

A41/A42 User Manual



A41/A42

User Manual

Document ID: 2CMC484002M0201

Revision: A

2012-02-24

Disclaimer

The information in this document is subject to change without notice and should not be construed as a commitment by ABB AB. ABB AB assumes no responsibility for any errors that may appear in this document.

In no event shall ABB AB be liable for direct, indirect, special, incidental or consequential damages of any nature or kind arising from the use of this document, nor shall ABB AB be liable for incidental or consequential damages arising from use of any software or hardware described in this document.

Copyrights

This document and parts thereof must not be reproduced or copied without written permission from ABB AB, and the contents thereof must not be imparted to a third party nor used for any unauthorized purpose.

The software or hardware described in this document is furnished under a license and may be used, copied, or disclosed only in accordance with the terms of such license.

© Copyright 2010 ABB AB. All rights reserved.

Trademarks

ABB AB is a registered trademark of the ABB Group. All other brand or product names mentioned in this document may be trademarks or registered trademarks of their respective holders.

Contact

ABB AB
P.O. BOX 1005
SE-611 29 NYKÖPING
SWEDEN
Tel: +46 155 295000
Fax: +46 155 288110

Table of Content

1 Product Overview	9
1.1 Meter Parts	10
1.2 Meter Types	12
2 Installation	15
2.1 Mounting the Meter	16
2.2 Environmental Considerations	18
2.3 Installing the Meter	19
2.3.1 Configuring the meter	20
2.4 Wiring Diagrams	21
2.4.1 Direct connected meters	21
2.4.2 Transformer connected meters without voltage transformer	21
2.4.3 Transformer connected meters with voltage transformer	22
2.4.4 Inuts/outputs	22
2.4.5 Communication	23
3 User Interface	25
3.1 Display	26
4 Meter Settings	31
4.1 Settings and Configurations	32
4.1.1 Setting Date	32
4.1.2 Setting Time	33
4.1.3 Setting Ratios	33
4.1.4 Setting Pulse Output	33
4.1.5 Setting I/O	34
4.1.6 Setting Alarm	35
4.1.7 Setting Currency/CO2	37
4.1.8 Setting RS485	38
4.1.9 Setting IR Side	38
4.1.10 Setting Upgrade Consent	40
4.1.11 Setting Pulse LED	40
4.1.12 Setting Tariff	40
4.1.13 Setting Previous Values	41
4.1.14 Setting Load Profile	41
4.1.15 Setting Demand	42
4.1.16 Resetting Resettable Registers	42
5 Technical Description	45
5.1 Energy Values	46
5.2 Instrumentation	48
5.3 Harmonics	50
5.3.1 Measuring Harmonics	52
5.4 Alarm	54
5.5 Inputs and Outputs	55
5.5.1 Tariff Inputs	55
5.5.2 Pulse Outputs	56
5.5.2.1 Pulse Frequency and Pulse length	56
5.6 Internal Clock	58
5.7 Logs	59
5.7.1 System Log	59
5.7.2 Event Log	60
5.7.3 Net Quality Log	61
5.7.4 Audit Log	61
5.7.5 Settings Log	62

5.7.6 Event codes	62
5.8 Demand	64
5.9 Previous Values	66
5.10 Load Profile	68
6 Technical data	71
6.1 Technical Specifications	72
6.2 Physical dimensions	76
7 Measurement Methods	77
7.1 Measuring Energy	78
7.1.1 Single Phase, 1-Element Metering	80
7.1.2 3-Phase, 2-Element Metering	82
7.1.3 3-Phase, 3-Element Metering	84
8 Service & Maintenance	89
8.1 Service and Maintenance	90
9 Communication with Modbus	91
9.1 About the Modbus Protocol	92
9.1.1 Function Code 3 (Read holding registers)	92
9.1.2 Function Code 16 (Write multiple registers)	94
9.1.3 Function Code 6 (Write single register)	95
9.1.3.1 Exception Responses	96
9.2 Reading and Writing to Registers	97
9.3 Mapping Tables	98
9.4 Historical Data	109
9.4.1 Quantity identifiers	112
9.5 Previous Values	117
9.5.1 Reading Previous Values	119
9.6 Demand	121
9.6.1 Reading Demand	123
9.7 Event logs	125
9.7.1 Reading Event logs	127
9.8 Load profile	129
9.8.1 Reading Load profile	131
9.9 Configuration	132
9.9.1 Previous values	132
9.9.2 Demand	133
9.9.3 Load profile	136
9.9.4 Alarms	137
9.9.5 Inputs and outputs	141
9.9.6 Tariffs	143
10 Communication with M-Bus	151
10.1 Protocol Description	152
10.1.1 Telegram Format	156
10.1.1.1 Field description	156
10.1.2 Value Information Field codes	162
10.1.2.1 Standard VIF codes	162
10.1.2.2 Standard codes for VIFE used with extension indicator FDh	162
10.1.2.3 Standard codes for VIFE	163
10.1.2.4 First manufacturer specific VIFE-codes	163
10.1.2.5 VIFE-Codes for reports of record errors (meter to master)	164
10.1.2.6 VIFE-Codes for object actions (master to meter)	165

10.1.2.7	2:nd manufacturer specific VIFE followed after VIFE 1111 1000 (F8 hex):	165
10.1.2.8	2:nd manufacturer specific VIFE followed after VIFE 1111 1001 (F9 hex):	165
10.1.2.9	2:nd manufacturer specific VIFE followed after VIFE 1111 1110 (FE hex):	167
10.1.3	Communication process	167
10.1.3.1	Selection and secondary addressing	168
10.2	Standard Readout of Meter Data	170
10.2.1	Example of the 1st telegram (all values are hexadecimal)	170
10.2.2	Example of 2nd telegram (all values are hexadecimal)	174
10.2.3	Example of 3rd telegram (all values are hexadecimal)	178
10.2.4	Example of the 4th telegram (all values are hexadecimal)	183
10.2.5	Example of the 5th telegram (all values are hexadecimal)	186
10.2.6	Example of the 6th telegram (all values are hexadecimal)	189
10.2.7	Example of the 7th telegram (all values are hexadecimal)	193
10.2.8	Example of the 8th telegram (all values are hexadecimal)	196
10.2.9	Example of the 9th telegram (all values are hexadecimal)	199
10.3	Special Readout of Meter Data	202
10.3.1	Readout of Load Profile Data	203
10.3.1.1	Examples of Readouts of Load Profile Data	208
10.3.2	Readout of Demand Data	210
10.3.2.1	Examples of Readouts of Demand Data	211
10.3.3	Readout of Previous Values	213
10.3.3.1	Examples of Readouts of Previous Values	215
10.3.4	Readout of Event Log Data	218
10.3.4.1	Example of readout of log data	220
10.3.5	Readout of Current Harmonics	221
10.3.5.1	Examples of Readouts of Current Harmonics Data	223
10.3.6	Readout of Voltage Harmonics	227
10.3.6.1	Examples of readout of voltage harmonics data	228
10.4	Sending Data to the Meter	233
10.4.1	Set tariff	233
10.4.2	Set primary address	234
10.4.3	Change baud rate	234
10.4.4	Reset power fail counter	235
10.4.5	Set Current transformer (CT) ratio - numerator	235
10.4.6	Set voltage transformer (VT) ratio - numerator	236
10.4.7	Set current transformer (CT) ratio - denominator	236
10.4.8	Set voltage transformer (VT) ratio - denominator	237
10.4.9	Select status information	237
10.4.10	Reset of stored state for input 1	238
10.4.11	Reset of stored state for input 2	238
10.4.12	Reset of stored state for input 3	239
10.4.13	Reset of stored state for input 4	239
10.4.14	Reset of input counter 1	240
10.4.15	Reset of input counter 2	240
10.4.16	Reset of input counter 3	241
10.4.17	Reset of input counter 4	241
10.4.18	Set output 1	242
10.4.19	Set output 2	242
10.4.20	Set output 3	243
10.4.21	Set output 4	243
10.4.22	Reset power outage time	244
10.4.23	Send password	244
10.4.24	Set password	244

Table of Content

10.4.25 Set date and time	245
10.4.26 Set date	246
10.4.27 Reset demand, previous values, load profile and logs	246
10.4.28 Reset resettable active energy import	247
10.4.29 Reset resettable active energy export	248
10.4.30 Reset resettable reactive energy import	248
10.4.31 Reset resettable reactive energy export	249
10.4.32 Freeze demand	249
10.4.33 Set write access level	250
10.4.34 Set tariff source	250
10.4.35 Set CO2 conversion factor	251
10.4.36 Set currency conversion factor	251

Chapter 1: Product Overview

Overview This chapter describes the parts of the meter and the different meter types.

In this chapter The following topics are covered in this chapter:

- 1.1 Meter Parts 10
- 1.2 Meter Types 12

1.1 Meter Parts

Illustration

The parts of the meter are shown in the illustration below:

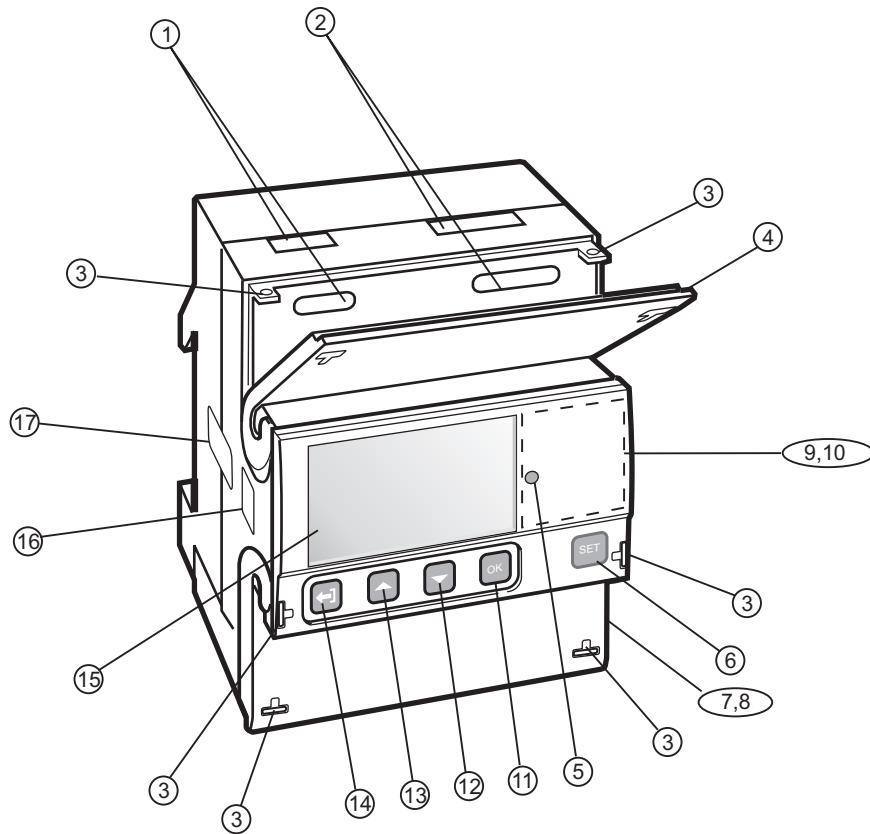

Parts description

The following table describes the parts of the meter:

Item	Description	Comments
1	Terminal for communication connection	
2	Terminal for input/output connection	
3	Sealing point.	Seal thread can be used to seal the cover.
4	Sealable terminal cover	Protective cover with printed wiring diagram on the inside.
5	LED	Flashes in proportion to the energy measured.
6	Set button	Enter configuration mode
7	Sealable terminal cover	Protective cover with printed wiring diagram on the inside
8	Terminal block	Terminal for all voltages and currents
9	Sealable cover	To protect the LCD and seal the set button

Item	Description	Comments
10	Product data	Contains data about the meter type
11	OK button	Perform an action or choose a menu
12	Down button	Toggle down (toggle right in the main menu)
13	Up button	Toggle up (toggle left in the main menu)
14	Exit button	Exit to the previous menu or toggle between default and main menu.
15	Display	LCD for meter reading
16	optical communication interface	For IR communication
17	Sealing	

1.2 Meter Types

Main groups

The A41/A42 meters are divided into two main groups:

- Direct connected meters for currents $\leq 80\text{A}$.
- Transformer connected meters for currents $> 80\text{A}$ using external current transformers with secondary current $\leq 6\text{A}$ and optional voltage transformers.

Subgroups

The main meter groups are further divided into subgroups depending on the functionality of the respective meter:

Subgroup	Functionality
Platinum	Reactive energy, Harmonics, Configurable I/O (except the 690V meter which has fixed I/O), Advanced clock functions (load profiles), Basic clock functions (Tariff control, Previous values, Max. demand, Event log), Class 0.5 or Class 1, Tariffs, Fixed I/O, Resettable registers, Import/export of energy, Active energy, Pulse output/alarm
Gold	Basic clock functions (Tariff control, Previous values, Max. demand, Event log), Class 0.5 or Class 1, Tariffs, Fixed I/O, Resettable registers, Import/export of energy, Active energy, Pulse output/alarm
Silver	Class 0.5 or Class 1, Tariffs, Fixed I/O, Resettable registers, Import/export of energy, Active energy, Pulse output/alarm
Bronze	Import/export of energy, Active energy, Class 1, Pulse output/alarm
Steel	Active energy, Class 1, Pulse output/alarm

Product label

The meter type information that is reflected on the labels on the meter is shown in the picture below:

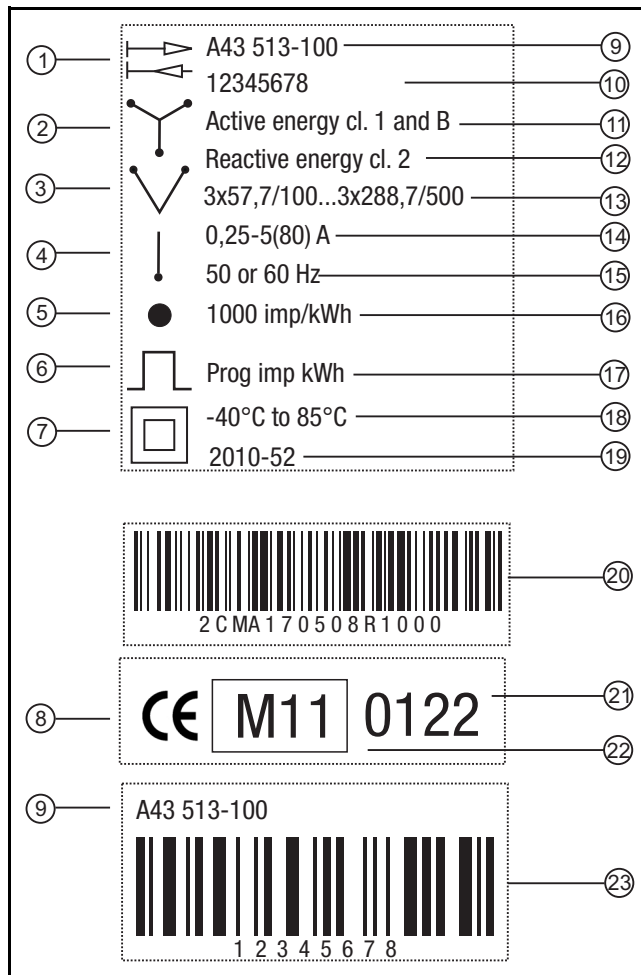

Product label information

The information on the product label is explained in the table below:

Item	Description
1	Import/export of energy
2	3-element metering
3	2-element metering
4	1-element metering
5	LED
6	Pulse output
7	Protection class II
8	Declaration of product safety
9	Type designation
10	Serial number
11	Accuracy active energy

Item	Description
12	Accuracy reactive energy
13	Voltage
14	Current
15	Frequency
16	LED pulse frequency
17	Pulse frequency
18	Temperature range
19	Date of manufacture (year and week)
20	ABB ID
21	Notified body
22	MID and year of verification

Chapter 2: Installation

Overview

This chapter describes how to mount the A41/A42 meters and how to connect them to an electricity network. The chapter also contains information about how to perform a basic configuration of the meter.

Information about how to connect I/O and communication options is also included in this chapter.

In this chapter

The following topics are covered in this chapter:

- 2.1 Mounting the Meter 16
- 2.2 Environmental Considerations 18
- 2.3 Installing the Meter 19
 - 2.3.1 Configuring the meter 20
- 2.4 Wiring Diagrams 21
 - 2.4.1 Direct connected meters 21
 - 2.4.2 Transformer connected meters without voltage transformer 22
 - 2.4.3 Transformer connected meters with voltage transformer 23
 - 2.4.4 Inputs/outputs 25
 - 2.4.5 Communication 26

2.1 Mounting the Meter

General

This section describes different ways to mount the A41/A42 meters. For some methods of mounting additional accessories are needed. For further information about accessories, refer to the Main Catalog (2CMC480001C0201).

DIN-rail mounted

The A41/A42 meters are intended to be mounted on a DIN-rail (DIN 50022). If this method of mounting is used no extra accessories are needed and the meter is fastened by snapping the DIN-rail lock onto the rail.

DIN-rail

The following picture shows a DIN-rail.

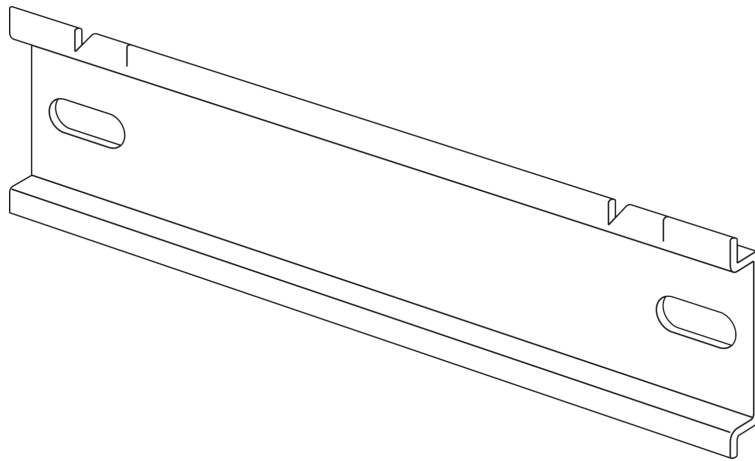

Wall mounted

The recommended way to mount the meter on a wall is to mount a separate DIN-rail on the wall and then mount the meter on the rail.

Flush mounted

To flush-mount the meter a flush-mount kit should be used.

Flush-mount kit

The following picture shows a flush-mount kit.

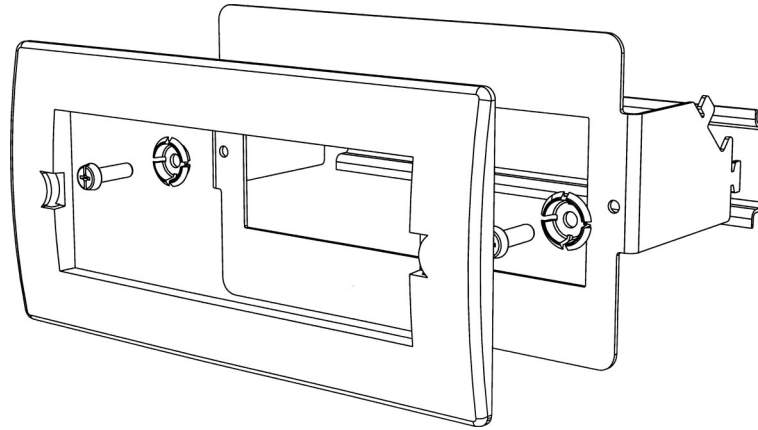

2.2 Environmental Considerations

Ingress protection

To comply with the protection requirements the product must be mounted in protection class IP 51 enclosures, or better, according to IEC 60259.

Mechanical environment

In accordance with the Measuring Directive (2004/22/EC), the product complies with M1, which means that it can be operated in "...locations with vibration and shocks of low significance, e.g. for instruments fastened to light supporting structures subject to negligible vibrations and shocks transmitted from local blasting or pile-driving activities, slamming doors, etc."

Electromagnetic environment

In accordance with the Measuring Directive (2004/22/EC), the product complies with E2, which means that it can be operated "...in locations with electro magnetic disturbances corresponding to those likely to be found in other industrial buildings."

Climatic environment

In order to work properly the product should not be operated outside the specified temperature range of -40°C - $+70^{\circ}\text{C}$.

In order to work properly the product should not be exposed to humidity exceeding the specified 75% yearly average, 95% on 30 days/year.

2.3 Installing the Meter



Warning – Electrical equipment should only be installed, accessed, serviced and maintained by qualified electrical personnel.

Working with high voltage is potentially lethal. Persons subjected to high voltage may suffer cardiac arrest, burn injuries, or other severe injuries. To avoid such injuries, make sure to disconnect the power supply before you start the installation.



Warning – For safety reasons it is recommended that the equipment is installed in a way that makes it impossible to reach or touch the terminal blocks by accident.

The best way to make a safe installation is to install the unit in an enclosure. Further, access to the equipment should be limited through use of lock and key, controlled by qualified electrical personnel.



Warning – The meters must always be protected by fuses on the incoming side.

In order to allow for maintenance of transformer rated meters, it is recommended that there should be a short circuiting device installed near the meter.

Installation requirements

Meters with wireless communication should not be installed closer than 20 cm from people.

Install the meter

Follow the steps in the table below to install and verify the installation of the meter:

Step	Action
1	Switch off the mains power.
2	Place the meter on the Din rail and make sure it snaps onto it.
3	Strip the cable insulation to the length that is indicated on the meter.
4	Connect the cables according to the wiring diagram that is printed on the meter and tighten the screws (2.5 Nm for direct connected meters and 2 Nm for transformer connected meters).
5	Install the circuit protection. See <i>table 2:1</i> below for the correct fuse.
6	If inputs/outputs are used, connect the cables according to the wiring diagram that is printed on the meter and tighten the screws (0.25 Nm). Then connect to an external power supply (max 240V).
7	If communication is used, connect the cables according to the wiring diagram that is printed on the meter and tighten the screws (0.25 Nm).
Verify the installation	
8	Check that the meter is connected to the specified voltage and that voltage phase connections and the neutral (if used) are connected to the correct terminals.
9	For a transformer connected meter, check that the current direction of the primary and secondary current of the external transformers is correct. Also check that the transformers are connected to the correct meter terminals.

Step	Action
10	Switch on the power. If a warning symbol is displayed, refer to the error codes in <i>Troubleshooting</i> .
11	Under the menu item "Instantaneous Values" on the meter, check that the voltages, currents, power and power factors are reasonable and that the power direction is what to be expected (the total power should be positive for a load that consumes energy). When doing the check the meter should be connected to the intended load, preferably a load with a current above zero on all phases to make the check as complete as possible.

Circuit protection Use the information in this table to select the correct fuse for the circuit protection.

Table: 2:1

Meter type	Max circuit protection
Direct connected	80 A MCB, C characteristic or 80 A fuse type gL-gG
Transformer connected	10 A MCB, B characteristic or Diazes, fast.

2.3.1 Configuring the meter

Default settings For information about how to change the default settings of the meter, refer to the chapter called *Meter Settings*.

Default settings The following table lists the default settings of the meter that normally need to be changed. Check the settings of the meter to see if they need to be reconfigured.

Parameter	Direct connected meters	Transformer connected meters
Clock	---	---
Ratios VT	---	1
Ratios CT	---	1
Pulse frequency	10	10
Pulse length	100 ms	100 ms

2.4 Wiring Diagrams

General

This section describes how to connect the different types of meters to an electricity network. The terminal numbers in the wiring diagrams listed below correspond to the marking on the terminal block of the meter.

2.4.1 Direct connected meters

2-wire connection The following diagram shows a 2-wire connection of a direct connected 1-phase meter:

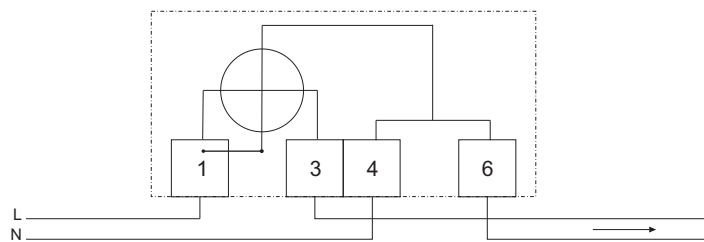

2.4.2 Transformer connected meters without voltage transformer

2-wire connection The following diagram shows a 2-wire connection of a transformer connected 3-phase meter:

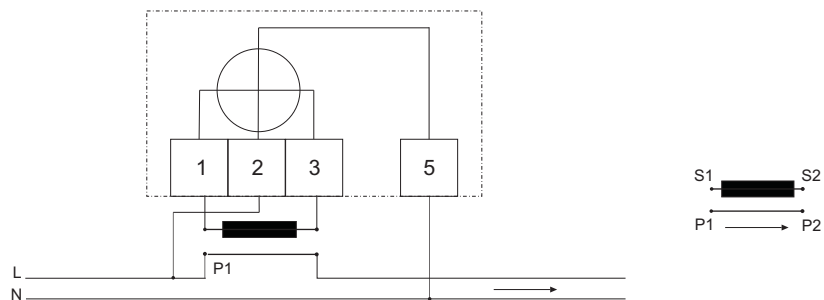

2.4.3 Transformer connected meters with voltage transformer

2-wire connection The following diagram shows a 2-wire connection of a transformer connected 3-phase meter with voltage transformers:

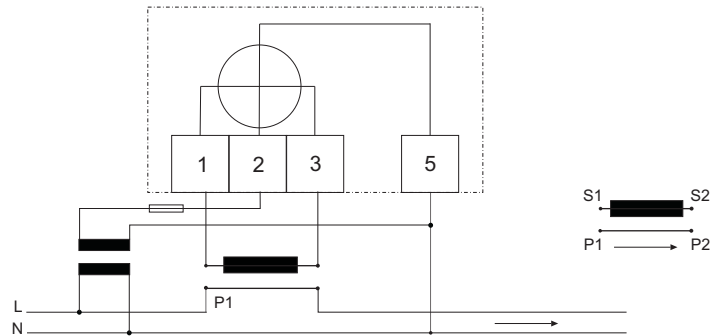

2.4.4 Inuts/outputs

2 outputs, 2 inputs

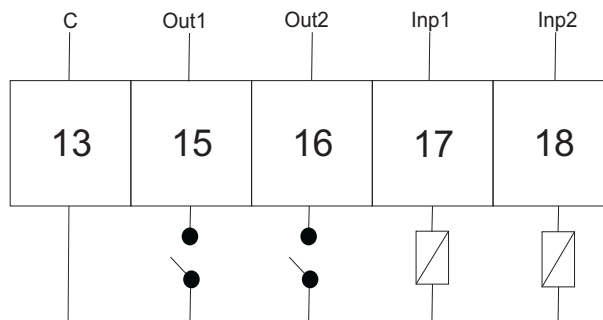

4 configurable inputs/outputs

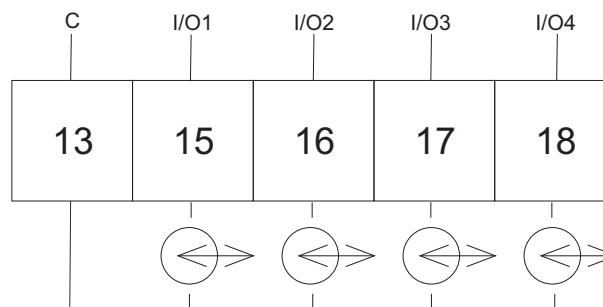

1 output

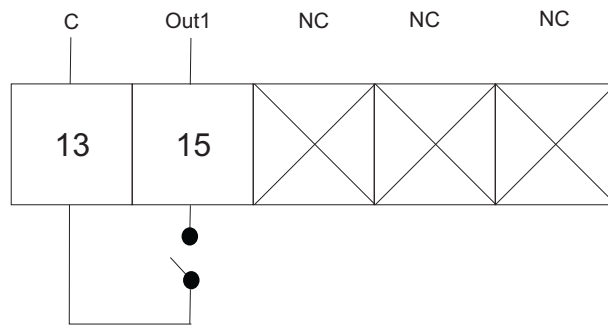

2.4.5 Communication

RS 485

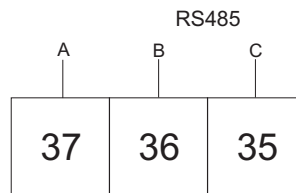

M-Bus

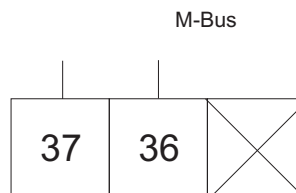

Chapter 3: User Interface

Overview This chapter describes the different display views and the menu structure.

In this chapter The following topics are covered in this chapter:

3.1 Display 28

3.1 Display

General

The display contains two main views, the Default menu and the Main menu. Use the Exit button  to toggle between the views. In both views a number status icons are displayed in the upper part of the display. These icons are explained in *table 3:1* below. In the same manner the bottom part of the display has an explanatory text to describe what is shown or highlighted at the moment.

Default menu

The following image shows an example of the layout of the Default menu:

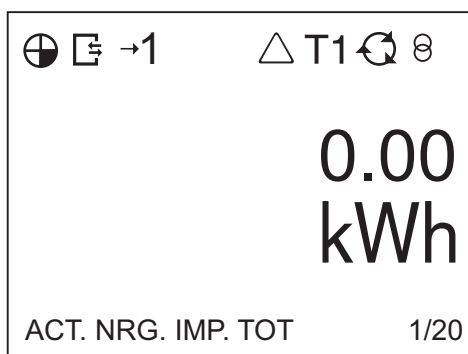

Energy values

The following table explains the content of the 20 available pages in the Default menu:



Page	Unit	Text on display	Explaining text
1/20	kWh	ACT.NRG.IMP.TOT	Measures the total imported active energy.
2/20	kWh	ACT.NRG.EXP.TOT	Measures the total exported active energy.
3/20	kvarh	REACT.NRG.IMP.TOT	Measures the total imported reactive energy.
4/20	kvarh	REACT.NRG.EXP.TOT	Measures the total exported reactive energy.
5/20	kWh	ACT.NRG.IMP.TAR1	Measures the imported active energy for tariff 1
6/20	kWh	ACT.NRG.IMP.TAR2	Measures the imported active energy for tariff 2
7/20	kWh	ACT.NRG.IMP.TAR3	Measures the imported active energy for tariff 3





Page	Unit	Text on display	Explaining text
8/20	kWh	ACT.NRG.IMP.TAR4	Measures the imported active energy for tariff 4
9/20	kWh	ACT.NRG.EXP.TAR1	Measures the exported active energy for tariff 1
10/20	kWh	ACT.NRG.EXP.TAR2	Measures the exported active energy for tariff 2
11/20	kWh	ACT.NRG.EXP.TAR3	Measures the exported active energy for tariff 3
12/20	kWh	ACT.NRG.EXP.TAR4	Measures the exported active energy for tariff 4
13/20	kvarh	REACT.NRG.IMP.TAR1	Measures the imported reactive energy for tariff 1
14/20	kvarh	REACT.NRG.IMP.TAR2	Measures the imported reactive energy for tariff 2
15/20	kvarh	REACT.NRG.IMP.TAR3	Measures the imported reactive energy for tariff 3
16/20	kvarh	REACT.NRG.IMP.TAR4	Measures the imported reactive energy for tariff 4
17/20	kvarh	REACT.NRG.EXP.TAR1	Measures the exported reactive energy for tariff 1
18/20	kvarh	REACT.NRG.EXP.TAR2	Measures the exported reactive energy for tariff 2
19/20	kvarh	REACT.NRG.EXP.TAR3	Measures the exported reactive energy for tariff 3
20/20	kvarh	REACT.NRG.EXP.TAR4	Measures the exported reactive energy for tariff 4

Status Icons

The status icons that can be seen the display are explained in the following table.

Table: 3:1

Icon	Indication
	Active quadrant.
	Communication is in progress. The meter is either sending or receiving information.

Icon	Indication
	Metering in progress. Clockwise rotation indicates import. Counter clockwise rotation indicates export.
1→1 ←1 2→2←2 3→3←3	Arrows indicate direction of current per phase. Arrow left = export, arrow right = import. A digit without arrow indicates that only voltage is connected to the phase.
T1 T2 T3 T4	Active tariff.
  	Error, warning, note
	Transformer ratio (only on transformer rated meters)





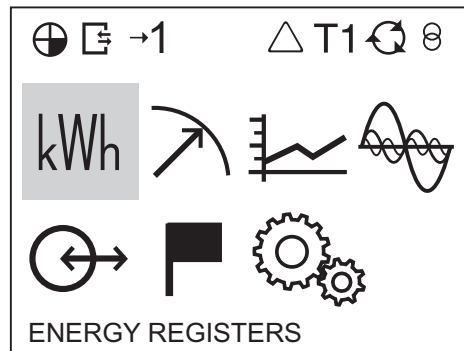

Main menu

The following image shows an example of the layout of the main menu:







Main menu icons

Depending on the meter type all or a subset of the following icons may be available in the display:

Icon	Explanation
kWh	Energy registers
	Instantaneous values
	Stored values
	Harmonics
	I/O
	Status
	Settings

Main menu structure

The following table describes the main menu structure and its content:

						
Active Energy Import L1-L3	Active Power	Previous Values	THD Voltage	I/O 1	System Log	Clock
Active Energy Export L1-L3	Reactive Power	Load Profiles	Harmonics Voltage L1-L3	I/O 2	Event Log	Ratios
Active Energy Net L1-L3	Apparent Power	Demand	THD Current	I/O 3	Net Quality Log	Wires
Reactive Energy Import L1-L3	Phase Voltage		Harmonics Current L1-L3	I/O 4	System Status	Pulse Output
Reactive Energy Export L1-L3	Main Voltage				Audit Log	I/O
Reactive Energy Net L1-L3	Current				Settings Log	Alarm
Apparent Energy Import L1-L3	frequency				About	Currency/CO ₂
Apparent Energy Export L1-L3	Power Factor					RS 485
Apparent Energy Net L1-L3	Phase Angle Power					IR Side
Active Energy Import Tariff	Phase Angle Voltage					Wireless
Active Energy Export Tariff	Phase Angle Current					Upgrade Consent
Reactive Energy Import Tariff	Current Quadrant					Pulse LED
Reactive Energy Export Tariff						Tariff
Resettable Active Energy Import Total						Previous Values
Resettable Active Energy Export Total						Load profiles
Resettable Reactive Energy Import Total						Demand
Resettable Reactive Energy Export Total						Resettable registers
Currency						
CO ₂						

Chapter 4: Meter Settings

Overview This chapter gives an overview of the meter settings and configuration options.

In this chapter The following topics are covered in this chapter:

- 4.1 Settings and Configurations 32
 - 4.1.1 Setting Date 32
 - 4.1.2 Setting Time 33
 - 4.1.3 Setting Ratios 33
 - 4.1.4 Setting Pulse Output 33
 - 4.1.5 Setting I/O 34
 - 4.1.6 Setting Alarm 35
 - 4.1.7 Setting Currency/CO2 37
 - 4.1.8 Setting RS485 38
 - 4.1.9 Setting IR Side 38
 - 4.1.10 Setting Upgrade Consent 40
 - 4.1.11 Setting Pulse LED 40
 - 4.1.12 Setting Tariff 40
 - 4.1.13 Setting Previous Values 41
 - 4.1.14 Setting Load Profile 41
 - 4.1.15 Setting Demand 42
 - 4.1.16 Resetting Resettable Registers 42







4.1 Settings and Configurations

Configurable functions

Depending on the meter type, all or a subset of the following functions can be configured:



Clock	
Ratios	
Wires	
Pulse output	
I/O	
Alarm	
Currency/CO ₂	
RS485	
IR Side	
Wireless	
Upgrade Consent	
Pulse LED	
Tariff	
Previous Values	
Load profile	
Demand	
Resettable registers	

Setting a value

When setting a value, the  button is used to activate the set-option. The  and  buttons are used to change the options that can be set, such as on or off. If the set-option involves setting a number, for example a alarm limit, the  button is used to increase a digit, and the  button is used to decrease a digit. The  button is used to toggle between digits. The option/digit that is active for setting is marked with a underscore. When the underscore on the last option has disappeared, the setting has been performed.

4.1.1 Setting Date

To set the date, perform the following steps:

1. Choose the Settings icon in the main menu, press .
2. Choose “Clock”, press .
3. The display will now show the date.
4. Set the date.

4.1.2 Setting Time

To set the time, perform the following steps:

1. Choose the Settings icon in the main menu, press .
2. Choose "Clock", press .
3. The display will now show the date. Press to get to the time-menu.
4. Set the time.

4.1.3 Setting Ratios

To set the ratios, perform the following steps:

1. Choose the Settings icon in the main menu, press .
2. Choose "Ratios", press .
3. The display will show the quantity Current (CT on the display) and the ratio. To change the ratio, press . See *table 4:1* for interval.
4. Press . The display will show the quantity Voltage (VT on the display) and the ratio. To change the ratio, press . See *table 4:1* for interval.

Table: 4:1

Option	Interval
Transformer Current (CT)	1-9999/1-9
Transformer Voltage (VT)	1-999999/1-999

4.1.4 Setting Pulse Output

To set the pulse output, perform the following steps:

1. Choose the Settings icon in the main menu, press .
2. Choose "Pulse out" (Pul.out on the display), press .

The display will show what type of energy is measured on pulse output 1. Depending on meter type, the available choices are:

Act.Nrg.Imp on the display	Active energy imported
Act.Nrg.Exp on the display	Active energy exported
React.Nrg.Imp on the display	Reactive energy imported
React.Nrg.Exp on the display	Reactive energy exported
Inactive on the display	Inactive

3. Set the energy type.
4. Press once to get to the next menu. The display will show the frequency. The interval that can be set is 0-999999 imp/kWh or 0-999999 imp/MWh. Set the frequency and quantity.
5. Press once to get to the next menu. The display will show the pulse length in milliseconds. The interval for the pulse length is from 10 to 990ms. Set the pulse length.
6. Press once to get to the next menu. The display will show the setting for pulse output 1. Depending on the meter type, the available choices are:

4 configurable I/Os	4 static I/Os	1 static I/O
No output	No output	No output
Out 1	Out 1	Out 1
Out 2	Out 2	-
Out 3	-	-
Out 4	-	-



Note – If choosing an I/O that is not pulse output configured, the option is set to “no output” when pressing the **OK** button.

- The first pulse output is now fully configured. Depending on the meter type, up to four pulse outputs can be set. If your meter supports multiple pulse outputs, use **▼** to toggle down to the remaining pulse outputs and set them the same way as pulse output 1.

4.1.5 Setting I/O

To set the I/O, perform the following steps:

- Choose the Settings icon in the main menu, press **OK**.
- Choose “I/O”, press **OK**.
- The display will now show I/O 1. To change I/O, use **▲** or **▼**. To set an I/O, press the **SET** button. Depending on the meter type, different choices can be made for the I/O, see *table 4:2*.

Table: 4:2

I/O	Available choices	
4 configurable I/Os	<ul style="list-style-type: none"> • Input • Alarm out • Communication out (Comm.out on display) • Pulse out (Pul.out on display) • Tariff out • Always on • Always off 	
4 static I/Os ¹	<ul style="list-style-type: none"> • Alarm out • Communication out (Comm.out on display) • Pulse out (Pul.out on display) • Tariff out • Always on • Always off 	

I/O	Available choices	
1 static I/O	<ul style="list-style-type: none"> • Alarm out • Communication out (Comm.out on display) • Pulse out Pul.out on display) • Tariff out • Always on • Always off 	

1. I/O 1 and I/O 2 are set to static output by default. I/O 3 and 4 are set to static output by default and cannot be configured. I/O 3 and I/O 4 are not shown in the display.

4.1.6 Setting Alarm

To set the alarm , perform the following steps:

1. Choose the Settings icon in the main menu, press .
2. Choose “Alarm”, press .
3. The display will show what quantity shall be measured. Depending on the meter type, different quantities are available. See *table 4:3* and *table 4:4* for available quantities and interval/units for the different quantities. Set the desired quantity.

Table: 4:3

1-phase meter		Interval/Unit
Inactive		-
Current L1		0.01-99.99 A/kA
Voltage L1		0.1-999.9 V/kV
Harmonic voltage L1		0.1-999.9 V/kV
Active power total		0-9999 W/kW/MW
Reactive power total		0-9999 W/kW/MW
Apparent power total		0-9999 W/kW/MW
Power factor total		0.000-0.999

Table: 4:4

3-phase meter	Interval/Unit
Inactive	-
Active power total	0-9999 W/kW/MW
Reactive Power Total	0-9999 W/kW/MW
Apparent Power Total	0-9999 W/kW/MW
Power factor total	0.000-0.999
Current L1	0.01-99.99 A/kA
Current L2	0.01-99.99 A/kA
Current L3	0.01-99.99 A/kA
Current N	0.01-99.99 A/kA
Voltage L1	0.1-999.9 V/kV
Voltage L2	0.1-999.9 V/kV
Voltage L3	0.1-999.9 V/kV
Voltage L1-L2	0.1-999.9 V/kV
Voltage L2-L3	0.1-999.9 V/kV
Voltage L1-L3	0.1-999.9 V/kV
Harmonicvoltage L1	0.1-999.9 V/kV
Harmonic voltage L2	0.1-999.9 V/kV
Harmonic voltage L3	0.1-999.9 V/kV
Harmonic voltage L1-L2	0.1-999.9 V/kV
Harmonic voltage L2-L3	0.1-999.9 V/kV
Harmonic voltage L1-L3	0.1-999.9 V/kV
Active power L1	0-9999 W/kW/MW
Active power L2	0-9999 W/kW/MW
Active power L3	0-9999 W/kW/MW
Reactive power L1	0-9999 W/kW/MW
Reactive power L2	0-9999 W/kW/MW
Reactive power L3	0-9999 W/kW/MW
Apparent power L1	0-9999 W/kW/MW
Apparent power L2	0-9999 W/kW/MW
Apparent power L3	0-9999 W/kW/MW
Power factor L1	0.000-0.999
Power factor L2	0.000-0.999
Power factor L3	0.000-0.999

4. Press once to get to the next menu. The display will show what level the alarm will trigger on. Set the alarm level.

5. Press once to get to the next menu. The display will show the time that the measured value has to be higher than the limit set in the previous step in order for the alarm to trigger. Set the time limit.
6. Press once to get to the next menu. The display will show what level the alarm will cease on. Set the alarm level.
7. Press once to get to the next menu. The display will show the time that the measured value has to be lower than the limit set in the previous step in order for the alarm to cease. Set the time limit.
8. Press once to get to the next menu. The display will show if the alarm will be logged or not. The available values are “on” and “off”. Set logging to on or off.
9. Press once to get to the next menu. The display will show what output the alarm is set on (or if no output is set). The available choices are dependent on meter type, see *table 4:5*.

Table: 4:5

4 configurable I/Os	4 static I/Os	1 static I/O
No output	No output	No output
Out 1	Out 1	Out 1
Out 2	Out 2	
Out 3		
Out 4		



Note – If choosing an I/O that is not alarm configured, the option will be set to “no output” when pressing the button.

10. The first alarm is now fully configured. Depending on the meter type, up to four alarms can be set. If your meter supports multiple alarms, use and to set the remaining alarms the same way as the first alarm was configured.

4.1.7 Setting Currency/CO₂

By setting a conversion factor for Currency/CO₂, kWh is converted to currency and/or kg CO₂.

To set currency/CO₂, perform the following steps:

1. Choose the Settings icon in the main menu, press .
2. Choose “Currency/CO₂” (Curr/CO₂ on the display), press .
3. The display will show price in currency per unit.
4. Press to set the the conversion factor and the quantity.
5. Use to get to the next page. The page will display the CO₂ emissions in kg per kWh.
6. Press to set the conversion factor for CO₂.

4.1.8 Setting RS485

The RS485 uses the EQ-Bus and the Modbus protocol to communicate. To set the RS485 communication depending on protocol, perform the following steps:

Step	EQ-Bus	Modbus
1	Choose the Settings icon in the main menu, press <input type="button" value="OK"/> .	Choose the Settings icon in the main menu, press <input type="button" value="OK"/> .
2	Choose communication interface.	Choose communication interface.
3	Choose EQ-Bus.	Choose Modbus.
4	Press <input type="button" value="▼"/> once to get to the next menu. The display will show the baudrate. See <i>Table 4:6</i> for baudrate options. Set baudrate.	Press <input type="button" value="▼"/> once to get to the next menu. The display will show the baudrate. See <i>Table 4:6</i> for baudrate options. Set baudrate.
5	Press <input type="button" value="▼"/> once to get to the next menu. The display will show the address. See <i>Table 4:6</i> for address range. Set address.	Press <input type="button" value="▼"/> once to get to the next menu. The display will show the address. See <i>Table 4:6</i> for address range. Set address.
6	Press <input type="button" value="▼"/> once to get to the next menu. The display will show the Oct. TO. See <i>Table 4:6</i> for options. Set Oct. TO	Press <input type="button" value="▼"/> once to get to the next menu. The display will show the Parity. See <i>Table 4:6</i> for options. Set Parity.
7	Press <input type="button" value="▼"/> once to get to the next menu. The display will show the Inac. TO. See <i>Table 4:6</i> for options. Set Inac. TO	
	Press <input type="button" value="▼"/> once to get to the next menu. The display will show if the password is to be reset. See <i>Table 4:6</i> for options. Set the option.	

4.1.9 Setting IR Side

The IR Side uses the M-Bus and the EQ-Busⁱ protocol to communicate. To set the IR Side communication depending on protocol, perform the following steps:

Step	M-Bus	EQ-Bus
1	Choose the Settings icon in the main menu, press <input type="button" value="OK"/> .	Choose the Settings icon in the main menu, press <input type="button" value="OK"/> .
2	Choose IR Side, press <input type="button" value="OK"/> .	Choose IR Side, press <input type="button" value="OK"/> .
3	Press <input type="button" value="SET"/> and choose M-Bus.	Press <input type="button" value="SET"/> and choose EQ-Bus.
4	Press <input type="button" value="▼"/> once to get to the next menu. The display will show the baudrate. See <i>Table 4:6</i> for baudrate options. Set baudrate.	Press <input type="button" value="▼"/> once to get to the next menu. The display will show the baudrate. See <i>Table 4:6</i> for baudrate options. Set baudrate.

- i. EQ-Bus is a communication protocol designed for internal communication with ABB meters. The protocol is based on the following IEC standards; 62056-42, 62056-46, 62056-53, 62056-61, 62056-62.

Step	M-Bus	EQ-Bus
5	Press <input type="checkbox"/> once to get to the next menu. The display will show the address. See <i>Table 4:6</i> for address range. Set address.	Press <input type="checkbox"/> once to get to the next menu. The display will show the address. See <i>Table 4:6</i> for address range. Set address.
6	Press <input type="checkbox"/> once to get to the next menu. The display will show the access level. See <i>Table 4:6</i> for options. Set the access level.	Press <input type="checkbox"/> once to get to the next menu. The display will show the Oct. TO. See <i>Table 4:6</i> for options. Set Oct. TO.
7	Press <input type="checkbox"/> once to get to the next menu. The display will show the Send status info. See <i>Table 4:6</i> for options. Set the send info status.	Press <input type="checkbox"/> once to get to the next menu. The display will show the Inac. TO. See <i>Table 4:6</i> for options. Set Inac. TO.
	Press <input type="checkbox"/> once to get to the next menu. The display will show if the password is to be reset. See <i>Table 4:6</i> for options. Set the option.	Press <input type="checkbox"/> once to get to the next menu. The display will show password reset option. Set if the password shall be reset or not.
	Press <input type="checkbox"/> once to get to the next menu. The display will show the upgrade mode. See <i>Table 4:6</i> for options. Set the upgrade mode.	

Protocol details

The following table shows the intervals and options for the different protocols:

Table: 4:6

Protocol	Access level	Upgrade mode	Send Status Info	Reset password	Parity	Baudrate	Address	Inter octet timeout (ms)	Inactivity timeout (ms)
EQ-Bus (when used through RS485)	-	-	-	Yes, No	-	1200, 2400, 4800, 9600, 19200, 38400, 57600, 115200, 125000, 230400, 250000, 460800	16-16381	20-6000	0-2000
Modbus (when used through RS485)	-	-	-	-	None, Odd, Even	1200, 2400, 4800, 9600, 19200, 38400, 57600, 115200	1-247	-	-

Protocol	Access level	Upgrade mode	Send Status Info	Reset password	Parity	Baudrate	Address	Inter octet timeout (ms)	Inactivity timeout (ms)
M-Bus (when used through IR-Side)	Open, Password, Closed	Active, Not Active	Always, Never, When not OK	Yes, No	-	2400, 4800, 9600, 19200, 38400	1-250	-	-
EQ-Bus (when used through IR-Side)	-	-	-	Yes, No	-	1200, 2400, 4800, 9600, 19200, 38400, 57600, 115200, 125000, 230400			

4.1.10 Setting Upgrade Consent

Upgrade Consent can be set to *Allowed* or *Not Allowed*. Setting it to *Allowed* means you agree to updates of the meter. Setting it to *Not Allowed* means no upgrades will take place.

To set Upgrade Consent, perform the following steps:

1. Choose the Settings icon in the main menu, press **OK**.
2. Choose "Upgrade Consent" (Upgr.Cons on the display), press **OK**.
3. Press **SET** to set Upgrade Consent.

4.1.11 Setting Pulse LED

To set pulse LED, perform the following steps:

1. Choose the Settings icon in the main menu, press **OK**.
2. Choose "Pulse LED" (Puls.LED on the display), press **OK**.
3. Press **SET** to set the type of energy that the LED shall indicate on.

4.1.12 Setting Tariff

The tariff source can be set to input, clock or communication. To set the tariffs, perform the following steps:

Step	Input	Clock	Communication
1	Choose the Settings icon in the main menu, press OK .	Choose the Settings icon in the main menu, press OK .	Choose the Settings icon in the main menu, press OK .
2	Choose "Tariff", press OK .	Choose "Tariff", press OK .	Choose "Tariff", press OK .

Step	Input	Clock	Communication
3	Press <input type="button" value="SET"/> and choose Input.	Press <input type="button" value="SET"/> and choose Clock. If the display says "Config found No reset" then reset the configuration by pressing <input type="button" value="SET"/> and choosing "Reset"	Press <input type="button" value="SET"/> and choose Comm.
4	Use <input type="button" value="▼"/> to toggle to the first configuration. Four configurations are available. Set the tariff that shall be active for each configuration.	Press <input type="button" value="▼"/> to get to the next page.	The tariff source is now set for communication.
5	-	Set the desired tariffs with start-time and if the tariff is to be used or not. Up to eight tariffs can be set, four for weekdays and four for weekends. Set at least one tariff for weekdays (Mon-Fri) and one for weekends (Sat-Sun) even if the values are the same.	-

4.1.13 Setting Previous Values

To set set the previous values, perform the following steps:

1. Choose the Settings icon in the main menu, press .
2. Choose "Previous Values" (Prev.Val. on the display), press .
3. Perform the setting. The options are day, week and month.
4. If setting week, use to go to the next step.
5. Set what week-day the snapshot of the values will be taken.

4.1.14 Setting Load Profile

To set the load profile, perform the following steps:

1. Choose the Settings icon in the main menu, press .
2. Choose "Load Profiles" (Load Pro on the display), press .
3. The first page will show the interval for the quantity active energy imported (Act.Imp.Tot on the display). Up to eight channels (pages) are available to configure, see table below.

Page	Quantity	On display	Predefined value
1/8	Active Energy Imported total	Act.Imp.Tot	15 min
2/8	Active Energy Exported Total	Act.Exp.Tot	15 min
3/8	Reactive Energy Imported Total	React.Imp.Tot	15 min
4/8	Reactive Energy Exported Total	React.Exp.Tot	15 min
5/8	Input Counter 1	Inp.Ctr 1	1 hours
6/8	Input Counter 2	Inp.Ctr 2	1 hours

Page	Quantity	On display	Predefined value
7/8	Input Counter 3	Inp.Ctr 3	1 hours
8/8	Input Counter 4	Inp.Ctr 4	1 hours

4. Configure the desired channels.

When a configuration has been made, a reset may be required in order to perform a new configuration. To reset the intervals, toggle down to the reset page and perform a reset the same way as performing a setting.

4.1.15 Setting Demand

The demand function enables measuring of up to 50 values (channels). Step 1-6 are general for the function and step 7-9 are specific for each channel.

To set the demand, perform the following steps:

1. Choose the Settings icon in the main menu, press .
2. Choose "Demand" (Demand on the display), press .
3. Set the period. The available choices are day, week and month. If choosing day, the starting point will be now and the ending point will be 00:00. If choosing month, the starting point will be now and the ending point will be the first of next month at 00:00. If choosing week, the starting point will be now and the ending point will be the set day at 00:00. If choosing week, press to get to the page where the day is set. Press .
4. Set the interval that shall be measured. Press to continue.
5. Set the subinterval that shall be measured. Press to continue.
6. Set if the previous settings shall be reset. Press to continue.
7. Set the quantity that shall be measured. Press to continue.
8. Set the demand type. Press to continue.
9. The demand level will be set automatically.

The first channel is now set. To set the next channel, repeat step 3-9. Up to 50 channels can be set.

4.1.16 Resetting Resettable Registers

To reset registers, perform the following steps:

1. Choose the Settings icon in the main menu, press .
2. Choose "Resettable registers" (Rst.Reg on the display), press .
3. The display will show the different registers to reset. Depending on the meter type, the available choices are:

Register	On the display
Active Energy Imported Total	Act.Imp
Active Energy Exported Total	Act.Exp
Reactive Energy Imported Total	Rea.Imp
Reactive Energy Exported Total	Rea.Exp

Register	On the display
Reset all	All

4. Toggle through the pages and reset the desired registers.

Chapter 5: Technical Description

Overview

This chapter contains technical descriptions of the meter functions. Depending of the meter type, the meter may contain all or a subset of the functions described in this chapter.

In this chapter

The following topics are covered in this chapter:

- 5.1 Energy Values 48
- 5.2 Instrumentation 50
- 5.3 Harmonics 52
- 5.4 Alarm 56
- 5.5 Inputs and Outputs 57
- 5.6 Internal Clock 60
- 5.7 Logs 61
- 5.8 Demand 66
- 5.9 Previous Values 68
- 5.10 Load Profile 70

5.1 Energy Values

General

The energy values are stored in energy registers. The different energy registers can be divided into:

- Registers containing active, reactive or apparent energy
- Registers containing different tariffs or total sum of all tariffs
- Registers containing energy per phase or total sum of all phases
- Resettable registers
- Registers containing momentary or historical value

The energy values can be read via communication or directly in the display with the help of the buttons.

Primary value

In transformer connected meters with external current transformers, and sometimes also external voltage transformers, the register value is multiplied by the total transformer ratio before it is presented on the display or sent out via communication. This value is called primary value.

Presentation of register values

In direct connected meters the energy is usually displayed with a fixed unit and number of decimals (normally kWh, with no decimals).

In transformer connected meters where primary values are displayed, the energy values can be rather big when the total transformer ratio is big. Normally the meter automatically adapts the unit and number of decimals displayed to the value.

In case the energy is displayed with fixed units and number of decimals the energy will "roll over" to zeros when the energy is incremented if all nines are displayed. The meter can however contain more digits internally, which can be read out via communication if the meter is equipped with a communication interface. See the example below where the value 2483756 is displayed, while the internal register contains 192483756.6.

Image

The following picture shows a display with fixed unit and numbers of decimals:

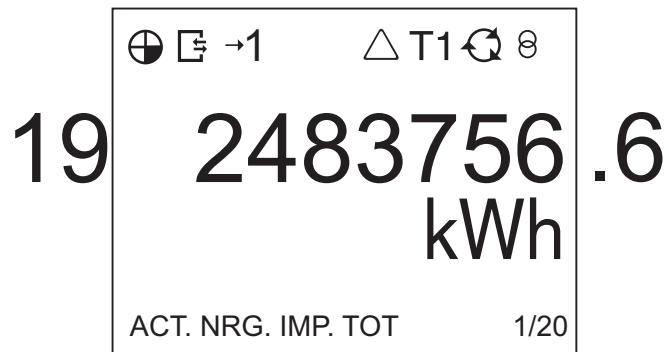

5.2 Instrumentation

Instrumentation functions

The following table shows the complete instrumentation functions of the A41/A42 meters. Depending on the meter type all or a subset of the following functions are available.

Instrumentation	3-phase, 4-wire	3-phase, 3-wire
Active power, total	X	X
Active power, L1	X	X
Active power, L2	X	
Active power, L3	X	X
Reactive power, Total	X	X
Reactive power, L1	X	X
Reactive power, L2	X	
Reactive power, L3	X	X
Apparent power, Total	X	X
Apparent power, L1	X	X
Apparent power, L2	X	
Apparent power, L3	X	X
Voltage L1 - N	X	
Voltage L2 - N	X	
Voltage L3 - N	X	
Voltage L1 - L2	X	X
Voltage L3 - L2	X	X
Voltage L1 - L3	X	
Current L1	X	X
Current L2	X	
Current L3	X	X
Current N	X	
Frequency	X	X
Power factor, Total	X	X
Power factor, L1	X	X
Power factor, L2	X	
Power factor, L3	X	X
Phase angle power, Total	X	X
Phase angle power, L1	X	X
Phase angle power, L2	X	
Phase angle power, L3	X	X
Phase angle voltage, L1	X	X
Phase angle voltage, L2	X	
Phase angle voltage, L3	X	X
Phase angle current, L1	X	X
Phase angle current, L2	X	

Instrumentation	3-phase, 4-wire	3-phase, 3-wire
Phase angle current, L3	X	X
Current quadrant, Total	X	X
Current quadrant, L1	X	X
Current quadrant, L2	X	
Current quadrant, L3	X	X
THD	X	X
Harmonic voltage L1	X	X
Harmonic voltage L2	X	
Harmonic voltage L3	X	X
Harmonic voltage L1-L2	X	X
Harmonic voltage L2-L3	X	X
Harmonic voltage L1-L3	X	
Harmonic current L1	X	X
Harmonic current L2	X	
Harmonic current L3	X	X
Harmonic current N	X	

Accuracy

All instrumentation data accuracy is defined within the voltage range 20 % of the stated nominal voltage and within the current range 5 % of the base current to the maximum current.

The accuracy of all instrumentation data except the voltage and current phase-angles is the same as the stated energy metering accuracy. The accuracy for the voltage and current phase-angles is 2 degrees.

5.3 Harmonics

General

The presence of harmonics in voltages and currents may cause a number of unwanted problems. This chapter describes the origin of harmonics, how the negative effects of harmonics can be eliminated and how harmonics is measured.

The harmonics data can be read via communication or directly in the display with the help of the buttons.

Generation of harmonics

Generators in the power system produce a nearly pure sinusoidal voltage with a frequency near the stated system frequency, normally 50 or 60 Hz. Linear loads, consisting of pure resistors, capacitors and inductors, draw a pure sinusoidal current if the voltage over the load is pure sinusoidal.

A non-linear load, however, draws non-sinusoidal current resulting in a current consisting of several frequencies. One example of a common non-linear load are power supplies in electronic equipment which normally contains rectifier diodes which rectifies the incoming voltage and charges a capacitor. The power supply only draws current at the top of the sine wave when the rectified voltage exceeds the voltage over the capacitor. Another example of a non linear load is a thyristor controlled load, where the current normally is turned on at the voltage zero crossing and turned off sometimes during the sine wave.

These currents are all non-sinusoidal and can be divided into a fundamental part, which is the same as the mains frequency, and high frequency parts, that is harmonics, which have frequency that are integral multiples of the mains frequency.

Harmonics in the current will in turn cause harmonics in the voltage since the mains wires and the generator have an impedance causing a voltage drop that is proportional to the current. It should also be pointed out that if there is harmonics in the voltage, also a linear load will cause harmonics in the current, that have the same magnitude as the voltage harmonics. However, the origin of harmonics in the voltage are non-linear loads.

Negative effects of harmonics

The presence of harmonics in voltages and currents can cause a number of problems:

- Increased cable losses. At higher frequencies skin and proximity effects increases, resulting in increased losses.
- High current in the neutral wire.
- Motor efficiency and product lifetime will decrease if the voltage contain harmonics.
- In transformers, harmonics will cause higher wire, hysteresis and eddy losses, which could result in efficiency losses up to 50%.
- Voltage harmonic can give higher peak voltages (higher crest factor), causing overvoltage protection devices to trip and in worst case destruction of devices.
- Voltage harmonic can result in decreased product lifetime and in worst case destruction of capacitor banks (used for power factor correction).
- Voltage harmonic can cause malfunction of devices controlled by the voltage, often zero crossings (voltage harmonics can give extra zero crossings).
- Voltage harmonics can produce disturbances within devices having its power supply connected to the mains causing problems.

Eliminating negative effects of harmonics

Because of the negative effects of harmonics it may be necessary to take actions to decrease the problems. This can be either done by decreasing the harmonics, and/or taking actions that decrease the negative effects of the harmonics.

Suggested actions

- Increase the size of the neutral conductor if the current is abnormally high due to harmonics.
 - Install appropriate filters to isolate loads with high current harmonics.
 - Install filters to protect to protect loads that are sensitive to voltage harmonics.
 - Oversize generators, motors and transformers to better cope with harmonics.
 - Substitute equipment for equipment that generates less current harmonics and is less sensitive to voltage harmonics.
-

5.3.1 Measuring Harmonics

General

To detect and eliminate the problems related to presence of harmonics, it's generally necessary to measure the harmonics. Meters that have harmonic measurement enabled measure harmonics on all voltages and currents up to the 16th harmonic and calculates the total harmonic distortion (THD).

Measuring

Measurement of the harmonics is done sequentially, one at a time, and approximately two harmonic numbers are measured every second.

Each harmonic is calculated according to:

$$I_n / I_f \cdot 100\%$$

and the total current harmonic distortion for the harmonics measured is calculated according to:

$$\sqrt{\sum_{n=2}^{16} I_n^2} / I_f \cdot 100\%$$

where I_f is the fundamental current and I_n is the current for harmonics with number n.

At each measurement the harmonic is set to 0 if the rms value of the current is below a certain lower limit (normally 5% of the basic current).

Folding distortion

Since the meter have limited sampling frequency, presence of harmonics over the 20:th harmonic (1 kHz at 50 Hz line frequency) will result in folding distortion and can affect the harmonic measurement accuracy negatively.

Due to the possible presence of folding distortion and the fact that harmonics is measured sequentially, one at a time, it is recommended that the harmonic measurement results of the meter is used as a tool to detect presence of harmonics and not as an exact instrument to get exact results.

Frequency measurement

Measuring harmonics require a valid frequency measurement. If the frequency measurement is uncertain, the harmonic measurement will not be performed. To get a valid measurement the meter uses a retry scheme. If the retry scheme does not give a valid measurement the harmonic will be marked as "not available".

Accuracy

The accuracy of the current harmonics varies with the harmonic amplitude and is valid only provided there is no harmonics above the 16th harmonic.

Harmonic Number	1% < Distortion ≤ 5%	5% < Distortion ≤ 10%	10% < Distortion ≤ 20%	20% < Distortion ≤ 50%	50% < Distortion ≤ 100%
2	± 0.5%*	± 1.0	± 2%	± 4%	± 6%
3	± 0.7%*	± 1.5%	± 3%	± 6%	± 9%
4	± 1.0%	± 2.0%	± 4%	± 8%	± 12%
5	± 1.2%	± 2.5%	± 5%	± 10%	± 15%
6	± 1.5%	± 3.0%	± 6%	± 12%	± 18%
7	± 1.7%	± 3.5%	± 7%	± 14%	± 21%
8	± 2.0%	± 4.0%	± 8%	± 16%	± 24%
9	± 2.5%	± 5.0%	± 10%	± 20%	± 30%
10	± 2.5%	± 5.0%	± 10%	± 20%	± 30%
11	± 2.5%	± 5.0%	± 10%	± 20%	± 30%
12	± 2.5%	± 5.0%	± 10%	± 20%	± 30%
13	± 2.5%	± 5.0%	± 10%	± 20%	± 30%
14	± 2.5%	± 5.0%	± 10%	± 20%	± 30%
15	± 2.5%	± 5.0%	± 10%	± 20%	± 30%
16	± 2.5%	± 5.0%	± 10%	± 20%	± 30%

* For distortion levels below 1% the absolute uncertainty is ± 0.5%.

5.4 Alarm

General

The purpose of the alarm function is to enable monitoring of quantities in the meter. Monitoring can be set to high or low level detection. High level detection gives an alarm when the level of a quantity goes above the set level. Low level detection gives an alarm when the value goes below the set level.

It is possible to configure 25 alarms. Configuration can be done via communication or with the buttons directly on the meter.

Quantities

Depending on the meter type all or a subset of the following quantities can be monitored:

Voltage L1	Reactive power L2
Voltage L2	Reactive power L3
Voltage L3	Apparent power total
Voltage L1-L2	Apparent power L1
Voltage L2-L3	Apparent power L2
Voltage L1-L3	Apparent power L3
Current L1	Power factor total
Current L2	power factor L1
Current L3	Power factor L2
Current N	power factor L3
Active power total	Harmonic voltage L1
Active power L1	Harmonic voltage L2
Active power L2	Harmonic voltage L3
Active power L3	Harmonic voltage L1-L2
Reactive power Total	Harmonic voltage L2-L3
Reactive power L1	Harmonic voltage L1-L3

Functional description

When the value of the monitored quantity passes the activation level, and remains there for a period of time equal or longer than the specified time delay, the alarm is activated. In the same way, the alarm is deactivated when the value passes the deactivation level and remains there for a time equal or longer than the specified time delay.

If the activation level is higher than the deactivation level, the alarm is activated when the value of the monitored quantity is higher than the activation level.

If the activation level is lower than the deactivation level, the alarm is activated when the value of the monitored quantity is lower than the activation level.

5.5 Inputs and Outputs

General

Inputs/outputs are built with autocouplers and are galvanically isolated from other meter electronics. They are polarity independent and handle both DC and AC voltage.

An input that is not connected equals having its voltage off.

The equivalent circuitry of the outputs is an ideal relay in series with a resistor.

Functionality of inputs

The inputs count pulses, register activity and current status and the data can be read directly on the meter display or via communication

Register activity can be reset via communication or via the buttons directly on the meter.

Functionality of outputs

The outputs can be controlled by communication, alarm or by the internal clock.

5.5.1 Tariff Inputs

Tariff control

On meters with tariff functionality, the tariffs are controlled either via communication, the internal clock or by 1 or 2 tariff inputs.

Tariff control via inputs is done by applying a proper combination of "voltage" or "no voltage" to the input(s). Each combination of "voltage"/"no voltage" will result in that the meter will register the energy in a particular tariff register.

In combined meters with both active and reactive metering, both quantities are controlled by the same inputs and the active tariff for active and reactive energy will always be the same.

Indication of active tariff

The active tariff is displayed on the LCD by the text "Tx" in the status field, where x is the tariff number. The active tariff can also be read via communication.

Input coding, meters with 4 tariffs

The coding of the inputs is binary. The following table describes the default coding.

Input 4	Input 3	Tariff
OFF	OFF	= T1
OFF	ON	= T2
ON	OFF	= T3
ON	ON	= T4

Input coding, meters with 2 tariffs

The coding of the inputs is binary. The following table describes the default coding.

Input 3	Tariff
OFF	= T1
ON	= T2

5.5.2 Pulse Outputs

About pulse outputs

Meters equipped with pulse outputs may have up to 4 outputs.

On the pulse outputs the meter sends out a specified number of pulses (pulse frequency) per kilowatt hour (kilovar for reactive pulse outputs).

The pulse outputs are primary, which means that the pulses are sent out in proportion to the true primary energy, taking current and voltage transformer ratios (CT and VT ratio) programmed on the meter into account.

For direct connected meters no external transformers are used and the amount of pulses sent out are in proportion to the energy flowed through the meter.

5.5.2.1 Pulse Frequency and Pulse length

General

Pulse frequency and pulse length can be set via the buttons on the meter or via communication. If the meter have more than 1 pulse output, all outputs will have the same pulse frequency and pulse length.

Pulse frequency

The pulse frequency is configurable and can be set to a value between 1-9999 impulses. The value must be an integer. The unit is selectable and may be set to imp/kWh, imp/Wh or imp/MWh.

Pulse length

The pulse length can be set to a value between 10-990 ms.

Deciding pulse frequency/length

If the power is too high for a certain pulse length and pulse frequency, there is a risk that the pulses may go into one another. If this happens the meter will emit a new pulse (relay closed) before the previous one has terminated (relay open) and the pulse will be missed. In worst case the relay may be closed at all times.

To avoid this problem a calculation should be made to work out the maximum pulse frequency allowed at a particular site based upon an estimated maximum power and the meter's pulse output data.

Formula

The formula to use for this calculation is:

$$\text{Max pulse frequency} = 1000 * 3600 / U / I / n / (P_{\text{pause}} + P_{\text{length}})$$

where U and I is the estimated maximum element voltage (in volts) and current (in amperes), n the number of elements (1 - 3). Plength and Ppause are the pulse length and the required pulse pause (in seconds). A reasonable minimum pulse length and pulse pause is 30 ms which conforms to the S0 and IEC standard.



Note – U and I have to be the primary values in a transformer connected meter if the CT and VT for the external transformers are programmed into the meter.

Example 1

In a direct connected 3-element meter with estimated maximum voltage and current of 250 V and 65 A and pulse length 100 ms and required pulse pause 30 ms, the maximum allowed pulse frequency will be:

$$1000 * 3600 / 250 / 65 / 3 / (0.030 + 0.100) = 568 \text{ impulses / kWh (kvarh)}$$

Example 2

In a transformer connected 3-element meter with estimated maximum voltage and current of $63 * 100 \text{ V} = 6300 \text{ V}$ (VT ratio 100) and $6 * 50 \text{ A} = 300 \text{ A}$ (CT ratio 50) and pulse width 100 ms and required pulse pause 30 ms the maximum allowed pulse frequency will be:

$$1000 * 3600 / 6300 / 300 / 3 / (0.030 + 0.100) = 6.16 \text{ impulses / kWh (kvarh)}$$

5.6 Internal Clock

General	Meter with a built-in clock automatically keeps track of leap year and daylight savings time (DST). The use of DST is optional. Time is controlled by a quartz crystal real time clock.
Time and date	Time and date can be set via communication, or with the buttons directly on the meter.
Time dependant functions	<ul style="list-style-type: none">• Load profile• Maximum demand• Minimum demand• Previous values• Event log• Outputs controlled by time• Tariff control
Backup of clock	In case of power failure a super capacitor backs up the clock for 48 hours.

5.7 Logs

General

The meter contains a total of five different logs:

- System Log
- Event Log
- Net Quality Log
- Audit log
- Settings Log

Log events can be read via communication or directly in the display of the meter.

A maximum of 500 log events can be stored in the System Log, the Event Log and the Net Quality Log. When the maximum number of events for a log is reached, the oldest events will be overwritten.

A maximum of 40 log events can be stored in the Audit Log. When the maximum number of events for this log is reached, no more events can be stored. A new firmware upgrade attempt will be unsuccessful because no more log events can be stored.

A maximum of 80 log events can be stored in the Settings Log. When the maximum number of events for this log is reached, no more events can be stored. A new setting for either CT/VT or number of elements will not be accepted because no more log events can be stored.

It is possible to delete all entries in the System Log, The Event Log and the Net Quality Log via communication.

5.7.1 System Log

This log stores events that relate to errors in the meter.

Contents

The following information is stored in an event:

- Date and time
- Event Code
- Duration

The following events are stored in this log:

- Program CRC Error - Error when checking firmware consistency.
 - Persistent Storage Error - Data stored in long-term memory is corrupt.
 - RTC Circuit Error - Error when trying to read date and time from real-time clock.
-

5.7.2 Event Log

This log stores events that relate to alarms and configuration warnings.

Contents

The following information is stored in an event:

- Date and Time
- Event Code
- Duration

The following events are stored in this log:

- Date Not Set Warning - Date has not been configured for RTC.
 - Time Not Set Warning - Time has not been configured for RTC.
 - Negative Power Element 1 Warning - Element 1 measures negative power.
 - Negative Power Element 2 Warning - Element 2 measures negative power.
 - Negative Power Element 3 Warning - Element 3 measures negative power.
 - Negative Total Power Warning - Total power is measured as negative.
 - Alarm Current L1
 - Alarm current L2
 - Alarm Current L3
 - Alarm Current Neutral
 - Alarm Active Power Total
 - Alarm Active Power L1
 - Alarm Active Power L2
 - Alarm Active Power L3
 - Alarm Reactive Power total
 - Alarm Reactive Power L1
 - Alarm Reactive Power L2
 - Alarm Reactive Power L3
 - Alarm Apparent power Total
 - Alarm Apparent power L1
 - Alarm Apparent power L2
 - Alarm Apparent power L3
 - Alarm Power Factor Total
 - Alarm Power Factor L1
 - Alarm Power Factor L2
 - Alarm Power Factor L3
-

5.7.3 Net Quality Log

This log stores alarms and information that relates to net quality.

Contents

The following events are stored in this log

- U1 Missing Warning - U1 is missing
 - U2 Missing Warning - U2 is missing
 - U3 Missing Warning - U3 is missing
 - Frequency Warning - Net frequency is not stable
 - Alarm Voltage L1
 - Alarm Voltage L2
 - Alarm Voltage L3
 - Alarm Voltage L1-L2
 - Alarm Voltage L2-L3
 - Alarm Voltage L1-L3
 - Alarm Harmonic Voltage L1
 - Alarm Harmonic Voltage L2
 - Alarm Harmonic Voltage L3
 - Alarm Harmonic Voltage L1-L2
 - Alarm Harmonic Voltage L2-L3
 - Alarm Harmonic Voltage L1-L3
-

5.7.4 Audit Log

The Audit Log stores an event after an attempt has been made to upgrade the firmware.

Contents

The following information is stored in an event:

- Date and Time
 - Firmware version
 - Active Energy import
 - Active Energy import L1
 - Active Energy import L2
 - Active Energy import L3
 - Active Energy import Tariff 1
 - Active Energy import Tariff 2
 - Active Energy import Tariff 3
 - Active Energy import Tariff 4
 - Active Energy Export
 - Firmware Upgrade status
-

5.7.5 Settings Log

This log stores an event when the transformer ratio is reconfigured.

Contents

The following information is stored in an event:

- Date and Time
- Firmware version
- Active Energy import
- Active Energy import L1
- Active Energy import L2
- Active Energy import L3
- Active Energy import Tariff 1
- Active Energy import Tariff 2
- Active Energy import Tariff 3
- Active Energy import Tariff 4
- Active Energy Export
- CT-Value
- VT-Value
- Elements

5.7.6 Event codes

Description

The following table describes the event codes that may occur in the System log, the Event log and the Net quality log:

Event code	Event
41	Program CRC error
42	Persistent storage error
53	RTC circuit error
1000	U1 Missing Warning
1001	U2 Missing Warning
1002	U3 Missing Warning
1004	Negative Power Element 1 Warning
1005	Negative Power Element 2 Warning
1006	Negative Power Element 3 Warning
1007	Negative Total power Warning
1008	Frequency Warning
1010	Date Not Set Warning
1011	Time Not Set Warning
2013	Alarm 1 active
2014	Alarm 2 active

Event code	Event
2015	Alarm 3 active
2016	Alarm 4 active
2017	Alarm 5 active
2018	Alarm 6 active
2019	Alarm 7 active
2020	Alarm 8 active
2021	Alarm 9 active
2022	Alarm 10 active
2023	Alarm 11 active
2024	Alarm 12 active
2025	Alarm 13 active
2026	Alarm 14 active
2027	Alarm 15 active
2028	Alarm 16 active
2029	Alarm 17 active
2030	Alarm 18 active
2031	Alarm 19 active
2032	Alarm 20 active
2033	Alarm 21 active
2034	Alarm 22 active
2035	Alarm 23 active
2036	Alarm 24 active
2037	Alarm 25 active

5.8 Demand

General

The demand functionality is used to measure and store the maximum and minimum demands of different quantities in the meter. Time is divided into intervals of a certain length in which the mean values of a set of selected quantities are measured.

Demand can be configured via communication or via the buttons on the meter.



Note – Before any demand values can be stored, time/date must be set.

Changing time/ date will store the current period and start a new one.

If a power fail occurs that lasts over the end of an ongoing period, the period will be stored when the meter powers up again and a new period will start. If date/time is not set when the meter powers up again, demand will enter a waiting state until time/date is set.

Interval length

The interval lengths for demand can be one of the following: 1, 2, 5, 10, 15, 20, 30, 60, 120, 180, 240, 360, 480, 720 or 1440 minutes.

Storing periods

When the last interval of an ongoing period has finished, the maximum- and/or minimum values are stored and a new period starts.

The length of a demand period can be a day, a week or a month.

Demand has 50 channels which can be configured individually. Each channel can store up to 200 periods. A stored period contains the demand value, the date/time of the period and the date/time of the interval when the demand value was measured. All channels use the same interval and period length.

The period/interval date and time is stored as end of period/interval. For instance, if a period starts 2010.01.01 00:00.00 and ends 2010.01.02 00:00.00, then the stored period will be 2010.01.02 00:00.00.

If there is no free memory space available, the oldest period will be erased to make room for the most recent one.

Stored periods can be read via communication or directly on the display.

An ongoing period can be ended and a new one started by sending a “freeze demand” via communication.

It is also possible to erase all stored periods by sending a “Reset Demand” command via communication.

Demand values

The number of demand values to be stored during a period is individually configurable per channel. Each demand channel can be configured to store up to the three highest or lowest demand values. If demand is configured to store only one maximum interval, then only the interval with the maximum peak will be re-

corded. If demand is configured to store three maximum intervals the intervals with the three highest peaks are recorded.

Sliding demand

A demand channel can also be configured as maximum sliding demand or minimum sliding demand. A sub-interval time is set which divides the interval into a circular array with a new mean value calculated at the end of every sub-interval. The selectable sub-interval times for demand is a subset of the interval times and evenly divisible with the selected interval time.

Selectable quantities

Depending on the meter type all or a subset of the following quantities can be selected.

ACTIVE ENERGY IMPORT TOTAL	HARMONIC VOLTAGE L1*
ACTIVE ENERGY IMPORT L1	HARMONIC VOLTAGE L2*
ACTIVE ENERGY IMPORT L2	HARMONIC VOLTAGE L3*
ACTIVE ENERGY IMPORT L3	HARMONIC VOLTAGE L1-L2*
REACTIVE ENERGY IMPORT TOTAL	HARMONIC VOLTAGE L2-L3*
REACTIVE ENERGY IMPORT L1	HARMONIC VOLTAGE L1-L3*
REACTIVE ENERGY IMPORT L2	CURRENT L1*
REACTIVE ENERGY IMPORT L3	CURRENT L2*
APPARENT ENERGY IMPORT TOTAL	CURRENT L3*
APPARENT ENERGY IMPORT L1	HARMONIC CURRENT L1*
APPARENT ENERGY IMPORT L2	HARMONIC CURRENT L2*
APPARENT ENERGY IMPORT L3	HARMONIC CURRENT L3*
ACTIVE ENERGY IMPORT TARIFF1	ACTIVE POWER TOTAL*
ACTIVE ENERGY IMPORT TARIFF2	HARMONIC CURRENT NEUTRAL*
ACTIVE ENERGY IMPORT TARIFF3	ACTIVE POWER L1*
ACTIVE ENERGY IMPORT TARIFF4	ACTIVE POWER L2*
REACTIVE ENERGY IMPORT TARIFF1	ACTIVE POWER L3*
REACTIVE ENERGY IMPORT TARIFF2	REACTIVE POWER TOTAL*
REACTIVE ENERGY IMPORT TARIFF3	REACTIVE POWER L1*
REACTIVE ENERGY IMPORT TARIFF4	REACTIVE POWER L2*
VOLTAGE L1*	REACTIVE POWER L3*
VOLTAGE L2*	APPARENT POWER TOTAL*
VOLTAGE L3*	APPARENT POWER L1*
VOLTAGE L1-L2*	APPARENT POWER L2*
VOLTAGE L2-L3*	APPARENT POWER L3*
VOLTAGE L1-L3*	PULSE INPUT COUNTERS

* The value is a mean value of the period.

5.9 Previous Values

General

At the end of a defined period, up to 50 configurable channels, which can contain energy register values, input counter values and currency/CO₂ values, are stored together with the current time/date

Previous values can be configured via communication or via the buttons on the meter.



Note – Before any previous values can be stored, time/date must be set.

Changing time/ date will store the current period and start a new one.

If a power fail occurs that lasts over the end of an ongoing period, the period will be stored when the meter powers up again and a new period will start. If date/time is not set when the meter powers up again, previous values will enter a waiting state until time/date is set.

Storing periods

Previous values has 50 channels which can be configured individually via communication. Each channel can store up to 200 periods.

The period length can be a day, a week or a month and can be configured via communication or via the buttons on the meter.

The period date and time is stored as end of period. For instance, if a period starts 2010.01.01 00:00.00 and ends 2010.01.02 00:00.00, then the stored period will be 2010.01.02 00:00.00.

Stored periods can be read via communication or directly on the display.

If there is no free memory space available, the oldest period will be erased to make room for the most recent one.

It is possible to erase all stored periods by sending a “Reset Previous Values” command via communication.

Selectable quantities

Depending on the meter type all or a subset of the following quantities can be selected.

ACTIVE ENERGY IMPORT TOTAL	ACTIVE ENERGY IMPORT TARIFF3
ACTIVE ENERGY EXPORT TOTAL	ACTIVE ENERGY IMPORT TARIFF4
ACTIVE ENERGY IMPORT L1	REACTIVE ENERGY IMPORT TARIFF1
ACTIVE ENERGY IMPORT L2	REACTIVE ENERGY IMPORT TARIFF2
ACTIVE ENERGY IMPORT L3	REACTIVE ENERGY IMPORT TARIFF3
ACTIVE ENERGY EXPORT L1	REACTIVE ENERGY IMPORT TARIFF4
ACTIVE ENERGY EXPORT L2	REACTIVE ENERGY EXPORT TARIFF1
ACTIVE ENERGY EXPORT L3	REACTIVE ENERGY EXPORT TARIFF2
REACTIVE ENERGY IMPORT TOTAL	REACTIVE ENERGY EXPORT TARIFF3
REACTIVE ENERGY EXPORT TOTAL	REACTIVE ENERGY EXPORT TARIFF4

REACTIVE ENERGY IMPORT L1	ACTIVE ENERGY EXPORT TARIFF1
REACTIVE ENERGY IMPORT L2	ACTIVE ENERGY EXPORT TARIFF2
REACTIVE ENERGY IMPORT L3	ACTIVE ENERGY EXPORT TARIFF3
REACTIVE ENERGY EXPORT L1	ACTIVE ENERGY EXPORT TARIFF4
REACTIVE ENERGY EXPORT L2	ACTIVE ENERGY NET TOTAL
REACTIVE ENERGY EXPORT L3	ACTIVE ENERGY NET L1
APPARENT ENERGY IMPORT TOTAL	ACTIVE ENERGY NET L2
APPARENT ENERGY EXPORT TOTAL	ACTIVE ENERGY NET L3
APPARENT ENERGY IMPORT L1	REACTIVE ENERGY NET TOTAL
APPARENT ENERGY IMPORT L2	REACTIVE ENERGY NET L1
APPARENT ENERGY IMPORT L3	REACTIVE ENERGY NET L2
APPARENT ENERGY EXPORT L1	REACTIVE ENERGY NET L3
APPARENT ENERGY EXPORT L2	APPARENT ENERGY NET TOTAL
APPARENT ENERGY EXPORT L3	APPARENT ENERGY NET L1
RESETTABLE ACTIVE ENERGY IMPORT TOTAL	APPARENT ENERGY NET L2
RESETTABLE ACTIVE ENERGY EXPORT TOTAL	APPARENT ENERGY NET L3
RESETTABLE REACTIVE ENERGY IMPORT TOTAL	ACTIVE ENERGY CURRENCY CONVERSION
RESETTABLE REACTIVE ENERGY EXPORT TOTAL	ACTIVE ENERGY CO2 CONVERSION
ACTIVE ENERGY IMPORT TARIFF1	
ACTIVE ENERGY IMPORT TARIFF2	

5.10 Load Profile

General

A load profile is a collection of 8 channels that can store register values. Through communication each channel can be assigned one register, a time interval and a minimum amount of snapshots to be stored in the channel.

Interval per channel can also be configured via the buttons on the meter.

The load profiles can be read via communication or directly on the display.

The stored register values in a channel can be read either as a list of snapshots or as interval consumptions.



Note – Before any load profiles can be stored, time/date must be set.

If a power failure occurs toward the end of an interval, the event will be stored when the meter powers up again only if time/date are still correct.

Intervals

The interval lengths for Load Profiles can be one of the following: 1, 2, 5, 10, 15, 20, 30, 60, 120, 180, 240, 360, 480, 720 or 1440 minutes.

If the interval is evenly divisible with an hour, the start of each hour will mark the start of a new interval. If the interval is evenly divisible with a day, the start of a day will mark the start of a new interval.

The interval date and time is stored as end of interval. For instance, if an interval starts 2010.01.01 00:00.00 and ends 2010.01.01 00:15.00, then the stored period will be 2010.01.01 00:15.00.

Example 1

Interval is set to 120 minutes, current time 12:13. Evenly divisible with a day. The next interval end/start times will be: 14:00, 16:00, 18:00, 20:00, 22:00, 00:00, etc,...

Example 2

Interval is set to 15 minutes, current time 12:13. Evenly divisible with an hour. The next interval end/start times will be: 12:15, 12:30, 12:45, 13:00, 13.15, 13.30 etc,...

Channels and snapshots

Each channel has its own interval configuration. That means that snapshots in one channel can be stored with a different interval than snapshots in another channel.

Each channel can be assigned a number of snapshots. A total of 40 000 snapshots can be stored in a load profile. All channels in a load profile share the same memory area, which means that one channel can store 40 000 snapshots if no other

channel is used. By default the meter has all 8 channels activated with 5000 snapshots assigned to each.

If there is no free memory space available, the oldest snapshot will be erased to make room for the most recent one.

It is possible to erase all snapshots per channel by sending a “Reset Load profile” command via communication.

Reading snapshots

There are two ways of reading out the snapshots:

- **Smart search** automatically ignores all duplicate snapshots that may have been stored if time/date has been changed backwards.
- **Raw search** outputs all snapshots that are stored in memory, including any duplicate.

By default, the search type is set to smart search. The search type can be configured via communication.

Load profile data

Each load profile data value is associated with a status value. The status value gives information such as:

- Interval is longer or shorter than defined length
- Power outage occurred during interval
- Data not available

Selectable quantities

Depending on the meter type all or a subset of the following quantities can be selected:

ACTIVE ENERGY IMPORT TOTAL	APPARENT ENERGY IMPORT L3
ACTIVE ENERGY EXPORT TOTAL	APPARENT ENERGY EXPORT L1
ACTIVE ENERGY IMPORT L1	APPARENT ENERGY EXPORT L2
ACTIVE ENERGY IMPORT L2	APPARENT ENERGY EXPORT L3
ACTIVE ENERGY IMPORT L3	ACTIVE ENERGY CURRENCY CONVERSION
ACTIVE ENERGY EXPORT L1	ACTIVE ENERGY CO2 CONVERSION
ACTIVE ENERGY EXPORT L2	VOLTAGE L1*
ACTIVE ENERGY EXPORT L3	VOLTAGE L2*
REACTIVE ENERGY IMPORT TOTAL	VOLTAGE L3*
REACTIVE ENERGY EXPORT TOTAL	VOLTAGE L1-L2*
REACTIVE ENERGY IMPORT L1	VOLTAGE L2-L3*
REACTIVE ENERGY IMPORT L2	VOLTAGE L1-L3*
REACTIVE ENERGY IMPORT L3	CURRENT L1*
REACTIVE ENERGY EXPORT L1	CURRENT L2*
REACTIVE ENERGY EXPORT L2	CURRENT L3*
REACTIVE ENERGY EXPORT L3	CURRENT Neutral
APPARENT ENERGY IMPORT TOTAL	POWER FACTOR TOTAL*
APPARENT ENERGY EXPORT TOTAL	POWER FACTOR L1*
APPARENT ENERGY IMPORT L1	POWER FACTOR L2*
APPARENT ENERGY IMPORT L2	POWER FACTOR L3*

The value is a mean value of the period.

Chapter 6: Technical data

Overview This chapter contains technical data and product drawings.

In this chapter The following topics are covered in this chapter:

- 6.1 Technical Specifications 72
- 6.2 Physical dimensions 76

6.1 Technical Specifications

Specifications for A 41 direct connected meters

Voltage/current inputs	
Nominal voltage	230 VAC
Voltage range	57.7 - 288 VAC (-20%+15%)
Power dissipation voltage circuits	0.8 VA (0.8 W) total
Power dissipation current circuits	0.007 VA (0.007 W) at 230 VAC and I_{ref}
Base current I_b	5 A
Reference current I_{ref}	5 A
Transitional current I_{tr}	0.5 A
Maximum current I_{max}	80 A
Minimum current I_{min}	0.25 A
Starting current I_{st}	< 20 mA
Terminal wire area	1-25 mm ²
Recommended tightening torque	2.5 Nm
General data	
Frequency	50 or 60 Hz ± 5%
Accuracy	1%
Display	96x64 pixels, view area 39x26 mm
Mechanical	
Material	Polycarbonate in transparent front glass, bottom case, upper case and terminal cover. Glass reinforced polycarbonate in terminal block.
Weight	
Environmental	
Operating temperature	-40°C - +70°C
Storage temperature	-40°C - +85°C
Humidity	75% yearly average, 95% on 30 days/year.
Resistance to fire and heat	Terminal 960°C, cover 650°C (IEC 60695-2-1)
Resistance to water and dust	IP 20 on terminal block without protective enclosure and IP 51 in protective enclosure, according to IEC 60529.
Mechanical environment	Class M1 in accordance with the Measuring Instrument Directive (MID), (2004/22/EC).
Electromagnetic environment	Class E2 in accordance with the Measuring Instrument Directive (MID), (2004/22/EC).
Outputs	
Current	2 - 100 mA
Voltage	24 VAC - 240 VAC, 24 VDC - 240 VDC. For meters with only 1 output, 5 - 40VDC.
Pulse output frequency	Prog. 1 - 9999 imp/MWh, 1 - 9999 imp/kWh, 1 - 9999 imp/Wh
Pulse length	10 - 990 ms
Terminal wire area	0.5 - 1 mm ²

Recommended tightening torque	0.25 Nm
Inputs	
Voltage	0-240 V AC/DC
OFF	0-20 V AC/DC
ON	45-240 V AC/DC
Min. pulse length	30 ms
terminal wire area	0.5 - 1 mm ²
Recommended tightening torque	0.25 Nm
Communication	
Terminal wire area	0.5 - 1 mm ²
Recommended tightening torque	0.25 Nm
Pulse indicator(LED)	
Pulse frequency	1000 imp/kWh
Pulse length	40 ms
EMC compatibility	
Impulse voltage test	6 kV 1.2/50μs (IEC 60060-1)
Surge voltage test	4 kV 1.2/50μs (IEC 61000-4-5)
Fast transient burn test	4 kV (IEC 61000-4-4)
Immunity to electromagnetic HF-fields	80 MHz - 2 GHz at 10 V/m (IEC61000-4-3)
Immunity to conducted disturbance	150kHz – 80MHz, (IEC 61000-4-6)
Immunity to electromagnetic disturbances	2-150 kHz for kWh-meters
Radio frequency emission	EN 55022, class B (CISPR22)
Electrostatic discharge	15 kV (IEC 61000-4-2)
Standards	IEC 62052-11, IEC 62053-21 class 1 & 2, IEC 62053-23 class 2, IEC 62054-21, GB/T 17215.211-2006, GBT 17215.321-2008 class 1 & 2, GB 4208-2008, EN 50470-1, EN 50470-3 category A & B

Specifications for A 42 transformer rated meter

Voltage inputs	
Nominal voltage	230 VAC
Voltage range	57,7 - 288 VAC (-20%~+15%)
Power dissipation voltage circuits	0.8 VA (0.8 W) total
Power dissipation current circuits	0.001 VA (0.001 W) at 230 VAC and I _{ref}
Terminal wire area	0.5 - 10 mm ²
Recommended tightening torque	2 Nm
Current inputs	
Rated current I _n	1 A
Reference current I _{ref}	1 A
Transitional current I _{tr}	0.05 A
Maximum current I _{max}	6 A

Minimum current I_{\min}	0.02 A
Starting current I_{st}	< 1 mA
Terminal wire area	0.5 - 10mm
Recommended tightening torque	2 Nm
General data	
Frequency	50 or 60 Hz \pm 5% or 16,7 Hz (optional)
Accuracy	0.5%, 1%
Display	96x64 pixels, view area 39x26 mm
Mechanical	
Material	Polycarbonate in transparent front glass, bottom case, upper case and terminal cover. Glass reinforced polycarbonate in terminal block.
Weight	
Environmental	
Operating temperature	-40°C - 70°C
Storage temperature	-40°C - 85°C
Humidity	75% yearly average, 95% on 30 days/year
Resistance to fire and heat	Terminal 960°C, cover 650°C (IEC 60695-2-1)
Resistance to water and dust	IP 20 on terminal block without protective enclosure and IP 51 in protective enclosure, according to IEC 60529.
Mechanical environment	Class M1 in accordance with the Measuring Instrument Directive (MID), (2004/22/EC).
Electromagnetic environment	Class E2 in accordance with the Measuring Instrument Directive (MID), (2004/22/EC).
Outputs	
Current	2 - 100 mA
Voltage	24 VAC - 240 VAC, 24 VDC - 240 VDC. For meters with only 1 output, 5 - 40VDC.
Pulse output frequency	Prog. 1 - 9999 imp/MWh, 1 - 9999 imp/kWh, 1 - 9999 imp/Wh
Pulse length	10 - 990 ms
Terminal wire area	0.5 - 1mm ²
Recommended tightening torque	0.25 Nm
Inputs	
Voltage	0-240 V AC/DC
OFF	0-20 V AC/DC
ON	45-240 V AC/DC
Min. pulse length	30 ms
Terminal wire area	0.5 - 1mm ²
Recommended tightening torque	0.25 Nm
Transformer ratios	
Programmable voltage ratio (VT)	1 - 9999
Programmable current ratio (CT)	1 - 9999
Max total transformer ratio (VT*CT)	999999
Pulse indicator(LED)	

Pulse frequency	5000 imp/kWh
Pulse length	40 ms
EMC compatibility	
Impulse voltage test	6 kV 1.2/50µs (IEC 60060-1)
Surge voltage test	4 kV 1.2/50µs (IEC 61000-4-5)
Fast transient burn test	4 kV (IEC 61000-4-4)
Immunity to electromagnetic HF-fields	80 MHz - 2 GHz at 10 V/m (IEC61000-4-3)
Immunity to conducted disturbance	150kHz – 80MHz, (IEC 61000-4-6)
Immunity to electromagnetic disturbances	2-150 kHz for kWh-meters
Radio frequency emission	EN 55022, class B (CISPR22)
Electrostatic discharge	15 kV (IEC 61000-4-2)
Standards	IEC 62052-11, IEC 62053-21 class 1 & 2, IEC 62053-23 class 2, IEC 62054-21, GB/T 17215.211-2006, GBT 17215.321-2008 class 1 & 2, GB 4208-2008, EN 50470-1, EN 50470-3 category A & B

6.2 Physical dimensions

A41/A42

The following drawing shows the physical dimensions of the A41/A42 meters.

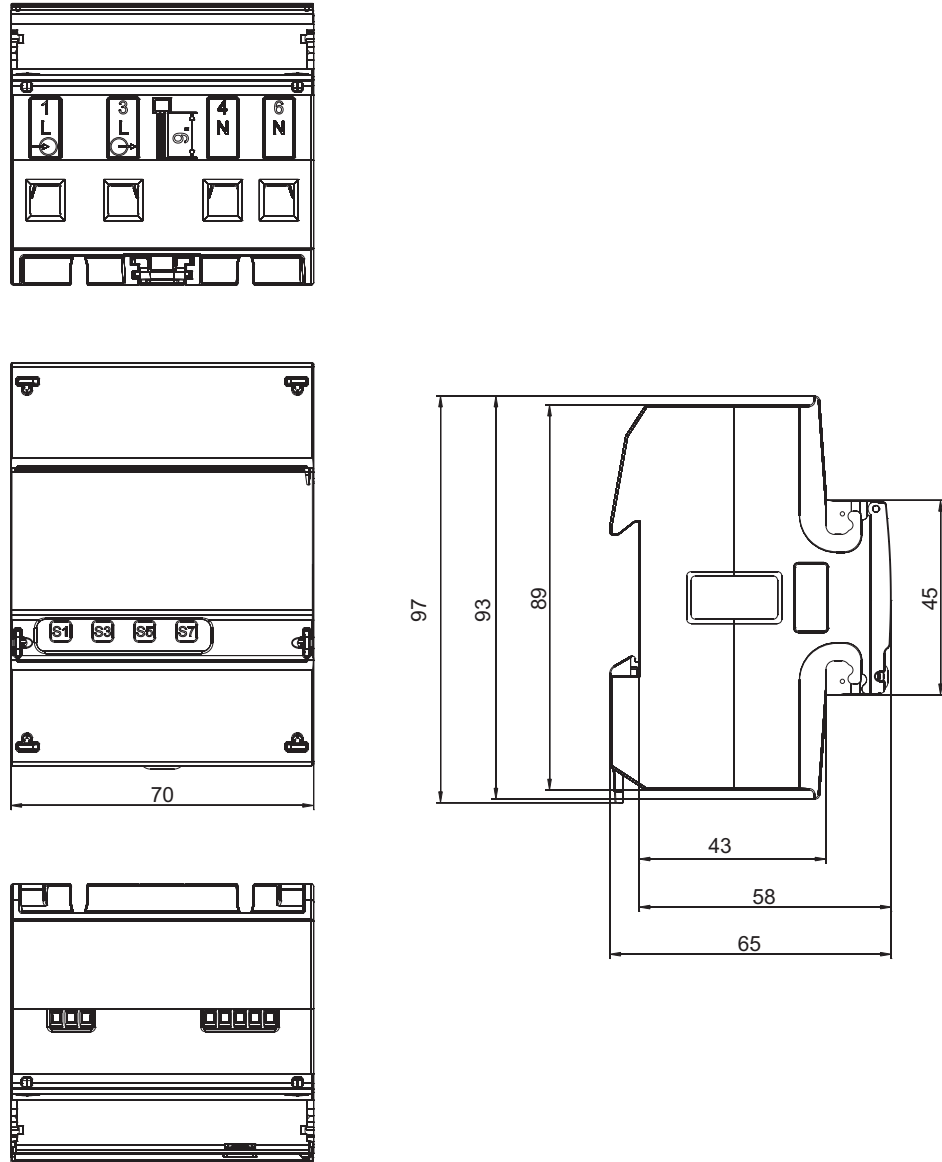

Chapter 7: Measurement Methods

Overview

This chapter contains information about measurement theory and the most commonly used measurement methods. The information can be used to better understand the meter behavior and/or to pick the correct measurement method.

In this chapter

The following topics are covered in this chapter:

- 7.1 Measuring Energy 80
 - 7.1.1 Single Phase, 1-Element Metering 82
 - 7.1.2 3-Phase, 2-Element Metering 84
 - 7.1.3 3-Phase, 3-Element Metering 86

7.1 Measuring Energy

Active energy

It is easy to understand the need for a utility to measure active energy, since the information is necessary to bill the customer correctly. Usually the more energy the customer consumes the higher the accuracy of the meter needs to be. Normally 4 accuracy classes are used: 2%- (small consumers, e.g. households), 1%-, 0.5%- and 0.2%-meters with defined power levels for each class.

Also from a customer point of view it is easy to understand the need to measure the active energy as it can give him information about where and when energy is consumed. This information can then be used to take measures to decrease the consumption.

In many cases it is desired to simplify the measurement. In such cases simplified methods can be used of which the most common are described in this chapter. These methods most often require a balanced load, which means that the impedance is the same in all phases giving the same current amplitude and power factor in all phases.



Note – It should be mentioned that even if the load is perfectly balanced the accuracy will be decreased if the incoming voltages are not the same on all phases.

Reactive energy

Sometimes there is also a need to measure the reactive energy. Consumer equipment often introduces a phase shift between current and voltage due to the fact that the load has a more or less reactive component, e.g. motors that have an inductive component, etc. A reactive load will increase the current which means that the power source generator and the size of the power lines have to increase which in turn means higher cost for the utility. A higher current also means that the line losses increase.

Because of that, the maximum permissible phase shift is sometimes governed in the terms of the contract that the consumer have with the power supplier. If the consumer exceeds a specified maximum reactive load, he will be liable for an extra charge. This type of contract will require a utility meter that measures reactive energy and/or power.

Also, from the customer's point of view, it may be of some interest to measure reactive energy/power since it gives him knowledge about the nature of the load. That is, how big the different loads are and how they vary over time. This knowledge can be used in the planning how to decrease the reactive power/energy to decrease the electricity bill.

Resistive, inductive and capacitive loads

Resistive loads don't give rise to any phase shifts. Inductive loads have phase shift in one direction with the current lagging the voltage, while capacitive loads produces a phase shift in the opposite direction with the current leading the voltage. As a result, inductive and capacitive loads can be used to compensate each other

Illustration

The following illustration shows a vector diagram for resistive, inductive and capacitive loads:

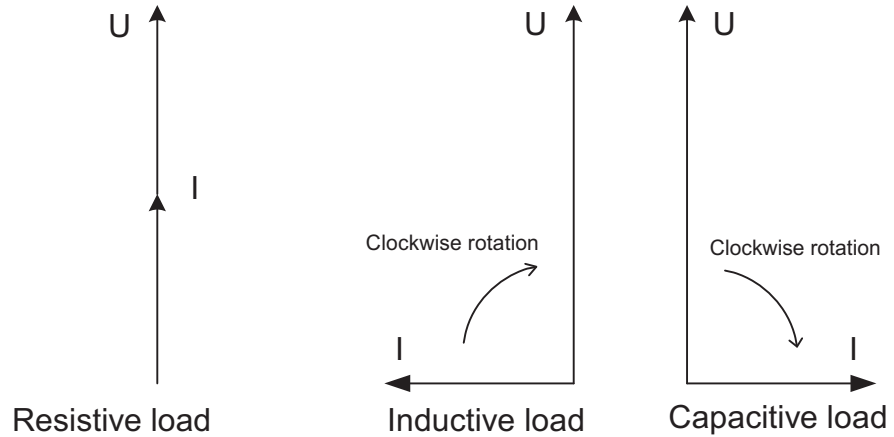

Phase displacement

A load that consumes both reactive and active energy can be divided into active and reactive components. The angle between the apparent power ($U \cdot I$) vector and the active power component is described as phase displacement angle or power factor angle, often referred to as ϕ . $\cos \phi$ is referred to as the power factor.

Illustration

The following illustration shows a vector diagram for a load with an active and a reactive component:

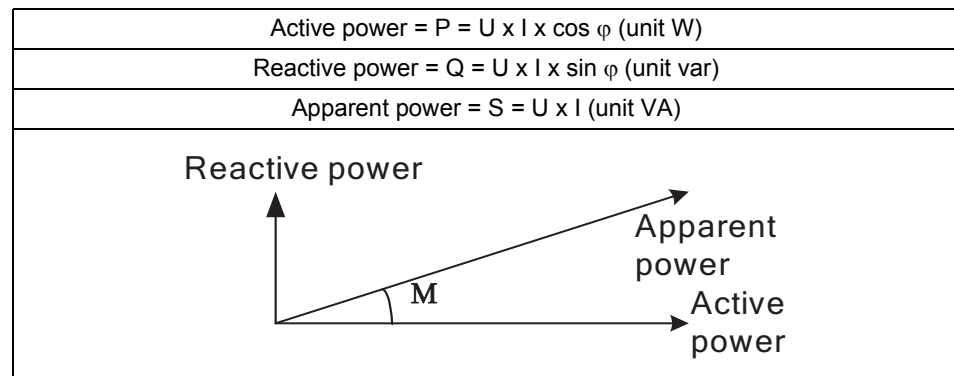

The 4 power quadrants

The type of load can be represented geometrically by four quadrants. In the first quadrant the load is inductive and active and energy is imported (energy is delivered from the utility to the customer). In the second quadrant the load is capacitive and active energy is exported and reactive energy is imported. In the third quadrant the load is inductive and active and reactive energy is exported. In the last quadrant the load is capacitive and active energy is imported and reactive energy exported.

Illustration

The following illustration shows the loads

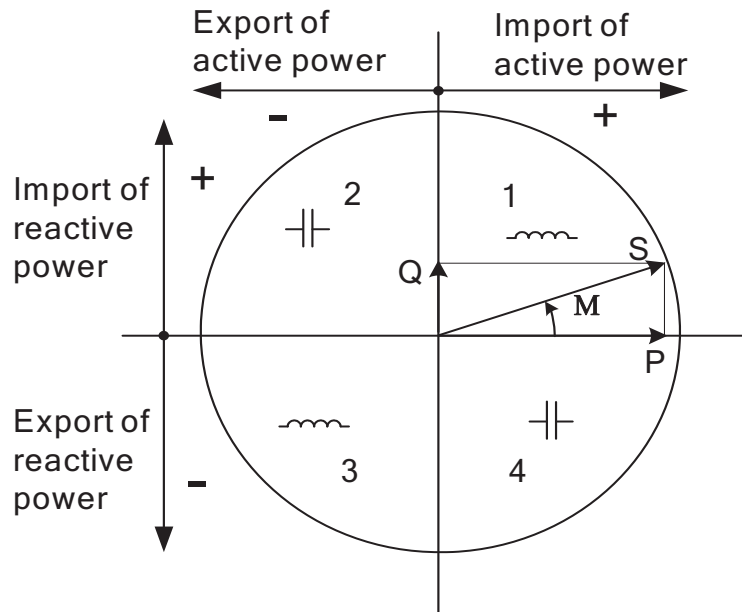

7.1.1 Single Phase, 1-Element Metering**1- element metering in a 2-wire system**

In a 2-wire installation a single phase meter is used. Normally the 2 wires are a phase voltage and the neutral.

The active energy consumed by the load is the product of momentary voltage and current integrated over the desired measuring time period.

Calculating active power

In the case where no harmonics is present and the rms value of the voltage and current is constant, the active power can be expressed as:

$$P = U_{\text{rms}} * I_{\text{rms}} * \cos \varphi$$

where φ is the phase angle between the voltage and the current.

Illustration

The following illustration shows a direct connected single phase meter measuring the active energy (E) consumed by a load.

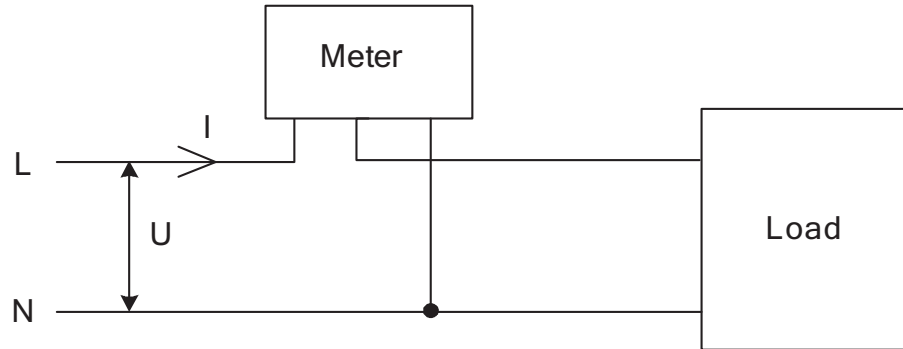

1-element metering in a 4-wire system

In 4-wire system the single element metering method only gives correct results in a balanced system (same voltage, current and power factor in all phases). This method should not be used for accurate measurement, but can be used when high accuracy is not needed.

Illustration

The following illustration shows single phase metering in a 3-phase system.

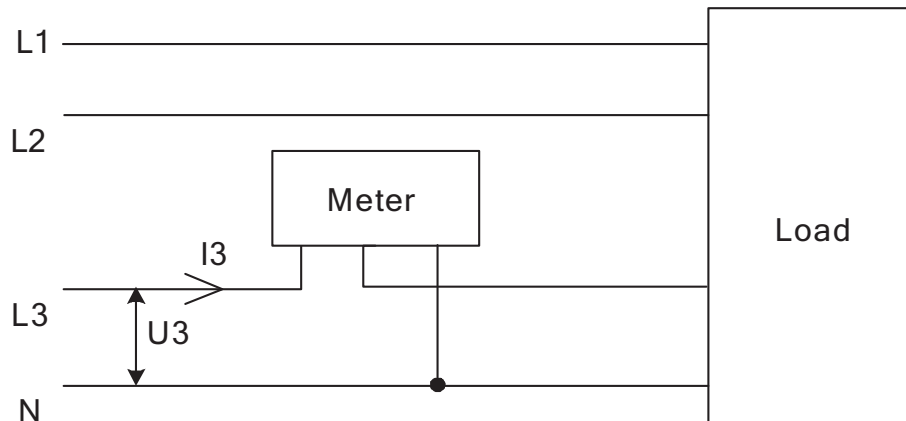

7.1.2 3-Phase, 2-Element Metering

2-element metering in a 3-wire system

The 2-element metering method is used in systems with 3 wires, normally a 3-phase system that does not have a neutral conductor. A 2-element meter can be used irrespectively of the load being balanced or not.

In a 2-element meter the L2 voltage is used as the voltage reference and the voltage difference between that voltage and the L1 and L3 voltage are measured and multiplied by its respective current. The active energy consumed by the load is the product of momentary voltages $U1-U2$ and $U3-U2$ and the currents $I1$ and $I2$ integrated over the desired measuring time period.

Illustration

The following diagram shows a 2-element meter measuring the active energy (E) consumed by a load.

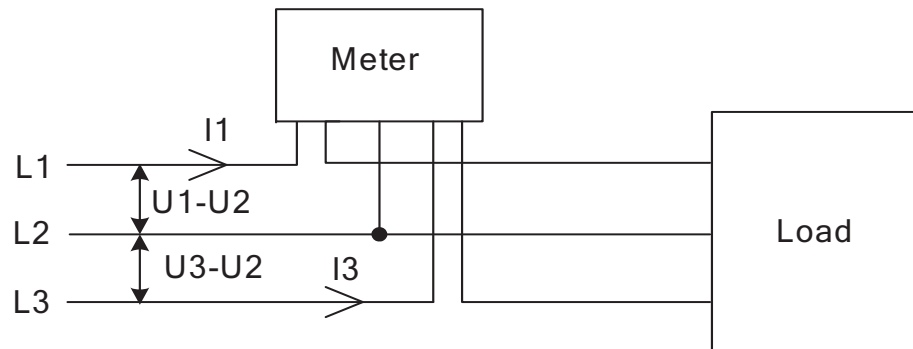

Calculating total active power

If no harmonics is present and the rms values of the voltages and currents are constant, the total active power can be expressed as:

$$P_{tot} = P1 + P3 = (U1-U2) \times I1 \times \cos \phi_{12} + (U3-U2) \times I3 \times \cos \phi_{32}$$

Illustration

The following vector diagram shows the vectors for the phase voltages ($U1$, $U2$, $U3$), the phase currents ($I1$, $I2$, $I3$) and the element voltages ($U1-U2$, $U3-U2$) for

a pure resistive load where the phase currents are in phase with its respective phase voltages.

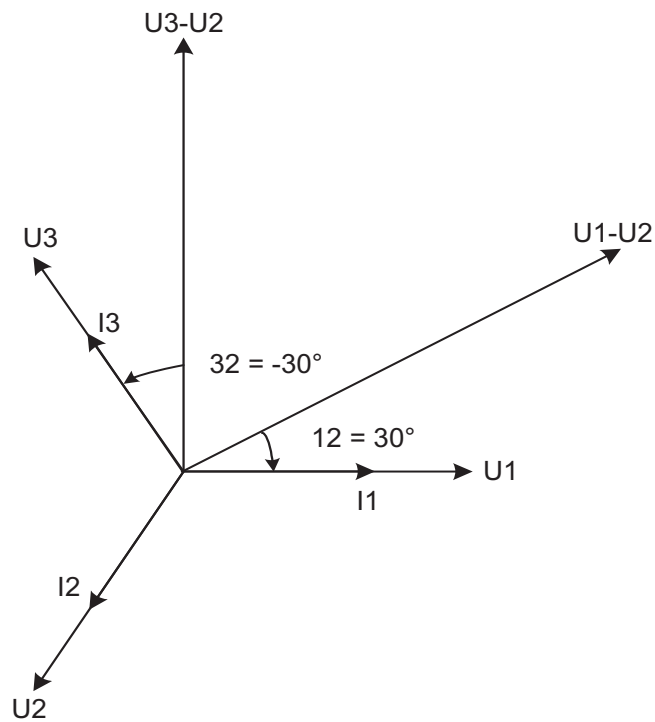

2-element metering in a 4-wire system

2-element metering can also be used in a 4-wire system if the current in the neutral connection is zero. Applying this method in a system having a non-zero neutral current will decrease the accuracy, but can sometimes be justified if the current is small compared to the line currents or if high accuracy is not required.

It is also possible to use this method for measuring one current only. This method will only give correct result in a balanced system. Note that the current flows backwards through phase 1 and 3 and that the phase voltages not are connected to the normal inputs when the current transformer is connected to phase 1 and 3.

Illustration

The following diagrams shows 2-element measurements with only 1 current transformer:

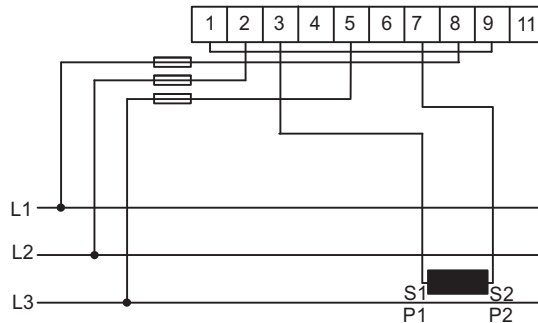
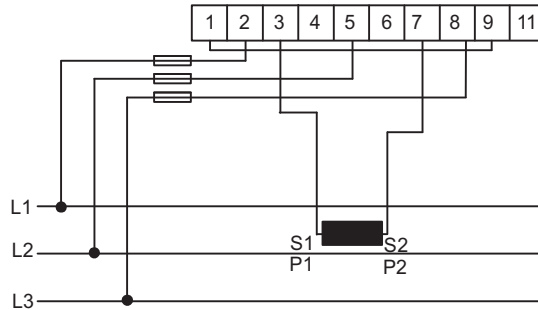
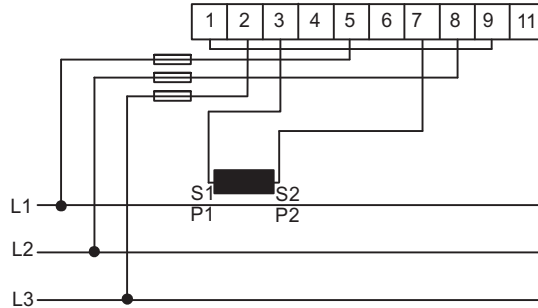

7.1.3 3-Phase, 3-Element Metering

3-element metering in a 4-wire system

This method is normally used in three phase systems that have a neutral conductor.

In a 3-element meter the neutral voltage is used as the voltage reference and the voltage difference between the neutral voltage and the L1, L2 and L3 voltages are measured and multiplied by its respective current. The active energy consumed

by the load is the product of momentary voltages U_1 , U_2 and U_3 and the currents I_1 , I_2 and I_3 integrated over the desired measuring time period.

Illustration

The following diagram shows a direct connected 3-element meter measuring the active energy (E) consumed by a load.

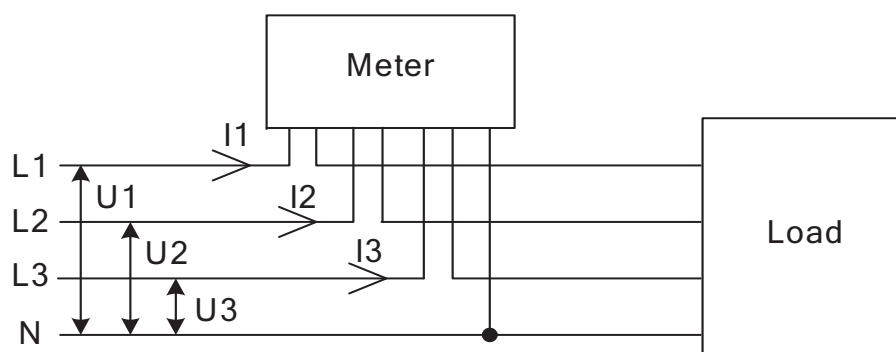

Calculating total active power

In the case where no harmonics are present and the rms values of the voltages and currents are constant, the total active power can be expressed as:

$$P_{\text{tot}} = P_1 + P_2 + P_3 = U_1 \times I_1 \times \cos \varphi_1 + (U_2 \times I_2 \times \cos \varphi_2 + U_3 \times I_3 \times \cos \varphi_3)$$

3-element metering with the neutral disconnected

Sometimes it is desired to use a 3-element meter without having the neutral connected. It can be done with both transformer connected and direct connected meters.

This can for example be desired in cases where a voltage transformer without a neutral is being used for the moment but where a change to a voltage transformer with neutral will be made sometime in the future. To save the trouble of changing the meter at that time a 3-element meter is used from the beginning.

Using a 3-element meter without having the neutral connected will decrease the accuracy due to the fact that the floating neutral connection on the meter (terminal 11) will lie at a different level than the true neutral (N) because of impedance imbalance inside the meter, resulting in the phase voltages not being correct. The imbalance error is usually however rather small (typically 0-2%) and if the currents are balanced the total error in the energy measurement will be very small, as a too small energy measurement on one element will be compensated by approximately opposite errors for the other phases.

Illustration

The following diagram shows a 3-element transformer connected meter with the neutral disconnected:

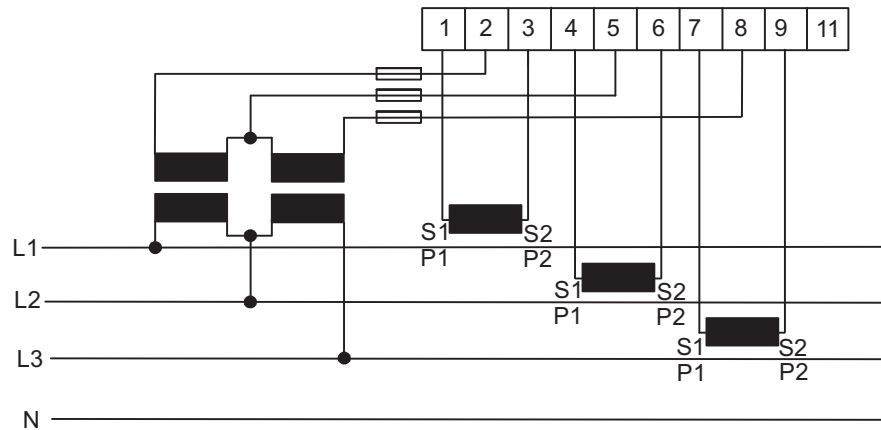

3-element metering with 2 transformers

It is also possible to use a 3-element meter with only 2 current transformers. This type connection is possible both with and without the neutral available or the neutral left floating.

Note that if the current transformers are connected to protective earth it must be connected in only one point. Both methods require a balanced system (voltages and currents the same in all 3 phases). It shall also be mentioned that having a floating neutral also can give additional errors in the measured voltages due to impedance nonlinearity and imbalance inside the meter.

Illustration

The following diagram shows a 3-element transformer connected meter with 2 current transformers:

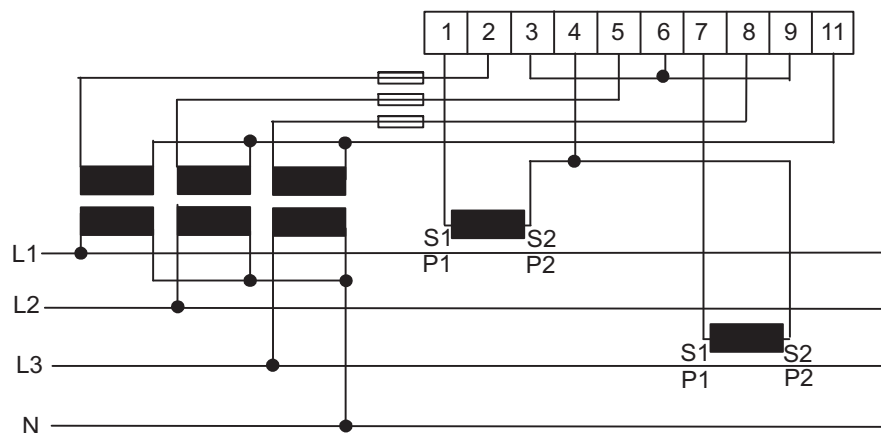

Illustration

The following diagram shows a 3-element transformer connected meter with 2 current transformers and a floating neutral:

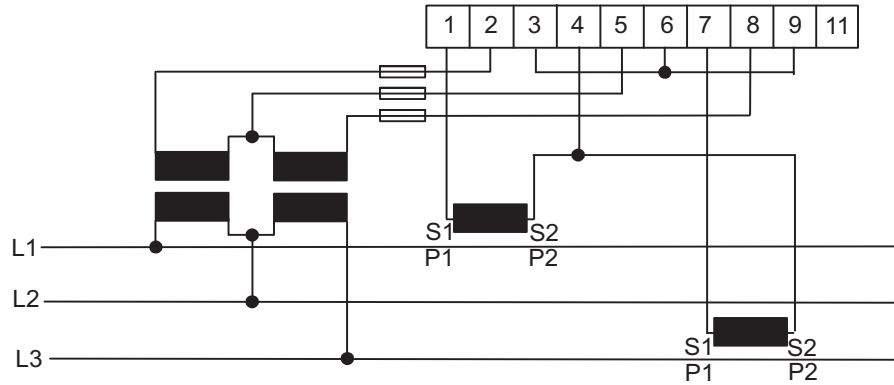

Summation metering

The currents from several different transformers can be summed into one single meter.



Note – The summation metering method could also be used with a single phase meter or a 2-element meter

Illustration

The following illustration shows summation metering with a 3-element transformer connected meter:

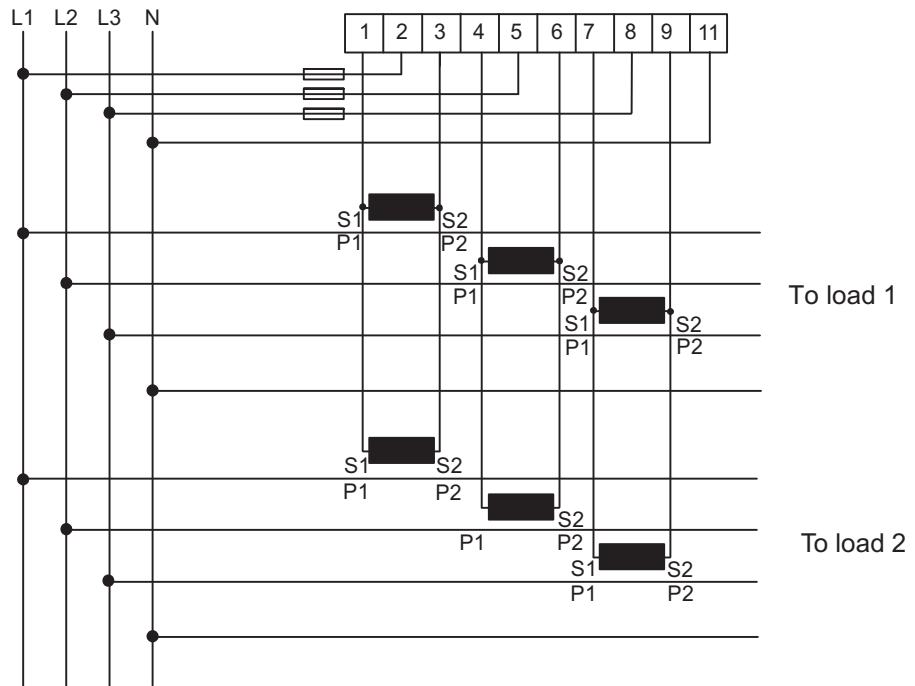

Chapter 8: Service & Maintenance

Overview This chapter contains information about service and manitenance of the product.

In this chapter The following topics are covered in this chapter:

8.1 Service and Maintenance 92

8.1 Service and Maintenance

Service

This product contains no parts that can be repaired or exchanged. A broken meter must be replaced.

Cleaning

If the meter needs to be cleaned, use a lightly moistened cloth with a mild detergent to wipe it.



Caution – Be careful that no liquid gets into the meter since it can ruin the equipment.

Chapter 9: Communication with Modbus

Overview

This chapter describes the mapping from meter data to Modbus and how to read and write to registers.

In this chapter

The following topics are covered in this chapter:

9.1 About the Modbus Protocol	94
9.2 Reading and Writing to Registers	99
9.3 Mapping Tables	100
9.4 Historical Data	111
9.5 Previous Values	119
9.6 Demand	123
9.7 Event logs	127
9.8 Load profile	131
9.9 Configuration	134

9.1 About the Modbus Protocol

General

Modbus is a master-slave communication protocol that can support up to 247 slaves organized as a multidrop bus. The communication is half duplex. Services on Modbus are specified by function codes.

The function codes are used to read or write 16 bit registers. All metering data, such as active energy, voltage or firmware version, is represented by one or more such registers. For further information about the relation between register number and metering data, refer to “Mapping Tables” on page - 98.

The Modbus protocol is specified in its entirety in Modbus Application Protocol Specification V1.1b. The document is available at <http://www.modbus.org>

Supported function codes

The following function codes are supported:

- Function code 3 (Read holding registers)
- Function code 6 (Write single register)
- Function code 16 (Write multiple registers)

Modbus request frame

A Modbus request frame generally has the following structure:

Slave Address	Function Code	Data	Error Check
---------------	---------------	------	-------------

Slave address	Modbus slave address, 1 byte.
Function code	Decides the service to be performed.
Data	Dependent on the function code. The length varies.
Error check	CRC, 2 bytes

Message types

The network messages can be query-response or broadcast type. The query-response command sends a query from the master to an individual slave and is generally followed by a response.

The broadcast command sends a message to all slaves and is never followed by a response. Broadcast is supported by function code 6 and 16.

9.1.1 Function Code 3 (Read holding registers)

General

Function code 3 is used to read measurement values or other information from the electricity meter. It is possible to read up to 125 consecutive registers at a time. This means that multiple values can be read in one request.

Request frame

A request frame has the following structure:

Slave Address	Function Code	Address	No. of Registers	Error Check
---------------	---------------	---------	------------------	-------------

Example of a request

The following is an example of a request. (read total energy import, etc...)

Slave address	0x01
Function code	0x03
Start address, high byte	0x50
Start address, low byte	0x00
No. of registers, high byte	0x00
No. of registers, low byte	0x18
Error check (CRC), high byte	0x54
Error check (CRC), low byte	0xC0

Response frame

A response frame has the following structure:

Slave Address	Function Code	Byte Count	Register Values	Error Check
---------------	---------------	------------	-----------------	-------------

Example of a response

The following is an example of a response:

Slave address	0x01
Function code	0x03
Byte count	0x30
Value of register 0x5000, high byte	0x00
Value of register 0x5000, low byte	0x15
...	
Value of register 0x5017, high byte	0xFF
Value of register 0x5017, low byte	0xFF
Error check (CRC), high byte	0xFF
Error check (CRC), low byte	0xFF

In this example, the slave with the Modbus address 1 responds to a read request. The number of data bytes is 0x30. The first register (0x5000) has the value 0x0015 and the last (0x5017) has the value 0xFFFF

9.1.2 Function Code 16 (Write multiple registers)

General

Function code 16 is used to modify settings in the meter, such as date/time, to control output and to reset values, such as power fail counter. It is possible to write up to 123 consecutive registers in a single request. This means that several settings can be modified and/or several reset operations can be performed in a single request.

Request frame

A request frame has the following structure:

Slave Address	Function Code	Start Address	No. of Registers	Byte Count	Register Values	Error Check
---------------	---------------	---------------	------------------	------------	-----------------	-------------

Example of a request

The following is an example of a request (set Date/Time to November 11, 2010, 12:13:14):

Slave address	0x01
Function code	0x10
Start address, high byte	0x8A
Start address, low byte	0x00
No. of registers, high byte	0x00
No. of registers, low byte	0x03
Byte count	0x06
Value of register 0x8A00, high byte	0x0A
Value of register 0x8A00, low byte	0x0B
Value of register 0x8A01, high byte	0x0B
Value of register 0x8A01, low byte	0x0C
Value of register 0x8A02, high byte	0x0D
Value of register 0x8A02, low byte	0x0E
Error check (CRC), high byte	0x8C
Error check (CRC), low byte	0x82

In this example the master sends a write request to the slave that has the Modbus address 1. The first register to write is 0x8A00 and the number of registers to write is 0x03. This means that the registers 0x8A00 to 0x8A02 are written. Register 0x8A00 is set to the value 0x0A0B, and so on.

Response frame

A response frame has the following structure:

Slave Address	Function Code	Start Address	No. of Registers	Error Check
---------------	---------------	---------------	------------------	-------------

Example of a response

The following is an example of a response:

Slave address	0x01
Function code	0x10
Register address, high byte	0x8A
Register address, low byte	0x00
No. of registers, high byte	0x00
No. of registers, low byte	0x03
Error check (CRC), high byte	0xAA
Error check (CRC), low byte	0x10

In the example above the slave with the Modbus address 1 responds to a write request. The first register is 0x8A00 and 0x03 registers have been successfully written to.

9.1.3 Function Code 6 (Write single register)

General

Function code 6 can be used as an alternative to function code 16 if there is only one register to be written. It can, for example be used to reset the power fail counter.

Request frame

A request frame has the following structure:

Slave Address	Function Code	Register Address	Register Value	Error Check
---------------	---------------	------------------	----------------	-------------

Example of a request

The following is an example of a request (reset power fail counter):

Slave address	0x01
Function code	0x06
Register address, high byte	0x8F
Register address, low byte	0x00
No. of registers, high byte	0x00
No. of registers, low byte	0x01

Error check (CRC), high byte	0x62
Error check (CRC), low byte	0xDE

Response frame Using function code 6, the response frame is an echo of the request frame.

9.1.3.1 Exception Responses

General If an error should occur while processing a request, the meter gives an exception response that contains an exception code.

Exception frame An exception frame has the following structure:

Slave Address	Function Code	Exception Code	Error Check
---------------	---------------	----------------	-------------

In the exception response the function code is set to the function code of the request plus 0x80.

Exception codes The exception codes that are used are listed in the following table:

Exception code	Exception	Definition
01	Illegal function	A function code that is not supported has been used.
02	Illegal data address	The requested register is outside the allowed range.
03	Illegal data value	The structure of a received message is incorrect.
04	Slave device failure	Processing the request fail due to an internal error in the meter.

9.2 Reading and Writing to Registers

Readable registers

The readable range in the modbus mapping are registers 1000-8EFF (hexadecimal). Reading any registers within this range will result in a normal Modbus response. It is possible to read any number of registers between 1 and 125, i.e., it is not necessary to read all registers of a quantity listed on one line in the mapping tables. Any attempt to read outside this range will result in an illegal data address exception (Modbus exception code 2).

Multi-register values

For quantities that are represented as more than 1 register, the most significant byte is found in the high byte of the first (lowest) register. The least significant byte is found in the low byte of the last (highest) register.

Unused registers

Unused registers within the mapping range, for example missing quantities in the connected meter, will result in a normal Modbus response but the value of the register will be set to “invalid”.

For quantities with data type “unsigned”, the value will be FFFF in all registers. For quantities with data type “signed”, the value is the highest value possible to express. That means that a quantity that is represented by only one register will have the value 7FFF. A quantity that is represented by 2 registers will have the value 7FFFFFFF, and so on.

Writing to registers

Writing to registers is only permitted to the registers listed as writable in the mapping tables. Attempting to write to a register that is listed as writable but that is not supported by the meter will not result in an error indication.



Note – It is not possible to modify parts of a setting, e.g. to set only the year and month of the Date/time setting.

Confirm set values

After you set a value in the meter, it is recommended that you read the value to confirm the result, since it is not possible to confirm if a write was successful from the Modbus response.

9.3 Mapping Tables

Introduction

The purpose of this section is to explain the relation between register number and metering data.

Contents of the mapping tables

The following table explains the content of the mapping tables:

Quantity	Name of the meter quantity or other information available in the meter.
Details	Refinement of the Quantity column.
Start Reg (Hex)	Hexadecimal number for the first (lowest) Modbus Register for this quantity. *
Size	Number of Modbus registers for the meter Quantity. A Modbus Register is 16 bits long.
Res.	Resolution of the value for this Quantity (if applicable).
Unit	Unit for the Quantity (if applicable).
Data type	Data type for this Quantity, i.e. how the value in the Modbus registers should be interpreted.

*It is expressed exactly as it is sent on the bus. That is, it should not be subtracted by 40 000 or decremented by 1, as is common for Modbus products.

Total energy accumulators

All registers in the following table are read only:

Quantity	Details	Start reg (Hex)	Size	Res.	Unit	Data type
Active import	kWh	5000	4	0,01	kWh	Unsigned
Active export	kWh	5004	4	0,01	kWh	Unsigned
Active net	kWh	5008	4	0,01	kWh	Unsigned
Reactive import	kvarh	500C	4	0,01	kvarh	Unsigned
Reactive export	kvarh	5010	4	0,01	kvarh	Unsigned
Reactive net	kvarh	5014	4	0,01	kvarh	Unsigned
Apparent import	kVAh	5018	4	0,01	kVAh	Unsigned
Apparent export	kVAh	501C	4	0,01	kVAh	Unsigned
Apparent net	kVAh	5020	4	0,01	kVAh	Unsigned
Active import CO2	kVAh	5024	4	0,001	kg	Unsigned
Active import Currency	kVAh	5034	4	0,001	currency	Unsigned

Energy accumulators divided into tariffs

All registers in the following table are read only:

Quantity	Details	Start reg (Hex)	Size	Res.	Unit	Data type
Active import	Tariff 1	5170	4	0,01	kWh	Unsigned
Active import	Tariff 2	5174	4	0,01	kWh	Unsigned
Active import	Tariff 3	5178	4	0,01	kWh	Unsigned
Active import	Tariff 4	517C	4	0,01	kWh	Unsigned
Active export	Tariff 1	5190	4	0,01	kWh	Unsigned
Active export	Tariff 2	5194	4	0,01	kWh	Unsigned
Active export	Tariff 3	5198	4	0,01	kWh	Unsigned
Active export	Tariff 4	519C	4	0,01	kWh	Unsigned
Reactive import	Tariff 1	51B0	4	0,01	kvarh	Unsigned
Reactive import	Tariff 2	51B4	4	0,01	kvarh	Unsigned
Reactive import	Tariff 3	51B8	4	0,01	kvarh	Unsigned
Reactive import	Tariff 4	51BC	4	0,01	kvarh	Unsigned
Reactive export	Tariff 1	51D0	4	0,01	kvarh	Unsigned
Reactive export	Tariff 2	51D4	4	0,01	kvarh	Unsigned
Reactive export	Tariff 3	51D8	4	0,01	kvarh	Unsigned
Reactive export	Tariff 4	51DC	4	0,01	kvarh	Unsigned

Energy accumulators per phase

All registers in the following table are read only:

Quantity	Details	Start reg (Hex)	Size	Res.	Unit	Data type
Active import	L1	5460	4	0,01	kWh	Unsigned
Active import	L2	5464	4	0,01	kWh	Unsigned
Active import	L3	5468	4	0,01	kWh	Unsigned
Active export	L1	546C	4	0,01	kWh	Unsigned
Active export	L2	5470	4	0,01	kWh	Unsigned
Active export	L3	5474	4	0,01	kWh	Unsigned
Active net	L1	5478	4	0,01	kWh	Unsigned
Active net	L2	547C	4	0,01	kWh	Unsigned
Active net	L3	5480	4	0,01	kWh	Unsigned

Quantity	Details	Start reg (Hex)	Size	Res.	Unit	Data type
Reactive import	L1	5484	4	0,01	kvarh	Unsigned
Reactive import	L2	5488	4	0,01	kvarh	Unsigned
Reactive import	L3	548C	4	0,01	kvarh	Unsigned
Reactive export	L1	5490	4	0,01	kvarh	Unsigned
Reactive export	L2	5494	4	0,01	kvarh	Unsigned
Reactive export	L3	5498	4	0,01	kvarh	Unsigned
Reactive net	L1	549C	4	0,01	kvarh	Unsigned
Reactive net	L2	54A0	4	0,01	kvarh	Unsigned
Reactive net	L3	54A4	4	0,01	kvarh	Unsigned
Apparent import	L1	54A8	4	0,01	kVAh	Unsigned
Apparent import	L2	54AC	4	0,01	kVAh	Unsigned
Apparent import	L3	54B0	4	0,01	kVAh	Unsigned
Apparent export	L1	54B4	4	0,01	kVAh	Unsigned
Apparent export	L2	54B8	4	0,01	kVAh	Unsigned
Apparent export	L3	54BC	4	0,01	kVAh	Unsigned
Apparent net	L1	54C0	4	0,01	kVAh	Unsigned
Apparent net	L2	54C4	4	0,01	kVAh	Unsigned
Apparent net	L3	54C8	4	0,01	kVAh	Unsigned

Resettable energy accumulators

All registers in the following table are read only:

Quantity	Start reg (Hex)	Size	Res.	Unit	Data type
Resettable active import	552C	4	0,01	kWh	Unsigned
Resettable active export	5530	4	0,01	kWh	Unsigned
Resettable reactive import	5534	4	0,01	kWh	Unsigned
Resettable reactive export	5538	4	0,01	kWh	Unsigned

Instantaneous values

All registers in the following table are read only:

Quantity	Details	Start reg (Hex)	Size	Res.	Unit	Value range	Data type
Voltage	L1-N	5B00	2	0,1	V		Unsigned
Voltage	L2-N	5B02	2	0,1	V		Unsigned
Voltage	L3-N	5B04	2	0,1	V		Unsigned
Voltage	L1-L2	5B06	2	0,1	V		Unsigned
Voltage	L3-L2	5B08	2	0,1	V		Unsigned
Voltage	L1-L3	5B0A	2	0,1	V		Unsigned
Current	L1	5B0C	2	0,01	A		Unsigned
Current	L2	5B0E	2	0,01	A		Unsigned
Current	L3	5B10	2	0,01	A		Unsigned
Current	N	5B12	2	0,01	A		Unsigned
Active power	Total	5B14	2	0,01	W		Signed
Active power	L1	5B16	2	0,01	W		Signed
Active power	L2	5B18	2	0,01	W		Signed
Active power	L3	5B1A	2	0,01	W		Signed
Reactive power	Total	5B1C	2	0,01	var		Signed
Reactive power	L1	5B1E	2	0,01	var		Signed
Reactive power	L2	5B20	2	0,01	var		Signed
Reactive power	L3	5B22	2	0,01	var		Signed
Apparent power	Total	5B24	2	0,01	VA		Signed
Apparent power	L1	5B26	2	0,01	VA		Signed
Apparent power	L2	5B28	2	0,01	VA		Signed
Apparent power	L3	5B2A	2	0,01	VA		Signed
Frequency		5B2C	1	0,01	Hz		Unsigned
Phase angle power	Total	5B2D	1	0,1	°	-180°-+180°	Signed
Phase angle power	L1	5B2E	1	0,1	°	-180°-+180°	Signed
Phase angle power	L2	5B2F	1	0,1	°	-180°-+180°	Signed
Phase angle power	L3	5B30	1	0,1	°	-180°-+180°	Signed
Phase angle voltage	L1	5B31	1	0,1	°	-180°-+180°	Signed
Phase angle voltage	L2	5B32	1	0,1	°	-180°-+180°	Signed
Phase angle voltage	L3	5B33	1	0,1	°	-180°-+180°	Signed
Phase angle current	L1	5B37	1	0,1	°	-180°-+180°	Signed
Phase angle current	L2	5B38	1	0,1	°	-180°-+180°	Signed
Phase angle current	L3	5B39	1	0,1	°	-180°-+180°	Signed
Power factor	Total	5B3A	1	0,001	-	-1,000-+1,000	Signed
Power factor	L1	5B3B	1	0,001	-	-1,000-+1,000	Signed
Power factor	L2	5B3C	1	0,001	-	-1,000-+1,000	Signed

Quantity	Details	Start reg (Hex)	Size	Res.	Unit	Value range	Data type
Power factor	L3	5B3D	1	0,001	-	-1,000-+1,000	Signed
Current quadrant	Total	5B3E	1		-	1-4	Unsigned
Current quadrant	L1	5B3F	1		-	1-4	Unsigned
Current quadrant	L2	5B40	1		-	1-4	Unsigned
Current quadrant	L3	5B41	1		-	1-4	Unsigned



Note – Powers are sent out as 32 bit signed integers, expressed in W (or var/VA) with 2 decimals. This means that the maximum power possible to express is approximately ± 21 MW. If the power is higher than that the user is advised to read power from the DMTME mapping instead, where the scaling is in W without decimals.

Harmonics

Harmonics are mapped in 2 registers each, starting with THD and then followed by 2nd, 3rd, 4th harmonic and so on.

All registers in the following table are read only:

Quantity	Details	Start reg (Hex)	Size/ harmonic	Nr of harmonics	Res.	Unit	Data type
Voltage harmonics	L1-N	5D00	2	16	0,1	%	Unsigned
Voltage harmonics	L2-N	5D80	2	16	0,1	%	Unsigned
Voltage harmonics	L3-N	5E00	2	16	0,1	%	Unsigned
Voltage harmonics	L1-L2	5E80	2	16	0,1	%	Unsigned
Voltage harmonics	L3-L2	5F00	2	16	0,1	%	Unsigned
Voltage harmonics	L1-L3	5F80	2	16	0,1	%	Unsigned
Current harmonics	L1	6000	2	16	0,1	%	Unsigned
Current harmonics	L2	6080	2	16	0,1	%	Unsigned
Current harmonics	L3	6100	2	16	0,1	%	Unsigned
Current harmonics	N	6180	2	16	0,1	%	Unsigned

Inputs and outputs

The following table contains both writable and read only registers:

Quantity	Details	Start Reg (Hex)	Size	Possible values	Data type	Read/ Write
Output 1		6300	1	ON=1, OFF=0	Unsigned	R/W

Quantity	Details	Start Reg (Hex)	Size	Possible values	Data type	Read/Write
Output 2		6301	1	ON=1, OFF=0	Unsigned	R/W
Output 3		6302	1	ON=1, OFF=0	Unsigned	R/W
Output 4		6303	1	ON=1, OFF=0	Unsigned	R/W
Input 1	Current state	6308	1	ON=1, OFF=0	Unsigned	R
Input 2	Current state	6309	1	ON=1, OFF=0	Unsigned	R
Input 3	Current state	630A	1	ON=1, OFF=0	Unsigned	R
Input 4	Current state	630B	1	ON=1, OFF=0	Unsigned	R
Input 1	Stored state	6310	1	ON=1, OFF=0	Unsigned	R
Input 2	Stored state	6311	1	ON=1, OFF=0	Unsigned	R
Input 3	Stored state	6312	1	ON=1, OFF=0	Unsigned	R
Input 4	Stored state	6313	1	ON=1, OFF=0	Unsigned	R
Input 1	Counter	6318	4		Unsigned	R
Input 2	Counter	631C	4		Unsigned	R
Input 3	Counter	6320	4		Unsigned	R
Input 4	Counter	6324	4		Unsigned	R

Production data and identification

All registers in the following table are read only:

Quantity	Start Reg (Hex)	Size	Data type
Serial number	8900	2	Unsigned
Meter firmware version	8908	8	ASCII string (up to 16 characters)
Modbus mapping version	8910	1	2 bytes
Type designation	8960	6	ASCII string (12 characters, including null termination)

Meter firmware version is expressed as a string of 3 digits separated by periods, e.g. 1.0.0. Unused bytes at the end are set to binary 0.

In the **Modbus mapping version** register the high byte corresponds to the Major version (1-255), and the low byte corresponds to the Minor version (0-255).

Miscellaneous

In the following table Date/time and current tariff are writable. All other registers are read only:

Quantity	Start Reg (Hex)	Description	Size	Data type	Read/Write
Date/time	8A00	Byte 0: year* Byte 1: month Byte 2: day Byte 3: hour Byte 4: minute Byte 5: second	3	Date/Time	R/W
Day of week	8A03	Weekdays (1-7, Mo=1)	1	Unsigned	R
DST active	8A04	1=DST active 0=DST inactive	1	Unsigned	R
Day type	8A05	Value 0-3 correspond to day type 1-4	1	Unsigned	R
Season	8A06	Value 0-3 correspond to season 1-4	1	Unsigned	R
Current tariff	8A07	Tariff 1-4	1	Unsigned	R/W
Error flags	8A13	64 flags	4	Bit string	R
Information flags	8A19	64 flags	4	Bit string	R
Warning flags	8A1F	64 flags	4	Bit string	R
Alarm flags	8A25	64 flags	4	Bit string	R
Power fail counter	8A2F		1	Unsigned	R
Power outage time	8A39	Byte 0-2: days* Byte 3: hours Byte 4: minutes Byte 5: seconds	3	Date/Time	R
Reset counter for active energy import	8A48		4	Unsigned	R
Reset counter for active energy export	8A4C		4	Unsigned	R
Reset counter for reactive energy import	8A50		4	Unsigned	R
Reset counter for reactive energy export	8A54		4	Unsigned	R

* Byte 0 is the highest byte of the lowest register

The **Reset counter** registers show the number of times the resettable energy accumulators have been reset.

Settings

All registers in the following table have read and write access:

Quantity	Start Reg (hex)	Size	Res.	Unit	Data type
Current transformer ratio numerator	8C04	2		-	Unsigned
Voltage transformer ratio numerator	8C06	2		-	Unsigned
Current transformer ratio denominator	8C08	2		-	Unsigned
Voltage transformer ratio denominator	8C0A	2		-	Unsigned
CO2 conversion factor	8CE0	2	0.001	kg/kWh	Unsigned
Currency conversion factor	8CE2	2	0.01	Currency/kWh	Unsigned
LED source (0 = active energy, 1 = reactive energy)	8CE4	1		-	Unsigned
Number of elements (values 1-3)	8CE5	1		-	Unsigned

Operations

All registers in the following table are write only:

Quantity	Details	Start Reg (hex)	Size	Action	Data type
Reset power fail counter		8F00	1	Write the value 1 to perform a reset	Unsigned
Reset power outage time		8F05	1	Write the value 1 to perform a reset	Unsigned
Reset input counter	Input 1	8F0B	1	Write the value 1 to perform a reset	Unsigned
Reset input counter	Input 2	8F0C	1	Write the value 1 to perform a reset	Unsigned
Reset input counter	Input 3	8F0D	1	Write the value 1 to perform a reset	Unsigned
Reset input counter	Input 4	8F0E	1	Write the value 1 to perform a reset	Unsigned

Quantity	Details	Start Reg (hex)	Size	Action	Data type
Reset stored state	input 1	8F13	1	Write the value 1 to perform a reset	Unsigned
Reset stored state	Input 2	8F14	1	Write the value 1 to perform a reset	Unsigned
Reset stored state	input 3	8F15	1	Write the value 1 to perform a reset	Unsigned
Reset stored state	Input 4	8F16	1	Write the value 1 to perform a reset	Unsigned
Reset resettable active energy import		8F1B	1	Write the value 1 to perform a reset	Unsigned
Reset resettable active energy export		8F1C	1	Write the value 1 to perform a reset	Unsigned
Reset resettable reactive energy import		8F1D	1	Write the value 1 to perform a reset	Unsigned
Reset resettable reactive energy export		8F1E	1	Write the value 1 to perform a reset	Unsigned
Reset Previous values		8F1F	1	Write the value 1 to perform a reset	Unsigned
Reset Demand		8F20	1	Write the value 1 to perform a reset	Unsigned
Reset Load profile channel 1		8F21	1	Write the value 1 to perform a reset	Unsigned
Reset Load profile channel 2		8F22	1	Write the value 1 to perform a reset	Unsigned
Reset Load profile channel 3		8F23	1	Write the value 1 to perform a reset	Unsigned
Reset Load profile channel 4		8F24	1	Write the value 1 to perform a reset	Unsigned
Reset Load profile channel 5		8F25	1	Write the value 1 to perform a reset	Unsigned
Reset Load profile channel 6		8F26	1	Write the value 1 to perform a reset	Unsigned
Reset Load profile channel 7		8F27	1	Write the value 1 to perform a reset	Unsigned
Reset Load profile channel 8		8F28	1	Write the value 1 to perform a reset	Unsigned
Reset System log		8F31	1	Write the value 1 to perform a reset	Unsigned

Quantity	Details	Start Reg (hex)	Size	Action	Data type
Reset Event log		8F32	1	Write the value 1 to perform a reset	Unsigned
Reset Net quality log		8F33	1	Write the value 1 to perform a reset	Unsigned
Reset Communication log		8F34	1	Write the value 1 to perform a reset	Unsigned
Freeze demand		8F70	1	Write the value 1 to freeze the demand values	Unsigned

DMTME multimeters

Parts of the Modbus mapping is compatible with the ABB DMTME multimeters. All registers in the following table are read only:

Quantity	Start Reg (Hex)	Size	Unit	Data type
Phase Voltage L1-N	1002	2	Volt	Unsigned
Phase Voltage L2-N	1004	2	Volt	Unsigned
Phase Voltage L3-N	1006	2	Volt	Unsigned
Line Voltage L1-L2	1008	2	Volt	Unsigned
Line Voltage L2-L3	100A	2	Volt	Unsigned
Line Voltage L1-L3	100C	2	Volt	Unsigned
Line Current L1	1010	2	mA	Unsigned
Line Current L2	1012	2	mA	Unsigned
Line Current L3	1014	2	mA	Unsigned
3-Phase Sys. Power Factor	1016	2	*1000	Signed
Power Factor L1	1018	2	*1000	Signed
Power Factor L2	101A	2	*1000	Signed
power Factor L3	101C	2	*1000	Signed
3-Phase Sys. Apparent Power	1026	2	VA	Unsigned
Apparent Power L1	1028	2	VA	Unsigned
Apparent Power L2	102A	2	VA	Unsigned
Apparent Power L3	102C	2	VA	Unsigned
3-Phase Sys. Active Power	102E	2	Watt	Unsigned
Active Power L1	1030	2	Watt	Unsigned

Quantity	Start Reg (Hex)	Size	Unit	Data type
Active Power L2	1032	2	Watt	Unsigned
Active Power L3	1034	2	Watt	Unsigned
3-Phase Reactive power	1036	2	VAr	Unsigned
Reactive Power L1	1038	2	VAr	Unsigned
Reactive power L2	103A	2	VAr	Unsigned
Reactive Power L3	103C	2	VAr	Unsigned
3-Phase Sys. Active energy	103E	2	Wh*100	Unsigned
3-Phase Sys. Reactive energy	1040	2	VArh*100	Unsigned
Frequency	1046	2	mHz	Unsigned
Current transformer ratio	11A0	2	1-999999	Unsigned
Voltage transformer ratio	11A2	2	1-9999	Unsigned

9.4 Historical Data

General

In the Modbus mapping all historical data is organized as entries. This concerns Previous values, Demand, Load profile and Event logs.

Entry number 1 is the most recent entry, entry number 2 is the second most recent, and so on. Entry number 0 is not used.

Readout of all types of historical values is made by writing to a group of registers called Header and reading from one or more groups of registers called Data blocks.

The Header is used for controlling readout with respect to date/time or entry numbers, and for loading new entries into the Data blocks. The data blocks contain the actual data, for example event log entries or energy values.

When there are no more entries to read all registers in the Data blocks are set to 0xFFFF.

Header registers

There are a number of standard commands that are used in the same way when reading out any type of historical data. These are represented by registers in the Header, separately mapped for each functionality, but with the same names.

The following table describes the common header registers:

Function	Size	Description	Data type	Read/write
Get next entry	1	Write the value 1 to this register to load new values in the Data block(s)	Unsigned	R/W
Entry number	1	Write to this register to choose an entry number to start reading from	Unsigned	R/W
Date/Time	3	Write to this register to choose a date/time to start reading from	Date/Time (see below)	R/W
Direction	1	Write to this register to choose the direction of reading	Unsigned	R/W

Get next entry register

The Get next entry register is used to continue an ongoing readout, which was started by writing to any of the Entry number, Date/Time or Direction registers.

If the direction in Direction register is set to backward the Data block is loaded with older data. And correspondingly, if the direction is set to forward the Data block is loaded with more recent data.

Entry number register

The Entry number register is used to specify an entry number to start reading from. When a value is written to the Entry number register the Data block is loaded with values for that entry number.

Subsequent writes to Get next entry register will update the Entry number register (increment or decrement depending on direction in the Direction register), as well as loading new values to the Data block.

The default value of Entry number register after a restart is 0.

Date/Time register

The Date/Time register is used to specify a date and time to start reading from. When a value is written to the Date/Time register the Data block is loaded with values for that date and time. The Entry number register is also automatically updated, to reflect which entry number the values for this date and time has.

If there is no entry for the date and time chosen, and the reading direction is set to backward, the nearest older entry will be loaded into the Data block. If the reading direction is instead forward, the nearest newer entry will be loaded.

Subsequent writes to Get next entry register will load new data into the Data block, in the order indicated by the Direction register. The Entry number register will also be automatically updated (incremented or decremented depending on the direction in the Direction register).

Direction register

The Direction register is used to control the direction in time in which the entries are read. Possible values are shown in the table below:

Value	Description
0	Backwards, i.e. from recent entries towards older entries
1	Forward, i.e. from old entries towards recent entries

The default value of Entry number register after a restart is 0, i.e. backwards.

Data block registers

There are a number of standard data items that are used in the same way when reading out any type of historical data. These are represented by registers in the Data block, separately mapped for each functionality, but with the same names.

The following table describes the common Data block registers:

Function	Size	Description	Data type	Read /write
Timestamp	3	The date and time on which the value was stored	Date/Time	R/W
Quantity	3	OBIS code for the quantity concerned	6 byte sequence	R/W

Function	Size	Description	Data type	Read /write
Data type	1	Data type for the value of the quantity concerned	Unsigned	R/W
Scaler	1	Scaling of the value for the quantity concerned	Signed	R/W

Timestamp The date and time on which the value was stored. How to interpret the data in these registers is described in. “Date and time format” on page - 112

Quantity registers The OBIS code for a quantity in for example a load profile channel or previous values channel. A list of OBIS codes is found in “Quantity identifiers” on page - 112.

The table below shows an example of how an OBIS code is mapped to the Quantity registers. The OBIS code used is for active energy import total: 1.0.1.8.0.255.

Byte number	Comment on byte order	Value (in case of active energy import total)
0	Most significant byte of lowest register	1
1	Least significant byte of lowest register	0
2	...	1
3	...	8
4	...	0
5	Least significant byte of highest register	255

Data type register The data type register contains a data type identifier that is a value between 0 and 255. Currently only two identifiers are used for historical values. The identifier for 64 bit **unsigned** integer is 21 and the identifier for 64 bit **signed** integer is 20.

Scaler register The scaler register shows the resolution of the value. The measured value in the Value register should be interpreted as $\text{value} \cdot 10^{\text{scaler}}$. For example, the prefix kilo is represented by scaler 3 while milli is -3. An energy accumulator with the resolution 0,01 kWh consequently has scaler 1.

Date and time format

The same date and time format is used wherever a date and time occurs in the registers, e.g. the Date/Time register in the Header or a timestamp in the Data block. The following table shows the structure of date and time in the mapping:

Byte number	Description	Comment on byte order
0	Year	Most significant byte of lowest register
1	Month	Least significant byte of lowest register
2	Day	...
3	Hour	...
4	Minute	...
5	Second	Least significant byte of highest register

Response times

The Headers for reading out historical values include one or more of the registers Entry number, Date/Time, Direction and Get next entry for controlling the read-out.

When writing to any of the registers Entry number, Date/Time or Direction a new search is started in the persistent storage, which can take a long time depending on how old the entry searched for is. The response from Modbus is given **after** the search is finished, i.e. when the requested entry has been found.

Recent entries are found fast, whereas finding the oldest can take seconds or even up to about a minute if there are many thousands of newer values. It is therefore preferable to start reading from a recent entry number or date/time and then go **backwards** in time.

Writing to the Get next entry register continues the ongoing search and consequently goes fast.

9.4.1 Quantity identifiers

The quantities stored in Previous values, Demand and Load profile are identified by OBIS codes. The OBIS code is a 6 byte identifier. The tables below list the OBIS codes for all quantities possible to configure.

Total energies

The following table lists the OBIS codes for total energies:

Quantity	OBIS code
Active energy import total	1.0.1.8.0.255
Active energy export total	1.0.2.8.0.255
Active energy net total	1.0.16.8.0.255
Reactive energy import total	1.0.3.8.0.255

Quantity	OBIS code
Reactive energy export total	1.0.4.8.0.255
Reactive energy net total	1.0.128.8.0.255
Apparent energy import total	1.0.9.8.0.255
Apparent energy export total	1.0.10.8.0.255
Apparent energy net total	1.0.137.8.0.255
Active energy import total CO2	1.0.1.8.200.255
Active energy import total Currency	1.0.1.8.220.255

Energies per tariff

The following table lists the OBIS codes for energies per tariff:

Quantity	OBIS code
Active energy import tariff 1	1.0.1.8.1.255
Active energy import tariff 2	1.0.1.8.2.255
Active energy import tariff 3	1.0.1.8.3.255
Active energy import tariff 4	1.0.1.8.4.255
Active energy export tariff 1	1.0.2.8.1.255
Active energy export tariff 2	1.0.2.8.2.255
Active energy export tariff 3	1.0.2.8.3.255
Active energy export tariff 4	1.0.2.8.4.255
Reactive energy import tariff 1	1.0.3.8.1.255
Reactive energy import tariff 2	1.0.3.8.2.255
Reactive energy import tariff 3	1.0.3.8.3.255
Reactive energy import tariff 4	1.0.3.8.4.255
Reactive energy export tariff 1	1.0.4.8.1.255
Reactive energy export tariff 2	1.0.4.8.2.255
Reactive energy export tariff 3	1.0.4.8.3.255
Reactive energy export tariff 4	1.0.4.8.4.255

Energies per phase

The following table lists the OBIS codes for energies per phase:

Quantity	OBIS code
Active energy import L1	1.0.21.8.0.255
Active energy import L2	1.0.41.8.0.255

Quantity	OBIS code
Active energy import L3	1.0.61.8.0.255
Active energy export L1	1.0.22.8.0.255
Active energy export L2	1.0.42.8.0.255
Active energy export L3	1.0.62.8.0.255
Active energy net L1	1.0.36.8.0.255
Active energy net L2	1.0.56.8.0.255
Active energy net L3	1.0.76.8.0.255
Reactive energy import L1	1.0.23.8.0.255
Reactive energy import L2	1.0.43.8.0.255
Reactive energy import L3	1.0.63.8.0.255
Reactive energy export L1	1.0.24.8.0.255
Reactive energy export L2	1.0.44.8.0.255
Reactive energy export L3	1.0.64.8.0.255
Reactive energy net L1	1.0.129.8.0.255
Reactive energy net L2	1.0.130.8.0.255
Reactive energy net L3	1.0.131.8.0.255
Apparent energy import L1	1.0.29.8.0.255
Apparent energy import L2	1.0.49.8.0.255
Apparent energy import L3	1.0.69.8.0.255
Apparent energy export L1	1.0.30.8.0.255
Apparent energy export L2	1.0.50.8.0.255
Apparent energy export L3	1.0.70.8.0.255
Apparent energy net L1	1.0.138.8.0.255
Apparent energy net L2	1.0.139.8.0.255
Apparent energy net L3	1.0.140.8.0.255

Pulse input counters

The following table lists the OBIS codes for pulse input counters:

Quantity	OBIS code
Input 1 counter	1.128.82.8.0.255
Input 2 counter	1.129.82.8.0.255
Input 3 counter	1.130.82.8.0.255
Input 4 counter	1.131.82.8.0.255

Averages of instrumentation values

Averages of instrumentation values are used in load profile recording.

The following table lists the OBIS codes for averaging of instrumentation values:

Quantity	OBIS code
Voltage L1	1.0.32.27.0.255
Voltage L2	1.0.52.27.0.255
Voltage L3	1.0.72.27.0.255
Voltage L1-L2	1.0.134.27.0.255
Voltage L2-L3	1.0.135.27.0.255
Voltage L1-L3	1.0.136.27.0.255
Current L1	1.0.31.27.0.255
Current L2	1.0.51.27.0.255
Current L3	1.0.71.27.0.255
Current N	1.0.91.27.0.255
Power factor total	1.0.13.27.0.255
Power factor L1	1.0.33.27.0.255
Power factor L2	1.0.53.27.0.255
Power factor L3	1.0.73.27.0.255

Min/Max of instrumentation values and powers

Minimum and maximum of instrumentation values and powers are used for the Demand function. In the table below the byte shown as X can have any of the values 3, 6, 13 or 16. The meaning of these values is described after the OBIS code table.

The following table lists the OBIS codes for minimum/maximum of instrumentation values and powers:

Quantity	OBIS code
Voltage L1	1.0.32.X.0.255
Voltage L2	1.0.52.X.0.255
Voltage L3	1.0.72.X.0.255
Voltage L1-L2	1.0.134.X.0.255
Voltage L2-L3	1.0.135.X.0.255
Voltage L1-L3	1.0.136.X.0.255

Quantity	OBIS code
Current L1	1.0.31.X.0.255
Current L2	1.0.51.X.0.255
Current L3	1.0.71.X.0.255
Current N	1.0.91.X.0.255
THD Voltage L1	1.0.32.X.124.254
THD Voltage L2	1.0.52.X.124.254
THD Voltage L3	1.0.72.X.124.254
THD Voltage L1-L2	1.0.134.X.124.254
THD Voltage L2-L3	1.0.135.X.124.254
THD Voltage L1-L3	1.0.136.X.124.254
THD Current L1	1.0.31.X.124.254
THD Current L2	1.0.51.X.124.254
THD Current L3	1.0.71.X.124.254
THD Current N	1.0.91.X.124.254
Powers	Same codes as energies, but with X set to 3, 6, 13 or 16

X-values

The following table lists the meaning of the values for X:

Value of X	Meaning
3	Minimum value of averages calculated over measurement period 1
6	Maximum value of averages calculated over measurement period 1
13	Minimum value of averages calculated over measurement period 2
16	Maximum value of averages calculated over measurement period 2



Note – Measurement period 1 is currently used for block demand and measurement period 2 is used for sliding demand.

9.5 Previous Values



Note – Before you can use the information in this chapter you must be familiar with and understand the information and the concepts described in “Historical Data” on page - 109.

Mapping table

The following table shows an overview of the mapping table:

Function	Details	Start Reg (Hex)	Size
Previous values	Header	8000	16
Previous values	Data block 1	8010	83
Previous values	Data block 2	8070	83
Previous values	Data block 3	80D0	83
Previous values	Data block 4	8130	83
Previous values	Data block 5	8190	83
Previous values	Data block 6	81F0	83
Previous values	Data block 7	8250	83

Header

The following table describes the header:

Function	Start Reg (Hex)	Size	Description	Read/write
Get next entry	8000	1	Write value 1 to this register to load the next block of values and timestamp	R/W
Entry number	8001	1	Write to this register to choose an entry number to start reading from	R/W
Date/Time	8004	3	Write to this register to choose a date/time to start reading from	R/W
Direction	8007	1	Write to this register to choose the direction of reading	R/W

Data blocks

The Data blocks contain the history of previous values. Data block 1 to 7 have the same structure. Each block can contain up to 8 channels. Consequently, in a meter with 50 previous values channels, there are 8 channels in each of block 1 to block 6 and 2 channels in block 7.

The registers of unused channels are filled with 0xFFFF.

Structure of the data blocks

The following table describes the structure of the data blocks:

Channel	Contents	Start Reg (Hex)	Size	Description
Common for all channels	Timestamp	8010	3	Date and time for the end of this period, i.e. when this entry was stored. (Date/Time format)
Channel 1	Quantity	8013	3	OBIS code for the quantity stored in channel 1.
Channel 1	Data type	8016	1	Data type for quantity stored in channel 1.
Channel 1	Scaler	8017	1	Scaler for quantity stored in channel 1.
Channel 1	Status	8018	1	Status for quantity stored in channel 1.
Channel 1	Value	8019	4	Value for quantity stored in channel 1.
...				
...				
Channel 8	Quantity	8059	3	OBIS code for the quantity stored in channel 8.
Channel 8	Data type	805C	1	Data type for quantity stored in channel 8.
Channel 8	Scaler	805D	1	Scaler for quantity stored in channel 8.
Channel 8	Status	805E	1	Status for quantity stored in channel 8.
Channel 8	Value	805F	4	Value for quantity stored in channel 8.

Status register

The status register shows the status for a value stored at a given timestamp. Possible values are shown in the table below:

Status	Description
0	OK
1	Not available
2	Data error

Example of data block 1

The following table shows the relation between stored values and channels in data block 1:

Entry	Timestamp	Channel 1		Channel 2..8
		Status	Value	
1	110601 00:00:00	0 (OK)	1000 kWh	...
2	110501 00:00:00	0 (OK)	800 kWh	...
3	110401 00:00:00	0 (OK)	450 kWh	...

9.5.1 Reading Previous Values

General

Readout of previous values is controlled by the Entry number register or Date/Time register.

After writing to any of those registers, the values of all channels for the given entry number or date/time are available in the registers of data block 1 to 7, together with status and timestamp information.

In the data blocks, the registers Quantity, Data type and Scaler provide further information about the data stored in each channel. To get the next block of previous values, write the value 1 to the Get next entry register, and then read again from the registers in the data blocks.

Read the most recent

Follow the steps in the table below to read the most recent previous values entry:

Step	Action
1	Write the value 1 to the entry number register.
2	Read the data blocks of interest.

Read the entire history

Follow the steps in the table below to read the entire history of previous values:

Step	Action
1	Write the value 0 to the Entry number register to make sure the reading starts from the most recent entry.
2	Write the value 1 to the Get next entry register.
3	Read the data blocks of interest.
4	Repeat steps 2 and 3 until there are no more entries stored. When all entries have been read, all registers in the data blocks are set to 0xFFFF.



Note – The entry number register is reset to 0 after a restart.

Read forward or backwards from a specified date/time

Follow the steps in the table below to read forward or backwards in time from a specified date/time:

Step	Action
1	Write a date and time to the Date/Time registers.
2	Write to the Direction register. Writing value 0 means backwards and value 1 means forward.
3	Read the data blocks of interest.
4	Write the value 1 to the Get next entry register.
5	Repeat steps 3 and 4 until there are no more entries stored. When all entries have been read, all registers in the data blocks are set to 0xFFFF.



Note – The Date/time registers are reset to 0xFFFF after a restart.

9.6 Demand



Note – Before you can use the information in this chapter you must be familiar with and understand the information and the concepts described in “Historical Data” on page - 109.

Mapping table

The following table shows an overview of the mapping table:

Function	Details	Start Reg (Hex)	Size
Demand	Header	8300	16
Demand	Data block 1	8310	115
Demand	Data block 2	8390	115
Demand	Data block 3	8410	115
Demand	Data block 4	8490	115
Demand	Data block 5	8510	115
Demand	Data block 6	8590	115
Demand	Data block 7	8610	115

Header

The following table describes the header:

Function	Start Reg (Hex)	Size	Description	Read/write
Get next entry	8300	1	Write value 1 to this register to load the next block of values and timestamp	R/W
Entry number	8301	1	Write to this register to choose an entry number to start reading from	R/W
Date/Time	8304	3	Write to this register to choose a date/time to start reading from	R/W
Direction	8307	1	Write to this register to choose the direction of reading	R/W

Data blocks

The Data blocks contain the history of demand. Data block 1 to 7 have the same structure. Each block can contain up to 8 channels. Consequently, in a meter with 50 demand channels, there are 8 channels in each of block 1 to block 6 and 2 channels in block 7.

The registers of unused channels are filled with 0xFFFF.

Structure of the data blocks

The following table describes the structure of the data blocks:

Channel	Contents	Start Reg (Hex)	Size	Description
Common for all channels	Timestamp	8310	3	Date and time for the end of this period, i.e. when this entry was stored. (Date/Time format)
Channel 1	Quantity	8313	3	OBIS code for the quantity monitored in channel 1.
Channel 1	Level	8316	1	Demand level for channel 1.
Channel 1	Data type	8317	1	Data type for quantity monitored in channel 1.
Channel 1	Scaler	8318	1	Scaler for quantity monitored in channel 1.
Channel 1	Capture time	8319	3	Date and time when the minimum or maximum occurred for the quantity monitored in channel 1.
Channel 1	Status	831C	1	Status for quantity monitored in channel 1.
Channel 1	Value	831D	4	Value for quantity monitored in channel 1.
...				
...				
Channel 8	Quantity	836C	3	OBIS code for the quantity monitored in channel 8.
Channel 8	Level	836F	1	Demand level for channel 8.
Channel 8	Data type	8370	1	Data type for quantity monitored in channel 8.
Channel 8	Scaler	837A	1	Scaler for quantity monitored in channel 8.
Channel 8	Capture time	837B	3	Date and time when the minimum or maximum occurred for the quantity monitored in channel 8.
Channel 8	Status	837E	1	Status for quantity monitored in channel 8.
Channel 8	Value	837F	4	Value for quantity monitored in channel 8.

Level register

The Level register shows which demand level is configured for this channel. Possible values are shown in the table below:

Value	Description
1	Highest/Lowest value during the demand period
2	Second highest/lowest value during the demand period

Value	Description
3	Third highest/lowest value during the demand period

Capture time register

The Capture time register shows the date and time when the minimum or maximum value for this entry occurred.

Status register

The status register shows the status for a value stored at a given timestamp. Possible values are shown in the table below:

Status	Description
0	OK
1	Not available
2	Data error

Example of data block 1

The following table shows the relation between stored values and channels in data block 1:

Entry	Timestamp	Channel 1			Channel 2..8
		Capture time	Status	Value	
1	110601 00:00:00	110515 01:05:00	0 (OK)	200 W	...
2	110501 00:00:00	110410 02:10:00	2 (Data error)	10000 W	...
3	110401 00:00:00	110305 03:15:00	0 (OK)	250 W	...

9.6.1 Reading Demand

General

Readout of demand is controlled by the Entry number register or Date/Time register.

After writing to any of those registers, the values of all channels for the given entry number or date/time are available in the registers of data block 1 to 7, together with status and timestamp information.

In the data blocks, the registers Quantity, Level, Data type and Scaler provide further information about the data stored in each channel. To get the next block of demand values, write the value 1 to the Get next entry register, and then read again from the registers in the data blocks.

Read the most recent

Follow the steps in the table below to read the most recent demand entry:

Step	Action
1	Write the value 1 to the entry number register.
2	Read the data blocks of interest.

Read the entire history

Follow the steps in the table below to read the entire history of previous values:

Step	Action
1	Write the value 0 to the Entry number register to make sure the reading starts from the most recent entry.
2	Write the value 1 to the Get next entry register.
3	Read the data blocks of interest.
4	Repeat steps 3 and 4 until there are no more entries stored. When all entries have been read, all registers in the data blocks are set to 0xFFFF.



Note – The entry number register is reset to 0 after a restart.

Read forward or backwards from a specified date/time

Follow the steps in the table below to read forward or backwards in time from a specified date/time:

Step	Action
1	Write a date and time to the Date/Time registers.
2	Write to the Direction register. Writing value 0 means backwards and value 1 means forward.
3	Read the data blocks of interest.
4	Write the value 1 to the Get next entry register.
5	Repeat steps 3 and 4 until there are no more entries stored. When all entries have been read, all registers in the data blocks are set to 0xFFFF.



Note – The Date/time registers are reset to 0xFFFF after a restart.

9.7 Event logs



Note – Before you can use the information in this chapter you must be familiar with and understand the information and the concepts described in “Historical Data” on page - 109.

Mapping table

The following table shows an overview of the mapping table:

Log type	Details	Start Reg (Hex)	Size
System log	Header	6500	16
System log	Data block	6510	105
Event log	Header	65B0	16
Event log	Data block	65C0	105
Audit log	Header	6660	16
Audit log	Data block	6670	105
Net quality log	Header	6710	16
Net quality log	Data block	6720	105
Communication log	Header	67C0	16
Communication log	Data block	67D0	105

Header and data block

There is one pair of header and data block for each log type, located in the registers listed in the mapping table above. In the tables showing the structure of the header and data block below the register numbers are valid for the System log. However the headers and data blocks for all log types share the same structure, so the tables are applicable for all log types if the register numbers are exchanged to correct values.

Structure of the header

The following table describes the header:

Function	Start Reg (Hex)	Size	Description	Read/write
Get next block	6500	1	Write value 1 to this register to load the next block of log entries	R/W
Entry number	6501	1	Write to this register to choose an entry number to start reading from	R/W
Date/Time	6504	3	Write to this register to choose a date/time to start reading from	R/W
Direction	6507	1	Write to this register to choose the direction of reading	R/W

Data block

The data block contains the log entries, consisting of timestamp, event counter, event category, event id and duration. There is space for up to 15 log entries in the data block. The log is read by repeatedly loading new values into the data block in backward or forward direction in time.

The event appearing in the first position in the data block has the entry number indicated by Entry number register. In case of backwards reading the events in the other positions follow in ascending entry number order, i.e. going towards older events. In case of forward reading the events in the other positions follow in descending entry number order, i.e. going towards more recent events.

Structure of the data block

The following table describes the structure of the data block:

Entry position	Contents	Start Reg (Hex)	Size	Description
1	Timestamp	6510	3	Date and time when the event occurred (Date/Time format)
1	Category	6513	1	The category of this log entry (exception, warning, error or information).
1	Event id	6514	1	The id for this log entry, identifying what has happened.
1	Duration	6515	2	The duration of this event measured in seconds.
...				
...				
15	Timestamp	6572	3	Date and time when the event occurred (Date/Time format)
15	Category	6575	1	The category of this log entry (exception, warning, error or information).
15	Event id	6576	1	The id for this log entry, identifying what has happened.
15	Duration	6577	2	The duration of this event measured in seconds.

Category

Possible values for the category register are shown in the table below:

Category	Description
1	Exception
2	Error

Category	Description
4	Warning
8	Information

9.7.1 Reading Event logs

General

Readout of logs is controlled by the Entry number register or the Date/Time register. After writing to the Entry number register or the Date/Time register, the log entries are available in the registers of the data block. To get the next set of entries the Get next entry register is used.

Read the 15 most recent logs

Follow the steps in the table below to read the 15 most recent log entries:

Step	Action
1	Write the value 1 to the entry number register.
2	Read the data block.

Read the entire history

Follow the steps in the table below to read the entire history of logs, backwards in time:

Step	Action
1	Write the value 0 to the Entry number register to make sure the reading starts from the most recent entry.
2	Write the value 1 to the Get next entry register.
3	Read the data block. First time this step is performed the logs in the data block are the most recent up to the 15th most recent. Second time this step is performed the logs in the data block are the 16th to the 30th.
4	Repeat steps 2 and 3 until there are no more entries stored. When all entries have been read, all registers in the data block are set to 0xFFFF.



Note – The entry number register is reset to 0 after a restart.

Read forward or backwards from a specified date/time

Follow the steps in the table below to read forward or backwards in time from a specified date/time:

Step	Action
1	Write a date and time to the Date/Time registers.
2	Write to the Direction register. Writing value 0 means backwards and value 1 means forward.
3	Read data block.
4	Write the value 1 to the Get next entry register.

Step	Action
5	Repeat steps 3 and 4 until there are no more entries stored. When all entries have been read, all registers in the data block are set to 0xFFFF.



Note – The Date/time registers are reset to 0xFFFF after a restart.

9.8 Load profile



Note – Before you can use the information in this chapter you must be familiar with and understand the information and the concepts described in “Historical Data” on page - 109.

Mapping table

The following table shows an overview of the mapping table:

Quantity	Details	Start Reg (Hex)	Size
Load profile	Header	8700	16
Load profile	Channel information	8710	7
Load profile	Data block	8720	120

Structure of the header

The following table describes the header:

Function	Start Reg (Hex)	Size	Description	Read/write
Get next block	8700	1	Write value 1 to this register to load the next block of load profile entries	R/W
Channel number	8703	1	Write to this register to choose a load profile channel. Possible values are 1-8.	R/W
Date/Time	8704	3	Write to this register to choose a date/time to start reading from	R/W
Direction	8707	1	Write to this register to choose the direction of reading	R/W

Structure of the channel information

The following table describes the channel information registers:

Function	Start Reg (Hex)	Size	Description	Read/write
Quantity	8710	3	OBIS code for the quantity stored in this channel	R/W
Scaler	8713	1	Scaling of the values stored in this channel	R/W
Interval	8714	2	Interval with which values are stored in this channel. Expressed in minutes.	R/W
Data type	8716	1	Data type of the values stored in this channel	R/W

Data block

The data block contains the load profile entries, consisting of timestamp, status and value. There is space for up to 15 entries in the data block. The load profile is read by repeatedly loading new values into the data block in backward or forward direction in time.

In case of backwards reading the entries in the data block are placed in ascending entry number order, i.e. going towards older entries. In case of forward reading the entries are placed in descending entry number order, i.e. going towards more recent entries.

Structure of the data block

The following table describes the structure of the data block:

Entry position	Contents	Start Reg (Hex)	Size	Description
1	Timestamp	8720	3	Date and time when the entry was stored. (Date/Time format)
1	Status	8723	1	The status for this entry
1	Value	8724	4	The value for this entry
...				
...				
15	Timestamp	8789	3	Date and time when the entry was stored. (Date/Time format)
15	Status	8792	1	The status for this entry
15	Value	8793	4	The value for this entry

Status register

The status register holds status information for a load profile entry.

The following table describes the meaning of the individual bits in the status register:

Bit number	Contents	Description
0	Entry available	This bit is set if the value register contains a valid value
1	Restart	This bit is set if a restart occurred during the interval
2	Interval long	This bit is set if the interval was longer than the configured interval. This happens if the date and time have been adjusted backwards in time.

Bit number	Contents	Description
3	Interval short	This bit is set if the interval was shorter than the configured interval. This happens if the date and time have been adjusted forward in time.
4	Time change	This bit is set if an adjustment to the date and time was made during the interval
5	Bad value	This bit is set if the value register contains a doubtful value
6-7	Not used	



Note – Bit 0 in the table above refers to the least significant bit in the register.

9.8.1 Reading Load profile

General

Readout of load profile is controlled by the Date/Time register. After writing to the Date/Time register, the load profile entries are available in the registers of the data block. To get the next set of entries the Get next entry register is used.

Read the 15 most recent entries

Follow the steps in the table below to read the 15 most recent load profile entries:

Step	Action
1	Write a date and time in the future to the Date/Time registers, e.g. 2099-01-01 00:00:00.
2	Write the value 0 to the Direction register.
3	Read the data block.

Read forward or backwards from a specified date/time

Follow the steps in the table below to read forward or backwards in time from a specified date/time:

Step	Action
1	Write a date and time to the Date/Time registers.
2	Write to the Direction register. Writing value 0 means backwards and value 1 means forward.
3	Read data block.
4	Write the value 1 to the Get next entry register.
5	Repeat steps 3 and 4 until there are no more entries stored. When all entries have been read, all registers in the data block are set to 0xFFFF.



Note – The Date/time registers are reset to 0xFFFF after a restart.

9.9 Configuration

Introduction

This section describes how to configure the following functions:

- Previous values
 - Demand
 - Load profile
 - Alarms
 - I/O
 - Tariffs
-

9.9.1 Previous values

General

Previous values configuration defines the set of quantities to store at the end of a period. It is also defines the period with which values are stored.

Mapping table

The following table shows an overview of the mapping table:

Quantity	Details	Start Reg (Hex)	Size
Previous values	Quantity configuration	8C50	5
Previous values	Period configuration	8C55	1

Quantity configuration registers

The following table describes the group of registers for configuring quantities to store in previous values:

Function	Start Reg (Hex)	Size	Description	Read/write
Number of channels	8C50	1	The number of channels used (up to a maximum of 50)	R/W
Channel number	8C51	1	Current channel number during read or write of configuration	R
Quantity	8C52	3	OBIS code for the quantity in this channel	R/W

Write quantity configuration

Follow the steps in the table below to configure the set of quantities to store in previous values:

Step	Action
1	Write the number of channels that shall be configured to the Number of channels register. This is a value between 1 and 50.

Step	Action
2	Write the OBIS code for the quantity to store in the first channel to the Quantity registers.
3	Repeat step 2 for all channels that shall be used, i.e. the same number of times as the value written in step 1.

Read quantity configuration

Follow the steps in the table below to read the current configuration of quantities to store in previous values:

Step	Action
1	Read the Number of channels register to find out how many channels are used.
2	Read from the Quantity registers to get the OBIS code for the quantity configured in the first channel.
3	Repeat step 2 for each channel, until all OBIS codes have been read. This means step 2 shall be performed the same number of times as the value read from the Number of channels register



Note – Step 1 initiates the readout procedure and can NOT be left out, even if the number of channels used is already known.



Note – The Channel number register can optionally be read together with the Quantity registers in step 2. The Channel number register holds the current channel number, starting from 1 after reading the Number of channels register. It is incremented every time the Quantity registers are read.

Period configuration register

The Period configuration register is used to read or write the period with which previous values are stored. The table below describes the contents of the Period configuration register:

Byte nr	Description	Possible values
0 (High byte)	Previous values period	0 = Daily 1 = Weekly 2 = Monthly
1 (Low byte)	Day of week, in case of weekly storage	1-7 (1 = Monday)

9.9.2 Demand

General

Demand configuration defines the set of quantities to store at the end of a period and the number of levels for these quantities. It is also defines the period with which values are stored, and the intervals for calculation of minimum and maximum values.

Mapping table

The following table shows an overview of the mapping table:

Quantity	Details	Start Reg (Hex)	Size
Demand	Quantity configuration	8C30	5
Demand	Level configuration	8C35	4
Demand	Interval configuration	8C39	1
Demand	Sub interval configuration	8C3A	1
Demand	Period configuration	8C3B	1

Quantity configuration registers

The following table describes the group of registers for configuring quantities to store in demand:

Function	Start Reg (Hex)	Size	Description	Read/write
Number of quantities	8C30	1	The number of quantities to store in Demand (up to a maximum of 50)	R/W
Quantity number	8C31	1	Current quantity number during read or write of configuration	R
Quantity	8C32	3	OBIS code for the quantity	R/W

Write quantity configuration

Follow the steps in the table below to configure the set of quantities to store in demand:

Step	Action
1	Write the number of quantities that shall be configured to the Number of quantities register. This is a value between 1 and 50.
2	Write the OBIS code for the first quantity to the Quantity registers.
3	Repeat step 2 for all quantities that shall be used, i.e. the same number of times as the value written in step 1.

Read quantity configuration

Follow the steps in the table below to read the current configuration of quantities to store in demand:

Step	Action
1	Read the Number of quantities register to find out how many quantities are used.
2	Read from the Quantity registers to get the OBIS code for the first quantity.
3	Repeat step 2 for each quantity, until all OBIS codes have been read. This means step 2 shall be performed the same number of times as the value read from the Number of quantities register



Note – Step 1 initiates the readout procedure and can NOT be left out, even if the number of quantities used is already known.



Note – The Quantity number register can optionally be read together with the Quantity registers in step 2. The Quantity number register holds the current quantity number, starting from 1 after reading the Number of quantities register. It is incremented every time the Quantity registers are read.

Level configuration registers

The following table describes the group of registers for configuring the number of levels for all quantities stored in demand:

Function	Start Reg (Hex)	Size	Description	Read/write
Level quantity	8C35	3	OBIS code for the quantity	R/W
Number of levels	8C38	1	Number of levels to store for the quantity	R/W

Write level configuration

Follow the steps in the table below to configure the number of levels for each of the quantities stored in demand:

Step	Action
1	Write the OBIS code for the first quantity to the Level quantity registers.
2	Write the number of levels to use for the quantity chosen in step 1 to the Number of levels register. Allowed values are 1-3.
3	Repeat step 1 and 2 for all quantities used in demand.



Note – It is assumed that the set of quantities, i.e. the OBIS codes, to store in demand has already been configured by performing the steps under Write quantity configuration. Writing an OBIS code in step 1 above does NOT add it to the set of quantities to store.

Read level configuration

Follow the steps in the table below to read the current configuration of levels for all quantities stored in demand:

Step	Action
1	Write the OBIS code for the first quantity to the Level quantity registers.
2	Read the number of levels used for the quantity chosen in step 1 from the Number of levels register.
3	Repeat step 1 and 2 for all quantities used in demand.



Note – It is assumed that the set of quantities, i.e. the OBIS codes, stored in demand is already known. Otherwise the steps under Read quantity configuration must be performed first to find these.

Interval configuration register

The Interval configuration register is used to read or write the length of the period with which average values are calculated. The interval is expressed in minutes.

Sub interval configuration register

The Sub interval configuration register is used to read or write the length of the short period in case of sliding demand. The sub interval is expressed in minutes.

Period configuration register

The Period configuration register is used to read or write the period with which demand values are stored. The table below describes the contents of the Period configuration register:

Byte nr	Description	Possible values
0 (High byte)	Demand period	0 = Daily 1 = Weekly 2 = Monthly
1 (Low byte)	Day of week, in case of weekly storage	1-7 (1 = Monday)

9.9.3 Load profile

General

Load profile configuration defines the quantity to store for each channel. It is also defines the interval by which values are stored and the maximum number of snapshots. All settings are individual for every channel.

Mapping table

The following table shows the registers used for load profile configuration:

Quantity	Details	Start Reg (Hex)	Size
Load profile	Channel number	8C20	1
Load profile	Quantity	8C21	3
Load profile	Interval	8C24	2
Load profile	Max number of snapshots	8C26	2

Write channel configuration

Follow the steps in the table below to configure all load profile channels:

Step	Action
1	Choose the channel to configure by writing a number to the Channel number register. Allowed values are 1-8.

Step	Action
2	Write the OBIS code for the quantity to store in the chosen channel to the Quantity registers.
3	Write the desired storing interval to the Interval registers. The interval is expressed in minutes.
4	Write the desired maximum number of snapshots to the Max number of snapshots registers.
5	Repeat steps 1 to 4 for all channels.

Read channel configuration

Follow the steps in the table below to read the current configuration of the load profile channels:

Step	Action
1	Choose the channel to read configuration for by writing a number to the Channel number register. Allowed values are 1-8.
2	Read from the Quantity registers to get the OBIS code for the quantity configured in the chosen channel.
3	Read from the Interval registers to get the storing interval for the chosen channel. The interval is expressed in minutes.
4	Read from the Max number of snapshots registers to get the maximum number of snapshots that can be stored in the chosen channel.
5	Repeat steps 1 to 4 for all channels.

9.9.4 Alarms

General

Alarm configuration defines the set of quantities to monitor. It is also defines the threshold values, delays and actions to perform for each alarm. Each alarm is configured individually.

Alarm configuration registers

The following table describes the group of registers for configuring the alarm parameters:

Function	Start Reg (Hex)	Size	Description	Read/write
Alarm number	8C60	1	The number (identifier) for the alarm to configure	R/W
Quantity	8C61	3	The quantity to monitor	R/W
Thresholds	8C64	8	ON and OFF thresholds to used to decide when the alarm is active	R/W

Function	Start Reg (Hex)	Size	Description	Read/write
Delays	8C6C	4	ON and OFF delays, defining the time that the measured value must be above/below the configured thresholds before the alarm triggers	R/W
Actions	8C70	2	Actions to perform when alarm is triggered	R/W

Quantity identifiers

The following table lists the OBIS codes for the quantities that can be monitored by an alarm:

Quantity	OBIS code
Voltage L1	1.0.32.7.0.255
Voltage L2	1.0.52.7.0.255
Voltage L3	1.0.72.7.0.255
Voltage L1-L2	1.0.134.7.0.255
Voltage L2-L3	1.0.135.7.0.255
Voltage L1-L3	1.0.136.7.0.255
Current L1	1.0.31.7.0.255
Current L2	1.0.51.7.0.255
Current L3	1.0.71.7.0.255
Current N	1.0.91.7.0.255
Active power total	1.0.16. 7.0.255
Active power L1	1.0.36. 7.0.255
Active power L2	1.0.56. 7.0.255
Active power L3	1.0.76. 7.0.255
Reactive power total	1.0.128. 7.0.255
Reactive power L1	1.0.129. 7.0.255
Reactive power L2	1.0.130. 7.0.255
Reactive power L3	1.0.131. 7.0.255
Apparent power total	1.0.137. 7.0.255
Apparent power L1	1.0.138. 7.0.255
Apparent power L2	1.0.139. 7.0.255

Quantity	OBIS code
Apparent power L3	1.0.140.7.0.255
Power factor total	1.0.13.7.0.255
Power factor L1	1.0.33.7.0.255
Power factor L2	1.0.53.7.0.255
Power factor L3	1.0.73.7.0.255
Harmonic voltage L1	1.0.32.7.0.255
Harmonic voltage L2	1.0.52.7.0.255
Harmonic voltage L3	1.0.72.7.0.255
Harmonic voltage L1-L2	1.0.134.7.0.255
Harmonic voltage L2-L3	1.0.135.7.0.255
Harmonic voltage L1-L3	1.0.136.7.0.255
Harmonic current L1	1.0.31.7.0.255
Harmonic current L2	1.0.51.7.0.255
Harmonic current L3	1.0.71.7.0.255
Harmonic current Neutral	1.0.91.7.0.255
Inactive (deactivates the alarm)	1.128.128.128.128.128

Thresholds registers

The Thresholds registers are used to read and write the ON and OFF threshold values for an alarm. The scaling is the same as where the quantity appears in the normal mapping tables. The first (lowest) 4 registers are the ON threshold and the last 4 registers are the OFF threshold. Data type is signed 64 bit integer.

Delays registers

The Delays registers are used to read or write the ON and OFF delays for an alarm. The delay is expressed in milliseconds. The first (lowest) 2 registers are the ON delay and the last 2 registers are the OFF delay. Data type is unsigned 32 bit integer.

Actions registers

The Actions registers are used to read or write the actions to be performed when an alarm triggers. The first (lowest) register holds the actions to perform. The

second register holds the number of the output to set, in case Set output action is used.

Register nr (Hex)	Bit number	Description	Possible values
8C72	0 (least significant bit)	Write entry to log	1 = use this action 0 = don't use
	1	Set output	1 = use this action 0 = don't use
	2	Set bit in alarm register	1 = use this action 0 = don't use
	3 - 15	Not used	
8C73	(Entire register)	Number of the output to turn on. Ignored if Set output bit above is set to 0.	1-4



Note – Both registers in the table above must be written in one operation, otherwise the value will not take effect.

Write alarm configuration

Follow the steps in the table below to configure the parameters for monitoring the value of a number of quantities in the meter:

Step	Action
1	Write the number of the alarm to configure to the Alarm number register. This is a value between 1 and 25.
2	Write the OBIS code for the quantity to monitor to the Quantity registers.
3	Write the ON and OFF thresholds to the Thresholds registers.
4	Write the ON and OFF delays to the Delays registers.
5	Write the actions to perform to perform to the Action registers.
6	Repeat step 1 to 4 for all alarms that shall be used.

Read alarm configuration

Follow the steps in the table below to read the current configuration of monitoring parameters for alarms.

Step	Action
1	Write the number of the alarm to read configuration for to the Alarm number register. This is a value between 1 and 25.
2	Read the Quantity registers to get the quantity monitored in the chosen alarm.
3	Read the Thresholds registers to get the ON and OFF thresholds.
4	Read the Delays registers to get the ON and OFF delays.
5	Read the Action registers to get the actions performed when an alarm is triggered.

Step	Action
6	Repeat step 1 to 4 for all alarms.

9.9.5 Inputs and outputs

General

Inputs and outputs configuration defines the function for each physical I/O port. It also defines the parameters for the logical pulse outputs.

Mapping table

The following table shows an overview of the mapping table:

Quantity	Details	Start Reg (Hex)	Size
Inputs and outputs	I/O port configuration	8C0C	4
Inputs and outputs	Pulse output configuration	8C10	12

I/O port configuration registers

The following table describes the group of registers for configuring the function for physical I/O ports:

Register	Start Reg (Hex)	Size	Description	Read/write
I/O port 1	8C0C	1	Function of first I/O port	R/W
I/O port 2	8C0D	1	Function of second I/O port	R/W
I/O port 3	8C0E	1	Function of third I/O port	R/W
I/O port 4	8C0F	1	Function of fourth I/O port	R/W

The following table lists the possible values for I/O port function:

Value	Function
0	Input
1	Communication output
2	Alarm output
3	Pulse output
4	Tariff output
5	Output always ON
6	Output always OFF

Pulse output configuration registers

The following table describes the group of registers for configuring the pulse outputs:

Function	Start Reg (Hex)	Size	Description	Read/write
Pulse output instance	8C10	1	The instance number of the pulse output	R/W
Port number	8C11	1	The physical I/O port on which the pulses are sent out	R/W
Energy quantity	8C12	3	The OBIS code for the quantity	R/W
Pulse frequency active energy	8C15	2	The pulse frequency, measured in pulses/kWh with 3 decimals. This is relevant only if Energy quantity is set to active energy.	R/W
Pulse frequency reactive energy	8C17	2	The pulse frequency, measured in pulses/kvarh with 3 decimals. This is relevant only if Energy quantity is set to reactive energy.	R/W
Pulse length	8C19	2	The duration of a pulse, measured in milliseconds	R/W
Turn off pulse output	8C1B	1	Write the value 1 to this register to turn off the chosen pulse output instance	R/W

Selectable energy quantities

The table below lists the possible energy quantities to associate with a pulse output:

Quantity	OBIS code
Active energy import total	1.0.1.8.0.255
Active energy export total	1.0.2.8.0.255
Reactive energy import total	1.0.3.8.0.255
Reactive energy export total	1.0.4.8.0.255

Write pulse output configuration

Follow the steps in the table below to configure the pulse outputs:

Step	Action
1	Choose the pulse output instance to configure by writing a number to the Pulse output instance register. Allowed values are 1-4.
2	Write to the Port number register to decide to which physical port the pulses are sent out for the chosen pulse output. Allowed values are 0-4, where 0 means No Output.
3	Write the OBIS code of the quantity that shall be used for the chosen pulse output to the Energy quantity registers. Possible OBIS codes are listed above.

Step	Action
4	Write the desired pulse frequency to the Pulse frequency active or reactive energy registers, depending on the chosen energy type.
5	Write the desired pulse length to the Pulse length registers.
6	Repeat steps 1 to 5 for all pulse outputs.

Turn off a pulse output

Follow the steps in the table below to turn off a pulse output instance:

Step	Action
1	Choose the pulse output instance to configure by writing a number to the Pulse output instance register. Allowed values are 1-4.
2	Write the value 1 to the Turn off pulse output register.

Read pulse output configuration

Follow the steps in the table below to read the current pulse output configuration:

Step	Action
1	Choose the pulse output instance to read configuration for by writing a number to the Pulse output instance register. Allowed values are 1-4.
2	Read the Port number register to get the I/O port number used by the chosen pulse output instance.
3	Read the Energy quantity registers to get the OBIS code of the quantity used for the chosen pulse output instance.
4	Read the Pulse frequency active or reactive energy registers, depending on the chosen energy type, to get the pulse frequency used by the chosen pulse output instance.
5	Read the Pulse length registers to get the pulse length used by the chosen pulse output instance.
6	Repeat steps 1 to 5 for all pulse outputs.

9.9.6 Tariffs

General

Tariff configuration defines the currently used tariff source, i.e. communication, clock or inputs. It is also defines the settings that are specific for each of these sources.

Mapping table

The following table shows an overview of the mapping table:

Quantity	Details	Start Reg (Hex)	Size
Tariffs	Tariff source	8C90	1
Tariffs	Input configuration	8C91	1
Tariffs	Season configuration	8C92	35

Quantity	Details	Start Reg (Hex)	Size
Tariffs	Week profile configuration	8CB5	24
Tariffs	Day profile configuration	8CCD	6
Tariffs	Special days configuration	8CD3	5

Tariff source register

The Tariff source register is used to read or write the source used for controlling the tariffs. Possible values are listed in the table below:

Value	Description
0	Clock (Calendar)
1	Communication
2	Inputs

Input configuration register

The Input configuration register is used for reading and writing tariff input configuration. It decides how many tariffs are used, and which tariff is activated for every combination of values on the inputs. The following table describes the contents of the Input configuration register:

Byte	Bits	Description	Possible values
0 (high byte)	Entire byte	The number of tariffs to use	1-4
1 (low byte)	0-1*	Tariff to activate when both inputs are OFF	0-3 (0 = tariff 1, etc)
	2-3*	Tariff to activate when input 3 is ON and input 4 is OFF	0-3
	4-5*	Tariff to activate when input 3 is OFF and input 4 is ON	0-3
	6-7*	Tariff to activate when both inputs are ON	0-3

* Bit 0 is the least significant bit.

Season configuration registers

The following table describes the group of registers for configuring seasons:

Function	Start Reg (Hex)	Size	Description	Read/write
Number of seasons	8C92	1	The number of seasons used (1-4)	R/W
Season number	8C93	1	Current season number during read or write of configuration	R

Function	Start Reg (Hex)	Size	Description	Read/write
Season	8C94	33	Name, start date/time and associated week profile for the season	R/W

Season registers

The following table describes the group of registers for configuring a season:

Function	Start Reg (Hex)	Size	Description	Read/write
Season name	8C94	15	The season name. Expressed as an ASCII character string, with a maximum length of 30 characters. First character is in the high byte of the lowest register. Any unused space in the end must be set to binary 0.	R/W
Season start	8C93	3	Start date/time of the season. Formatted as Date/Time. See "Date and time format" on page - 112. Hour, Minute and Second are currently not used and must be set to FF.	R/W
Week profile	8C94	15	The name of the week profile associated with this season. Same format as Season name.	R/W



Note – All 33 registers in the table above must be written in one operation, otherwise the values will not take effect.

Write season configuration

Follow the steps in the table below to write the season configuration:

Step	Action
1	Write the number of seasons to use to the Number of seasons register. This is a value between 1 and 4.
2	Write the desired season configuration of the first season to the Season registers.
3	Repeat step 2 for all seasons that shall be used, i.e. the same number of times as the value written in step 1.

Read season configuration

Follow the steps in the table below to read the current season configuration:

Step	Action
1	Read the Number of seasons register to find out how many seasons are used.
2	Read from the Season registers to get the season name, start date/time and week profile associated with the first season.

Step	Action
3	Repeat step 2 for each season, until all season configurations have been read. This means step 2 shall be performed the same number of times as the value read in step 1.



Note – Step 1 initiates the readout procedure and can NOT be left out, even if the number of seasons used is already known.



Note – The Season number register can optionally be read together with the Season registers in step 2. The Season number register holds the current season number, starting from 1 after reading the Number of seasons register. It is incremented every time the Season registers are read.

Week profile configuration registers

The following table describes the group of registers for configuring week profiles:

Function	Start Reg (Hex)	Size	Description	Read/write
Number of week profiles	8CB5	1	The number of week profiles used (1-4)	R/W
Week profile number	8CB6	1	Current week profile number during read or write of configuration	R
Week profile	8CB7	22	Name and day IDs for the week profile	R/W

Week profile registers

The following table describes the group of registers for configuring a week profile:

Function	Start Reg (Hex)	Size	Description	Read/write
Week profile name	8CB7	15	The week profile name. Same format as described in Season registers above.	R/W
Day ID monday	8CC6	1	Day ID for monday. Allowed values are 1-16.	R/W
Day ID	1	...	R/W
Day ID sunday	8CCC	1	Day ID for sunday. Allowed values are 1-16.	R/W



Note – All 22 registers in the table above must be written in one operation, otherwise the values will not take effect.



Note – If the tariff configuration has been performed using any other communication protocol, other values than 1-16 can occur for Day IDs. When configuring over Modbus though, the values written have to be within this range.

Write week profile configuration

Follow the steps in the table below to configure the week profiles:

Step	Action
1	Write the number of week profiles to use to the Number of week profiles register. This is a value between 1 and 4.
2	Write the desired week profile configuration of the first week profile to the Week profile registers.
3	Repeat step 2 for all week profiles that shall be used, i.e. the same number of times as the value written in step 1.

Read week profile configuration

Follow the steps in the table below to read the current week profile configuration:

Step	Action
1	Read the Number of week profiles register to find out how many week profiles are used.
2	Read from the Week profile registers to get the week profile name and day ID:s for the first week profile.
3	Repeat step 2 for each week profile, until all week profile configurations have been read. This means step 2 shall be performed the same number of times as the value read in step 1.



Note – Step 1 initiates the readout procedure and can NOT be left out, even if the number of week profiles used is already known.



Note – The Week profile number register can optionally be read together with the Week profile registers in step 2. The Week profile number register holds the current week profile number, starting from 1 after reading the Number of week profiles register. It is incremented every time the Week profile registers are read.

Day profile configuration registers

The following table describes the group of registers for configuring day profiles:

Function	Start Reg (Hex)	Size	Description	Read/write
Number of day profiles	8CCD	1	The number of day profiles used (1-16)	R/W
Day profile number	8CCE	1	Current day profile number during read or write of configuration	R
Number of actions	8CCF	1	The number of actions during a day profile (1-30)	R/W
Action number	8CD0	1	Current action number during read or write of configuration	R
Action	8CD1	2	Time when the action shall be performed, and what to do	R/W

Action registers

The following table describes the group of registers for configuring a day profile action:

Function	Byte number	Description
Execution time	0 (High byte)	Hour when the action shall be performed.
	1 (Low byte)	Minute when the action shall be performed.
Action id	(Both bytes)	Decides the action to perform. See the list of possible actions below.



Note – Both registers in the table above must be written in one operation, otherwise the values will not take effect.

Possible actions to perform are activating tariffs and setting or resetting outputs. The possible values for action id are listed in the table below:

Value	Description
0	Activate tariff 1
...	...
3	Activate tariff 4
100	Set output 1
101	Reset output 1
...	...
106	Set output 4
107	Reset output 4

Write day profile configuration

Follow the steps in the table below to configure the day profiles:

Step	Action
1	Write the number of day profiles to use to the Number of day profiles register. This is a value between 1 and 16.
2	Write the number of actions to perform for the first day profile to the Number of actions register. This is a number between 1 and 30.
3	Write the execution time and action id for the first action to perform during the day to the Action registers.
4	Repeat step 3 for all actions that shall be performed during the day, i.e. the same number of times as the value written in step 2.
5	Repeat step 2-4 for all day profiles, i.e. the same number of times as the value written in step 1.

Read day profile configuration

Follow the steps in the table below to read the current day profile configuration:

Step	Action
1	Read the Number of day profiles register to find out how many day profiles are used.
2	Read the Number of actions register to find out how many actions are configured for the first day profile.
3	Read from the Action registers to get the execution time and action id for the first action.
4	Repeat step 3 for all actions that are configured for the day, i.e. the same number of times as the value read in step 2.
5	Repeat step 2-4 for all day profiles, i.e. the same number of times as the value read in step 1.



Note – Step 1 and 2 initiate the readout procedure and can NOT be left out, even if the number of day profiles and actions used are already known.



Note – The Day profile number register can optionally be read together with the Number of actions register in step 2. The Day profile number register holds the current day profile number, starting from 1 after reading the Number of day profiles register. It is incremented every time the last action during the day is read from Action registers. In the same way the Action number register can optionally be read together with the Action registers in step 3. The Action number register holds the current action number, starting from 1 after reading the Number of actions register. It is incremented every time the Action registers are read.

Special days configuration registers

The following table describes the group of registers for configuring special days:

Function	Start Reg (Hex)	Size	Description	Read/write
Number of special days	8CD3	1	The number of special days used (1-50)	R/W
Special day number	8CD4	1	Current special day number during read or write of configuration	R
Special day	8CD5	3	Date and associated day ID for the special day	R/W

Special day registers

The following table describes the group of registers for configuring a week profile:

Contents	Register	Byte nr	Description
Date	8CD3	0 (high byte)	Year

Contents	Register	Byte nr	Description
		1	Month
	8CD4	0	Day
		1	Not used
Day id	8CD5	(Both)	Day ID associated with the special day



Note – All 3 registers in the table above must be written in one operation, otherwise the values will not take effect.

Write special day configuration

Follow the steps in the table below to configure the special days:

Step	Action
1	Write the number of special days to use to the Number of special days register. This is a value between 1 and 50.
2	Write the desired date and day id of the first special to the Special day registers.
3	Repeat step 2 for all special days that shall be used, i.e. the same number of times as the value written in step 1.

Read special day configuration

Follow the steps in the table below to read the current special day configuration:

Step	Action
1	Read the Number of special days register to find out how many special days are used.
2	Read from the Special day registers to get the date and day id for the first special day.
3	Repeat step 2 for each special day, until all special day configurations have been read. This means step 2 shall be performed the same number of times as the value read in step 1.



Note – Step 1 initiates the readout procedure and can NOT be left out, even if the number of special days used is already known.



Note – The Special day number register can optionally be read together with the Special day registers in step 2. The Special day number register holds the current special day number, starting from 1 after reading the Number of special days register. It is incremented every time the Special day registers are read.

Chapter 10: Communication with M-Bus

Overview This chapter describes how to read meter data and to send commands to the meter over M-Bus.

In this chapter The following topics are covered in this chapter:

- 10.1 Protocol Description 154
- 10.2 Standard Readout of Meter Data 172
- 10.3 Special Readout of Meter Data 204
- 10.4 Sending Data to the Meter 235

10.1 Protocol Description

General

The communication protocol described in this chapter meets the requirements of EN 13757-2 and EN 13757-3.

The communication can be divided in two parts. One part is reading data from the meter and the other part is sending data to it.

The data readout procedure starts when the master sends a REQ_UD2 telegram to the meter. The meter responds with a RSP_UD telegram. A typical readout is a multi-telegram readout.

Some data in the meter can only be read by first sending a SND_UD followed by REQ_UD2. This is true for load profiles, demand and log files.

Using SND_UD telegrams data can be sent to the meter.

Communication objects

The following quantities can be read by sending a REQ_UD2 to the meter

Register	Communication objects
Active import energy, total	Total cumulative active imported energy
Active import energy, tariff 1	Cumulative active imported energy tariff 1
Active import energy, tariff 2	Cumulative active imported energy tariff 2
Active import energy, tariff 3	Cumulative active imported energy tariff 3
Active import energy, tariff 4	Cumulative active imported energy tariff 4
Reactive import energy, total	Total cumulative reactive imported energy
Reactive import energy, tariff 1	Cumulative reactive imported energy tariff 1
Reactive import energy, tariff 2	Cumulative reactive imported energy tariff 2
Reactive import energy, tariff 3	Cumulative reactive imported energy tariff 3
Reactive import energy, tariff 4	Cumulative reactive imported energy tariff 4
Active export energy, total	Total cumulative active exported energy
Active export energy, tariff 1	Cumulative active exported energy tariff 1
Active export energy, tariff 2	Cumulative active exported energy tariff 2
Active export energy, tariff 3	Cumulative active exported energy tariff 3
Active export energy, tariff 4	Cumulative active exported energy tariff 4
Reactive export energy, total	Total cumulative reactive exported energy
Reactive export energy, tariff 1	Cumulative reactive exported energy tariff 1
Reactive export energy, tariff 2	Cumulative reactive exported energy tariff 2
Reactive export energy, tariff 3	Cumulative reactive exported energy tariff 3
Reactive export energy, tariff 4	Cumulative reactive exported energy tariff 4
CT Ratio	Current transformer ratio (numerator)
CT Ratio	Current transformer ratio (denominator)
VT Ratio	Voltage transformer ratio (numerator)
VT Ratio	Voltage transformer ratio (denominator)
Outputs	Read and set status of outputs
Inputs, current state	Read current state of input 1,2, 3 and 4

Register	Communication objects
Inputs, stored state	Read and reset stored state of input 1,2, 3 and 4
Inputs, counter	Read and clear input pulse counter 1,2, 3 and 4
Current, L1	Instantaneous current in the L1 phase
Current, L2	Instantaneous current in the L2 phase
Current, L3	Instantaneous current in the L3 phase
Voltage, L1-N	Instantaneous voltage between L1 and neutral
Voltage, L2-N	Instantaneous voltage between L2 and neutral
Voltage, L3-N	Instantaneous voltage between L3 and neutral
Voltage, L1-L2	Instantaneous voltage between L1 and L2
Voltage, L2-L3	Instantaneous voltage between L2 and L3
Voltage, L1-L3	Instantaneous voltage between L1 and L3
Active Power, Total	Instantaneous total active power
Active Power, L1	Instantaneous active power in L1
Active Power, L2	Instantaneous active power in L2
Active Power, L3	Instantaneous active power in L3
Reactive Power, Total	Instantaneous total reactive power
Reactive Power, L1	Instantaneous reactive power in L1
Reactive Power, L2	Instantaneous reactive power in L2
Reactive Power, L3	Instantaneous reactive power in L3
Apparent Power, Total	Instantaneous total apparent power
Apparent Power, L1	Instantaneous apparent power in L1
Apparent Power, L2	Instantaneous apparent power in L2
Apparent Power, L3	Instantaneous apparent power in L3
Voltage phase angle, L1	Instantaneous voltage phase angle for L1 (L1 voltage is reference)
Voltage phase angle, L2	Instantaneous voltage phase angle for L2 (L1 voltage is reference)
Voltage phase angle, L3	Instantaneous voltage phase angle for L3 (L1 voltage is reference)
Current phase angle, L1	Instantaneous current phase angle for L1 (L1 voltage is reference)
Current phase angle, L2	Instantaneous current phase angle for L2 (L1 voltage is reference)
Current phase angle, L3	Instantaneous current phase angle for L3 (L1 voltage is reference)
Phase angle power, Total	Instantaneous phase angle for total power
Phase angle power L1	Instantaneous phase angle power for L1
Phase angle power L2	Instantaneous phase angle power for L2
Phase angle power L3	Instantaneous phase angle power for L3
Installation check	Read result of and clear installation check
Current quadrant, Total	Quadrant in which the meter is measuring
Current quadrant, L1	Quadrant in which the meter is measuring, L1
Current quadrant, L2	Quadrant in which the meter is measuring, L2

Register	Communication objects
Current quadrant, L3	Quadrant in which the meter is measuring, L3
Power fail counter	Read and reset power fail counter
Total power outage time	Read and reset total power outage time
Current tariff	Read and set current tariff
Manufacturer	Manufacturer information
FW-version	Firmware version
Warning flags	Read warning flags
Info flags	Read info flags
Alarm flags	Read alarm flags
Error flags	Read error flags
Date and time	Read and set date and time
Previous values	Read previous values
Load profile	Read load profile data
Demand	Read Demand (max. and min. data)
Event log	Read event log data
System log	Read system log data
Audit log	Read audit log data
Net quality log	Read net quality log data
Settings log	Read transformer log data
Current harmonics	Read THD and harmonics on each current measured
Voltage harmonics	Read THD and harmonics on each voltage measured
Apparent import energy, total	Total cumulative apparent imported energy
Apparent export energy, total	Total cumulative apparent exported energy
Active import energy, L1	Cumulative active imported energy in the L1 phase
Active import energy, L2	Cumulative active imported energy in the L2 phase
Active import energy, L3	Cumulative active imported energy in the L3 phase
Active export energy, L1	Cumulative active exported energy in the L1 phase
Active export energy, L2	Cumulative active exported energy in the L2 phase
Active export energy, L3	Cumulative active exported energy in the L3 phase
Reactive import energy, L1	Cumulative reactive imported energy in the L1 phase
Reactive import energy, L2	Cumulative reactive imported energy in the L2 phase
Reactive import energy, L3	Cumulative reactive imported energy in the L3 phase
Reactive export energy, L1	Cumulative reactive exported energy in the L1 phase
Reactive export energy, L2	Cumulative reactive exported energy in the L2 phase
Reactive export energy, L3	Cumulative reactive exported energy in the L3 phase

Register	Communication objects
Apparent import energy, L1	Cumulative apparent imported energy in the L1 phase
Apparent import energy, L2	Cumulative apparent imported energy in the L2 phase
Apparent import energy, L3	Cumulative apparent imported energy in the L3 phase
Apparent export energy, L1	Cumulative apparent exported energy in the L1 phase
Apparent export energy, L2	Cumulative apparent exported energy in the L2 phase
Apparent export energy, L3	Cumulative apparent exported energy in the L3 phase

Read/write commands

The following tasks are possible to perform with SND_UD telegrams:

Command
Set tariff
Set primary address
Change baud rate
Reset power fail counter
Reset power outage time
Set CT Ratio numerator
Set CT Ratio denominator
Set VT Ratio numerator
Set VT Ratio denominator
Select Status information
Reset stored state input
Reset input counters
Set output
Set date time
Set date
Send Password
Freeze Max demand
Set communication access level
Read Request Load profile
Read request previous values
Read request demand (maximum and minimum
Read request Log (System, Event, quality, audit and Transformer Logs)
Read request current harmonics
Read request voltage harmonics
Read/Write Load profile settings
Read/Write Previous value settings

Command
Read/Write Alarm settings
Read/Write Tariff settings

10.1.1 Telegram Format

General

M-Bus uses 3 different telegram formats. The formats are identified by the start character.

Single Character	Short Frame	Long Frame
E5H	Start (10h)	Start (68h)
	C-Field	L-Field
	A-Field	L-Field
	Check Sum	Start (68h)
	Stop (16h)	C-Field
		A-Field
		CI-Field
		User Data (0-252 Bytes)
		Check Sum
		Stop (16h)

The **Single Character** format consists of a single character and is used to acknowledge received telegrams.

The **Short Frame** format is identified by its start character (10h) and consists of five characters. Besides the C- and A-fields it includes the check sum and the stop character 16h.

The **Long Frame** format is identified by its start character (68h) and consists of a variable number of characters. After the start character the L-field is transmitted twice, then the start character once again followed by the C-, A- and CI-fields. The user data (0 - 252 bytes) is transmitted after the CI-field followed by the check sum and the stop character (16h).

10.1.1.1 Field description

General

All fields in the telegram have a length of 1byte (8 bits).

The L-Field

The L-Field (length field) gives the size of the user data (in bytes) plus 3 (for the C-, A- and CI-Fields). It is transmitted twice in the telegrams using the long frame format.

The C-Field

The C-Field (control field) contains information about the direction of the data flow and error handling. Besides labeling the functions and the actions caused by them, the control field specifies the direction of data flow and is responsible for various parts of the communication to and from the meter.

The following table shows the coding of the C-Field:

Bit No.	7	6	5	4	3	2	1	0
To meter	0	PRM	FCB	FCV	F3	F2	F1	F0
From meter	0	PRM	0	0	F3	F2	F1	F0

The primary message bit (**PRM**) is used to specify the direction of the data flow. It is set to 1 when a telegram is sent from a master to the meter and to 0 in the other direction.

The frame count bit valid (**FCV**) is set to 1 by the master to indicate that the frame count bit (**FCB**) is used. When the FCV is set to 0, the meter ignores the FCB.

The FCB is used to indicate successful transmission procedures. A master shall toggle the bit after a successful reception of a reply from the meter. If the expected reply is missing, or the reception of it is faulty, the master resends the same telegram with the same FCB. The meter answers, to a REQ_UD2-request with toggled FCB and a set FCV, with a RSP_UD containing the next telegram of a multi-telegram answer. If the FCB is not toggled it will repeat the last telegram. The actual values will be updated in a repeated telegram.

On receipt of a SND_NKE the meter clears the FCB. The meter uses the same FCB for primary addressing, secondary addressing and point-to-point communication.

The bits 0 to 3 (F0, F1, F2 and F3) of the control field are the function code of the message. The following table shows the function codes:

Comand	C-Field (binary)	C-Field (hex)	Telegram	Description
SND_NKE	0100 0000	40	Short frame	Initialization of meter
SND_UD	01F1 0011	53/73	Long frame	Send user data to meter
REQ_UD2	01F1 1011	5b	Short frame	Request for class 2 data
RSP_UD	0000 1000	08	Long frame	Data transfer form meter to master after request.

A-Field

The A-Field (address field) is used to address the recipient in the calling direction, and to identify the sender of information in the receiving direction. The size of this field is one byte, and can therefore take values from 0 to 255.

The following table shows the allocation of addresses:

Address	Description
0	Factory default
1-250	Can be given to meters as individual primary addresses, either via the bus (secondary addressing) or via the buttons directly on the meter.
251-252	Reserved for future use.
253	Used by the secondary addressing procedure (FDh).
254	Used for point-to-point communication (FEh). The meter replies with its primary address.
255	Used for broadcast transmissions to all meters (FFh). None of the meters replies to a broadcast message.

CI-Field

The CI-field (control information) codes the type and sequence of application data to be transmitted in the frame. Bit two (counting begins with bit 0, value 4), called M-bit or Mode bit, in the CI-field gives information about the used byte sequence in multi-byte data structures. For communication with the meter, the Mode bit shall not be set (Mode 1) meaning the least significant byte of a multi-byte record is transmitted first.

The following table shows the codes to be used by the master:

CI_Field codes	Application
51h	Data send
52h	Selection of slaves
B8h	Set baud rate to 300
B9h	Set baud rate to 600
Bah	Set baud rate to 1200
BBh	Set baud rate to 2400
BCh	Set baud rate to 4800
BDh	Set baud rate to 9600
BEh	Set baud rate to 19200
BFh	Set baud rate to 38400

The meter uses code 72 in the CI-Field to respond to requests for user data.

User data

The User Data contains the data to be sent to the recipient.

The following table shows the structure of the data sent from the meter to the master:

Fixed data header	Data records	MDH
12 bytes	Variable number of bytes	1 byte

The following table shows the structure of the data sent from the master to the meter:

Data records
Variable number of bytes

Fixed data header

The following table shows the structure of the fixed data header:

ID No.	Manufacturer	Version	Medium	Access No.	Status	Signature
4 bytes	2 bytes	1 byte	1 byte	1 byte	1 byte	2 byte

The following list explains the content of the fixed data header:

- **Identification No.** is the 8-digit serial number of the meter (BCD coded).
- **Manufacturer** is set to 0442h meaning ABB
- **Version** specifies the version of the protocol implementation. The meters currently use the protocol version equal to 0x20.
- **Medium** byte is set to 02h to indicate electricity.
- **Access number** is a counter that counts successful accesses.
- **Status byte** is used to indicate the meter status.

Bit	Meaning
0	Meter busy
1	Internal error
2	Power low
3	Permanent error
4	Temporary error
5	Installation error
6	Not used
7	Not used

- **Signature** is set to 00 00h

Data records

The data, together with information regarding coding, length and the type of data is transmitted in data records. The maximum total length of the data records is 240 bytes.

The following table shows the structure of the data record (transmitted left to right):

Data Record Header				Data
Data Information Block (DIB)		Value Information Block (VIB)		
DIF	DIFE	VIF	VIFE	
1 byte	0-10 bytes	1 byte	0-10 bytes	
				0-n bytes

Each Data record consists of a data record header (DRH) and the actual data. The DRH in turn consists of the data information block (DIB) to describe the length, type and coding of the data, and the value information block (VIB) to give the value of the unit and the multiplier.

Data information block (DIB)

The DIB contains at least one byte (Data Information Field, DIF), and is in some cases expanded with, a maximum of 10, DIFE's (Data Information Field Extension).

The following table shows the structure of the Data Information Field (DIF):

Bit 7	Bit 6	Bit 5	Bit 4	Bit 3	Bit 2	Bit 1	Bit 0
Extension bit	LSB ¹ of storage No.	Function Field		Data Field			

1. Least significant bit.

The following list explains the content of the DIF:

- The **Extension Bit** is set when the next byte is a DIFE.
- The **LSB of storage No.** is normally set to 0 to indicate actual value. (1=stored value).
- The **Function Field** is set to 00 for instantaneous values, 01 for maximum values and 10 for minimum values.
- The **Data Field** shows the format of the data. The following table shows the coding of the data field:

Code	Meaning	Length
0000	No Data	0
0001	8 Bit Integer	1
0010	16 Bit Integer	2
0100	32 Bit Integer	4
0111	64 Bit Integer	8
1010	4 digit BCD	2
1111	6 digit BCD	3
1100	8 digit BCD	4

Code	Meaning	Length
1101	Variable Length (ASCII)	Variable
1110	12 digit BCD	6

The following table shows the structure of the Data Information Field Extension (DIFE)

Bit 7	Bit 6	Bit 5	Bit 4	Bit 3	Bit 2	Bit 1	Bit 0
Extension bit	Unit	Tariff		Storage No.			

The following list explains the content of the DIFE:

- **Unit** is used for power and energy values show the type of power/energy. It is also used to define the number of inputs/outputs and to specify sign of offset when accessing event log data.
- **Tariff** is used for energy values to give tariff information.
- **Storage number** is set to 0 in values read to indicate momentary values. Storage number bigger than 0 is used to indicate previously stored values, i.e, values stored at a specific point of time in the past.

Value Information block (VIB)

VIB follows a DIF or DIFE without extension bit. It contains one value information field (VIF) and is in some cases expanded with up to 10 value information field extensions (VIFE).

The following table shows the structure of the value information field (VIF):

Bit 7	6	5	4	3	2	1	0
Extension Bit	Value Information						

Value information contains information about the value (unit, status, etc.) The extension bit is set when the next byte is a VIFE.

If VIF or VIFE = FFh the next VIFE is manufacturer specific. The manufacturer specific VIFE has the same construction as a VIF. If the extension bit of the manufacturer specific VIFE is set, and the VIFE is less than 1111 1000, the next byte is a standard VIFE, otherwise it is the first data byte. If the extension bit of the manufacturer specific VIFE is set and the VIFE is bigger than or equal to 1111 1000, the next byte is an extension of manufacturer specific VIFE's.

Data

The Data follows a VIF or a VIFE without the extension bit set.

Manufacturer data header (MDH)

The manufacturer data header (MDH) is either made up by the character 1Fh that indicates that more data will follow in the next telegram, or by 0Fh indicating the last telegram.

Check sum

The Check Sum is used to recognize transmission and synchronization faults. It is calculated from the arithmetical sum, of the bytes from the control field to the last user data, without taking carry digits into account .

10.1.2 Value Information Field codes

10.1.2.1 Standard VIF codes

VIF-code	Description	Range coding	Range
E000 0nnn	Energy	$10^{(nnn-3)}$ Wh	0.001Wh to 10000Wh
E010 1nnn	Power	$10^{(nnn-3)}$ W	0.001W to 10000W
E010 00nn	Duration	nn = 00 seconds nn = 01 minutes nn = 10 hours nn = 11 days	
E110 110n	Time point	n = 0: date n = 1: time & date	Data type G Data type F or 6 byte BCD coding
E111 1000	Fabrication No.		00000000 to 99999999
E111 1010	Bus address		0-250
1111 1011	Extension of VIF-codes		Not used by the meter
1111 1101	Extension of VIF-codes		True VIF is given in the first VIFE and is coded using Table FD
1111 1111	Manufacturer specific		Next VIFE is manufacturer specific

10.1.2.2 Standard codes for VIFE used with extension indicator FDh

If the VIF contains the extension indicator FDh the true VIF is contained in the first VIFE.

VIFE-code	Description
E000 1010	Manufacturer
E000 1100	Version
E000 1110	Firmware Version
E001 1010	Digital Output (binary)
E001 1011	Digital Input (binary)
E001 1100	Baud rate
E010 01nn	Interval length, 00: seconds, 01: minutes), 10: hours, 11: days

VIFE-code	Description
E100 nnnn	10 ⁽ⁿⁿⁿⁿ⁻⁹⁾ Volts
E101 nnnn	10 ⁽ⁿⁿⁿⁿ⁻¹²⁾ A
E110 0001	Cumulating counter
E001 0110	Password

10.1.2.3 Standard codes for VIFE

The following values for VIFE's are defined for an enhancement of VIF's other than FDh and FBh:

VIFE-code	Description
E010 0111	Per measurement (interval) ^{1 2}
E011 1001	Start date(/time) of
E110 1f1b	Date (/time) of, b = 0: end of, b = 1: begin of, f is not used in meters, always 0 ^{1 2}
1111 1111	Next VIFE is manufacturer specific

1. Date (/time) of “or duration of” relates to the information which the whole data record contains.
2. The information about usage of data type F (date and time) or data type G (date) can be derived from the data field (0010b: type G/0100: type F).

10.1.2.4 First manufacturer specific VIFE-codes

VIFE-code	Description
E000 0000	Total
E000 0001	L1
E000 0010	L2
E000 0011	L3
E000 0100	N
E000 0101	L1-L2
E000 0110	L3-L2
E000 0111	L1 – L3
E001 0000	Pulse frequency
E001 0011	Tariff
E001 0100	Installation check
E001 0101	Status of values
E001 0111	Current quadrant
E001 1000	Power fail counter

VIFE-code	Description
E010 0000	Current Transformer ratio numerator (CT ratio)
E010 0001	Voltage Transformer ratio numerator (VT ratio)
E010 0010	Current Transformer ratio denominator (CT ratio)
E010 0011	Voltage Transformer ratio denominator (VT ratio)
E010 0100	CO2 conversion factor ($\text{kg} * 10^{-3} / \text{kWh}$)
E010 0101	Currency conversion factor ($\text{curr} * 10^{-3} / \text{kWh}$)
E010 0110	Error flags
E010 0111	Warning flags
E010 1000	Information flags
E010 1001	Alarm flags
E100 0nnn	Phase angle voltage ($\text{degrees} * 10^{(nnn-3)}$)
E100 1nnn	Phase angle current ($\text{degrees} * 10^{(nnn-3)}$)
E101 0nnn	Phase angle power ($\text{degrees} * 10^{(nnn-3)}$)
E101 1nnn	Frequency ($\text{Hz} * 10^{(nnn-3)}$)
E110 0nnn	Power factor ($*10^{(nnn-3)}$)
E110 1010	Change communication write access level
E110 1100	Power outage time
E110 1101	Current harmonics
E110 1110	Voltage harmonics
E110 1111	Event type
E111 0000	Measurement period
E111 0001	Reset counter for energy
E111 0010	Resettable register
E111 0110	Sequence number (audit log)
E111 1000	Extension of manufacturer specific VIFE's, next VIFE(s) used for numbering
E111 1001	Extension of manufacturer specific VIFE's, next VIFE(s) specifies actual meaning
E111 1110	Extension of manufacturer specific VIFE's, next VIFE(s) used for manufacturer specific record errors/status

10.1.2.5 VIFE-Codes for reports of record errors (meter to master)

VIFE-code	Type of record error	Error group
E000 0000	None	

VIFE-code	Type of record error	Error group
E001 0101	No data available (undefined value)	
E001 1000	Data error	Data errors

10.1.2.6 VIFE-Codes for object actions (master to meter)

VIFE-code	Action	Description
E000 0111	Clear	Set data to zero
E000 1011	Freeze data	Freeze data to storage number

10.1.2.7 2:nd manufacturer specific VIFE followed after VIFE 1111 1000 (F8 hex):

VIFE-code	Description
Ennn nnnn	Used for numbering (0-127)

10.1.2.8 2:nd manufacturer specific VIFE followed after VIFE 1111 1001 (F9 hex):

VIFE-code	Description
E000 0001	DST, day of week, day type, season
E000 0010	Quantity specification of maximum demand
E000 0011	Quantity specification of previous values
E000 0100	Quantity specification of load profile
E000 0110	Quantity specification of event log
E000 0110	Tariff source
E001 0000	Readout request of active imported energy load profile in format energy register values at end of intervals
E001 0001	Readout request of active imported energy load profile in format energy consumption per interval
E001 0010	Readout request of reactive imported energy load profile in format energy register values at end of intervals
E001 0011	Readout request of reactive imported energy load profile in format energy consumption per interval
E001 0100	Readout request of input 1 counter load profile in format counter register values at end of intervals
E001 0101	Readout request of input 1 counter load profile in format number of counts per interval
E001 0110	Readout request of input 2 counter load profile in format counter register values at end of intervals
E001 0111	Readout request of input 2 counter load profile in format number of counts per interval

VIFE-code	Description
E001 1000	Readout request of maximum demand
E001 1001	Readout request of previous values
E001 1010	Readout request of event log
E001 1011	Readout request of current harmonics
E001 1100	Readout request of active exported energy load profile in format energy register values at end of intervals
E001 1101	Readout request of active exported energy load profile in format energy consumption per interval
E001 1110	Readout request of reactive exported energy load profile in format energy register values at end of intervals
E001 1111	Readout request of reactive exported energy load profile in format energy consumption per interval
E010 0000	Readout request of apparent imported energy load profile in format energy register values at end of intervals
E010 0001	Readout request of apparent imported energy load profile in format energy consumption per interval
E010 0010	Readout request of apparent exported energy load profile in format energy register values at end of intervals
E010 0011	Readout request of apparent exported energy load profile in format energy consumption per interval
E010 0100	Readout request of input 3 counter load profile in format counter register values at end of intervals
E010 0101	Readout request of input 3 counter load profile in format number of counts per interval
E010 0110	Readout request of input 4 counter load profile in format counter register values at end of intervals
E010 0111	Readout request of input 4 counter load profile in format number of counts per interval
E010 1000	Readout request of current load profile
E010 1001	Readout request of voltage load profile
E010 1010	Readout request of THD voltage load profile
E010 1011	Readout request of THD current load profile
E010 1100	Readout request of power factor load profile
E010 1101	Readout request of voltage harmonics
E010 1110	System log
E010 1111	Audit log
E011 0000	Net quality log

VIFE-code	Description
E011 0001	Settings log
E011 0010	Event log
E011 0011	Event type system log
E011 0100	Event type audit log
E011 0101	Event type net quality log
E011 0110	Event type settings log
E011 0111	Event type event log
E011 0nnn	Energy in CO ₂ (kg * 10 ⁿⁿⁿ⁻⁷)
E011 1nnn	Energy in currency (currency * 10 ⁿⁿⁿ⁻³)

10.1.2.9 2:nd manufacturer specific VIFE followed after VIFE 1111 1110 (FE hex):

VIFE-code	Description
E000 opsl	Data status for load profile, o = overflow, p = power outage during interval, s = short interval, l = long interval

10.1.3 Communication process

General

The Data Link Layer uses two kinds of transmission services:

Send/Confirm	SND/CON
Request/Respond	REQ/RSP

When the meter has received a correct telegram it waits between 35 and 80 ms before it reponds. A telegram is considered as correct if it passes the following tests:

- Start /Parity /Stop bits per character
- Start /Check Sum /Stop characters per telegram format
- In case of a long frame, the number of additional characters received match the L-field (= L Field + 6).
- If the received data is reasonable

The time between a response from the meter and a new message from the master must be at least 20 ms.

Send/confirm procedure

SND_NKE is used to initiate communication with the meter. When the meter has received an NKE followed by a REQ_UD2(see description below), the 1st telegram from the meter is sent out.

If the meter was selected for secondary addressing it will be deselected. The value of the FCB is cleared in the meter, i.e., the meter expects that the first telegram from a master with FCV=1 contains an FCB=1.

The meter can either confirm a correct reception with the single character acknowledge E5h), or it can omit confirmation because it did not receive the telegram correctly.

SND_UD is used to send data to the meter. The meter either confirms reception of a correct message or it omits confirmation because it did not receive the telegram correctly.

Request/respond procedure

REQ_UD2 is used by the master to request data from the meter. **RSP_UD** is used by the meter to transfer data to the master. The meter indicates to the master that more data will follow in the next telegram by sending 1Fh as the last user data.

If the meter does not respond to the REQ_UD2, it's an indication that the message was not received correctly or that the address does not match.

10.1.3.1 Selection and secondary addressing

General

It is possible to communicate with the meter using secondary addressing. The secondary addressing takes place with the help of a selection:

68h	0Bh	0Bh	68h	53h	FDh	52h	ID 1-4	Manu- facturer 1-2	Gener- ation ¹	Me- dium	CS	16h
-----	-----	-----	-----	-----	-----	-----	-----------	--------------------------	------------------------------	-------------	----	-----

1. Generation means the same thing as version.

The master sends a SND_UD with the control information 52h to the address 253 (FDh) and fills the specific meter secondary address fields(identification number, manufacturer, version and medium) with the values of the meter that is to be addressed. The address (FDh) and the control information (52h) is the indication for the meter to compare the following secondary address with its own, and to change into the selected state should it match. In this case the meter answers the selection with an acknowledgement (E5h), otherwise it does not reply. Selected state means that the meter can be addressed with the bus address 253 (FDh).

Wild cards

During selection individual positions of the secondary addresses can be occupied by wildcards. Such a wildcard means that this position will not be taken into account during selection. In the identification number each individual digit can be wild-carded by a wildcard nibble Fh while the fields for manufacturer, version and medium can be wild-carded by a wildcard byte FFh. The meter will remain

selected until it receives a selection command with non-matching secondary addresses, a selection command with CI=56h, or a SND_NKE to address 253.

10.2 Standard Readout of Meter Data

General

This section describes the readout of the default telegrams containing energy and instrumentation values etc. The data readout procedure starts when the master sends a REQ_UD2 telegram to the meter. The meter responds with a RSP_UD telegram. A typical readout is a multi-telegram readout. The last DIF in the user data part of the telegram is 1F to indicate that there is more data in the next telegram, or 0F if there are no more telegrams.

For EQ meters there are up to 7 default telegrams to read. In meters with internal clock more telegrams may follow, containing previous values data. The most recent values are sent out first having storage number 1, then the second most recently stored values with storage number 2 and so on until all stored previous values have been read. If no previous values exist in a meter with internal clock a telegram is sent out where all data is marked with status byte for "No data available".

It is also possible to read previous values starting from a specific date and backwards in time by sending a special read request.



Note – Note: Normally the meter is configured to send out power values as 32 bit integers, expressed in W (or var/VA) with 2 decimals. This means that the maximum power possible to express is approximately ± 21 MW

Below following sections is an example of a readout of the 7 default telegrams and 2 previous values telegrams, containing the most recent snapshot of previous values. Note that these are examples only, data types and scaling of the quantities can differ between meters, as well as the allocation of quantities to different telegrams.

10.2.1 Example of the 1st telegram (all values are hexadecimal)

Byte No.	Size	Value	Description
1	1	68	Start character
2	1	FA	L-field, calculated from C field to last user data
3	1	FA	L-field, repeated
4	1	68	Start character
5	1	08	C-field, RSP_UD
6	1	xx	A-field, address
7	1	72	CI-field, variable data respond, LSB first
8-11	4	xxxxxxx	Identification Number, 8 BCD digits
12-13	2	4204	Manufacturer: ABB
14	1	02	Version
15	1	02	Medium, 02 = Electricity
16	1	xx	Number of accesses
17	1	xx	Status
18-19	2	0000	Signature (0000 = no encryption)

Byte No.	Size	Value	Description
20	1	0E	DIF size, 12 digit BCD
21	1	84	VIF for units kWh with resolution 0,01kWh
22	1	xx	VIFE status
23-28	6	xxxxxxxxxxx	Active imported energy, Total
29	1	8E	DIF size, 12 digit BCD
30	1	10	DIFE, tariff 1
31	1	84	VIF for units kWh with resolution 0,01kWh
32	1	xx	VIFE status
33-38	6	xxxxxxxxxxx	Active imported energy, Tariff 1
39	1	8E	DIF size, 12 digit BCD
40	1	20	DIFE, tariff 2
41	1	84	VIF for units kWh with resolution 0,01kWh
42	1	xx	VIFE status
43-48	6	xxxxxxxxxxx	Active imported energy, Tariff 2
49	1	8E	DIF size, 12 digit BCD
50	1	30	DIFE, tariff 3
51	1	84	VIF for units kWh with resolution 0,01kWh
52	1	xx	VIFE status
53-58	6	xxxxxxxxxxx	Active imported energy, Tariff 3
59	1	8E	DIF size, 12 digit BCD
60	1	80	DIFE,
61	1	10	DIFE, tariff 4
62	1	84	VIF for units kWh with resolution 0,01kWh
63	1	xx	VIFE status
64-69	6	xxxxxxxxxxx	Active imported energy, Tariff 4
70	1	8E	DIF size, 12 digit BCD
71	1	40	DIFE, unit 1
72	1	84	VIF for units kWh with resolution 0,01kWh
73	1	xx	VIFE status
74-79	6	xxxxxxxxxxx	Active exported energy, Total
80	1	8E	DIF size, 12 digit BCD
81	1	50	DIFE, tariff 1, unit 1
82	1	84	VIF for units kWh with resolution 0,01kWh
83	1	xx	VIFE status
84-89	6	xxxxxxxxxxx	Active exported energy, Tariff 1
90	1	8E	DIF size, 12 digit BCD
91	1	60	DIFE, tariff 2, unit 1
92	1	84	VIF for units kWh with resolution 0,01kWh
93	1	xx	VIFE status
94-99	6	xxxxxxxxxxx	Active exported energy, Tariff 2
100	1	8E	DIF size, 12 digit BCD

Byte No.	Size	Value	Description
101	1	70	DIFE, tariff 3, unit 1
102	1	84	VIF for units kWh with resolution 0,01kWh
103	1	xx	VIFE status
104-109	6	xxxxxxxxxxx	Active exported energy, Tariff 3
110	1	8E	DIF size, 12 digit BCD
111	1	C0	DIFE, unit 1
112	1	10	DIFE, tariff 4
113	1	84	VIF for units kWh with resolution 0,01kWh
114	1	xx	VIFE status
115-120	6	xxxxxxxxxxx	Active exported energy, Tariff 4
121	1	01	DIF size, 8 bit integer
122	1	FF	VIF next byte is manufacturer specific
123	1	93	VIFE current tariff
124	1	xx	VIFE status
125	1	xx	Current tariff
126	1	04	DIF size, 32 bit integer
127	1	FF	VIF next byte is manufacturer specific
128	1	A0	VIFE CT ratio numerator
129	1	xx	VIFE status
130-133	4	xxxxxxx	Current transformer ratio numerator
134	1	04	DIF size, 32 bit integer
135	1	FF	VIF next byte is manufacturer specific
136	1	A1	VIFE VT ratio numerator
137	1	xx	VIFE status
138-141	4	xxxxxxx	Voltage transformer ratio numerator
142	1	04	DIF size, 32 bit integer
143	1	FF	VIF next byte is manufacturer specific
144	1	A2	VIFE CT ratio denominator
145	1	xx	VIFE status
146-149	4	xxxxxxx	Current transformer ratio denominator
150	1	04	DIF size, 32 bit integer
151	1	FF	VIF next byte is manufacturer specific
152	1	A3	VIFE VT ratio denominator
153	1	xx	VIFE status
154-157	4	xxxxxxx	Voltage transformer ratio denominator
158	1	07	DIF size, 64 bit integer
159	1	FF	VIF next byte is manufacturer specific
160	1	A6	VIFE error flags (binary)
161	1	xx	VIFE status
162-169	8	xxxxxxxxxxxxxxxx	64 Error flags
170	1	07	DIF size, 64 bit integer

Byte No.	Size	Value	Description
171	1	FF	VIF next byte is manufacturer specific
172	1	A7	VIFE warning flags (binary)
173	1	xx	VIFE status
174-181	8	xxxxxxxxxxxxxxxx	64 Warning flags
182	1	07	DIF size, 64 bit integer
183	1	FF	VIF next byte is manufacturer specific
184	1	A8	VIFE information flags (binary)
185	1	xx	VIFE status
186-193	8	xxxxxxxxxxxxxxxx	64 Information flags
194	1	07	DIF size, 64 bit integer
195	1	FF	VIF next byte is manufacturer specific
196	1	A9	VIFE alarm flags (binary)
197	1	xx	VIFE status
198-205	8	xxxxxxxxxxxxxxxx	64 Alarm flags
206	1	0E	DIF size, 12 digit BCD
207	1	ED	VIF time/date
208	1	xx	VIFE status
209-214	6	xxxxxxxxxxx	Time and date (sec,min,hour,day,month,year)
215	1	01	DIF size, 8 bit integer
216	1	FF	VIF next byte is manufacturer specific
217	1	F9	VIF extension of manufacturer specific VIFE's, next VIFE specifies actual meaning
218	1	81	VIFE DST, day of week, day type, season
219	1	xx	VIFE status
220	1	xx	DST data in bit 0: 1:DST active, 0:DST inactive Day of week data in bit 1-3: 001-111; Monday-Sunday Type of day data in bit 4-5: 00-11; Type of day 1-4 Season data in bit 6-7: 00-11; Season 1-4
221	1	0D	DIF size, variable length, ASCII coding
222	1	FD	VIF extension of VIF-codes
223	1	8E	VIFE Firmware
224	1	xx	VIFE status
225	1	0C*	Byte specifying length, *see note below
226-237	12*	xxxxxxxxxxxxxxxx xxxxxxx	Firmware version (ASCII coded, LSB byte first), *see note below
238	1	0D	DIF size, variable length, ASCII coding
239	1	FF	VIF next byte is manufacturer specific
240	1	AA	VIFE Type designation
241	1	xx	VIFE status
242	1	0B	Byte specifying length
243-253	11	xxxxxxxxxxxxxxxx xxxxx	Type designation (ASCII coded, LSB byte first), for example: A44 552-100
254	1	1F	DIF, more records will follow in next telegram

Byte No.	Size	Value	Description
255	1	xx	CS checksum, calculated from C field to last data
256	1	16	Stop character

10.2.2 Example of 2nd telegram (all values are hexadecimal)

Byte No.	Size	Value	Description
1	1	68	Start character
2	1	FC	L-field, calculated from C field to last user data
3	1	FC	L-field, repeated
4	1	68	Start character
5	1	08	C-field, RSP_UD
6	1	xx	A-field, address
7	1	72	CI-field, variable data respond, LSB first
8-11	4	xxxxxxxx	Identification Number, 8 BCD digits
12-13	2	4204	Manufacturer: ABB
14	1	02	Version
15	1	02	Medium, 02 = Electricity
16	1	xx	Number of accesses
17	1	xx	Status
18-19	2	0000	Signature (0000 = no encryption)
20	1	04	DIF size, 32 bit integer
21	1	FF	VIF next byte is manufacturer specific
22	1	98	VIFE Power fail counter
23	1	xx	VIFE status
24-27	4	xxxxxxxx	Power fail counter
28	1	04	DIF size, 32 bit integer
29	1	A9	VIF for units W with resolution 0,01W
30	1	xx	VIFE status
31-34	4	xxxxxxxx	Active power, Total
35	1	04	DIF size, 32 bit integer
36	1	A9	VIF for units W with resolution 0,01W
37	1	FF	VIFE next byte is manufacturer specific
38	1	81	VIFE L1
39	1	xx	VIFE status
40-43	4	xxxxxxxx	Active power, L1
44	1	04	DIF size, 32 bit integer
45	1	A9	VIF for units W with resolution 0,01W
46	1	FF	VIFE next byte is manufacturer specific
47	1	82	VIFE L2
48	1	xx	VIFE status
49-52	4	xxxxxxxx	Active power, L2
53	1	04	DIF size, 32 bit integer

Byte No.	Size	Value	Description
54	1	A9	VIF for units W with resolution 0,01W
55	1	FF	VIFE next byte is manufacturer specific
56	1	83	VIFE L3
57	1	xx	VIFE status
58-61	4	xxxxxxx	Active power, L3
62	1	84	DIF size, 32 bit integer
63	1	80	DIFE (Unit = 0)
64	1	40	DIFE (Unit = 1, => xx10 (2))
65	1	A9	VIF for units var with resolution 0,01var
66	1	xx	VIFE status
67-70	4	xxxxxxx	Reactive power, Total
71	1	84	DIF size, 32 bit integer
72	1	80	DIFE (Unit = 0)
73	1	40	DIFE (Unit = 1, => xx10 (2))
74	1	A9	VIF for units var with resolution 0,01var
75	1	FF	VIFE next byte is manufacturer specific
76	1	81	VIFE L1
77	1	xx	VIFE status
78-81	4	xxxxxxx	Reactive power, L1
82	1	84	DIF size, 32 bit integer
83	1	80	DIFE (Unit = 0)
84	1	40	DIFE (Unit = 1, => xx10 (2))
85	1	A9	VIF for units var with resolution 0,01var
86	1	FF	VIFE next byte is manufacturer specific
87	1	82	VIFE L2
88	1	xx	VIFE status
89-92	4	xxxxxxx	Reactive power, L2
93	1	84	DIF size, 32 bit integer
94	1	80	DIFE (Unit = 0)
95	1	40	DIFE (Unit = 1, => xx10 (2))
96	1	A9	VIF for units var with resolution 0,01var
97	1	FF	VIFE next byte is manufacturer specific
98	1	83	VIFE L3
99	1	xx	VIFE status
100-103	4	xxxxxxx	Reactive power, L3
104	1	84	DIF size, 32 bit integer
105	1	80	DIFE (Unit = 0)
106	1	80	DIFE (Unit = 0)
107	1	40	DIFE (Unit = 1, => x100 (4))
108	1	A9	VIF for units VA with resolution 0,01VA
109	1	xx	VIFE status

Byte No.	Size	Value	Description
110-113	4	xxxxxxxx	Apparent power, Total
114	1	84	DIF size, 32 bit integer
115	1	80	DIFE (Unit = 0)
116	1	80	DIFE (Unit = 0)
117	1	40	DIFE (Unit = 1, => x100 (4))
118	1	A9	VIF for units VA with resolution 0,01VA
119	1	FF	VIFE next byte is manufacturer specific
120	1	81	VIFE L1
121	1	xx	VIFE status
122-125	4	xxxxxxxx	Apparent power, L1
126	1	84	DIF size, 32 bit integer
127	1	80	DIFE (Unit = 0)
128	1	80	DIFE (Unit = 0)
129	1	40	DIFE (Unit = 1, => x100 (4))
130	1	A9	VIF for units VA with resolution 0,01VA
131	1	FF	VIFE next byte is manufacturer specific
132	1	82	VIFE L2
133	1	xx	VIFE status
134-137	4	xxxxxxxx	Apparent power, L2
138	1	84	DIF size, 32 bit integer
139	1	80	DIFE (Unit = 0)
140	1	80	DIFE (Unit = 0)
141	1	40	DIFE (Unit = 1, => x100 (4))
142	1	A9	VIF for units VA with resolution 0,01VA
143	1	FF	VIFE next byte is manufacturer specific
144	1	83	VIFE L3
145	1	xx	VIFE status
146-149	4	xxxxxxxx	Apparent power, L3
150	1	04	DIF size, 32 bit integer
151	1	FD	VIF extension of VIF-codes
152	1	C8	VIFE for units V with resolution 0,1V
153	1	FF	VIFE next byte is manufacturer specific
154	1	81	VIFE L1
155	1	xx	VIFE status
156-159	4	xxxxxxxx	Voltage L1 - N
160	1	04	DIF size, 32 bit integer
161	1	FD	VIF extension of VIF-codes
162	1	C8	VIFE for units V with resolution 0,1V
163	1	FF	VIFE next byte is manufacturer specific
164	1	82	VIFE L2
165	1	xx	VIFE status

Byte No.	Size	Value	Description
166-169	4	xxxxxxx	Voltage L2 - N
170	1	04	DIF size, 32 bit integer
171	1	FD	VIF extension of VIF-codes
172	1	C8	VIFE for units V with resolution 0,1V
173	1	FF	VIFE next byte is manufacturer specific
174	1	83	VIFE L3
175	1	xx	VIFE status
176-179	4	xxxxxxx	Voltage L3 - N
180	1	04	DIF size, 32 bit integer
181	1	FD	VIF extension of VIF-codes
182	1	C8	VIFE for units V with resolution 0,1V
183	1	FF	VIFE next byte is manufacturer specific
184	1	85	VIFE L1 - L2
185	1	xx	VIFE status
186-189	4	xxxxxxx	Voltage L1 - L2
190	1	04	DIF size, 32 bit integer
191	1	FD	VIF extension of VIF-codes
192	1	C8	VIFE for units V with resolution 0,1V
193	1	FF	VIFE next byte is manufacturer specific
194	1	86	VIFE L2 - L3
195	1	xx	VIFE status
196-199	4	xxxxxxx	Voltage L3 - L2
200	1	04	DIF size, 32 bit integer
201	1	FD	VIF extension of VIF-codes
202	1	C8	VIFE for units V with resolution 0,1V
203	1	FF	VIFE next byte is manufacturer specific
204	1	87	VIFE L1 - L3
205	1	xx	VIFE status
206-209	4	xxxxxxx	Voltage L1 - L3
210	1	04	DIF size, 32 bit integer
211	1	FD	VIF extension of VIF-codes
212	1	DA	VIFE for units A with resolution 0,01A
213	1	FF	VIFE next byte is manufacturer specific
214	1	81	VIFE L1
215	1	xx	VIFE status
216-219	4	xxxxxxx	Current L1
220	1	04	DIF size, 32 bit integer
221	1	FD	VIF extension of VIF-codes
222	1	DA	VIFE for units A with resolution 0,01A
223	1	FF	VIFE next byte is manufacturer specific
224	1	82	VIFE L2

Byte No.	Size	Value	Description
225	1	xx	VIFE status
226-229	4	xxxxxxx	Current L2
230	1	04	DIF size, 32 bit integer
231	1	FD	VIF extension of VIF-codes
232	1	DA	VIFE for units A with resolution 0,01A
233	1	FF	VIFE next byte is manufacturer specific
234	1	83	VIFE L3
235	1	xx	VIFE status
236-239	4	xxxxxxx	Current L3
240	1	04	DIF size, 32 bit integer
241	1	FD	VIF extension of VIF-codes
242	1	DA	VIFE for units A with resolution 0,01A
243	1	FF	VIFE next byte is manufacturer specific
244	1	84	VIFE N
245	1	xx	VIFE status
246-249	4	xxxxxxx	Current N
250	1	0A	DIF size, 4 digit BCD
251	1	FF	VIF next byte is manufacturer specific
252	1	E9	VIFE Frequency with resolution 0.01Hz
253	1	xx	VIFE status
254-255	2	xxxx	Frequency
256	1	1F	DIF more records will follow in next telegram
257	1	xx	CS checksum, calculated from C field to last data
258	1	16	Stop character

10.2.3 Example of 3rd telegram (all values are hexadecimal)

Byte No.	Size	Value	Description
1	1	68	Start character
2	1	F4	L-field, calculated from C field to last user data
3	1	F4	L-field, repeated
4	1	68	Start character
5	1	08	C-field, RSP_UD
6	1	xx	A-field, address
7	1	72	CI-field, variable data respond, LSB first
8-11	4	xxxxxxx	Identification Number, 8 BCD digits
12-13	2	4204	Manufacturer: ABB
14	1	02	Version
15	1	02	Medium, 02 = Electricity
16	1	xx	Number of accesses
17	1	xx	Status
18-19	2	0000	Signature (0000 = no encryption)

Byte No.	Size	Value	Description
20	1	0E	DIF size, 12 digit BCD
21	1	FF	VIF next byte is manufacturer specific
22	1	EC	VIFE Power outage time
23	1	xx	VIFE status
24-29	6	xxxxxxxxxxx	Power outage time (sec, min, hour, days, LSB first)
30	1	02	DIF size, 16 bit integer
31	1	FF	VIF next byte is manufacturer specific
32	1	E0	VIFE power factor with resolution 0,001
33	1	xx	VIFE status
34-35	2	xxxx	Power factor, Total
36	1	02	DIF size, 16 bit integer
37	1	FF	VIF next byte is manufacturer specific
38	1	E0	VIFE power factor with resolution 0,001
39	1	FF	VIFE next byte is manufacturer specific
40	1	81	VIFE L1
41	1	xx	VIFE status
42-43	2	xxxx	Power factor, L1
44	1	02	DIF size, 16 bit integer
45	1	FF	VIF next byte is manufacturer specific
46	1	E0	VIFE power factor with resolution 0,001
47	1	FF	VIFE next byte is manufacturer specific
48	1	82	VIFE L2
49	1	xx	VIFE status
50-51	2	xxxx	Power factor, L2
52	1	02	DIF size, 16 bit integer
53	1	FF	VIF next byte is manufacturer specific
54	1	E0	VIFE power factor with resolution 0,001
55	1	FF	VIFE next byte is manufacturer specific
56	1	83	VIFE L3
57	1	xx	VIFE status
58-59	2	xxxx	Power factor, L3
60	1	02	DIF size, 16 bit integer
61	1	FF	VIF next byte is manufacturer specific
62	1	D2	VIFE phase angle power with resolution 0.1
63	1	xx	VIFE status
64-65	2	xxxx	Phase angle power, Total
66	1	02	DIF size, 16 bit integer
67	1	FF	VIF next byte is manufacturer specific
68	1	D2	VIFE phase angle power with resolution 0.1
69	1	FF	VIFE next byte is manufacturer specific
70	1	81	VIFE L1

Byte No.	Size	Value	Description
71	1	xx	VIFE status
72-73	2	xxxx	Phase angle power, L1
74	1	02	DIF size, 16 bit integer
75	1	FF	VIF next byte is manufacturer specific
76	1	D2	VIFE phase angle power with resolution 0.1
77	1	FF	VIFE next byte is manufacturer specific
78	1	82	VIFE L2
79	1	xx	VIFE status
80-81	2	xxxx	Phase angle power, L2
82	1	02	DIF size, 16 bit integer
83	1	FF	VIF next byte is manufacturer specific
84	1	D2	VIFE phase angle power with resolution 0.1
85	1	FF	VIFE next byte is manufacturer specific
86	1	83	VIFE L3
87	1	xx	VIFE status
88-89	2	xxxx	Phase angle power, L3
90	1	02	DIF size, 16 bit integer
91	1	FF	VIF next byte is manufacturer specific
92	1	C2	VIFE phase angle voltage with resolution 0.1
93	1	FF	VIFE next byte is manufacturer specific
94	1	81	VIFE L1
95	1	xx	VIFE status
96-97	2	xxxx	Phase angle voltage, L1
98	1	02	DIF size, 16 bit integer
99	1	FF	VIF next byte is manufacturer specific
100	1	C2	VIFE phase angle voltage with resolution 0.1
101	1	FF	VIFE next byte is manufacturer specific
102	1	82	VIFE L2
103	1	xx	VIFE status
104-105	2	xxxx	Phase angle voltage, L2
106	1	02	DIF size, 16 bit integer
107	1	FF	VIF next byte is manufacturer specific
108	1	C2	VIFE phase angle voltage with resolution 0.1
109	1	FF	VIFE next byte is manufacturer specific
110	1	83	VIFE L3
111	1	xx	VIFE status
112-113	2	xxxx	Phase angle voltage, L3
114	1	02	DIF size, 16 bit integer
115	1	FF	VIF next byte is manufacturer specific
116	1	CA	VIFE phase angle current with resolution 0.1
117	1	FA	VIFE next byte is manufacturer specific

Byte No.	Size	Value	Description
118	1	81	VIFE L1
119	1	xx	VIFE status
120-121	2	xxxx	Phase angle current, L1
122	1	02	DIF size, 16 bit integer
123	1	FF	VIF next byte is manufacturer specific
124	1	CA	VIFE phase angle current with resolution 0.1
125	1	FF	VIFE next byte is manufacturer specific
126	1	82	VIFE L2
127	1	xx	VIFE status
128-129	2	xxxx	Phase angle current, L2
130	1	02	DIF size, 16 bit integer
131	1	FF	VIF next byte is manufacturer specific
132	1	CA	VIFE phase angle current with resolution 0.1
133	1	FF	VIFE next byte is manufacturer specific
134	1	83	VIFE L3
135	1	xx	VIFE status
136-137	2	xxxx	Phase angle current, L3
138	1	8E	DIF size, 12 digit BCD
139	1	80	DIFE,
140	1	40	DIFE, unit 2
141	1	84	VIF for units kvarh with resolution 0,01kvarh
142	1	xx	VIFE status
143-148	6	xxxxxxxxxxxx	Reactive imported energy, Total
149	1	8E	DIF size, 12 digit BCD
150	1	90	DIFE, tariff 1
151	1	40	DIFE, unit 2
152	1	84	VIF for units kvarh with resolution 0,01kvarh
153	1	xx	VIFE status
154-159	6	xxxxxxxxxxxx	Reactive imported energy, Tariff 1
160	1	8E	DIF size, 12 digit BCD
161	1	A0	DIFE, tariff 2
162	1	40	DIFE, unit 2
163	1	84	VIF for units kvarh with resolution 0,01kvarh
164	1	xx	VIFE status
165-170	6	xxxxxxxxxxxx	Reactive imported energy, Tariff 2
171	1	8E	DIF size, 12 digit BCD
172	1	B0	DIFE, tariff 3
173	1	40	DIFE, unit 2
174	1	84	VIF for units kvarh with resolution 0,01kvarh
175	1	xx	VIFE status
176-181	6	xxxxxxxxxxxx	Reactive imported energy, Tariff 3

Byte No.	Size	Value	Description
182	1	8E	DIF size, 12 digit BCD
183	1	80	DIFE,
184	1	50	DIFE, tariff 4, unit 2
185	1	84	VIF for units kvarh with resolution 0,01kvarh
186	1	xx	VIFE status
187-192	6	xxxxxxxxxxxx	Reactive imported energy, Tariff 4
193	1	8E	DIF size, 12 digit BCD
194	1	C0	DIFE, unit bit 0
195	1	40	DIFE, unit bit 1, unit bit0-1-> unit 3
196	1	84	VIF for units kvarh with resolution 0,01kvarh
197	1	xx	VIFE status
198-203	6	xxxxxxxxxxxx	Reactive exported energy, Total
204	1	8E	DIF size, 12 digit BCD
205	1	D0	DIFE, tariff 1, unit bit 0
206	1	40	DIFE, unit bit 1, unit bit 0-1-> unit 3
207	1	84	VIF for units kvarh with resolution 0,01kvarh
208	1	xx	VIFE status
209-214	6	xxxxxxxxxxxx	Reactive exported energy, Tariff 1
215	1	8E	DIF size, 12 digit BCD
216	1	E0	DIFE, tariff 2, unit bit 0
217	1	40	DIFE, unit bit 1, unit bit 0-1-> unit 3
218	1	84	VIF for units kvarh with resolution 0,01kvarh
219	1	xx	VIFE status
220-225	6	xxxxxxxxxxxx	Reactive exported energy, Tariff 2
226	1	8E	DIF size, 12 digit BCD
227	1	F0	DIFE, tariff 3, unit bit 0
228	1	40	DIFE, unit bit 1, unit bit 0-1-> unit 3
229	1	84	VIF for units kvarh with resolution 0,01kvarh
230	1	xx	VIFE status
231-236	6	xxxxxxxxxxxx	Reactive exported energy, Tariff 3
237	1	8E	DIF size, 12 digit BCD
238	1	C0	DIFE, unit bit 0
239	1	50	DIFE, tariff 4, unit bit 1, unit bit 0-1-> unit 3
240	1	84	VIF for units kvarh with resolution 0,01kvarh
241	1	xx	VIFE status
242-247	6	xxxxxxxxxxxx	Reactive exported energy, Tariff 4
248	1	1F	DIF, more records will follow in next telegram
249	1	xx	CS checksum, calculated from C field to last data
250	1	16	Stop character

10.2.4 Example of the 4th telegram (all values are hexadecimal)

Byte No.	Size	Value	Description
1	1	68	Start character
2	1	AE	L-field, calculated from C field to last user data
3	1	AE	L-field, repeated
4	1	68	Start character
5	1	08	C-field, RSP_UD
6	1	xx	A-field, address
7	1	72	CI-field, variable data respond, LSB first
8-11	4	xxxxxxx	Identification Number, 8 BCD digits
12-13	2	4204	Manufacturer: ABB
14	1	02	Version
15	1	02	Medium, 02 = Electricity
16	1	xx	Number of accesses
17	1	xx	Status
18-19	2	0000	Signature (0000 = no encryption)
20	1	01	DIF size, 8 bit integer
21	1	FF	VIF next byte is manufacturer specific
22	1	97	VIFE current quadrant
23	1	xx	VIFE status
24	1	xx	Current quadrant, total
25	1	01	DIF size, 8 bit integer
26	1	FF	VIF next byte is manufacturer specific
27	1	97	VIFE current quadrant
28	1	FF	VIF next byte is manufacturer specific
29	1	81	VIFE L1
30	1	xx	VIFE status
31	1	xx	Current quadrant, L1
32	1	01	DIF size, 8 bit integer
33	1	FF	VIF next byte is manufacturer specific
34	1	97	VIFE current quadrant
35	1	FF	VIF next byte is manufacturer specific
36	1	82	VIFE L2
37	1	xx	VIFE status
38	1	xx	Current quadrant, L2
39	1	01	DIF size, 8 bit integer
40	1	FF	VIF next byte is manufacturer specific
41	1	97	VIFE current quadrant
42	1	FF	VIF next byte is manufacturer specific
43	1	83	VIFE L3
44	1	xx	VIFE status
45	1	xx	Current quadrant, L3

Byte No.	Size	Value	Description
46	1	81	DIF size, 8 bit integer
47	1	40	DIFE (Unit = 1)
48	1	FD	VIF extension of VIF-codes
49	1	9A	VIFE digital output
50	1	xx	VIFE status
51	1	xx	Output 1, current state
52	1	81	DIF size, 8 bit integer
53	1	80	DIFE,
54	1	40	DIFE (Unit = 2)
55	1	FD	VIF extension of VIF-codes
56	1	9A	VIFE digital output
57	1	xx	VIFE status
58	1	xx	Output 2, current state
59	1	81	DIF size, 8 bit integer
60	1	C0	DIFE (Unit = 1)
61	1	40	DIFE (Unit = 2)
62	1	FD	VIF extension of VIF-codes
63	1	9A	VIFE digital output
64	1	xx	VIFE status
65	1	xx	Output 3, current state
66	1	81	DIF size, 8 bit integer
67	1	80	DIFE,
68	1	80	DIFE,
69	1	40	DIFE (Unit = 4)
70	1	FD	VIF extension of VIF-codes
71	1	9A	VIFE digital output
72	1	xx	VIFE status
73	1	xx	Output 4, current state
74	1	81	DIF size, 8 bit integer
75	1	40	DIFE (Unit = 1)
76	1	FD	VIF extension of VIF-codes
77	1	9B	VIFE digital input
78	1	xx	VIFE status
79	1	xx	Input 1 current state
80	1	81	DIF size, 8 bit integer
81	1	80	DIFE,
82	1	40	DIFE (Unit = 2)
83	1	FD	VIF extension of VIF-codes
84	1	9B	VIFE digital input
85	1	xx	VIFE status
86	1	xx	Input 2 current state

Byte No.	Size	Value	Description
87	1	81	DIF size, 8 bit integer
88	1	C0	DIFE (Unit = 1)
89	1	40	DIFE (Unit = 2)
90	1	FD	VIF extension of VIF-codes
91	1	9B	VIFE digital input
92	1	xx	VIFE status
93	1	xx	Input 3 current state
94	1	81	DIF size, 8 bit integer
95	1	80	DIFE,
96	1	80	DIFE,
97	1	40	DIFE (Unit = 4)
98	1	FD	VIF extension of VIF-codes
99	1	9B	VIFE digital input
100	1	xx	VIFE status
101	1	xx	Input 4 current state
102	1	C1	DIF size, 8 bit integer, storage number 1
103	1	40	DIFE (Unit = 1)
104	1	FD	VIF extension of VIF-codes
105	1	9B	VIFE digital input
106	1	xx	VIFE status
107	1	xx	Input 1, stored state (1 if current state has been 1)
108	1	C1	DIF size, 8 bit integer, storage number 1
109	1	80	DIFE,
110	1	40	DIFE (Unit = 2)
111	1	FD	VIF extension of VIF-codes
112	1	9B	VIFE digital input
113	1	xx	VIFE status
114	1	xx	Input 2, stored state (1 if current state has been 1)
115	1	C1	DIF size, 8 bit integer, storage number 1
116	1	C0	DIFE (Unit = 1)
117	1	40	DIFE (Unit = 2)
118	1	FD	VIF extension of VIF-codes
119	1	9B	VIFE digital input
120	1	xx	VIFE status
121	1	xx	Input 3, stored state (1 if current state has been 1)
122	1	C1	DIF size, 8 bit integer, storage number 1
123	1	80	DIFE,
124	1	80	DIFE,
125	1	40	DIFE (Unit = 4)
126	1	FD	VIF extension of VIF-codes
127	1	9B	VIFE digital input

Byte No.	Size	Value	Description
128	1	xx	VIFE status
129	1	xx	Input 4, stored state (1 if current state has been 1)
130	1	8E	DIF size, 12 digit BCD
131	1	40	DIFE (Unit = 1)
132	1	FD	VIF extension of VIF-codes
133	1	E1	VIFE cumulating counter
134	1	xx	VIFE status
135-140	6	xxxxxxxxxxxx	Counter 1 (input 1)
141	1	8E	DIF size, 12 digit BCD
142	1	80	DIFE,
143	1	40	DIFE (Unit = 2)
144	1	FD	VIF extension of VIF-codes
145	1	E1	VIFE cumulating counter
146	1	xx	VIFE status
147-152	6	xxxxxxxxxxxx	Counter 2 (input 2)
153	1	8E	DIF size, 12 digit BCD
154	1	C0	DIFE (Unit = 1)
155	1	40	DIFE (Unit = 2)
156	1	FD	VIF extension of VIF-codes
157	1	E1	VIFE cumulating counter
158	1	xx	VIFE status
159-164	6	xxxxxxxxxxxx	Counter 3 (input 3)
165	1	8E	DIF size, 12 digit BCD
166	1	80	DIFE,
167	1	80	DIFE,
168	1	40	DIFE (Unit = 4)
169	1	FD	VIF extension of VIF-codes
170	1	E1	VIFE cumulating counter
171	1	xx	VIFE status
172-177	6	xxxxxxxxxxxx	Counter 4 (input 4)
178	1	1F	DIF, more records will follow in next telegram
179	1	xx	CS checksum, calculated from C field to last data
180	1	16	Stop character

10.2.5 Example of the 5th telegram (all values are hexadecimal)

Byte No.	Size	Value	Description
1	1	68	Start character
2	1	A4	L-field, calculated from C field to last user data
3	1	A4	L-field, repeated
4	1	68	Start character
5	1	08	C-field, RSP_UD

Byte No.	Size	Value	Description
6	1	xx	A-field, address
7	1	72	CI-field, variable data respond, LSB first
8-11	4	xxxxxxx	Identification Number, 8 BCD digits
12-13	2	4204	Manufacturer: ABB
14	1	02	Version
15	1	02	Medium, 02 = Electricity
16	1	xx	Number of accesses
17	1	xx	Status
18-19	2	0000	Signature (0000 = no encryption)
20	1	0E	DIF size, 12 digit BCD
21	1	84	VIF for units kWh with resolution 0,01kWh
22	1	FF	VIFE next byte is manufacturer specific
23	1	F2	VIFE resettable energy
24	1	xx	VIFE status
25-30	6	xxxxxxxxxxx	Resettable active imported energy, Total
31	1	8E	DIF size, 12 digit BCD
32	1	40	DIFE (Unit = 1)
33	1	84	VIF for units kWh with resolution 0,01kWh
34	1	FF	VIFE next byte is manufacturer specific
35	1	F2	VIFE resettable energy
36	1	xx	VIFE status
37-42	6	xxxxxxxxxxx	Resettable active exported energy, Total
43	1	8E	DIF size, 12 digit BCD
44	1	80	DIFE
45	1	40	DIFE (Unit = 2)
46	1	84	VIF for units kvarh with resolution 0,01kvarh
47	1	FF	VIFE next byte is manufacturer specific
48	1	F2	VIFE resettable energy
49	1	xx	VIFE status
50-55	6	xxxxxxxxxxx	Resettable reactive imported energy, Total
56	1	8E	DIF size, 12 digit BCD
57	1	C0	DIFE (Unit = 1)
58	1	40	DIFE (Unit = 2)
59	1	84	VIF for units kvar with resolution 0,01kvarh
60	1	FF	VIFE next byte is manufacturer specific
61	1	F2	VIFE resettable energy
62	1	xx	VIFE status
63-68	6	xxxxxxxxxxx	Resettable reactive exported energy, Total
69	1	04	DIF size, 32 bit integer
70	1	FF	VIFE next byte is manufacturer specific
71	1	F1	VIFE reset counter

Byte No.	Size	Value	Description
72	1	xx	VIFE status
73-76	4	xxxxxxx	Reset counter for active imported energy, Total
77	1	84	DIF size, 32 bit integer
78	1	40	DIFE (Unit = 1)
79	1	FF	VIFE next byte is manufacturer specific
80	1	F1	VIFE reset counter
81	1	xx	VIFE status
82-85	4	xxxxxxx	Reset counter for active exported energy, Total
86	1	84	DIF size, 32 bit integer
87	1	80	DIFE
88	1	40	DIFE (Unit = 2)
89	1	FF	VIFE next byte is manufacturer specific
90	1	F1	VIFE reset counter
91	1	xx	VIFE status
92-95	4	xxxxxxx	Reset counter for reactive imported energy, Total
96	1	84	DIF size, 32 bit integer
97	1	C0	DIFE (Unit = 1)
98	1	40	DIFE (Unit = 2)
99	1	FF	VIFE next byte is manufacturer specific
100	1	F1	VIFE reset counter
101	1	xx	VIFE status
102-105	4	xxxxxxx	Reset counter for reactive exported energy, Total
106	1	0E	DIF size, 12 digit BCD
107	1	FF	VIFE next byte is manufacturer specific
108	1	F9	VIF extension of manufacturer specific VIFE's
109	1	C4	Energy in CO2 with resolution 0,001 kg
110	1	xx	VIFE status
111-116	6	xxxxxxxxxxx	CO2 for active imported energy, Total
117	1	0E	DIF size, 12 digit BCD
118	1	FF	VIFE next byte is manufacturer specific
119	1	F9	VIF extension of manufacturer specific VIFE's
120	1	C9	Energy in Currency with resolution 0,01 currency
121	1	xx	VIFE status
122-127	6	xxxxxxxxxxx	Currency for active imported energy, Total
128	1	04	DIF size, 32 bit integer
129	1	FF	VIFE next byte is manufacturer specific
130	1	A4	CO2 conversion factor in g/kWh
131	1	xx	VIFE status
132-133	4	xxxxxxx	CO2 conversion factor for active energy
134	1	04	DIF size, 32 bit integer
135	1	FF	VIFE next byte is manufacturer specific

Byte No.	Size	Value	Description
136	1	A5	Currency conversion factor in 0,001 currency/kWh
137	1	xx	VIFE status
138-143	4	xxxxxxx	Currency conversion factor for active energy
144	1	8E	DIF size, 12 digit BCD
145	1	80	DIFE
146	1	80	DIFE
147	1	40	DIFE, Unit 4
148	1	84	VIF for unit kVAh with resolution 0,01kVAh
149	1	xx	VIFE status
150-155	6	xxxxxxxxxxx	Apparent imported energy, Total
156	1	8E	DIF size, 12 digit BCD
157	1	C0	DIFE, Unit bit 0
158	1	80	DIFE, Unit bit 1
159	1	40	DIFE, Unit bit 2, Unit bit 0-2 -> Unit 5
160	1	84	VIF for unit kVAh with resolution 0,01kVAh
161	1	xx	VIFE status
162-167	6	xxxxxxxxxxx	Apparent exported energy, Total
168	1	1F	DIF, more records will follow in next telegram
169	1	xx	CS checksum, calculated from C field to last data
170	1	16	Stop character

10.2.6 Example of the 6th telegram (all values are hexadecimal)

Byte No.	Size	Value	Description
1	1	68	Start character
2	1	F7	L-field, calculated from C field to last user data
3	1	F7	L-field, repeated
4	1	68	Start character
5	1	08	C-field, RSP_UD
6	1	xx	A-field, address
7	1	72	CI-field, variable data respond, LSB first
8-11	4	xxxxxxx	Identification Number, 8 BCD digits
12-13	2	4204	Manufacturer: ABB
14	1	02	Version
15	1	02	Medium, 02 = Electricity
16	1	xx	Number of accesses
17	1	xx	Status
18-19	2	0000	Signature (0000 = no encryption)
20	1	0E	DIF size, 12 digit BCD
21	1	84	VIF for units kWh with resolution 0,01kWh
22	1	FF	VIFE next byte is manufacturer specific
23	1	81	VIFE L1

Byte No.	Size	Value	Description
24	1	xx	VIFE status
25-30	6	xxxxxxxxxxxx	Active imported energy, L1
31	1	0E	DIF size, 12 digit BCD
32	1	84	VIF for units kWh with resolution 0,01kWh
33	1	FF	VIFE next byte is manufacturer specific
34	1	82	VIFE L2
35	1	xx	VIFE status
36-41	6	xxxxxxxxxxxx	Active imported energy, L2
42	1	0E	DIF size, 12 digit BCD
43	1	84	VIF for units kWh with resolution 0,01kWh
44	1	FF	VIFE next byte is manufacturer specific
45	1	83	VIFE L3
46	1	xx	VIFE status
47-52	6	xxxxxxxxxxxx	Active imported energy, L3
53	1	8E	DIF size, 12 digit BCD
54	1	80	DIFE
55	1	40	DIFE, Unit 2
56	1	84	VIF for units kvarh with resolution 0,01 kvarh
57	1	FF	VIFE next byte is manufacturer specific
58	1	81	VIFE L1
59	1	xx	VIFE status
60-65	6	xxxxxxxxxxxx	Reactive imported energy, L1
66	1	8E	DIF size, 12 digit BCD
67	1	80	DIFE
68	1	40	DIFE, Unit 2
69	1	84	VIF for units kvarh with resolution 0,01 kvarh
70	1	FF	VIFE next byte is manufacturer specific
71	1	82	VIFE L2
72	1	xx	VIFE status
73-78	6	xxxxxxxxxxxx	Reactive imported energy, L2
79	1	8E	DIF size, 12 digit BCD
80	1	80	DIFE
81	1	40	DIFE, Unit 2
82	1	84	VIF for units kvarh with resolution 0,01 kvarh
83	1	FF	VIFE next byte is manufacturer specific
84	1	83	VIFE L3
85	1	xx	VIFE status
86-91	6	xxxxxxxxxxxx	Reactive imported energy, L3
92	1	8E	DIF size, 12 digit BCD
93	1	80	DIFE
94	1	80	DIFE

Byte No.	Size	Value	Description
95	1	40	DIFE, Unit 4
96	1	84	VIF for unit kVAh with resolution 0,01kVAh
97	1	FF	VIFE next byte is manufacturer specific
98	1	81	VIFE L1
99	1	xx	VIFE status
100-105	6	xxxxxxxxxxx	Apparent imported energy, L1
106	1	8E	DIF size, 12 digit BCD
107	1	80	DIFE
108	1	80	DIFE
109	1	40	DIFE, Unit 4
110	1	84	VIF for unit kVAh with resolution 0,01kVAh
111	1	FF	VIFE next byte is manufacturer specific
112	1	82	VIFE L2
113	1	xx	VIFE status
114-119	6	xxxxxxxxxxx	Apparent imported energy, L2
120	1	8E	DIF size, 12 digit BCD
121	1	80	DIFE
122	1	80	DIFE
123	1	40	DIFE, Unit 4
124	1	84	VIF for unit kVAh with resolution 0,01kVAh
125	1	FF	VIFE next byte is manufacturer specific
126	1	83	VIFE L3
127	1	xx	VIFE status
128-133	6	xxxxxxxxxxx	Apparent imported energy, L3
134	1	8E	DIF size, 12 digit BCD
135	1	40	DIFE, Unit 1
136	1	84	VIF for units kWh with resolution 0,01kWh
137	1	FF	VIFE next byte is manufacturer specific
138	1	81	VIFE L1
139	1	xx	VIFE status
140-145	6	xxxxxxxxxxx	Active exported energy, L1
146	1	8E	DIF size, 12 digit BCD
147	1	40	DIFE, Unit 1
148	1	84	VIF for units kWh with resolution 0,01kWh
149	1	FF	VIFE next byte is manufacturer specific
150	1	82	VIFE L2
151	1	xx	VIFE status
152-157	6	xxxxxxxxxxx	Active exported energy, L2
158	1	8E	DIF size, 12 digit BCD
159	1	40	DIFE, Unit 1
160	1	84	VIF for units kWh with resolution 0,01kWh

Byte No.	Size	Value	Description
161	1	FF	VIFE next byte is manufacturer specific
162	1	83	VIFE L3
163	1	xx	VIFE status
164-169	6	xxxxxxxxxxxx	Active exported energy, L3
170	1	8E	DIF size, 12 digit BCD
171	1	C0	DIFE, Unit bit 0
172	1	40	DIFE, Unit bit 1, unit bit0-1-> unit 3
173	1	84	VIF for units kvarh with resolution 0,01 kvarh
174	1	FF	VIFE next byte is manufacturer specific
175	1	81	VIFE L1
176	1	xx	VIFE status
177-182	6	xxxxxxxxxxxx	Reactive exported energy, L1
183	1	8E	DIF size, 12 digit BCD
184	1	C0	DIFE, Unit bit 0
185	1	40	DIFE, Unit bit 1, unit bit0-1-> unit 3
186	1	84	VIF for units kvarh with resolution 0,01 kvarh
187	1	FF	VIFE next byte is manufacturer specific
188	1	82	VIFE L2
189	1	xx	VIFE status
190-195	6	xxxxxxxxxxxx	Reactive exported energy, L2
196	1	8E	DIF size, 12 digit BCD
197	1	C0	DIFE, Unit bit 0
198	1	40	DIFE, Unit bit 1, unit bit0-1-> unit 3
199	1	84	VIF for units kvarh with resolution 0,01 kvarh
200	1	FF	VIFE next byte is manufacturer specific
201	1	83	VIFE L3
202	1	xx	VIFE status
203-208	6	xxxxxxxxxxxx	Reactive exported energy, L3
209	1	8E	DIF size, 12 digit BCD
210	1	C0	DIFE, Unit bit 0
211	1	80	DIFE, Unit bit 1
212	1	40	DIFE, Unit bit 2, unit bit0-2-> unit 5
213	1	84	VIF for unit kVAh with resolution 0,01kVAh
214	1	FF	VIFE next byte is manufacturer specific
215	1	81	VIFE L1
216	1	xx	VIFE status
217-222	6	xxxxxxxxxxxx	Apparent exported energy, L1
223	1	8E	DIF size, 12 digit BCD
224	1	C0	DIFE, Unit bit 0
225	1	80	DIFE, Unit bit 1
226	1	40	DIFE, Unit bit 2, unit bit0-2-> unit 5

Byte No.	Size	Value	Description
227	1	84	VIF for unit kVAh with resolution 0,01kVAh
228	1	FF	VIFE next byte is manufacturer specific
229	1	82	VIFE L2
230	1	xx	VIFE status
231-236	6	xxxxxxxxxxx	Apparent exported energy, L2
237	1	8E	DIF size, 12 digit BCD
238	1	C0	DIFE, Unit bit 0
239	1	80	DIFE, Unit bit 1
240	1	40	DIFE, Unit bit 2, unit bit0-2-> unit 5
241	1	84	VIF for unit kVAh with resolution 0,01kVAh
242	1	FF	VIFE next byte is manufacturer specific
243	1	83	VIFE L3
244	1	xx	VIFE status
245-250	6	xxxxxxxxxxx	Apparent exported energy, L3
251	1	1F	DIF, more records will follow in next telegram
252	1	xx	CS checksum, calculated from C field to last data
253	1	16	Stop character

10.2.7 Example of the 7th telegram (all values are hexadecimal)

Byte No.	Size	Value	Description
1	1	68	Start character
2	1	B6	L-field, calculated from C field to last user data
3	1	B6	L-field, repeated
4	1	68	Start character
5	1	08	C-field, RSP_UD
6	1	xx	A-field, address
7	1	72	CI-field, variable data respond, LSB first
8-11	4	xxxxxxx	Identification Number, 8 BCD digits
12-13	2	4204	Manufacturer: ABB
14	1	02	Version
15	1	02	Medium, 02 = Electricity
16	1	xx	Number of accesses
17	1	xx	Status
18-19	2	0000	Signature (0000 = no encryption)
20	1	8E	DIF size, 12 digit BCD
21	1	80	DIFE
22	1	C0	DIFE, Unit 2
23	1	40	DIFE, Unit 4
24	1	84	VIF for unit kWh with resolution 0,01kWh
25	1	xx	VIFE status
26-31	6	xxxxxxxxxxx	Active net energy, Total

Byte No.	Size	Value	Description
32	1	8E	DIF size, 12 digit BCD
33	1	80	DIFE
34	1	C0	DIFE, Unit 2
35	1	40	DIFE, Unit 4
36	1	84	VIF for unit kWh with resolution 0,01kWh
37	1	FF	VIFE next byte is manufacturer specific
38	1	81	VIFE L1
39	1	xx	VIFE status
40-45	6	xxxxxxxxxxxx	Active net energy, L1
46	1	8E	DIF size, 12 digit BCD
47	1	80	DIFE
48	1	C0	DIFE, Unit 2
49	1	40	DIFE, Unit 4
50	1	84	VIF for unit kWh with resolution 0,01kWh
51	1	FF	VIFE next byte is manufacturer specific
52	1	82	VIFE L2
53	1	xx	VIFE status
54-59	6	xxxxxxxxxxxx	Active net energy, L2
60	1	8E	DIF size, 12 digit BCD
61	1	80	DIFE
62	1	C0	DIFE, Unit 2
63	1	40	DIFE, Unit 4
64	1	84	VIF for unit kWh with resolution 0,01kWh
65	1	FF	VIFE next byte is manufacturer specific
66	1	83	VIFE L3
67	1	xx	VIFE status
68-73	6	xxxxxxxxxxxx	Active net energy, L3
74	1	8E	DIF size, 12 digit BCD
75	1	C0	DIFE, Unit 1
76	1	C0	DIFE, Unit 2
77	1	40	DIFE, Unit 4
78	1	84	VIF for unit kvarh with resolution 0,01kvarh
79	1	xx	VIFE status
80-85	6	xxxxxxxxxxxx	Reactive net energy, Total
86	1	8E	DIF size, 12 digit BCD
87	1	C0	DIFE, Unit 1
88	1	C0	DIFE, Unit 2
89	1	40	DIFE, Unit 4
90	1	84	VIF for unit kvarh with resolution 0,01kvarh
91	1	FF	VIFE next byte is manufacturer specific
92	1	81	VIFE L1

Byte No.	Size	Value	Description
93	1	xx	VIFE status
94-99	6	xxxxxxxxxxxx	Reactive net energy, L1
100	1	8E	DIF size, 12 digit BCD
101	1	C0	DIFE, Unit 1
102	1	C0	DIFE, Unit 2
103	1	40	DIFE, Unit 4
104	1	84	VIF for unit kvarh with resolution 0,01kvarh
105	1	FF	VIFE next byte is manufacturer specific
106	1	82	VIFE L2
107	1	xx	VIFE status
108-113	6	xxxxxxxxxxxx	Reactive net energy, L2
114	1	8E	DIF size, 12 digit BCD
115	1	C0	DIFE, Unit 1
116	1	C0	DIFE, Unit 2
117	1	40	DIFE, Unit 4
118	1	84	VIF for unit kvarh with resolution 0,01kvarh
119	1	FF	VIFE next byte is manufacturer specific
120	1	83	VIFE L3
121	1	xx	VIFE status
122-127	6	xxxxxxxxxxxx	Reactive net energy, L3
128	1	8E	DIF size, 12 digit BCD
129	1	80	DIFE
130	1	80	DIFE
131	1	80	DIFE
132	1	40	DIFE, Unit 8
133	1	84	VIF for unit kVAh with resolution 0,01kVAh
134	1	xx	VIFE status
135-140	6	xxxxxxxxxxxx	Apparent net energy, Total
141	1	8E	DIF size, 12 digit BCD
142	1	80	DIFE
143	1	80	DIFE
144	1	80	DIFE
145	1	40	DIFE, Unit 8
146	1	84	VIF for unit kVAh with resolution 0,01kVAh
147	1	FF	VIFE next byte is manufacturer specific
148	1	81	VIFE L1
149	1	xx	VIFE status
150-155	6	xxxxxxxxxxxx	Apparent net energy, L1
156	1	8E	DIF size, 12 digit BCD
157	1	80	DIFE
158	1	80	DIFE

Byte No.	Size	Value	Description
159	1	80	DIFE
160	1	40	DIFE, Unit 8
161	1	84	VIF for unit kVAh with resolution 0,01kVAh
162	1	FF	VIFE next byte is manufacturer specific
163	1	82	VIFE L2
164	1	xx	VIFE status
165-170	6	xxxxxxxxxxxx	Apparent net energy, L2
171	1	8E	DIF size, 12 digit BCD
172	1	80	DIFE
173	1	80	DIFE
174	1	80	DIFE
175	1	40	DIFE, Unit 8
176	1	84	VIF for unit kVAh with resolution 0,01kVAh
177	1	FF	VIFE next byte is manufacturer specific
178	1	83	VIFE L3
179	1	xx	VIFE status
180-185	6	xxxxxxxxxxxx	Apparent net energy, L3
186	1	1F	DIF, more records will follow in next telegram
187	1	xx	CS checksum, calculated from C field to last data
188	1	16	Stop character

10.2.8 Example of the 8th telegram (all values are hexadecimal)

This example telegram contains the most recent snapshot of previous values.

Byte No.	Size	Value	Description
1	1	68	Start character
2	1	DE	L-field, calculated from C field to last user data
3	1	DE	L-field, repeated
4	1	68	Start character
5	1	08	C-field, RSP_UD
6	1	xx	A-field, address
7	1	72	CI-field, variable data respond, LSB first
8-11	4	xxxxxxx	Identification Number, 8 BCD digits
12-13	2	4204	Manufacturer: ABB
14	1	02	Version
15	1	02	Medium, 02 = Electricity
16	1	xx	Number of accesses
17	1	xx	Status
18-19	2	0000	Signature (0000 = no encryption)
20	1	CE	DIF size, 12 digit BCD, storage number bit 0
21	1	00	DIFE, storage number bit 1-4
22	1	ED	VIF for time/date point

Byte No.	Size	Value	Description
23	1	E8	VIFE indicating end of period
24	1	xx	VIFE status
25-30	6	xxxxxxxxxxxx	Time and date (sec,min,hour,day,month,year)
31	1	4E	DIF size, 12 digit BCD, storage number bit 0
32	1	84	VIF for units kWh with resolution 0,01kWh
33	1	xx	VIFE status
34-39	6	xxxxxxxxxxxx	Active imported energy, Total
40	1	CE	DIF size, 12 digit BCD, storage number bit 0
41	1	40	DIFE, Unit 1
42	1	84	VIF for units kWh with resolution 0,01kWh
43	1	xx	VIFE status
44-49	6	xxxxxxxxxxxx	Active exported energy, Total
50	1	CE	DIF size, 12 digit BCD, storage number bit 0
51	1	80	DIFE,
52	1	40	DIFE, unit 2
53	1	84	VIF for units kvarh with resolution 0,01kvarh
54	1	xx	VIFE status
55-60	6	xxxxxxxxxxxx	Reactive imported energy, Total
61	1	CE	DIF size, 12 digit BCD, storage number bit 0
62	1	C0	DIFE, unit 1
63	1	40	DIFE, unit 2
64	1	84	VIF for units kvarh with resolution 0,01kvarh
65	1	xx	VIFE status
66-71	6	xxxxxxxxxxxx	Reactive exported energy, Total
72	1	4E	DIF size, 12 digit BCD, storage number bit 0
73	1	84	VIF for units kWh with resolution 0,01kWh
74	1	FF	VIFE next byte is manufacturer specific
75	1	81	VIFE L1
76	1	xx	VIFE status
77-82	6	xxxxxxxxxxxx	Active imported energy, L1
83	1	4E	DIF size, 12 digit BCD, storage number bit 0
84	1	84	VIF for units kWh with resolution 0,01kWh
85	1	FF	VIFE next byte is manufacturer specific
86	1	82	VIFE L2
87	1	xx	VIFE status
88-93	6	xxxxxxxxxxxx	Active imported energy, L2
94	1	4E	DIF size, 12 digit BCD, storage number bit 0
95	1	84	VIF for units kWh with resolution 0,01kWh
96	1	FF	VIFE next byte is manufacturer specific
97	1	83	VIFE L3
98	1	xx	VIFE status

Byte No.	Size	Value	Description
99-104	6	xxxxxxxxxxxx	Active imported energy, L3
105	1	CE	DIF size, 12 digit BCD, storage number bit 0
106	1	40	DIFE, Unit 1
107	1	84	VIF for units kWh with resolution 0,01kWh
108	1	FF	VIFE next byte is manufacturer specific
109	1	81	VIFE L1
110	1	xx	VIFE status
111-116	6	xxxxxxxxxxxx	Active exported energy, L1
117	1	CE	DIF size, 12 digit BCD, storage number bit 0
118	1	40	DIFE, Unit 1
119	1	84	VIF for units kWh with resolution 0,01kWh
120	1	FF	VIFE next byte is manufacturer specific
121	1	82	VIFE L2
122	1	xx	VIFE status
123-128	6	xxxxxxxxxxxx	Active exported energy, L2
129	1	CE	DIF size, 12 digit BCD, storage number bit 0
130	1	40	DIFE, Unit 1
131	1	84	VIF for units kWh with resolution 0,01kWh
132	1	FF	VIFE next byte is manufacturer specific
133	1	83	VIFE L3
134	1	xx	VIFE status
135-140	6	xxxxxxxxxxxx	Active exported energy, L3
141	1	CE	DIF size, 12 digit BCD, storage number bit 0
142	1	10	DIFE, tariff 1, storage number bit 1-4
143	1	84	VIF for units kWh with resolution 0,01kWh
144	1	xx	VIFE status
145-150	6	xxxxxxxxxxxx	Active imported energy, tariff 1
151	1	CE	DIF size, 12 digit BCD, storage number bit 0
152	1	20	DIFE, tariff 2, storage number bit 1-4
153	1	84	VIF for units kWh with resolution 0,01kWh
154	1	xx	VIFE status
155-160	6	xxxxxxxxxxxx	Active imported energy, tariff 2
161	1	CE	DIF size, 12 digit BCD, storage number bit 0
162	1	30	DIFE, tariff 3, storage number bit 1-4
163	1	84	VIF for units kWh with resolution 0,01kWh
164	1	xx	VIFE status
165-170	6	xxxxxxxxxxxx	Active imported energy, tariff 3
171	1	CE	DIF size, 12 digit BCD, storage number bit 0
172	1	80	DIFE, tariff bits 0-1, storage number bit 1-4
173	1	10	DIFE, tariff bits 2-3, tariff 4
174	1	84	VIF for units kWh with resolution 0,01kWh

Byte No.	Size	Value	Description
175	1	xx	VIFE status
176-181	6	xxxxxxxxxxx	Active imported energy, tariff 4
182	1	CE	DIF size, 12 digit BCD, storage number bit 0
183	1	90	DIFE, tariff 1, storage number bit 1-4, unit bit 0
184	1	40	DIFE, unit bit 1
185	1	84	VIF for units kvarh with resolution 0,01kvarh
186	1	xx	VIFE status
187-192	6	xxxxxxxxxxx	Reactive imported energy, tariff 1
193	1	CE	DIF size, 12 digit BCD, storage number bit 0
194	1	A0	DIFE, tariff 2, storage number bit 1-4, unit bit 0
195	1	40	DIFE, unit bit 1
196	1	84	VIF for units kvarh with resolution 0,01kvarh
197	1	xx	VIFE status
198-203	6	xxxxxxxxxxx	Reactive imported energy, tariff 2
204	1	CE	DIF size, 12 digit BCD, storage number bit 0
205	1	B0	DIFE, tariff 3, storage number bit 1-4, unit bit 0
206	1	40	DIFE, unit bit 1
207	1	84	VIF for units kvarh with resolution 0,01kvarh
208	1	xx	VIFE status
209-214	6	xxxxxxxxxxx	Reactive imported energy, tariff 3
215	1	CE	DIF size, 12 digit BCD, storage number bit 0
216	1	80	DIFE, tariff bits 0-1, storage number bit 1-4, unit bit 0
217	1	50	DIFE, tariff 4, unit bit 1
218	1	84	VIF for units kvarh with resolution 0,01kvarh
219	1	xx	VIFE status
220-225	6	xxxxxxxxxxx	Reactive imported energy, tariff 4
226	1	1F	DIF, more records will follow in next telegram
227	1	xx	CS checksum, calculated from C field to last data
228	1	16	Stop character

10.2.9 Example of the 9th telegram (all values are hexadecimal)

This example telegram contains the most recent snapshot of previous values, continued from telegram 8. Second most recent snapshot would be sent out in 10th and 11th telegram, and so on.

Byte No.	Size	Value	Description
1	1	68	Start character
2	1	4B	L-field, calculated from C field to last user data
3	1	4B	L-field, repeated
4	1	68	Start character
5	1	08	C-field, RSP_UD
6	1	xx	A-field, address

Byte No.	Size	Value	Description
7	1	72	CI-field, variable data respond, LSB first
8-11	4	xxxxxxx	Identification Number, 8 BCD digits
12-13	2	4204	Manufacturer: ABB
14	1	02	Version
15	1	02	Medium, 02 = Electricity
16	1	xx	Number of accesses
17	1	xx	Status
18-19	2	0000	Signature (0000 = no encryption)
20	1	CE	DIF size, 12 digit BCD, storage number bit 0
21	1	00	DIFE, storage number bit 1-4
22	1	ED	VIF for time/date point
23	1	E8	VIFE indicating end of period
24	1	xx	VIFE status
25-30	6	xxxxxxxxxxx	Time and date (sec,min,hour,day,month,year)
31	1	CE	DIF size, 12 digit BCD, storage number bit 0
32	1	40	DIFE, storage number bit 1-4, unit bit 0
33	1	FD	VIF FD -> next VIFE specifies type of value
34	1	61	Cumulation counter
35	1	xx	VIFE status
36-41	6	xxxxxxxxxxx	Number of pulses registered on input 1
42	1	CE	DIF size, 12 digit BCD, storage number bit 0
43	1	80	DIFE, storage number bit 1-4, unit bit 0
44	1	40	DIFE, unit bit 1
45	1	FD	VIF FD -> next VIFE specifies type of value
46	1	61	Cumulation counter
47	1	xx	VIFE status
48-53	6	xxxxxxxxxxx	Number of pulses registered on input 2
54	1	CE	DIF size, 12 digit BCD, storage number bit 0
55	1	C0	DIFE, storage number bit 1-4, unit bit 0
56	1	40	DIFE, unit bit 1
57	1	FD	VIF FD -> next VIFE specifies type of value
58	1	61	Cumulation counter
59	1	xx	VIFE status
60-65	6	xxxxxxxxxxx	Number of pulses registered on input 3
66	1	CE	DIF size, 12 digit BCD, storage number bit 0
67	1	80	DIFE, storage number bit 1-4, unit bit 0
68	1	80	DIFE, unit bit 1
69	1	40	DIFE, unit bit 2
70	1	FD	VIF FD -> next VIFE specifies type of value
71	1	61	Cumulation counter
72	1	xx	VIFE status

Byte No.	Size	Value	Description
73-78	6	xxxxxxxxxxx	Number of pulses registered on input 4
79	1	0F	DIF indicating that this is the last telegram
80	1	xx	CS checksum, calculated from C field to last data
81	1	16	Stop character

10.3 Special Readout of Meter Data

Introduction

Some data in the meter can only be read by first sending a SND_UD followed by a REQ_UD2.



Note – An NKE should always be sent before sending any of the commands described below. If the meter is in the middle of another special data readout process it will not respond correctly to the command.

After reading the first telegram, it is possible to continue reading by sending repeated REQ_UD2 commands

If the data item that has been read is normal and without any specific status associated with it, no status-VIFE or 0 will be sent out. If the status is “data error” or “no data available”, the standard M-Bus status coding will be sent out (18 hex or 15 hex).

Readable data

The data that can be read in this way is:

- Load profile
- Demand
- Previous values
- Logs
- Harmonics

Date, date/time format

In some cases data specifying date or date/time is contained in the read request command.

The format for date used in the commands is M-Bus data type G:

Day in bits 0-4	Valid values 1-31
Months in bits 8-11	Valid values 1-12
Year in bits 5-7 and 12-15 (bits 5-7 are the LSB bits)	Valid values 1-99

The format for date/time is 6 bytes BCD or M-Bus data type F. M-Bus data type F consists of

Minutes in bits 0-5	Valid values 0-59
Hours in bits 8-12	Valid values 0-23
Day in bits 16-20	Valid values 1-31
Months in bits 24-27	Valid values 1-12
Year in bits 21-23 and 28-31 (MSB bits)	Valid values 0-99

If a date or date/time is specified in the command, the meter sends out data for that period. If no data is stored in the meter for the specified period, the meter will

send out data from the nearest date backward in time. Therefore it is recommended that the system should check the date sent in the telegram to verify that it is the requested date. If no data is stored in the meter for the specified date, or for any date backward in time, all data in the telegram will have the status byte marked as “no data available” (15 hex).

10.3.1 Readout of Load Profile Data

Read request for a specified date

A read request for a specified date is performed by sending the following SND_UD to the meter followed by a REQ_UD2 (all values are hexadecimal).

Byte No.	Size	Value	Description
1	1	68	Start character
2	1	0A	L-field, calculated from C field to last user data
3	1	0A	L-field, repeated
4	1	68	Start character
5	1	53/73	C-field, SND_UD
6	1	xx	A-field, address
7	1	51	CI-field, data send, LSB first
8	1	02	DIF size, 2 byte integer
9	1	EC	VIF time point, date, M-Bus data type G
10	1	FF	VIF next byte is manufacturer specific
11	1	F9	VIF extension of manufacturer specific VIFE's, next VIFE specifies actual meaning.

Byte No.	Size	Value	Description
12	1	xx	VIFE specifies data requested: 10: Active import energy register values at end of interval 11: Active import energy consumption per interval 12: Reactive import energy register values at end of interval 13: Reactive import energy consumption per interval 14: Input 1 register values at end of interval 15: Input 1 number of counts per interval 16: Input 2 register values at end of interval 17: Input 2 number of counts per interval 1C: Active export energy register values at end of interval 1D: Active export energy consumption per interval 1E: Reactive export energy register values at end of interval 1F: Reactive export energy consumption per interval 20: Apparent import energy register values at end of interval 21: Apparent import energy consumption per interval 22: Apparent export energy register values at end of interval 23: Apparent export energy consumption per interval 24: Input 3 register values at end of interval 25: Input 3 number of counts per interval 26: Input 4 register values at end of interval 27: Input 4 number of counts per interval 28: Current average values per interval 29: Voltage average values per interval 2A: THD voltage average values per interval 2B: THD current average values per interval 2C: Power factor average values per interval
13-14	2	xxxx	Date (M-Bus data type G, LSB byte sent first)
15	1	xx	CS checksum, calculated from C field to last data
16	1	16	Stop character

Read request for a specified date and time

A read request for a specified time is performed by sending the following SND_UD to the meter followed by a REQ_UD2 (all values are hexadecimal).

Byte No.	Size	Value	Description
1	1	68	Start character
2	1	0E	L-field, calculated from C field to last user data
3	1	0E	L-field, repeated
4	1	68	Start character
5	1	53/73	C-field, SND_UD
6	1	xx	A-field, address
7	1	51	CI-field, data send, LSB first
8	1	0E	DIF size, 12 digit BCD data
9	1	ED	VIF time point, date, M-Bus data type G
10	1	FF	VIF next byte is manufacturer specific
11	1	F9	VIF extension of manufacturer specific VIFE's, next VIFE specifies actual meaning.

Byte No.	Size	Value	Description
12	1	xx	VIFE specifies data requested: 10: Active import energy register values at end of interval 11: Active import energy consumption per interval 12: Reactive import energy register values at end of interval 13: Reactive import energy consumption per interval 14: Input 1 register values at end of interval 15: Input 1 number of counts per interval 16: Input 2 register values at end of interval 17: Input 2 number of counts per interval 1C: Active export energy register values at end of interval 1D: Active export energy consumption per interval 1E: Reactive export energy register values at end of interval 1F: Reactive export energy consumption per interval 20: Apparent import energy register values at end of interval 21: Apparent import energy consumption per interval 22: Apparent export energy register values at end of interval 23: Apparent export energy consumption per interval 24: Input 3 register values at end of interval 25: Input 3 number of counts per interval 26: Input 4 register values at end of interval 27: Input 4 number of counts per interval 28: Current average values per interval 29: Voltage average values per interval 2A: THD voltage average values per interval 2B: THD current average values per interval 2C: Power factor average values per interval
13-18	6	xxxxxxxxxxx	Time/date (sec:min:hour / day-month-year)
19	1	xx	CS checksum, calculated from C field to last data
20	1	16	Stop character

Read request for load profile, quantities with phase no. specified

A read request for a load profile, quantities with phase no. specified is performed by sending the following SND_UD to the meter followed by a REQ_UD2 (all values are hexadecimal).

Byte No.	Size	Value	Description
1	1	68	Start character
2	1	10	L-field, calculated from C field to last user data
3	1	10	L-field, repeated
4	1	68	Start character
5	1	53/73	C-field, SND_UD
6	1	xx	A-field, address
7	1	51	CI-field, data send, LSB first
8	1	0E	DIF size, 12 digit BCD data
9	1	ED	VIF time point, date and time
10	1	FF	VIF next byte is manufacturer specific
11	1	F9	VIF extension of manufacturer specific VIFE's, next VIFE specifies actual meaning.

Byte No.	Size	Value	Description
12	1	xx	VIFE specifies data requested: 10: Active import energy register values at end of interval 11: Active import energy consumption per interval 12: Reactive import energy register values at end of interval 13: Reactive import energy consumption per interval 14: Input 1 register values at end of interval 15: Input 1 number of counts per interval 16: Input 2 register values at end of interval 17: Input 2 number of counts per interval 1C: Active export energy register values at end of interval 1D: Active export energy consumption per interval 1E: Reactive export energy register values at end of interval 1F: Reactive export energy consumption per interval 20: Apparent import energy register values at end of interval 21: Apparent import energy consumption per interval 22: Apparent export energy register values at end of interval 23: Apparent export energy consumption per interval 24: Input 3 register values at end of interval 25: Input 3 number of counts per interval 26: Input 4 register values at end of interval 27: Input 4 number of counts per interval 28: Current average values per interval 29: Voltage average values per interval 2A: THD voltage average values per interval 2B: THD current average values per interval 2C: Power factor average values per interval
13	1	FF	Next byte is manufacturer specific
14	1	xx	Entity corresponding to phase nos. L1,L2,L3,L1-L2,L2-L3,L1-L3, N
15-20	6	xxxxxxxxxxx	Time/date (sec:min:hour / day-month-year)
21	1	xx	CS checksum, calculated from C field to last data
22	1	16	Stop character

Read request for load profile with channel no. specified as input

A read request for a load profile with channel no. specified as input is performed by sending the following SND_UD to the meter followed by a REQ_UD2 (all values are hexadecimal).

Byte No.	Size	Value	Description
1	1	68	Start character
2	1	11	L-field, calculated from C field to last user data
3	1	11	L-field, repeated
4	1	68	Start character
5	1	53/73	C-field, SND_UD
6	1	xx	A-field, address
7	1	51	CI-field, data send, LSB first
8	1	0E	DIF size, 12 digit BCD data
9	1	ED	VIF time point, date and time

Byte No.	Size	Value	Description
10	1	FF	VIF next byte is manufacturer specific
11	1	F9	VIF extension of manufacturer specific VIFE's, next VIFE specifies actual meaning.
12	1	B8	Read load profile data based upon the channel no. specified. Register value will be read
13	1	FF	Next byte is manufacturer specific
14	1	F8	Next byte is manufacturer specific, used for numbering
15	1	xx	Specifies channel no. where channel nos=>0...7
16-21	6	xxxxxxxxxxx	Time/date (sec:min:hour / day-month-year)
22	1	xx	CS checksum, calculated from C field to last data
23	1	16	Stop character

Comments

The data is sent out with 12 load profile values in each telegram. This means that 2 telegrams must be read for 1 day of load profile values when the interval length is 60 minutes. If the interval length is 30 minutes 4 telegrams must be read and if the interval length is 15 minutes 8 telegrams must be read.

Beside the interval data the date/time information for the day record and the interval length is sent out.

Reading load profile energy values can be done either as register values, or as consumption per interval values. This is controlled by the VIFE used in the read-out request.

When the load profile data is read out as consumption per interval the register value at the start of the 1:st interval is also sent out. The date/time information is sent out in format M-Bus data type F.

When the load profile data is read out as consumption per interval the date/time information specifies the start of the 1:st interval and the date/time-stamp for the register value in the frame sent out. When the load profile data is read out as register values the date/time information specifies the end of the 1:st interval the frame sent out.

The register values have same data and value information bytes (DIF, DIFE's, VIF, VIFE's) as the momentary register values, but with storage number 1 to indicate that it is stored historical data.

If the load profile search type is set to raw format, it is only possible to read register values or average values, i.e., not consumption values per interval. In this case the values stored in the meter are sent out in the order they were stored, starting with the most recent. This means that there may exist duplicate time-stamps as well as jumps in time in any direction.

Status information

The manufacturer specific coding of the status information is used to indicate the following:

- Date/time was changed during the interval
- Data overflow in interval
- Intervals are too long or too short
- Power outage occurred during the interval

If one or several of these status events occur during an interval, the extra VIFE's FF FE 0x are sent out, where x is a bit 4-0 and have the following meaning if set:

Bit 4	Date/time was changed during the interval
Bit 3	Data overflow in interval
Bit 2	Power outage occurred during interval
Bit 1	Short interval
Bit 0	Long interval

10.3.1.1 Examples of Readouts of Load Profile Data

Introduction

In the following are a number of practical examples of load profile readouts. All data is hexadecimal and comments are preceded by a semicolon.

Readout of day 1 of active energy load profile register values

Reading active energy import total
10 40 fe 3e 16
Reading acknowledge
e5
Sending Direct access with Date command
68 0a 0a 68 73 fe 51 02 ec ff f9 10 69 11 32 16; Readout load profile with date
spccified, Date 09-01-2011 (9th January 2011)
Reading acknowledge
e5
Sending Request User Data 2:
10 7b fe 79 16
Data block 1:
68 89 89 68 08 00 72
00 00 00 00 42 04 10 02 18 2a 00 00 ;Header Information
44 ed eb 00 24 00 69 11; Date and time at the end of the interval (09-01-2011),
9th-January-2011.
01 fd a5 00 01 ;Interval length = 1 minute
4e 84 15 00 00 00 00 00 ;Total active import energy, value 15 hex indicating
data not available
4e 84 15 00 00 00 00 00
4e 84 15 00 00 00 00 00
4e 84 15 00 00 00 00 00
4e 84 15 00 00 00 00 00
4e 84 15 00 00 00 00 00
4e 84 15 00 00 00 00 00
4e 84 15 00 00 00 00 00
4e 84 15 00 00 00 00 00
4e 84 00 39 58 17 00 00 00 ;Total Active import energy 1758.39 kwh
4e 84 00 39 58 17 00 00 00 ;Total Active Import Energy 1758,39 kwh
4e 84 00 39 58 17 00 00 00 ;Total Active Import Energy 1758.39 kwh
1f 1e 16
Sending Request User Data 2

10 5b fe 59 16

Data block 2:

68 80 80 68 08 00 72 00 00 00 00 42 04 10 02 19

2a 00 00

44 ed eb 00 30 00 69 11 Date and Time MBus data type F format 9th January 2011
01 fd a5 00 01 ;Interval length 1 minute.

4e 84 00 39 58 17 00 00 00 ;Total Active Import Energy 1739.58 kwh

4e 84 00 39 58 17 00 00 00 ;Total Active Import Energy 1739.58 kwh

4e 84 00 39 58 17 00 00 00 ;Total Active Import Energy 1739.58 kwh

4e 84 00 39 58 17 00 00 00

4e 84 00 39 58 17 00 00 00

4e 84 00 39 58 17 00 00 00

4e 84 00 39 58 17 00 00 00

4e 84 00 39 58 17 00 00 00

4e 84 15 00 00 00 00 00 00

4e 84 15 00 00 00 00 00 00

4e 84 15 00 00 00 00 00 00

1f 23 16

1f at the end of the 2nd telegram indicates there are more frames to follow.

10.3.2 Readout of Demand Data

Read request

A read request is performed by sending the following SND_UD to the meter followed by a REQ_UD2 (all values are hexadecimal).

Byte No.	Size	Value	Description
1	1	68	Start character
2	1	0A	L-field, calculated from C field to last user data
3	1	0A	L-field, repeated
4	1	68	Start character
5	1	53/73	C-field, SND_UD
6	1	xx	A-field, address
7	1	51	CI-field, data send, LSB first
8	1	02	DIF size, 2 byte integer
9	1	EC	VIF time point, date, M-Bus data type G
10	1	FF	VIF next byte is manufacturer specific
11	1	F9	VIF extension of manufacturer specific VIFE's, next VIFE specifies actual meaning.

Byte No.	Size	Value	Description
12	1	18	VIFE specifies maximum demand
13-14	2	xxxx	Date (M-Bus data type G, LSB byte sent first)
15	1	xx	CS checksum, calculated from C field to last data
16	1	16	Stop character

Comments

The demand data stored for a measured period is sent out in one or more telegrams depending on the number of channels that are used. The data that is sent out is interval length, demand values for all channels and a date/time stamp for the end of the measured period. Each demand value is also followed by the date/time stamp for the end of the interval in which the minimum/maximum occurred.

The date/time information is sent out in format 6 byte BCD in order second, minute, hour, day, month and year.

The data for the currently pending period will be sent out with storage number set to 0, the most recent stored historical values will have storage number 1, the next set of historical values will have storage number 2 etc.

If data have not been generated for a quantity the demand value is set to 0 and the date/time is set to 00-00-00 / 00:00:00. This is the case for the currently pending period before any demand have been stored, that is while the very first interval in a measurement period is pending. It will also happen if a particular tariff has not been active in a measurement period.

10.3.2.1 Examples of Readouts of Demand Data

Introduction

In the following is a number of commented practical examples of demand data. All data is in hexadecimal format. Comments are preceded by a semicolon.

The examples contain only maximum values. For minimum values the function field in the DIF is set to 10 hex instead of 01 hex.

Readout of demand data

System sends read request command for demand:

68 0A 0A 68 73 FE 51 02 EC FF F9 18 C1 07 88 16

Meter sends out acknowledge:

E5

System sends out request UD2:

10 7B FE 79 16

Meter sends out data telegram:

68 E8 E8 68 08 00 72 44 47 24 00 42 04 02 02 04 00 00 00 ;Data header
01 FD 25 0F;Interval length 15 minutes

94 10 29 60 57 2A 00 ;Current maximum demand (storage number 0) for active
power tariff 1, VIF 29 -> data in W with 2 decimals. Data = 2A5760hex =
27748.80 W

8E 00 ED 6B 00 15 00 01 07 06 ;Date/time stamp for maximum given above:
1:st of july 2006, 00:15:00 (hour:minute:second)

94 20 29 00 00 00 00 ;Current maximum demand (storage number 0) for active
power tariff 2; VIF 29 -> data in W with 2 decimals. Data = 0

8E 00 ED 6B 00 00 00 00 00 00 ;Date/time stamp for maximum given above
is 00-00-00 / 00:00:00 -> no maximum have been generated for this quantity

94 30 29 00 00 00 00 8E 00 ED 6B 00 00 00 00 00 94 80 10 29 00
00 00 00 8E 00 ED 6B 00 00 00 00 00 94 90 40 29 60 5E 0A 00 8E
00 ED 6B 00 15 00 01 07 06 94 A0 40 29 00 00 00 00 8E 00 ED 6B 00
00 00 00 00 94 B0 40 29 00 00 00 00 8E 00 ED 6B 00 00 00 00
00 94 80 50 29 00 00 00 8E 00 ED 6B 00 00 00 00 00 94 40 FD
61 00 00 00 00 8E 00 ED 6B 00 00 00 00 00 94 80 40 FD 61 00 00
00 00 8E 00 ED 6B 00 00 00 00 00

8E 00 ED EB FF 70 00 00 00 00 00 ;Date/time stamp for end of measure-
ment period will always be 00-00-00 / 00:00:00 for the currently pending period

1F ;Did 1F -> More data exists

00
;Pad bytes

14 16 ;Checksum and stop byte

System sends out request UD2:

10 5B FE 59 16

Meter sends out data telegram:

68 E8 E8 68 08 00 72 44 47 24 00 42 04 02 02 05 00 00 00 ;Data header

01 FD 25 0F ;Interval length 15 minutes

D4 10 29 40 90 02 00 ;Maximum demand (storage number 1) for active power tariff 1, VIF 29 -> data in W with 2 decimals. Data = 29040hex = 1680.00 W

CE 00 ED 6B 26 29 01 03 06 06 ;Date/time stamp for maximum given above: 3:rd of june 2006, 01:29:26 (hour:minute:second)

D4 20 29 00 00 00 00 ;Maximum demand (storage number 1) for active power tariff 2, VIF 29 -> data in W with 2 decimals. Data = 0hex = 0 W

CE 00 ED 6B 00 00 00 00 00 ;Date/time stamp all zeros -> no maximum have been stored for this tariff

D4 30 29 50 30 02 00 CE 00 ED 6B 00 45 03 07 06 06 D4 80 10 29 C0 E0 04 00 CE 00 ED 6B 55 59 23 30 06 06

D4 90 40 29 A0 A0 00 00 ;Maximum demand (storage number 1) for reactive power tariff 1, VIF 29 -> data in var with 2 decimals. Data = A0A0hex = 411.20 var

CE 00 ED 6B 26 29 01 03 06 06 ;Date/time stamp for maximum given above: 3:rd of june 2006, 01:29:26 (hour:minute:second)

D4 A0 40 29 00 00 00 00 CE 00 ED 6B 00 00 00 00 00 D4 B0 40 29 30 89 00 00CE 00 ED 6B 00 45 03 07 06 06 D4 80 50 29 A0 31 01 00 CE 00 ED 6B 55 59 23 30 06 06

D4 40 FD 61 00 00 00 00 ;Maximum demand (storage number 1) for input 1, VIF 29 -> data in number of pulses. Data = 0hex = 0 pulses

CE 00 ED 6B 00 00 00 00 00 D4 80 40 FD 61 00 00 00 00 CE 00 ED 6B 00 00 00 00 00

CE 00 ED EB FF 70 00 00 00 01 07 06 ;Date/time stamp for end of measurement period: 1:st of july 2006, 00:00:00 (hour:minute:second)

1F 00 C5 16

10.3.3 Readout of Previous Values

Read request

A read request is performed by sending the following SND_UD to the meter (all values are hexadecimal) followed by a REQ_UD2

Byte No.	Size	Value	Description
1	1	68	Start character
2	1	0A	L-field, calculated from C field to last user data
3	1	0A	L-field, repeated

Byte No.	Size	Value	Description
4	1	68	Start character
5	1	53/73	C-field, SND_UD
6	1	xx	A-field, address
7	1	51	CI-field, data send, LSB first
8	1	02	DIF size, 2 byte integer
9	1	EC	VIF time point, date, M-Bus data type G
10	1	FF	VIF next byte is manufacturer specific
11	1	F9	VIF extension of manufacturer specific VIFEs, next VIFE specifies actual meaning.
12	1	19	VIFE specifies Previous values
13-14	2	xxxx	Date (M-Bus data type G, LSB byte sent first)
15	1	xx	CS checksum, calculated from C field to last data
16	1	16	Stop character

Comments

Previous values data for all channels that is stored at the end of a period is sent out in one or more telegrams depending on the number of channels that are used. The most recent values are sent out first having storage number 1, then the second most recently stored values with storage number 2 and so on until all stored previous values have been read. Beside the previous register values a date/time stamp for the end of the period is sent out in the telegram. The date/time information is sent out in format 6 byte BCD in order second, minute, hour, day, month and year.



Note – Previous values are also sent out in a normal readout sequence. This sequence takes it start after the default telegrams that contain current values of energy registers, instrumentation values, etc...

10.3.3.1 Examples of Readouts of Previous Values

Readout of previous values data

Sending initialize command

10 40 fe 3e 16

Reading acknowledge

e5

Sending Direct access with Date command

68 0a 0a 68 73 fe 51 02 ec ff f9 19 68 11 3a 16 ; Date 8th January, year 11

Reading acknowledge

e5

Sending Request User Data 2:

10 7b fe 79 16

Meter sends out data telegram:

Data block 1:

68 e3 e3 68 08 00 72 00 00 00 00 42 04 10 02 01 2a 00 00; Data header

ce 00 ed eb 00 00 00 00 08 01 11; Date/Time stamp for previous values, here 08-01-11 / 00:00:00 (day-month-year / sec:min:hour)

ce 00 84 00 39 58 17 00 00 00; Daily value for total import active energy, here 1758.39 kwh

ce 40 84 00 35 18 27 01 00 00; Daily value for total export active energy, here 12718.35 kwh

ce 80 40 84 00 23 75 02 00 00 00; Daily value for total import reactive energy, here 275.23 kvarh

ce c0 40 84 00 35 02 00 00 00 00; Daily value for total export reactive energy, here 2.35 kvarh

ce 00 84 ff 81 00 27 83 75 07 00 00; Daily value for active energy import L1, here 77583.27 kwh

ce 00 84 ff 82 00 23 75 02 00 00 00; Daily value for active energy import L2, here 275.23 kwh

ce 00 84 ff 83 00 35 02 00 00 00 00; Daily value for active energy import L3, here 2.35 kwh

ce 40 84 ff 81 00 39 58 17 00 00 00; Daily value for active energy export L1, here 1758.39 kwh

ce 40 84 ff 82 00 35 18 27 01 00 00; Daily value for active energy export L2, here 12718.35 kwh

ce 40 84 ff 83 00 27 83 75 07 00 00; Daily value for active energy export L3, here

77583.27 kwh

ce 10 84 00 00 00 00 00 00 00; Daily value for tariff 1 active energy, here 0.0 kwh

ce 20 84 00 00 00 00 00 00 00; Daily value for tariff 2 active energy, here 0.0 kwh

ce b0 00 84 00 00 00 00 00 00 00; Daily value for tariff 3 active energy, here 0.0 kwh

ce 80 10 84 00 00 00 00 00 00 00; Daily value for tariff 4 active energy, here 0.0 kwh

ce 90 40 84 00 00 00 00 00 00 00; Daily value for tariff 1 reactive energy, here 0.0 kvarh

ce a0 40 84 00 00 00 00 00 00 00; Daily value for tariff 2 reactive energy, here 0.0 kvarh

ce b0 40 84 00 00 00 00 00 00 00; Daily value for tariff 3 reactive energy, here 0.0 kvarh

ce 80 50 84 00 00 00 00 00 00 00; Daily value for tariff 4 reactive energy, here 0.0 kvarh

1f; Dif 1F-> more daily values exist

6e 16; Checksum and stop byte

Sending Request User Data 2:

10 5b fe 59 16

Data block 2:

68 4b 4b 68 08 00 72 00 00 00 00 42 04 10 02 02 2a 00 00; Data header

ce 00 ed eb 00 00 00 00 08 01 11; Date/Time stamp for previous values, here 08-01-11 / 00:00:00 (day-month-year / sec:min:hour)

ce 40 fd e1 00 00 00 00 00 00 00; Daily value for input 1 counter, here 0 pulses

ce 80 40 fd e1 00 00 00 00 00 00 00; Daily value for input 1 counter, here 0 pulses

ce c0 40 fd e1 00 00 00 00 00 00 00; Daily value for input 1 counter, here 0 pulses

ce 80 80 40 fd e1 00 00 00 00 00 00 00; Daily value for input 1 counter, here 0 pulses

0f; Dif 0F-> no more daily values exist

cd 16 ; Checksum and stop byte

Readout of previous values data

System sends read request command for previous values with date 1:st of July 06:

68 0A 0A 68 73 FE 51 02 EC FF F9 19 C1 07 89 16

Meter sends out acknowledge:

E5

System sends out request UD2:

10 7B FE 79 16

Meter sends out data telegram:

68 9C 9C 68 08 00 72 44 47 24 00 42 04 02 02 09 00 00 00 ;Data header

The date/time stamp and the monthly values have storage number 1, that is, it is the 1:st (most recent in time) set of monthly values

CE 00 ED 6B 00 00 00 01 07 06 ;Date/time stamp for previous values, here 01-07-06 / 00:00:00 (day-month-year / sec:min:hour)

CE 00 04 35 08 00 00 00 00 ;Monthly value for total active energy, 8.35 kWh

CE 10 04 62 02 00 00 00 00 ;Monthly value for tariff 1 active energy, 2.62 kWh

CE 20 04 27 02 00 00 00 00 ;Monthly value for tariff 2 active energy, 2.27 kWh

CE 30 04 79 00 00 00 00 00 ;Monthly value for tariff 3 active energy, 0.79 kWh

CE 80 10 04 65 02 00 00 00 ;Monthly value for tariff 4 active energy, 2.65 kWh

CE 80 40 04 04 02 00 00 00 ;Monthly value for total reactive energy, 2.04 kvarh

CE 90 40 04 64 00 00 00 00 ;Monthly value for tariff 1 reactive energy, 0.64 kWh

CE B0 40 04 19 00 00 00 00 ;Monthly value for tariff 3 reactive energy, 0.19 kWh

CE 80 50 04 65 00 00 00 00 ;Monthly value for tariff 4 reactive energy, 0.65 kWh

CE 40 FD 61 00 00 00 00 00 ;Monthly value for input 1 counter, 0 pulses

CE 80 40 FD 61 00 00 00 00 00 ;Monthly value for input 2 counter, 0 pulses

1F ;Dif 1F -> more monthly values exist

00 00 00 00 00 00 00 00 00 00 00 00 ;Pad bytes

62 16 ;Checksum and stop byte

System sends out request UD2:

10 5B FE 59 16

Meter sends out data telegram:

```

68 9C 9C 68 08 00 72 44 47 24 00 42 04 02 02 0A 00 00 00
8E 01 ED 6B 00 00 00 01 06 06 ;Date/time stamp for previous values, 01-06-
06 / 00:00:00 (day-month-year / sec:min:hour)
8E 01 04 17 05 00 00 00 00 8E 11 04 55 01 00 00 00 00 8E 21 04 27
02 00 00 00 00 8E 31 04 31 00 00 00 00 00 8E 81 10 04 04 01 00 00
00 00 8E 81 40 04 26 01 00 00 00 00 8E 91 40 04 38 00 00 00 00 00
8E A1 40 04 55 00 00 00 00 8E B1 40 04 07 00 00 00 00 00 8E 81
50 04 25 00 00 00 00 00 8E 41 FD 61 00 00 00 00 00 00 00 8E 81 40 FD
61 00 00 00 00 00 00 0F 00 00 00 00 00 00 00 00 00 00 00 00 E9 16
    
```

10.3.4 Readout of Event Log Data

Read request

Each one of the existing logs can be read by sending the following SND_UD to the meter followed by a REQ_UD2 (all values are hexadecimal).

Byte No.	Size	Value	Description
1	1	68	Start character
2	1	12	L-field, calculated from C field to last user data
3	1	12	L-field, repeated
4	1	68	Start character
5	1	53/73	C-field, SND_UD
6	1	xx	A-field, address
7	1	51	CI-field, data send, LSB first
8	1	8E or EC	DIF size, 6 byte BCD, storage number bit 0 is 0 or 1
9	1	8x or Cx	DIFE storage number bits 1-4, unit bit 6 is 0 or 1
10	1	8x	DIFE storage number bits 5-8
11	1	8x	DIFE storage number bits 9-12
12	1	0x	DIFE storage number bits 13-16
13	2	ED	VIF time/date
14	1	FF	VIF next byte is manufacturer specific
15	1	F9	VIF extension of manufacturer specific VIFE's, next VIFE specifies actual meaning.
16	1	1A	VIFE Specification for different Logs: System Log = 0x2e Audit Log = 0x2f Net Quality Log = 0x30 Settings Log = 0x31 Event Log = 0x32
17-22	6	xxxxxxxxxxx	Time/date (sec:min:hour / day-month-year)
23	1	xx	CS checksum, calculated from C field to last data
24	1	16	Stop character

Event Offset

The meter supports offset values 0 and -1 for reading the System, Event, Audit, Net Quality and Settings logs. If the offset mentioned is 0 then meter will read the

log in the forward direction. If the offset value mentioned is -1 then it will read the data in the backward direction from the given date.

Data

The data will be sent out with 5 events in each telegram. If less than 5 events is stored in the meter for the specified date/time and offset all data in the telegram after the last stored event will have status byte marked as "no data available" (15 hex).

The data sent out for each event is:

- Event type (1 byte binary coded).
 - Date/time stamp for start of the event (6 byte bcd in order sec:min:hour/day:month:year)
 - Duration of the event (in seconds)
-

10.3.4.1 Example of readout of log data

Readout of Net Quality Log with date and time specified as input

Send Nke.

10 40 fe 3e 16

Meter Responds with E5

E5

Read request net quality log with Offset -1.

68 12 12 68 73 fe 51 ce c0 80 80 00 ed ff f9 30 01 02 03 22 12 11 b0 16;Read net quality log with offset value -1. Date and Time spciefied as input, 22-12-2011 01:02:03

Meter Responds with E5.

E5.

Send Req UD2.

10 7B FE 79 16.

Meter responds with long frame data for net quality Log:

68 88 88 68 08 00 72 00 00 00 00 42 04 20 02 16 2a 00 00 ; Header Information

02 ff f9 b5 00 e1 07;Event Type net quality Log

0e ed b9 00 21 47 23 06 01 10 ;Date and Time 10.01.06 23:47:21

04 a0 00 dd 03 00 00 ;Duration

02 ff f9 b5 00 de 07 ;Event Type net quality Log

0e ed b9 00 21 47 23 06 01 10 ;Date and Time 10.02.06 23:47:21

04 a0 00 dd 03 00 00 ;Duation

02 ff f9 b5 00 f0 03 ;Event Type net quality Log

0e ed b9 00 11 47 23 06 01 10 ;Date and time 10.02.06 23:47:11

04 a0 00 e7 03 00 00 ;Duration

02 ff f9 b5 00 e8 03

0e ed b9 00 11 47 23 06 01 10

04 a0 00 e7 03 00 00

02 ff f9 b5 00 e2 07

0e ed b9 00 11 47 23 06 01 10

04 a0 e7 03 00 00

1f 70 16;1F indicates there are more frames to follow.

Readout of 4 telegrams of event log data with offset -1

System sends event log read request command (date/time 14/3-06 09:51:40), offset -1

68 12 12 68 73 FE 51 CE C0 80 80 00 ED FF F9 1A 40 51 09 14 03 06 06 16

Meter sends out acknowledge:

E5

System sends out request UD2:

10 7B FE 79 16

Meter sends out data telegram:

68 7E 7E 68 08 00 72 42 10 00 00 42 04 02 02 05 00 00 00 ;Data header
01 FF 6F 01 ;Total power outage
0E ED 39 24 19 09 14 03 06 ;Time/date 39:24:09 / 14-03-06 (sec:min:hour / day-month-year)
04 20 FE 00 00 00 ;Duration 254 seconds
01 FF 6F 01 ;Total power outage
0E ED 39 12 45 15 13 03 06 ;Time/date 12:45:15 / 13-03-06 (sec:min:hour / day-month-year)
04 20 5B 00 00 00 ; Duration 91 seconds
01 FF 6F 0F ;Abnormal negative power
0E ED 39 28 44 15 13 03 06 04 20 23 00 00 00
01 FF 6F 01 ;Total power outage
0E ED 39 44 38 15 13 03 06 04 20 52 01 00 00
01 FF 6F 0D ;Undervoltage on phase 3, level 2
0E ED 39 36 25 15 13 03 06 04 20 3E 00 00 00
1F ;Dif 1F -> More events exist
00 00 00 00 00 00 00 00 00 00 00 00 00 00 00 ;Pad bytes
0A 16 ;Checksum and stopbyte

10.3.5 Readout of Current Harmonics

Read request

A read request for current harmonics is performed by sending the following SND_UD to the meter followed by a REQ_UD2 (all values are hexadecimal).

Byte No.	Size	Value	Description
1	1	68	Start character

Byte No.	Size	Value	Description
2	1	07	L-field, calculated from C field to last user data
3	1	07	L-field, repeated
4	1	68	Start character
5	1	53/73	C-field, SND_UD
6	1	xx	A-field, address
7	1	51	CI-field, data send, LSB first
8	1	00	DIF size, no data
9	1	FF	VIF next byte is manufacturer specific
10	1	F9	VIF extension of manufacturer specific VIFE's, next VIFE specifies actual meaning
11	1	1B	VIFE specifies current harmonics
12	1	xx	CS checksum, calculated from C field to last data
13	2	16	Stop character

Read request for a specific phase

A read request for a specific phase is performed by sending the following SND_UD to the meter followed by a REQ_UD2 (all values are hexadecimal).

Byte No.	Size	Value	Description
1	1	68	Start character
2	1	08	L-field, calculated from C field to last user data
3	1	08	L-field, repeated
4	1	68	Start character
5	1	53/73	C-field, SND_UD
6	1	xx	A-field, address
7	1	51	CI-field, data send, LSB first
8	1	01	DIF size, 8 bit integer
9	1	FF	VIF next byte is manufacturer specific
10	1	F9	VIF extension of manufacturer specific VIFE's, next VIFE specifies actual meaning
11	1	1B	VIFE specifies current harmonics
12	1	xx	Phase number 1-3
13	1	xx	CS checksum, calculated from C field to last data
14	1	16	Stop character

About the data sent out

The meter will send out harmonic data for one phase in each telegram, which means 3 telegrams in a 3-element meter, 2 telegrams in a 2-element meter and 1 telegram in a single phase meter.

Data sent out will be the total harmonic distortion and the harmonics measured, normally those with numbers 2-16. Note that the total harmonic distortion is calculated from the harmonics measured and is thus not the true total harmonic dis-

tortion, which would require all harmonics (up to infinite frequency) to be measured.



Note – Data may temporarily be marked "not available" if there are disturbances on the net (for example due to short voltage dips) making the frequency measurement invalid. Also directly after startup all harmonics will be marked "not available" as they haven't been measured yet. As the harmonics are measured sequentially one at a time they will be available one by one.

10.3.5.1 Examples of Readouts of Current Harmonics Data

Comments

In the following are 2 examples of readouts of current harmonics data. The second example, which is in telegram format, is commented. The comments are preceded by semicolon. The data in both telegrams is hexadecimal.

Example 1

The readout contains the following data:

Byte No.	Size	Value	Description
1	1	68	Start character
2	1	73	L-field, calculated from C field to last user data
3	1	73	L-field, repeated
4	1	68	Start character
5	1	08	C-field, RSP_UD
6	1	xx	A-field, address
7	1	72	CI-field, data send, LSB first
8-11	4	xxxxxxx	identification number, 8 BCD digits
12-13	2	4204	Manufacturer: ABB
14	1	05	Version
15	1	02	Medium, 02=electricity
16	1	xx	Number of accesses
17	1	xx	Status
18-19	1	0000	Signature (0000=no encryption)
20	1	02	DIF size, 2 byte integer
21	1	FF	VIF next byte is manufacturer specific
22	1	ED	VIFE current harmonics
23	1	FF	VIF next byte is manufacturer specific
24	1	8x	VIFE phase x
25	1	FF	VIF next byte is manufacturer specific
26	1	F8	Extension of manufacturer specific VIFE's, next VIFE(s) used for numbering
27	1	00	Number 0 signifies total harmonics
28-29	2	xxxx	Total harmonics in percent with 1 decimal
30	1	02	DIF size, 2 byte integer

Byte No.	Size	Value	Description
31	1	FF	VIF next byte is manufacturer specific
32	1	ED	VIFE current harmonics
33	1	FF	VIF next byte is manufacturer specific
34	1	8x	VIFE phase x
35	1	FF	VIF next byte is manufacturer specific
36	1	F8	Extension of manufacturer specific VIFE's, next VIFE(s) used for numbering
37	1	02	Harmonic number
38-39	2	xxxx	2:nd harmonic in percent with 1 decimal
40	1	02	DIF size, 2 byte integer
41	1	FF	VIF next byte is manufacturer specific
42	1	ED	VIFE current harmonics
43	1	FF	VIF next byte is manufacturer specific
44	1	8x	VIFE phase x
45	1	FF	VIF next byte is manufacturer specific
46	1	F8	Extension of manufacturer specific VIFE's, next VIFE(s) used for numbering
47	1	03	Harmonic number
48-49	2	xxxx	3:rd harmonic in percent with 1 decimal
50	1	02	DIF size, 2 byte integer
51	1	FF	VIF next byte is manufacturer specific
52	1	ED	VIFE current harmonics
53	1	FF	VIF next byte is manufacturer specific
54	1	8x	VIFE phase x
55	1	FF	VIF next byte is manufacturer specific
56	1	F8	Extension of manufacturer specific VIFE's, next VIFE(s) used for numbering
57	1	04	Harmonic number
58-59	2	xxxx	4:th harmonic in percent with 1 decimal
60	1	02	DIF size, 2 byte integer
61	1	FF	VIF next byte is manufacturer specific
62	1	ED	VIFE current harmonics
63	1	FF	VIF next byte is manufacturer specific
64	1	8x	VIFE phase x
65	1	FF	VIF next byte is manufacturer specific
66	1	F8	Extension of manufacturer specific VIFE's, next VIFE(s) used for numbering
67	1	05	Harmonic number
68-69	2	xxxx	5:th harmonic in percent with 1 decimal
70	1	02	DIF size, 2 byte integer
71	1	FF	VIF next byte is manufacturer specific
72	1	ED	VIFE current harmonics

Byte No.	Size	Value	Description
73	1	FF	VIF next byte is manufacturer specific
74	1	8x	VIFE phase x
75	1	FF	VIF next byte is manufacturer specific
76	1	F8	Extension of manufacturer specific VIFE's, next VIFE(s) used for numbering
77	1	05	Harmonic number
78-79	2	xxxx	5:th harmonic in percent with 1 decimal
80	1	02	DIF size, 2 byte integer
81	1	FF	VIF next byte is manufacturer specific
82	1	ED	VIFE current harmonics
83	1	FF	VIF next byte is manufacturer specific
84	1	8x	VIFE phase x
85	1	FF	VIF next byte is manufacturer specific
86	1	F8	Extension of manufacturer specific VIFE's, next VIFE(s) used for numbering
87	1	05	Harmonic number
88-89	2	xxxx	5:th harmonic in percent with 1 decimal
90	1	02	DIF size, 2 byte integer
91	1	FF	VIF next byte is manufacturer specific
92	1	ED	VIFE current harmonics
93	1	FF	VIF next byte is manufacturer specific
94	1	8x	VIFE phase x
95	1	FF	VIF next byte is manufacturer specific
96	1	F8	Extension of manufacturer specific VIFE's, next VIFE(s) used for numbering
97	1	05	Harmonic number
98-99	2	xxxx	5:th harmonic in percent with 1 decimal
100	1	02	DIF size, 2 byte integer
101	1	FF	VIF next byte is manufacturer specific
102	1	ED	VIFE current harmonics
103	1	FF	VIF next byte is manufacturer specific
104	1	8x	VIFE phase x
105	1	FF	VIF next byte is manufacturer specific
106	1	F8	Extension of manufacturer specific VIFE's, next VIFE(s) used for numbering
107	1	05	Harmonic number
108-109	2	xxxx	5:th harmonic in percent with 1 decimal
110	1	1F	DIF, more records will follow in next telegram
111-119	9	00000000 00000000	PAD bytes
120	1	xx	CS checksum, calculated from C field to last data
121	1	16	Stop character

Example 2, readout of harmonic data starting from phase 2

System sends harmonic data read request command

```
68 08 08 68 73 FE 51 01 FF f9 1B 02 D8 16
```

Meter sends out acknowledge:

```
E5
```

System sends out request UD2:

```
10 7Bb FE 79 16
```

Meter sends out data telegram:

```
68 73 73 68 08 00 72 89 34 29 00 42 04 06 02 2E 00 00 00 ;Data header  
02 FF ED FF 82 FF f8 00 1A 05 ;Total current harmonic distortion for phase  
2 = 130.6 %
```

```
02 FF ED FF 82 FF f8 02 06 00 ;2:nd current harmonic distortion for phase 2  
= 0.6 %
```

```
02 FF ED FF 82 FF F8 03 70 03 ;3:rd current harmonic distortion for phase 2  
= 88.0 %
```

```
02 FF ED FF 82 FF F8 04 05 00 02 FF ED FF 82 FF F8 05 CC 02 02 FF  
ED FF 82 FF F8 06 07 00 02 FF ED FF 82 FF f8 07 0b 02 02 FF ED FF  
82 FF F8 08 09 00 02 FF ED FF 82 FF f8 09 80 01
```

1F ; Dif 1F -> More harmonic data exist

```
00 00 00 00 00 00 00 00 00 00 C6 16
```

System sends out request UD2:

```
10 7B FE 79 16
```

Meter sends out data telegram:

```
68 73 73 68 08 00 72 89 34 29 00 42 04 06 02 2F 00 00 00 ;Data header  
02 FF ED FF 83 FF F8 00 12 05 ;Total current harmonic distortion for phase  
3 = 129.8%
```

```
02 FF ED FF 83 FF F8 02 09 00 ;2:nd current harmonic distortion for phase 3  
= 0.9%
```

```
02 FF ED FF 83 FF F8 03 78 03 ;3:rd current harmonic distortion for phase 3  
= 88.8%
```

```
02 FF ED FF 83 FF F8 04 04 0002 FF ED FF 83 FF F8 05 db 0202 FF ED  
FF 83 FF F8 06 09 0002 FF ED FF 83 FF F8 07 00 0202 FF ED FF 83 FF  
F8 08 0B 0002 FF ED FF 83 FF F8 09 3F 01
```

0F ; Dif 0F -> No more harmonic data exist

```
00 00 00 00 00 00 00 00 00 00 89 16
```

10.3.6 Readout of Voltage Harmonics

Read request

A read request for voltage harmonics is performed by sending the following SND_UD to the meter followed by a REQ_UD2 (all values are hexadecimal).

Byte No.	Size	Value	Description
1	1	68	Start character
2	1	07	L-field, calculated from C field to last user data
3	1	07	L-field, repeated
4	1	68	Start character
5	1	53/73	C-field, SND_UD
6	1	xx	A-field, address
7	1	51	CI-field, data send, LSB first
8	1	00	DIF size, no data
9	1	FF	VIF next byte is manufacturer specific
10	1	F9	VIF extension of manufacturer specific VIFE's, next VIFE specifies actual meaning
11	1	2D	VIFE specifies voltage harmonics
12	1	xx	CS checksum, calculated from C field to last data
13	2	16	Stop character

Read request for a specific phase

A read request for a specific phase is performed by sending the following SND_UD to the meter followed by a REQ_UD2 (all values are hexadecimal).

Byte No.	Size	Value	Description
1	1	68	Start character
2	1	08	L-field, calculated from C field to last user data
3	1	08	L-field, repeated
4	1	68	Start character
5	1	53/73	C-field, SND_UD
6	1	xx	A-field, address
7	1	51	CI-field, data send, LSB first
8	1	01	DIF size, 8 bit integer
9	1	FF	VIF next byte is manufacturer specific
10	1	F9	VIF extension of manufacturer specific VIFE's, next VIFE specifies actual meaning
11	1	2D	VIFE specifies voltage harmonics
12	1	xx	Phase number 1-3
13	1	xx	CS checksum, calculated from C field to last data
14	1	16	Stop character

About the data sent out

The meter will send out harmonic data for one phase in each telegram, which means 3 telegrams in a 3-element meter, 2 telegrams in a 2-element meter and 1 telegram in a single phase meter.

Data sent out will be the total harmonic distortion and the harmonics measured, normally those with numbers 2-16. Note that the total harmonic distortion is calculated from the harmonics measured and is thus not the true total harmonic distortion, which would require all harmonics (up to infinite frequency) to be measured. If any harmonic have frequency above 500 Hz it will not be measured and will be marked "not available".

10.3.6.1 Examples of readout of voltage harmonics data

Example 1

The readout contains the following data:

Byte No.	Size	Value	Description
1	1	68	Start character
2	1	73	L-field, calculated from C field to last user data
3	1	73	L-field, repeated
4	1	68	Start character
5	1	08	C-field, RSP_UD
6	1	xx	A-field, address
7	1	72	CI-field, data send, LSB first
8-11	4	xxxxxxx	identification number, 8 BCD digits
12-13	2	4204	Manufacturer: ABB
14	1	05	Version
15	1	02	Medium, 02=electricity
16	1	xx	Number of accesses
17	1	xx	Status
18-19	1	0000	Signature (0000=no encryption)
20	1	02	DIF size, 2 byte integer
21	1	FF	VIF next byte is manufacturer specific
22	1	EE	VIFE voltage harmonics
23	1	FF	VIF next byte is manufacturer specific
24	1	8x	VIFE phase x
25	1	FF	VIF next byte is manufacturer specific
26	1	F8	Extension of manufacturer specific VIFE's, next VIFE(s) used for numbering
27	1	00	Number 0 signifies total harmonics
28-29	2	xxxx	Total harmonics in percent with 1 decimal
30	1	02	DIF size, 2 byte integer
31	1	FF	VIF next byte is manufacturer specific
32	1	EE	VIFE voltage harmonics

Byte No.	Size	Value	Description
33	1	FF	VIF next byte is manufacturer specific
34	1	8x	VIFE phase x
35	1	FF	VIF next byte is manufacturer specific
36	1	F8	Extension of manufacturer specific VIFE's, next VIFE(s) used for numbering
37	1	02	Harmonic number
38-39	2	xxxx	2:nd harmonic in percent with 1 decimal
40	1	02	DIF size, 2 byte integer
41	1	FF	VIF next byte is manufacturer specific
42	1	EE	VIFE voltage harmonics
43	1	FF	VIF next byte is manufacturer specific
44	1	8x	VIFE phase x
45	1	FF	VIF next byte is manufacturer specific
46	1	F8	Extension of manufacturer specific VIFE's, next VIFE(s) used for numbering
47	1	03	Harmonic number
48-49	2	xxxx	3:rd harmonic in percent with 1 decimal
50	1	02	DIF size, 2 byte integer
51	1	FF	VIF next byte is manufacturer specific
52	1	EE	VIFE voltage harmonics
53	1	FF	VIF next byte is manufacturer specific
54	1	8x	VIFE phase x
55	1	FF	VIF next byte is manufacturer specific
56	1	F8	Extension of manufacturer specific VIFE's, next VIFE(s) used for numbering
57	1	04	Harmonic number
58-59	2	xxxx	4:th harmonic in percent with 1 decimal
60	1	02	DIF size, 2 byte integer
61	1	FF	VIF next byte is manufacturer specific
62	1	EE	VIFE voltage harmonics
63	1	FF	VIF next byte is manufacturer specific
64	1	8x	VIFE phase x
65	1	FF	VIF next byte is manufacturer specific
66	1	F8	Extension of manufacturer specific VIFE's, next VIFE(s) used for numbering
67	1	05	Harmonic number
68-69	2	xxxx	5:th harmonic in percent with 1 decimal
70	1	02	DIF size, 2 byte integer
71	1	FF	VIF next byte is manufacturer specific
72	1	EE	VIFE voltage harmonics
73	1	FF	VIF next byte is manufacturer specific
74	1	8x	VIFE phase x

Byte No.	Size	Value	Description
75	1	FF	VIF next byte is manufacturer specific
76	1	F8	Extension of manufacturer specific VIFE's, next VIFE(s) used for numbering
77	1	05	Harmonic number
78-79	2	xxxx	5:th harmonic in percent with 1 decimal
80	1	02	DIF size, 2 byte integer
81	1	FF	VIF next byte is manufacturer specific
82	1	EE	VIFE voltage harmonics
83	1	FF	VIF next byte is manufacturer specific
84	1	8x	VIFE phase x
85	1	FF	VIF next byte is manufacturer specific
86	1	F8	Extension of manufacturer specific VIFE's, next VIFE(s) used for numbering
87	1	05	Harmonic number
88-89	2	xxxx	5:th harmonic in percent with 1 decimal
90	1	02	DIF size, 2 byte integer
91	1	FF	VIF next byte is manufacturer specific
92	1	EE	VIFE voltage harmonics
93	1	FF	VIF next byte is manufacturer specific
94	1	8x	VIFE phase x
95	1	FF	VIF next byte is manufacturer specific
96	1	F8	Extension of manufacturer specific VIFE's, next VIFE(s) used for numbering
97	1	05	Harmonic number
98-99	2	xxxx	5:th harmonic in percent with 1 decimal
100	1	02	DIF size, 2 byte integer
101	1	FF	VIF next byte is manufacturer specific
102	1	EE	VIFE voltage harmonics
103	1	ff	VIF next byte is manufacturer specific
104	1	8x	VIFE phase x
105	1	FF	VIF next byte is manufacturer specific
106	1	F8	Extension of manufacturer specific VIFE's, next VIFE(s) used for numbering
107	1	05	Harmonic number
108-109	2	xxxx	5:th harmonic in percent with 1 decimal
110	1	1F	DIF, more records will follow in next telegram
111-119	9	00000000 00000000	PAD bytes
120	1	xx	CS checksum, calculated from C field to last data
121	1	16	Stop character

Example 2

Sending initialize command

10 40 FE 3E 16

Reading acknowledge

E5

System sends voltage harmonic data read request command

68 08 08 68 73 FE 51 00 FF F9 2D 01 E8 16

Meter sends out acknowledge

E5

System sends out request UD2

10 7B FE 79 16

Meter sends out data telegram

6E C0 C0 68 08 00 72 00 00 00 00 42 04 20 02 03 2A 00 00 ;Data header

02 FF EE FF 81 FF F8 80 00 11 01 ;Total voltage harmonic distortion for phase 1 = 27.3%

02 FF EE FF 81 FF F8 82 00 1E 00 ;2nd voltage harmonic distortion for phase 1 = 3.0%

02 FF EE FF 81 FF F8 83 00 03 01 ;3rd voltage harmonic distortion for phase 1 = 25.9%

02 FF EE FF 81 FF F8 84 00 0B 00 ;4th voltage harmonic distortion for phase 1 = 1.1%

02 FF EE FF 81 FF F8 85 00 4D 00 ;5th voltage harmonic distortion for phase 1 = 7.7%

02 FF EE FF 81 FF F8 86 00 03 00 ;6th voltage harmonic distortion for phase 1 = 0.3%

02 FF EE FF 81 FF F8 87 00 08 00 ;7th voltage harmonic distortion for phase 1 = 0.8%

02 FF EE FF 81 FF F8 88 00 01 00 ;8th voltage harmonic distortion for phase 1 = 0.1%

02 FF EE FF 81 FF F8 89 00 12 00 ;9th voltage harmonic distortion for phase 1 = 1.8%

02 FF EE FF 81 FF F8 8A 00 02 00 ;10th voltage harmonic distortion for phase 1 = 0.2%

02 FF EE FF 81 FF F8 8B 00 0E 00 ;11th voltage harmonic distortion for phase 1 = 1.5%

02 FF EE FF 81 FF F8 8C 00 01 00 ;12th voltage harmonic distortion for phase 1 = 0.1%

02 FF EE FF 81 FF F8 8D 00 05 00 ;13th voltage harmonic distortion for phase 1 = 0.5%

02 FF EE FF 81 FF F8 8E 00 00 00 ;14th voltage harmonic distortion for phase 1 = 0.0%

02 FF EE FF 81 FF F8 8F 00 07 00 ;15th voltage harmonic distortion for phase 1 = 0.7%

02 FF EE FF 81 FF F8 90 00 01 00 ;16th voltage harmonic distortion for phase 1 = 0.1%

0F -No more harmonics data exist

D3 16

10.4 Sending Data to the Meter

General

This section describes the telegrams that can be sent to an EQ meter. Some of the telegrams contain data, others do not. Data sent in the telegram is sometimes stored in the meter, sometimes used by the meter to perform a certain action. Telegrams that contains no data usually initiates a certain action in the meter.

Write access level protection

Some of the commands can be protected by a password. There are 3 different levels of write access level protection:

- Open
- Open by password
- Closed

The write access level can be set either via the buttons directly on the meter or via communication using the *set write access level* command.

If the access level is set to *Open*, the meter will always accept the command as long as the the meter is properly addressed and the syntax and checksum are correct.

If the access level is set to *Open by password* the specific command sent to the meter must be preceded by a *send password* command in order for the meter to accept the command.

If the access level is set to *Closed* the meter will not accept any command, but will just return an acknowledge character (E5 hex). To change this access level protection, the access level has to be set to *Open* via the buttons directly on the meter.



Note – Commands that are not affected by the write access level protection only require a correct message with correct address, syntax and checksum to be accepted.

10.4.1 Set tariff

For meters with tariff control the active tariff is set by sending the following command (all values are hexadecimal). The command is not affected by the write protection level set.

Byte No.	Size	Value	Description
1	1	68	Start character
2	1	07	L-field, calculated from C field to last user data
3	1	07	L-field, repeated
4	1	68	Start character
5	1	53/73	C-field, SND_UD
6	1	xx	A-field, address
7	1	51	CI-field, data send, LSB first
8	1	01	DIF size, 8 bit integer

Byte No.	Size	Value	Description
9	1	FF	VIF next byte is manufacturer specific
10	1	13	VIFE tariff
11	1	xx	New tariff
12	1	xx	CS checksum, calculated from C field to last data
13	1	16	Stop character

10.4.2 Set primary address

The primary address is set by sending the following command (all values are hexadecimal). The command is not affected by the write protection level set.

Byte No.	Size	Value	Description
1	1	68	Start character
2	1	06	L-field, calculated from C field to last user data
3	1	06	L-field, repeated
4	1	68	Start character
5	1	53/73	C-field, SND_UD
6	1	xx	A-field, address
7	1	51	CI-field, data send, LSB first
8	1	01	DIF size, 8 bit integer
9	1	7A	VIFE Bus Address
10	1	xx	New primary address
11	1	xx	CS checksum, calculated from C field to last data
12	1	16	Stop character

10.4.3 Change baud rate

The baud rate of the electrical M-Bus interface is set by sending the following command (all values are hexadecimal). The command is not affected by the write protection level set.

Byte No.	Size	Value	Description
1	1	68	Start character
2	1	03	L-field, calculated from C field to last user data
3	1	03	L-field, repeated
4	1	68	Start character
5	1	53/73	C-field, SND_UD
6	1	xx	A-field, address
7	1	Bx	CI-field, New baud rate (where x=>8..F)
8	1	xx	CS checksum, calculated from C field to last data
9	1	16	Stop character

10.4.4 Reset power fail counter

The power fail counter is reset to 0 by sending the following command (all values are hexadecimal). The command is not affected by the write protection level set.

Byte No.	Size	Value	Description
1	1	68	Start character
2	1	07	L-field, calculated from C field to last user data
3	1	07	L-field, repeated
4	1	68	Start character
5	1	53/73	C-field, SND_UD
6	1	xx	A-field, address
7	1	51	CI-field, data send, LSB first
8	1	00	DIF size, no data
9	1	FF	VIF next byte is manufacturer specific
10	1	98	VIFE no. of power fails
11	1	07	VIFE clear
12	1	xx	CS checksum, calculated from C field to last data
13	1	16	Stop character

10.4.5 Set Current transformer (CT) ratio - numerator

The current transformer ratio (CT) numerator is set by sending the following command (all values are hexadecimal). The command is affected by the write protection level set.

Byte No.	Size	Value	Description
1	1	68	Start character
2	1	0a	L-field, calculated from C field to last user data
3	1	0a	L-field, repeated
4	1	68	Start character
5	1	53/73	C-field, SND_UD
6	1	xx	A-field, address
7	1	51	CI-field, data send, LSB first
8	1	04	DIF size, 32 bit integer
9	1	FF	VIF next byte is manufacturer specific
10	1	20	VIFE CT ratio numerator
11-14	4	xxxxxxx	New CT ratio numerator
15	1	xx	CS checksum, calculated from C field to last data
16	1	16	Stop character

10.4.6 Set voltage transformer (VT) ratio - numerator

The voltage transformer ratio (VT) numerator is set by sending the following command (all values are hexadecimal). The command is affected by the write protection level set.

Byte No.	Size	Value	Description
1	1	68	Start character
2	1	0a	L-field, calculated from C field to last user data
3	1	0a	L-field, repeated
4	1	68	Start character
5	1	53/73	C-field, SND_UD
6	1	xx	A-field, address
7	1	51	CI-field, data send, LSB first
8	1	04	DIF size, 32 bit integer
9	1	FF	VIF next byte is manufacturer specific
10	1	21	VIFE VT ratio numerator
11-14	4	xxxxxxx	New VT ratio numerator
15	1	xx	CS checksum, calculated from C field to last data
16	1	16	Stop character

10.4.7 Set current transformer (CT) ratio - denominator

The current transformer ratio (CT) denominator is set by sending the following command (all values are hexadecimal). The command is affected by the write protection level set.

Byte No.	Size	Value	Description
1	1	68	Start character
2	1	0a	L-field, calculated from C field to last user data
3	1	0a	L-field, repeated
4	1	68	Start character
5	1	53/73	C-field, SND_UD
6	1	xx	A-field, address
7	1	51	CI-field, data send, LSB first
8	1	04	DIF size, 32 bit integer
9	1	FF	VIF next byte is manufacturer specific
10	1	22	VIFE CT ratio denominator
11-14	4	xxxxxxx	New CT ratio denominator
15	1	xx	CS checksum, calculated from C field to last data
16	1	16	Stop character

10.4.8 Set voltage transformer (VT) ratio - denominator

The current transformer ratio (VT) denominator is set by sending the following command (all values are hexadecimal). The command is affected by the write protection level set.

Byte No.	Size	Value	Description
1	1	68	Start character
2	1	0A	L-field, calculated from C field to last user data
3	1	0A	L-field, repeated
4	1	68	Start character
5	1	53/73	C-field, SND_UD
6	1	xx	A-field, address
7	1	51	CI-field, data send, LSB first
8	1	04	DIF size, 32 bit integer
9	1	FF	VIF next byte is manufacturer specific
10	1	23	VIFE VT ratio denominator
11-14	4	xx xx xx xx	New VT ratio denominator
15	1	xx	CS checksum, calculated from C field to last data
16	1	16	Stop character

10.4.9 Select status information

To change the way the status information is sent out the following command is sent (all values are hexadecimal). The command is not affected by the write protection level set.

Byte No.	Size	Value	Description
1	1	68	Start character
2	1	07	L-field, calculated from C field to last user data
3	1	07	L-field, repeated
4	1	68	Start character
5	1	53/73	C-field, SND_UD
6	1	xx	A-field, address
7	1	51	CI-field, data send, LSB first
8	1	01	DIF size, 8 bit integer
9	1	FF	VIF next byte is manufacturer specific
10	1	15	VIFE status of values (status byte on the values)
11	1	xx	0=never, 1=status if not OK=always
12	1	xx	CS checksum, calculated from C field to last data
13	1	16	Stop character

10.4.10 Reset of stored state for input 1

Reset of stored state for input 1 is performed by sending the following command (all values are hexadecimal). The command is not affected by the write protection level set.

Byte No.	Size	Value	Description
1	1	68	Start character
2	1	08	L-field, calculated from C field to last user data
3	1	08	L-field, repeated
4	1	68	Start character
5	1	53/73	C-field, SND_UD
6	1	xx	A-field, address
7	1	51	CI-field, data send, LSB first
8	1	C0	DIF size, no data, storage number 1
9	1	40	DIFE unit=1
10	1	FD	VIF extension of VIF codes
11	1	9B	VIFE digital input
12	1	07	VIFE clear
13	1	xx	CS checksum, calculated from C field to last data
14	1	16	Stop character

10.4.11 Reset of stored state for input 2

Reset of stored state for input 2 is performed by sending the following command (all values are hexadecimal). The command is not affected by the write protection level set.

Byte No.	Size	Value	Description
1	1	68	Start character
2	1	09	L-field, calculated from C field to last user data
3	1	09	L-field, repeated
4	1	68	Start character
5	1	53/73	C-field, SND_UD
6	1	xx	A-field, address
7	1	51	CI-field, data send, LSB first
8	1	C0	DIF size, no data, storage number 1
9	1	80	DIFE unit=0
10	1	40	DIFE unit=2
11	1	FD	VIF extension of VIF codes
12	1	9B	VIFE digital input
13	1	07	VIFE clear
14	1	xx	CS checksum, calculated from C field to last data
15	1	16	Stop character

10.4.12 Reset of stored state for input 3

Reset of stored state for input 3 is performed by sending the following command (all values are hexadecimal). The command is not affected by the write protection level set.

Byte No.	Size	Value	Description
1	1	68	Start character
2	1	09	L-field, calculated from C field to last user data
3	1	09	L-field, repeated
4	1	68	Start character
5	1	53/73	C-field, SND_UD
6	1	xx	A-field, address
7	1	51	CI-field, data send, LSB first
8	1	C0	DIF size, no data, storage number 1
9	1	C0	DIFE unit=1
10	1	40	DIFE unit=2
11	1	FD	VIF extension of VIF codes
12	1	9B	VIFE digital input
13	1	07	VIFE clear
14	1	xx	CS checksum, calculated from C field to last data
15	1	16	Stop character

10.4.13 Reset of stored state for input 4

Reset of stored state for input 4 is performed by sending the following command (all values are hexadecimal). The command is not affected by the write protection level set.

Byte No.	Size	Value	Description
1	1	68	Start character
2	1	0A	L-field, calculated from C field to last user data
3	1	0A	L-field, repeated
4	1	68	Start character
5	1	53/73	C-field, SND_UD
6	1	xx	A-field, address
7	1	51	CI-field, data send, LSB first
8	1	C0	DIF size, no data, storage number 1
9	1	80	DIFE unit=0
10	1	80	DIFE unit=0
11	1	40	DIFE unit=4
12	1	FD	VIF extension of VIF codes
13	1	9B	VIFE digital input
14	1	07	VIFE clear
15	1	xx	CS checksum, calculated from C field to last data
16	1	16	Stop character

10.4.14 Reset of input counter 1

Reset of input counter 1 is performed by sending the following command (all values are hexadecimal). The command is not affected by the write protection level set.

Byte No.	Size	Value	Description
1	1	68	Start character
2	1	08	L-field, calculated from C field to last user data
3	1	08	L-field, repeated
4	1	68	Start character
5	1	53/73	C-field, SND_UD
6	1	xx	A-field, address
7	1	51	CI-field, data send, LSB first
8	1	C0	DIF size, no data
9	1	40	DIFE unit=1
10	1	FD	VIF extension of VIF codes
11	1	9B	VIFE cumulating counters
12	1	07	VIFE clear
13	1	xx	CS checksum, calculated from C field to last data
14	1	16	Stop character

10.4.15 Reset of input counter 2

Reset of input counter 2 is performed by sending the following command (all values are hexadecimal). The command is not affected by the write protection level set.

Byte No.	Size	Value	Description
1	1	68	Start character
2	1	09	L-field, calculated from C field to last user data
3	1	09	L-field, repeated
4	1	68	Start character
5	1	53/73	C-field, SND_UD
6	1	xx	A-field, address
7	1	51	CI-field, data send, LSB first
8	1	80	DIF size, no data
9	1	80	DIFE unit=0
10	1	40	DIFE unit=2
11	1	FD	VIF extension of VIF codes
12	1	E1	VIFE cumulating counters
13	1	07	VIFE clear
14	1	xx	CS checksum, calculated from C field to last data
15	1	16	Stop character

10.4.16 Reset of input counter 3

Reset of input counter 3 is performed by sending the following command (all values are hexadecimal). The command is not affected by the write protection level set.

Byte No.	Size	Value	Description
1	1	68	Start character
2	1	09	L-field, calculated from C field to last user data
3	1	09	L-field, repeated
4	1	68	Start character
5	1	53/73	C-field, SND_UD
6	1	xx	A-field, address
7	1	51	CI-field, data send, LSB first
8	1	80	DIF size, no data
9	1	C0	DIFE unit=1
10	1	40	DIFE unit=2
11	1	FD	VIF extension of VIF codes
12	1	E1	VIFE cumulating counters
13	1	07	VIFE clear
14	1	xx	CS checksum, calculated from C field to last data
15	1	16	Stop character

10.4.17 Reset of input counter 4

Reset of input counter 4 is performed by sending the following command (all values are hexadecimal). The command is not affected by the write protection level set.

Byte No.	Size	Value	Description
1	1	68	Start character
2	1	0A	L-field, calculated from C field to last user data
3	1	0A	L-field, repeated
4	1	68	Start character
5	1	53/73	C-field, SND_UD
6	1	xx	A-field, address
7	1	51	CI-field, data send, LSB first
8	1	80	DIF size, no data
9	1	80	DIFE unit=0
10	1	80	DIFE unit=0
11	1	40	DIFE unit=4
12	1	FD	VIF extension of VIF codes
13	1	E1	VIFE cumulating counters
14	1	07	VIFE clear
15	1	xx	CS checksum, calculated from C field to last data
16	1	16	Stop character

10.4.18 Set output 1

Setting the state of output 1 is performed by sending the following command (all values are hexadecimal). The command is not affected by the write protection level set.

Byte No.	Size	Value	Description
1	1	68	Start character
2	1	08	L-field, calculated from C field to last user data
3	1	08	L-field, repeated
4	1	68	Start character
5	1	53/73	C-field, SND_UD
6	1	xx	A-field, address
7	1	51	CI-field, data send, LSB first
8	1	81	DIF size, 8 bit integer
9	1	40	DIFE unit=1
10	1	FD	VIF extension of VIF codes
11	1	1A	VIFE digital output
12	1	xx	output 1, new state
13	1	xx	CS checksum, calculated from C field to last data
14	1	16	Stop character

10.4.19 Set output 2

Setting the state of output 2 is performed by sending the following command (all values are hexadecimal). The command is not affected by the write protection level set.

Byte No.	Size	Value	Description
1	1	68	Start character
2	1	09	L-field, calculated from C field to last user data
3	1	09	L-field, repeated
4	1	68	Start character
5	1	53/73	C-field, SND_UD
6	1	xx	A-field, address
7	1	51	CI-field, data send, LSB first
8	1	81	DIF size, 8 bit integer
9	1	80	DIFE unit=0
10	1	40	DIFE unit=2
11	1	FD	VIF extension of VIF codes
12	1	1A	VIFE digital output
13	1	xx	output 2, new state
14	1	xx	CS checksum, calculated from C field to last data
15	1	16	Stop character

10.4.20 Set output 3

Setting the state of output 3 is performed by sending the following command (all values are hexadecimal). The command is not affected by the write protection level set.

Byte No.	Size	Value	Description
1	1	68	Start character
2	1	09	L-field, calculated from C field to last user data
3	1	09	L-field, repeated
4	1	68	Start character
5	1	53/73	C-field, SND_UD
6	1	xx	A-field, address
7	1	51	CI-field, data send, LSB first
8	1	81	DIF size, 8 bit integer
9	1	C0	DIFE unit=1
10	1	40	DIFE unit=2
11	1	FD	VIF extension of VIF codes
12	1	1A	VIFE digital output
13	1	xx	output 3, new state
14	1	xx	CS checksum, calculated from C field to last data
15	1	16	Stop character

10.4.21 Set output 4

Setting the state of output 4 is performed by sending the following command (all values are hexadecimal). The command is not affected by the write protection level set.

Byte No.	Size	Value	Description
1	1	68	Start character
2	1	0A	L-field, calculated from C field to last user data
3	1	0A	L-field, repeated
4	1	68	Start character
5	1	53/73	C-field, SND_UD
6	1	xx	A-field, address
7	1	51	CI-field, data send, LSB first
8	1	81	DIF size, 8 bit integer
9	1	80	DIFE unit=0
10	1	80	DIFE unit=0
11	1	40	DIFE unit=4
12	1	FD	VIF extension of VIF codes
13	1	1A	VIFE digital output
14	1	xx	output 4, new state
15	1	xx	CS checksum, calculated from C field to last data
16	1	16	Stop character

10.4.22 Reset power outage time

Reset of power outage time is performed by sending the following command (all values are hexadecimal). The command is not affected by the write protection level set.

Byte No.	Size	Value	Description
1	1	68	Start character
2	1	07	L-field, calculated from C field to last user data
3	1	07	L-field, repeated
4	1	68	Start character
5	1	53/73	C-field, SND_UD
6	1	xx	A-field, address
7	1	51	CI-field, data send, LSB first
8	1	00	DIF size, no data
9	1	FF	VIF next byte is manufacturer specific
10	1	EC	VIFE power outage time
11	1	07	VIFE clear
12	1	xx	CS checksum, calculated from C field to last data
13	1	16	Stop character

10.4.23 Send password

Password is sent with the following command (all values are hexadecimal).

Byte No.	Size	Value	Description
1	1	68	Start character
2	1	0E	L-field, calculated from C field to last user data
3	1	0E	L-field, repeated
4	1	68	Start character
5	1	53/73	C-field, SND_UD
6	1	Xx	A-field, address
7	1	51	CI-field, data send, LSB first
8	1	07	DIF size, 8 byte integer
9	1	FD	VIF extension of VIF codes
10	1	16	VIFE password
11-18	8	xxxxxxxxxxxxxxxx	Password
19	1	xx	CS checksum, calculated from C field to last data
20	1	16	Stop character

10.4.24 Set password

Password is set by sending the following command (all values are hexadecimal).



Note – If the meter is password protected the old password must be sent before a new can be set.

Byte No.	Size	Value	Description
1	1	68	Start character
2	1	0F	L-field, calculated from C field to last user data
3	1	0F	L-field, repeated
4	1	68	Start character
5	1	53/73	C-field, SND_UD
6	1	xx	A-field, address
7	1	51	CI-field, data send, LSB first
8	1	07	DIF size, 8 byte integer
9	1	FD	VIF extension of VIF codes
10	1	96	VIFE password
11	1	00	VIFE write (replace)
12-19	8	xxxxxxxxxxxxxxxx	Password
20	1	xx	CS checksum, calculated from C field to last data
21	1	16	Stop character

10.4.25 Set date and time

Date and time is set by sending the following command (all values are hexadecimal). The command not affected by the write protection level set.



Note – Before sending the command an NKE should be sent. If the meter is in the middle of a special data readout process it will not respond to the set date and time command.

Byte No.	Size	Value	Description
1	1	68	Start character
2	1	0B	L-field, calculated from C field to last user data
3	1	0B	L-field, repeated
4	1	68	Start character
5	1	53/73	C-field, SND_UD
6	1	xx	A-field, address
7	1	51	CI-field, data send, LSB first
8	1	0E	DIF size, 12 digit BCD
9	1	6D	VIF time/date
10-15	6	xxxxxxxxxxxx	Time and date (sec, min, hour, day, month, year)
16	1	xx	CS checksum, calculated from C field to last data
17	1	16	Stop character

It is also possible to set date/time using the M-Bus data type F;

Byte No.	Size	Value	Description
1	1	68	Start character
2	1	09	L-field, calculated from C field to last user data
3	1	09	L-field, repeated

Byte No.	Size	Value	Description
4	1	68	Start character
5	1	53/73	C-field, SND_UD
6	1	xx	A-field, address
7	1	51	CI-field, data send, LSB first
8	1	04	DIF size, 32 bit integer
9	1	6D	VIF time/date
10-13	1	xxxxxxx	Time and date. Min, hour, day, month, year coded according to M-Bus data type F: <ul style="list-style-type: none"> • Minutes in bits 0-5. Valid values 0-59 • Hours in bits 8-12. Valid values 0-23 • Day in bits 16-20. Valid values 1-31 • Month in bits 24-27. Valid values 1-12 • Year in bits 21-23 and 28-31 (MSB bits). Valid values 0-99. All other bits are unused
14	1	xx	CS checksum, calculated from C field to last data
15	1	16	Stop character

10.4.26 Set date

The date is set by sending the following command (all values are hexadecimal). The command is affected by the write protection level set.

Byte No.	Size	Value	Description
1	1	68	Start character
2	1	07	L-field, calculated from C field to last user data
3	1	07	L-field, repeated
4	1	68	Start character
5	1	53/73	C-field, SND_UD
6	1	xx	A-field, address
7	1	51	CI-field, data send, LSB first
8	1	02	DIF size, 16 bit integer
9	1	6C	VIF date
10-11	1	xxxx	Date (day, month, year coded according to M-Bus data type G)
12	1	xx	CS checksum, calculated from C field to last data
13	1	16	Stop character

10.4.27 Reset demand, previous values, load profile and logs

All data for demand, previous values, load profile and logs is cleared by sending the following command (all values are hexadecimal). The command is affected by the write protection level set.

Byte No.	Size	Value	Description
1	1	68	Start character
2	1	08	L-field, calculated from C field to last user data

Byte No.	Size	Value	Description
3	1	08	L-field, repeated
4	1	68	Start character
5	1	53/73	C-field, SND_UD
6	1	xx	A-field, address
7	1	51	CI-field, data send, LSB first
8	1	00	DIF size, no data
9	1	FF	VIF next byte is manufacturer specific
10	1	F9	VIF extension of manufacturer specific VIFE's, next VIFE specifies actual meaning
11	1	xx	VIFE specifies data to be cleared: <ul style="list-style-type: none"> • 82: Demand • 83: Previous values • 84: Load profile • 85: Event log • AE: System log • B0: Net quality log • B1: Settings log
12	1	07	VIFE clear
13	1	xx	CS checksum, calculated from C field to last data
14	1	16	Stop character

10.4.28 Reset resettable active energy import

Reset of resettable active energy import is performed by sending the following command (all values are hexadecimal). The command is affected by the write protection level set.

Byte No.	Size	Value	Description
1	1	68	Start character
2	1	08	L-field, calculated from C field to last user data
3	1	08	L-field, repeated
4	1	68	Start character
5	1	53/73	C-field, SND_UD
6	1	xx	A-field, address
7	1	51	CI-field, data send, LSB first
8	1	00	DIF size, no data
9	1	84	VIFE specifying energy
10	1	FF	VIFE next byte is manufacturer specific
11	1	F2	Resettable registers
12	1	07	VIFE clear
13	1	xx	CS checksum, calculated from C field to last data
14	1	16	Stop character

10.4.29 Reset resettable active energy export

Reset of resettable active energy export is performed by sending the following command (all values are hexadecimal). The command is affected by the write protection level set.

Byte No.	Size	Value	Description
1	1	68	Start character
2	1	09	L-field, calculated from C field to last user data
3	1	09	L-field, repeated
4	1	68	Start character
5	1	53/73	C-field, SND_UD
6	1	xx	A-field, address
7	1	51	CI-field, data send, LSB first
8	1	80	DIF size, no data
9	1	40	DIFE, unit=1
10	1	84	VIFE specifying energy
11	1	FF	VIFE next byte is manufacturer specific
12	1	F2	Resettable registers
13	1	07	VIFE clear
14	1	xx	CS checksum, calculated from C field to last data
15	1	16	Stop character

10.4.30 Reset resettable reactive energy import

Reset of resettable active energy export is performed by sending the following command (all values are hexadecimal). The command is affected by the write protection level set.

Byte No.	Size	Value	Description
1	1	68	Start character
2	1	08	L-field, calculated from C field to last user data
3	1	08	L-field, repeated
4	1	68	Start character
5	1	53/73	C-field, SND_UD
6	1	xx	A-field, address
7	1	51	CI-field, data send, LSB first
8	1	80	DIF size, no data
9	1	80	DIFE, unit=0
10	1	40	DIFE unit=2
11	1	84	VIFE specifying energy
12	1	FF	VIFE next byte is manufacturer specific
13	1	F2	Resettable registers
14	1	07	VIFE clear
15	1	xx	CS checksum, calculated from C field to last data
16	1	16	Stop character

10.4.31 Reset resettable reactive energy export

Reset of resettable active energy export is performed by sending the following command (all values are hexadecimal). The command is affected by the write protection level set.

Byte No.	Size	Value	Description
1	1	68	Start character
2	1	0A	L-field, calculated from C field to last user data
3	1	0A	L-field, repeated
4	1	68	Start character
5	1	53/73	C-field, SND_UD
6	1	xx	A-field, address
7	1	51	CI-field, data send, LSB first
8	1	80	DIF size, no data
9	1	C0	DIFE, unit=1
10	1	40	DIFE unit=3
11	1	84	VIFE specifying energy
12	1	FF	VIFE next byte is manufacturer specific
13	1	F2	Resettable registers
14	1	07	VIFE clear
15	1	xx	CS checksum, calculated from C field to last data
16	1	16	Stop character

10.4.32 Freeze demand

The demand values will be frozen and a new period will be started by sending the following command (all values are hexadecimal). The command is affected by the write protection level set.

Byte No.	Size	Value	Description
1	1	68	Start character
2	1	08	L-field, calculated from C field to last user data
3	1	08	L-field, repeated
4	1	68	Start character
5	1	53/73	C-field, SND_UD
6	1	xx	A-field, address
7	1	51	CI-field, data send, LSB first
8	1	00	DIF size, no data
9	1	FF	VIF next byte is manufacturer specific
10	1	F9	VIF extension of manufacturer specific vife's, next vife specifies actual meaning
11	1	82	VIFE specifying demand
12	1	0B	VIFE freeze
13	1	xx	CS checksum, calculated from C field to last data
14	1	16	Stop character

10.4.33 Set write access level

The write access level is set by sending the following command (all values are hexadecimal). The command is affected by the write protection level set.

Byte No.	Size	Value	Description
1	1	68	Start character
2	1	07	L-field, calculated from C field to last user data
3	1	07	L-field, repeated
4	1	68	Start character
5	1	53/73	C-field, SND_UD
6	1	xx	A-field, address
7	1	51	CI-field, data send, LSB first
8	1	01	DIF size, 8 bit integer
9	1	FF	VIF next byte is manufacturer specific
10	1	6A	VIFE write control
11	1	xx	Write control (1: Closed, 2: Open by password, 3: Open)
12	1	xx	CS checksum, calculated from C field to last data
13	1	16	Stop character

10.4.34 Set tariff source

Tariffs can be controlled by inputs, communication or internal clock.

The tariff source is set by sending the following command (all values are hexadecimal). The command is affected by the write protection level set.

Byte No.	Size	Value	Description
1	1	68	Start character
2	1	08	L-field, calculated from C field to last user data
3	1	08	L-field, repeated
4	1	68	Start character
5	1	53/73	C-field, SND_UD
6	1	xx	A-field, address
7	1	51	CI-field, data send, LSB first
8	1	01	DIF size, 8 bit integer
9	1	FF	VIF next byte is manufacturer specific
10	1	F9	VIF extension of manufacturer specific VIFE's, next VIFE specifies actual meaning
11	1	06	VIFE tariff source
12	1	xx	Tariff source (0: Internal clock, 1: Communication command, 2: Inputs)
13	1	xx	CS checksum, calculated from C field to last data
14	1	16	Stop character

10.4.35 Set CO2 conversion factor

The co2 conversion factor is set by sending the following command (all values are hexadecimal). The command is not affected by the write protection level set.

Byte No.	Size	Value	Description
1	1	68	Start character
2	1	0A	L-field, calculated from C field to last user data
3	1	0A	L-field, repeated
4	1	68	Start character
5	1	53/73	C-field, SND_UD
6	1	xx	A-field, address
7	1	51	CI-field, data send, LSB first
8	1	04	DIF size, 32 bit integer
9	1	FF	VIF next byte is manufacturer specific
10	1	24	VIFE CO2 conversion factor in g/kWh
11-14	4	xxxxxxx	CO2 conversion factor
15	1	xx	CS checksum, calculated from C field to last data
16	1	16	Stop character

10.4.36 Set currency conversion factor

The currency conversion factor is set by sending the following command (all values are hexadecimal). The command is not affected by the write protection level set.

Byte No.	Size	Value	Description
1	1	68	Start character
2	1	0A	L-field, calculated from C field to last user data
3	1	0A	L-field, repeated
4	1	68	Start character
5	1	53/73	C-field, SND_UD
6	1	xx	A-field, address
7	1	51	CI-field, data send, LSB first
8	1	04	DIF size, 32 bit integer
9	1	FF	VIF next byte is manufacturer specific
10	1	25	VIFE currency conversion factor
11-14	4	xxxxxxx	Currency conversion factor in currency/kWh with 3 decimals
15	1	xx	CS checksum, calculated from C field to last data
16	1	16	Stop character

