

DALIBOX Broadcast 6CH/4CH

KNX-DALI Interface for up to 6/4 Channel Broadcast Control

**ZDI-DLB6
ZDI-DLB4**

Application Program Version: [1.2]
Manual Edition: [1.2]_b

www.zennio.com

CONTENTS

Contents	2
Document Updates	3
1 Introduction	4
1.1 DALIBOX Broadcast 6CH.....	4
1.2 Installation.....	6
1.3 Compatible Ballasts.....	7
2 Configuration.....	8
2.1 General Configuration.....	10
2.2 Channels.....	16
2.2.1 Main Configuration.....	16
2.2.2 Limits.....	19
2.2.3 Switch On/Off	20
2.2.4 Dimming.....	22
2.2.5 Error Objects.....	23
2.2.6 Status Objects	27
2.2.7 Custom On/Off.....	28
2.2.8 Timers	29
2.2.9 Scenes/Sequences	34
2.2.10 Lock.....	37
2.2.11 Custom Initialisation	38
2.2.12 Modes	39
ANNEX I. Error indicators	44
ANNEX II. Communication Objects.....	45

DOCUMENT UPDATES

Version	Changes	Page(s)
[1.2]_b	Clarification about ballast change directions.	24
[1.2]_a	Changes in the application program: <ul style="list-style-type: none">• Heartbeat functionality added.• New parameter to configure bit timing.	-
[1.1]_a	Changes in the application program: Internal code revision.	-

1 INTRODUCTION

1.1 DALIBOX BROADCAST 6CH

DALIBOX Broadcast 6CH and DALIBOX Broadcast 4CH are the KNX-DALI broadcast gateways from Zennio. Featuring six and four DALI channels respectively, they are intended for interconnection of the KNX and DALI buses, thus making it possible to send broadcast control messages (i.e., addressed to all ballasts that may be present) through the output channels, as well as to monitor the DALI installation.

Their main functions are:

- **General ballast control** through universal DALI.
- Support for **up to 20 ballasts per channel**, and therefore **up to 120 ballasts** (6CH model) or **up to 80 ballasts** (4CH model) in total.
- **110V** or **230V** power supply.
- **Ballast swap** with automatic address re-assignment.
- Light regulation with **customisable dimming** limits and times, or by manually characterising the dimming curve.
- **Lock** function.
- **Timed actions**: simple timers, flashing sequences and automatic switch-off.
- **Scenes and sequences**,
- **Custom On/Off** controls,
- **Standby Mode** to help save power consumption in the ballasts by controlling the power supply to the output channels.
- **Error detection and notification**: short circuit, overconsumption, power failure, open circuit, ballast error and lamp failure.
- Support for the **Burn-in** mode, required by certain lamps during the switch-on in order to ensure an optimal life period.

- **Manual control** through the on-board pushbuttons and LEDs.
- **Heartbeat** or periodical “still-alive” notification.

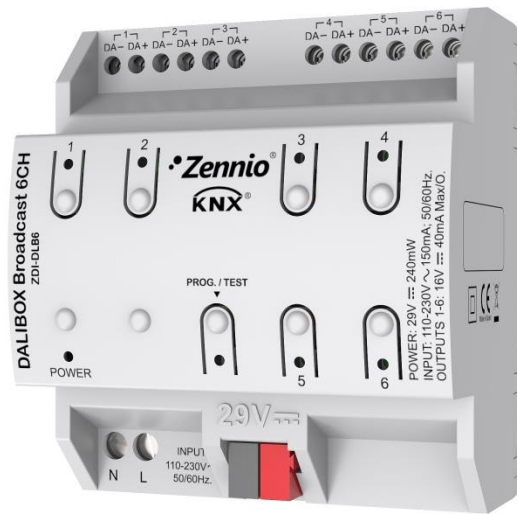

Figure 1. DALIBOX Broadcast 6CH

Note: certain figures or sections of this manual may refer specifically to DALIBOX Broadcast 6CH. However, please bear in mind that everything applies to DALIBOX Broadcast 4CH as well, with the only difference of the available output channels.

1.2 INSTALLATION

DALIBOX Broadcast 6CH / 4CH connects to the KNX bus through the on-board KNX connector. Once the device is provided with power from the KNX bus, both the individual address and the associated application program can be downloaded.

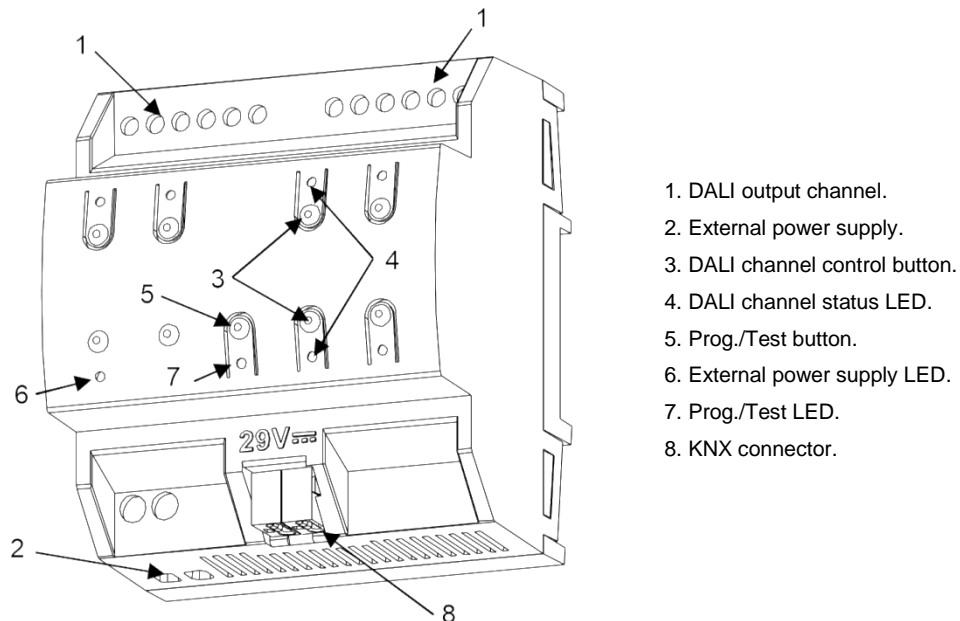

Figure 2. Element Diagram.

The main elements of the device are described next:

- **Prog./Test Pushbutton (5):** a short press on this button sets the device into the programming mode, making the associated LED (7) light in red.

Note: if this button is held while plugging the device into the KNX bus, the device will enter into **safe mode**. In such case, the LED will blink in red every 0.5 seconds.

- **Output Channels (1):** slots for the connection of the DALI bus wires.
- **Neutral and Phase Inputs (2):** slots for the connection of the neutral and the phase of the power line.

To get detailed information about the technical features of the device, as well as on the installation and security procedures, please refer to the corresponding **Datasheet**, bundled with the original package of the device and also available at www.zennio.com.

1.3 COMPATIBLE BALLASTS

DALIBOX Broadcast 6CH / 4CH is able to control DALI-certified ballasts (i.e., with the DALI logo) that make use of only one individual address.

Correct operation cannot be guaranteed for other ballasts.

Nevertheless, not all DALI-certified ballasts behave the same way – certain particularities apply:

- Ballasts with LED loads do not report lamp failures; therefore, with these ballasts it is not possible to notify such circumstance to the KNX bus.
- When a lamp failure takes place, certain ballasts with fluorescent lamps may cause the remaining lamps flash briefly.
- Fluorescent-lamp ballasts need an extra time to switch off the load when a non-immediate regulation to 0% is commanded.
- Certain ballast models, on the event of a DALI communication error (e.g., short-circuit or power failure), do not switch to the dimming value configured for such circumstance – the ballast will maintain the last dimming value that may have been set.
- Some lamps may implement a significant delay when they are switched on. Such circumstance must be taken into account in case of parameterising timed actions or flashing and dimming sequences.

There may be some other (minor) particularities depending on the ballasts and on the lamps in the installation. Therefore, the integrator is advised to perform some testing to ensure compatibility.

2 CONFIGURATION

The DALIBOX Broadcast 6CH / 4CH application program allows, as stated in previous sections, controlling DALI ballasts grouped into up to six or four channels. Such control is performed according to a set of customisable options which make DALIBOX Broadcast 6CH / 4CH a very versatile device:

- Different alternatives to **control the luminosity** of the connected loads:
 - One-bit objects to **switch on / switch off** each channel,
 - Four-bit objects for per-channel **step dimming**,
 - One-byte objects for per-channel **absolute dimming** (in percentage).
- **General dimming** features:
 - Configurable **dimming times**, being possible to modify them through communication objects. Up to three different dimming times are available.
 - Dimming limits, i.e., **maximum and minimum lighting** levels.
 - Minimum luminosity level reachable by each channel, i.e., the **ballast physical minimum**.
 - Maximum luminosity level allowed in the ballasts under the **economy mode**.
- **Custom on/off**: possibility of enabling and configuring up to two different switch-on/off controls, with custom dimming values and times.
- **Simple timer and flashing**: timed switch-on and switch-off sequences of the ballasts connected to the device.
- **Scenes/Sequences**: up to ten different, customisable scenes or sequences (with up to five configurable steps each), being possible to define the dimming type of each step action, among other things.
- **Lock**: channel control enabling/disabling, with the additional option to define actions for the lock and unlock events.

- **Initialization:** custom configuration of the initial status (upon the recovery of the KNX bus power or after an ETS download or a restart) for each channel, or either of an initial sending (immediate or delayed) of the status to the bus.
- **Error identification:** detection of anomalies that may affect the proper operation of the device: power supply error, short circuit, ballast error, ballast overload, open circuit or lamp failure.
- **Special operation modes:**
 - **Standby:** mode that allows notifying an external actuator after switching off a channel, so the power supply to the ballasts in such channel can be interrupted, thus reducing the power consumption.
 - **Auto Off:** mode that allows automatically switching off one channel, provided that it remains steady under a certain, parameterisable dimming threshold for more than a certain, parameterisable time period.
 - **Burn-in:** mode that prevents the execution of dimming orders during a certain, parameterisable time period after the switch-on of the ballast, with the aim of stabilising the lamp response and of optimising its life time. This feature may be required by certain lamp models.

2.1 GENERAL CONFIGURATION

The general configuration of DALIBOX Broadcast 6CH / 4CH **entails enabling the desired number of channels**, depending on the number of loads to be controlled and their distribution along the DALI installation.

Besides, the **manual control** type desired (i.e., the control type that will be available through the on-board pushbuttons of the device) may be selected.

Moreover, the general configuration allows enabling the following functions:

- **Power Supply Error Object**: notification to the KNX bus about an **external power supply** failure in the device.
- **Heartbeat** or periodical “still-alive” notification.
- **Standard Bit Timing**: this function allows customising the time threshold after which the arrival of a new bit through the DALI bus will be considered corrupt, for instance to prevent telegram collisions in case several ballast have been assigned the same address. Preserving the standard threshold is highly encouraged, unless intending to connect very specific ballasts that may require modifying it.

Once the basic configuration is defined, it is possible to enable and configure some additional functions for each channel (please refer to section 2.2).

Related to the **manual control**, DALIBOX Broadcast 6CH / 4CH allows manually switching the state of its channels through the respective pushbuttons on the top side of the device. A specific pushbutton is therefore available per channel.

Manual operation can be done in two different ways, named as **Test On mode** (for testing purposes during the configuration of the device) and **Test Off mode** (for a normal use, anytime). Whether both, only one, or none of these modes should be accessible needs to be parameterised in ETS. Moreover, it is possible to enable a specific binary object for locking and unlocking the manual control in runtime.

Notes:

- *The Test Off mode will be active (unless it has been disabled in parameters) after a download or a reset with no need of a specific activation – the pushbuttons will respond to user presses from the start.*
- *On the contrary, switching to the Test On mode (unless disabled in parameters) needs to be done by long-pressing the Prog./Test button (for at least three seconds), until the LED is no longer red and turns yellow. From that moment, once the button is released, the LED light will remain green to confirm that the device has switched from the Test Off mode to the Test On mode. After that, an additional press will turn the LED yellow and then off, once the button is released. This way, the device leaves the Test On mode. Note that it will also leave this mode if a bus power failure takes place.*

Test Off Mode

Under the Test Off Mode, the channels can be controlled through both their communication objects and the actual pushbuttons located on the top of the device.

When any of these buttons is pressed, the corresponding channel will behave as if an order had been received through the analogous communication object, depending on the channel configuration:

- A **short press** will be equivalent to receiving a switch order (either a switch-on or a switch-off – this will alternate on every short press). The first time, it will always consist in a switch-on, unless the current level is already maximum (in such case, the regulation will be towards 0%). This regulation is subject to the “On/Off Dimming Time” (see section 2.2.3) for each channel.
- A **long press** will be equivalent to receiving a relative dimming command (see section 2.2.4). The dimming direction will be contrary to that of the previous regulation, although the first time the regulation will always be upwards (unless the current level is already the maximum one – in such case the regulation will be towards 0%). The dimming speed will correspond to that defined in parameters for the relative dimming. Once the pushbutton is released, the regulation is interrupted.

Regarding the rest of the functions, the device will behave under the Test Off mode as usual. As stated, button presses during this mode are entirely analogous to the reception of the corresponding orders from the KNX bus, thus the status objects will also be sent normally.

Test On Mode

After entering the Test On mode, it will only be possible to control the output channels through the on-board manual control pushbuttons. Orders received through communication objects will be ignored, with independence of the channel they are addressed to.

Enabling the Test On mode allows the direct control of every channel with independence of the device parameterisation – the output channels can be controlled in the Test On mode no matter if they have not been enabled in parameters:

- During the Test On mode, a physical minimum (see section 2.2.2) of 3% will be applied to all channels (thus, making the response of all ballasts homogeneous).
- The channel dimming through the on-board pushbuttons will be analogous to that in the Test Off mode, with the following remarks:
 - A **short press** will cause immediate regulations to 0% or to 100% (and not to the maximum level configured).
 - The **long press** dimming period will be 10 seconds (from 0% to 100%).

Any orders received from the KXN bus related to the channel operation will be ignored. Moreover, the device will not send the status objects that may correspond to the manual actions performed by the user. **The only exceptions are the lock objects.**

Important: *the device is delivered from factory with both manual modes (Test Off and Test On) enabled, although with all channels disabled (thus, the Test Off mode will result functionless).*

ETS PARAMETERISATION

After importing the corresponding ETS database and adding the device to the project topology, the configuration process begins by entering the Parameters tab of the device.

The tab tree on the left shows the “General” tab in the first place. This entry itself comprises the following parameters:

Parameter	Value/Status
Channel 1	<input type="checkbox"/>
Channel 2	<input type="checkbox"/>
Channel 3	<input type="checkbox"/>
Channel 4	<input type="checkbox"/>
Channel 5	<input type="checkbox"/>
Channel 6	<input type="checkbox"/>
Manual Control	Test Off Mode + Test On Mode
Manual Control Lock	<input type="checkbox"/>
Power Supply Error Object	<input type="checkbox"/>
Heartbeat (Periodical Alive Notification)	<input type="checkbox"/>
Standard Bit Timing	<input checked="" type="checkbox"/>

Figure 3. General

- **Channel ‘x’**: checkboxes to enable or disable the required output channels.
- **Manual Control**: options are “Disabled”, “Only Test Off Mode”, “Only Test On Mode” and “Test Off Mode + Test On Mode” (default). Depending on the selection, the device will permit using the manual control under the Test Off, the Test On, or both modes. Note that, as stated before, using the Test Off mode does not require any special action, while switching to the Test On mode does require long-pressing the Prog./Test button.
- **Manual Control Lock**: unless the above parameter has been disabled, the Lock Manual Control parameter provides an optional procedure for locking the manual control in runtime. When this checkbox is enabled, object “**Manual Control Lock**” turns visible, as well as two more parameters:

- **Value:** defines whether the manual control lock/unlock should take place respectively upon the reception (through the aforementioned object) of values “0” and “1”, or the opposite.
- **Initialization:** sets how the lock state of the manual control should remain after the device start-up (after an ETS download or a bus power failure): “Unlocked”, “Locked” or “Last Value” (default; on the very first start-up, this will be Unlocked).
- **Power Supply Error Object:** enables/disables a one-bit object (“Error: Power Supply”) that will notify (by sending the value “1” periodically) the existence of a power supply failure. See section 2.2.5. Once the error is over, it will send the value “0” (once).
- **Heartbeat (Periodical Alive Notification):** this parameter lets the integrator incorporate a one-bit object to the project (“**[Heartbeat] Object to Send ‘1’**”) that will be sent periodically with a value of “1” to notify that the device is still working (still alive).

Heartbeat (Periodical Alive Notification)

Period

Figure 4. Heartbeat (Periodical Alive Notification).

Note: *The first sending after download or bus failure takes place with a delay of up to 255 seconds, to prevent bus overload. The following sendings match the period set.*

- **Standard Bit Timing:** enables/disables the possibility of configuring the bit detection time. The standard value set by default is 500 μ s.
 - **Maximum time for one bit phase:** sets the new threshold value between 500 μ s and 650 μ s.

Note: *preserving the standard threshold is highly encouraged, unless intending to connect very specific ballasts that may require modifying it.*

Standard Bit Timing	<input type="checkbox"/>
Maximum time for one bit phase	<input type="text" value="500"/> us

Figure 5. Standard Bit Timing.

2.2 CHANNELS

2.2.1 MAIN CONFIGURATION

The general configuration for each output channel involves the following options:

- **Dimming times:** the dimming time is the length of the transition from switched off (0%) to the maximum luminosity level (100%), which determines the speed of the regulation. **Up to three different dimming times** can be applied to the different orders or actions, and their values may be changed through three communication objects (one per each dimming time).

Note: *in case of configuring dimming limits (see section 2.2.2), the dimming times will be applied as follows:*

- *Transitions between 0% and the minimum dimming value will be instantaneous.*
 - *Transitions between the minimum dimming value and the maximum dimming value will take the proportional part of the parameterised dimming time (which must be understood as the time corresponding to the entire transition from 0% to 100%).*
- **Bus failure:** it is important to distinguish between the two bus failure types:
 - **KNX bus failure:** during the absence of the KNX bus, DALIBOX Broadcast 6CH/4CH will keep powering the DALI channels (even if the external power LED indicator remains off), thus making the ballast remain in the last dimming level. Note that timed actions will be stopped and will not be resumed when the KNX bus voltage is recovered.
 - **DALI bus failure:** this may happen if communication errors take place between the device and the ballasts, which may be due to **short-circuits** in the channel or to a **power supply failure**. In such cases, the ballasts will adopt a customisable dimming value named as **dimming value during DALI bus failure**.
 - **Functions:** it is possible to configure a set of custom functions per channel:

- **Error Objects:** enables or disables the error notification objects for each channel. See section 2.2.5.
- **Status Objects:** enabled or disables the status objects associated to each channel (On/Off and dimming value). See section 2.2.6.
- **Custom On/Off:** allows enabling two custom On/Off controls, with different dimming values and times. See section 2.2.7.
- **Timers:** allows defining timed or delayed on/off switches. See section 2.2.8.
- **Scenes/Sequences:** enables the configuration of up to ten custom dimming sequences and scenes. See section 2.2.9.
- **Lock:** enables a lock object, which allows locking and unlocking the output channel, i.e., disabling the control. See section 2.2.10.
- **Custom Initialization:** permits setting the initial state of the channels (or after a KNX bus failure). See section 2.2.11.
- **Modes:** allows enabling and configuring different operation modes: Standby, Auto Off and Burn-in. See section 2.2.12.

ETS PARAMETERISATION

After enabling the desired channels, their corresponding tabs will be shown, as in Figure 6.

The “Configuration” screen contains the following parameters:

- **Dimming Times:** three dimming times may be parameterised, through the following parameters:
 - **Dimming Time [n]:** sets dimming time n (1-3), between 1 and 255 (seconds or minutes).
 - **Dimming Time Objects:** enables three two-byte objects, named “[Ch] Dimming Time n ”, which allow changing the dimming times parameterised (between 1 and 255 minutes or seconds). This parameter is disabled by default.

- **Diming Value During DALI Bus Failure:** allows configuring the behaviour of the ballasts on the event of a DALI bus failure: “No Change” (by default); “Off” (which makes the ballast switch off) or “Defined Value” (the ballast will switch to a customisable value, between 0% and 100%).

DIMMING TIMES (from Minimum to Maximum)	
Dimming Time 1	5 s
Dimming Time 2	10 s
Dimming Time 3	15 s
Dimming Time Objects	<input type="checkbox"/>

BUS FAILURE	
Dimming Value During DALI Bus Failure	No Change

FUNCTIONS	
Error Objects	<input type="checkbox"/>
Status Objects	<input type="checkbox"/>
Custom On/Off	<input type="checkbox"/>
Timers	<input type="checkbox"/>
Scenes/Sequences	<input type="checkbox"/>
Lock	<input type="checkbox"/>
Custom Initialization	<input type="checkbox"/>
Modes	<input type="checkbox"/>

Figure 6. Channel “x”. Configuration

- **Functions:** checkboxes for enable or disable several additional functionalities for the channel (when active, more tabs and communication objects are incorporated):
 - **Error Objects:** see section 2.2.5.
 - **Status Objects:** see section 2.2.6.
 - **Custom On/Off:** see section 2.2.7.
 - **Timers:** see section 2.2.8.
 - **Scenes/Sequences:** see section 2.2.9.

- **Lock:** see section 2.2.10.
- **Custom Initialisation:** see section 2.2.11.
- **Modes:** see section 2.2.12.

2.2.2 LIMITS

DALIBOX Broadcast 6CH / 4CH allows configuring two different limit types:

- **Luminosity Limits:** they limit the luminosity ranges controlled by the ballast. These limits are not perceptible by the user, i.e., the dimming range for the KNX bus will still be 0-100%, and the dimming time between both ends (0% to 100%) will be exactly the dimming time parameterised.
 - **Ballast Physical Minimum:** minimum luminosity value that the ballast is actually able to produce, as specified by the manufacturer. This determines the actual luminosity level that will correspond to a dimming percentage of 1%.

***Note:** physical minimum must be configured as indicated in the ballast or in the datasheet.*
 - **Economic Mode:** maximum luminosity level the ballast will be allowed to reach. It determines the actual luminosity level that will correspond to a dimming percentage of 100%.
- **Dimming Limits:** perceptible limits that allow restricting the percentage value range of the control objects. Note that the actual meaning of the values of these objects depends itself on the luminosity limits configured. The effect of these limits over the dimming times is explained in section 2.2.1.
 - **Minimum Dimming Value:** lower dimming percentage allowed. The load will remain at this level in case of receiving a lower value (only switch-off orders will be handled).
 - **Maximum Dimming Value:** upper dimming percentage allowed. The load will remain at this level in case of receiving a greater value.

The dimming curve takes into account all the above limits.

ETS PARAMETERISATION

The tab 'Limits' has the following configurable options available:

Section	Parameter	Value	Unit/Scale
LUMINOSITY LIMITS	Ballast Physical Minimum	<input checked="" type="checkbox"/>	
	Minimum Luminosity Level	10	x 0,1%
	Economical Mode	<input checked="" type="checkbox"/>	
	Maximum Luminosity Level	1000	x 0,1%
DIMMING LIMITS	Minimum Dimming Value	0	%
	Maximum Dimming Value	100	%

Figure 7. Channel X. Limits

● Luminosity Limits:

- **Ballast Physical Minimum:** enables or disables the physical minimum of the channel.
- **Minimum Luminosity Level:** the available range is 1 to 100 tenths (0.1% to 10%).
- **Economical Mode:** enables or disables the economic mode.
- **Maximum Luminosity Level:** the available range is 100 to 1000 tenths (10% to 100%).

● Dimming Limits:

- **Minimum Dimming Value:** the available range is 0% to 100%.
- **Maximum Dimming Value:** the available range is 0% to 100%.

2.2.3 SWITCH ON/OFF

DALIBOX Broadcast 6CH / 4CH lets configuring the general On/Off switch control so that these actions are performed **immediately** or through a **smooth regulation** (according to one of the three configurable dimming times; see section 2.2.1).

Furthermore, it is possible to specify the luminosity level that the channel will adopt when a general switch-on order is executed: either a **fixed value** (configurable in parameters) or the **last value** prior to the switch-off (i.e., a memory switch-on). In addition, in case of selecting the latter, it is possible to select whether a **second switch-on order** should set the maximum dimming value.

ETS PARAMETERISATION

The following parameters are available in the “Switch On/Off” tab:

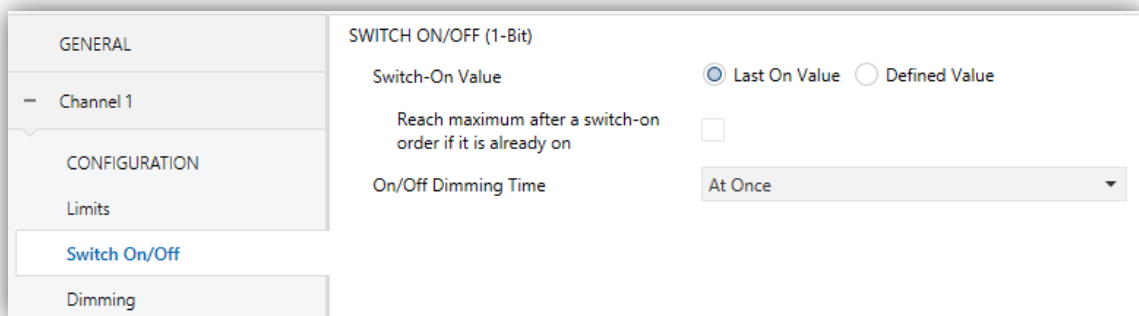

Figure 8. Channel “x”. Switch On/Off

● Switch On/Off (1 bit):

- **Switch On Value:** allows selecting the general dimming level that will be adopted by the channel when the value “1” is received through “[Ch] On/Off”. It can be “Last On Value” (default option) or “Defined Value”.
 - In case of selecting “Last On Value”:
 - **Reach Maximum after a Switch On Order if it’s Already On:** enables or disables the option to switch to the maximum dimming level through a second switch-on order.
 - In case of selecting “Defined Value”:
 - **Value:** the available range is 0% to 100%.
- **On/Off Dimming Time:** “At Once” (option by default) or “Dimming Time n ” (with $n=1,2,3$). See section 2.2.1.

2.2.4 DIMMING

DALIBOX Broadcast 6CH / 4CH provides two general dimming modes besides the general On/Off control:

- **Relative Dimming:** modifies the dimming level through orders to increment or decrement it by fixed percentages (“1.6%”, “3.1%”, “6.3%”, “12.5%”, “25%”, “50%” or “100%”), which will be added to or subtracted from the current dimming level of the channel. A **four-bit object** is provided for the reception of the relative dimming orders.

It is possible to select whether it will be possible to switch off a channel through a relative dimming order, in case the target value is lower than the minimum parameterized. If not enabled, the channel will remain at the minimum level parameterised.

- **Absolute dimming:** modifies the dimming level through orders that specify the desired target value, regardless of the current value of the channel. A **one-byte object** is provided for the reception of the absolute dimming orders.

For both dimming modes, the dimming time for the 0% to 100% transition may be selected among the three different dimming times already defined. An immediate transition can also be configured, if desired.

ETS PARAMETERISATION

The “Dimming” tab contains the following parameters:

GENERAL	RELATIVE DIMMING (4-Bit)
Channel 1	Relative Dimming Time Dimming Time 1
CONFIGURATION	Allow Switching Off via Relative Dimming <input checked="" type="checkbox"/>
Limits	ABSOLUTE DIMMING (1-Byte)
Switch On/Off	Absolute Dimming Time Dimming Time 2
Dimming	

Figure 9. Channel X. Dimming

- **Relative Dimming (4 bits):** this section allows setting up the configuration of the relative dimming function and the **four-bit** object “[Ch] Relative Dimming”.
 - **Relative Dimming Time:** “At Once”, “Dimming Time 1”, “Dimming Time 2”, “Dimming Time 3”. See section 2.2.1.
 - **Allow Switching Off via Relative Dimming:** sets whether the channel should be switched off in case a decrease order with a dimming value lower than the minimum value parameterised is received.

- **Absolute Dimming (1 byte):** this section allows setting up the configuration of the relative absolute dimming function and the **one-byte** object “[Ch] Absolute Dimming”.
 - **Absolute Dimming Time:** analogous to the above parameter.

2.2.5 ERROR OBJECTS

DALIBOX Broadcast 6CH / 4CH is able to **detect certain errors** that may occur during normal operation, which will be indicated through the on-board LEDs (please refer to ANNEX I. Error indicators). Moreover, in case of having parameterised it, these errors can be notified to the KNX bus too.

Blocking errors (short-circuit and lack of power supply) will interrupt all actions, including timed actions. Other errors will not interrupt them – they will still be executed by all connected ballasts that do not present errors.

2.2.5.1 SHORT-CIRCUIT ERROR (DALI ERROR)

The **short-circuit error** (or **DALI error**) is reported in case the communication is interrupted in the output channel, due to issues in the DALI bus. In such cases, the ballasts will acquire the value configured for DALI bus failure cases (see section 2.2.1).

While this error persists, the following errors will no longer be notified, due to a lack of communication with the ballasts:

- Ballast Error
- Lamp Error
- Open Circuit Error
- Ballast Overload Error

2.2.5.2 POWER SUPPLY ERROR

This error is reported when the external power supply is interrupted and therefore the DALI bus becomes non-functional. In such case, the ballasts will adopt the level configured for DALI bus failure cases (see section 2.2.1), as the ballasts have their own power supply. In case this is interrupted too, they will obviously switch off.

During the power supply error, the channel will not respond to control actions. Other error types will not be reported, either. Nevertheless, the lock objects (see section 2.2.10) will be taken into account so once the error is over the corresponding action can be performed.

Note that the detection of this error is enabled/disabled from the general settings of the device (see section 2.1), as it is not a per-channel error.

2.2.5.3 BALLAST OVERLOAD ERROR

The ballast detection process lets DALIBOX Broadcast 6CH / 4CH determine the number of ballasts present in the channel. This error will be reported in case of detecting **more than 20 ballasts in the same channel** (note, however, that this process may take up to one minute – the error may not be reported immediately).

This error does not interrupt the normal control of the channel, although abnormal behaviours may be expected in the installation.

Note: *in sporadic cases (e.g., depending on the wiring), the connection of a high number of ballasts may be detected as a short circuit (see section 2.2.5.1).*

2.2.5.4 OPEN CIRCUIT ERROR

The open circuit error indicates **the absence of ballasts in the channel** (either due to a breakdown, to an interruption in their power supply or to being the DALI bus circuit open) As in the above case, the detection of this may not be immediate, being possible that the device takes up to one minute to report it.

The open circuit error may also be reported in case all ballasts in the channel are under the ballast error (see section 2.2.5.6). In such case, both errors are reported.

2.2.5.5 LAMP ERROR

Lamp error is notified in case of **failure of at least one of the loads connected to the ballasts in the channel**. As above case, the detection of this may not be immediate.

The lamp error does not interrupt normal channel control nor timed actions, either.

Note: *not all ballasts are able to detect lamp failures (see section 1.3).*

2.2.5.6 BALLAST ERROR

DALIBOX Broadcast 6CH / 4CH notifies ballast error when at least one of the already detected ballasts in the channel no longer responds. The error is considered to be over once the number of the ballasts detected in the channel is, at least, equal to that prior to the error. The notification of this error is not immediate, being possible that the device takes up to one minute to report it.

The ballast error does not interrupt normal channel control nor timed actions, either.

Important:

- ***To let reducing the number of ballasts in the installation*** (which may cause a permanent ballast presence error), the Write flag of the communication object that reports this error has been enabled, so the error can be cleared by sending it the value "0". Whenever this happens, the device will assume the current number of ballasts as correct.

- ***To replace a defective ballast***, please proceed as follows:
 1. *Disconnect the defective ballast keeping DALIBOX Interface on.*
 2. *Wait for the detection of the ECG presence error (which may take up to 70 seconds).*
 3. *Clear the ballast presence error (via object or display).*
 4. *Connect the new ballast (it will be assigned the first DALI address available).*
 5. *Assign the new ballast the address of the removed ballast.*

If, despite following these steps, the new ballast is not detected correctly or is not well configured, disconnect it for at least one minute and reconnect it. Thus DALIBOX Interface will reconfigure it.

Note: ballasts with more than one DALI address (e.g., ballasts that control RGB modules) may cause abnormal situations during the ballast detection. Therefore, using them with DALIBOX Broadcast 6CH / 4CH is not recommended (in fact, under broadcast control it is not possible to regulate the colour components independently – only white light will be perceived).

ETS PARAMETERISATION

This section allows enabling the different channel-dependent error types that should be reported to the KNX bus. Note that general power supply error is enabled from the general device settings (see section 2.1).

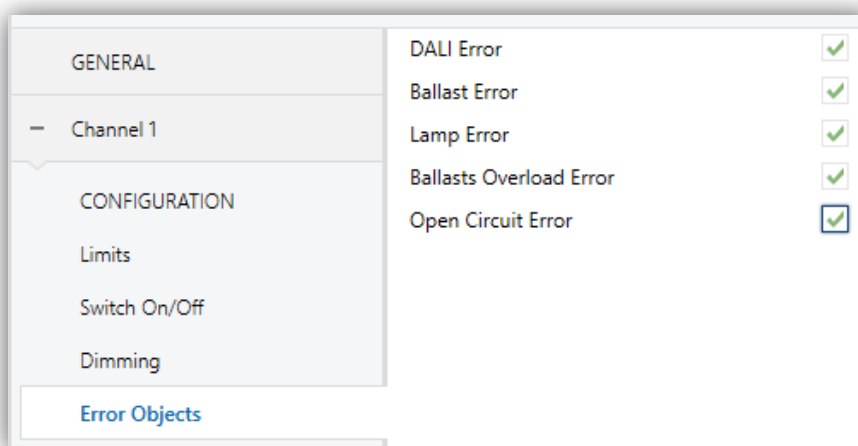

Figure 10. Channel “x”. Error Objects

- **DALI Error:** enables the “[Cx] Error: DALI Bus Failure” object, which will be sent periodically with value “1” in case of detecting communication errors or a short circuit in the DALI bus of the channel. After the error is over, it will be sent (once) with value “0”.
- **Ballast Error:** enables the “[Cx] Error: Ballast Failure” object, which will be sent periodically with value “1” in case of detecting a ballast failure in at least one of the ballasts connected to the channel. After the error is over, it will be sent (once) with value “0”.
- **Lamp Error:** enables the “[Cx] Error: Lamp Failure” object, which will be sent periodically with value “1” in case of detecting a lamp failure in at least one of the ballasts connected to the channel. After the error is over, it will be sent (once) with value “0”.

- **Ballast Overload Error:** enables the “[Cx] Error: Ballast Overload” object, which will be sent periodically with value “1” in case of detecting excessive ballasts connected to the channel. After the error is over, it will be sent (once) with value “0”.
- **Open Circuit Error:** enables the “[Cx] Error: Open Circuit” object, which will be sent periodically with value “1” in case of detecting a short circuit or a complete absence of ballasts in the channel. After the error is over, it will be sent (once) with value “0”.

2.2.6 STATUS OBJECTS

DALIBOX Broadcast 6CH / 4CH provides different objects that report the current dimming state of the output channel:

- A **one-bit object** (On/Off).
- A **one-byte object**, which indicates the dimming level (in percentage).

ETS PARAMETERISATION

After enabling this function, the following options will be available.

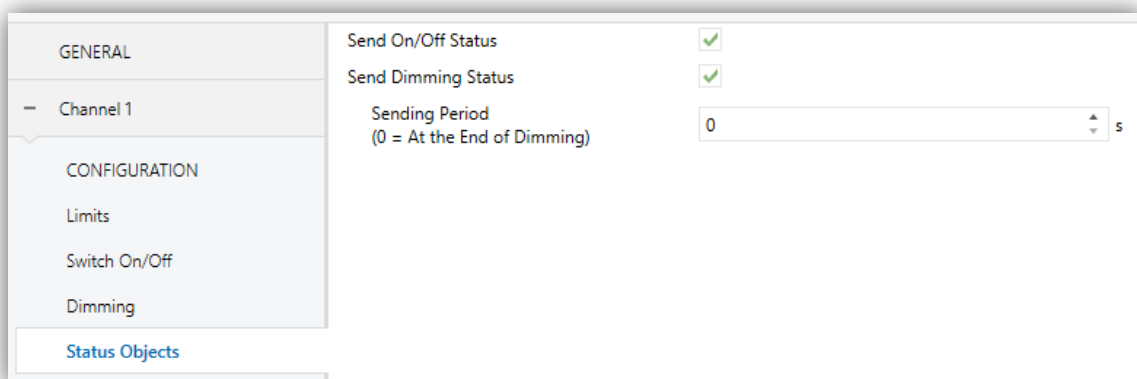

Figure 11. Channel “x”. Status Objects

- **Send On/Off Status:** enables a one-bit object (“[Cx] On/Off (Status)”) that will be sent whenever the channel is switched off (“0”) or on (“1”).
- **Send Dimming Status:** enables a one-byte object (“[Cx] Dimming Value (Status)”) that will be sent with the current channel dimming value (between

0% and 100%) whenever it changes. Enabling this parameter brings up an addition one:

- **Sending Period:** defines the sending cycle time (1 to 255 seconds) of the status object during a dimming process. If it is set to “0”, the dimming status will be sent only at the end of the dimming process.

2.2.7 CUSTOM ON/OFF

This function offers up to two additional On/Off controls for the output channel, and therefore up to two new communication objects to switch the ballasts on and off.

These additional controls can be customised with specific dimming levels for the “On” and “Off” states, and may also be configured to perform an immediate or soft dimming.

ETS PARAMETERISATION

Once the function has been enabled, the following parameters will show in ETS:

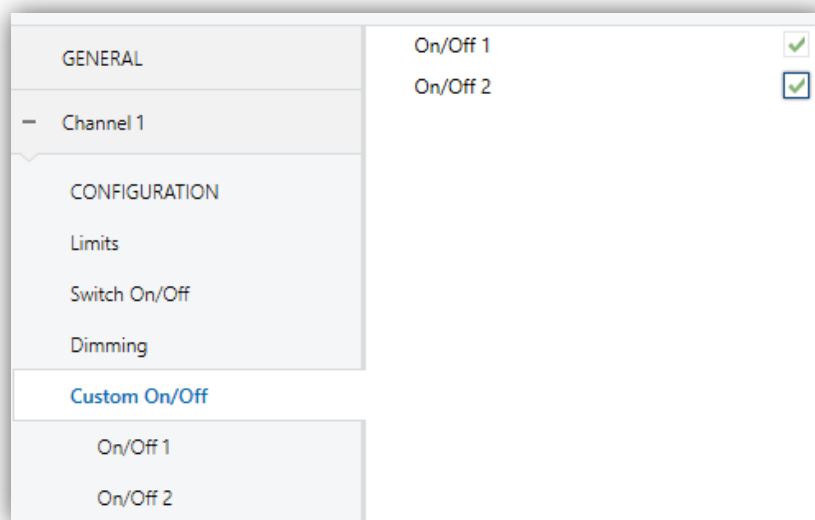

Figure 12. Channel “x”. Custom On/Off

- **On/Off ‘n’:** “Disabled” by default. Once enabled, the “[Cx] Custom On/Off ‘n’” one-bit object and a specific parameter tab will show in ETS.

This new screen allows setting up the specific behaviour when a “1” or a “0” are received through the aforementioned object:

GENERAL	Dimming Value for Bit Value '1'	100 %
Channel 1	Dimming Time for Bit Value '1'	At Once
CONFIGURATION	Dimming Value for Bit Value '0'	0 %
Limits	Dimming Time for Bit Value '0'	At Once
Switch On/Off		
Dimming		
Custom On/Off		
On/Off 1		
On/Off 2		

Figure 13. Custom On/Off 'n'

- **Dimming Value for Bit Value '1'**: sets a specific dimming percentage (0% to 100%) to be applied to the channel when a "1" is received.
- **Dimming Time for Bit Value '1'**: "At Once", "Dimming Time 1", "Dimming Time 2", "Dimming Time 3". See section 2.2.1.
- **Dimming Value for Bit Value '0'** and **Dimming Time for Bit Value '0'**: analogous to the above two parameters, but referred to the arrival of the value "0" from the bus.

2.2.8 TIMERS

This function allows configuring a **simple timer** and a **flashing sequence** in the output channel, being it possible to enable or disable both functions independently.

- The **simple timer** function consists in a switch-on of the channel (with an optional delay) on the reception of the corresponding trigger object, and a later switch-off, either automatic (after a certain period) or triggered through the corresponding bus object, also with an optional delay in this case.
- On the other hand, the **flashing** function consists in switching the channel on and off a certain number of times or indefinitely, according to the parameters, once the corresponding object is received.

ETS PARAMETERISATION

After enabling this option, the following parameters will show in ETS:

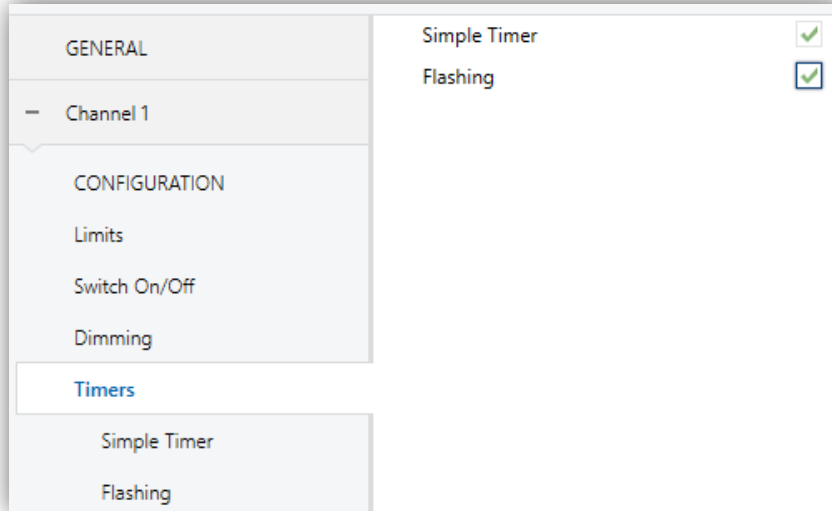

Figure 14. Channel “x”. Timers

Simple Timer and **Flashing** are disabled by default. Once enabled, the “[Cx] Simple Timer” and “[Cx] Flashing” one-bit objects are added to the project topology. An additional parameter tab for each option shows up too.

Simple Timer

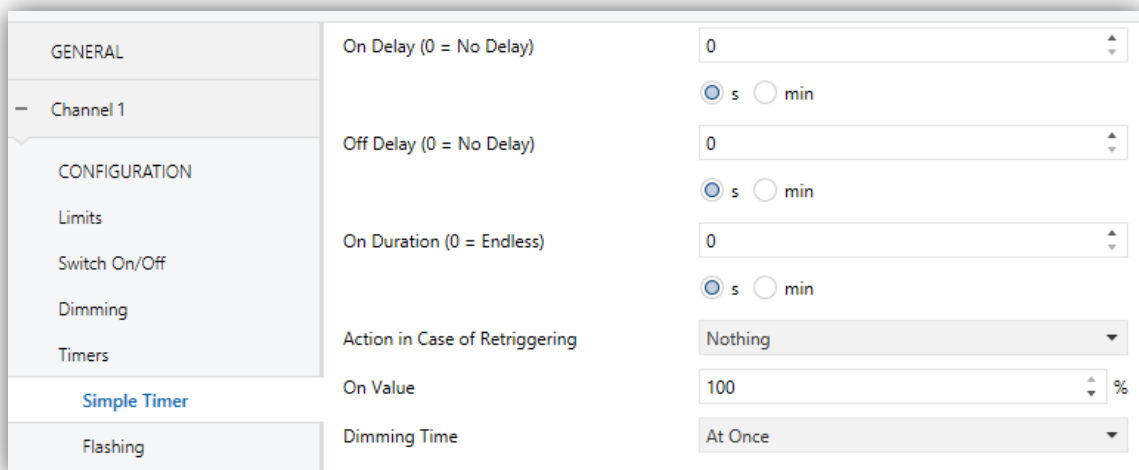

Figure 15. Simple Timer

Once the simple timer function has been enabled, the “[Cx] Simple Timer” one-bit object becomes enabled too, making it possible to trigger a switch-on by sending it the value “1” or a switch-off by sending it the value “0”. Both actions can be delayed according to the following parameters:

- **On Delay:** sets a delay between the reception of the simple timer trigger order (value “1” through object “[Cx] Simple Timer”) and the actual switch-on of the channel, in the range 0 to 255 seconds or minutes.
- **Off Delay:** sets a delay between the reception of the simple timer stop order (value “0” through object “[Cx] Simple Timer”) and the actual switch-off of the channel, in the range 0 to 255 seconds or minutes.
- **On Duration:** sets the time the output channel must remain on before being automatically switched off (unless the value “0” is received through “[Cx] Simple Timer”, which will switch the channel off immediately), in the range 0 to 255 seconds or minutes. The value “0” (default option) will disable the automatic switch-off, thus making the channel remain on.
- **Action in Case of Retriggering:** sets the action to be performed in case the value “1” is received several times.
 - **Nothing:** the current time count will not be restarted.
 - **Restart:** the time count of the On Duration will be restarted from zero.
 - **Multiply:** the time count of the On Duration will become ‘n’ times the configured time, being ‘n’ the number of times the value “1” is received.
- **On Value:** sets a specific dimming percentage (0% to 100%) to be applied to the channel during the “on” stage.
- **Dimming Time:** “At Once”, “Dimming Time 1”, “Dimming Time 2”, “Dimming Time 3” (see “Dimming times” in section 2.2.1).

Note: *the simple timer function will be interrupted whenever any other dimming action is commanded, no matter if it falls within the On Duration or during the On/Off delays.*

Example:

- On delay: 2 s.
- Off delay: 2 s.
- On duration: 4 s.
- On value: 100%.
- Dimming time: immediate.

Assuming that the “1” labels correspond to the arrivals of the value “1” through the “[Cx] Simple Timer” and that the “0” labels correspond to the arrival of the value “0”, the expected behaviour will be:

Action in case of retriggering: nothing

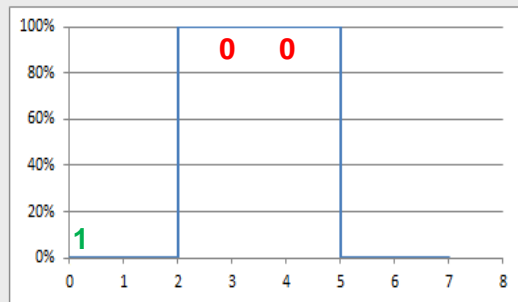
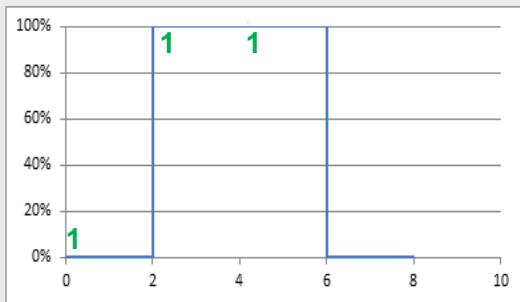

Action in case of retriggering: restart

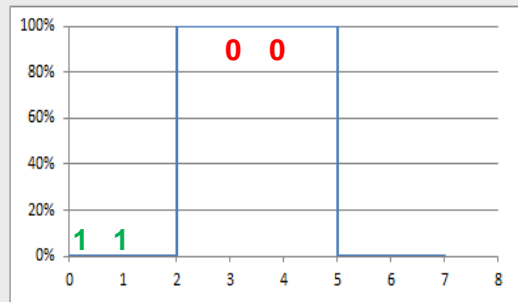
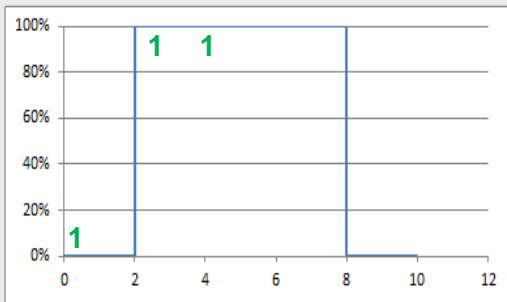

Action in case of retriggering = multiply

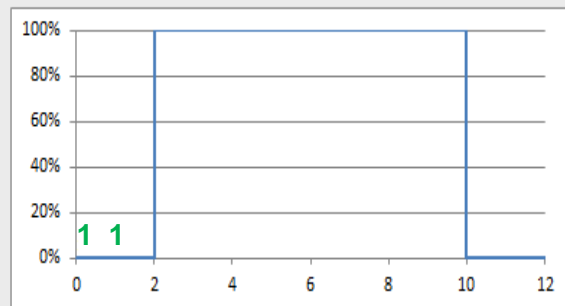
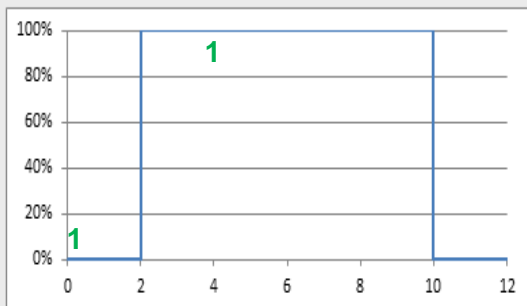

Flashing

Once the flashing function has been enabled, the “[Ch] Flashing” one-bit object will turn visible in order to let triggering an On-Off-On... sequence by sending it the value “1”, as well as interrupting it by sending it the value “0” The options for this function are the following:

GENERAL	On Duration	1
Channel 1		<input checked="" type="radio"/> s <input type="radio"/> min
CONFIGURATION	Off Duration	1
Limits		<input checked="" type="radio"/> s <input type="radio"/> min
Switch On/Off	Repetitions (0 = Endless)	0
Dimming	On Value	100 %
Timers	Final Value	0 %
Simple Timer		
Flashing		

Figure 16. Flashing

- **On Duration:** sets the length of each “On” stage during the sequence, in the range 1 to 255 seconds or minutes.
- **Off Duration:** sets the length of each “Off” stage during the sequence, in the range 1 to 255 seconds or minutes.
- **Repetitions:** sets the number of iterations of the sequence, between 0 and 255. The value “0” (default option) causes an endless repetition, until an order to interrupt the sequence is received.
- **On Value:** sets a specific dimming percentage (0% to 100%) to be applied to the channel during the “On” stages.
- **Final Value:** sets a specific dimming value (0% to 100%) to be applied to the channel after the last repetition or after the reception of one “0” through the “[Cx] Flashing” communication object.

2.2.9 SCENES/SEQUENCES

This feature allows defining different scenes (i.e., specific ambiances or dimming sequences), which can be activated by sending the corresponding trigger values to a **one-byte object**.

DALIBOX Broadcast 6CH / 4CH offers **up to ten** configurable scenes / sequences per channel.

ETS PARAMETERISATION

The “Scenes/Sequences” tab in ETS contains the following parameters:

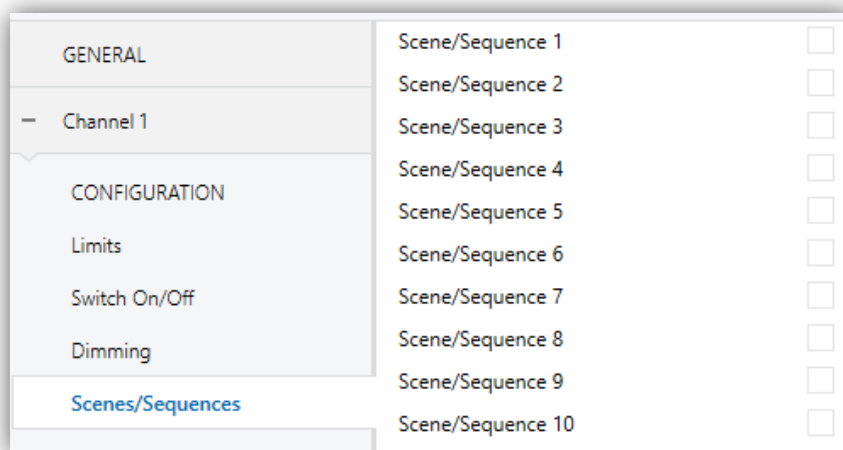

Figure 17. Channel “x”. Scenes/Sequences

Each scene / sequence activated from this screen will have a specific tab associated, labelled as “**Scene/Sequence ‘n’**” and containing the following parameters:

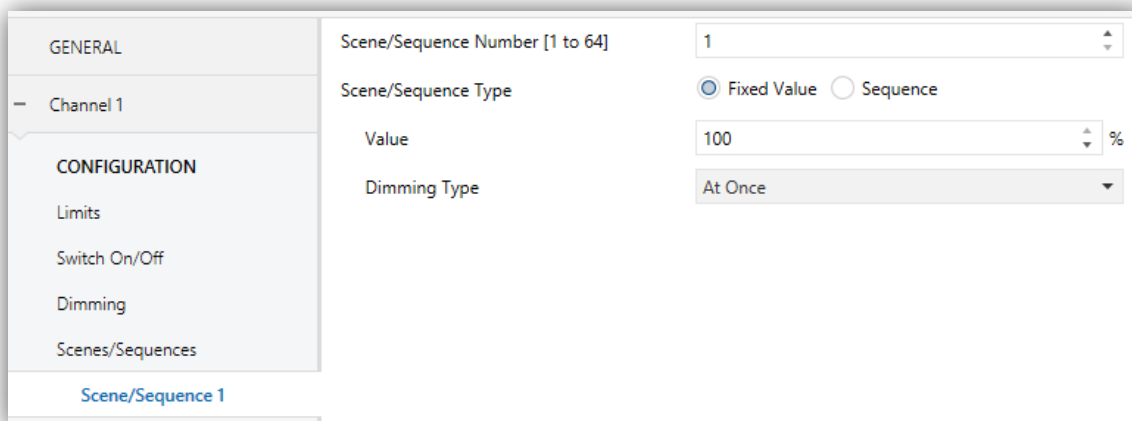

Figure 18. Scene configuration

- **Scene/Sequence Number:** sets the scene/sequence identifying number (from 1 to 64) whose reception (decreased by 1, according to the KNX standard) through the “[Cx] Scenes/Sequences” object will make the device trigger the scene/sequence.
- **Scene/Sequence Type:** selects the action desired for the activation of the scene/sequence:
 - **“Fixed Value”:** the scene activation will consist in setting a fixed dimming value (0% to 100%) in the channel, according to the following parameters:
 - **Value:** sets the desired dimming percentage.
 - **Dimming Type:** “At Once”, “Dimming Time 1”, “Dimming Time 2”, “Dimming Time 3”. See section 2.2.1.

In this case it will be also possible to **save scenes**. If a scene saving order (values 128 to 191) is received, the current dimming level of the channel will be taken into account for later triggers of the corresponding scene.

- **“Sequence”:** brings the option to define sequences of **up to five steps**, and to configure the following parameters:
 - **Cyclic:** “Enabled” (after the last step, the sequence will start over) or “Disabled” (default option; in such case, after the last step, it will be possible to automatically trigger any other sequence parameterised).
 - **Next Sequence:** only available if **Cyclic** has been disabled; allows the execution of another sequence after the last step of the current sequence. The options are “No Sequence” and “Sequence ‘n’” (being ‘n’ a value between 1 and 10).

Additionally, each individual step offers the following parameters:

- **Action n:** enables or disables step number n (with n between 1 and 5).
- **Value:** analogous to the equivalent option in static scenes.
- **Dimming Type:** “At Once”, “Dimming Time 1”, “Dimming Time 2”, “Dimming Time 3”, “Equal to Action Time” (the transition will last for the proportional part of the action time configured below, which is interpreted as the length of an entire transition from 0% to 100%) and

“Dimming Throughout the Action” (the dimming speed will adapt so that transition lasts for all the action time configured).

- **Action time:** defines the duration of the action, i.e., the time it will take until the next action begins execution. The available range is 1 to 100 seconds or minutes.

Note: *in the event of an action time greater than the selected **Dimming Type** time, the channel dimming level will remain unchanged until this time is over.*

Actions will be run in order (starting from the first one), once DALIBOX Broadcast 6CH / 4CH receives through “[Cx] Scenes/Sequences” the value that triggers the sequence. Finally, if the sequence is cyclic, once the last action ends, the entire sequence will be restarted.

An example of custom sequence configuration is shown in Figure 19.

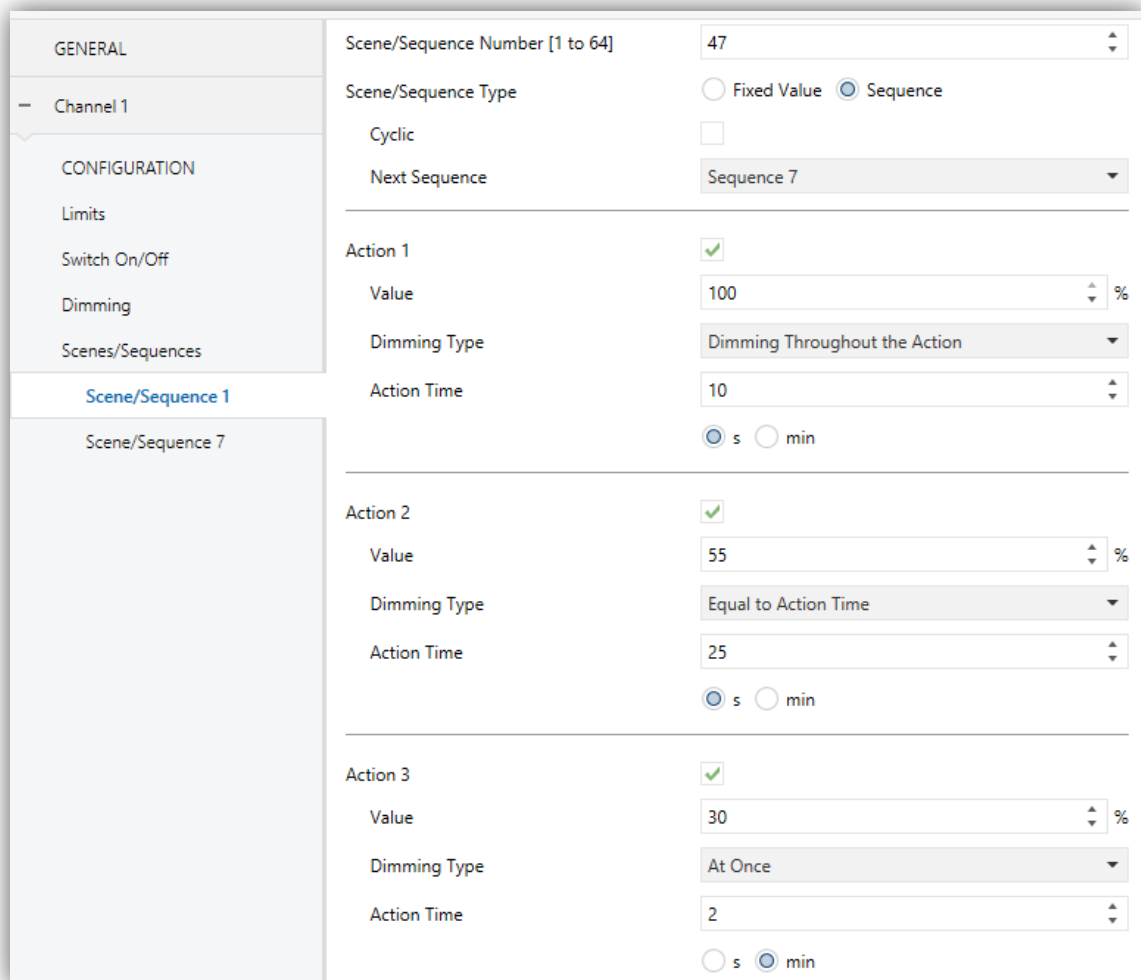

Figure 19. Sequence Example

Once this function has been enabled, the following objects will show in ETS:

- “[Cx] Scenes/Sequences” (one byte): will trigger the scene or sequence whose scene number is received through the object (see below).
- “[Cx] Start/Stop Sequence” (one bit): allows starting the last sequence performed, or restarting the one currently running (by sending the value “1”), as well as interrupting the current sequence (value “0”).

Note: the “[Cx] Start/Stop Sequence” object only applies to sequences, and has no effect over static scenes. Moreover, after a download from ETS (partial or complete), if the value “1” is sent through this object, DALIBOX Broadcast 6CH / 4CH will trigger the first, non-static sequence parameterised.

2.2.10 LOCK

Enabling the lock function will bring a **one-bit** object which will allow locking and unlocking the related channel. Channel locking causes that any bus orders addressing to that channel are ignored.

Receiving a lock order while running a sequence, a flashing sequence or a timed action **will stop the execution of that action.**

ETS PARAMETERISATION

Once this function has been enabled, the following options will show in ETS:

GENERAL	Lock Object Polarity	<input checked="" type="radio"/> 0 = Unlock; 1 = Lock	<input type="radio"/> 0 = Lock; 1 = Unlock
Channel 1	Behaviour at Locking	No Change	
CONFIGURATION	Behaviour at Unlocking	No Change	
Limits			
Switch On/Off			
Dimming			
Lock			

Figure 20. Channel “x”. Lock

- **Lock Object Polarity:** sets which value will be interpreted as a lock order and which one as an unlock order: “0 = Unlock; 1 = Lock” (default) or “0 = Lock; 1 = Unlock”.
- **Behaviour at Locking:** sets the action to be performed when a lock order is received: “No Change” (default option), “Off” (the channel will be switch off), “On” (the channel will be switched on) or “Defined Value” (a value between 0% and 100% will be parameterisable).
- **Behaviour at Unlocking:** sets the action to be performed when an unlock order is received. The options are analogous to those for locking, but will also comprise the following two: “Previous State” (to recover the status previous to the lock order) and “Last Order” (to apply the status corresponding to the last order received during the lock state; in case of not having received any order during the lock state, the previous status before locking will be recovered).

2.2.11 CUSTOM INITIALISATION

This function lets customising the state of the channel after the start-up of the device.

Opting for the **default initial configuration** implies the following:

- After an ETS download, the channel will remain off.
- After recovering from a KNX bus power failure, the channel will recover the state previous to the power failure.

On the other hand, opting for a **custom initial configuration** allows parameterising the desired state after the bus power is restored or after a download.

Note: *KNX bus failures do not switch off the ballasts, unless their own power supply is interrupted (see section 2.2.5).*

ETS PARAMETERISATION

Once the option to customise the initial configuration has been enabled (otherwise, the default configuration will be applied) the following objects will show in ETS:

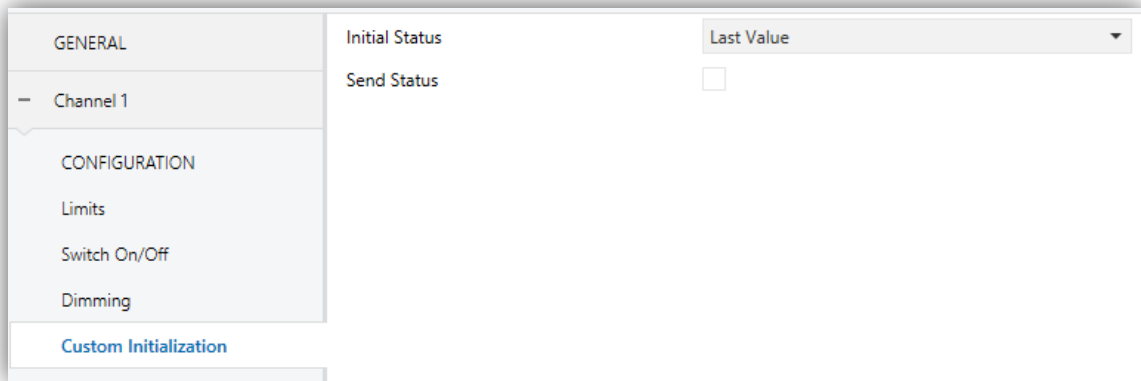

Figure 21. Channel “x”. Custom initialization

- **Initial Status:** sets the desired initial state of the channel:
 - **“Last”** (default value): when the KNX bus power is restored, the channel will recover the dimming state previous to the bus failure. Note that this option has no effect after a download (the channel will remain off).
 - **“Off”**: the channel will always start switched off.
 - **“Defined Value”**: the channel will start at a specific dimming level (between 0% and 100%), configured in **“Value”**.
- **Send Status:** if enabled, the status objects will be sent to the bus at the start-up to inform about the initial state of the channel. This requires that the status objects have been enabled (see section 2.2.6).
 - **Delay:** sets a delay (in seconds) before performing this sending.

2.2.12 MODES

DALIBOX Broadcast 6CH / 4CH implements three special operation options (already introduced in section 2) named as **Standby mode**, **Burn-in mode** and **Auto-Off mode**, each of which is explained in detail next.

2.2.12.1 STANDBY MODE

The Standby mode can be enabled independently for each channel. When enabled, DALIBOX Broadcast 6CH / 4CH sends a one-bit object to the KNX bus thirty seconds after the channel is switched off. This allows making use of an external actuator to

interrupt the power supply of the ballasts, thus reducing the power consumption. The object will be sent once again (with the inverse value) as soon as the channel is switched on again. Note that enabling this function may make the channel switch-on last a little longer than expected.

The following diagram illustrates how the devices should be wired:

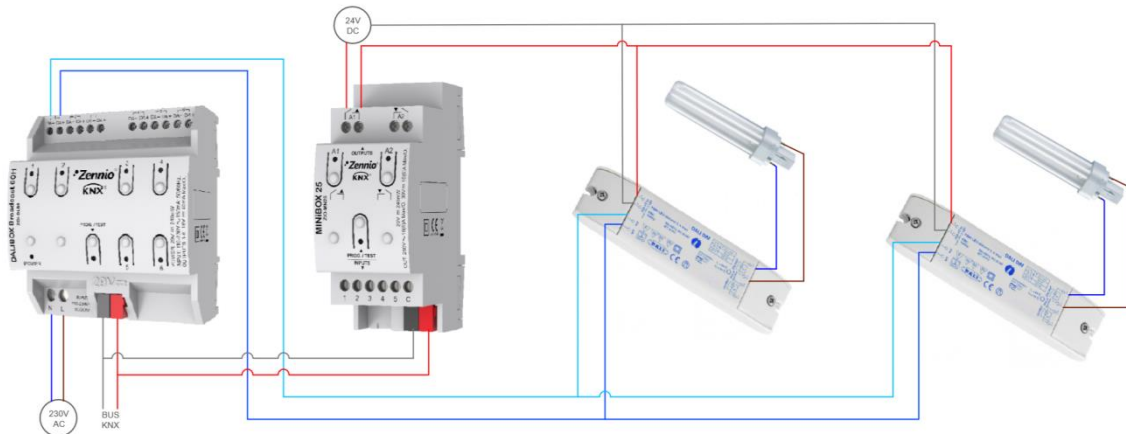

Figure 22. Standby Scheme

On the other hand, during the device **start-up**, the Standby object will be sent as **inactive** to make it possible that the ballasts are powered during their initialisation. Some other situations imply sending the Standby object:

- A power supply error,
- A short-circuit error (DALI error),
- During the **Burn-In mode** (see section 2.2.12.2). If the Standby function has been enabled, the Burn-In mode will last 500 ms longer, to make sure the ballasts are powered for at least the parameterised burn-in time.
- During the **Test On mode** (see section 2.1).

It is important to note that this functionality may have certain consequences over ballast replacements or channel error detections. For example:

- While the Standby mode remains active (i.e., while the ballast power supply remains interrupted), **DALI-related errors** such as ballast errors, lamp errors, ballast overload or open circuit errors will no longer be detected in that channel.

- During **ballast initialisation** or DALI address assignment, any attempts to activate the Standby mode will be postponed by 30 seconds, as many times as necessary until such process is finished.

The following example illustrates how the Standby mode works:

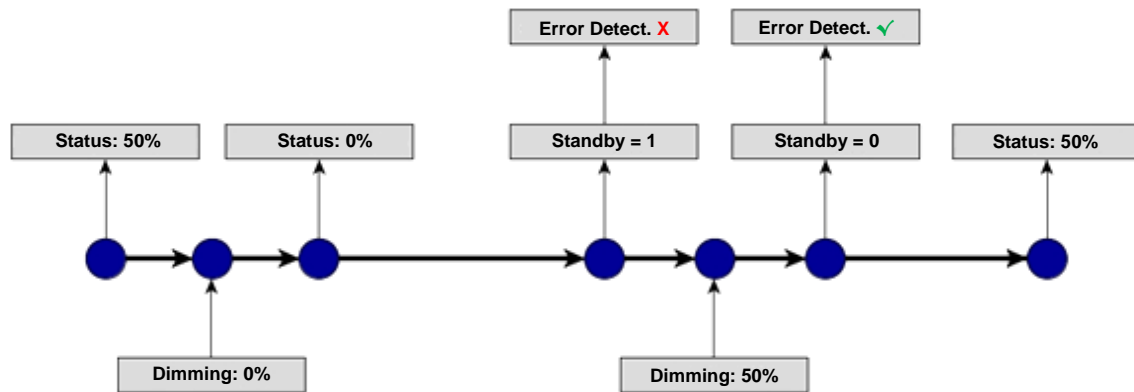

Figure 23. Standby mode action sequence

2.2.12.2 BURN-IN MODE

The Burn-in mode is intended for certain lamp types such (as steam lamps) which need to remain on for a certain time period **before performing any light dimming**. Before the channel has been (steadily) switched on for at least the configured time, it will only be possible to **switch the loads off or to regulate them to 100%**.

In case of having configured any **limits** (either luminosity limits or dimming limits; see section 2.2.2), they will not be considered while the Burn-in mode is in operation, i.e., the loads will be actually switched on entirely. However, they will be applied once the Burn-in mode is over, which will may be perceived as a slight change in the light level.

This functionality entails certain effects over in other functionalities (while the Burn-in mode remains active, any dimming order greater than 0% will be executed as an immediate regulation to 100%, or to 0% in other case):

- Relative and absolute dimming.
- Simple timers and flashing.
- Lock/unlock actions.
- Initialisation.
- Test On and Test Off Modes.

An object is provided to force the activation or deactivation of the Burn-in mode at any time.

2.2.12.3 AUTO OFF MODE

The Auto Off mode allows an automatic switch-off of the channel if it is found to be steady (i.e., without receiving further dimming orders) at a certain dimming value –or threshold– for at least a certain amount of time (configurable).

This function will not take place while any of the following is active:

- Power Supply Error
- DALI Error
- Test On Mode
- Device lock
- Burn-in Mode active
- Timers

ETS PARAMETERISATION

Once the Modes option has been enabled, the following parameters will show in ETS:

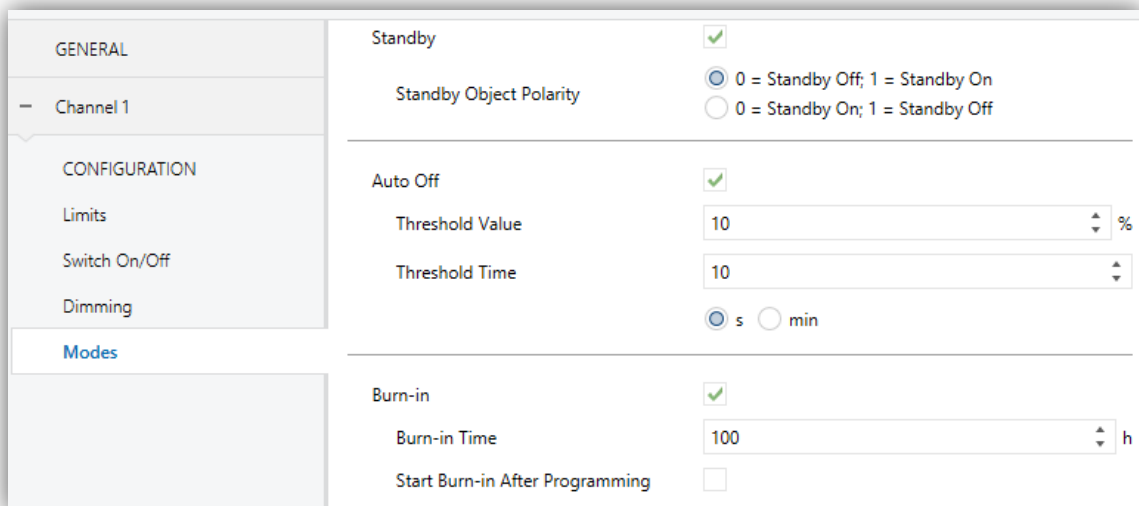

Figure 24. Channel “x”. Modes

- **Standby:** allows enabling the Standby function. In such case, the following parameter appears:

- **Standby Object Polarity:** sets value will be sent (through “[Cx] Standby State”) on the activation and the deactivation of the Standby mode: “0 = Standby Off; 1 = Standby On” or “0 = Standby On; 1 = Standby Off”.

Note: *unless a joint control of the different channels is intended, grouping together all their Standby objects is not advisable, as it will cause open circuits in the other channels whenever one of them is switched off.*

- **Auto Off:** allows enabling the Auto Off function. In such case, the following parameters will show:
 - **Threshold Value:** dimming value (between 1% and 100%, with 10% as the default value) beneath which the Auto Off will be triggered in case the channel remains steady at that value for more than the threshold time.
 - **Threshold Time:** time count before triggering the Auto Off mode, between 1-255 seconds or minutes (10 seconds by default).
- **Burn-in:** allows enabling the Burn-in function. In such case, two new objects become available:
 - “[Cx] Burn-in Mode (Status)”, which will be sent when the channel enters (value “1”) or leaves (value “0”) the Burn-in mode.
 - “[Cx] Burn-in Mode”, which allows forcing the activation (value “1”) or deactivation (value “0”) of the Burn-in mode at any time, as well as restarting the time count in case it is already active.

The following parameters will also be available:

- **Burn-in Time:** sets the time the Burn-in mode should last, between 1 and 255 hours (100 h by default).
- **Start Burn-in After Programming:** sets whether the start-up actions configured (see section 2.2.11) should be applied the Burn-in restrictions or not.

ANNEX II. COMMUNICATION OBJECTS

- “**Functional range**” shows the values that, with independence of any other values permitted by the bus according to the object size, may be of any use or have a particular meaning because of the specifications or restrictions from both the KNX standard or the application programme itself.

Note: objects related to channels 5 and 6 (numbers 95-140) are only present in DALIBOX Broadcast 6CH.

Number	Size	I/O	Flags	Data type (DPT)	Functional Range	Name	Function
1	1 Bit	O	CTR--	DPT_Alarm	0/1	Error: Power Supply	0 = No Error; 1 = Error
2	1 Bit	I	C--W-	DPT_Enable	0/1	Manual Control Lock	0 = Unlock; 1 = Lock
	1 Bit	I	C--W-	DPT_Enable	0/1	Manual Control Lock	0 = Lock; 1 = Unlock
3, 26, 49, 72, 95, 118	1 Bit	I	C--W-	DPT_Switch	0/1	[Cx] On/Off	0 = Off; 1 = On
4, 27, 50, 73, 96, 119	4 Bit	I	C--W-	DPT_Control_Dimming	0x0 (Stop) 0x1 (Dec. by 100%) 0x2 (Dec. by 50%) 0x3 (Dec. by 25%) 0x4 (Dec. by 12%) 0x5 (Dec. by 6%) 0x6 (Dec. by 3%) 0x7 (Dec. by 1%) 0x8 (Stop) 0x9 (Inc. by 100%) 0xA (Inc. by 50%) 0xB (Inc. by 25%) 0xC (Inc. by 12%) 0xD (Inc. by 6%) 0xE (Inc. by 3%) 0xF (Inc. by 1%)	[Cx] Relative Dimming	4-Bit Dimmer Control
5, 28, 51, 74, 97, 120	1 Byte	I	C--W-	DPT_Scaling	0% - 100%	[Cx] Absolute Dimming	1-Byte Dimmer Control
6, 29, 52, 75, 98, 121	1 Bit	O	CTR--	DPT_Switch	0/1	[Cx] On/Off (Status)	0 = Off; 1 = On
7, 30, 53, 76, 99, 122	1 Byte	O	CTR--	DPT_Scaling	0% - 100%	[Cx] Dimming Value (Status)	0 - 100%
8, 9, 10, 31, 32, 33, 54, 55, 56, 77, 78, 79, 100, 101, 102, 123, 124, 125	2 Bytes	I	C--W-	DPT_TimePeriodSec	0 - 65535	[Cx] Dimming Time X	Time in Seconds
11, 12, 34, 35, 57, 58, 80, 81, 103, 104, 126, 127	1 Bit	I	C--W-	DPT_Switch	0/1	[Cx] Custom On/Off X	0 = Off; 1 = On
13, 36, 59, 82, 105, 128	1 Bit	I	C--W-	DPT_Start	0/1	[Cx] Simple Timer	0 = Deactivate; 1 = Activate
14, 37, 60, 83, 106, 129	1 Bit	I	C--W-	DPT_Start	0/1	[Cx] Flashing	0 = Deactivate; 1 = Activate
15, 38, 61, 84, 107, 130	1 Byte	I	C--W-	DPT_SceneControl	0-63; 128-191	[Cx] Scenes/Sequences	Scene/Sequence Number

16, 39, 62, 85, 108, 131	1 Bit	I	C--W-	DPT_Start	0/1	[Cx] Start/Stop Sequence	0 = Stop; 1 = Start
17, 40, 63, 86, 109, 132	1 Bit	I	C--W-	DPT_Enable	0/1	[Cx] Lock	0 = Unlock; 1 = Lock
	1 Bit	I	C--W-	DPT_Enable	0/1	[Cx] Lock	0 = Lock; 1 = Unlock
18, 41, 64, 87, 110, 133	1 Bit	O	CTR--	DPT_State	0/1	[Cx] Standby (Status)	0 = Standby On; 1 = Standby Off
	1 Bit	O	CTR--	DPT_State	0/1	[Cx] Standby (Status)	0 = Standby Off; 1 = Standby On
19, 42, 65, 88, 111, 134	1 Bit	I	C--W-	DPT_Start	0/1	[Cx] Burn-in Mode	0 = Stop Burn-in ; 1 = Start Burn-in
20, 43, 66, 89, 112, 135	1 Bit	O	CTR--	DPT_State	0/1	[Cx] Burn-in Mode (Status)	0 = Burn-in Inactive; 1 = Burn-in Active
21, 44, 67, 90, 113, 136	1 Bit	O	CTR--	DPT_Alarm	0/1	[Cx] Error: Open Circuit	0 = No Error; 1 = Error
22, 45, 68, 91, 114, 137	1 Bit	O	CTR--	DPT_Alarm	0/1	[Cx] Error: Ballasts Overload	0 = No Error; 1 = Error
23, 46, 69, 92, 115, 138	1 Bit	I/O	CTR W-	DPT_Alarm	0/1	[Cx] Error: Ballast Failure	0 = No Error; 1 = Error
24, 47, 70, 93, 116, 139	1 Bit	O	CTR--	DPT_Alarm	0/1	[Cx] Error: Lamp Failure	0 = No Error; 1 = Error
25, 48, 71, 94, 117, 140	1 Bit	O	CTR--	DPT_Alarm	0/1	[Cx] Error: DALI Bus Failure	0 = No Error; 1 = Error
141	1 Bit		CT---	DPT_Trigger	0/1	[Heartbeat] Object to Send '1'	Sending of '1' Periodically

Join and send us your inquiries
about Zennio devices:

<http://support.zennio.com>

Zennio Avance y Tecnología S.L.

C/ Río Jarama, 132. Nave P-8.11
45007 Toledo (Spain).

Tel. +34 925 232 002

www.zennio.com
info@zennio.com



RoHS