

DIMinBOX DX2 / DX4

2-Channel / 4-Channel Universal Light Dimmer

**ZDI-DBDX2
ZDIDBDX4**

DIMinBOX DX2 application program version: [1.1]

DIMinBOX DX4 application program version: [1.0]

User manual edition: [1.1]_b

CONTENTS

Contents	2
Document Updates	4
1 Introduction	5
1.1 DIMinBOX DX2 and DIMinBOX DX4	5
1.2 Load Types.....	7
1.2.1 Combining Load Types.....	7
1.3 Installation.....	9
2 Configuration	11
2.1 General.....	11
2.2 Channel Cx / Channel Cx + Cy / Channel C1 + C2 + C3 + C4	16
2.2.1 Dimming	16
2.2.2 Characteristic Curve	20
2.2.3 Configuration.....	22
2.2.4 Status Objects.....	23
2.2.5 Custom On/Off	24
2.2.6 Simple Timer.....	25
2.2.7 Flashing.....	27
2.2.8 Scenes/Sequences.....	29
2.2.9 Lock Channel.....	32
2.2.10 Alarms.....	33
2.2.11 Auto Off	36
2.2.12 Initialisation	37
2.3 Error Notifications.....	39

2.3.1	Bus Notifications.....	39
2.3.2	LED Indicators.....	39
2.3.3	Reaction to Errors.....	42
2.4	Inputs (only in DIMinBOX DX2).....	46
2.4.1	Binary Input.....	46
2.4.2	Temperature Probe.....	47
2.4.3	Motion Detector.....	47
2.5	Logic Functions.....	48
2.6	Manual Control.....	49
2.6.1	Test On Mode.....	50
2.6.2	Test Off Mode.....	50
ANNEX I: Communication Objects of DIMinBOX DX2.....		51
ANNEX II: Communication Objects of DIMinBOX DX4.....		58

DOCUMENT UPDATES

Version	Changes	Page(s)
[1.1]_b	New device: DIMinBOX DX4 . Changes in the DIMinBOX DX2 application program: <ul style="list-style-type: none">• Change from “Dimming Speed” to “Smooth Dimming Time” objects.	19
[1.1]_a	Changes in the DIMinBOX DX2 application program: <ul style="list-style-type: none">• Heartbeat functionality added.• New parameter “Advanced power supply control”.• Minor DPTs modifications.	-

1 INTRODUCTION

1.1 DIMinBOX DX2 and DIMinBOX DX4

DIMinBOX DX2 or **DIMinBOX DX4** are two universal, **two-channel** or **four-channel**, respectively, multi-function KNX light dimmer from Zennio. Its wide variety of functions make them versatile and robust devices.

- Compatibility with **resistive (R)**, **inductive (L)**, **capacitive (C)**, **LED*** and low-consumption **CFL*** loads.

(*) Only dimnable LED / CFL lamps are supported.

- Maximum **per-channel power**:
 - At 230 VAC: 310 W for all load types.
 - At 110 VAC: 200 W for all load types.
- **High-performance regulation**: the device is entirely powered from the KNX bus, which prevents limitations and other effects over the load power.
- Automatic **frequency detection**.
- Possibility of automatic load type **detection** for conventional lamps (R / C / L),
- Compatibility with **Uninterruptible Power Supply** systems (UPS).
- Customisable **dimming pattern** for LED and CFL loads,
- Customisable **dimming times**.
- **Individual** or **joint** control of the two output channels,
- **Additional functions**: timed actions, scenes, custom On/Off controls, automatic switch-off, sequences, economy mode, channel lock...
- **Manual operation and supervision** of the loads through the on-board pushbuttons.
- 10 customisable, multi-operation **logic functions**.

- Automatic **error management** (short-circuits, overheating, anomalous network frequencies, overvoltage, absence of power supply and wrong load type selection).
- LED **indicators** to show error situations.
- 2 **multi-purpose inputs**, configurable as (only in DIMinBOX DX2):
 - Temperature probes,
 - Binary inputs (i.e., pushbuttons, switches, sensors),
 - Motion detectors.
- Data storage and load switch-off on **bus power losses**.
- **Heartbeat** or periodical “still-alive” notification.

1.2 LOAD TYPES

DIMinBOX DX2 / DX4 supports the following load types:

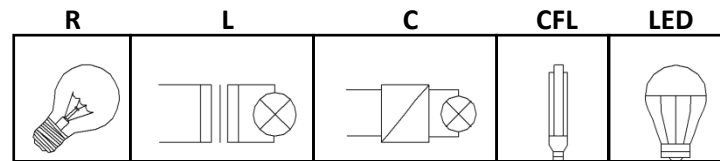

Figure 1 Load Types

- **Conventional lamps:**
 - Resistive (R),
 - Inductive (L),
 - Capacitive (C),
- Dimmable low-consumption **Compact Fluorescent Lamps (CFL)**.
- Dimmable Light Emitting Diode (**LED**) lamps.

1.2.1 COMBINING LOAD TYPES

In some cases, it is possible to combine different load types in the same channel (i.e., it is possible to control loads of different types together) as long as the following restrictions are satisfied:

- Inductive (L) and resistive (R) loads **can** be combined if the resistive load is less than 50% of the total load.
- Capacitive (C) and resistive (R) loads **can** be combined if the resistive load is less than 50% of the total load.
- Capacitive (C) and inductive (L) loads **cannot** be combined.
- CFL and LED loads **cannot** be combined.
- CFL and conventional (R / L / C) loads **cannot** be combined.
- LED and conventional (R / L / C) loads **cannot** be combined.

- It is advisable **not to combine** different CFL (or LED) loads together in the same channel, as the response may differ depending on the model or maker.

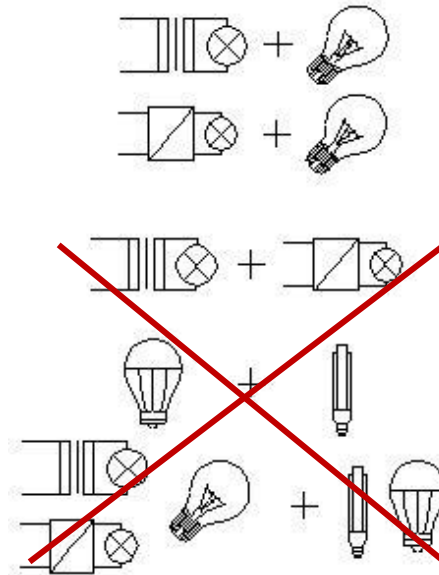

Figure 2. Combining Load Types.

To get further information, please refer to the corresponding **Datasheet**, bundled with the original package of the device and also available at www.zennio.com.

1.3 INSTALLATION

DIMinBOX DX2 / DX4 connects to the KNX bus through the on-board KNX connector. Once the device is provided with power from the KNX bus, both the individual address and the associated application program can be downloaded.

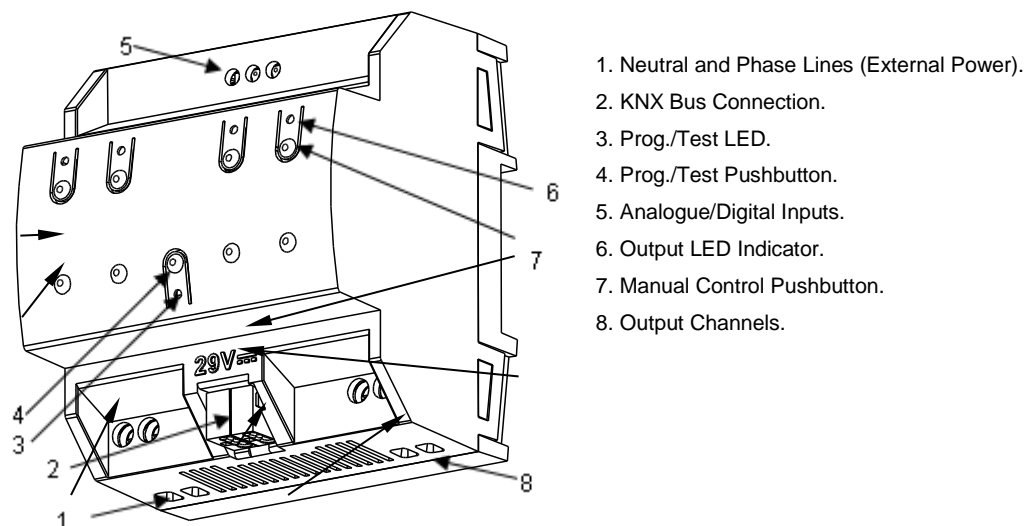

Figure 3 DIMinBOX DX2 - Element Diagram.

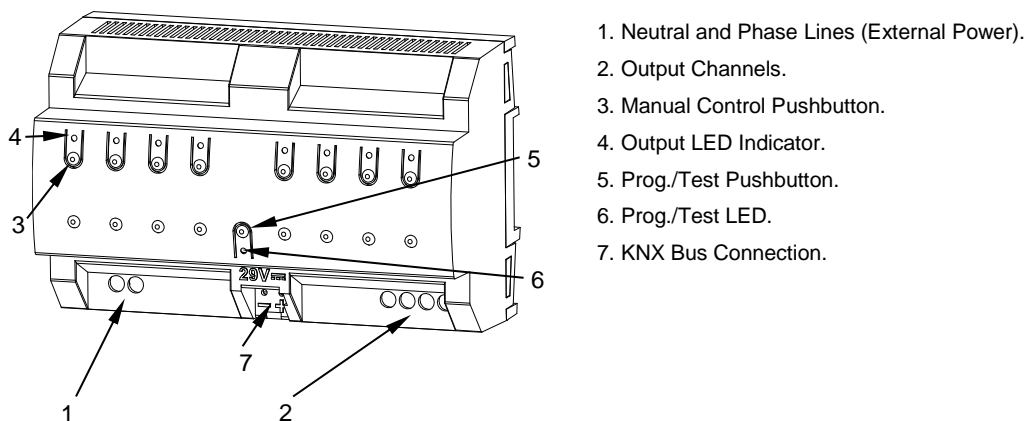

Figure 4 DIMinBOX DX4 - Element Diagram.

The main elements of the device are described next:

- **Test/Prog. Pushbutton (4 / 5):** a short press on this button sets the device into the programming mode, making the associated LED (6) light in red.

Note: if this button is held while plugging the device into the KNX bus, the device will enter into **safe mode**. The LED will blink in red every 0.5 seconds.

- **Output Channels** (8 / 2): slots for the connection of the output lines (loads).
- **Neutral and Phase Inputs** (1): slots for the connection of the voltage wires (neutral and phase lines).
- **Analogue-Digital Inputs** (5 / -): input ports for the stripped cables of external elements such as switches, motion detectors, temperature probes, etc.

To get detailed information about the technical features of the device, as well as on the installation and security procedures, please refer to the corresponding **Datasheet**, bundled with the original package of the device and also available at www.zennio.com.

2 CONFIGURATION

2.1 GENERAL

The general configuration of DIMinBOX DX2 / DX4 requires setting some general parameters common to all output channels:

- Whether to control the two channels **independently or jointly**.
- The length of the dimming course for the two **Smooth Dimming** functions, which make it possible to increase or decrease the light level of the loads progressively (in contrast to **At Once**). This length is defined as the time for an entire regulation, from a level of 0% (no light) to a level of 100% (full light).

Note: *there are several ways of regulating the light level. Therefore, it will be necessary to set which cases should do it at once and which ones smoothly.*

- The **manual control** type, in the case that operating the channels through the on-board pushbuttons is necessary for testing or for other purposes.
- Whether to send **error notifications** or not to the bus.
- Enabling or disabling the **Inputs** module (only for DIMinBOX DX2).
- Enabling or disabling the **Logic Functions** module.
- Heartbeat or periodical “still-alive” notification.
- **Advanced power supply control** for electrical grids under certain determined particularities.

ETS PARAMETERISATION

After importing the corresponding database in ETS and adding the device into the topology of the desired project, the configuration process begins by entering the Parameters tab of the device.

Note: once the device is in operation, it is advisable to switch off the loads prior to performing further parameter downloads from ETS.

The tab tree on the left shows the “**General**” tab in the first place, containing the following parameters:

Parameter	Value
Channel Configuration	C1 and C2 (Independent Channels)
Smooth Dimming Times [0% to 100%]	
Smooth Dimming Time 1	5 s
Smooth Dimming Time 2	10 s
Smooth Dimming Time Objects	<input type="checkbox"/>
Manual Control	Test Off Mode + Test On Mode
Lock Manual Control	<input type="checkbox"/>
Error Notification	<input type="checkbox"/>
Inputs	<input type="checkbox"/>
Logic Functions	<input type="checkbox"/>
Heartbeat (Periodic Alive Notification)	<input type="checkbox"/>
Enable Advanced Power Supply Control	<input type="checkbox"/>

Figure 5 General - Configuration.

- **Channel Configuration:** sets which channels will be functional, and whether they should be controlled independently or jointly. There are several options.
 - Independent Channels: all channels will be functional, and will be controllable separately. The parameterisation of this option depends on each device:

- DIMinBOX DX2: “C1 and C2 (independent channels)”, “C1 (independent channel)”, “C2 (independent channel)”, for enabling both channels, only C1 or only C2, respectively.
- DIMinBOX DX4: “Independent Channels: C1, C2, C3, C4”: When selected, four checkboxes will appear to enable each channel separately.

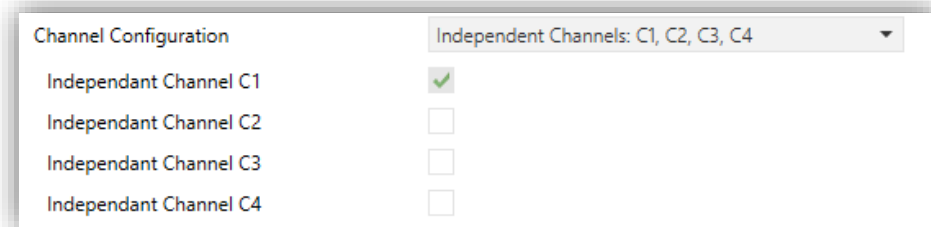

Figure 6 Independent channels configuration in DIMinBOX DX4.

- Common channel: all channels will be functional, although they will be controlled jointly.
 - DIMinBOX DX2: “C1 + C2 (common channel)”.
 - DIMinBOX DX4: “Common Channel: C1+C2+C3+C4”.
- “Channels by Blocks” (only in DIMinBOX DX4): this option allows set channels in blocks of two. The options are:
 - “Disabled”: both channels are disabled.
 - “Independent channels: Cx, Cy”: two checkboxes will appear to enable/disable each channel of the block individually.
 - “Common channel: Cx, Cy”: both channels operate as a single channel.

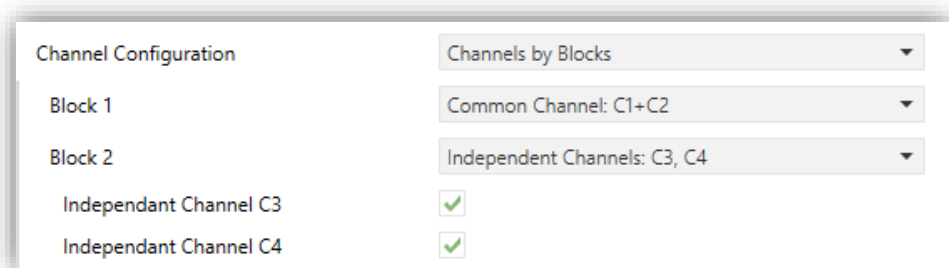
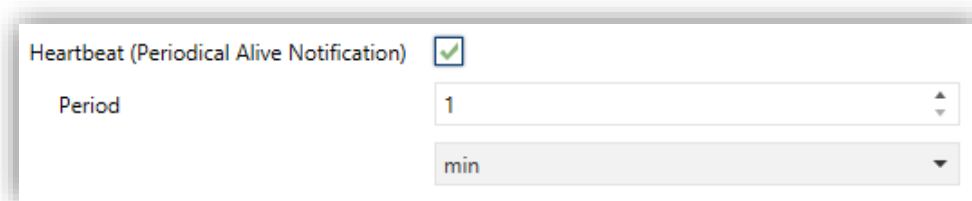

Figure 7 Channels by Blocks configuration in DIMinBOX DX4.

Depending on the option selected and the channels enabled, different tabs are added to the left menu.

- **Smooth Dimming Times:** 5 to 50 tenths of a second, 1 to 120 seconds or 1 to 5 minutes. The longer the time, the smoother the light regulation.
- **Smooth Dimming Time Objects:** enables or disables the “**Smooth Dimming Time 1**” and “**Smooth Dimming Time 2**” two-byte objects, which allow re-defining in runtime the dimming times initially defined in parameters.
- **Manual Control:** the options are “Disabled”, “Test Mode Off + Test Mode On”, “Only with Test Mode Off” and “Only with Test Mode On”. Please see section 2.6 for details.
- **Error Notifications:** enables or disables the “Error Notifications” tab (within “General”), which contains specific parameters for the case DIMinBOX DX2 / DX4 is required to report error events to the KNX bus. Please see section 2.3 for details.
- **Inputs** (only in DIMinBOX DX2): enables or disables the “Inputs” tab, which contains specific parameters for the case of connecting external accessories to DIMinBOX DX2. Please see section 2.4 for details.
- **Logic Functions:** enables or disables the “Logic Functions” tab, which contains specific parameters for the case the Logic Functions module is required. Please see section 2.5 for details.
- **Heartbeat (Periodical Alive Notification):** this parameter lets the integrator incorporate a one-bit object to the project (“**[Heartbeat] Object to Send ‘1’**”) that will be sent periodically with a value of “1” to notify that the device is still working (still alive).



Heartbeat (Periodical Alive Notification)

Period

Figure 8. Heartbeat (Periodical Alive Notification)

Note: *The first sending after download or bus failure takes place with a delay of up to 255 seconds, to prevent bus overload. The following sendings match the period set.*

- **Enable Advanced Power Supply Control:** enables or disables a software filter that palliates the effect produced by disturbances in electrical grids (for example, superimposed higher frequency signals to indicate tariff changes) when the charge is at 100%. This parameter is disabled by default in order to avoid undesirable effects on electrical grids not subject to these particularities.

2.2 CHANNEL C_x / CHANNEL C_x + C_y / CHANNEL C₁ + C₂ + C₃ + C₄

Regardless of the channel configuration chosen (independent channels, common channel or block channels; see section 2.1), the configuration options for each channel or set of channels are the same and are detailed in the following sections.

2.2.1 DIMMING

Regarding the light dimming function, the following options are available for each channel:

- The **load type**, which should be RCL (conventional loads), CFL or LED. Different dimming patterns are applied for each case. Please see section 1.2 for details.

- In the case of a **conventional** load (RCL), the integrator will have the option to **manually** set the type (R, C or L) or to let DIMinBOX DX2 / DX4 perform an **automatic** detection.

Note: *if the integrator opts for manually setting a conventional load type (R, C or L) and then installs the wrong type, DIMinBOX DX2 / DX4 will notify the KNX installation about it. See section 2.3.*

- In the case of a **CFL** or a **LED** load, the integrator will have the option to select the dimming pattern (among three options) that best fits the load being regulated. Next, it is necessary to select the dimming mode, that is, whether to regulate the load on the trailing edges of the wave or on the leading edges. Some testing with these options is advisable in order to obtain the best results for the specific lamp being regulated.

Note: *if the device detects issues while trying to regulate the load, it will consider that the selected dimming mode is wrong for the current load, and notify the KNX bus about it. See section 2.3*

- The **type of response** (immediate or smooth, with two smooth speeds available for configuration at the integrator's disposal) of the different light controls: precise dimming (i.e., orders to set a specific light level, expressed in terms of percentage), relative dimming (i.e., orders to increase or decrease the current light level by a certain percentage) and switch-on / switch-off.

- The **load switch-on method**, being possible to configure whether the loads should always recover their previous light level (the one they had before being switched off; this is referred to as “memory function”) when a new switch-on order arrives, or acquire their maximum level. In case of selecting ‘Previous’, the integrator may decide if a new switch-on overwrites the saved value and go to maximum or it is ignored, requiring a relative or precise order or a secondary on/off to achieve 100%
- Whether to activate the **economical mode** (only for RCL loads), which consists in proportionally reducing the actual light level (and thus the energy consumption) by applying a certain coefficient (20% to 100%), without altering the light levels sent and received through the KNX bus (0% to 100%). The above coefficient does take into account for calculating the actual dimming times, so even if the light level has been reduced by a certain percentage, the time it takes to go from the minimum to the maximum will not be shortened – it will still be the parameterised time.
- The **lowest light level** permitted (0% to 50%), as certain loads may show flickering or behave improperly in particularly low levels. When DIMinBOX DX2 / DX4 receives a request to dim the load to a value greater than 0% but lower than the parameterised limit, it will apply the level parameterised as minimum.

ETS PARAMETERISATION

GENERAL	Load Type	RCL
- Channel C1	Load Selection Mode	<input checked="" type="radio"/> Automatic <input type="radio"/> Manual Selection
DIMMING	Adjust Characteristic Curve	<input type="checkbox"/>
CONFIGURATION	Dimming Speed	
+ Channel C2	Absolute Dimming	Smooth 1
	Relative Dimming	Smooth 1
	On/Off	At Once
	Memory Function: On Light Level	<input checked="" type="radio"/> Maximum <input type="radio"/> Previous
	Enable Economical Mode	<input type="checkbox"/>
	Enable Minimum	<input type="checkbox"/>

Figure 9 Channel Cx.

The **Dimming** screen of each channel contains the following parameters:

- **Load Type:** sets the type of the load that will be connected to the output channel. The options are “RCL” (conventional lamps), “CFL” or “LED”.

The following two parameters show up in case of selecting “RCL”:

- **Load Selection Mode:** “Manual” or “Automatic”. And, in case of selecting “Manual”:
 - **Type:** “Resistive (R)”, “Capacitive (C/C+R)” or “Inductive (L/L+R)”.

On the other hand, the following two parameters show up in case of selecting “CFL” or “LED”:

- **Dimming Pattern:** “Lineal”, “Curve 1” or “Curve 2”. Figure 10 shows the different regulation curves for each load type.

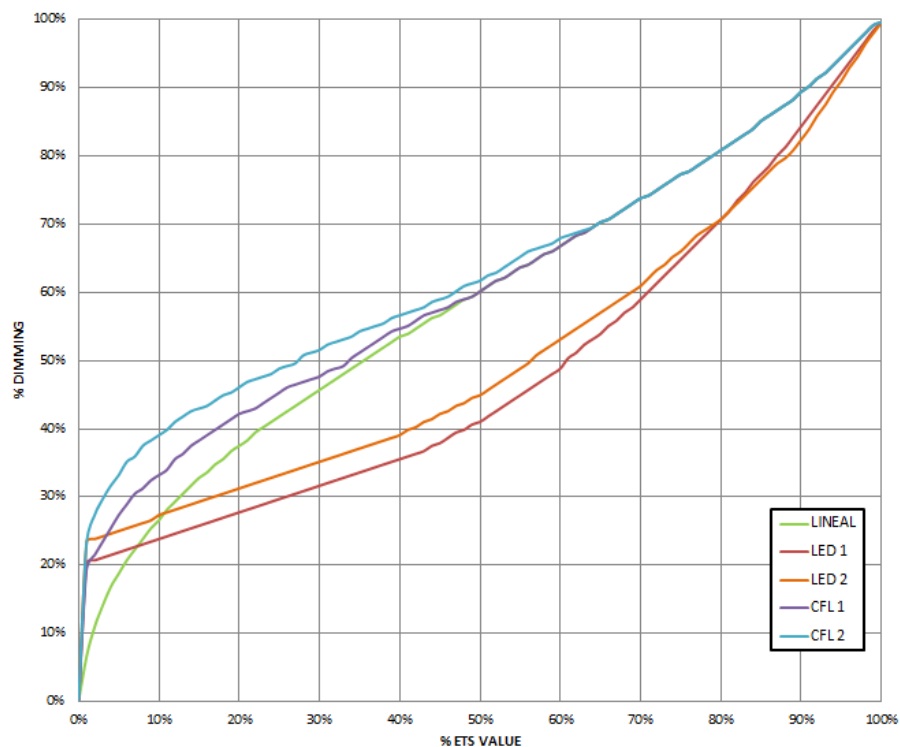

Figure 10 Dimming Patterns for LED and CFL loads.

- **Dimming Mode:** “Trailing Edge” or “Leading Edge”.

Important: please configure these options with caution in order to obtain the best results. Refer to section 1.2 for details.

With independence of the load type, the following parameters will be shown:

- **Adjust Characteristic Curve:** see section 2.2.2.
- **Dimming Speed:** sets the type of response (immediate or progressive; see section 2.1) for the different control orders.
 - **Absolute Dimming:** “At Once”, “Smooth 1” or “Smooth 2”.
 - **Relative Dimming:** “At Once”, “Smooth 1” or “Smooth 2”.
 - **On/Off:** “At Once”, “Smooth 1” or “Smooth 2”.
- **Memory Function:** sets the desired response for the switch-on orders: “Maximum” (maximum light level) or “Previous” (previous light level; that is, a “memory” switch-on).
- **Economical Mode:** enables (“Yes”) or disables (“No”) an internal reduction to the light level (and therefore the energy consumption) by a certain coefficient.
 - **Maximum Dimming Value:** 20% to 100%. The lower the maximum dimming value, the greater the consumption reduction.
- **Enable Minimum:** “Yes” or “No”. In case of selecting “Yes”:
 - **Maximum Dimming Value:** 0% to 50%.

On the other hand, the following communication objects will be available:

- “**[Cx] On/Off**” : one-bit object for the reception of switch orders from the bus. One “1” will switch the light on, while one “0” will switch it off. The dimming speed will be “At Once”, “Smooth 1” or “Smooth 2” according to the parameters, as explained above.
- “**[Cx] Absolute Dimming**” : 1-byte object for the reception of the desired light level (in terms of percentage) from the bus. Once again, the dimming speed will be “At Once”, “Smooth 1” or “Smooth 2” depending on the parameterisation, as explained above.
- “**[Cx] Relative Dimming**” : four-bit object for the reception of dimming orders from the bus. The value of the object will be interpreted as the desired step (brighter or darker), according to the KNX standard. The values “0” and “8” interrupt the current regulation.

Value	Response
0x0 (0)	Stop light dimming
0x1 (1)	Decrease the light level by 100%
0x2 (2)	Decrease the light level by 50%
0x3 (3)	Decrease the light level by 25%
0x4 (4)	Decrease the light level by 12%
0x5 (5)	Decrease the light level by 6%
0x6 (6)	Decrease the light level by 3%
0x7 (7)	Decrease the light level by 1%
0x8 (8)	Stop light dimming
0x9 (9)	Increase the light level by 100%
0xA (10)	Increase the light level by 50%
0xB (11)	Increase the light level by 25%
0xC (12)	Increase the light level by 12%
0xD (13)	Increase the light level by 6%
0xE (14)	Increase the light level by 3%
0xF (15)	Increase the light level by 1%

Table 1 Responses to the 4-bit Dimming Orders.

The dimming speed will be “At Once”, “Smooth 1” or “Smooth 2” depending on the parameterisation, as explained above.

- **“Smooth Dimming Time 1”** (provided that **Smooth Dimming Time Objects** has been enabled; see section 2.1): 1-byte object that allows the value of the “Smooth 1” control time to be changed in seconds via the bus. This modification will affect all actions where this time has been set. The time range of the objects to modify the regulation times (0 - 65535s) is greater than the maximum duration of these times (0.5 - 300s). So if a value longer than the maximum duration (300 seconds) is entered, this entry will be ignored. If a 0 is entered, the “At Once” speed (0.5s) will be adopted.
- **“Smooth Dimming Time 2”**: analogous to the above object, but for “Smooth 2”.

2.2.2 CHARACTERISTIC CURVE

Although DIMinBOX DX2 / DX4 provides several pre-set dimming patterns that should fit most luminaires, it is possible to define a custom dimming curve for each channel in order to get a specific response. This curve must be defined in terms of pairs of the form

{**control value, dimming value**}, which set the responses required in the luminaire for particular control values.

The response for the intermediate control values is obtained by interpolation.

ETS PARAMETERISATION



Figure 11 Characteristic Curve.

The **Characteristic Curve** screen, once enabled from the Dimming tab (see section 2.2.1), provides the following parameters:

- **Number of Value Pairs:** sets how many pairs of values will define the curve: “2”, “3” or “4”.
- **Minimum Control:** sets the control value (as a percentage) of the first pair. This value is necessarily 1%.
- **Minimum Dimming:** sets the dimming value (as a percentage) of the first pair, i.e., the dimming level to be applied to the luminaire when the device receives a control value that matches the control value of the first pair.
- **Control 1** (only for three-point and four-point curves): sets the control value of the second pair.
- **Dimming 1** (only for three-point and four-point curves): sets the dimming value of the second pair.
- **Control 2** (only for four-point curves): sets the control value of the third pair.
- **Dimming 2** (only for four-point curves): sets the dimming value of the third pair.

- **Maximum Control:** sets the control value of the last pair. This value is necessarily 100%.
- **Minimum Dimming:** sets the dimming value of the last pair.

2.2.3 CONFIGURATION

In addition to the options already described regarding the light dimming function, DIMinBOX DX2 / DX4 offers some more additional features, which are disabled in parameters by default.

The next sections describe each of them: **status objects**, **custom On/Off** controls, **simple timer**, **flashing**, **scenes and sequences**, **alarm**, **channel lock by object**, **automatic switch-off** and **initialisation settings**.

ETS PARAMETERISATION

The **Configuration** screen allows enabling the following functions for each channel:

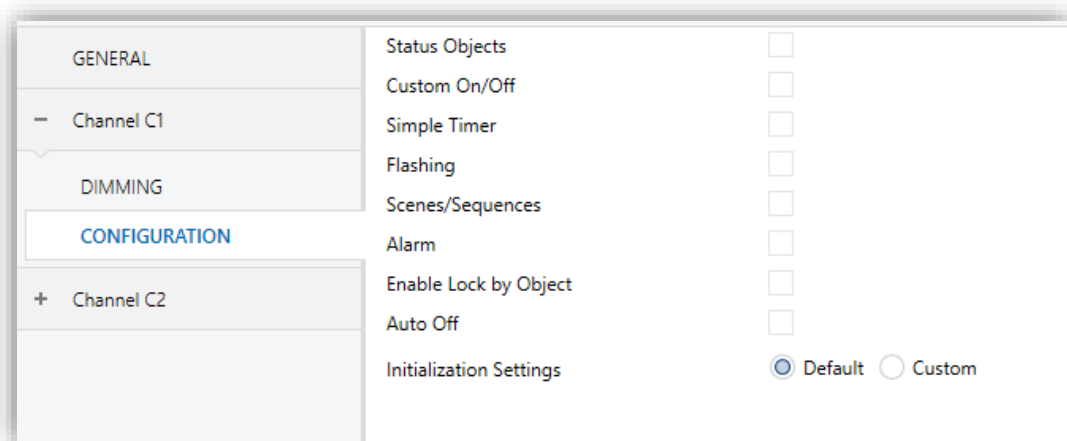

Figure 12 Configuration.

Marking any of the checkboxes will bring **a new entry to the tab tree** for the parameterisation of that particular function (with the exception of **“Enable Lock By Object”**, which has no parameters involved).

One drop-down box is also provided to select the desired **initialisation** of the device (**“Default”** or **“Custom”**).

The next subsections describe each of the above functions.

2.2.4 STATUS OBJECTS

This function implements, for a particular channel, a one-bit On/Off status object and a one-byte (percentage) status object that will report the channel state at any time, thus informing other devices in the KNX installation.

ETS PARAMETERISATION

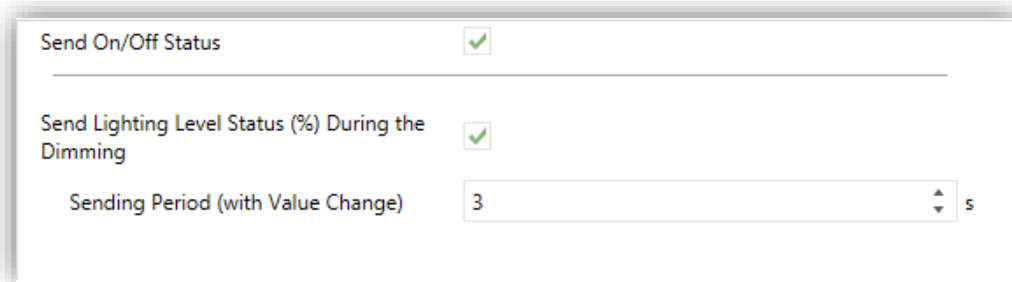

Figure 13 Status Objects.

This **Status Objects** screen contains the following parameters:

- **Send On/Off Status:** enables the "[Cx] On/Off (Status)" one-bit object, which reports the On/Off state of the output channel when it changes. It is always automatically sent back to the bus after the reception of an On/Off order through the analogous control object.
- **Send Lighting Level Status (%):** enables the "[Cx] Lighting Level (Status)" one-byte communication object, which reports –whenever it changes– the status of the light level applied to the output channel in terms of percentage, with an accuracy of $\pm 1\%$. If enabled, the following parameter also shows up:
 - **Sending Period (with Value Change):** sets every how much time the status object should be sent to the bus during a progressive (smooth) dimming, provided that the value differs from the last sent. The available range is 1 to 120 seconds. The default value is 3 seconds.

In case a dimming order is received during either the lock state (see section 2.2.9), an alarm (see section 2.2.10) or an error situation (see section 2.3), these objects will be sent to the bus –provided that they have been enabled– with the same value they already had, to make it evident that the requested order has not been executed.

2.2.5 CUSTOM ON/OFF

This function brings the chance to enable up to two additional On/Off controls for the output channel, and therefore up to two new communication objects to switch the load on or off.

These additional controls allow customising the light level of the output for the “On” and “Off” states and the switch type (at once or smooth).

The custom On/Off function is particularly useful when the dimmer is required to set a specific light level for each room (children bedrooms, hospital rooms, etc.), other than the maximum light level of the normal On/Off control. In such cases, both functions (normal and custom On/Off) can coexist and be used depending on the situation.

ETS PARAMETERISATION

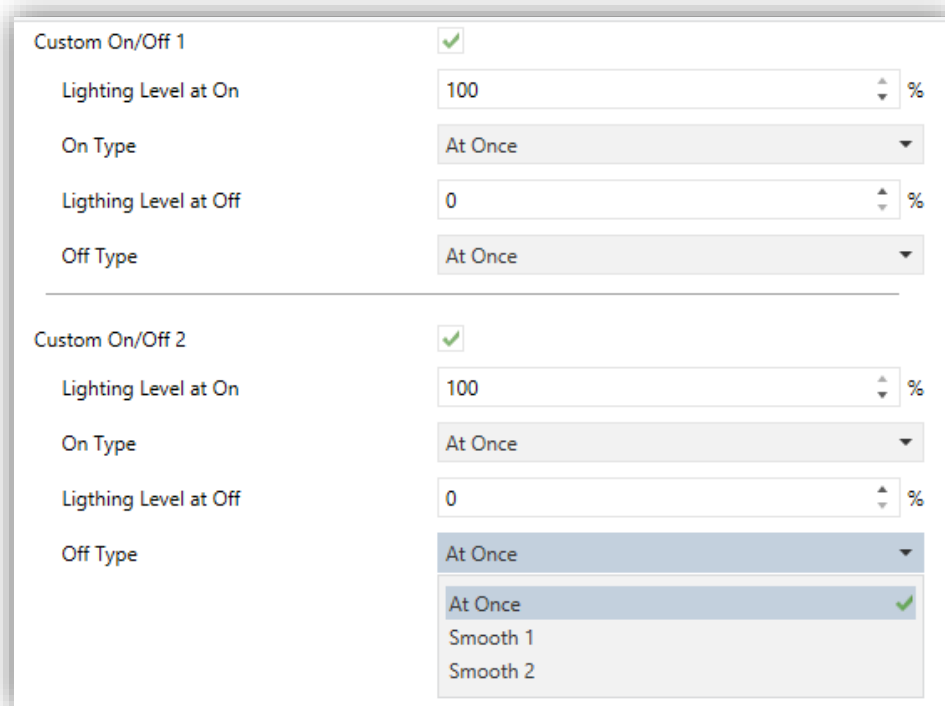

Figure 14 Custom On/Off.

Once enabled, the **Custom On/Off** screen offers up to two additional On/Off controls for the channel.

Both can be independently configured through the following parameters:

- **Lighting Level at On:** sets the desired light percentage (10% - 100%) to be applied to the channel when the value "1" is received through the "[Cx] Custom On/Off Y" 1-bit communication object (being "Y" equal to 1 or 2).
- **On Type:** sets the desired dimming type for the custom switch-on of the channel: [At once](#), [Smooth 1](#) or [Smooth 2](#).
- **Lighting Level at Off:** sets the desired light percentage (0% - 50%) to be applied to the corresponding channel when the value "0" is received through the "[Cx] Custom On/Off Y" 1-bit communication object.
- **Off Type:** sets the desired dimming type for the custom switch-off of the channel: [At once](#), [Smooth 1](#) or [Smooth 2](#).

2.2.6 SIMPLE TIMER

This function allows performing a switch-on of the load connected to the channel of DIMinBOX DX2 / DX4 and a later, automatic (timed) switch-off, being also possible to add delays and to parameterise the time length, the luminosity level and the dimming type. It is also possible to configure the desired effect in case the switch-on trigger is received several times (retriggering).

The timed switch-off can also be triggered in advance through the corresponding object, before the time count ends.

This function is useful in **a motion-dependent light control**, or when the load needs to be switched on and then switched off automatically after a certain time.

ETS PARAMETERISATION

Once enabled, the following parameters can be configured from the **Simple Timer** tab:

Lighting Level at On	100	%
On Delay (0 = No Delay)	0	s
Off Delay (0 = No Delay)	0	s
On Duration (0 = Endless)	0	s
On/Off Type	At Once	
Action in Case of Retriggering	Nothing (checked) Nothing Restart Multiply	

Figure 15 Simple Timer.

- **Lighting Level at On:** sets the desired light percentage (10% - 100%) to be applied when the timed switch-on is triggered (**[Cx] Simple Timer = 1**).
- **On Delay:** sets the time DIMinBOX DX2 / DX4 will wait since the reception of the timed switch-on order and the actual switch-on of the load. The allowed values are: 0 to 3600 s, 0 to 1000 min, 0 to 100h. If no delay is needed, this field should remain at zero.
- **Off Delay:** analogous to the previous parameter, but for the timed switch-off orders (**[Cx] Simple Timer = 0**).
- **On Duration:** sets the time of the “On” stage before the load automatically switches off. Allowed values are: 0 – 3600 s, 0 – 1000 min, 0 – 100h. A value of “0” in this field means that the load should remain on until a contrary order is received.

Note: *the time space defined here refers to the entire “On” stage, including (if applicable) the smooth dimming time. In case the dimming is too slow and the “On Duration” time too short, only a partial light transition will take place.*

- **On/Off Type:** sets the dimming type to be applied during the timed switch-on and switch-off of the channel: [At once](#), [Smooth 1](#) or [Smooth 2](#).
- **Action in case of Retriggerring:**
 - [Nothing](#): successive arrivals of the Timer On order will not reset the timer.
 - [Restart](#): if the output has already been switched on and the On Duration time is counting, the count will be restarted whenever another "1" is received through the "[Cx] Simple Timer" communication object.
 - [Multiply](#): if the output has already been switched on and the On Duration time is counting, then the actual duration will be "n" times the parameterised time, being "n" the number of times the value "1" is received through the "[Cx] Simple Timer" communication object.

The above parameter does not apply to the On and Off Delays:

- If the On (or Off) delay count is running, the timer will NOT be reset even if a new "1" (or "0") is received through "[Cx] Simple Timer".

During the simple timing, receiving any other order to regulate the load will interrupt the time count and make DIMinBOX DX2 / DX4 execute the new request.

2.2.7 FLASHING

This function allows running **On-Off** sequences with customisable lengths (and light levels) for the "On" and the "Off" stages. It is also possible to set the number of repetitions (up to 255, or otherwise endless), as well as the light level of the output after the last repetition (or when an order to interrupt the flashing is received).

The flashing sequence starts when DIMinBOX DX2 / DX4 receives a "1" through the flashing object and stops once it has executed all the configured repetitions (unless an endless sequence has been parameterised). It is possible to interrupt the flashing sequence at any time by sending one "0" to the flashing object. Sending any other control order (e.g., On/Off, scenes, etc.) will also interrupt it. Also, it is possible to send the device the order to re-start the flashing sequence during the execution.

ETS PARAMETERISATION

Once the function has been enabled, the following parameters can be configured from the **Flashing** screen:

Lighting Level at On	100	%
On Duration	2	s
Off Duration	2	s
Number of Repetitions (0 = Endless)	0	
Final Lighting Level	0	%

Figure 16 Flashing.

- **Lighting Level at On:** sets the desired light percentage (10% - 100%) to be applied to the load during the “On” stages.
 - **On Duration:** sets the length of the “On” stages. The available values are 1 to 3600 seconds, 1 to 1000 minutes, 1 to 24 hours (2 seconds by default).
 - **Off Duration:** analogous to the above parameter, but for the “Off” stages.
 - **Number of repetitions:** number of times the On/Off cycle will repeat during the sequence (from 0 to 255). For endless flashing, please enter “0”; in such case the sequence will repeat until an order to interrupt it (or any other dimming order: On/Off, scenes, etc.) is received.
- Note:** the sequence is triggered by writing the value “1” to object “[Cx] Flashing”, and interrupted by writing the value “0” to the same object.
- **Final Lighting Level:** sets the desired light percentage (0% - 100%) after the last repetition or after the reception of the value “0” through “[Cx] Flashing”.

2.2.8 SCENES/SEQUENCES

This function allows defining up to ten scenes/sequences per channel, which consist in a specific light ambient or dimming sequence than can be triggered by sending the corresponding scene number to the device.

ETS PARAMETERISATION

Each of the ten scenes/sequences can be individually configured from the **Scenes/Sequences** screen.

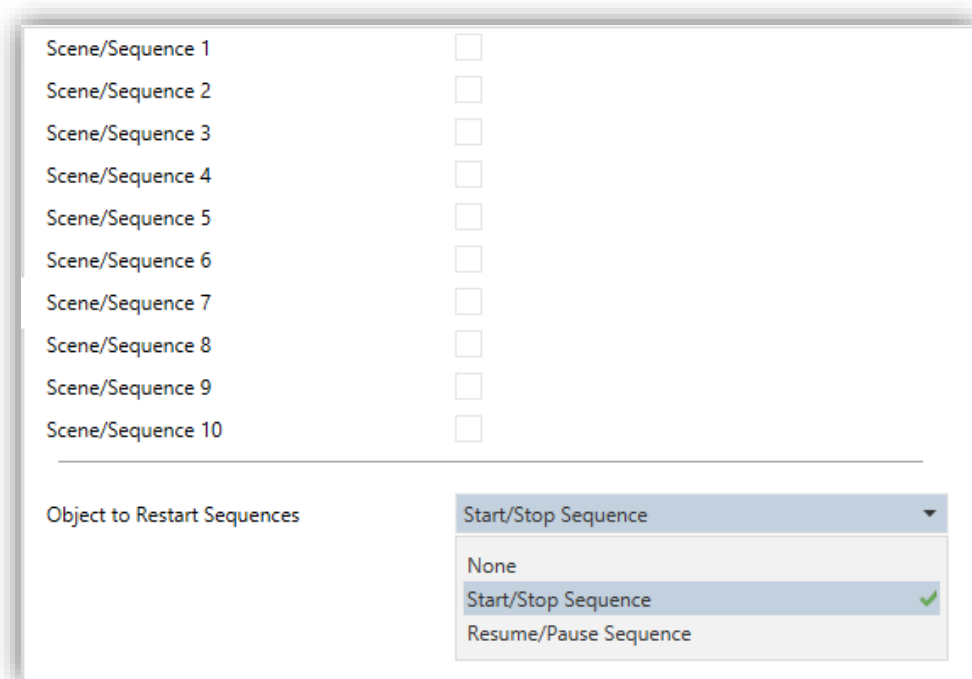

Figure 17 Scenes/Sequences.

One checkbox is shown for each of them. Marking any of these checkboxes brings a new entry to the tab tree, from which it is necessary to configure the following fields:

- **Scene/Sequence number**: sets the scene/sequence identifying number (from 1 to 64). The reception of this number (subtracting 1, according to the KNX standard) through the “[Cx] Scenes/Sequences” object will make the controller perform the corresponding actions.
- **Scene/Sequence type**: selects the desired type of response:

- **Scene:** The scene will consist in setting a certain light level (specified in “**Lighting Level**”) when the “[Cx] **Scenes/Sequences**” object is received with the proper scene number.

Scene/Sequence Number	1
Scene/Sequence Type	<input checked="" type="radio"/> Scene: Lighting Level <input type="radio"/> Custom Sequence
Lighting Level	0 %
Dimming Type	At Once

Figure 18 Scene.

- **Dimming type:** allows setting whether to apply the new level “[At Once](#)”, or progressively (“[Smooth 1](#)” or “[Smooth 2](#)”).
 - **Lighting Level:** brightness level to be applied in the scene between 0% - 100%.
- **Custom sequence.** The response will consist in a customisable sequence of up to five steps/actions, defined through the following parameters:
- **Cyclic:** “[Yes](#)” will define a cyclic sequence (after the last step, the sequence will start over), while “[No](#)” will define a non-cyclic sequence.
 - **Next Scene/Sequence:** this parameter offers the possibility of triggering –after the last step of the sequence– another sequence.
 - **Lighting Level Status Sending:** if set to “[Send continuously](#)”, the light level will be sent to the KNX bus through “[Cx] **Lighting Level (Status)**” during smooth dimming. If set to “[Send when sequence ends](#)”, the level will be sent to the bus once the last step of the sequence finishes, even if the sending of the status is enabled or not. In both cases, however, the Status Objects function should have been enabled (see section 2.2.3).

Scene/Sequence Number	1
Scene/Sequence Type	<input type="radio"/> Scene: Lighting Level <input checked="" type="radio"/> Custom Sequence
Cyclic	<input checked="" type="radio"/> No <input type="radio"/> Yes
Next Scene/Sequence	None
Lighting Level Status Sending	<input checked="" type="radio"/> Send Continuously <input type="radio"/> Send When Sequence Ends
Action 1	<input checked="" type="checkbox"/>
Lighting Level	0 %
Duration	2
	s
Dimming Type	At Once
Action 2	<input type="checkbox"/>
Action 3	<input type="checkbox"/>
Action 4	<input type="checkbox"/>
Action 5	<input type="checkbox"/>

Figure 19 Sequence.

For every step (action), the following parameters are required:

- **Lighting Level:** sets the desired luminosity for the step (0% to 100%).
- **Duration:** sets the time length of the step (i.e., the action time). The available values are 1 – 3600 seconds, 1 – 1000 minutes, and 1 – 24 hours (2 seconds by default).

Note: *the time space defined here refers to the entire step action, including (if applicable) the smooth dimming time. In case the dimming is too slow and the step action time too short, only a partial light transition will take place.*

- **Dimming type:** sets the dimming type for the transition between the steps: “At once”, “Smooth 1” or “Smooth 2”.

On the general tab scenes, the configuration of an object to re-start the sequences is possible:

- **None:** Sequence control object disabled.
- **Star/Stop Sequence:** An object named “[Cx] Start/Stop Sequence” is provided in case a sequence needs to be interrupted (value “0”) or re-started (value “1”). If the value “1” is received while no sequence was being run, the last sequence will be triggered again (or the first one parameterised, if no sequences have been executed before).
- **Resume/Pause Sequence:** An object named “[Cx] Resume/Pause Sequence” is provided in case a sequence needs to be interrupted (value “0”) or re-started (value “1”) the sequence from action in which it was paused. If the value “1” is received while no sequence was being run, the last sequence will be triggered again (or the first one parameterised, if no sequences have been executed before).

Note that these objects only apply to sequences, not to static scenes.

Besides running a scene it is also possible to save it: if the device receives an order to save the scene (values 128-191 through “[Cx] Scenes/Sequences”), the current luminosity level of the load (and the dimming speed) will be saved, but only if the value corresponds to any of the parameterised scenes (if not, the order will be ignored).

2.2.9 LOCK CHANNEL

This function permits locking the channel by sending a "1" through a specific one-bit communication object. From that moment, any action being executed by the channel will stop and the load will maintain the brightness value it currently has.

Dimming orders during the lock state will be ignored, while objects common to both channels not implying changes in their light levels will still respond.

DIMinBOX DX2 / DX4 will unlock the channel when the value "0" arrives through the lock object. The channel will still maintain the same luminosity level: any request received during the lock state will not be run by the channel after the unlock event.

After a power failure, the channel will maintain the lock state and the light level (the **initialization settings** will not apply in this case; see section 2.2.12).

Note that the **Auto Off** (section 2.2.11) function will not be available during the lock.

ETS PARAMETERISATION

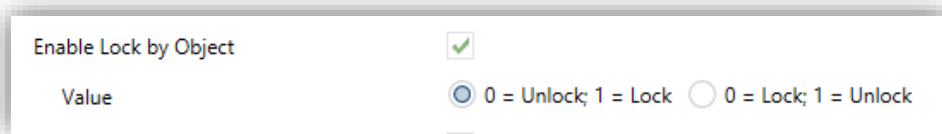

Figure 20. Bloqueo

Enabling this function in the Configuration screen of the channel adds an object (“**[Cx] Lock**”) to the project topology.

According to the polarity of the selected value:

- **0 = Unlock; 1 = Lock**, when this object receives the value “1” the channel will become locked, while the value “0” will resume the normal behaviour.
- **0 = Lock; 1 = Unlock**, when this object receives the value “0” the channel will become locked, while the value “1” will resume the normal behaviour.

2.2.10 ALARMS

This function brings the possibility of configuring an **alarm action** over the output channel, which will be executed on the arrival of a specific trigger object from the bus. Moreover, the activation of the alarm will interrupt any timed action that may be in progress (simple timers, flashing and sequences).

The available alarm actions are: **stopping** the current regulation, **switching the load on** (at a specific, customisable value) and **switching the load off**.

It is possible to **cyclically monitor the alarm object**, and to configure the desired period time. If enabled, the alarm will not only be triggered through the arrival of the designated alarm value through the alarm object, but also in case the no-alarm value is not received at least once within the configured cycle time.

Regarding the **alarm deactivation**, the following actions are available: leaving the load **as is** (no change), **switching the load off**, **switching the load on** (at a specific, customisable value) and switching the load back to the **previous state**. This previous state corresponds to the final lighting level, i.e., the last one before the alarm activation (or the last target level, in case the alarm was triggered in the course of a regulation).

On the other hand, the deactivation can be either normal or frozen (i.e., through an acknowledgement):

- **Normal**: the device leaves the alarm state as soon as the no-alarm value is received.
- **Frozen**: after the arrival of the no-alarm value, an additional acknowledgement object must be received before the device leaves the alarm state.

Any light regulation orders received during the alarm state will be ignored.

After a device power failure, the channel will preserve the alarm state and the light level; any **initial settings** (see section 2.2.12) will not apply in this case.

Note that the **Auto Off** (section 2.2.11) function will not be available during the alarm.

ETS PARAMETERISATION

The screenshot shows a configuration window for alarm settings. It is divided into two main sections: 'Trigger' and 'DEACTIVATION'.
In the 'Trigger' section:
- 'Trigger' is set to '1' (radio button selected).
- 'Cyclical Monitoring Period (0 = Disabled)' is set to '0' in a numeric input field, with a unit dropdown menu set to 's'.
- 'Action' is set to 'On' in a dropdown menu.
- 'Lighting Level' is set to '100' in a numeric input field, with a '%' symbol to its right.
In the 'DEACTIVATION' section:
- 'Mode' is set to 'Frozen (Acknowledgement Needed)' (radio button selected).
- 'Action' is set to 'No Change' in a dropdown menu.

Figure 21 Alarm

A specific alarm action can be configured per channel. Once this function has been enabled, the **Alarm** tab shows up:

The parameters involved in the **alarm activation** are:

- **Trigger:** sets which value (0 or 1) will imply the alarm activation when received through the “[Cx] Alarm” object, which will therefore imply the execution of the alarm activation action.
- **Cyclical Monitoring Period:** sets the maximum time without receiving the no-alarm value that will be acceptable prior to automatically triggering the alarm. The available values are 0 to 24 hours, 0 to 14400 minutes, 0 to 3600 seconds, and 0 to 600 tenths of a second. Value “0” disables the alarm cyclical monitor.
- **Action:** sets the desired response to the alarm activation.
 - [Stop](#).
 - On (**Lighting Level** allows setting the desired switch-on level).
 - Off.

On the other hand, the parameters involved in the **alarm deactivation** are:

- **Mode:** sets the alarm deactivation procedure:
 - [Normal](#).
 - Frozen (Acknowledgement Needed).

When opting for the second option, object “[Cx] Unfreeze Alarm” will be included into the project topology for the reception of the acknowledgement messages (value “1”).

- **Action:** sets the desired response to the alarm deactivation.
 - [No change](#),
 - On (**Lighting Level** allows setting the desired switch-on level),
 - Off,
 - Last (Before Alarm).

2.2.11 AUTO OFF

If the Auto Off function is enabled, the load controlled by the channel will automatically turn off after a certain time with a light level lower than a parameterisable limit.

The Auto Off function counts the time elapsed after the output falls below a certain threshold light level. If this count exceeds the parameterised timeout, DIMinBOX DX2 / DX4 will turn the load off. The count will stop if an order to increase back the light level over that limit is received.

ETS PARAMETERISATION

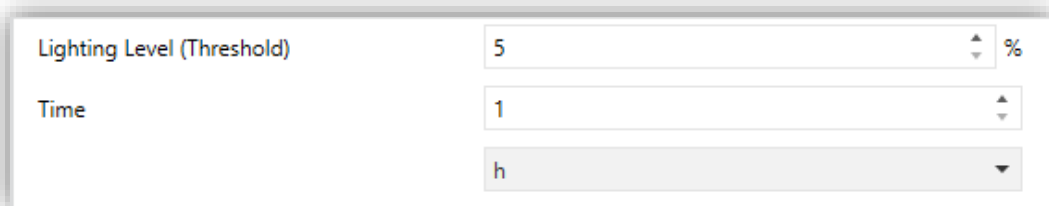

Lighting Level (Threshold)	5	%
Time	1	
		h

Figure 22. Auto Off.

The only parameters contained by the **Auto Off** screen are:

- **Lighting Level (Threshold)**: sets the desired light level (5% to 50%) that will trigger the time count.
- **Time**: sets the time that should elapse before turning the channel off. The available values are 10 to 3600 seconds, 1 to 1000 minutes and 1 to 24 hours.

Notes:

- *If the **Light Level (Threshold)** is lower than the **Lowest Light Level** (see section 2.2.1), the Auto Off will never be effective.*
- *It is recommended to take the regulation times into account when setting the auto off. If the dimming times are high, the luminaire may switch off before reaching the aimed dimming level.*

Example: Having the following configuration:

- Smooth Dimming Time 2: 5 min

- Auto Off:

Level: 5%

Time: 10s

If the luminary is off (0%) and receives a dimming order with regulation time Smooth 2 to 100%, until 15 seconds have elapsed, the channel will not reach 5%; therefore, after 10 seconds, the auto off occurs without reaching the target regulation level.

2.2.12 INITIALISATION

This function is provided to let the integrator specify the desired load state after DIMinBOX DX2 / DX4 recovers from a KNX bus failure or a power supply failure.

In case the integrator feels comfortable with the **default** initialisation settings (load off after an ETS download, and previous light level after a bus or power supply recovery), it will not be necessary to configure this function.

ETS PARAMETERISATION

If **Initialisation Settings** (in the **Configuration** tab; see section 2.2.3) was set to **“Custom”** a specific entry (**Initialisation Settings**) will be added to the tab tree. Otherwise, DIMinBOX DX2 / DX4 will implement the already described default load initialisation.

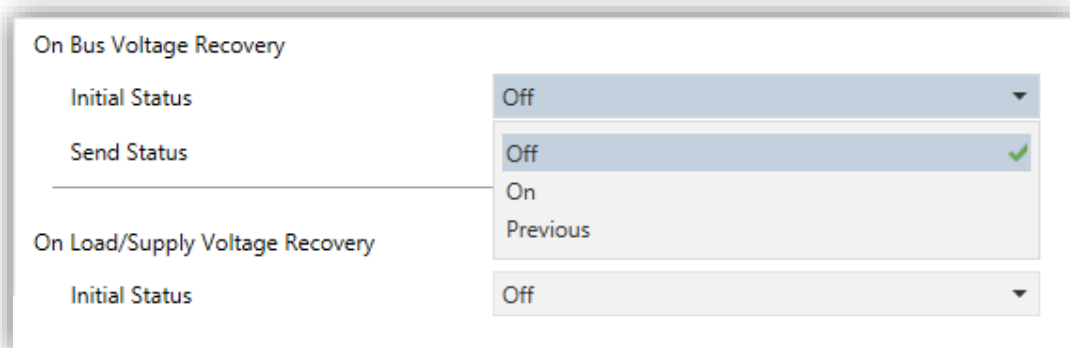

Figure 23 Initialisation Settings.

From this new screen, it is possible to set the **Initial Status** of the load (both after a bus recovery or a power supply recovery) to either "Off", "On" or "Previous".

If the above is set to "On", then an additional parameter will show up (**Lighting Level**) to set the desired light level, in terms of percentage.

2.3 ERROR NOTIFICATIONS

2.3.1 BUS NOTIFICATIONS

Although DIMinBOX DX2 / DX4 permanently watches for error events and reacts to them to prevent damage in the loads and in the device itself, it can also notify the KNX bus about the occurrence of errors, if such option is set in parameters.

The error situations DIMinBOX DX2 / DX4 can report are: **short-circuits**, **overvoltage**, **overheat**, **anomalous network frequency**, **power supply failure** and **wrong load type** selection (in case of having parameterised an RCL load and having manually set a type –resistive, capacitive or inductive– that does not match that of the actual load).

2.3.2 LED INDICATORS

In addition to the above, DIMinBOX DX2 / DX4 always informs about errors by means of the on-board **LED indicators**. In case of concurrence of multiple errors, DIMinBOX DX2 / DX4 will only notify about the one with the highest priority – other errors with a lower priority (on whatever channel) will not be notified by the LEDs until the former is over. Nevertheless, if each channel is under a different error, the two of them will be notified through the LEDs, no matter which one has the highest priority.

ERROR	LEDS DESCRIPTION	DIMinBOX DX2 VISUAL NOTIFICATION	DIMinBOX DX4 VISUAL NOTIFICATION
Short circuit	<p>The two LEDs of the channel with the error blink alternately each 0.25 second.</p> <p>When the output is locked, the programming LED blinks in blue.</p>		
Voltage Surge	<p>The two LEDs of the channel with the error blink simultaneously each 0.25 second.</p> <p>When the output is locked, the programming LED lights in blue</p>		
Overheating	<p>The LEDs of all the channels blink each second.</p>		

<p>Supply Voltage Failure</p>	<p>One LED of each channel blinks each second.</p>		
<p>Anomalous Frequency</p>	<p>All the LEDs of each channel blinks (during 1 second) sequentially</p>		
<p>Parameterization Error</p>	<p>One LED of the channel blinks each second while the other LED blinks each 0.25 second.</p>		

Table 2 Error Notification through the on-board LEDs.

2.3.3 REACTION TO ERRORS

For safety reasons and with independence of the bus notifications, DlMinBOX DX2 / DX4 always takes an action when an error is detected.

Note that when this action implies disconnecting the load, DlMinBOX DX2 / DX4 will no longer perform timed actions nor be aware of short-circuit, overvoltage or wrong load type situations, although other errors will still be monitored.

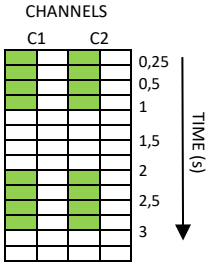
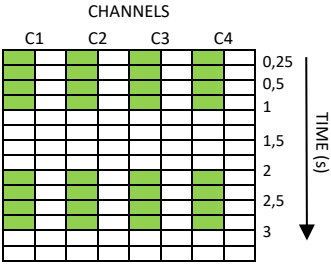
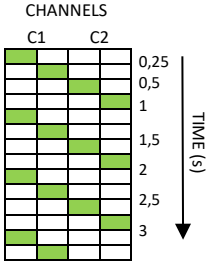
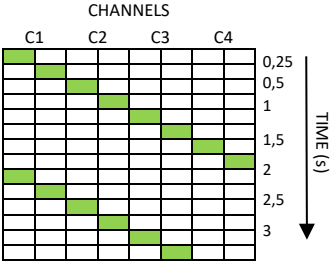
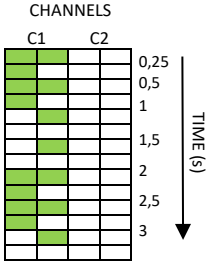
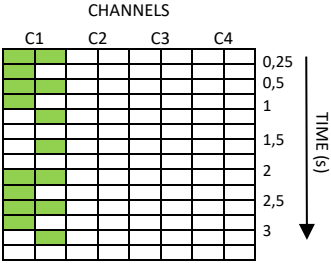
In the case of multiple errors happening at the same time, DlMinBOX DX2 / DX4 will focus on the error with a higher priority (see Table 2), which is supposed to trigger a more restrictive response action.

- **Short Circuit:** when a short circuit takes place, DlMinBOX DX2 / DX4 disconnects the load and waits until a new dimming command is received. When that happens, it will simply try to dim the load and will repeat the process if a new short circuit is detected.

In case of more than **three short circuits in less than two minutes** time (without resetting the device), DlMinBOX DX2 / DX4 will remain **locked** for three minutes and ignore any dimming order addressed to that channel. The lock status will be notified to the KNX bus (if configured in parameters), and also by a blue intermittence of the Prog./Test LED.

- **Overvoltage:** when an overvoltage situation takes place, DlMinBOX DX2 / DX4 disconnects the load and waits until a new dimming command is received. When that happens, it will simply try to dim the load and will repeat the process if a new overvoltage is detected.

In case of more than **three overvoltages in less than two minutes** time (without resetting the device), DlMinBOX DX2 / DX4 will remain **locked** for three minutes and ignore any dimming order addressed to that channel. The lock status will be notified to the KNX bus (if configured in parameters), and also by leaving the Prog./Test LED turned on in blue colour.

- **Overheat:**
 - When the internal temperature of DlMinBOX DX2 / DX4 results to be **between 73°C and 75°C**, the device will lower the light level of the channels

to 20%, ignoring later orders to increase the level. Once the temperature is lower than **65°C** (73°C less an offset of 8°C), the device will resume the normal behaviour, although the light level will remain as is until a new dimming order is received.

- When the internal temperature results to be **over 75°C**, the device will completely disconnect both channels and switch the loads off, ignoring all orders to dim the light. When the temperature falls below 65°C (75°C less an offset of 10°C), the device, the device will resume the normal behaviour, although the light level will remain as is until a new order is received.
- In addition to the above, DIMinBOX DX2 / DX4 is equipped with an **automatically resettable fuse**, which provides extra protection to the circuitry. Under situations of abnormally high temperature that cannot be solved by disconnecting the loads, this fuse will blow out, thus interrupting all communications and turning DIMinBOX DX2 / DX4 completely off.
- **Power Supply Failure:** when DIMinBOX DX2 / DX4 detects a drop of the power supply, it disconnects both channels and waits until it recovers. Whether the channels should remain off (or at a certain level) after the power recovery or recover their previous light levels can be parameterised (see section 2.2.12).
- **Anomalous Frequency:** when DIMinBOX DX2 / DX4 detects an abnormal frequency in the power network, it will react analogously as for the Power Supply Failure. During the anomalous frequency error, the device will still be able to detect overheating and drops of the power supply.
- **Wrong Load Type:** under either a non-conventional load type configuration or a manual configuration of a specific conventional (RCL) load type, in case DIMinBOX DX2 / DX4 tries to regulate the load and detects any issues due to a mismatch in the load type configuration, it will disconnect the output channel and wait for new dimming orders. When they arrive, it will try to dim the load and will repeat the process if the load type is still wrong.

ETS PARAMETERISATION

If error notifications have been enabled from the **General** tab (see section 2.1), an additional entry will be shown in the tab tree on the left.

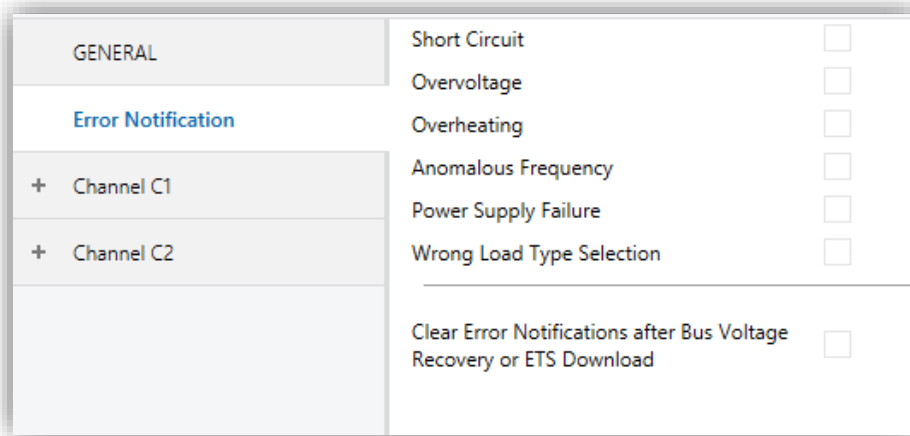

Figure 24 Error Notification.

This screen contains one checkbox per error situation (including “**Wrong Load Type Selection**”, in case of parameterising either a specific conventional load or a non-conventional load type). Marking any of them will add a specific one-bit communication object to the project topology (or two, if the error is channel-dependent but a two-channel control has been configured).

The specific error objects are:

- “**Power Supply Fault**”,
- “[Cx] **Short Circuit**”,
- “**Overheating**”,
- “[Cx] **Overvoltage**”,
- “**Anomalous Frequency**”.
- “[Cx] **Wrong Load Type Parameterization**”.

These objects are sent periodically sent to the bus (every thirty seconds) with a value of “1” as long as the error persists. Once the undesired situation is over, they are sent (once) with the value “0”. Note that, as already explained, if several errors take place at the same time, the error with the highest priority may mask other errors, which therefore will not be reported until the former is solved.

There is also a secondary object related to some of the error situations:

- “[Cx] **Lock Due to Overvoltages**”.

- “[Cx] Lock Due to Short Circuits”.

When DIMinBOX DX2 / DX4 gets automatically locked after detecting one of these errors multiple times, the lock object corresponding to that error will be sent with value “1”. Once the lock state is over, it will be sent with value “0”.

Back to the parameters, one more is shown in addition to the above checkboxes:

- **Clear Error Notifications after Bus Voltage Recovery or ETS Download:** sets whether the previous state of the enabled error objects should be cleared during the start-up of the device (i.e., whether they should be sent with the value “0” to the KNX bus).

This does not mean that DIMinBOX DX2 / DX4 will ignore any errors still taking place after the device start-up (in such case, the corresponding object will be sent with the value “1” after being sent with the value “0”), but may be useful to *force* all error states to zero in the beginning, to update other devices in the KNX installation.

2.4 INPUTS (ONLY IN DIMINBOX DX2)

DIMinBOX DX2 incorporates **two analogue/digital inputs**, each configurable as a:

- **Binary Input**, for the connection of a pushbutton or a switch/sensor.
- **Temperature Probe**, for the connection of a temperature sensor from Zennio.
- **Motion Detector**, for the connection of a motion detector (model ZN1IO-DETEC-P from Zennio).

Important: *older models of the Zennio motion detector (e.g., ZN1IO-DETEC and ZN1IO-DETEC-N) will not work properly with DIMinBOX DX2.*

ETS PARAMETERISATION

When **Inputs** has been activated in the general configuration screen (see section **¡Error! No se encuentra el origen de la referencia.**), the following drop-down lists will be available for the selection of the specific functions required.

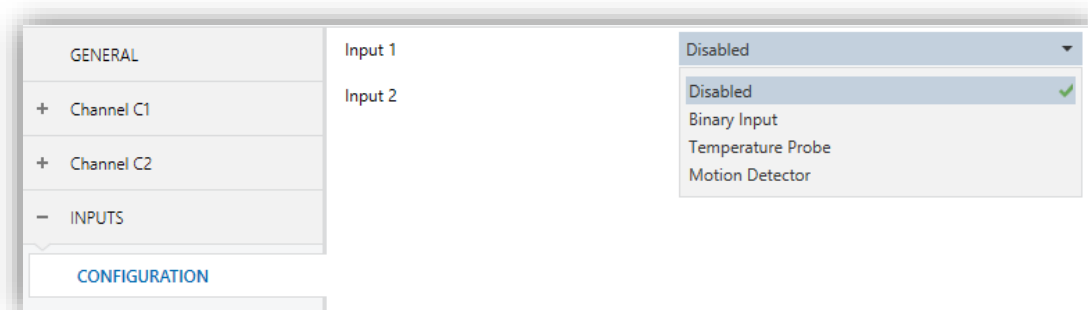

Figure 25. Inputs - Configuration

All inputs are disabled by default. Depending on the function selected for each input, additional tabs will be included in the menu on the left.

2.4.1 BINARY INPUT

Please refer to the “**Binary Inputs**” user manual, available in the DIMinBOX DX2 product section at the Zennio homepage, www.zennio.com.

2.4.2 TEMPERATURE PROBE

Please refer to the “**Temperature Probe**” user manual, available in the DIMinBOX DX2 product section at the Zennio homepage, www.zennio.com.

2.4.3 MOTION DETECTOR

It is possible to connect motion detectors (models **ZN1IO-DETEC-P** and **ZN1IO-DETEC-X** from Zennio) to the input ports of DIMinBOX DX2. This brings the device with the possibility of monitoring motion and presence in the room, as well as the light level. Depending on the detection, different response actions can be parameterised.

Please refer to the specific user manual “**Motion Detector**” (available in the DIMinBOX DX2 product section at the Zennio homepage, www.zennio.com) for detailed information about the functionality and the configuration of the related parameters.

Notes:

- *The ZN1IO-DETEC-P motion detector is compatible with a variety of Zennio devices. However, depending on the device it is actually being connected to, the functionality may differ slightly. Therefore, please refer specifically to the aforementioned user manual.*
- *Motion detectors with references ZN1IO-DETEC and ZN1IO-DETEC-N are **not compatible** with DIMinBOX DX2 (may report inaccurate measurements if connected to this device).*
- *When connected to DIMinBOX DX2, the rear micro-switch of model ZN1IO-DETEC-P should be set to position “**Type B**”.*

2.5 LOGIC FUNCTIONS

This module makes it possible to perform numeric and binary operations to incoming values received from the KNX bus, and to send the results through other communication objects specifically enabled for this purpose.

DIMinBOX DX2 / DX4 can implement **up to 10 different and independent functions**, each of them entirely customisable and consisting in **up to 4 consecutive operations each**.

The execution of each function can depend on a configurable **condition**, which will be evaluated every time the function is **triggered** through specific, parameterisable communication objects. The result after executing the operations of the function can also be evaluated according to certain **conditions** and afterwards sent (or not) to the KNX bus, which can be done every time the function is executed, periodically or only when the result differs from the last one.

Please refer to the specific user manual “**Logic Functions**” (available in the DIMinBOX DX2 / DX4 product section at the Zennio homepage, www.zennio.com) for detailed information about the functionality and the configuration of the related parameter.

2.6 MANUAL CONTROL

The two output channels of DIMinBOX DX2 / DX4 can be manually operated and verified by means of the **on-board pushbuttons and LEDs** (two per channel), located on the top side of the device.

Two alternative approaches are provided for this manual control:

- **Test On Mode**, intended for testing the installation and the loads while setting up the device.
- **Test Off Mode**, intended for any other purposes during normal, long-term operation of the device.

ETS lets configuring **which of the two modes** (if not both) should be accessible. Moreover, a specific **object** can also be enabled in parameters in order to lock/unlock the manual control in runtime (to prevent undesired use, for example).

The **Test Off Mode is active any time** (unless disabled in parameters), which means that the on-board pushbuttons will work according to this mode by default.

On the other hand, **switching to the Test On Mode** (unless disabled in parameters) is done by holding the Prog/Test button for at least three seconds. This will turn the LED yellow. Once the button is released, the LED will become green (which means the Test On Mode is now active). Pressing the button again will turn the LED off, which will mean the Test Off Mode has become the active mode again

In case of having parameterised a two-channel joint control: CX +CY, only the pushbuttons of channel X will have effect (on both channels, in this case). Likewise, in case of having a single common channel: C1+C2+C3+C4, the manual control will be carried out using the pushbuttons of channel 1.

Note: *both manual control modes come enabled from factory.*

2.6.1 TEST ON MODE

Under this mode, the output channels will be controllable only by means of the manual control itself. Any orders received from the KNX bus will be ignored, and the status objects will not be sent to the bus either.

The error notification, lock and timed functions will remain inoperative as well. On the other hand, the **Economical mode** and the **Minimum Light Level** will still apply,

Note that, for safety reasons, the Test On Mode will not be accessible while there are errors in any of the channels (see section 2.3). On the other hand, if an error is detected during the Test On Mode, the device will automatically leave this mode.

Regarding the loads themselves, their reaction to the **short and long presses** will be as follows:

- **Short press:** the load will switch on or off, depending on the button.
- **Long press:** depending on the button, the load will keep progressively increasing or decreasing the light level until the button is released. The speed of this regulation will be the one that has been parameterised in ETS for the relative dimming.

2.6.2 TEST OFF MODE

Operating the manual control under this mode will be entirely analogous as receiving orders from the KNX bus. In fact, the device will still respond to any requests from the bus and will send the status objects when corresponding.

Under the Test Off Mode, the loads react to the **short and long presses** the same way they do in the Test On Mode:

- **Short press:** the load will switch on or off, depending on the button.
- **Long press:** depending on the button, the load will keep progressively increasing or decreasing the light level until the button is released. The speed of this regulation will be the one that has been parameterised in ETS for the relative dimming.

ANNEX I: COMMUNICATION OBJECTS OF DIMINBOX DX2

“Functional range” shows the values that, with independence of any other values permitted by the bus according to the object size, may be of any use or have a particular meaning because of the specifications or restrictions from both the KNX standard or the application program itself.

Number	Size	I/O	Flags	Data type (DPT)	Functional Range	Name	Function
1, 2	1 Bit	I	C--W-	DPT_Switch	0/1	[Cx] On/Off	0 = Off; 1 = On
	1 Bit	I	C--W-	DPT_Switch	0/1	[C1+C2] On/Off	0 = Off; 1 = On
3, 4	4 Bit	I	C--W-	DPT_Control_Dimming	0x0 (Stop) 0x1 (Dec. by 100%) 0x2 (Dec. by 50%) 0x3 (Dec. by 25%) 0x4 (Dec. by 12%) 0x5 (Dec. by 6%) 0x6 (Dec. by 3%) 0x7 (Dec. by 1%) 0x8 (Stop) 0x9 (Inc. by 100%) 0xA (Inc. by 50%) 0xB (Inc. by 25%) 0xC (Inc. by 12%) 0xD (Inc. by 6%) 0xE (Inc. by 3%) 0xF (Inc. by 1%)	[Cx] Relative Dimming	4 bits dimmer ctrl
	4 Bit	I	C--W-	DPT_Control_Dimming	0x0 (Stop) 0x1 (Dec. by 100%) ... 0x7 (Dec. by 1%) 0x8 (Stop) 0x9 (Inc. by 100%) ... 0xF (Inc. by 1%)	[C1+C2] Relative Dimming	4 bits dimmer ctrl
5, 6	1 Byte	I	C--W-	DPT_Scaling	0% - 100%	[Cx] Absolute Dimming	1 byte dimmer ctrl
	1 Byte	I	C--W-	DPT_Scaling	0% - 100%	[C1+C2] Absolute Dimming	1 byte dimmer ctrl
7	2 Bytes	I/O	C-RW-	DPT_TimePeriodSec	0 - 65535	Smooth Dimming Time 1	Time in Seconds
8	2 Bytes	I/O	C-RW-	DPT_TimePeriodSec	0 - 65535	Smooth Dimming Time 2	Time in Seconds

9, 10	1 Bit	O	CTR--	DPT_Alarm	0/1	[Cx] Open Circuit	0 = No error; 1 = Error
	1 Bit	O	CTR--	DPT_Alarm	0/1	[C1+C2] Open Circuit	0 = No error; 1 = Error
11	1 Bit	O	CTR--	DPT_Alarm	0/1	Power Supply Failure	0 = No error; 1 = Error
12, 13	1 Bit	O	CTR--	DPT_Alarm	0/1	[Cx] Short Circuit	0 = No error; 1 = Error
	1 Bit	O	CTR--	DPT_Alarm	0/1	[C1+C2] Short Circuit	0 = No error; 1 = Error
14, 15	1 Bit	O	CTR--	DPT_Boot	0/1	[Cx] Lock Due to Short Circuits	0 = Unlocked; 1 = Locked
	1 Bit	O	CTR--	DPT_Boot	0/1	[C1+C2] Lock Due to Short Circuits	0 = Unlocked; 1 = Locked
16	1 Bit	O	CTR--	DPT_Alarm	0/1	Overheating	0 = No error; 1 = Error
17, 18	1 Bit	O	CTR--	DPT_Alarm	0/1	[Cx] Overvoltage	0 = No error; 1 = Error
	1 Bit	O	CTR--	DPT_Alarm	0/1	[C1+C2] Overvoltage	0 = No error; 1 = Error
19, 20	1 Bit	O	CTR--	DPT_Boot	0/1	[Cx] Lock Due to Overvoltages	0 = Unlocked; 1 = Locked
	1 Bit	O	CTR--	DPT_Boot	0/1	[C1+C2] Lock Due to Overvoltages	0 = Unlocked; 1 = Locked
21	1 Bit	O	CTR--	DPT_Alarm	0/1	Anomalous Frequency	0 = No error; 1 = Error
22, 23	1 Bit	O	CTR--	DPT_Alarm	0/1	[Cx] Load Type Parameterization Error	0 = No error; 1 = Error
	1 Bit	O	CTR--	DPT_Alarm	0/1	[C1+C2] Load Type Parameterization Error	0 = No error; 1 = Error
24, 25	1 Bit	O	CTR--	DPT_Switch	0/1	[Cx] On/Off (Status)	0 = Off; 1 = On
	1 Bit	O	CTR--	DPT_Switch	0/1	[C1+C2] On/Off (Status)	0 = Off; 1 = On
26, 27	1 Byte	O	CTR--	DPT_Scaling	0% - 100%	[Cx] Lighting Level (Status)	0 - 100%
	1 Byte	O	CTR--	DPT_Scaling	0% - 100%	[C1+C2] Lighting Level (Status)	0 - 100%
28, 29	1 Bit	I	C--W-	DPT_Switch	0/1	[Cx] Custom On/Off 1	0 = Off; 1 = On
	1 Bit	I	C--W-	DPT_Switch	0/1	[C1+C2] Custom On/Off 1	0 = Off; 1 = On
30, 31	1 Bit	I	C--W-	DPT_Switch	0/1	[Cx] Custom On/Off 2	0 = Off; 1 = On
	1 Bit	I	C--W-	DPT_Switch	0/1	[C1+C2] Custom On/Off 2	0 = Off; 1 = On
32, 33	1 Bit	I	C--W-	DPT_Start	0/1	[Cx] Simple Timer	0 = Deactivate; 1 = Activate
	1 Bit	I	C--W-	DPT_Start	0/1	[C1+C2] Simple Timer	0 = Deactivate; 1 = Activate
34, 35	1 Bit	I	C--W-	DPT_Start	0/1	[Cx] Flashing	0 = Deactivate; 1 = Activate
	1 Bit	I	C--W-	DPT_Start	0/1	[C1+C2] Flashing	0 = Deactivate; 1 = Activate
36, 37	1 Byte	I	C--W-	DPT_SceneControl	0-63; 128-191	[Cx] Scenes/Sequences	Scene/Sequence value
	1 Byte	I	C--W-	DPT_SceneControl	0-63; 128-191	[C1+C2] Scenes/Sequences	Scene/Sequence value
38, 39	1 Bit	I	C--W-	DPT_Start	0/1	[Cx] Start/Stop Sequence	0 = Stop; 1 = Start
	1 Bit	I	C--W-	DPT_Start	0/1	[Cx] Resume/Pause Sequence	0 = Pause; 1 = Resume
	1 Bit	I	C--W-	DPT_Start	0/1	[C1+C2] Start/Stop Sequence	0 = Stop; 1 = Start
	1 Bit	I	C--W-	DPT_Start	0/1	[C1+C2] Resume/Pause Sequence	0 = Pause; 1 = Resume
40, 41	1 Bit	I/O	C-RW-	DPT_Enable	0/1	[Cx] Lock	0 = Unlock; 1 = Lock
	1 Bit	I/O	C-RW-	DPT_Enable	0/1	[Cx] Lock	0 = Lock; 1 = Unlock
	1 Bit	I/O	C-RW-	DPT_Enable	0/1	[C1+C2] Lock	0 = Unlock; 1 = Lock
	1 Bit	I/O	C-RW-	DPT_Enable	0/1	[C1+C2] Lock	0 = Lock; 1 = Unlock

42	1 Bit	I/O	C - R W -	DPT_Enable	0/1	Lock manual control	0 = Unlock; 1 = Lock
	1 Bit	I/O	C - R W -	DPT_Enable	0/1	Lock manual control	0 = Lock; 1 = Unlock
43, 44	1 Byte	I	C - - W -	20.xxx	0/1/2	[Cx] Edge Select (Only for Test Purposes)	0 = Automatic; 1 = Leading; 2 = Trailing
	1 Byte	I	C - - W -	20.xxx	0/1/2	[C1+C2] Edge Select (Only for Test Purposes)	0 = Automatic; 1 = Leading; 2 = Trailing
45, 46	1 Byte	I	C - - W -		0/1/2	[Cx] Dimming Pattern (Only for Test Purposes)	0 = Linear; 1 = Curve 1; 2 = Curve 2
	1 Byte	I	C - - W -		0/1/2	[C1+C2] Dimming Pattern (Only for Test Purposes)	0 = Linear; 1 = Curve 1; 2 = Curve 2
47, 48	1 Bit	I	C - - W -	DPT_Alarm	0/1	[Cx] Alarm	0 = Normal; 1 = Alarm
	1 Bit	I	C - - W -	DPT_Alarm	0/1	[Cx] Alarm	0 = Alarm; 1 = Normal
	1 Bit	I	C - - W -	DPT_Alarm	0/1	[C1+C2] Alarm	0 = Normal; 1 = Alarm
	1 Bit	I	C - - W -	DPT_Alarm	0/1	[C1+C2] Alarm	0 = Alarm; 1 = Normal
49, 50	1 Bit	I	C - - W -	DPT_Ack	0/1	[Cx] Unfreeze Alarm	Alarm = 0 + Unfreeze = 1 => End Alarm
	1 Bit	I	C - - W -	DPT_Ack	0/1	[Cx] Unfreeze Alarm	Alarm = 1 + Unfreeze = 1 => End Alarm
	1 Bit	I	C - - W -	DPT_Ack	0/1	[C1+C2] Unfreeze Alarm	Alarm = 0 + Unfreeze = 1 => End Alarm
	1 Bit	I	C - - W -	DPT_Ack	0/1	[C1+C2] Unfreeze Alarm	Alarm = 1 + Unfreeze = 1 => End Alarm
51, 52	1 Byte	I	C - - W -	DPT_Scaling	0% - 100%	[C1+C2] Minimum Dimming Value (Only for Test Purposes)	0 - 50%
	1 Byte	I	C - - W -	DPT_Scaling	0% - 100%	[Cx] Minimum Dimming Value (Only for Test Purposes)	0 - 50%
53	1 Bit		C T - - -	DPT_Trigger	0/1	[Heartbeat] Object to Send '1'	Sending of '1' Periodically
54, 60	1 Bit	I	C - - W -	DPT_Enable	0/1	[Ix] Input Lock	0 = Unlock; 1 = Lock
55, 56, 61, 62	1 Bit		C T - - -	DPT_Switch	0/1	[Ix] [Short Press] 0	Sending of 0
	1 Bit		C T - - -	DPT_Switch	0/1	[Ix] [Short Press] 1	Sending of 1
	1 Bit	I	C T - W -	DPT_Switch	0/1	[Ix] [Short Press] 0/1 Switching	Switching 0/1
	1 Bit		C T - - -	DPT_UpDown	0/1	[Ix] [Short Press] Move Up Shutter	Sending of 0 (Up)
	1 Bit		C T - - -	DPT_UpDown	0/1	[Ix] [Short Press] Move Down Shutter	Sending of 1 (Down)
	1 Bit		C T - - -	DPT_UpDown	0/1	[Ix] [Short Press] Move Up/Down Shutter	Switching 0/1 (Up/Down)
	1 Bit		C T - - -	DPT_Step	0/1	[Ix] [Short Press] Stop/Step Up Shutter	Sending of 0 (Stop/Step Up)
	1 Bit		C T - - -	DPT_Step	0/1	[Ix] [Short Press] Stop/Step Down Shutter	Sending of 1 (Stop/Step Down)
	1 Bit		C T - - -	DPT_Step	0/1	[Ix] [Short Press] Stop/Step Shutter (Switched)	Switching of 0/1 (Stop/Step Up/Down)

	4 Bit		CT----	DPT_Control_Dimming	0x0 (Stop) 0x1 (Dec. by 100%) ... 0x7 (Dec. by 1%) 0x8 (Stop) 0x9 (Inc. by 100%) ... 0xF (Inc. by 1%)	[Ix] [Short Press] Brighter	Increase Brightness
	4 Bit		CT----	DPT_Control_Dimming	0x0 (Stop) 0x1 (Dec. by 100%) ... 0x7 (Dec. by 1%) 0x8 (Stop) 0x9 (Inc. by 100%) ... 0xF (Inc. by 1%)	[Ix] [Short Press] Darker	Decrease Brightness
	4 Bit		CT----	DPT_Control_Dimming	0x0 (Stop) 0x1 (Dec. by 100%) ... 0x7 (Dec. by 1%) 0x8 (Stop) 0x9 (Inc. by 100%) ... 0xF (Inc. by 1%)	[Ix] [Short Press] Brighter/Darker	Switch Bright/Dark
	1 Bit		CT----	DPT_Switch	0/1	[Ix] [Short Press] Light On	Sending of 1 (On)
	1 Bit		CT----	DPT_Switch	0/1	[Ix] [Short Press] Light Off	Sending of 0 (Off)
	1 Bit	I	CT-W-	DPT_Switch	0/1	[Ix] [Short Press] Light On/Off	Switching 0/1
	1 Byte		CT----	DPT_SceneControl	0-63; 128-191	[Ix] [Short Press] Run Scene	Sending of 0 - 63
	1 Byte		CT----	DPT_SceneControl	0-63; 128-191	[Ix] [Short Press] Save Scene	Sending of 128 - 191
	1 Bit	I/O	CTRW-	DPT_Switch	0/1	[Ix] [Switch/Sensor] Edge	Sending of 0 or 1
	1 Byte		CT----	DPT_Value_1_Ucount	0 - 255	[Ix] [Short Press] Constant Value (Integer)	0 - 255
	1 Byte		CT----	DPT_Scaling	0% - 100%	[Ix] [Short Press] Constant Value (Percentage)	0% - 100%
	2 Bytes		CT----	DPT_Value_2_Ucount	0 - 65535	[Ix] [Short Press] Constant Value (Integer)	0 - 65535
	2 Bytes		CT----	9.xxx	-671088.64 - 670760.96	[Ix] [Short Press] Constant Value (Float)	Float Value
	1 Byte	I	C--W-	DPT_Scaling	0% - 100%	[Ix] [Short Press] Shutter Status (Input)	0% = Top; 100% = Bottom
	1 Byte	I	C--W-	DPT_Scaling	0% - 100%	[Ix] [Short Press] Dimming Status (Input)	0% - 100%
57, 63	1 Bit		CT----	DPT_Switch	0/1	[Ix] [Long Press] 0	Sending of 0

1 Bit		CT----	DPT_Switch	0/1	[Ix] [Long Press] 1	Sending of 1
1 Bit	I	CT-W-	DPT_Switch	0/1	[Ix] [Long Press] 0/1 Switching	Switching 0/1
1 Bit		CT----	DPT_UpDown	0/1	[Ix] [Long Press] Move Up Shutter	Sending of 0 (Up)
1 Bit		CT----	DPT_UpDown	0/1	[Ix] [Long Press] Move Down Shutter	Sending of 1 (Down)
1 Bit		CT----	DPT_UpDown	0/1	[Ix] [Long Press] Move Up/Down Shutter	Switching 0/1 (Up/Down)
1 Bit		CT----	DPT_Step	0/1	[Ix] [Long Press] Stop/Step Up Shutter	Sending of 0 (Stop/Step Up)
1 Bit		CT----	DPT_Step	0/1	[Ix] [Long Press] Stop/Step Down Shutter	Sending of 1 (Stop/Step Down)
1 Bit		CT----	DPT_Step	0/1	[Ix] [Long Press] Stop/Step Shutter (Switched)	Switching of 0/1 (Stop/Step Up/Down)
4 Bit		CT----	DPT_Control_Dimming	0x0 (Stop) 0x1 (Dec. by 100%) ... 0x7 (Dec. by 1%) 0x8 (Stop) 0x9 (Inc. by 100%) ... 0xF (Inc. by 1%)	[Ix] [Long Press] Brighter	Long Pr. -> Brighter; Release -> Stop
4 Bit		CT----	DPT_Control_Dimming	0x0 (Stop) 0x1 (Dec. by 100%) ... 0x7 (Dec. by 1%) 0x8 (Stop) 0x9 (Inc. by 100%) ... 0xF (Inc. by 1%)	[Ix] [Long Press] Darker	Long Pr. -> Darker; Release -> Stop
4 Bit		CT----	DPT_Control_Dimming	0x0 (Stop) 0x1 (Dec. by 100%) ... 0x7 (Dec. by 1%) 0x8 (Stop) 0x9 (Inc. by 100%) ... 0xF (Inc. by 1%)	[Ix] [Long Press] Brighter/Darker	Long Pr. -> Brighter/Darker; Release -> Stop
1 Bit		CT----	DPT_Switch	0/1	[Ix] [Long Press] Light On	Sending of 1 (On)
1 Bit		CT----	DPT_Switch	0/1	[Ix] [Long Press] Light Off	Sending of 0 (Off)
1 Bit	I	CT-W-	DPT_Switch	0/1	[Ix] [Long Press] Light On/Off	Switching 0/1
1 Byte		CT----	DPT_SceneControl	0-63; 128-191	[Ix] [Long Press] Run Scene	Sending of 0 - 63
1 Byte		CT----	DPT_SceneControl	0-63; 128-191	[Ix] [Long Press] Save Scene	Sending of 128 - 191

	1 Bit	O	CTR--	DPT_Alarm	0/1	[Ix] [Switch/Sensor] Alarm: Breakdown or Sabotage	1 = Alarm; 0 = No Alarm
	2 Bytes		CT---	9.xxx	-671088.64 - 670760.96	[Ix] [Long Press] Constant Value (Float)	Float Value
	2 Bytes		CT---	DPT_Value_2_Ucount	0 - 65535	[Ix] [Long Press] Constant Value (Integer)	0 - 65535
	1 Byte		CT---	DPT_Scaling	0% - 100%	[Ix] [Long Press] Constant Value (Percentage)	0% - 100%
	1 Byte		CT---	DPT_Value_1_Ucount	0 - 255	[Ix] [Long Press] Constant Value (Integer)	0 - 255
58, 64	1 Bit		CT---	DPT_Trigger	0/1	[Ix] [Long Press/Release] Stop Shutter	Release -> Stop Shutter
59, 65	1 Byte	I	C--W-	DPT_Scaling	0% - 100%	[Ix] [Long Press] Dimming Status (Input)	0% - 100%
	1 Byte	I	C--W-	DPT_Scaling	0% - 100%	[Ix] [Long Press] Shutter Status (Input)	0% = Top; 100% = Bottom
66, 70	2 Bytes	O	CTR--	DPT_Value_Temp	-273.00 - 670760.00	[Ix] Current Temperature	Temperature sensor value
67, 71	1 Bit	O	CTR--	DPT_Alarm	0/1	[Ix] Overcooling	0 = No Alarm; 1 = Alarm
68, 72	1 Bit	O	CTR--	DPT_Alarm	0/1	[Ix] Overheating	0 = No Alarm; 1 = Alarm
69, 73	1 Bit	O	CTR--	DPT_Alarm	0/1	[Ix] Probe Error	0 = No Alarm; 1 = Alarm
74	1 Byte	I	C--W-	DPT_SceneControl	0-63; 128-191	[Motion Detector] Scene Input	Scene Value
75	1 Byte		CT---	DPT_SceneControl	0-63; 128-191	[Motion Detector] Scene Output	Scene Value
76, 105	1 Byte	O	CTR--	DPT_Scaling	0% - 100%	[Ix] Luminosity	0-100%
77, 106	1 Bit	O	CTR--	DPT_Alarm	0/1	[Ix] Open Circuit Error	0 = No Error; 1 = Open Circuit Error
78, 107	1 Bit	O	CTR--	DPT_Alarm	0/1	[Ix] Short Circuit Error	0 = No Error; 1 = Short Circuit Error
79, 108	1 Byte	O	CTR--	DPT_Scaling	0% - 100%	[Ix] Presence State (Scaling)	0-100%
80, 109	1 Byte	O	CTR--	DPT_HVACMode	1=Comfort 2=Standby 3=Economy 4=Building Protection	[Ix] Presence State (HVAC)	Auto, Comfort, Standby, Economy, Building Protection
81, 110	1 Bit	O	CTR--	DPT_Occupancy	0/1	[Ix] Presence State (Binary)	Binary Value
	1 Bit	O	CTR--	DPT_Ack	0/1	[Ix] Presence: Slave Output	1 = Motion Detected
82, 111	1 Bit	I	C--W-	DPT_Window_Door	0/1	[Ix] Presence Trigger	Binary Value to Trigger the Presence Detection
83, 112	1 Bit	I	C--W-	DPT_Ack	0/1	[Ix] Presence: Slave Input	0 = Nothing; 1 = Detection from slave device
84, 113	2 Bytes	I	C--W-	DPT_TimePeriodSec	0 - 65535	[Ix] Presence: Waiting Time	0-65535 s.
85, 114	2 Bytes	I	C--W-	DPT_TimePeriodSec	0 - 65535	[Ix] Presence: Listening Time	1-65535 s.
86, 115	1 Bit	I	C--W-	DPT_Enable	0/1	[Ix] Presence: Enable	According to parameters
87, 116	1 Bit	I	C--W-	DPT_Switch	0/1	[Ix] Presence: Day/Night	According to parameters

88, 117	1 Bit	O	CTR--	DPT_Occupancy	0/1	[Ix] Presence: Occupancy State	0 = Not Occupied; 1 = Occupied
89, 118	1 Bit	I	C--W-	DPT_Ack	0/1	[Ix] External Motion Detection	0 = Nothing; 1 = Motion detected by an external sensor
90, 95, 100, 119, 124, 129	1 Byte	O	CTR--	DPT_Scaling	0% - 100%	[Ix] [Cy] Detection State (Scaling)	0-100%
91, 96, 101, 120, 125, 130	1 Byte	O	CTR--	DPT_HVACMode	1=Comfort 2=Standby 3=Economy 4=Building Protection	[Ix] [Cy] Detection State (HVAC)	Auto, Comfort, Standby, Economy, Building Protection
92, 97, 102, 121, 126, 131	1 Bit	O	CTR--	DPT_Switch	0/1	[Ix] [Cy] Detection State (Binary)	Binary Value
93, 98, 103, 122, 127, 132	1 Bit	I	C--W-	DPT_Enable	0/1	[Ix] [Cy] Enable Channel	According to parameters
94, 99, 104, 123, 128, 133	1 Bit	I	C--W-	DPT_Switch	0/1	[Ix] [Cy] Force State	0 = No Detection; 1 = Detection
134, 135, 136, 137, 138, 139, 140, 141, 142, 143, 144, 145, 146, 147, 148, 149, 150, 151, 152, 153, 154, 155, 156, 157, 158, 159, 160, 161, 162, 163, 164, 165	1 Bit	I	C--W-	DPT_Bool	0/1	[LF] (1-Bit) Data Entry x	Binary Data Entry (0/1)
166, 167, 168, 169, 170, 171, 172, 173, 174, 175, 176, 177, 178, 179, 180, 181	1 Byte	I	C--W-	DPT_Value_1_Ucount	0 - 255	[LF] (1-Byte) Data Entry x	1-Byte Data Entry (0-255)
182, 183, 184, 185, 186, 187, 188, 189, 190, 191, 192, 193, 194, 195, 196, 197	2 Bytes	I	C--W-	DPT_Value_2_Ucount	0 - 65535	[LF] (2-Byte) Data Entry x	2-Byte Data Entry
				DPT_Value_2_Count	-32768 - 32767		
				DPT_Value_Temp	-273,00 - 670760,00		
198, 199, 200, 201, 202, 203, 204, 205	4 Bytes	I	C--W-	DPT_Value_4_Count	-2147483648 - 2147483247	[LF] (4-Byte) Data Entry x	4-Byte Data Entry
206, 207, 208, 209, 210, 211, 212, 213, 214, 215	1 Bit	O	CTR--	DPT_Bool	0/1	[LF] Function x - Result	(1-Bit) Boolean
	1 Byte	O	CTR--	DPT_Value_1_Ucount	0 - 255	[LF] Function x - Result	(1-Byte) Unsigned
	2 Bytes	O	CTR--	DPT_Value_2_Ucount	0 - 65535	[LF] Function x - Result	(2-Byte) Unsigned
	4 Bytes	O	CTR--	DPT_Value_4_Count	-2147483648 - 2147483247	[LF] Function x - Result	(4-Byte) Signed
	1 Byte	O	CTR--	DPT_Scaling	0% - 100%	[LF] Function x - Result	(1-Byte) Percentage
	2 Bytes	O	CTR--	DPT_Value_2_Count	-32768 - 32767	[LF] Function x - Result	(2-Byte) Signed
	2 Bytes	O	CTR--	DPT_Value_Temp	-273.00 - 670760.00	[LF] Function x - Result	(2-Byte) Float

ANNEX II: COMMUNICATION OBJECTS OF DIMINBOX DX4

“Functional range” shows the values that, with independence of any other values permitted by the bus according to the object size, may be of any use or have a particular meaning because of the specifications or restrictions from both the KNX standard or the application program itself.

Number	Size	I/O	Flags	Data type (DPT)	Functional Range	Name	Function
1	2 Bytes	I/O	C - R W -	DPT_TimePeriodSec	0 - 65535	Smooth Dimming Time 1	Time in Seconds
2	2 Bytes	I/O	C - R W -	DPT_TimePeriodSec	0 - 65535	Smooth Dimming Time 2	Time in Seconds
3	1 Bit	O	CTR--	DPT_Alarm	0/1	Power Supply Failure	0 = No error; 1 = Error
4	1 Bit	O	CTR--	DPT_Alarm	0/1	Overheating	0 = No error; 1 = Error
5	1 Bit	O	CTR--	DPT_Alarm	0/1	Anomalous Frequency	0 = No error; 1 = Error
6	1 Bit	I/O	C - R W -	DPT_Enable	0/1	Lock manual control	0 = Unlock; 1 = Lock
	1 Bit	I/O	C - R W -	DPT_Enable	0/1	Lock manual control	0 = Lock; 1 = Unlock
7, 29, 51, 73	1 Bit	I	C--W-	DPT_Switch	0/1	[Cx] On/Off	0 = Off; 1 = On
7, 51	1 Bit	I	C--W-	DPT_Switch	0/1	[Cx+Cy] On/Off	0 = Off; 1 = On
7	1 Bit	I	C--W-	DPT_Switch	0/1	[C1+C2+C3+C4] On/Off	0 = Off; 1 = On
8, 30, 52, 74	1 Bit	O	CTR--	DPT_Switch	0/1	[Cx] On/Off (Status)	0 = Off; 1 = On
8	1 Bit	O	CTR--	DPT_Switch	0/1	[Cx+Cy] On/Off (Status)	0 = Off; 1 = On
	1 Bit	O	CTR--	DPT_Switch	0/1	[C1+C2+C3+C4] On/Off (Status)	0 = Off; 1 = On
9, 31, 53, 75	4 Bit	I	C--W-	DPT_Control_Dimming	0x0 (Stop) 0x1 (Dec. by 100%) 0x2 (Dec. by 50%) ... 0x7 (Dec. by 1%) 0x8 (Stop) 0x9 (Inc. by 100%) ... 0xD (Inc. by 6%) 0xE (Inc. by 3%) 0xF (Inc. by 1%)	[Cx] Relative Dimming	4-bit dimmer control
9, 53	4 Bit	I	C--W-	DPT_Control_Dimming	0x0 (Stop) 0x1 (Dec. by 100%) 0x2 (Dec. by 50%) 0x3 (Dec. by 25%) ... 0x7 (Dec. by 1%) 0x8 (Stop)	[Cx+Cy] Relative Dimming	4-bit dimmer control

					0x9 (Inc. by 100%) ... 0xD (Inc. by 6%) 0xE (Inc. by 3%) 0xF (Inc. by 1%)		
9	4 Bit	I	C - - W -	DPT_Control_Dimming	0x0 (Stop) 0x1 (Dec. by 100%) 0x2 (Dec. by 50%) ... 0x7 (Dec. by 1%) 0x8 (Stop) 0x9 (Inc. by 100%) ... 0xD (Inc. by 6%) 0xE (Inc. by 3%) 0xF (Inc. by 1%)	[C1+C2+C3+C4] Relative Dimming	4-bit dimmer control
10, 32, 54, 76	1 Byte	I	C - - W -	DPT_Scaling	0% - 100%	[Cx] Absolute Dimming	1-byte dimmer control
10, 54	1 Byte	I	C - - W -	DPT_Scaling	0% - 100%	[Cx+Cy] Absolute Dimming	1-byte dimmer control
10	1 Byte	I	C - - W -	DPT_Scaling	0% - 100%	[C1+C2+C3+C4] Absolute Dimming	1-byte dimmer control
11, 33, 55, 77	1 Byte	O	CTR - -	DPT_Scaling	0% - 100%	[Cx] Lighting Level (Status)	0 - 100%
11, 55	1 Byte	O	CTR - -	DPT_Scaling	0% - 100%	[Cx+Cy] Lighting Level (Status)	0 - 100%
11	1 Byte	O	CTR - -	DPT_Scaling	0% - 100%	[C1+C2+C3+C4] Lighting Level (Status)	0 - 100%
12, 34, 56, 78	1 Bit	I	C - - W -	DPT_Switch	0/1	[Cx] Custom On/Off 1	0 = Off; 1 = On
12, 56	1 Bit	I	C - - W -	DPT_Switch	0/1	[Cx+Cy] Custom On/Off 1	0 = Off; 1 = On
12	1 Bit	I	C - - W -	DPT_Switch	0/1	[C1+C2+C3+C4] Custom On/Off 1	0 = Off; 1 = On
13, 35, 57, 79	1 Bit	I	C - - W -	DPT_Switch	0/1	[Cx] Custom On/Off 2	0 = Off; 1 = On
13, 57	1 Bit	I	C - - W -	DPT_Switch	0/1	[Cx+Cy] Custom On/Off 2	0 = Off; 1 = On
13	1 Bit	I	C - - W -	DPT_Switch	0/1	[C1+C2+C3+C4] Custom On/Off 2	0 = Off; 1 = On
14, 36, 58, 80	1 Bit	I	C - - W -	DPT_Start	0/1	[Cx] Simple Timer	0 = Deactivate; 1 = Activate
14, 58	1 Bit	I	C - - W -	DPT_Start	0/1	[Cx+Cy] Simple Timer	0 = Deactivate; 1 = Activate
14	1 Bit	I	C - - W -	DPT_Start	0/1	[C1+C2+C3+C4] Simple Timer	0 = Deactivate; 1 = Activate
15, 37, 59, 81	1 Bit	I	C - - W -	DPT_Start	0/1	[Cx] Flashing	0 = Deactivate; 1 = Activate
15, 59	1 Bit	I	C - - W -	DPT_Start	0/1	[Cx+Cy] Flashing	0 = Deactivate; 1 = Activate
15	1 Bit	I	C - - W -	DPT_Start	0/1	[C1+C2+C3+C4] Flashing	0 = Deactivate; 1 = Activate
16, 38, 60, 82	1 Byte	I	C - - W -	DPT_SceneControl	0-63; 128-191	[Cx] Scenes/Sequences	Scene/Sequence value
16, 60	1 Byte	I	C - - W -	DPT_SceneControl	0-63; 128-191	[Cx+Cy] Scenes/Sequences	Scene/Sequence value
16	1 Byte	I	C - - W -	DPT_SceneControl	0-63; 128-191	[C1+C2+C3+C4] Scenes/Sequences	Scene/Sequence value
17, 39, 61, 83	1 Bit	I	C - - W -	DPT_Start	0/1	[Cx] Start/Stop Sequence	0 = Stop; 1 = Start
	1 Bit	I	C - - W -	DPT_Start	0/1	[Cx] Resume/Pause Sequence	0 = Pause; 1 = Resume

17, 61	1 Bit	I	C - - W -	DPT_Start	0/1	[Cx+Cy] Start/Stop Sequence	0 = Stop; 1 = Start
	1 Bit	I	C - - W -	DPT_Start	0/1	[Cx+Cy] Resume/Pause Sequence	0 = Pause; 1 = Resume
17	1 Bit	I	C - - W -	DPT_Start	0/1	[C1+C2+C3+C4] Start/Stop Sequence	0 = Stop; 1 = Start
	1 Bit	I	C - - W -	DPT_Start	0/1	[C1+C2+C3+C4] Resume/Pause Sequence	0 = Pause; 1 = Resume
18, 40, 62, 84	1 Bit	I/O	C - R W -	DPT_Enable	0/1	[Cx] Lock	0 = Lock; 1 = Unlock
	1 Bit	I/O	C - R W -	DPT_Enable	0/1	[Cx] Lock	0 = Unlock; 1 = Lock
18, 62	1 Bit	I/O	C - R W -	DPT_Enable	0/1	[Cx+Cy] Lock	0 = Unlock; 1 = Lock
	1 Bit	I/O	C - R W -	DPT_Enable	0/1	[Cx+Cy] Lock	0 = Lock; 1 = Unlock
18	1 Bit	I/O	C - R W -	DPT_Enable	0/1	[C1+C2+C3+C4] Lock	0 = Unlock; 1 = Lock
	1 Bit	I/O	C - R W -	DPT_Enable	0/1	[C1+C2+C3+C4] Lock	0 = Lock; 1 = Unlock
19, 41, 63, 85	1 Bit	I	C - - W -	DPT_Alarm	0/1	[Cx] Alarm	0 = No Alarm; 1 = Alarm
	1 Bit	I	C - - W -	DPT_Alarm	0/1	[Cx] Alarm	0 = Alarm; 1 = No Alarm
19, 63	1 Bit	I	C - - W -	DPT_Alarm	0/1	[Cx+Cy] Alarm	0 = No Alarm; 1 = Alarm
	1 Bit	I	C - - W -	DPT_Alarm	0/1	[Cx+Cy] Alarm	0 = Alarm; 1 = No Alarm
19	1 Bit	I	C - - W -	DPT_Alarm	0/1	[C1+C2+C3+C4] Alarm	0 = Alarm; 1 = No Alarm
	1 Bit	I	C - - W -	DPT_Alarm	0/1	[C1+C2+C3+C4] Alarm	0 = No Alarm; 1 = Alarm
20, 42, 64, 86	1 Bit	I	C - - W -	DPT_Ack	0/1	[Cx] Unfreeze Alarm	Alarm = 0 + Unfreeze = 1 => End Alarm
	1 Bit	I	C - - W -	DPT_Ack	0/1	[Cx] Unfreeze Alarm	Alarm = 1 + Unfreeze = 1 => End Alarm
20, 64	1 Bit	I	C - - W -	DPT_Ack	0/1	[Cx+Cy] Unfreeze Alarm	Alarm = 0 + Unfreeze = 1 => End Alarm
	1 Bit	I	C - - W -	DPT_Ack	0/1	[Cx+Cy] Unfreeze Alarm	Alarm = 1 + Unfreeze = 1 => End Alarm
20	1 Bit	I	C - - W -	DPT_Ack	0/1	[C1+C2+C3+C4] Unfreeze Alarm	Alarm = 1 + Unfreeze = 1 => End Alarm
	1 Bit	I	C - - W -	DPT_Ack	0/1	[C1+C2+C3+C4] Unfreeze Alarm	Alarm = 0 + Unfreeze = 1 => End Alarm
21, 43, 65, 87	1 Bit	O	C T R - -	DPT_Alarm	0/1	[Cx] Short Circuit	0 = No error; 1 = Error
21, 65	1 Bit	O	C T R - -	DPT_Alarm	0/1	[Cx+Cy] Short Circuit	0 = No error; 1 = Error
21	1 Bit	O	C T R - -	DPT_Alarm	0/1	[C1+C2+C3+C4] Short Circuit	0 = No error; 1 = Error
22, 44, 66, 88	1 Bit	O	C T R - -	DPT_Bool	0/1	[Cx] Lock Due to Short Circuits	0 = Unlocked; 1 = Locked
22, 66	1 Bit	O	C T R - -	DPT_Bool	0/1	[Cx+Cy] Lock Due to Short Circuits	0 = Unlocked; 1 = Locked
22	1 Bit	O	C T R - -	DPT_Bool	0/1	[C1+C2+C3+C4] Lock Due to Short Circuits	0 = Unlocked; 1 = Locked
23, 45, 67, 89	1 Bit	O	C T R - -	DPT_Alarm	0/1	[Cx] Overvoltage	0 = No error; 1 = Error
23, 67	1 Bit	O	C T R - -	DPT_Alarm	0/1	[Cx+Cy] Overvoltage	0 = No error; 1 = Error

23	1 Bit	O	CTR--	DPT_Alarm	0/1	[C1+C2+C3+C4] Overvoltage	0 = No error; 1 = Error
24, 46, 68, 90	1 Bit	O	CTR--	DPT_Bool	0/1	[Cx] Lock Due to Overvoltages	0 = Unlocked; 1 = Locked
24, 68	1 Bit	O	CTR--	DPT_Bool	0/1	[Cx+Cy] Lock Due to Overvoltages	0 = Unlocked; 1 = Locked
24	1 Bit	O	CTR--	DPT_Bool	0/1	[C1+C2+C3+C4] Lock Due to Overvoltages	0 = Unlocked; 1 = Locked
25, 47, 69, 91	1 Bit	O	CTR--	DPT_Alarm	0/1	[Cx] Load Type Parameterization Error	0 = No error; 1 = Error
25, 69	1 Bit	O	CTR--	DPT_Alarm	0/1	[Cx+Cy] Load Type Parameterization Error	0 = No error; 1 = Error
25	1 Bit	O	CTR--	DPT_Alarm	0/1	[C1+C2+C3+C4] Load Type Parameterization Error	0 = No error; 1 = Error
52	1 Bit	O	CTR--	DPT_Switch	0/1	[Cx+Cy] On/Off (estado)	0 = Off; 1 = On
95, 96, 97, 98, 99, 100, 101, 102, 103, 104, 105, 106, 107, 108, 109, 110, 111, 112, 113, 114, 115, 116, 117, 118, 119, 120, 121, 122, 123, 124, 125, 126	1 Bit	I	C--W-	DPT_Bool	0/1	[LF] (1-Bit) Data Entry x	Binary Data Entry (0/1)
127, 128, 129, 130, 131, 132, 133, 134, 135, 136, 137, 138, 139, 140, 141, 142	1 Byte	I	C--W-	DPT_Value_1_Ucount	0 - 255	[LF] (1-Byte) Data Entry x	1-Byte Data Entry (0-255)
143, 144, 145, 146, 147, 148, 149, 150, 151, 152, 153, 154, 155, 156, 157, 158	2 Bytes	I	C--W-	DPT_Value_2_Ucount	0 - 65535	[LF] (2-Byte) Data Entry x	2-Byte Data Entry
				DPT_Value_2_Count	-32768 - 32767		
				DPT_Value_Temp	-273,00 - 670760,00		
159, 160, 161, 162, 163, 164, 165, 166	4 Bytes	I	C--W-	DPT_Value_4_Count	-2147483648 - 2147483647	[LF] (4-Byte) Data Entry x	4-Byte Data Entry
167, 168, 169, 170, 171, 172, 173, 174, 175, 176	1 Bit	O	CTR--	DPT_Bool	0/1	[LF] Function x - Result	(1-Bit) Boolean
	1 Byte	O	CTR--	DPT_Value_1_Ucount	0 - 255	[LF] Function x - Result	(1-Byte) Unsigned
	2 Bytes	O	CTR--	DPT_Value_2_Ucount	0 - 65535	[LF] Function x - Result	(2-Byte) Unsigned
	4 Bytes	O	CTR--	DPT_Value_4_Count	-2147483648 - 2147483647	[LF] Function x - Result	(4-Byte) Signed
	1 Byte	O	CTR--	DPT_Scaling	0% - 100%	[LF] Function x - Result	(1-Byte) Percentage
	2 Bytes	O	CTR--	DPT_Value_2_Count	-32768 - 32767	[LF] Function x - Result	(2-Byte) Signed
	2 Bytes	O	CTR--	DPT_Value_Temp	-273.00° - 670760.00°	[LF] Function x - Result	(2-Byte) Float
177	1 Bit		CT---	DPT_Trigger	0/1	[Heartbeat] Object to Send '1'	Sending of '1' Periodically



Join and send us your inquiries
about Zennio devices:

<http://support.zennio.com>

Zennio Avance y Tecnología S.L.
C/ Río Jarama, 132. Nave P-8.11
45007 Toledo (Spain).

Tel. +34 925 232 002.

www.zennio.com
info@zennio.com

