

Operating Instructions **Busch-ComfortTouch®**



Busch-ComfortTouch® 9

8136/09-811-500

(CP/U 9.3.1)

8136/09-825-500

(CP/U 9.4.1)

Busch-ComfortTouch® 12.1

8136/12-811-500

(CP/U 12.3.1)

8136/12-825-500

(CP/U 12.4.1)

1	Notes on operating instructions.....	3
1.1	General information.....	3
1.2	Setup of the manual.....	3
1.3	Symbols in the manual.....	3
2	Safety.....	4
2.1	Intended use.....	4
2.2	Improper use.....	4
2.3	Liability and warranty.....	5
3	Environment.....	5
4	Product overview.....	6
4.1	Product description.....	6
4.2	Function overview.....	7
4.3	Device setup.....	9
5	Operation.....	10
5.1	Fundamentals.....	10
5.1.1	Colour concept.....	10
5.1.2	Basic setup of the monitor.....	11
5.1.3	Navigation bar.....	12
5.1.4	Status bar.....	13
5.2	Operating processes on the touchdisplay.....	15
5.2.1	Buttons.....	15
5.2.2	Control elements.....	16
5.2.3	Entries.....	27
5.2.4	Swiping motions (scrolling).....	27
5.3	Explanation of functions.....	28
5.3.1	Page types.....	28
5.3.2	Basic functions of switching, dimming, blinds, value, scenes, RTC and measured values.....	29
5.3.3	Media Player.....	30
5.3.4	Image messaging.....	32
5.3.5	Voice messages.....	35
5.3.6	E-mail.....	37
5.3.7	Feed Reader.....	39
5.3.8	Weekly programs.....	41
5.3.9	Calendar (twelve-month timer).....	44
5.3.10	Miele (only via Plug-In).....	45
5.3.11	Camera surveillance.....	46
5.3.12	Alarm control unit.....	48
5.3.13	Presence simulation.....	50
5.3.14	Short-time timer.....	51
5.3.15	Alarm clock.....	53
5.3.16	Data logger.....	55
5.3.17	Web browser.....	56
5.3.18	Telephone (VoIP).....	57
5.3.19	Door Communication.....	61
5.3.20	Fault and alarm messages.....	66
5.3.21	IR remote control.....	67
5.3.22	Scene editor.....	68
5.3.23	Room temperature controller.....	71
5.3.24	Date and time settings.....	75
5.3.25	Import and export of files.....	77
5.3.26	System settings.....	78
5.3.27	Device information.....	79
6	Cleaning.....	80

1 Notes on operating instructions

1.1 General information

Please read this manual through carefully and adhere to the information listed. This will ensure reliable operation and long service life of your product.

If additional information is required or problems arise that are not dealt with in this manual, the necessary information can be requested from the manufacturer or from your electrical installer.

1.2 Setup of the manual

- This manual provides you with the detailed information about the operation. This will ensure reliable operation and long service life of your product.
- The chapters "Information on the manual", "Safety", "Environmental information" and "Product overview" contain general specifications and basic information as well as a description of functions.
- The operation of the device is explained in chapter "Operation".
- Chapter "Maintenance" contains information about cleaning.

1.3 Symbols in the manual



Attention - damage to property

This symbol indicates a possibly harmful situation. Non-observance of the safety instructions can lead to damage or destruction of the product.



Note ...

This symbol indicates information or references to additional useful topics. This is not a signal word for a dangerous situation.



This symbol indicates information on the protection of the environment.

2 Safety



Caution

Risk of damaging the device due to external factors!

Moisture and contamination can damage the device.

That is why the device must be protected against humidity, dirt and damage during storage (renovations) and operation.

2.1 Intended use

The **Busch-ComfortTouch®** is a central switching and monitoring location for the entire building automation with control, monitoring and visualisation functions for numerous devices and media within a building. The device makes available numerous functions. The range of functions is contained in chapter "Description of Functions".



Note

The device must only be used in dry indoor rooms.



Note

Making and saving video recordings can infringe on personal rights! Always observe applicable legal and labeling requirements for placement and operation of video components!

2.2 Improper use

The device is dangerous if used improperly. Any non-intended use is deemed improper use. The manufacturer is not liable for damages resulting from such improper use. The associated risk is borne by the user/operator.

The device must never be used outdoors or in bathroom areas. Do not push objects through the openings in the device.

Maintenance and repair work must only be performed by authorized electricians.

2.3 Liability and warranty

Improper use and non-observance of this manual excludes the liability of the manufacturer for the damages caused. It voids the warranty of the manufacturer.

3 Environment



Consider the protection of the environment!

Used electric and electronic devices must not be disposed of with domestic waste.

- The device contains valuable raw materials which can be recycled. Therefore, dispose of the device at the appropriate collecting depot.

All packaging materials and devices bear the markings and test seals for proper disposal. Always dispose of the packaging material and electric devices and their components via the authorized collecting depots and disposal companies.

The products meet the legal requirements, in particular the laws governing electronic and electrical devices and the REACH ordinance.

(EU Directive 2002/96/EC WEEE and 2002/95/EC RoHS)

(EU REACH ordinance and law for the implementation of the ordinance (EC) No.1907/2006)

4 Product overview

4.1 Product description

Busch-ComfortTouch® are high-quality colour touch displays in 16:9 format with a resolution of 800 x 400 pixel for the 9" display and 800 x 1280 pixel for the 12.1" display.

The **Busch-ComfortTouch®** consists of a basic system on a modern computer platform that is also designed for future tasks and is capable of being upgraded. The unit is of fan-free cooling design and does not require a mechanical hard disc to store the platform-independent operating system in the device.

The **Busch-ComfortTouch®** is a central switching and monitoring location for the entire building automation with control, monitoring and visualisation functions for numerous devices and media within a building. It unites the functions of a building control system and an information and entertainment centre on a single monitor. Using the colour display, it is possible to switch on or dim lights in the entire building, control the blinds or regulate the room temperature or scenes using a combination of the functions mentioned above - even via remote control. Operation and control is carried out via the labelled touch surfaces in a clear menu structure and/or via floor plans and room views. The labelling code is of a design that is understood internationally and does not rely on language. They can be supplemented by easily understood function icons. No lettering is needed. You can design the touch surfaces to your individual preferences independent of the parameter settings.

The display has LED backlighting. The integrated speaker can, for example, provide acoustic feedback to operations, be used as an alarm clock or to signal alarms and fault messages and can also be used for playing back stored audio files.

The **Busch-ComfortTouch®** has a USB connection (USB 2.0) and a slot for a multimedia card / SD card (SD, SDHC and Micro SD (SDHC with the use of a suitable adapter)).

The design of the **Busch-ComfortTouch®** allows the connection to networks via LAN or WLAN. Access to KNX is also possible by means of the optional connection of twisted pair modules or via the appropriate IP/KNX router. And the device can additionally serve as gateway between IP networks and KNX networks.

4.2 Function overview

The following table provides an overview of the functions of the **Busch-ComfortTouch®**:



Note

The overview shows all the functions the **Busch-ComfortTouch®** offers. However, many functions are available only when the project planning software of the **Busch-ComfortTouch®** has been appropriately activated. Please contact your electrical installer who will set up the **Busch-ComfortTouch®** for you individually according to your wishes.

Function group	Function	Description
Entertainment / Multimedia	Media Player (includes Web Radio and Web TV)	Replay of: - Audio and video data - Internet Radio Streams - Internet TV Streams
News	Image messaging	Recording and displaying of notes
	Voice message	Recording and playback of voice messages
	E-mail	Reading of e-mails
	Feed Reader	Reading of feeds (news feeds)
Building control	KNX *)	Control and monitoring of a KNX bus system
	Scene editor	Editing and calling up of scenes and sequences
	Weekly timers	Editing of weekly timers
	Calendar (twelve-month timer)	Setting specific repeating anniversaries
	Miele (only via Plug-In)	For activating Miele household appliances
	Logic editor *)	Setting of separate logic functions, for implementing complex switching sequences
Safety	Camera surveillance	Display of IP camera images
	Alarm control unit	Protection against unwanted visitors
	Presence simulation	Recording and replay of switching sequences which can be automatically simulated during absence
Tools	Short-time timer	Integrating an egg timer
	Alarm clock	Integration of an alarm clock
	Data logger	Recording of data, e.g. energy consumption
	Web browser	Call-up of predefined Internet sites
Telephony	Telephone (VoIP)	Internet telephony
	Door Communication	For the communication with image and sound between the Busch-ComfortTouch® and an outdoor station

Function group	Function	Description
Settings	IR remote control	Editing and calling up scenes, sequences and operating functions via an infrared remote control
	Fault and alarm messages	Displaying and acknowledgement of faults
	Access control *)	Locking individual pages with password protection
	File browser *)	Administering external storage media and network shares
	Mobile access *)	Remotely controlling the Busch-ComfortTouch® (via MobileApp)
	Camera module	Use in various applications (e.g. door communication)
Control elements	Basic functions of switching, dimming, blinds, value, scenes, RTC and measured values	All conventional functions in building automation can be controlled and have their status displayed

*) No directly visible application with an operating page. The setting is made by the electrical installer via the project planning software. The activation is fundamental in part for other applications.

4.3 Device setup

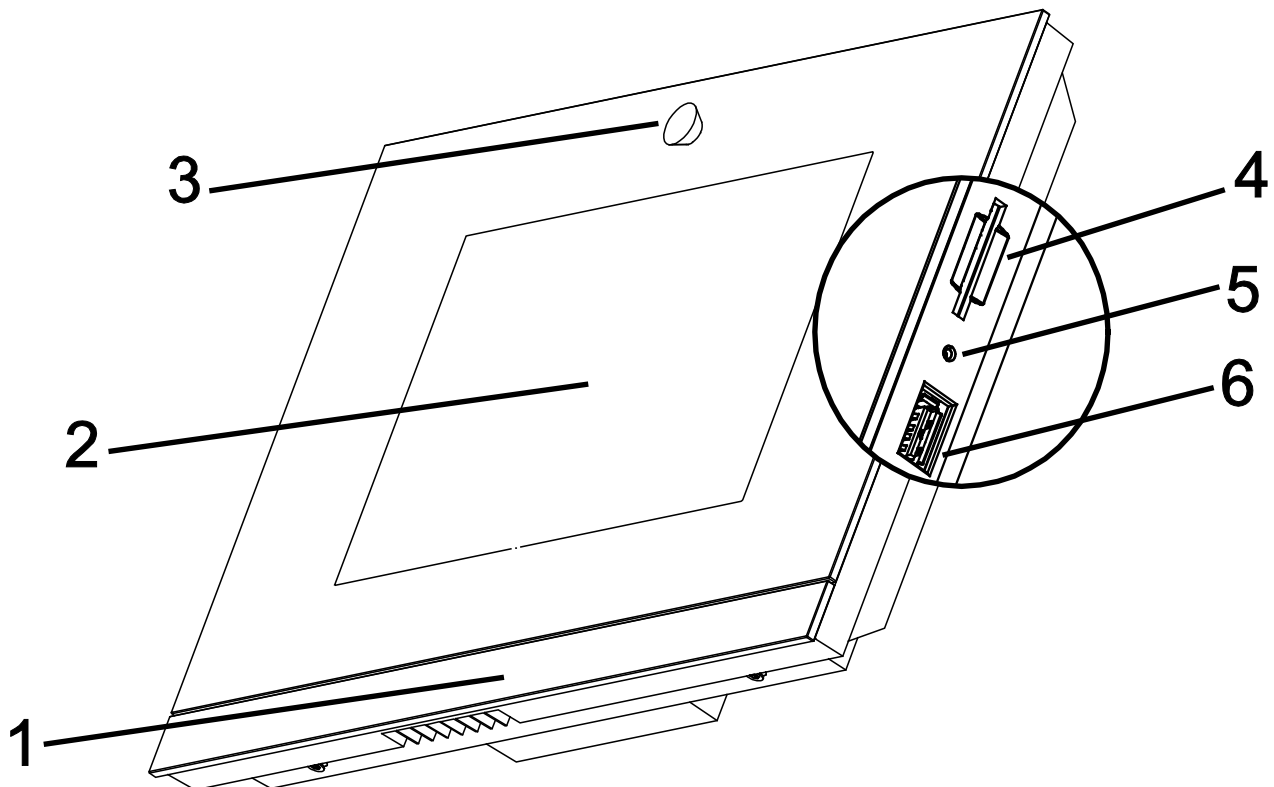

Fig. 1: Overview of devices

1 Design bar | 2 Colour touchdisplay | 3 Camera | 4 Slot for SD card | 5 Reset button | 6 Slot for USB stick



Caution

Risk of damaging the device due to touching!

The USB connection contains many sensitive contacts.

- They must not be touched directly!



Note

Some USB sticks which do not correspond to the general specification may not be recognised.

The **Busch-ComfortTouch**® has a "Audio out" output, via which active loudspeakers can be activated directly.

5 Operation

5.1 Fundamentals

The following pages will guide you through the advantages of the **Busch-ComfortTouch®**. Intuitive operability easily familiarizes you with the versatility of the technical options. The operation distinguishes itself through its clarity and user-friendliness.



Note

However, many functions are available only when the project planning software of the **Busch-ComfortTouch®** has been appropriately activated. Please contact your electrical installer who will set up the **Busch-ComfortTouch®** for you individually and according to your wishes. In the project planning software the scope of available functions is specified. Also consult your specialist electrical dealer.

5.1.1 Colour concept

The **Busch-ComfortTouch®** is equipped with an intelligent, intuitive operating concept. The basis is a consistent colour orientation for a better overview and faster recognition of the control element functions. The functions "Light", "Blinds", "Heating" and "Scenes" are illuminated in colour code (colour code on the operating surfaces) as follows:

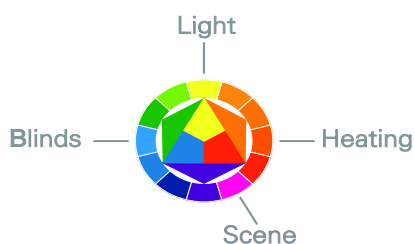
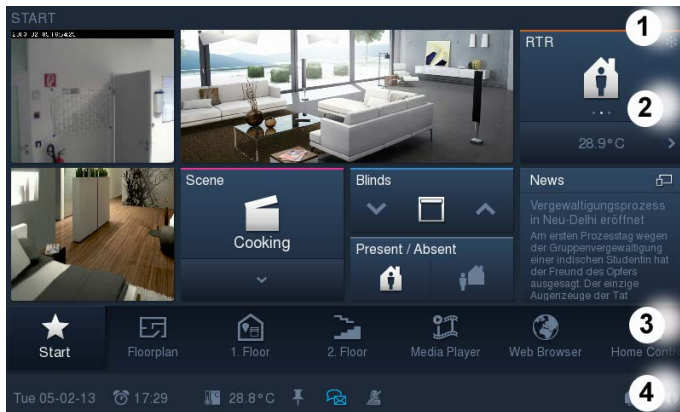

Fig. 2: Colour concept

Colour	Function assignment
Yellow (like the sun)	Light control
Blue (like the sky)	Blind functions
Orange (like warmth)	Climate functions
Magenta (stands for extravagance)	Scenes

5.1.2 Basic setup of the monitor

The functions available in the **Busch-ComfortTouch®** depend on their individual installation. This means that also the display image of the operating page and the naming of the functions vary from **Busch-ComfortTouch®** to **Busch-ComfortTouch®**. However, the basic structure always remains the same.



1 Title | 2 Operating surface | 3 Navigation bar | 4 Status bar

Element	Description
Title (pages, etc.) [1]	Specification of page or directory
Control button (pages) [2]	This is set up individually for you.
Navigation bar [3]	Contains a menu that is tailored to your apartment.
Status bar [4]	Displays information about your Busch-ComfortTouch® with the aid of icons.

5.1.3 Navigation bar

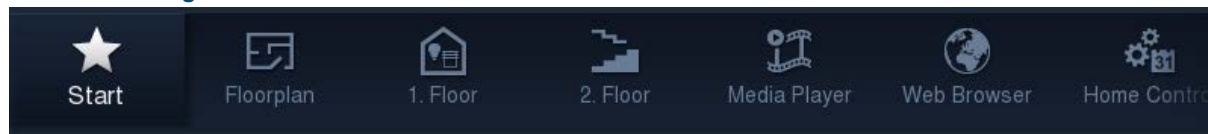

Fig. 3: Navigation bar (example)

The navigation bar is used exclusively for navigation in a **Busch-ComfortTouch®**. An exception are links to the start page, which also provides quick access to certain pages in the navigation bar.

Each operating or application page is represented by an access in the navigation bar. This means that each access on the navigation bar stands for exactly one page. Or conversely, each access to the navigation bar stands for exactly one page. Pressing an access takes you directly to the respective page. Also the functions are activated via the pages. The various accesses can also be bundled topically. Then, after a press, an option opens for calling up operating pages or application pages.

With a swiping motion of the fingers the bar can be moved back and forth. This shows all elements one after the other. Access to the start page is provided on the left edge of the navigation bar.

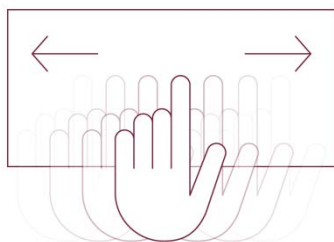

Fig. 4: Moving the navigation bar with swiping motion



Note

The icons for the buttons (accesses) can be selected individually.

5.1.4 Status bar









Fig. 5: Status bar (Example)

The status bar displays information about your **Busch-ComfortTouch®** with the aid of icons. Applications and functions can also be called up and activated directly by pressing the icons.

The following list shows a selection of important icons that can be displayed in the status bar (additional symbols are available).

Icon	Description
So 06.04.08	Displays the current date An option opens when pressing the date. Here the "Date settings" can be selected. Additional date-relevant functions are available for selection depending on the activation. The functions are described in greater detail in section "Explanation of functions".
10:20	Displays the current time An option opens when pressing the time. Here the "Time settings" can be selected. Additional time-relevant functions ("Alarm clock" and "Timer") are available for selection depending on the activation. The functions are described in greater detail in section "Explanation of functions".
 20.0°C	Displays the current room temperature as well as the current operating mode of the local room temperature controller Displays the current room temperature as well as the current operating mode of the local room temperature controller via different icons. With a press on the temperature the local room temperature controller opens. This function is described in greater detail in section "Explanation of functions" -> "Room temperature controller".
1  2 	When you touch the pin [1], you can hold the screen view since your Busch-ComfortTouch® switches to the start screen after the expiry of a time interval. After the activation the icon looks like icon [2].
	Indicates the logged-in user group If the icon does not appear in the status bar, one is logged in as guest.
	The message centre is displayed after pressing this icon All currently received messages are displayed here. Also "Image message" and "Voice message" are available for selection, calls (not accepted), e-mails or system messages. The icon appears brighter as soon as a message is received. After the message is opened in the "Message centre" it is deleted from the overview. Note When a message is received, a notice (with icons) appears via the "Message centre" icon indicating the type of message received.

Icon	Description
	<p>Indicates that the alarm control unit has been activated</p> <p>When pressing the icon, a selection with "Disarm" and "Open alarm control unit" is displayed. This function is described in greater detail in section "Explanation of functions" -> "Alarm control unit".</p>
	<p>Indicates that the alarm control unit has been disarmed</p> <p>When pressing the icon, a selection with "Arm" and "Open alarm control unit" is displayed. This function is described in greater detail in section "Explanation of functions" -> "Alarm control unit".</p>
	<p>Indicates that presence simulation is being played</p> <p>Presence simulation is activated during prolonged absences such as holidays. Your Busch-ComfortTouch® switches the lights and blinds on and off during your absence, to simulate someone's presence in the house. This function is described in greater detail in section "Explanation of functions" -> "Presence simulation".</p>
	<p>Indicates that presence simulation is being recorded</p> <p>During recording by your Busch-ComfortTouch®, presence simulation runs continuously to constantly have up-to-date information available. This is how a typical daily routine is recorded and stored. This function is described in greater detail in section "Explanation of functions" -> "Presence simulation".</p>
	<p>Indicates that the the volume is active (not mute)</p> <p>With a long press of this icon the volume controller is displayed. By shifting the controller you set the volume foe all applications of the Busch-ComfortTouch®. A brief press of this icon switches the volume to mute and the following icon is displayed.</p>
	<p>Indicates that the the volume is mute (not active)</p> <p>A brief press of this icon switches the volume to active and the previous icon is displayed.</p> <p>Note</p> <p>If you set the volume on "Mute", the alarm clock does not generate an alarm tone.</p>

5.2 Operating processes on the touchdisplay

5.2.1 Buttons

Operating surfaces are generally termed buttons, which are frequently used in user operating surfaces. The user can trigger a function by touching the button.

In the **Busch-ComfortTouch®** these are, among others, icons (e.g. in the navigation and status bars), data displays and lettering (e.g. date and time display in the status bar), list entries (e.g. options lists / menus) and graphically highlighted elements.

Examples of buttons in the **Busch-ComfortTouch®**:

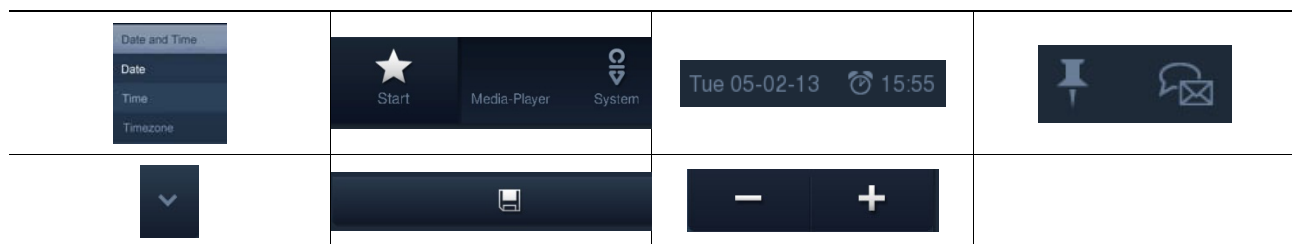

5.2.2 Control elements

Control elements in the **Busch-ComfortTouch®** are used to fulfil the basic functions of "Switching", "Dimming", "Blinds", "Value", "Scenes", RTC and "Measured values". The elements can include switches, buttons and sliders. This makes possible the button mode, (executing the function with one press), the tipping mode (executing the function by pressing and holding), as well as controller mode (moving a slider).

The following selection shows the most commonly used control elements available in the **Busch-ComfortTouch®**. The type and appearance of the control elements may vary due to individual adaptation.



Note

The type and appearance of some control elements has been fixed and cannot be altered (e.g. volume control). However, for some control elements (e.g. light switches) individual formats (also icons) can be selected.

This must be appropriately activated in the project planning software of the **Busch-ComfortTouch®**. Please contact your electrical installer who will set up the **Busch-ComfortTouch®** for you individually and according to your wishes.

Basic structures of control elements

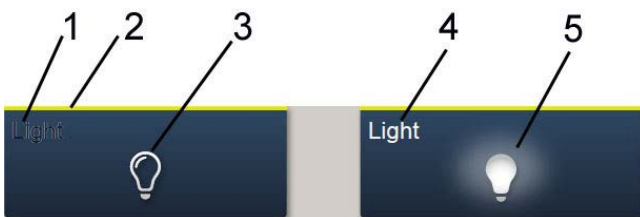

Fig. 6: Different statuses of the same control element

1 Status display of "Device" | **2** Designation of "Control element" | **3** Function button | **4** Status display of "Device" | **5** Function button

Control element	Description
Status display of device [1]	The device is switched off (lettering is dark).
Designation of control element [2]	Light control: Yellow Blind functions: Blue Climate functions: Orange Scenes: Magenta Other functions: Grey
Function button (push-button) [3]	The function is triggered with a press of the button (can also display the status, here: "Device off").
Status display of device [4]	The device is switched on (Lettering: white / bright).
Function button (push-button) [5]	The function is triggered with a press of the button (can also display the status, here: "Device on").

Additional basic principles

Function buttons of dimming control elements can display different stages of dimming by means of alternating icons (e.g. larger light halo around the icon).

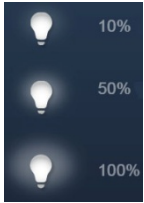

Default settings of steps (e.g. dimming steps, fan speed levels) are shown in white / bright lettering / icons. In the following example the default setting for a dimming step is 20%.



If a selection or setting cannot be made, the colour of the lettering / icons appears dark. In the following example the uppermost setting for dimming has been reached ("100%"). Increased dimming is not possible, and that is why "Plus (+)" and "100%" appear in a dark colour.









Active elements or functions are displayed in white / bright lettering / icons.

Adjustable control elements

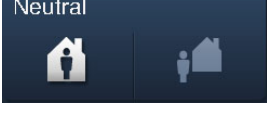
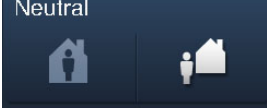

Push-buttons (basic versions, which can be adapted further)

Simple switches can be implemented with push-buttons. This makes light switches or switches for simple switching processes based on push-buttons possible.

Control element	Status	Function
Push-button (Light)		A simple light push-button always transmits the same value when actuated. Its status remains unchanged (e.g. "On").
Switch (Light)	 	A reverser light push-button alternately sends one of two values when actuated and alternates between two statuses (e.g. "On" and "Off").
Push-button (Neutral)		A simple neutral push-button always transmits the same value when actuated. Its status remains unchanged (e.g. "On").
Switch (Neutral)	 	A reverser light push-button alternately sends one of two values when actuated and alternates between two statuses (e.g. "On" and "Off").
Rocker switch (Neutral)	 	A neutral push-button with rocker function when actuated on the right or left side of the rocker sends out a switching telegram. A differentiation is made between whether the rocker is actuated on the left or on the right side. This allows one of two versions to be selected. A neutral push-button with rocker function can be used to call up two different scenes for example (in the example: "Presence" or "Absence").



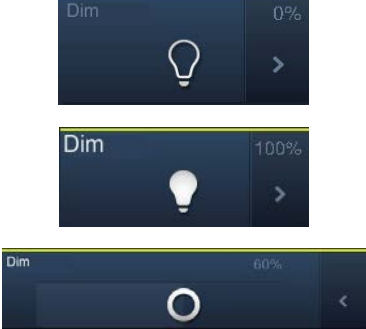

Dimmers (basic versions, which can be adapted further (e.g. with value display))

Dimmers can be used to implement convenient light switches with dimming functions.

Control element	Status	Function
Dimmer without slider		<p>The version <i>Without slider</i> has a push-button for switching on/off in the centre and two buttons left and right for stepwise dimming (brighter/darker).</p>
Dimmer with slider		<p>The version <i>With slider</i> has a push-button for switching on/off on the left side and a slider for dimming. There are two buttons to the left and right of the slider for stepwise dimming.</p>
Dimmers with popup slider		<p>The version <i>Pop-up slider</i> has a push-button for switching on/off on the left side and another button on the right side. The latter opens a slider for dimming. When not actuated the slider closes automatically again after a few seconds.</p>

Blinds (basic versions, which can be adapted further (e.g. with value display))



Blind control elements can be used to implement the activate of blinds, awnings, doors and other motor-driven actuators.

Control element	Status	Function
Blinds / roller shutters	<p>Top</p>  <p>Bottom</p>  <p>Intermediate positions</p>  	<p>The blind control element has push-buttons on the left and right to open or close a blind and, if necessary, an additional button to stop / start in the middle (depending on the operating mode selected).</p> <p>The button in the middle can display the status. An appropriate animation is displayed during the movement.</p> <p><u>Operating procedure:</u></p> <ul style="list-style-type: none"> – Icons for up / down <p>Brief press of the button Movement by one step (the icon in the centre does not change).</p> <p>Long button press Movement up to stop (the icon in the centre changes).</p> <p>Stop When the end stop has been reached or a brief press on icon "Up / Down" (depending on the direction of movement).</p> <p>Change The change of direction of movement with a brief press on icon "UP / Down". Followed by a long press on icon "Up / Down" (depending on the desired direction of movement)</p> <ul style="list-style-type: none"> – Icon in the centre (Blind) <p>Brief press of the button Movement up to stop (the icon in the centre changes).</p> <p>Stop When reaching the end stop or the <u>intermediate position</u> with a brief press on the icon. The icon then indicates the direction to be taken during a renewed movement.</p> <p>If the blind was in the <u>end position</u> (top / bottom), it automatically moves in the other direction (Up / Down).</p> <p>Change The change of direction of movement with a brief press on icon. Followed by a press on icon "Up / Down" (depending on the desired direction of movement). Followed by a renewed press in the icon in the centre.</p>

Scenes / sequences (basic versions, which can be adapted further)

With the "Scene" control element the user can call up so-called scenes or sequences.

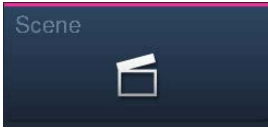

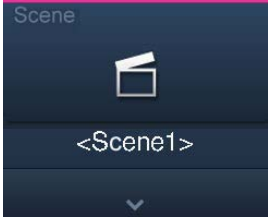
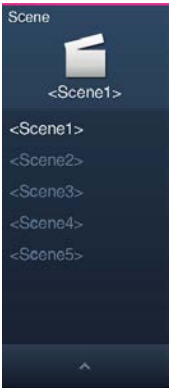
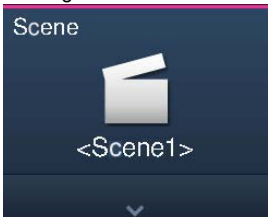

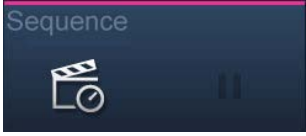
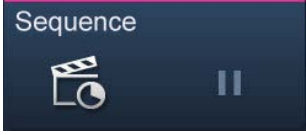
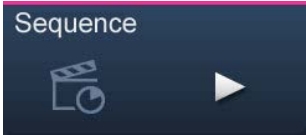

- In "scenes" several actions can be combined into one, so that the user can create, for instance, certain lighting scenes with just one press of the button (= several dimming actions).
- Sequences (processes) are a special form of scenes. Not all grouped actions are started simultaneously in one sequence such as in a scene, but one after the other in a predefined order.

Control element	Status	Function
Scene	<p>Scene can be called up:</p>  <p>Scene is running:</p> 	<p>The "Scene" control element has a push-button for calling up a scene.</p> <p>Changes to the scene are indicated by an icon and can be stored. This is done with a long press of the push-button. A progress bar is displayed. An icon is displayed after the successful storage.</p> <p>Note The scene to be called up must be assigned appropriately in the project planning software of the Busch-ComfortTouch®. Please contact your electrical installer who will set up the Busch-ComfortTouch® for you individually and according to your wishes.</p>
Scene (List)	<p>Scene can be called up:</p>  <p>Scene selection:</p>  <p>Scene is running:</p> 	<p>The "Scene (List)" control element has a pop-up button for calling up a list with different scenes. The list closes automatically after a few seconds if no selection has been made. The scene must be selected in the list. The scene is then started via the push-button. Changes to the scene are indicated by an icon and can be stored. This is done with a long press of the push-button. A progress bar is displayed. An icon is displayed after the successful storage.</p> <p>Note The scenes must be assigned appropriately in the project planning software of the Busch-ComfortTouch®. Please contact your electrical installer who will set up the Busch-ComfortTouch® for you individually and according to your wishes.</p>

Control element	Status	Function
Sequences (Process with influence from the user)	<p data-bbox="344 311 794 340">Scene can be called up:</p>  <p data-bbox="344 501 794 562">Sequence is running (animation on left push-button)</p>  <p data-bbox="344 723 794 846">The sequence was stopped and can be started again with the right push-button (start from the position it was stopped (see right push-button)).</p> 	<p data-bbox="802 311 1441 472">The "Sequences" control element has a push-button on the left and the right. On the left the user can start or stop a sequence. The left button is used to start or pause a sequence. The right button is used to pause and to restart a sequence (the process continuous from the point it was stopped).</p> <p data-bbox="802 479 1441 604">Changes to the sequence are indicated by an icon and can be stored. This is done with a long press of the left push-button. A progress bar is displayed. An icon is displayed after the successful storage.</p> <p data-bbox="802 645 1441 674">Note</p> <p data-bbox="802 680 1441 804">The sequence to be called up must be assigned appropriately in the project planning software of the Busch-ComfortTouch®. Please contact your electrical installer who will set up the Busch-ComfortTouch® for you individually and according to your wishes.</p>

Step switches (basic versions, which can be adapted further)

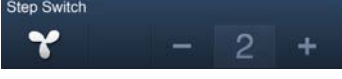
You can implement switch sequences with step switches. A step switch effectively combines several push-buttons into one control element.

Control element	Status	Function
Step switch without step display	<p>Device is off:</p>  <p>Device on and adjustable (as soon as the upper setting limit has been reached, the right icon appears dark (in this example:))</p> 	<p>The version without step display (and without slider) has two buttons left and right for calling up the next or previous step and a button in the centre. By pressing the right / left button a few times one reaches the next higher or lower step. The button in the middle returns the step switch to the bottom step (= "Off"). The icon in the middle can be animated during adjusting.</p>
Step switch with step display	<p>Device is off:</p>  <p>Device on and adjustable (adjustment only with buttons -> slider only displays):</p>   	<p>The version with step display (with slider) has a button to reset the step switch (= off) and buttons to call up the next or previous step. In addition, it uses a slider to show which step is currently on. The slider cannot be operated. The icon in the middle can be animated during adjusting.</p>

Value display elements / value sending elements (basic versions, which can be adapted further)

- With value display elements, values are displayed as text or graphical information in a page of the **Busch-ComfortTouch®**. They are not operable, but are used to display values only.
- With value sending elements, you can display values in different formats in a **Busch-ComfortTouch®** page and send them to other devices.

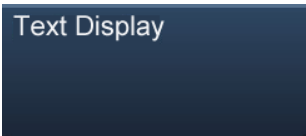
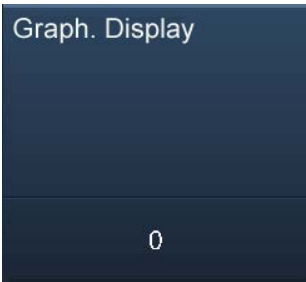
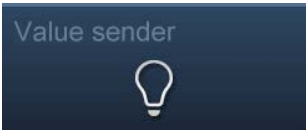
Control element	Status	Function
Text display element		<p>The "Text display" version can display values and texts that are sent, for instance, from a temperature sensor.</p> <p>There are no direct control elements here!</p>
Graphic display element		<p>The "Graphics display" version can display values graphically, which are sent from a temperature sensor, for example. The values are also displayed as a number. For the graphic display element you can choose between a wind rose and a dial-type gauge. This must have been appropriately assigned in the project planning software of the Busch-ComfortTouch®. Please contact your electrical installer who will set up the Busch-ComfortTouch® for you individually and according to your wishes.</p> <p>There are no direct control elements here!</p>
Value sending element		<p>With value sending elements, you can display values in different formats (see above) in a Busch-ComfortTouch® page and send them to other devices.</p> <p>There are no direct control elements here!</p>

Room temperature controller (basic versions, which can be adapted further)

Climate control units can be controlled with the control element for room temperature controllers. Because such devices have many functions, the control element displays only a small excerpt. That is why another window can be opened in the **Busch-ComfortTouch®** via the control element that displays all functions and information about the room temperature controller.



Note

The internal room temperature controller of the **Busch-ComfortTouch®** is not opened via this control element (see room temperature controller).

Control element	Status	Function
Room temperature controller		The "RTC" (room temperature controller) version has a push-button for opening an additional window. The button also displays the current temperature, which the controller regulates. The current operating mode and the mode (e.g. "Heating") of the controller are displayed in the top part of the control element.

Miele control elements (basic versions, which can be adapted further)

With the Miele control element you have the option of transferring information and data about kitchen appliances from Miele to the **Busch-ComfortTouch®** and to call this information up there. It is also possible to remotely control certain appliance functions with the **Busch-ComfortTouch®** and to implement these for KNX devices. This function is an option and only available with a corresponding plug-in. More detailed information is available from your electrical installer.

Links in the floor plan

Links in the floor plan are used to jump to individual operating pages from the start page.

Control element	Status	Function
Links: – Pages – Room view – Web (Internet site) – Camera – News centre	Some forms are possible. They must be created appropriately in the project planning software of the Busch-ComfortTouch® . Please contact your electrical installer who will set up the Busch-ComfortTouch® for you individually and according to your wishes.	The control element of the link can be selected within the field. This opens the operating page which was linked. Note The operating page to be linked must have been appropriately assigned in the project planning software of the Busch-ComfortTouch® . Please contact your electrical installer who will set up the Busch-ComfortTouch® for you individually and according to your wishes.

Special forms, bubble display

For the room view most control elements can also be used as "Bubble display". Operation is then similar to that described above.



Non-adaptable control elements

These are control elements that are fixed according to the system and therefore cannot be adapted.

Volume control

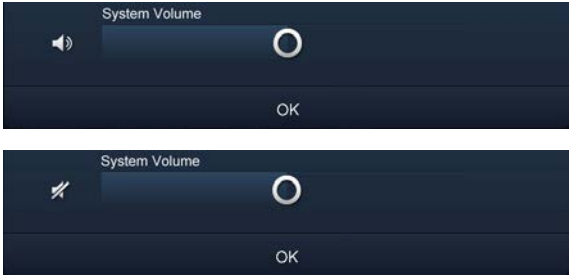
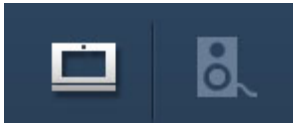
Control element	Status	Function
<p>The controller for the "System volume" is opened via the status bar of the start page. Controllers for "Applications" are each opened via the status bar of the application page. These always contain also the controllers for the system volume.</p>	<p>Example: System volume</p>  <p>Special case "Media volume": With this it can be selected whether the setting refers to the Busch-ComfortTouch® and / or to connected loudspeakers / devices.</p> 	<p>The controller for the volume appears with a long press on the loudspeaker icon in the status bar. The volume is adjusted by moving the slider.</p> <p>With a brief press on the loudspeaker icon on the controller the respective volume can be set on mute. The volume can be activated again in reverse.</p>

5.2.3 Entries

Appropriate entry options are always offered in the **Busch-ComfortTouch®** when entries have to be made for the execution of functions.

Examples for entry options in the **Busch-ComfortTouch®**:



5.2.4 Swiping motions (scrolling)

Scrolling is carried out with swiping motions of the fingers on the touchdisplay. This allows the navigation bar to be shifted to the left or right so that all elements become accessible.

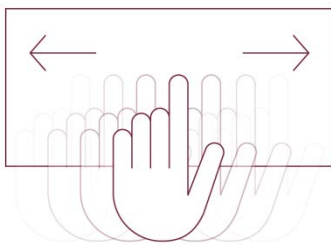

Fig. 7: Moving the navigation bar with swiping motion

5.3 Explanation of functions

5.3.1 Page types

The functions are called up and executed via the start page and the operating and application pages. These types of pages are briefly explained in the following.

- Start page:

The **Busch-ComfortTouch®** includes a start page (welcome page), which is displayed to the user after a certain time interval or after returning from the screensaver. It thus represents the "face" of the **Busch-ComfortTouch®** and serves as an orientation point. The start page is the starting point of any navigation. Access to the start page is always provided on the left side of the navigation bar.

The start page of the **Busch-ComfortTouch®** plays another important role:

Here functions that are especially useful for the user can be positioned. You can, for instance, add (additional) room lights and blinds to the start page in which the **Busch-ComfortTouch®** is located. The user then has direct access to these functions. To integrate such functions of building control into the start page, control elements must be positioned there. Alternatively, the start page can be used to create a second navigation option for such pages that involve functions of an individual room. For this, up to six floor plan graphics of a living room with appropriate links can be integrated into the start page. Please contact your electrical installer who will set up the **Busch-ComfortTouch®** for you individually and according to your wishes.

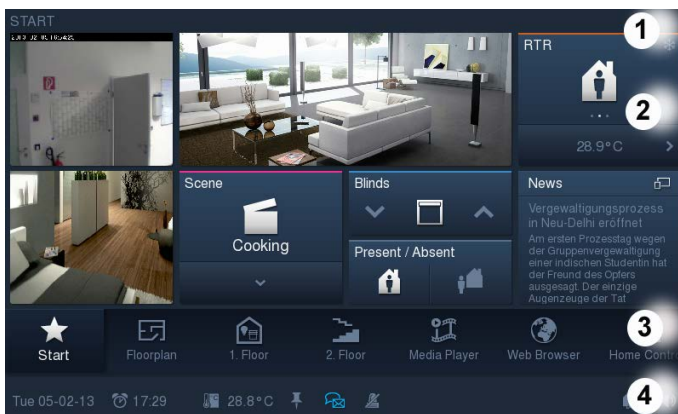

- Operating pages:

Operating pages can be freely configured via the project planning software of the **Busch-ComfortTouch®** and are used to provide building control functions (lights, blinds, room temperature controller, etc.). You can, for instance, operate all the blinds on the one operating page and all the home lights on the next. You could also use the operating page for all the functions of one room and the next page for all functions of the next. The type of structuring you wish to use is left to you. Please contact your electrical installer who will set up the **Busch-ComfortTouch®** for you individually and according to your wishes.

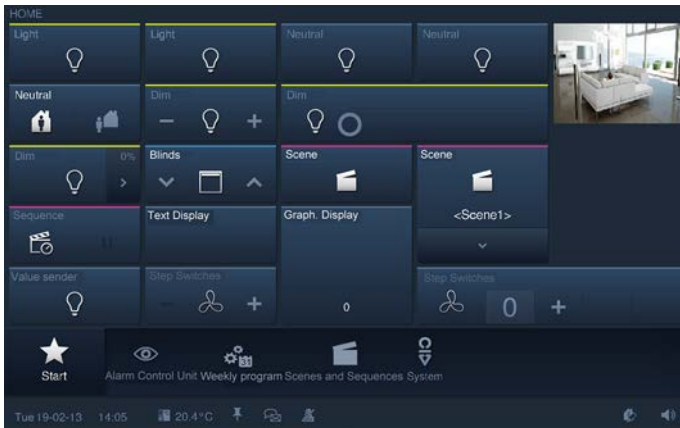

- Application pages:

The **Busch-ComfortTouch®** can be equipped with a range of applications (e.g. calendar, Media Player, etc.). For this the application pages are inserted into the **Busch-ComfortTouch®** via its project planning software. Please contact your electrical installer who will set up the **Busch-ComfortTouch®** for you individually and according to your wishes. Each application page has access in the navigation bar.

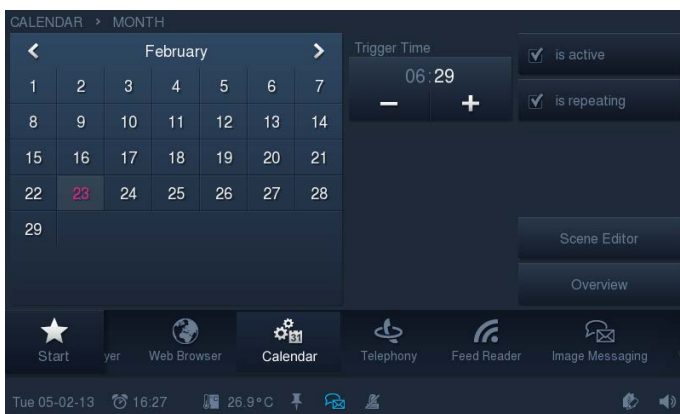

Note

The page types can contain buttons, control elements as well as input options. The basic operation is explained in section "Control processes at the touchdisplay".

5.3.2 Basic functions of switching, dimming, blinds, value, scenes, RTC and measured values

The basic functions are carried out via the operating page with the aid of control elements. These control elements are described in detail in section "Control processes at the touchdisplay" -> "Control elements".

5.3.3 Media Player

The Media Player serves for the playback of audio and video data, as well as Internet radio streams and Internet TV streams.



Note

Both MP3 music data and films with MPEG2 code can be replayed directly, unless they are copy protected by DRM (Digital Rights Management).

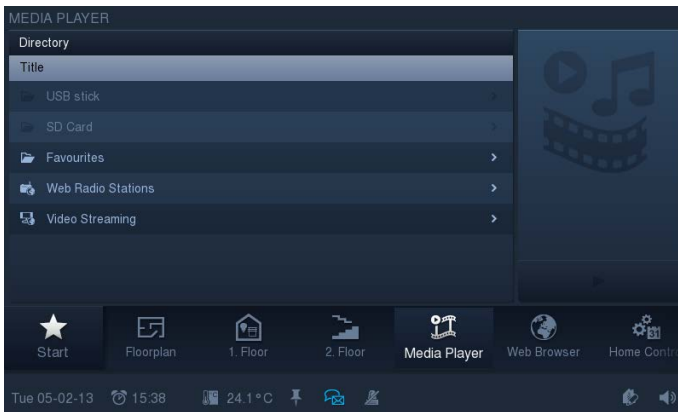

Press the "Media Player" icon in the navigation bar to access the Media Player.

Via the directory you can select whether you wish to read in audio or video data via USB stick or SD card. Here you can also open the lists of the Web radio stations and Web TV.

An example of how to start a radio station is shown in the following. An entry must be selected in the options list on the left side. Only then can the play button on the right-hand side be activated. The replay starts immediately.

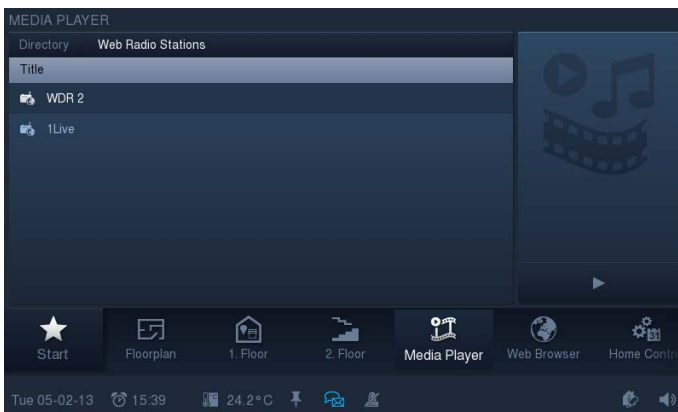

Operation during the replay of audio and video files

An operating bar appears during the replay:

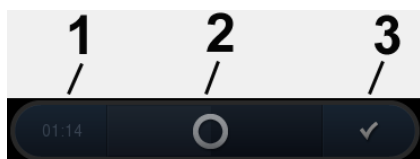

- 1 Expired time | 2 Slider for "Forward" and "Back" |
3 Opening the second view "Operating bar" (see the following figure)



- 4 Expired time | 5 Pause (during "Pause" the icon "Start ►) appears | 6 Stop | 7 Volume control opens

The replay can be terminated anytime via the cross in the top right-hand corner.

Additional details about the Web radio and Web TV

Audio can be provided by the integrated speaker or in stereo via the "Audio out" output with a connection to an external sound system or active speakers.

- Up to ten streams each can be set via the project planning software of the **Busch-ComfortTouch®**.
- The image can be displayed in reduced size at the upper left or in full-screen mode.



Note

The quality of the full-screen display depends on the image size of the stream being broadcast.



Note

Via the Web interface there is the option of making settings independently on the **Busch-ComfortTouch®**. Practical adjustments in the **Busch-ComfortTouch®** are, for example, station adaptation for streaming(Web) TV and Web radio. It is activated via the project planning software of the **Busch-ComfortTouch®**. Please see your electrical installer. He will also explain the operation to you.

5.3.4 Image messaging

The "Image messaging" function serves for recording and displaying notes. This enables user to leave image messages for other user on the **Busch-ComfortTouch®**. An image message is a handwritten text message or drawing created with the stylus pen or a finger on the display.

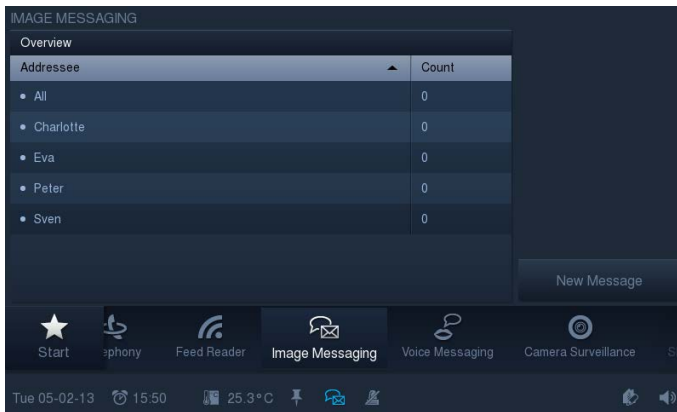

Press the "Image messaging" icon in the navigation bar to access the function.

1. Press "New message" to record a new image message.

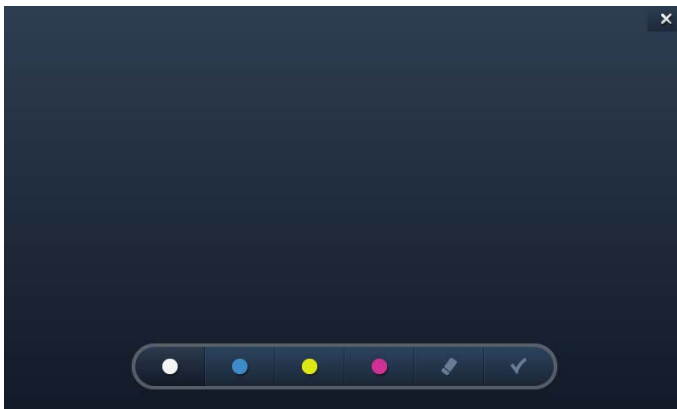

2. Use the operating bar for the selection of the tasks.



- 1 Selecting the line colour | 2 Deleting the previously created text stroke | 3 Confirm and open the next view

Leave a handwritten message for members of you family and others



Note

It is best to use the stylus pen.



3. Select the receiver of the message by inserting a tick.

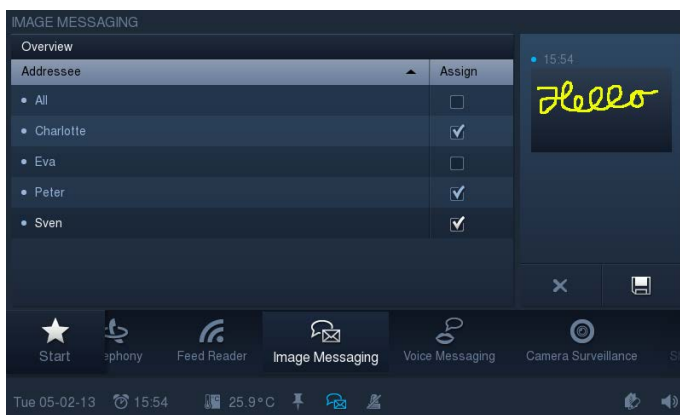

4. Press "Save".

An icon appears in the status bar which indicates that a new message has arrived.



Reading a handwritten message

5. To read the message, touch the icon in the status bar.



The message centre opens.

6. Here select the image message.

The message is displayed in full-page mode. The dark blue dot signals a new message.

7. Close the message by clicking the cross in the right-hand top corner.

A list of all available messages is displayed. News that has been read is marked with a light blue dot. All the messages can be selected and read again. The messages can also be deleted here. To do this, touch the following icon:



Cross icons appear next to the messages. A message is deleted by touching it.



Note

The list of all available messages for a receiver can be called up at any time via the "Image messaging" function. Just select the respective receiver.

5.3.5 Voice messages

The "Voice messages" function serves for recording and playback of voice messages. They are recorded with the integrated microphone and can therefore be played back later.

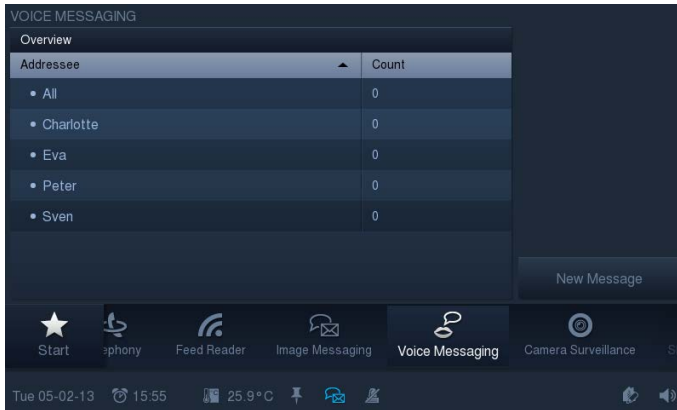

1. Press the "Voice messages" icon in the navigation bar to access the function.
2. Press "New message" to record a new voice message.

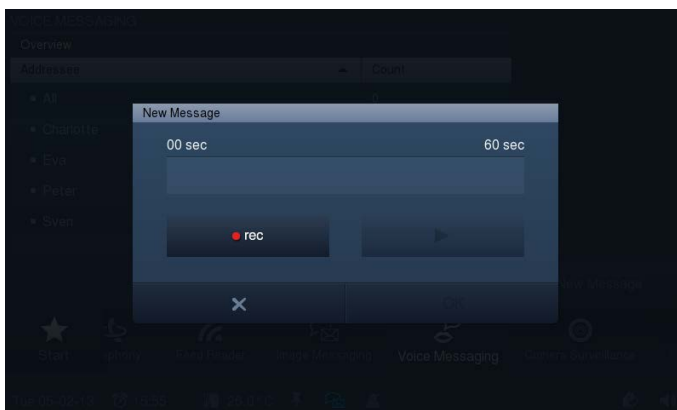

3. Now select "rec" (red dot) and speak into the integrated microphone. If you are finished inside a period of 60 seconds, press "OK". Otherwise the recording is automatically terminated after 60 seconds.
4. You can interrupt and restart the recording at any time by again pressing "rec" (white square) and then selecting "Start" (▶).

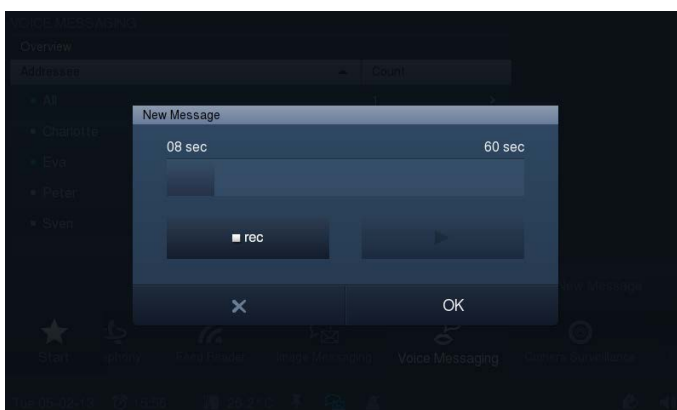

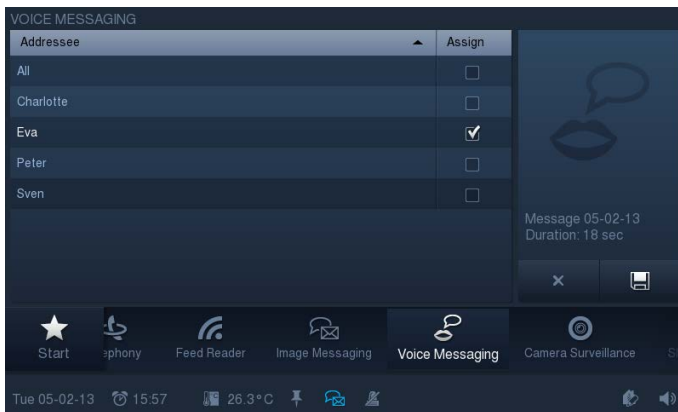

5. Select the receiver of the message by inserting a tick.
6. Then press "Save".

An icon appears in the status bar which indicates that a new message has arrived.



7. To listen to a message, press the icon in the status bar. The message centre opens. Select the voice message here.

The message is displayed in full-page mode and can be played back. The dark blue dot signals a new message.

8. Close the message by clicking the cross in the right-hand top corner.

A list of all available messages is displayed. Messages that have been heard are marked with a light blue dot. All the messages can be selected and replayed again. The messages can also be deleted here. To do this, touch the following icon:



Cross icons appear next to the messages. If they are touched, the message is deleted.



Note

The list of all available messages for a receiver can be called up at any time via the "Voice message" function. Just select the respective receiver.

5.3.6 E-mail

E-mails can be displayed without the need for a separate computer. E-mails can be easily answered via a graphic or voice message.

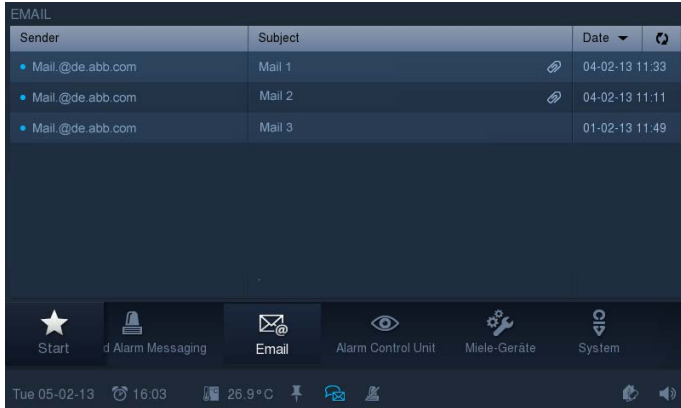

1. Press the "E-mail" icon in the navigation bar to access the function.

The list of e-mails received with a blue dot indicates new ones that have not yet been read. E-mails that have been read are marked with a light blue dot.

2. Press an entry to open the e-mail.

An update of the PO box can be made via the following icon.



An icon appears in the status bar which indicates that a new e-mail has arrived.

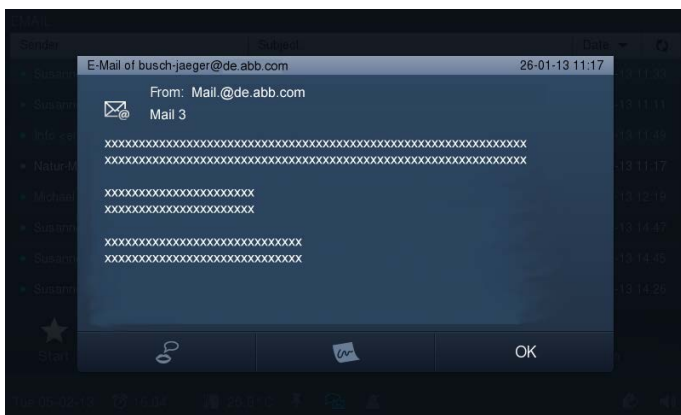

3. Press an entry to open the e-mail.
4. Answer e-mails direct via voice or image messages.

5. Touch the respective icon in the bottom bar. The functions "Image message" or "Voice messages" are opened (see sections "Image message" or "Voice message"). The receivers are selected automatically.



Note

E-mails cannot be deleted in the **Busch-ComfortTouch®**!

5.3.7 Feed Reader

With the Feed Reader you can display and read up to ten "News feeds" in compact form directly on the **Busch-ComfortTouch®**. This is, for example, current news, weather information, traffic information, etc.

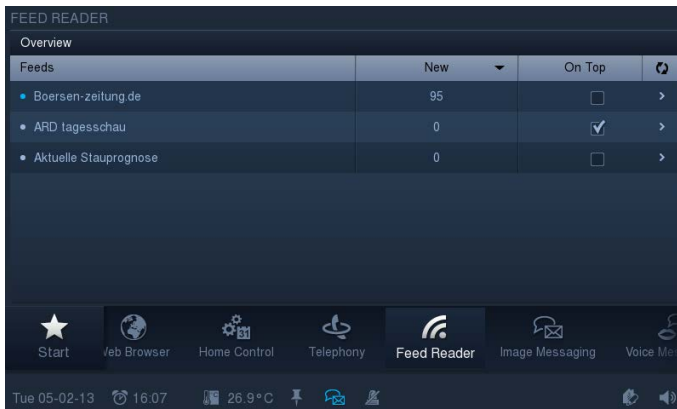

1. Press the "Feed Reader" icon in the navigation bar to access the function.

The list shows the Feeds (news services) that have been previously specified via the project planning software of the **Busch-ComfortTouch®**. Please see your electrical installer. A blue dot shows that the latest news has arrived at the Feeds. Otherwise the dot remains light blue. An update can be made via the following icon.



An icon appears in the status bar which indicates that news has arrived.



Note

The project planning software can also be used to specify whether Feeds are displayed as news feeds on the start page. The ones that are to be displayed can be selected in the overview (by setting a tick at "On start page"). The news is opened in the Web browser by pressing on an entry.

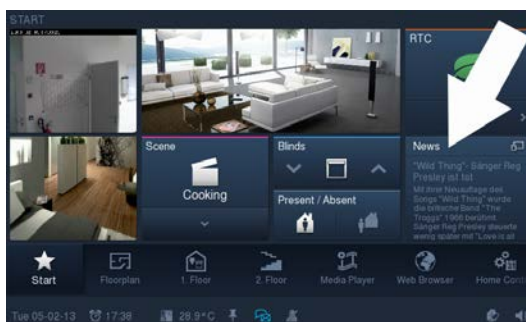



2. Press an entry to open the Feed.

The list of news received with a blue dot indicates new ones that have not yet been read. News that has been read is marked with a light blue dot. The news is opened in the Web browser by pressing on an entry.



Note

Via the Web interface there is the option of making settings independently on the **Busch-ComfortTouch®**. Practical changes in the **Busch-ComfortTouch®** are, for example, adjustments of the news services (Feeds) for the Feed Reader. It is activated via the project planning software of the **Busch-ComfortTouch®**. Please see your electrical installer. He will also explain the operation to you.

5.3.8 Weekly programs

Processes occurring on a weekly basis (scenes and sequences) can be set for each weekday in a clearly arranged way and automated in any number of weekly programs. These default settings will then be repeated continuously each week. The weekly programs are created via the project planning software of the **Busch-ComfortTouch®**. Please see your electrical installer. The compiling or adjusting on the **Busch-ComfortTouch®** can then be carried out by the user. Validity intervals (e.g. holidays) can be assigned to weekly programs, during which the preset weekly program is not triggered but the program of a specially defined day. This could be days such as Xmas, Sylvester or New Year. In this way weekly programs can be automatically activated and deactivated. A maximum of 8 periods of validity can be defined.

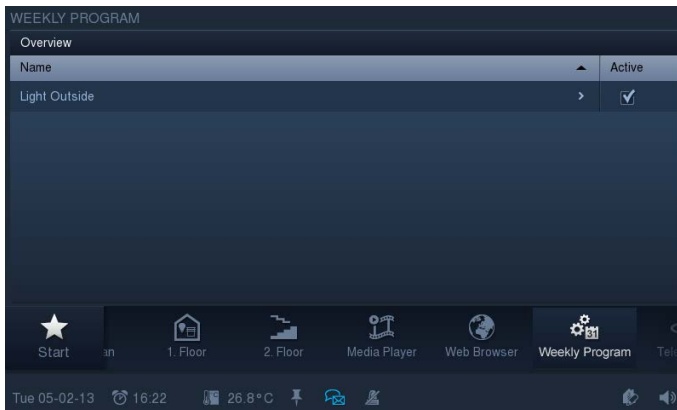

1. Press the "Weekly program" icon in the navigation bar to access the function.

The function can also be opened by pressing the date in the status bar.

The overview displays existing weekly programs. The program can be activated / deactivated by setting a tick.

2. To access the overview of scenes that have been assigned to the weekly program, press an entry (weekly program) in the overview list.

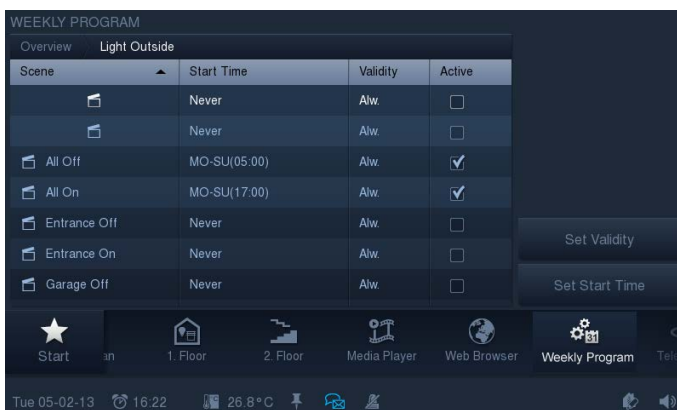

The overview displays the scenes that can be played in the weekly program (e.g. sequentially or simultaneously for different devices). The scene can be activated / deactivated by inserting a tick. Additionally, the statuses of the validity intervals and start times are displayed.

3. Select an entry (scene) to edit it.

The validity intervals can be specified via "Set validity".

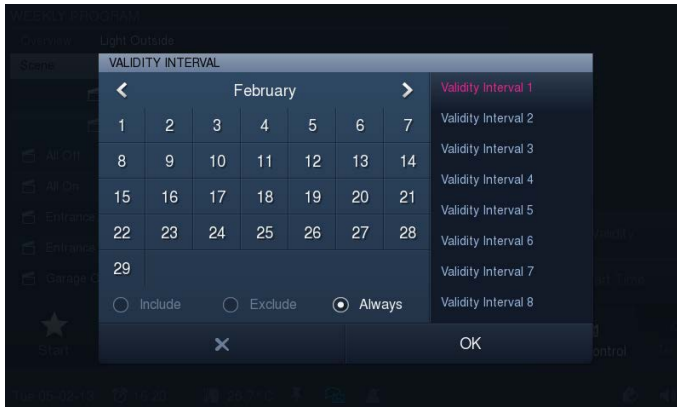

The months can be selected with the arrows.

4. Select a validity interval on the right-hand side.
5. Select the day(s) in the calendar.
6. Also specify the characteristics of the intervals.

Interval characteristics	Description
Always	The weekly program is continuous: there is no assignment to an interval.
Include	Within the marked days: The weekly program runs only within the marked days.
Exclude	Outside the marked days: The weekly program is suspended during the marked days.

7. Press "OK".

You return to the overview of scenes.

8. Adjust the start times via "Set start time".

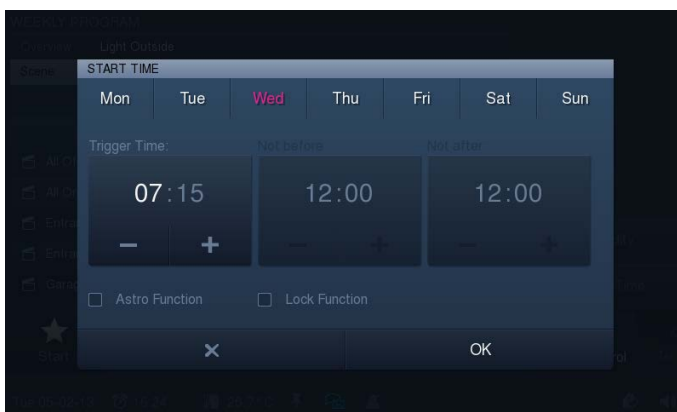

9. Select the day(s) in the upper bar.

10. Set the start time.

By setting a tick you can also specify whether the Astro function is to be activated. The Astro function can, for example, be used to automatically raise or lower blinds a few minutes earlier or later each day in dependence of the annual season. A lock function with "Not before" and "Not after" allows the set times to be adjusted to the Astro function. For this, a tick must have been set in the lock function.

11. Touch the "Hours" or "Minutes".

The setting is made via -/+.

12. Press "OK".

You return to the overview of scenes.

5.3.9 Calendar (twelve-month timer)

Via the calendar function you can specify times on certain days of the year when special scenes are triggered. These default settings can be repeated annually.

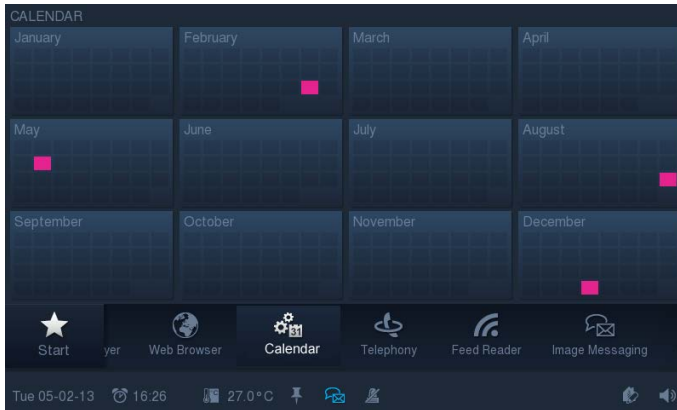

1. Press the "Calendar" icon in the navigation bar to access the function.

The overview by means of coloured boxes shows the days that have been specified.

2. If you wish to specify additional days, or you wish to change specifications, touch a month.

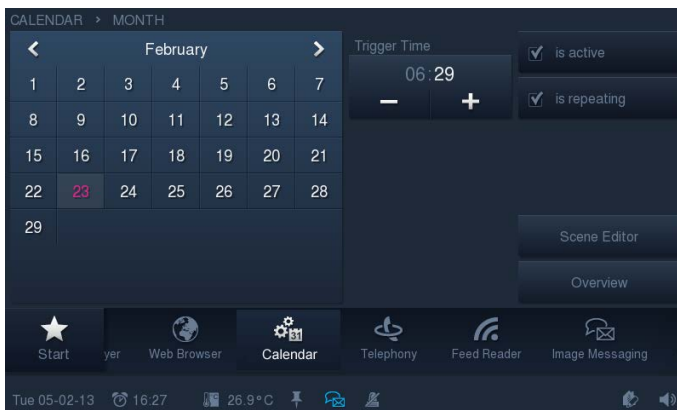

3. Touch one or several days in the calendar.

They are highlighted in colour. For these days special scenes can be specified via the scene editor (see "Scene editor"). Additionally, the time of the day at which the scene is to start can be specified via "Start time" (-/+). By setting a tick you can also specify whether a repeat is to take place each year.

4. Activate the specification by setting a tick.

5.3.10 Miele (only via Plug-In)



Note

A link to certain Miele appliances can be established with aid of this function. This function is only available with the aid of a special plug-in. Please see your electrical installer. A separate description is available for this function.

5.3.11 Camera surveillance

Camera surveillance provides fast, visual information about events occurring within the detection range of connected cameras. The surveillance cameras can be triggered and the transmission signal displayed. The application can be used to display the images from up to eight (with the 9" display) or ten (with the 12,1" display) network cameras (also internal camera modules) or other **Busch-ComfortTouch®** cameras.

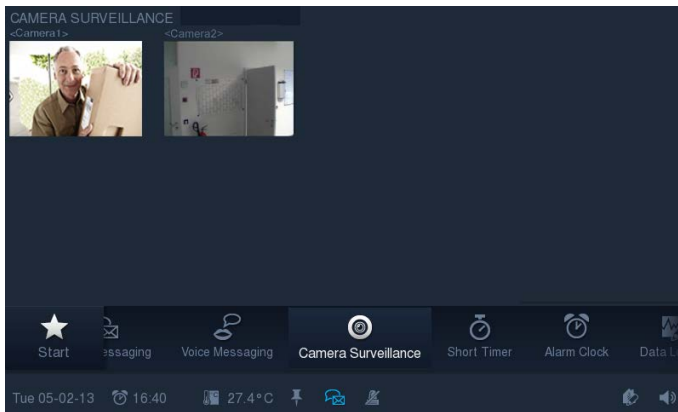

1. Press the "Camera surveillance" icon in the navigation bar to access the function.

The overview displays the current images of the available cameras in small image form. With a double press on a small image the full-page mode is opened for the respective camera image.

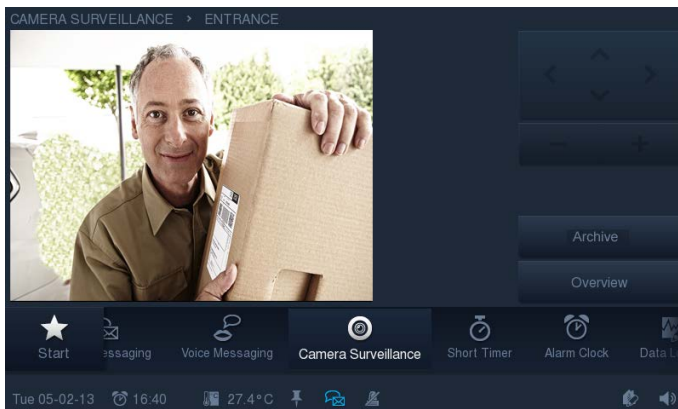

2. Depending on the type of camera, you can control the camera or reduce or enlarge the size of the camera image.

Archived camera images can be called up via the archive.



Note

The project planning software can also be used to specify whether camera surveillance is displayed as a small window at the start page. The current camera image is the displayed permanently. With a press on this window the "Camera surveillance" function opens.



5.3.12 Alarm control unit

The **Busch-ComfortTouch®** can monitor message circuits / contacts and display their status. This enables the panel to monitor the security of the building and, if necessary, to transmit messages about unauthorized access. For this purpose, movement detectors, glass break sensors, window sensors and further contacts can be integrated.



Note

The alarm control unit is not intended to serve as a VDS-certified (German Association of Property Insurers) alarm system but to merely offer the option of monitoring windows, doors or interior rooms via movement detectors. It is no substitute for an alarm system.

The status of the alarm control unit is shown in the status bar. This function is opened by pressing the icons. The function can also be called up via the navigation bar.



This icon indicates that the alarm control unit has been armed. When pressing the icon, a selection with "Disarm" and "Open alarm control unit" is displayed.



This icon indicates that the alarm control unit has been disarmed. When pressing the icon, a selection with "Arm" and "Open alarm control unit" is displayed.

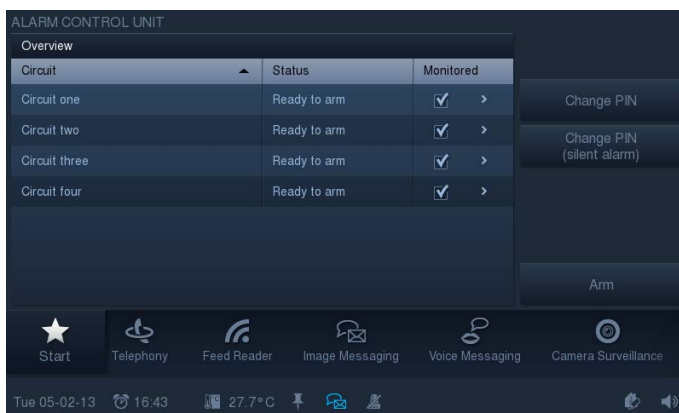

The overview displays the available message circuits. By setting a tick under "Monitored" you can specify the message circuits are armed when setting the alarm. The access code is required when setting the alarm. This can be entered via the numbers keyboard which appears. The access code can also be changed (first the request for the old access code -> "OK" -> then new entry -> "OK").

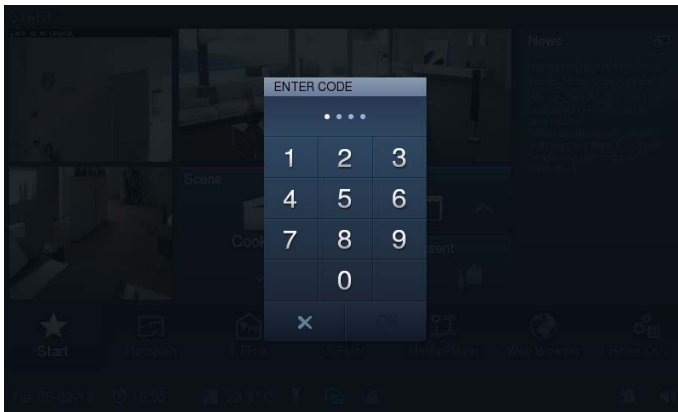

The sensors (e.g. movement detectors) contained in the message circuits can be seen by touching the entry. The individual sensors can be activated / deactivated by setting a tick under "Monitored". With the aid of "Ignore" it can be specified that an alarm can be set in spite of an existing message. By touching the lettering "Overview" you return to the previous view.

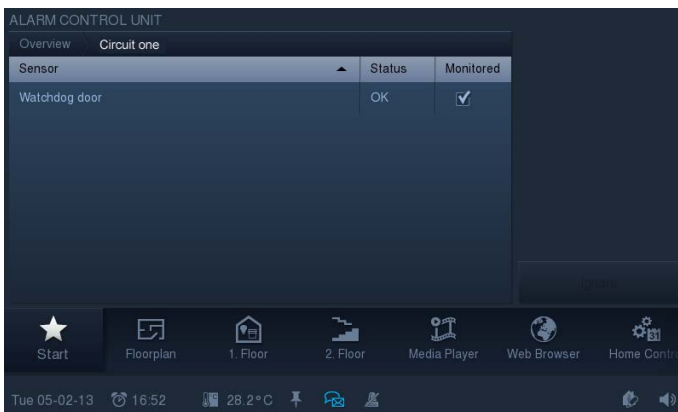

5.3.13 Presence simulation

The absence of the resident of the building can be realistically simulated to a great extent via the **Busch-ComfortTouch®**, for increasing the protection against unauthorised access.

The **Busch-ComfortTouch®** records (weekday-specific) up to 20 objects of all actions precisely to the minute and then plays these back.



Note

This function does not have a direct application page. It is deactivated / activated via the status bar with the following icons:



Please note that you must always create a presence simulation beforehand, so that the simulation can be played back later!

1. Open the function by pressing the icons shown above .

Additional text windows are then displayed.



2. Press "Record scene", to record a presence simulation.

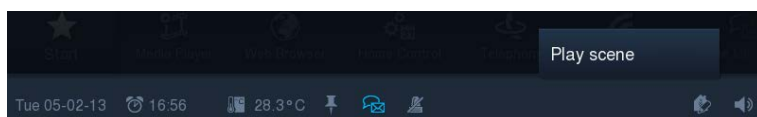

3. Press "Play back scene", to play back the presence simulation recorded.

The status of the presence simulation is displayed in the status bar.



This icon indicates that presence simulation **is being recorded**. During recording by your **Busch-ComfortTouch®**, presence simulation runs continuously to constantly have up-to-date information available. This is how a typical daily routine is recorded and stored.



This icon indicates that presence simulation **is being recorded**. Presence simulation is activated during prolonged absences such as holidays. Your **Busch-ComfortTouch®** switches the light and blinds on and off during your absence, for example, to simulate someone's presence in the house.

5.3.14 Short-time timer

Up to five different short-time timers ("Egg-timers") can be activated on the **Busch-ComfortTouch®**. A tone sequence can be set after the time has expired. There is also the additional option of running an automated scene at the start and/or end of a short-time timer.

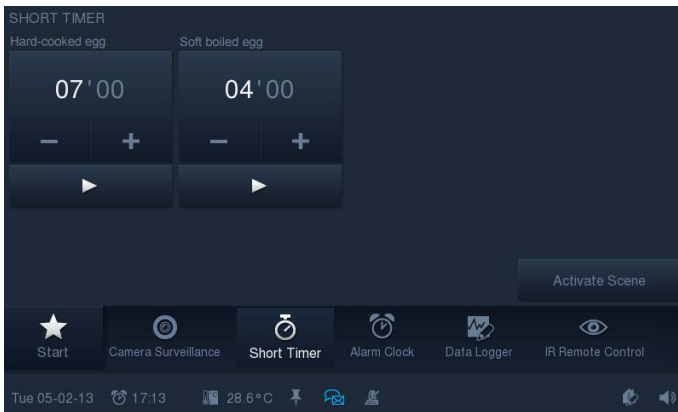

1. Press the "Short timer" icon in the navigation bar to access the function.

The overview displays the available shot-time timers. Here the timers can be set.

2. Touch the hours or minutes.

The setting is made via -/+.

3. Start the time sequence with the "Start button" (▶).

This can be stopped at any time with the "Stop button" (■). Via "Activate scene" you can activate scenes that have been assigned to the timers.

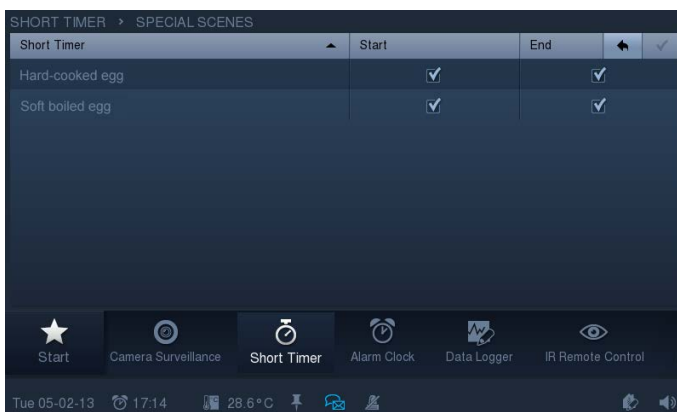

4. Set a tick to specify whether the assigned special scene is to be played at the start and/or at the end (for adjustment of scenes see "Scene editor").

5. Confirm the changes by touching the tick in the right-hand top corner.

Via the arrow in the top bar you again return to the overview.



Note

At the end of the running time, a message appears which must be confirmed.

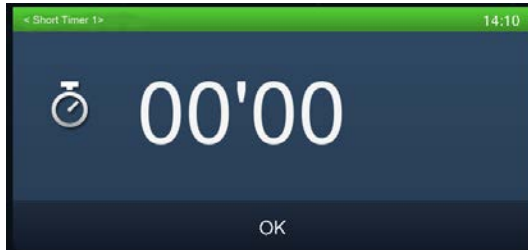

5.3.15 Alarm clock

Specific weekday times can be set for activating a specific scene for waking up (e.g. starting the Media Player with one's favourite music).

It is also possible to set a scene to precede the alarm, to prepare the home environment for its occupants prior to rising (the heating, for example, is switched on already one hour before to the alarm clock).

This allows a scene or a sequence to be started for the lead-in time (specific time set before alarm time), for alarm time, at activation of "Snooze" and switching off the alarm clock.

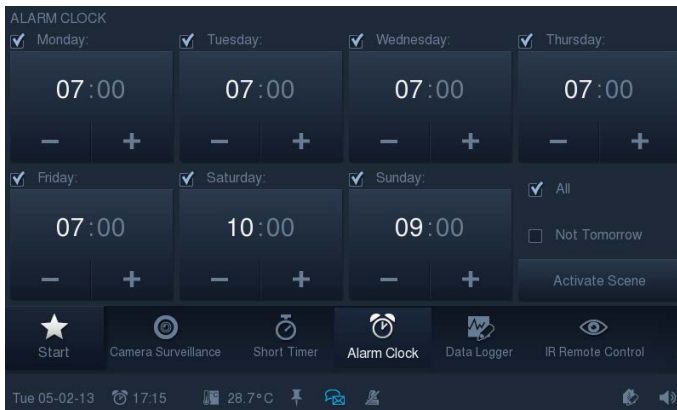

1. Press the "Alarm clock" icon in the navigation bar to access the function.

The overview displays the available alarm clock for each weekday. Here the alarm clock can be set individually.

2. Touch the "Hours" or "Minutes".

The setting is made via -/+ . It is activated by setting a tick next to the weekday. You can set a tick on "All" to activate all days. If you do not wish to be woken the next day, set a tick at "Not tomorrow".

3. Activate the the scenes assigned to the alarm clocks with "Activate scene".



4. Set a tick to specify whether the assigned special scene is to be played for Wake-up, "Off", "Snooze" or "Lead-in" (for adjustment of scenes see "Scene editor"). The lead-in time can be set individually.
5. Touch the "Hours" or "Minutes".

The setting is made via -/+.

6. Confirm the changes by pressing "Save".

Via the arrow next to "Save" you again access the overview.



Note

After the alarm clock has been activated, the alarm clock icon appears in the status bar. Here all the time settings can be called up again.

5.3.16 Data logger

The data logger integrated in the **Busch-ComfortTouch®** can graphically display data for up to eight communication objects. If these communication objects with sensors are linked via group addresses, then the energy consumption of a house, the power of a photovoltaic system or the fill level of an oil tank can be visualised, for example.

The **Busch-ComfortTouch®** can store the values as file in a specified directory to allow the determined values to be further processed. The following storage media can be used:

- SD Card
- USB stick
- Network



1. Press the "Data logger" icon in the navigation bar to access the function.

If several views are available, they are listed on the right side. The respective view opens when an entry is touched. The values can be reset via "Reset". With the aid of "Export" the data of the specified directory are exported.

5.3.17 Web browser





Also Internet sites can be called up and displayed in full-screen mode with the integrated Web browser of the **Busch-ComfortTouch®**. Predefined Internet sites can be called up on the **Busch-ComfortTouch®**. For this, up to 20 bookmarks for Internet sites can be stored in the project planning software for the **Busch-ComfortTouch®**.

When the Web browser starts, a list of all stored bookmarks are displayed. This list can be selected at any time. When the user selects an Internet site, it opens.

1. Press the "Web browser" icon in the navigation bar to access the function.

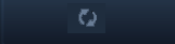

The buttons have the following functions:

Button	Function
	One page back.
	One page forward.
	Call-up of the "Bookmark" list.
	Scaling.
	Quitting the loading process (also a progress bar appears during the loading process).
	Update.

2. Close the Web browser by clicking the cross in the right-hand top corner.



Note

Via the Web interface there is the option of making settings independently on the **Busch-ComfortTouch®**. Practical changes in the **Busch-ComfortTouch®** are, for example, adjustments of the favourite (Internet sites) for the Web browser. It is activated via the project planning software of the **Busch-ComfortTouch®**. Please see your electrical installer. He will also explain the operation to you.

5.3.18 Telephone (VoIP)

With the function "Telephone (VoIP)" the **Busch-ComfortTouch®** can be used as an Internet protocol telephone ("VoIP telephone"). Please check the requirements with your electrical installer.

The following requirements must be fulfilled:

- A broadband Internet connection with a transfer rate of at least 100 kbit/s in both directions must exist.
- The Internet provider must allow VoIP telephony.
- For the **Busch-ComfortTouch®** to be reachable via a conventional call number, an SIP account must be obtained from the Internet provider.

There is also the option of calling a different **Busch-ComfortTouch®** in the house. This allows the **Busch-ComfortTouch®** as intercom system (intercom function).

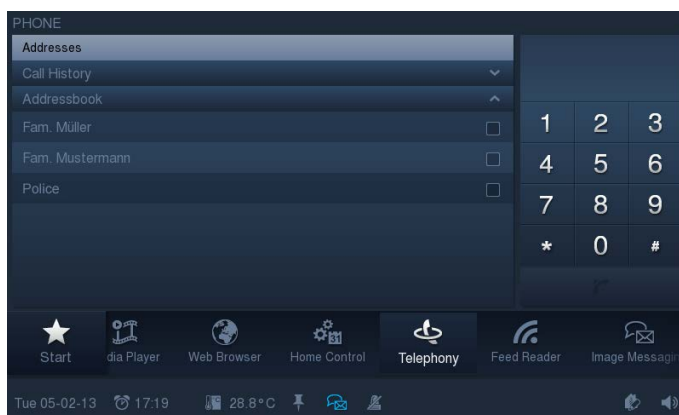

1. Press the "Telephone" icon in the navigation bar to access the function.

You can dial a number directly or select a stored number via the address book.

Dialling the number directly

1. Enter the number via the numbers keyboard.

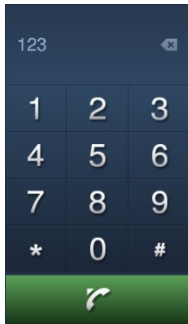

The digit entered last can only be deleted by touching the following sign:



2. Touch the following button.



The connection is being made. The time starts to run as soon as the call is answered.

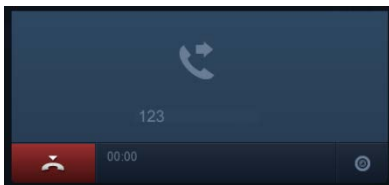

3. Terminate the call with the following button.



Dialling a stored number via the address book

1. Touch the entry "Address book".

A list with the stored address entries opens.

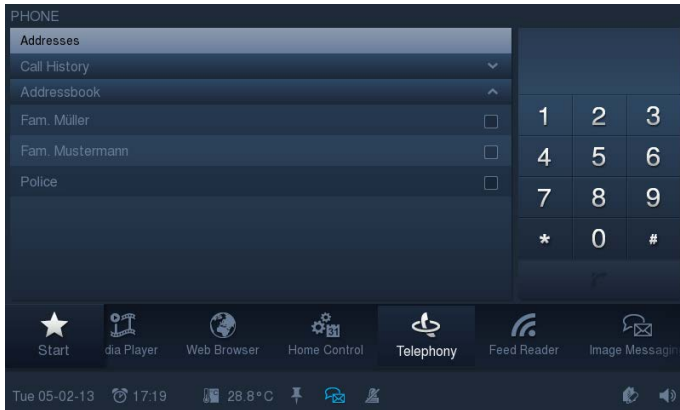

2. Set a tick at the desired party.

The name appears in the right field.

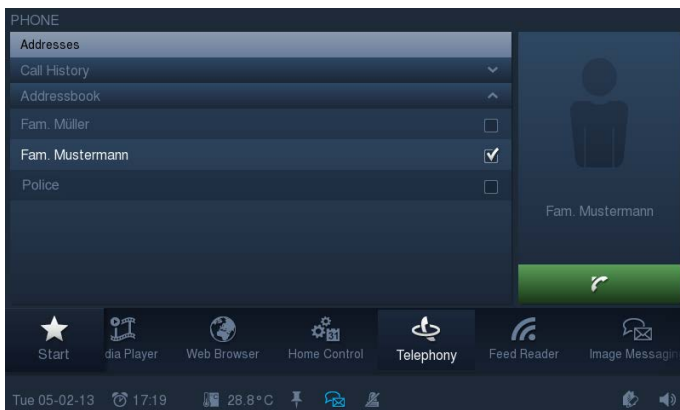

3. Touch the following button.



The connection is being made. The time starts to run as soon as the call is answered.

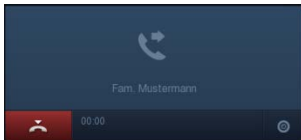

4. Terminate the call with the following button.



Note

Several parties may be called simultaneously as a group. For this you need to set a tick at several entries in the address book. The image on the right shows this accordingly.

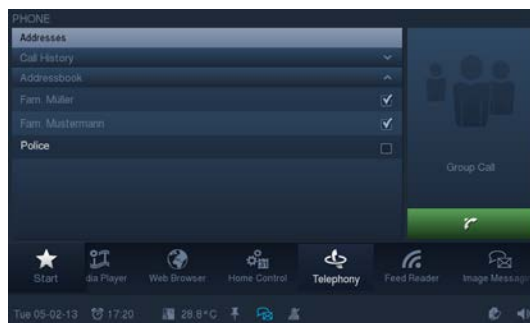

Note

Via the Web interface there is the option of making settings independently on the **Busch-ComfortTouch®**. Practical changes in the **Busch-ComfortTouch®** are, for example, adjustments to the address book for the telephone application. It is activated via the project planning software of the **Busch-ComfortTouch®**. Please see your electrical installer. He will also explain the operation to you.

5.3.19 Door Communication

The "Door communication" function makes communication with image and sound possible between the **Busch-ComfortTouch®** and an outdoor station. For this, up to five outdoor stations can be configured in the network. In addition, up to three cameras can be assigned to each outdoor station.

When the visitor presses the bell of an outdoor station (VoIP outdoor station), it is indicated on the **Busch-ComfortTouch®** as a door call. The **Busch-ComfortTouch®** switches automatically to the "Door communication" function (or, depending on the setting, first issues a message that needs to be confirmed) and shows the camera image of the respective outdoor station. The user can now accept or reject the call and switch conversation to mute, open the door and switch on the light. The view can also be switched to a different camera of the outdoor station.

In addition, the user can view all previous events via History (progress). Images (snapshots) can be recorded automatically or manually for this.

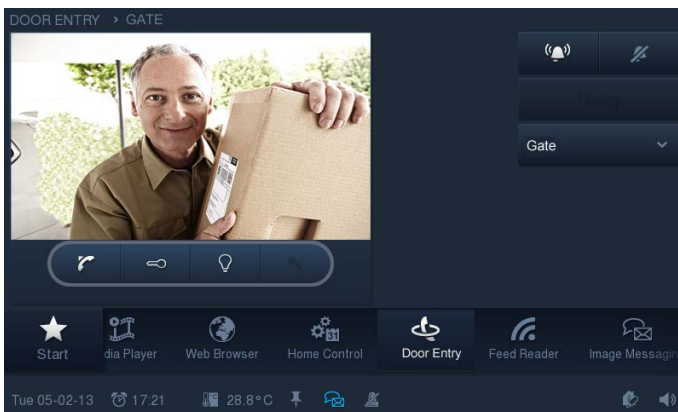

The function is opened either by pressing the "Door communication" icon in the navigation bar or automatically by an incoming bell call of an outdoor station. Depending on the setting, a message that must be confirmed appears first.

Selecting the function via the icon (no bell call)

A call up is practical when one wishes to view an archived snapshot or a current camera image of the different outdoor stations. The ring tone can also be deactivated.

Switching outdoor stations (camera image)

1. Open a list of connected outdoor stations with the aid of the following arrow on the right side.



2. Select the outdoor station.

The image will now be displayed. If the outdoor station has several cameras, the arrow buttons (< / >) can be used to switch between the cameras.

Open and edit the history (progress) of snapshots

1. Open a list of connected outdoor stations with the aid of the following arrow on the right side.



2. Now select the outdoor station.
3. Press "History".

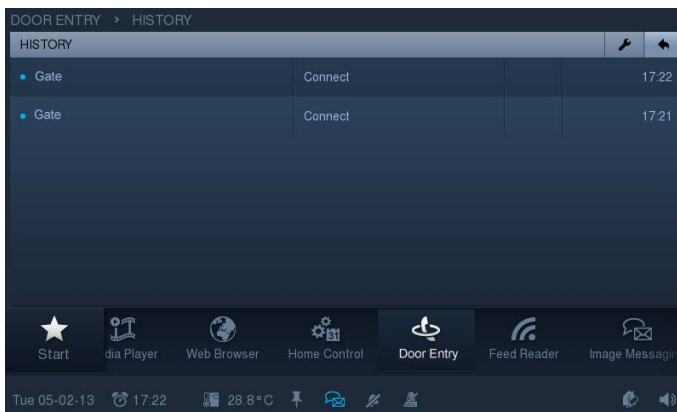

4. Select an entry.

The snapshot is displayed.



With the aid of the arrows one can switch between all snapshots of the outdoor station.

5. Press "OK".

The overview is displayed again.

6. Press the tool icon for editing.



7. Select an entry from the list.

This entry (snapshot) can be deleted with the cross on the right side. The entry can also be exported with "Export". For this, additional pages open which enquire the storage medium and the directory.



Caution



The entire list can be deleted with the cross next to "Export".

8. Return by pressing each time on the following arrow.



Deactivating the ring tone

The ring tone can be activated or deactivated via the following buttons (top right).



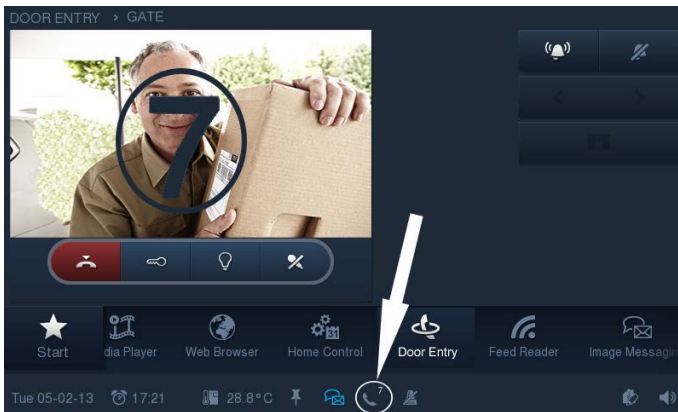

Button	Description
	Activating the ring tone (the ring tone is on: the icon is white).
	Deactivating the ring tone (the ring tone is off: the icon is white. The icon is also displayed in the status bar).

The function opens automatically at an incoming bell call.







When the visitor presses the bell of an outdoor station, it is indicated on the **Busch-ComfortTouch**® as a bell call. The **Busch-ComfortTouch**® switches automatically to the "Door communication" function (or, depending on the setting, first issues a message that needs to be confirmed) and shows the camera image of the respective outdoor station. Via the project planning software of the **Busch-ComfortTouch**® it can also be specified that the camera image is displayed in full-page mode. Please see your electrical installer.

Control options

	Accept the bell call.
	Activate the door opener at the outdoor station.
	Activate the light at the outdoor station.
	Deactivate the light at the outdoor station.

Control options after acceptance of the bell call.

	Mute function off (sound transmission to the outdoor station).
	Mute function on (no sound transmission to the outdoor station).
	Switch between the different cameras of an outdoor station.
	Create images (snapshots) (manually).
	Ending a bell call.



Note

The project planning software of the **Busch-ComfortTouch®** can also be used to specify how long the function remains open until it is automatically closed. Please see your electrical installer.

The running time is also displayed in the status bar. If the time has run down to 10 seconds, the expired time also appears in the camera image (see the following figure).

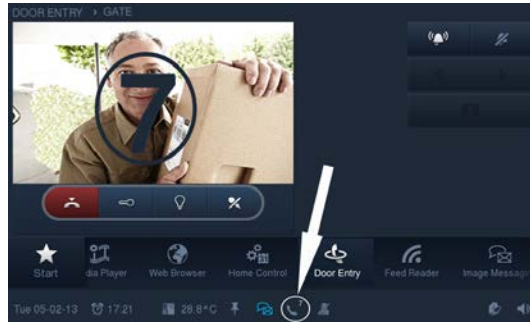

5.3.20 Fault and alarm messages

The **Busch-ComfortTouch**® offers protection and information during malfunction or interference.

Message contacts, sensors and their proper function can be monitored. The message issued in the event of a malfunction or notification can be set individually. The following can be selected:

- Alarm tone
- E-mail
- Scene for information or prevention.

Via "Fault and alarm messages" the user can see which messages have appeared on the **Busch-ComfortTouch**®. He can additionally use this function to acknowledge the messages, to export or delete them.

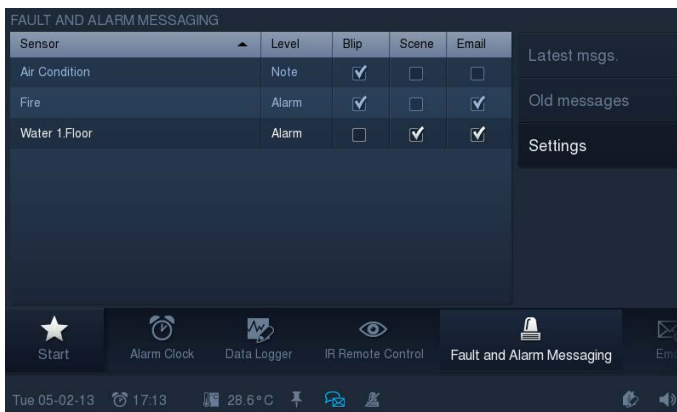

1. Press the "Fault and alarm messages" icon in the navigation bar to access the function.

By inserting a tick in "Settings" you can assign to the individual sensors how the information is to be provided. Several information paths can be selected together.

2. Press "Last message" to view all the unconfirmed messages.

Here the messages can be confirmed.

Via "Tool icon" (🔧) you access the next overview. Here the messages can be exported or deleted. With the arrow icon you go back.

3. Press "Old message" to view all the confirmed messages.

Via "Tool icon" (🔧) you access the next overview. Here the messages can be exported or deleted. With the arrow icon you go back.

5.3.21 IR remote control

The **Busch-ComfortTouch®** can be controlled via an RC5 or B&O capable remote control. To do this, the functions of the **Busch-ComfortTouch®** are programmed to an IR remote control. For this the available IR functions are predefined in the **Busch-ComfortTouch®** by the electrical installer with the aid of the project planning software. Programming of a new IR remote control is also possible on the device later.

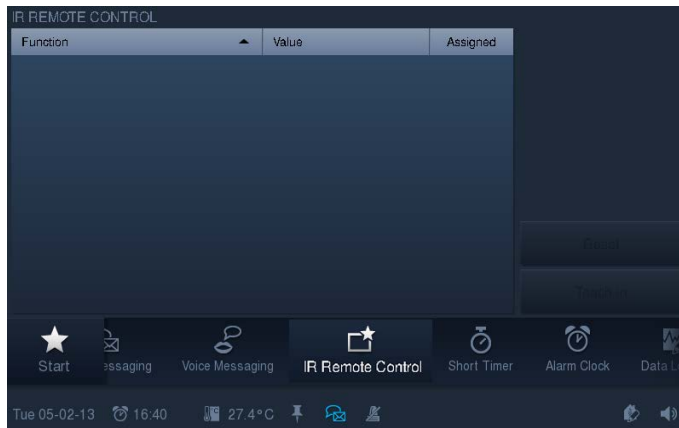

1. Press the "IR remote control" icon in the navigation bar to access the function.

The functions suitable for the IR remote control are described on the left.

2. Press an entry in the list and then "Teach in" to assign this function to the remote control.

A time of 5 seconds runs down.

3. During this time press a button on the remote control to assign the respective function to this button. To do this, point the remote control towards the **Busch-ComfortTouch®**. When this process is successful, a tick appears in "Assigned".

4. Select an entry from the list.

The assignment can also be deleted at any time.

5. The press "Reset".

When this process is successful, the tick is removed from "Assigned".

5.3.22 Scene editor

The "Scene editor" function offers the user the option of changing scenes and sequences which have been created in the project planning software ("Standard scenes").

The end user can also change so-called "Special scenes" that have been permanently assigned to an application page or a software module (e.g. alarm clock scenes).



Note

In the "Scene editor" on the **Busch-ComfortTouch®** the user cannot create new scenes. This is only possible with the scene editor in the project planning software.

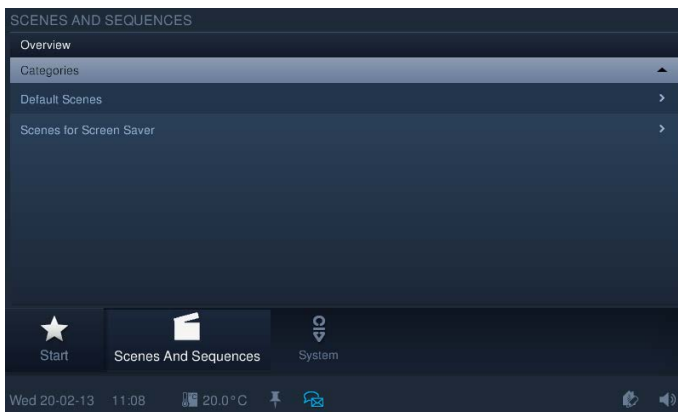

You reach the function by pressing the "Scenes and sequences" icon in the navigation bar. The function can also be opened via other functions that operate with scenes. Here the editing function opens directly (see the following instructions).

The overview shows the available categories of corresponding scenes and sequences.

1. Select a category .

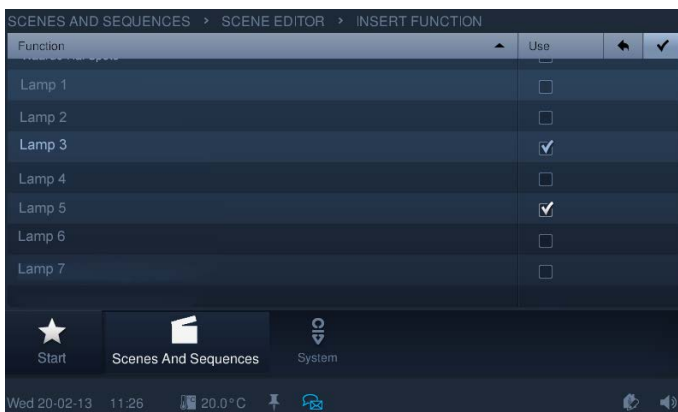

The overview shows the scenes and sequences that can be played. The scene can be activated / deactivated by inserting a tick. Additionally, the status of the scenes and the remaining times are displayed here after they are started.

2. Select an entry (scene) to edit it.

The scene can now be started with the aid of the "Control element" (see section "Control elements").

3. Press "Scene editor" to adjust the scene. Select an entry for this.

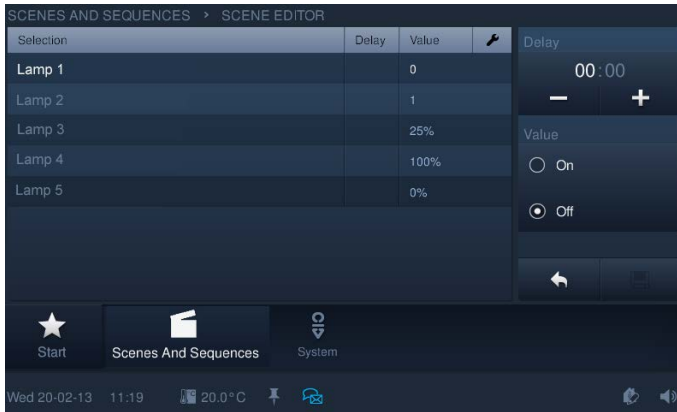

The overview shows components (functions) of the selected scene or the sequence. These components can be changed to a limited extent.

The adjustments that can be made are shown on the right.

4. Press the following icon to enable you to make adjustments for the entire scene.



Note

If the start time is changed, all the following scenes adjust their start times automatically.

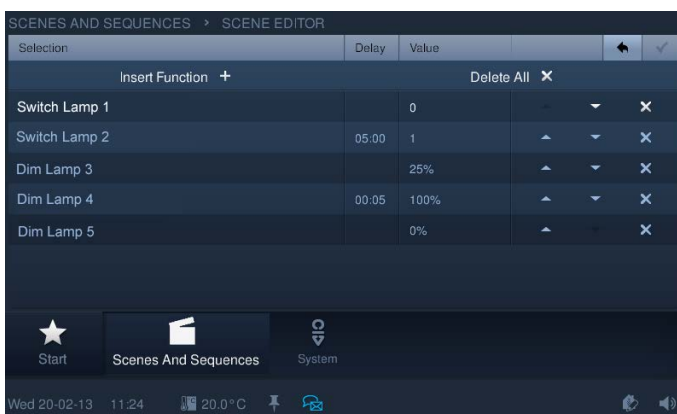

5. In this view you can delete individual functions.

6. For this, select the function and press the cross. Press the following icon to confirm the adjustment.



All functions can also be deleted. In addition, the sequence can be changed with the arrows.

With the right arrow icon you go back.



7. Additional components (functions) can also be added. Press "Insert function". Set a tick at the desired function and press the following icon to confirm the adjustment.

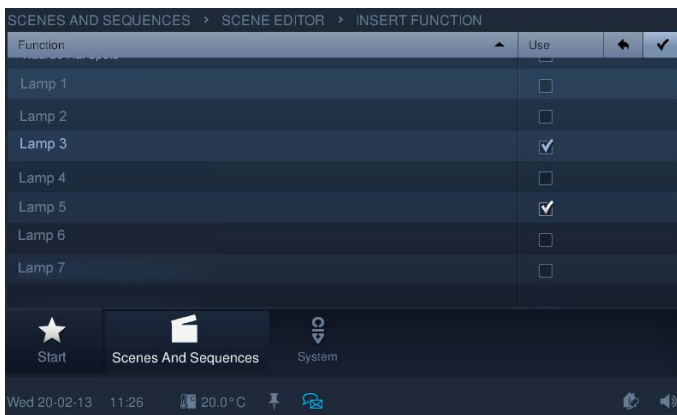

With the right top arrow icon you go back.

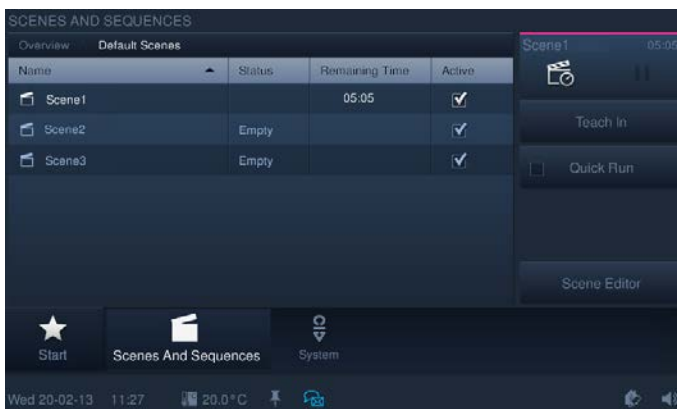

On the scene overview page the adjustments must then be programmed.

8. To do this, press "Programming". The scene can then be played (sequence, see the figure above).

5.3.23 Room temperature controller

The **Busch-ComfortTouch®** includes a local room temperature controller in the device.

Further, the temperature of various rooms can be controlled centrally by the device, i.e. only one actual temperature needs to be available from the various rooms (e.g. an external temperature sensor) and the **Busch-ComfortTouch®** can then control the temperature. The control of external temperature controllers and fan control according to requirements is also possible via the **Busch-ComfortTouch®**.



Note

The local temperature controller on the **Busch-ComfortTouch®** is opened via the status bar [1]. An external room temperature controller [2] is opened via the button of the control element.

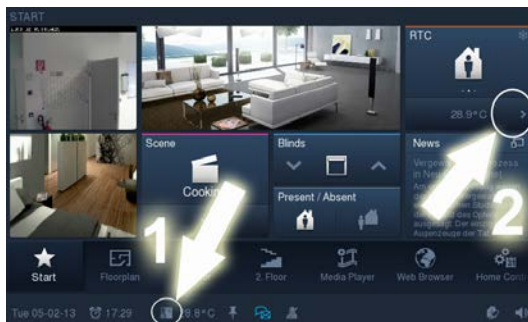

The status bar indicates the actual or set-point temperature of the room. Also the set operating mode of the local room temperature controller is displayed via different icons. With a press on the temperature the local room temperature controller opens.

The control element of an external room temperature controller can, for example, display the actual or set-point temperature of the room, which is regulated by the external room temperature controller.

The control element can also display the actual operating mode and the mode (e.g. heating). With a press on the control element the external room temperature controller opens.

The operating window is identical for both room temperature controllers!

The following figure shows an example of the an overview of the control and display elements of the room temperature controller (elements are available or not according to the setting in the project planning software of the **Busch-ComfortTouch®**).

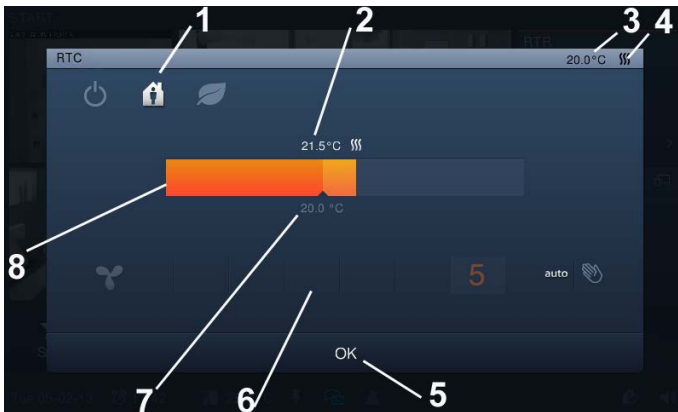







Fig. 8: Overview of the control and display elements of the room temperature controller

1 Operating modes | 2 Set set-point temperature | 3 Actual or set-point temperature | 4 Mode display |
5 Button for confirming the settings | 6 Fan settings | 7 Actual temperature | 8 Controller for manual adjustment

Operating modes (White icon, when the operating mode is active)	Description
	The room temperature controller is deactivated
	Presence (comfort temperature: the residents are at home)
	Absent (eco mode, cost-saving temperature: the residents are not at home).

The operating mode is activated by pressing the icons. The icons appear also in the status bar or the control element.

Mode display

Mode display	Description
	Heating mode.
	Cooling mode.

Fan setting

The fan setting is a "Step switch". The fan setting has a button to reset the step switch (fan icon = off) and buttons to call up the next or previous step. Also the step currently switched is displayed. The icon can be animated during adjusting. A switchover from "Automatic mode" (no fan speed levels can be activated) to "Manual mode".

Operation

The modes and settings are visually highlighted by means of a colour system. A white temperature display indicates that a mode (e.g. heating) has been started.

Some typical applications are shown in the following.

- Heating mode active:
Star heating mode since the actual temperature is lower than the set-point temperature.
The mode is additionally displayed by means of an orange-coloured bar. The difference between the actual and set-point temperature is displayed in a lighter shade.
The fan here is also started automatically.

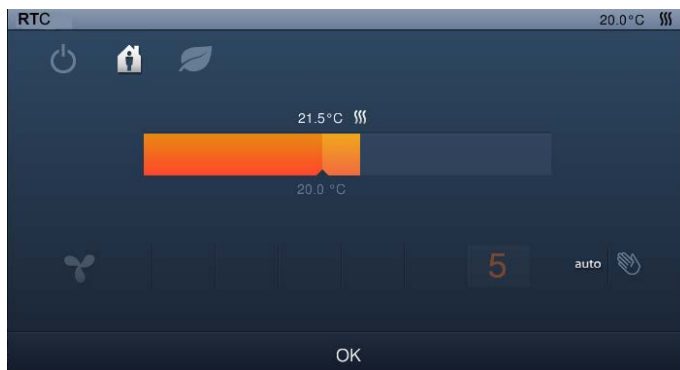

- Manual adjustment.
The set-point temperatures can also be adjusted manually. Simply press the controller. A circle appears which can be appropriately moved.

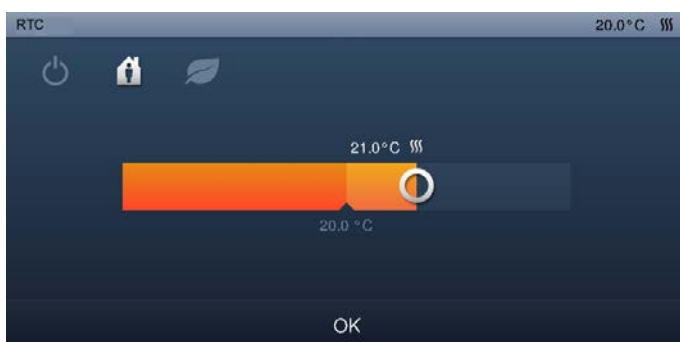

– Eco mode:

Eco mode is indicated by means of a green bar. Additional settings cannot be made. The settings are made via the project planning software of the **Busch-ComfortTouch®**. Here it can also be specified that a manual adjustment is admissible!

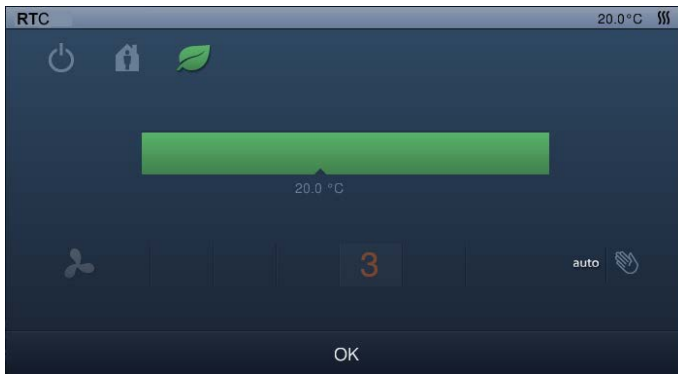

- Only fan operation:

- Here only the fan system can be operated (for a description, see above).

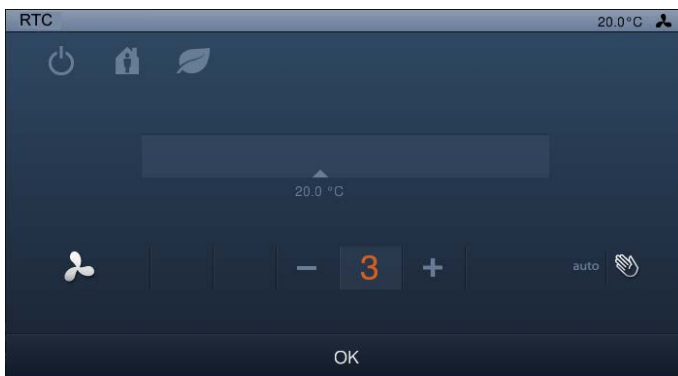

- The room temperature controller is deactivated

No settings can be made. To reactivate the room temperature controller, the operating mode "Room temperature controller deactivated" must be pressed again.

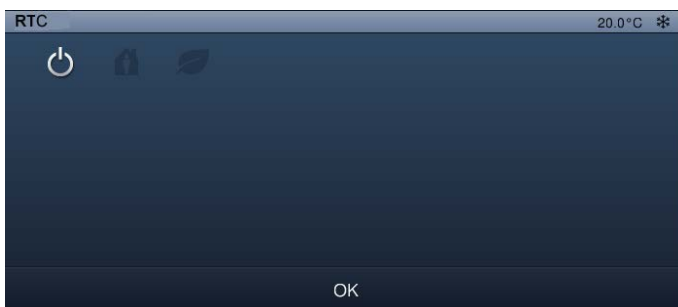

5.3.24 Date and time settings

Set date

The current date is displayed in the status bar.

So 06.04.08

1. Press on the date.

An option opens.

2. Here select the "Date setting".

Additional date-relevant functions are available for selection depending on the activation.



3. Select the date format. Press the arrow to open an options list.
4. Press an entry here.
5. Set the date.
6. Touch the day, the month or the year.

The setting is made via -/+.

7. Press the "Save" button.

Set time

The current time is displayed in the status bar.

10:20

1. Press the time.

An option opens.

2. Here select the "Time setting".

Additional time-relevant functions (alarm clock and timer) are available for selection depending on the activation.

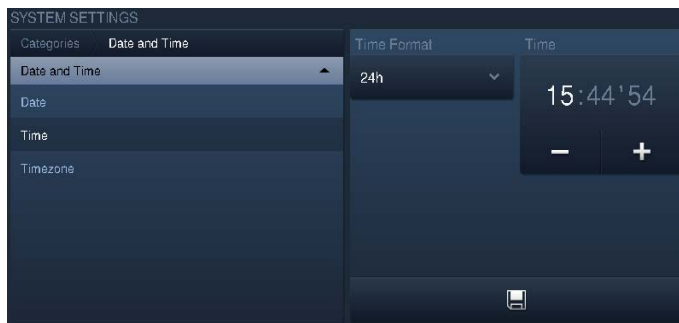

3. Select the date format. Press the arrow to open an options list.
4. Press an entry here.
5. Set the time.
6. Touch the hours or minutes or the seconds.
The setting is made via -/+.
7. Press the "Save" button.

5.3.25 Import and export of files

The **Busch-ComfortTouch®** contains a simple import and export function for files.

This function is started via "System" -> "Import / Export". The export function is described in the following.

1. Select the storage medium on which the file is to be saved.

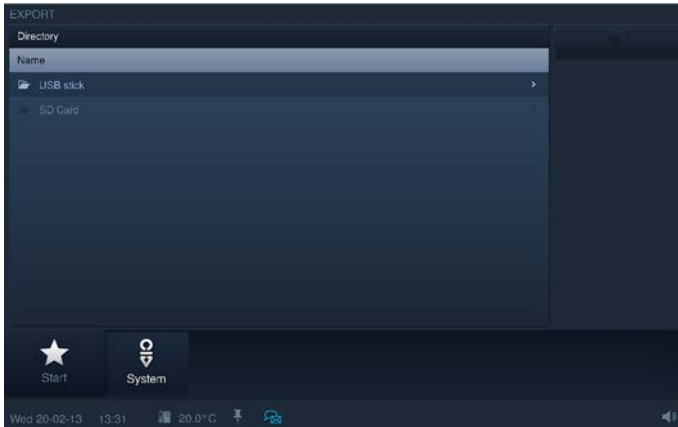

2. Select the directory on the storage medium.
3. Press the "Save" button.

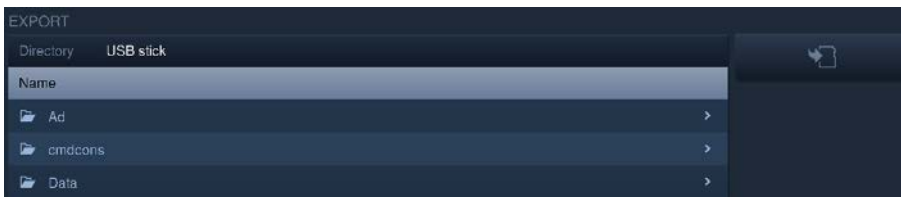

5.3.26 System settings

Some system settings can also be made directly on the **Busch-ComfortTouch®**. They are called up via the "System" icon in the navigation bar of the **Busch-ComfortTouch®**.

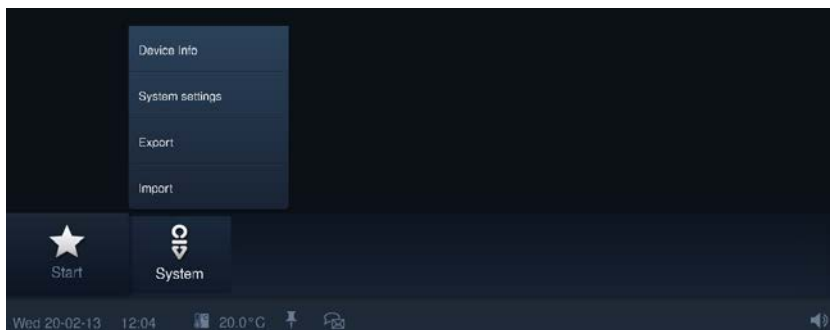

The following system settings are possible (depending on the project planning status, additional settings are available):

System settings	Description
Date and time	Formats, date, time and time zones.
Screen	Screen brightness.
Network settings	Network type, IP settings and WLAN network.
Settings on the Busch-ComfortTouch®	Basic settings (separators, first day of the week) Camera setting (Attention: This settings is made by the electrical installer) Dialog settings (signal tones and messages) Temperature settings (temperature unit and internal temperature offset) User settings (system language, user language, tone when pressing a button,)
Screen saver	Running time "Start saver", running time "Monitor off", effects, interval change and order

Modification of system settings

1. Select a category .
2. Then select the desired entry (or first the sub-list and then the entry).
3. Make the settings on the right-hand side.
4. Press the "Save" button.

5.3.27 Device information

Important information about the device is available in the **Busch-ComfortTouch®** via "System" -> "Device information". This includes the IP address, the MAC address and the contact details of the manufacturer.

6 Cleaning

Dirty units can be cleaned with a slightly moistened cloth. If this is insufficient, the cloth can be moistened also with a soap solution.



Caution

Incorrect cleaning can damage the device!

Incorrect cleaning agents can cause permanent damage to the surface of the device.

- Never use caustic cleaning agents or solvents.



Note

"Cleaning blockage"

To ensure that no functions is triggered unintentionally when cleaning the **Busch-ComfortTouch®**, the control elements can be blocked for a certain period.

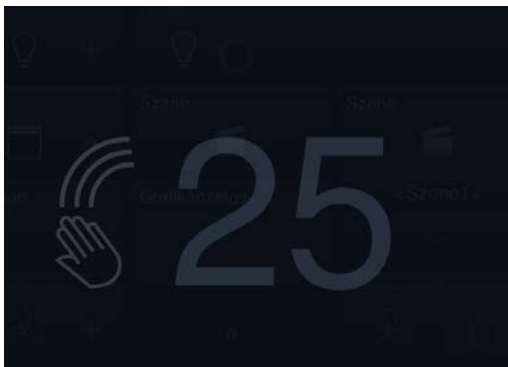

The cleaning blockage is activated with a long press of the start button. It is automatically deactivated after 30 seconds.

A member of the ABB Group

Busch-Jaeger Elektro GmbH

PO box
58505 Lüdenscheid

Freisenbergstraße 2
58513 Lüdenscheid
Germany

www.BUSCH-JAEGER.com

info.bje@de.abb.com

Central sales service:

Phone: +49 (0) 2351 956-1600

Fax: +49 (0) 2351 956-1700

Notice

We reserve the right to at all times make technical changes as well as changes to the contents of this document without prior notice.

The detailed specifications agreed to at the time of ordering apply to all orders. ABB accepts no responsibility for possible errors or incompleteness in this document.

We reserve all rights to this document and the topics and illustrations contained therein. The document and its contents, or extracts thereof, must not be reproduced, transmitted or reused by third parties without prior written consent by ABB.

Copyright© 2013 Busch-Jaeger Elektro GmbH
All rights reserved