

Installation Manual

FLEXA 3.0 IBPRO6

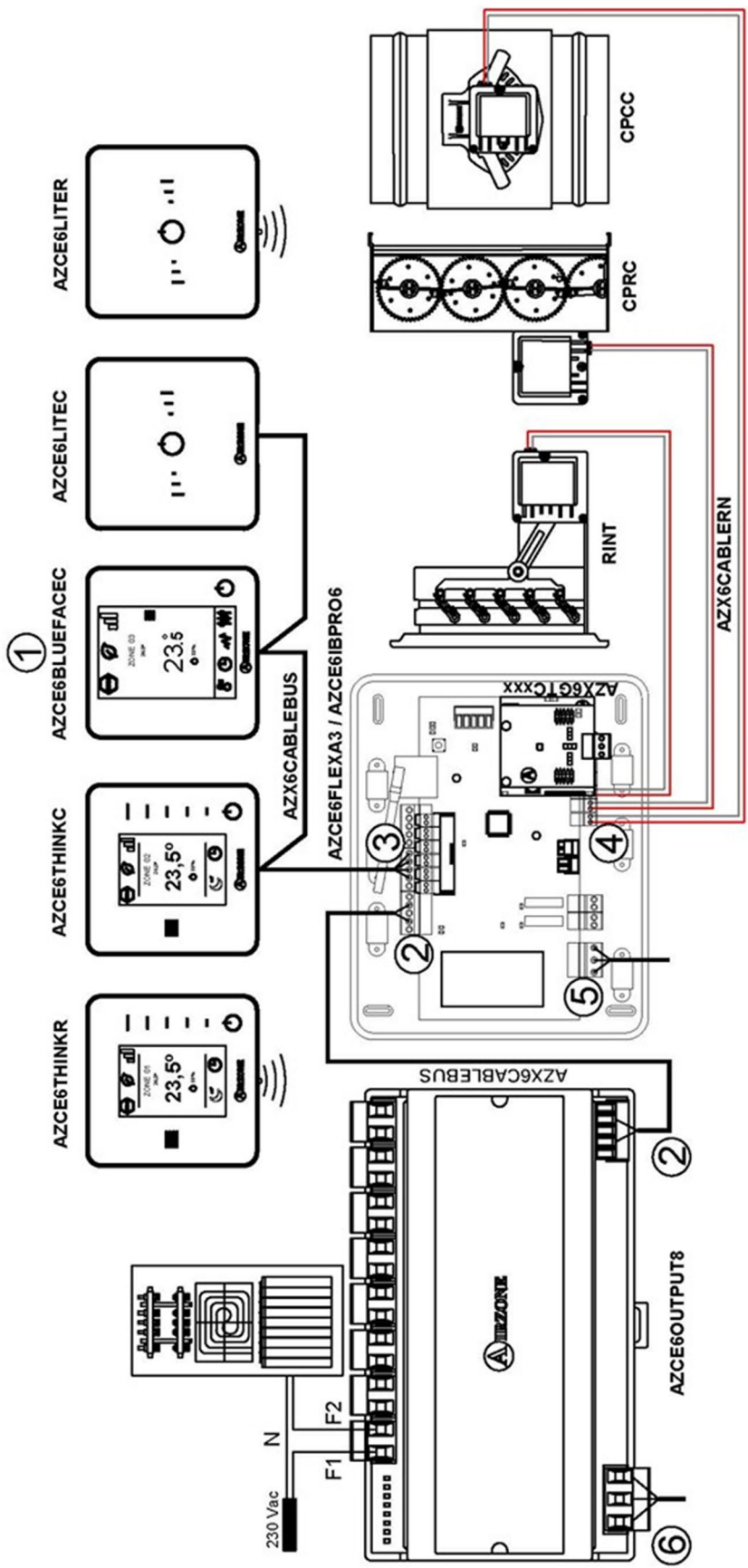



- | | | |
|---|--|------------------------------------|
| ① | | 2 x 0.22 + 2 x 0.5 mm ² |
| ② | | 2 x 0.22 mm ² |
| ③ | | 2 x 0.22 + 2 x 0.5 mm ² |
| ④ | | 2 x 0.75 mm ² |
| ⑤ | | 3 x 1.5 mm ² |
| ⑥ | | 3 x 1.5 mm ² |
-
- | |
|---|
| A Azul Blue Azul Bleu Blu Blau
- Negro Black Negro Noir Nero Schwarz
B Verde Green Verde Vert Verde Grün
+ Rojo Red Vermelho Rouge Rosso Rot |
| N Neutro Neutral Neutro Neutro Neutraleiter
L Fase Phase Fase Phase Phase
Tierra Ground Terra Terra Schutzleiter |

INDEX

Warnings and environmental policy.....	6
Precautions.....	6
Environmental policy	6
System elements.....	7
Airzone Main control board (AZCE6FLEXA3 / AZCE6IBPRO6).....	7
Airzone Expansion module of 2 zones (7 and 8) (AZCE6EXP8Z)	7
Airzone On/off zone module (AZCE6ONOFF6Z)	7
Airzone Control module of radiant elements (AZCE6OUTPUT8).....	7
Airzone Blueface color thermostat (AZCE6BLUEFACEC)	8
Airzone Think monochrome thermostat Wired/wireless (AZCE6THINK [C/R]).....	8
Airzone Lite thermostat Wired/Wireless (AZCE6LITE [C/R])	8
Airzone controller 3.0 gateway (AZX6GTC xxx)	9
Airzone Communication gateway (AZX6QADAPT xxx)	9
Airzone 0-10 V Fancoil control gateway (AZX6010VOLT SZ).....	9
Airzone control gateway – 3 speeds fancoil (AZX6FANCOILZ).....	10
Airzone control gateway for electromechanical units (AZX6ELECTROMECH).....	10
Webserver airzone cloud wi-fi dual 2.4-5G (AZX6WSC5GER).....	10
Webserver Hub Airzone Cloud Dual (AZX6WSPHUB).....	11
Webserver Hub Airzone-BACnet (AZX6WSPBAC)	11
Webserver Hub Airzone-Lutron (AZX6WSPLUT)	11
Airzone Supermaster controller (AZX6CSMASTER [S/E] [B/G])	12
Airzone Hidronic production control board (AZX6CCPGAWI).....	12
Airzone Production control board (AZX6CCP)	12
Airzone Aerothermal Gateway (AZX6GAW xxx)	13
KNX integration gateway (AZXKNXGTWAY)	13
Airzone consumption meter (AZX6ACCCON)	13
Airzone temperature metallic probe in sheath (AZX6SONDPROTEC)	13
General requirements.....	14
Introduction.....	15
System installation.....	15
Assembly and connection.....	16
Main control board (AZCE6FLEXA3 / AZCE6IBPRO6).....	16
Assembly.....	16
Connection.....	16
Airzone Expansion module of 2 zones (7 and 8) (AZCE6EXP8Z)	20
Connection.....	20
Airzone Control module of radiant elements (AZCE6OUTPUT8).....	21
Assembly.....	21
Connection.....	21
Wired Airzone thermostats (AZCE6BLUEFACEC / AZCE6THINKC / AZCE6LITEC).....	22
Assembly.....	22
Connection.....	22
Wireless Airzone thermostats (AZCE6THINKR / AZCE6LITER)	23
Assembly.....	23

Changing batteries.....	23
0-10 V Fancoil Control gateway (AZX6010VOLTSZ).....	24
Assembly.....	24
Connection.....	24
Airzone control gateway-3 speeds fancoil (AZX6FANCOILZ).....	25
Assembly.....	26
Connection.....	26
Control gateway for electromechanical units (AZX6ELECTROMECH).....	27
Assembly.....	27
Connection.....	27
Webserver Airzone Cloud Wi-Fi dual 2.4-5G (AZX6WSC5GER).....	29
Assembly.....	29
Connection.....	29
Configuration.....	29
Webserver HUB Airzone Cloud dual (AZX6WSPHUB).....	30
Assembly.....	30
Connection.....	30
Configuration.....	31
Webserver HUB Airzone BACnet (AZX6WSPBAC).....	31
Assembly.....	32
Connection.....	32
Configuration.....	32
Webserver HUB Airzone-Lutron (AZX6WSPLUT).....	33
Assembly.....	33
Connection.....	33
Configuration.....	34
Airzone Supermaster controller (AZX6CSMASTER [S/E] [B/G]).....	35
Assembly.....	35
Connection.....	35
Airzone hydronic production control board (AZX6CCPGAWI).....	36
Assembly.....	36
Connection.....	36
Airzone Production control board (AZX6CCP).....	40
Assembly.....	40
Connection.....	40
KNX integration gateway (AZXKNXGTWAY).....	44
Assembly.....	44
Connection.....	44
Airzone consumption meter (AZX6ACCCON).....	45
Assembly.....	45
Connection.....	45
Reset.....	46
Assembly and connection evaluation.....	47
System start-up.....	47
Airzone Blueface and Airzone Think setup.....	47

Airzone Lite setup.....	50
Lite thermostat reset	50
Initial Configuration evaluation	50
User and zone settings	51
User settings - Blueface thermostat	51
Zone Configuration menu – airzone Blueface Thermostat.....	51
User settings – airzone Think thermostat.....	52
Advanced settings.....	53
System settings.....	54
Zone Parameters	55
Production Settings	56
Self-diagnose.....	58
Airzone Main control board (AZCE6FLEXA3 / AZCE6IBPRO6).....	58
Airzone Expansion module of 2 zones (7 and 8) (AZCE6EXP8Z)	59
Airzone Control module of radiant elements (AZCE6OUTPUT8).....	59
Airzone Blueface and Think thermostats (AZCE6BLUEFACEC / AZCE6THINK [C/R])	60
Blueface Thermostat Warnings	60
Think Thermostat Warnings	60
Blueface and Think Thermostats errors	60
Airzone Lite thermostat (AZCE6LITE [C/R])	68
Airzone controller 3.0 gateway (AZX6GTCxxx)	70
Airzone Communication gateways (AZX6QADAPT xxx)	70
0-10 V Fancoil communication gateway (AZX6010VOLTSZ).....	71
Fancoil Communication gateway (AZX6FANCOILZ).....	71
Airzone control gateway for electromechanical units (AZX6ELECTROMECH).....	72
Webserver Airzone Cloud (AZX6WEBSCLLOUDC/AZX6WSC5GER).....	72
Airzone hydronic production control board (AZX6CCPGAWI)	73
Cloud ethernet Airzone Production control board (AZX6CCPWSCC).....	74
Airzone Production control board (AZX6CCP).....	75
Airzone Aerothermal gateways (AZX6GAW xxx).....	75
Airzone-KNX integration gateway (AZX6KNXGTWAY)	76
Airzone-BACnet integration gateway and Airzone-LUTRON integration gateway (AZX6BACNET and AZX6GTILUT).....	76
Airzone consumption meter (AZX6ACCCON)	77
Navigation trees.....	78
Navigation Tree - Blueface Thermostat.....	78
Navigation Tree - Think Thermostat.....	79

WARNINGS AND ENVIRONMENTAL POLICY

PRECAUTIONS

For your security, and to protect the devices, follow these instructions:

- Do not handle the system with wet or damp hands.
- Disconnect the power supply before making any connections.
- Take care not to cause a short circuit in any of the system connections.

ENVIRONMENTAL POLICY



Do not dispose of this equipment in the household waste. Electrical and electronic equipment contain substances that may damage the environment if they are not handled appropriately. The symbol of a crossed-out waste bin indicates that electrical equipment should be collected separately from other urban waste. For correct environmental management, it must be taken to the collection centers provided for this purpose, at the end of its useful life.

The equipment's components may be recycled. Act in accordance with current regulations on environmental protection.

If you replace it with other equipment, you must return it to the distributor or take it to a specialized collection center.

Those breaking the law or by-laws will be subject to such purposes and measures as are laid down in environmental protection legislation.

SYSTEM ELEMENTS

AIRZONE MAIN CONTROL BOARD (AZCE6FLEXA3 / AZCE6IBPRO6)

Electronic board that controls the system through wired and wireless devices. Wall mounted.

Functionalities:

- Control and management of the thermostats (up to 6 zones or 8 zones with expansion module).
- Power outlets for motorized elements.
- Zone On/Off module (up to 6 zones or 8 zones with expansion module) (*Only available for AZCE6IBPRO6*).
- Relay outlet configurable as CMV (controlled mechanical ventilation) or boiler.
- Gateway control management.
- Communications with units of integral control of the installation.
- Communications with other external control systems through integration bus.

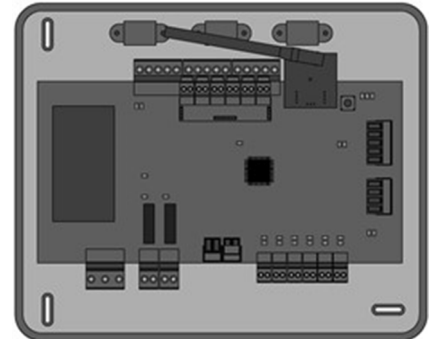

AIRZONE EXPANSION MODULE OF 2 ZONES (7 AND 8) (AZCE6EXP8Z)

Expansion module for controlling zone 7 and 8 in Airzone installations. Connection and power supply through Airzone connection bus of the main control board.

Functionalities:

- Two actuators for controlling zones 7 and 8.
- Two window contacts for controlling zones 7 and 8.

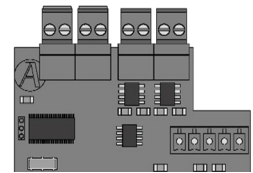

AIRZONE ON/OFF ZONE MODULE (AZCE6ONOFF6Z)

Module that allows suspending zone demand through dry voltage free contacts. Powered by main control board. Assembled on main control board through connectors.

Functionalities:

- On/Off of the zone through voltage free contact (for example: window contact).

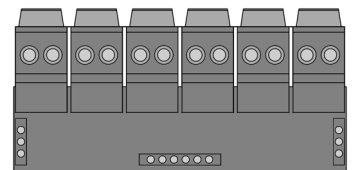

AIRZONE CONTROL MODULE OF RADIANT ELEMENTS (AZCE6OUTPUT8)

Control module of radiant elements for zoned heating. Communications through system Airzone connection bus. Externally powered at 110/230 Vac. DIN rail mounted.

Functionalities:

- Control of up to 8 radiant elements through 10 to relays at 110/230 Vac.

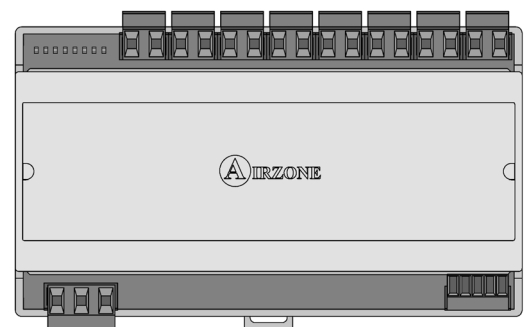

AIRZONE BLUEFACE COLOR THERMOSTAT (AZCE6BLUEFACEC)

Color graphic interface with capacitive screen for controlling zones in Airzone systems. Powered by main control board. Finished in steel and glass. Available in white and black.

Functionalities:

- Available in Spanish, English, French, Italian, German and Portuguese.
- Control of temperature, operating mode (Master thermostat) and system speed (Master thermostat and fancoil installations).
- Room temperature and relative humidity measurement of the zone.
- Configuration stages control (air, radiant or combined).
- Eco-Adapt function.
- Sleep function.
- Temperature and mode time schedules.
- Remote access to other zones of the system.
- Weather forecast and AC unit consumption (optional).



AIRZONE THINK MONOCHROME THERMOSTAT WIRED/WIRELESS (AZCE6THINK [C/R])

Graphic interface with low-energy e-ink screen and capacitive buttons for controlling zones in Airzone systems. Finished in steel and glass. Wired/wireless communications. Powered from main control board (wired) or by CR2450 button battery (wireless). Available in white and black.

Functionalities:

- Available in Spanish, English, French, Italian, German and Portuguese.
- Control of temperature, operating mode (Master thermostat) and system speed (Master thermostat and fan coil installations).
- Room temperature and relative humidity reading.
- Sleep function.
- Remote access to other zones of the system.
- Weather forecast (optional).



AIRZONE LITE THERMOSTAT WIRED/WIRELESS (AZCE6LITE [C/R])

Thermostat with capacitive buttons for controlling the temperature of the zones in Airzone systems. Finished in steel and glass. Wired/wireless communications. Powered from main control board (wired) or by CR2450 button battery (wireless). Available in white and black.

Functionalities:

- On/off of the zone.
- Set-point temperature control (Accuracy: $\pm 1^\circ\text{C}$, max: $\pm 3^\circ\text{C}$.)
- Room temperature and relative humidity reading.



AIRZONE CONTROLLER 3.0 GATEWAY (AZX6GTC XXX)

Gateway for the management of AC units compatible with Airzone control systems. Powered by the indoor unit. Assembly and connection on the AC unit bus of the enabled Airzone devices. Product developed and tested in collaboration with the manufacturer.

Features:

- Two-way communication of the basic control parameters depending on the demand of the Airzone control system.
- Automatic control of speeds, enabling (generally) the operating without bypass.
- Adjustment of the set point temperature based on the selected temperatures in the Airzone thermostats and the Eco-Adapt algorithm.
- Reading of the operating temperature of the system.
- Reading of warnings and errors of the controlled unit.
- Master control of the unit.

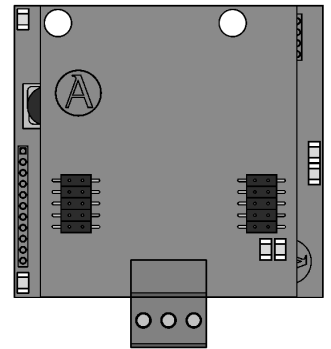

AIRZONE COMMUNICATION GATEWAY (AZX6QADAPT XXX)

Element that fully integrates AC units and Airzone zoning systems, enhancing the performance of the installation:

- ON/OFF depending on the number of zones where there's demand.
- Automatic mode changeover (Stop, Ventilation, Cooling, Heating or Dry) from master thermostat.
- Automatic fan speed selection based on the number of zones on demand.
- Set-point temperature adjustment based on the set-point temperatures of the zone thermostats of the system and Eco Adapt algorithm.

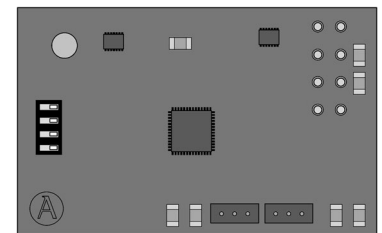

AIRZONE 0-10 V FANCOIL CONTROL GATEWAY (AZX6010VOLT SZ)

Control gateway of air-to-water zoning units. Fan control through 0-10 V output and opening-closing electrovalves Compatible with 2-pipe and 4-pipe installations. Externally powered at 110/230 Vac. Mounted on DIN rail or on wall.

Functionalities:

- Two relays for electrovalve control by demand.
- 0-10 V output for fan control.
- Automatic speed control based on the demand of the zones.

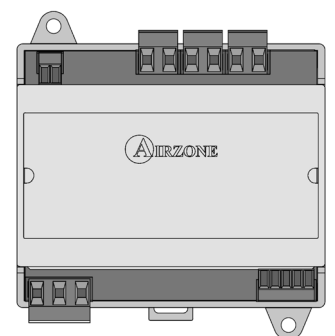

AIRZONE CONTROL GATEWAY – 3 SPEEDS FANCOIL (AZX6FANCOILZ)

Control gateway for air-to-water air conditioners. Control up to three fan-speeds and opening/closing of electro-valves. Compatible with 2 or 4-pipe air conditioners. Externally powered. Mounted on DIN rail or on wall.

Functionalities:

- Two electro-valve control relays for demand.
- Three control relays for fan-speed selection.
- Automatic fan speed selection based on the number of zones where there is demand.

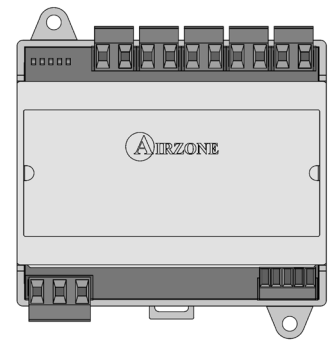

AIRZONE CONTROL GATEWAY FOR ELECTROMECHANICAL UNITS (AZX6ELECTROMECH)

Control gateway for air-conditioning units with electromechanical control. Management of up to two compressors in 1 stage (balanced) or 2 stages. Powered through AC unit bus. Mounted on DIN rail or on wall.

Functionalities:

- Relay for fan control.
- Relay to control up to two compressors.
- Relays to control heating/cooling modes.
- Relay for boiler control.
- Two Airzone probe inputs for protection of production units.

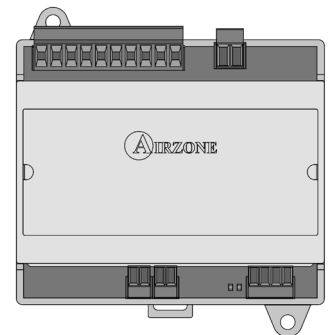

WEBSERVER AIRZONE CLOUD WI-FI DUAL 2.4-5G (AZX6WSC5GER)

Webserver for controlling systems through Airzone Cloud platform. Accessible through browser or app (available for IOS and Android). Connection via Wi-Fi. Powered through domotic bus.

Functionalities:

- Control of up to 32 systems.
- Configuration and control of zone parameters (Room and set-point temp., operating mode, etc.) and system parameters via Airzone Cloud.
- Associated with router through the app via Bluetooth.
- Temperature and operating mode time schedules.
- Multi-user and multisession.
- External control through Airzone Cloud platform.
- Remote updates of the Webserver firmware and the systems connected to it.
- Remote error detection and error resolution.

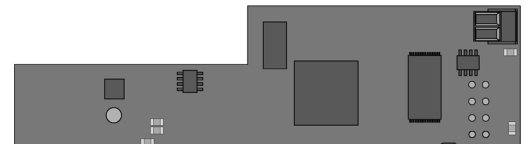

WEBSERVER HUB AIRZONE CLOUD DUAL (AZX6WSPHUB)

Webserver for controlling Airzone systems through Airzone Cloud platform. Accessible through browser or App (available for IOS and Android). Dual WiFi 2.4/5Ghz or Ethernet connection. Powered through domotic bus. Mounted on DIN rail or on wall.

Functionalities:

- Control of up to 32 systems.
- Configuration and control of zone parameters (Room and set-point temp., operating mode, etc.) and system parameters via Airzone Cloud.
- Associated with router through the app via Bluetooth.
- Multi-user and multisession.
- Port for integration via Modbus.
- Integration via local API.
- Remote updates of the Webserver firmware and the systems connected to it.
- Remote error detection and error resolution.

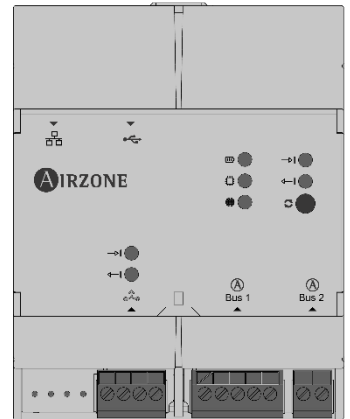

WEBSERVER HUB AIRZONE-BACNET (AZX6WSPBAC)

Integration webserver for controlling Airzone installations through BACnet platform. Dual WiFi 2.4/5Ghz or Ethernet connection. Powered through domotic bus. Mounted on DIN rail or on wall.

Functionalities:

- One Airzone-BACnet webserver per installation.
- Status of window contact and presence contact of each zone.
- Status of the radiant stage of each zone.
- On/Off of each zone.
- Set-point temperature control of each zone.
- Operating mode status.
- State and Fancoil fan speed.

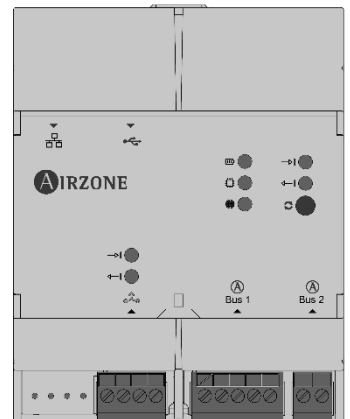

WEBSERVER HUB AIRZONE-LUTRON (AZX6WSPLUT)

Integration webserver for Lutron control systems on Airzone systems through Lutron HomeWorks QS Processor. Dual WiFi 2.4/5Ghz or Ethernet connection. Powered through domotic bus. Mounted on DIN rail or on wall.

Functionalities:

- Reading/Writing of the room temperature.
- Reading/Writing of the set-point temperature.
- Reading/Writing of the operating mode.
- Reading/Writing of the cooling/heating demand.
- Reading/Writing of the fan speeds.

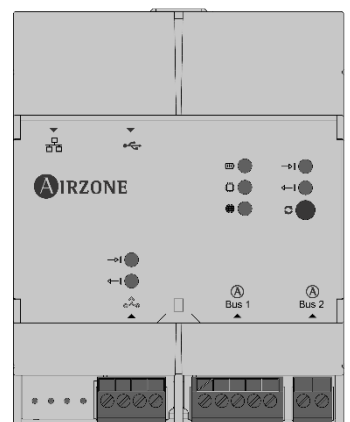

AIRZONE SUPERMASTER CONTROLLER (AZX6CSMASTER [S/E] [B/G])

Monochrome LCD touch screen back-lighted controller for managing the system of the installation. Powered through AC unit bus. Wall-mounted (AZX6CSMASTERS) or wall-embedded (AZX6CSMASTERE). Available in white and grey.

Functionalities:

- Up to 8 control groups.
- Operating mode and set-point temperature control.
- Forced mode control: it imposes the operating mode and the temperature, blocking the user control.
- Semi-forced mode control: it imposes the mode range and the temperature every hour.
- Forced mode control: it imposes the operating mode and the temperature, blocking the control for the user.
- Temperature time schedule for the installation.
- Operating mode time schedules.

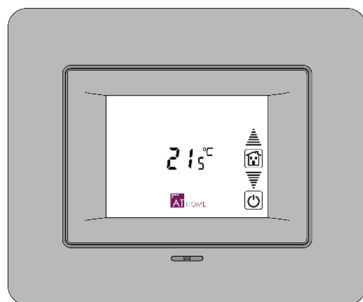

AZX6CSMASTERE

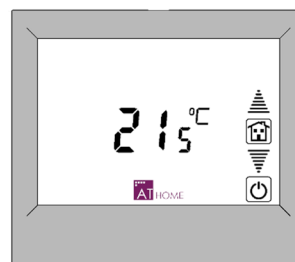

AZX6CSMASTERS

Important: This device is not compatible with the Production Control Board (AZX6CCP).

AIRZONE HIDRONIC PRODUCTION CONTROL BOARD (AZX6CCPGAWI)

Control board of production units. Communications through domotic bus. Externally powered at 110/230 Vac. Wall mounted.

Functionalities:

- Controls up to 32 systems.
- 6 control relays for cooling/heating modes, cooling/heating air demand and cooling/heating radiant demand.
- Inputs for semi-forced modes and DHW control.

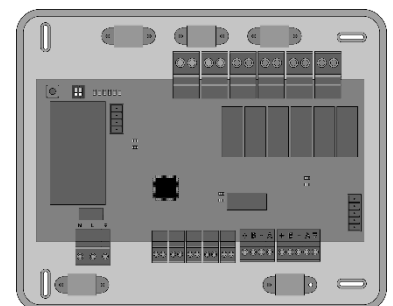

AIRZONE PRODUCTION CONTROL BOARD (AZX6CCP)

Control board of production units through 6 relays of 10 A at 110/230 Vac. Communications through domotic bus. Externally powered. Wall mounted.

Functionalities:

- Controls up to 32 systems.
- Controls cooling and heating mode through 2 relays.
- Controls cooling air and the heating air demand through 2 relays.
- Controls the cooling and heating radiant element demand through 2 relays.
- 3 Inputs for semi-forced mode.
- Input for boiler probe.

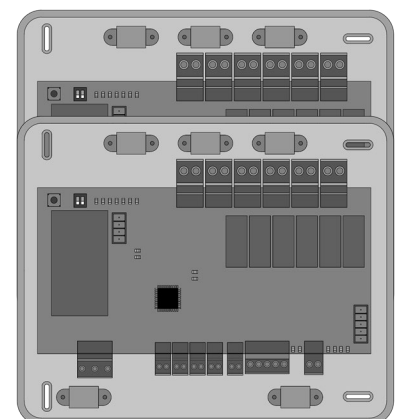

AIRZONE AEROTHERMAL GATEWAY (AZX6GAW XXX)

Communication gateway for aerothermal units. Powered through the AC unit bus of the production control board (AZX6CCP / AZX6CCPWSCC).

Functionalities:

- Two-way communication of the basic control parameters depending on the demand of the Airzone control system.
- Reading of errors of the controlled unit.
- Imposes water production temperature based on the demand.

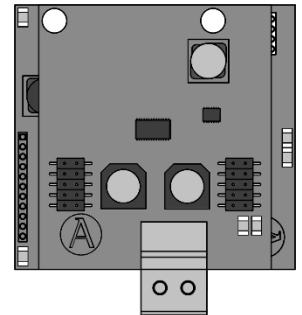

KNX INTEGRATION GATEWAY (AZXKNXGTWAY)

Airzone integration gateway of HVAC systems into KNX TP-1 control systems through Modbus. Powered through KNX bus. DIN-rail mounting.

Functionalities:

- One Airzone system per KNX gateway.
- Full KNX.
- KNX standard data.
- Easily configurable from ETS.
- Zone control through KNX devices.
- Type of installation control.
- Communication errors detection.



AIRZONE CONSUMPTION METER (AZX6ACCCON)

Module that calculates and displays the energy consumption of single-phase HVAC units for Blueface thermostat and Airzone Cloud. Wireless communications. Externally powered at 230 Vac. Din rail mounted.

Functionalities:

- Calculation of energy consumption at the period of use.
- Calculation of the current energy consumption.
- Representation of daily, monthly and annual period chart at Airzone Cloud.
- Energy consumption comparison between different periods of time at Airzone Cloud.

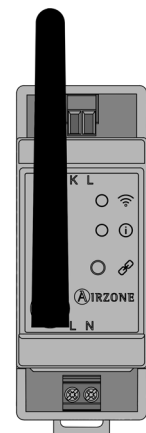

AIRZONE TEMPERATURE METALLIC PROBE IN SHEATH (AZX6SONDPROTEC)

Temperature probe in metal sheath.

Functionalities:

- Protection probe for return water (to boiler).
- Configurable as remote or distributed probe.



GENERAL REQUIREMENTS

Strictly follow the directions outlined in this manual:

- This system must be installed by a qualified technician.
- Verify that the units to be controlled have been installed according to the manufacturer's requirements and operate correctly before installing the Airzone System.
- Locate and connect all the devices of the installation in accordance with the electronic regulations in force.
- Verify that the air conditioning installation to be controlled is in accordance with the regulations in force.
- It is necessary to use a Blueface Thermostat to have all the features of the Airzone system.
- Follow these recommendations to locate the thermostats:

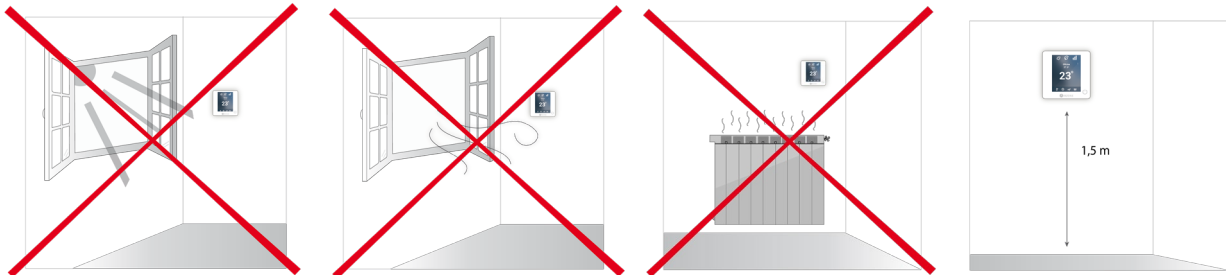

- Perform all the connections with total absence of power supply.
- In order to connect the elements of the system, use a proper cable: shielded twisted pair cable formed by 4 wires: $2 \times 0,22 \text{ mm}^2 + 2 \times 0,5 \text{ mm}^2$.
- Do not place the system bus close to lines of force, fluorescent lights, LED lamps, motors, etc. It might cause interference on the communications.

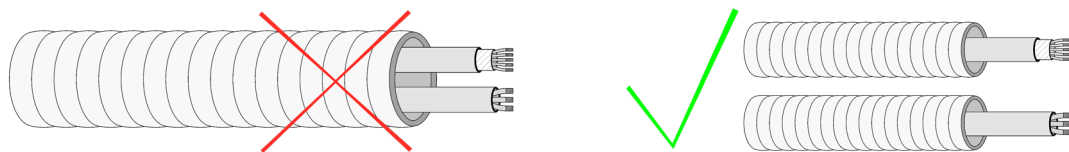

- Respect the connection polarity of each device. A wrong connection may seriously damage the product.
- For elements externally powered at 110 /230 Vac, for the communications, it is only necessary to connect the poles "A" and "B" of the bus.
- For elements externally powered at 110/230 Vac, respect the connection polarity. A wrong grounding may produce electric shocks.
- According to the current local and national regulations, it is mandatory to add a switch (or other element to disconnect the system) to the external supply wiring so that a constant separation between poles is guaranteed. The system will restart automatically if the supply is eventually turned off. **Use an independent circuit from the controlled system for the power supply.**
- Once the Airzone system is configured, verify that the static pressure of the duct system complies with the air distribution network conditions where is installed (check the Manufacturer's Manual of the equipment if you need to modify this parameter).

INTRODUCTION

Airzone systems enable the management of Master and Zone interfaces. Master thermostats enable mode management or define the efficiency level with the Eco-Adapt function.

It is recommended the use of a Blueface thermostat as Master Interface, this enables time schedule management and more unique functionalities.

Remember: *This system only admits one Master thermostat.*

To distinguish a Master Interface from a Zone Interface, check the next points:

- Blueface Master: Mode, Eco-Adapt and Speed* icons shown in white color.
- Blueface Zone: Mode, Eco-Adapt and Speed* icons shown in gray color.
- Think Master: Accessing the settings menu, Operation Mode and Speed* are available.
- Think Zone: Accessing the settings menu, Operation Mode and Speed* are unavailable.

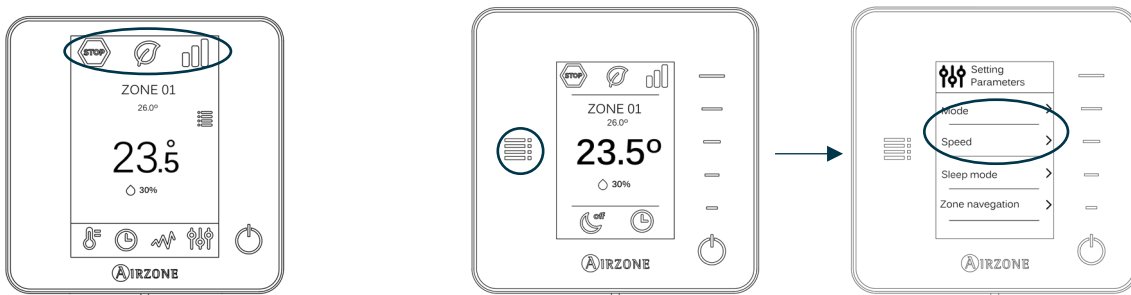

***Note:** *Only available on installations with Fancoil.*

SYSTEM INSTALLATION

Before the Airzone system commissioning, please check:

- The system is going to control works correctly without the Airzone system installed.
- In direct expansion unit systems, the indoor unit wired thermostat has been installed.

In order to install the system, carefully follow these steps:

- 1) **Connect all the necessary elements** (see section *Assembly and connection*)
 - Connect the actuators.
 - Connect the communication gateway.
 - Connect all the elements of the system (thermostats, modules, etc.).
 - Power the main board.
- 2) **Check all the assembly and the connection are correct** (see section *Assembly and connection evaluation*)
- 3) **Configure the system**
 - Configure all the thermostats (see sections *Initial configuration* and *Advanced settings*).

Access all our technical documents and the self-diagnosis section, check the most FAQs, certificates, watch our videos and read our declaration of conformity at:

myzone.airzone.es/products/

ASSEMBLY AND CONNECTION

MAIN CONTROL BOARD (AZCE6FLEXA3 / AZCE6IBPRO6)

Assembly

The production control board is supplied in a box to be screwed to the wall. It should be placed and mounted in accordance with the current electrotechnical regulations.

For the mounting of the main control board, follow the following steps:

- Locate the control board close to the unit to be controlled.
- Unscrew the cover securing the back part to the wall.
- Make all the connections and screw the cover again.

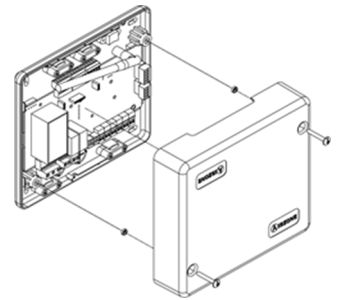

In Flexa 3.0 systems, it is possible to add a remote zone ON/OFF module to the main control board (AZCE6ONOFF6Z). To do this, insert the module in the corresponding connectors of the main board.

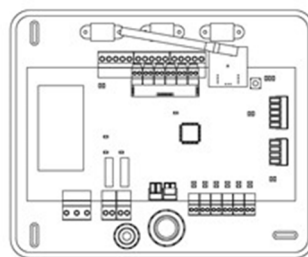

Connection

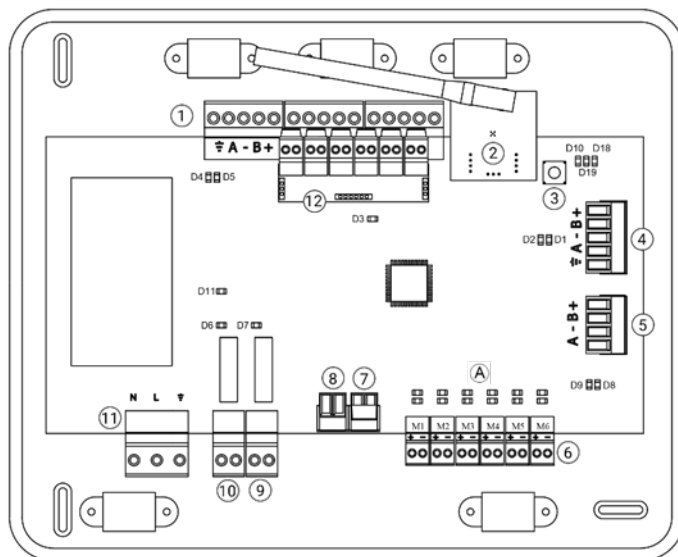

No.	Description
①	Airzone connection bus
②	Wireless Module
③	SW1
④	Automation bus
⑤	AC unit bus
⑥	Damper outputs
⑦	Alarm input (normally closed)
⑧	Temperature probe
⑨	CMV/Boiler
⑩	AC start-stop relay
⑪	Power
⑫	On/Off module (Only AZCE6IBPRO6)

Airzone connection bus connectors

The Airzone connection bus allows you to connect all the internal components dependent on the main board to control up to 6 zones (or 8 with the expansion module AZCE6EXP8Z). These are the elements that can be connected:

- Blueface (AZCE6BLUEFACEC), Think (AZCE6THINKC) and Lite (AZCE6LITEC) thermostats.
- Airzone Control module of radiant elements (AZC3POUTPUTC6).
- Expansion module (AZCE6EXP8Z).

If using a wired thermostat, connect it in one of the 3 Airzone connection bus terminals. The connection can be both a Bus connection or a star connection. Use (2x0.5+2x0.22 mm²) Airzone wire. For added security, secure the wires using the turrets.

Important: For elements externally powered at 110/230 Vac, for their communications, it is only necessary to connect the poles "A" and "B" of the bus. Use the shield only on the connector of the main control board.

In case of wireless element, check it has the battery on.

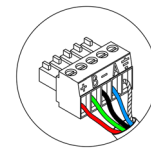

A	Blue
-	Black
B	Green
+	Red
Shield	Shield

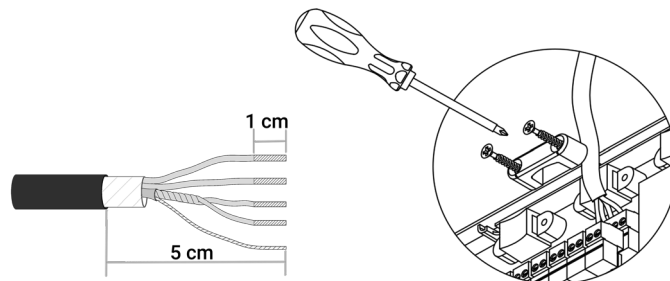

SW1

The main control board can also connect to Airzone wireless elements. These elements are associated by opening the wireless association module of the main control board. Press on SW1 and wait for the LED 19 to remain red. The wireless association module will be open during 15 minutes.

Reset system: If you want to return to factory values, press and hold on SW1 until LED D19 stops blinking.

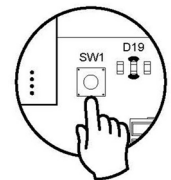

Domotic bus connector

The domotic bus allows you to interconnect multiple systems in order to control them through Airzone control peripherals or to integrate them into a superior control network. These are the elements that can be connected:

- Airzone Webserver Cloud (AZX6WEBSCLLOUDC/AZX6WSC5GER).
- KNX integration gateway (AZXKNXGTWAY).
- Airzone-BACnet integration gateway (AZX6BACNET).
- Airzone-Lutron integration gateway (AZX6GTILUT).
- Production control board Airzone (AZX6CCP).
- Airzone Supermaster controller (AZX6CSMASTER [S-E])

It has a 5-pin terminal for the domotic bus connection. This system can only be connected by bus. Attach the wires with the terminal screws following the color code.

Note: For elements externally powered at 110/230 Vac, for the communications, it is only necessary to connect the poles "A", "B" and "Shield" of the communication bus. Use the shield only on the connector of the main control board.

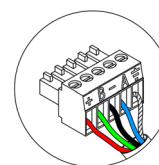

A	Blue
-	Black
B	Green
+	Red
Shield	Shield

AC unit bus connector

The AC unit bus allows you to connect different control gateway to the AC unit. These are the gateways that can be connected:

- Airzone controller 3.0 gateway (AZX6GTC xxx).
- Airzone Communication gateway (AZX6QADAPT xxx).
- Airzone 0-10 V Fancoil Control gateway (AZX6010VOLTSZ).
- Airzone Control Gateway – 3 speeds Fancoil (AZX6FANCOILZ).
- Electromechanical communication gateway (AZX6ELECTROMECH).

It has a 4-pin terminal to connect the AC unit bus. The connection for these elements is point-to-point. Attach the wires with the terminal screws following the color code.

Note: For elements externally powered at 110/230 Vac, for the communications, it is only necessary to connect the poles "A", "B" and "Shield" of the communication bus. Use the shield only on the connector of the main control board.

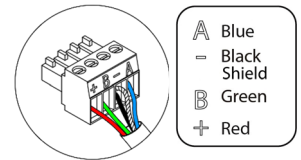

To connect integrated gateways, disconnect the AC unit bus terminal and insert the connector and the fixing post of the gateway.

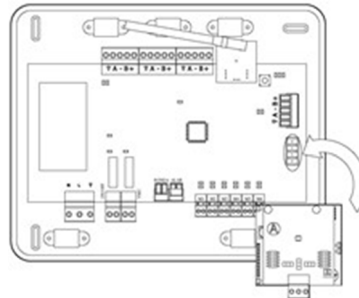

Actuator outputs

12-V actuator outputs allow you to connect Airzone motorized elements and manage them from the main control board (up to 8 actuators per board, up to 2 engines per output).

There are 6 two-pin terminals available to connect the motorized dampers. Attach the wires with the terminal screws following the color code.

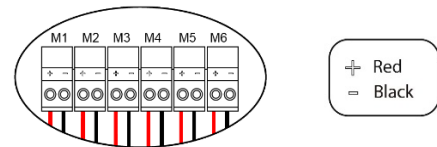

Alarm input

This input closes all the dampers and imposes Stop mode when there is an alert. This input is configured as normally closed. For proper operation of the system, this contact is supplied with a bonding jumper.

Temperature probe connector

It measures the outdoor temperature through an external probe. We recommend the use of this probe when using electromechanical units or NON-Inverter units (when it is necessary to control the return temperature of the units).

CMV/Boiler connector

This output can be configured as controlled mechanical ventilation control or boiler control. (See *Blueface Advanced Configuration Menu, system parameters*)

CMV configuration

Status	Stop	Ventilation	Cooling	Air heating	Heating radiant
Demand ON	CMV OFF	CMV ON	CMV ON	CMV ON	CMV ON
Demand OFF	CMV OFF	CMV ON	CMV ON	CMV ON	CMV ON

Boiler configuration

Status	Stop	Ventilation	Cooling	Air heating	Heating radiant
Demand ON	BOIL. OFF	BOIL. OFF	BOIL. OFF	BOIL. OFF	BOIL. ON
Demand OFF	BOIL. OFF	BOIL. OFF	BOIL. OFF	BOIL. OFF	BOIL. OFF

Relay specs: $I_{max} = 1$ A at 24/48 Vac, voltage-free. Note that to control elements with a greater power, it is recommended to use contactors in accordance with the power required.

AC Start-stop relay

This output is developed to start-stop AC units. Logic of operation of the output:

Status	Stop	Ventilation	Cooling	Air heating	Heating radiant
Demand ON	AC UNIT OFF	AC UNIT ON	AC UNIT ON	AC UNIT ON	AC UNIT OFF
Demand OFF	AC UNIT OFF	AC UNIT OFF	AC UNIT OFF	AC UNIT OFF	AC UNIT OFF

Relay specs: $I_{max} = 1 \text{ A}$ at 24-48 Vac, voltage-free. Note that to control elements with a greater power, it is recommended to use contactors in accordance with the power required.

Power supply connector

This connector powers the main control board and all the elements connected to it. Externally powered at 110/110/230 Vac. It is connected through a 3-pin terminal. Attach the wires with the terminal screws following the color code.

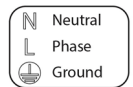
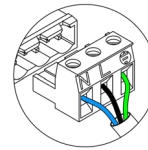

For added security, secure the wires using the turret.

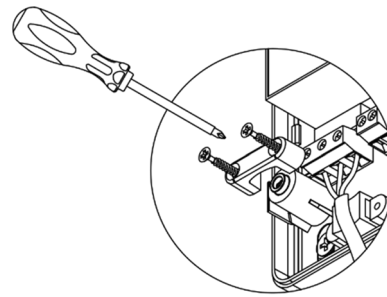
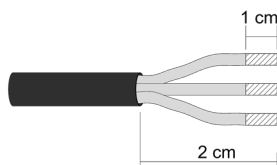

According to the current local and national regulations, it is mandatory to add a switch (or other element to disconnect the system) to the external supply wiring so that a constant separation between poles is guaranteed. The system will restart automatically if the supply is eventually turned off. **Use an independent circuit from the controlled system for the power supply.**

Remember: Once all the connections are made, make sure you replace the cover properly.

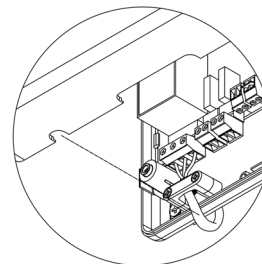
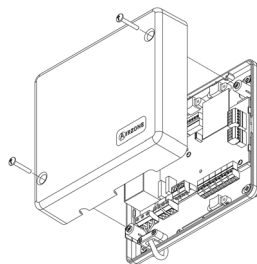

On/Off module

These connectors switch on/off the zone using a voltage-free mechanical component. It is a Plug&Play module; it just has to be connected and then recognized by the system to start operating. The logic of operation is normally closed.

For a proper operation, it is supplied with a bonding jumper.

Important: Use a shielded cable to control the inputs of the module.

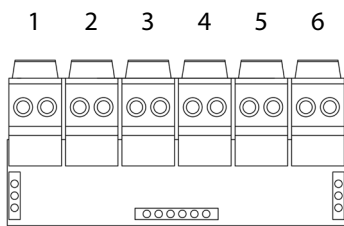

No.	Meaning
1	ON-OFF contact - Zone 1
2	ON-OFF contact - Zone 2
3	ON-OFF contact - Zone 3
4	ON-OFF contact - Zone 4
5	ON-OFF contact - Zone 5
6	ON-OFF contact - Zone 6

Note: When you open the contact of a zone, all the elements controlled in the zone close and the thermostat indicates there is an open input.

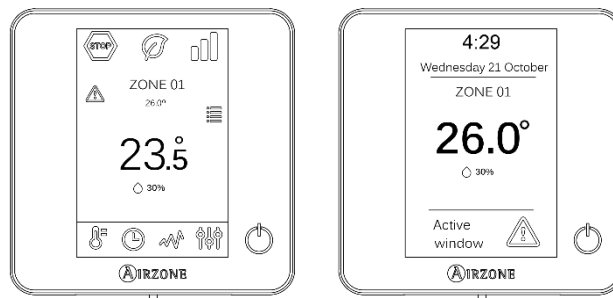

AIRZONE EXPANSION MODULE OF 2 ZONES (7 AND 8) (AZCE6EXP8Z)

Connection

The expansion module is integrated into the Airzone connection bus of the main board. It has 3 4-pin terminals, disconnect one of the terminals and fit in the module connector.

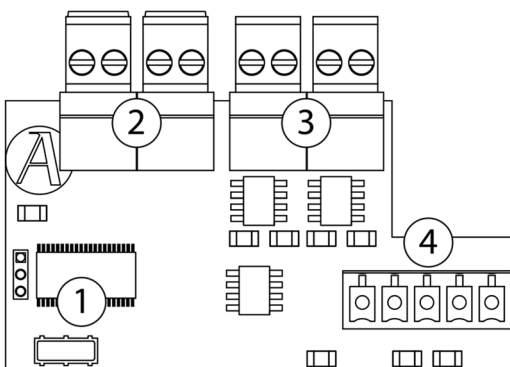

No.	Description
1	Microcontroller
2	Window contact
3	Actuator outputs
4	Airzone connection bus

3

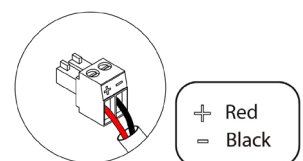

+ Red
- Black

AIRZONE CONTROL MODULE OF RADIANT ELEMENTS (AZCE6OUTPUT8)

Assembly

This module is mounted on DIN rail. It module is externally powered at 110/230 Vac. It is should be placed and mounted in accordance with the current electrotechnical regulations.

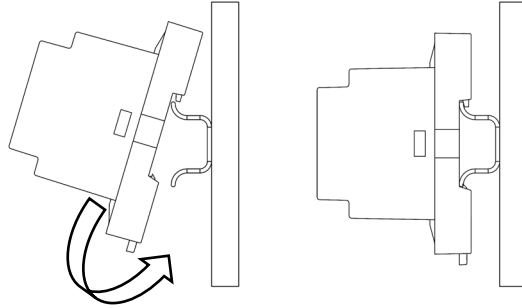

Note: To take the module away, pull the reed down to release it.

Connection

The control module of radiant elements is a device that connects to the Airzone connection bus of the main board. Control relay specs: $I_{max} = 10\text{ A}$ at 110/230 Vac, voltage-free.

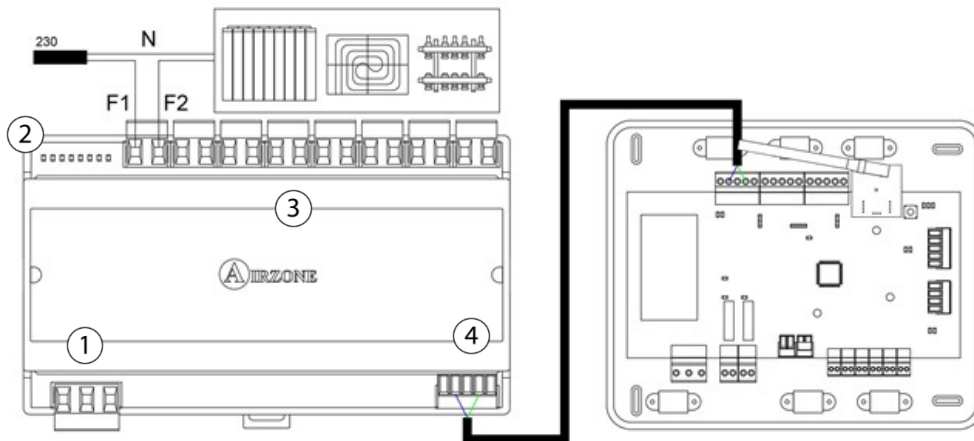

No.	Meaning
①	Power supply
②	LEDs of relay state
③	Zone relays
④	Airzone connection bus

Note that to control elements with a greater power, it is recommended to use contactors in accordance with the power required. Remember to connect the neutral connector directly from the circuit to the element to be controlled.

Operation of the relays:

No.	Meaning
O1	Radiant element demand - Zone 1
O2	Radiant element demand - Zone 2
O3	Radiant element demand - Zone 3
O4	Radiant element demand - Zone 4
O5	Radiant element demand - Zone 5
O6	Radiant element demand - Zone 6
O7	Radiant element demand - Zone 7
O8	Radiant element demand - Zone 8

④

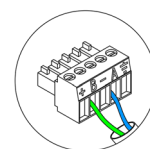

A Blue
B Green

It is connected to the module through a 3-pin terminal ①. Attach the wires with the terminal screws following the color code (0).

Once powered, the control module of radiant elements performs a sequential opening-closing of all relay outputs. This operation is repeated once a week to ensure the correct operation of the valves.

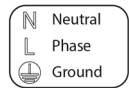
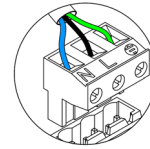

According to the current local and national regulations, it is mandatory to add a switch (or other element to disconnect the system) to the external supply wiring so that a constant separation between poles is guaranteed. The system will restart automatically if the supply is eventually turned off. **Use an independent circuit from the controlled system for the power supply.**

WIRED AIRZONE THERMOSTATS (AZCE6BLUEFACEC / AZCE6THINKC / AZCE6LITEC)

Assembly

Wired thermostats are mounted on the wall through a support. It is recommended not to locate it more than 40 meters away from the main control board. To fix it to the wall, follow these steps:

- Separate the back part of the thermostat from the wall support and make all the connections.
- Fix the back part of the thermostat to the wall.
- Place the display on the support once it is fixed.
- Place the anti-theft rods for additional support (optional).
-

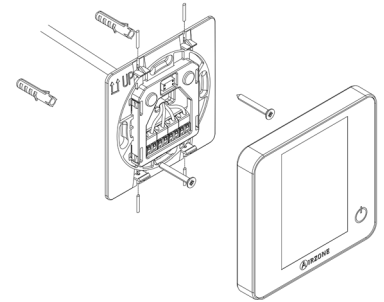

Connection

The Airzone thermostats are connected to the Airzone connection bus of the main board. Attach the wires with the terminal screws following the color code.

Important: Use provided tool to press in the locking tabs.

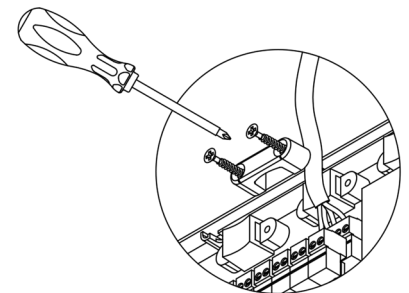
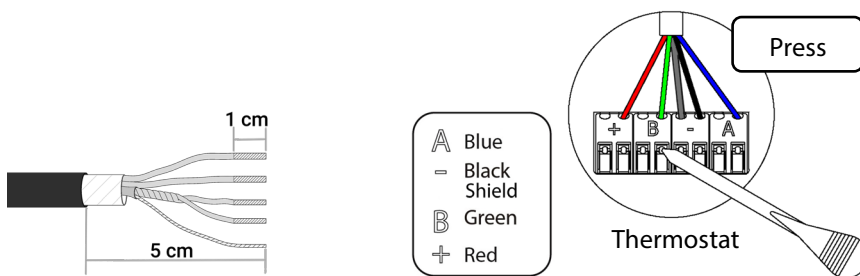
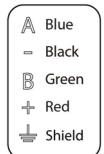
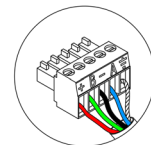

WIRELESS AIRZONE THERMOSTATS (AZCE6THINKR / AZCE6LITER)

Assembly

Wireless thermostats are mounted on the wall through a support. It is recommended not to locate it more than 40 meters away from the main control board.

To fix it to the wall, follow these steps:

- Remove the back of the thermostat and insert the CR2450 button battery.
- Fix the back part of the thermostat to the wall.
- Place the display on the support once it is fixed.
- Place the anti-theft rods for additional support.

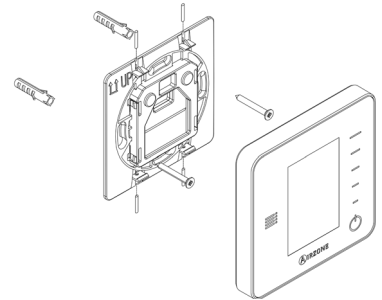

Changing batteries

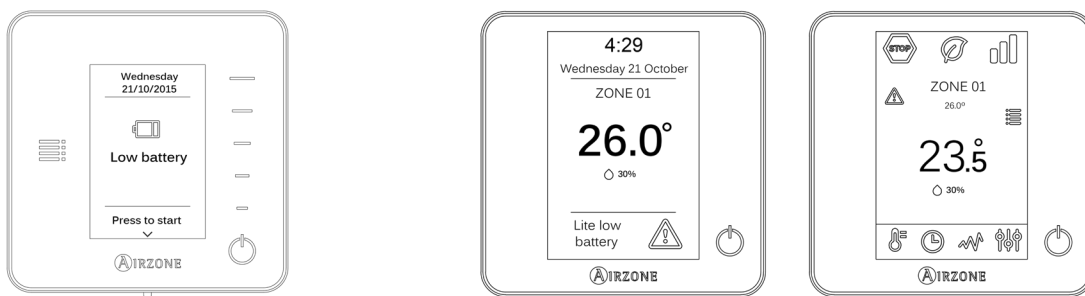

To replace the battery, separate the thermostat from its support and replace the battery (CR2450).

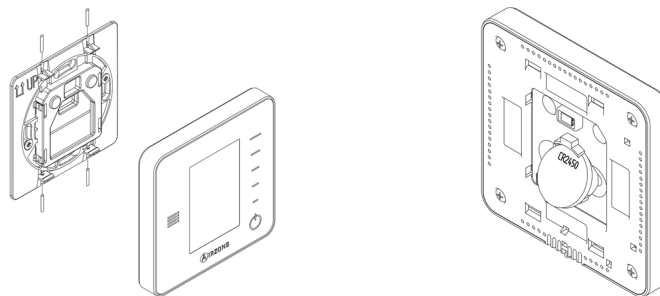

Important: We recommend using of top-brand batteries. Using low-quality batteries may reduce the duration of use. Remember to deposit the old battery into an appropriate recycling point.

Note: Do not forget to remove the security system before taking away the thermostat from the wall.

0-10 V FANCOIL CONTROL GATEWAY (AZX6010VOLTSZ)

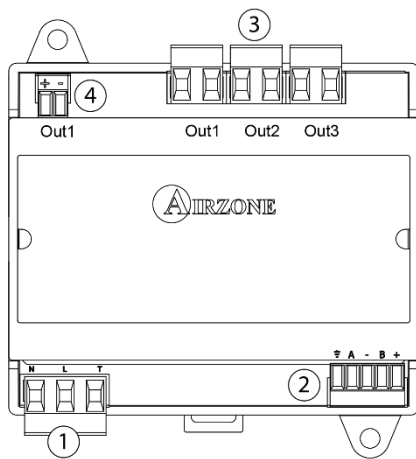

Meaning		
①	Power supply	
②	AC unit bus	
③	OUT 1	Cooling air demand
	OUT 2	Heating air demand
	OUT 3	Fan demand
④	Fan control	

Assembly

Fancoil control gateway can be mounted on DIN rail or on wall. This module is externally powered at 110/230 Vac. It should be placed and mounted in accordance with the current electrotechnical regulations.

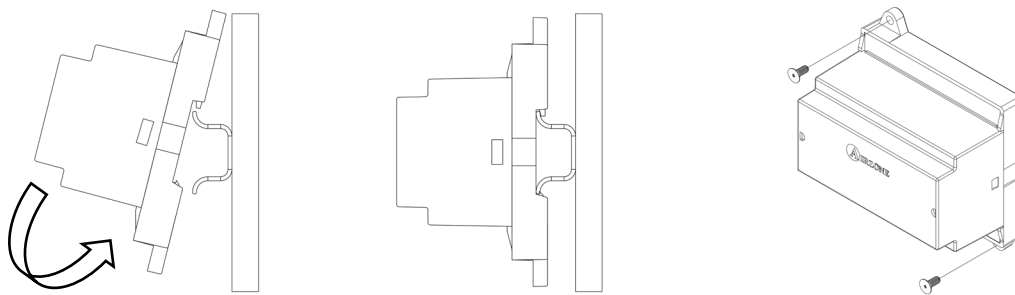

Note: To remove the module on DIN rail, pull the tab down to release it.

Connection

The 0-10 V gateway is connected to the AC unit bus of the main board.

Connection diagram, 2-pipe installation

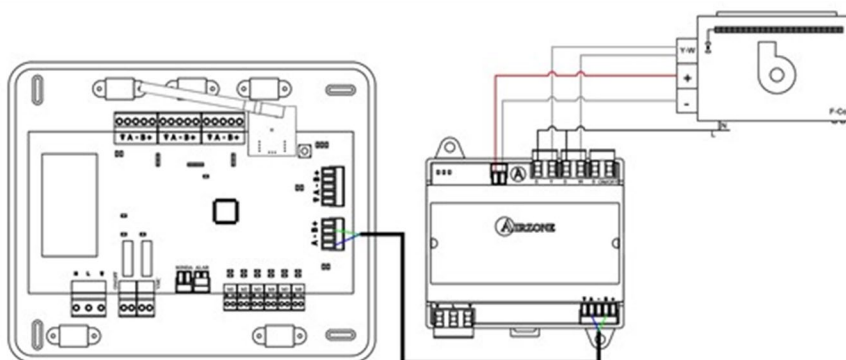

Connection diagram, 4-pipe installation

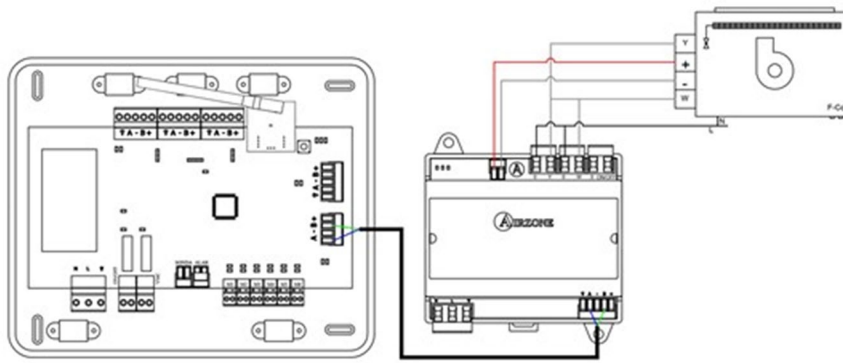

Control relay specs: $I_{max} = 10 \text{ A}$ at 110/230 Vac, voltage-free. Note that to control elements with a greater power, it is recommended to use contactors in accordance with the power required.

It has a 5-pin terminal to connect it to the AC unit bus of the main board ②. Attach the wires with the terminal screws following the color code. Use the shield only on the connector of the main control board.

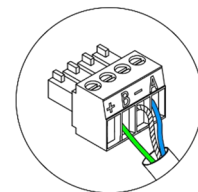

- A Blue
- B Green
- Shield

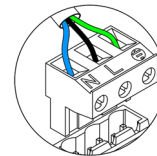

- N Neutral
- L Phase
- Ground

①



According to the current local and national regulations, it is mandatory to add a switch (or other element to disconnect the system) to the external supply wiring so that a constant separation between poles is guaranteed. The system will restart automatically if the supply is eventually turned off. **Use an independent circuit from the controlled system for the power supply.**

AIRZONE CONTROL GATEWAY-3 SPEEDS FANCOIL (AZX6FANCOILZ)

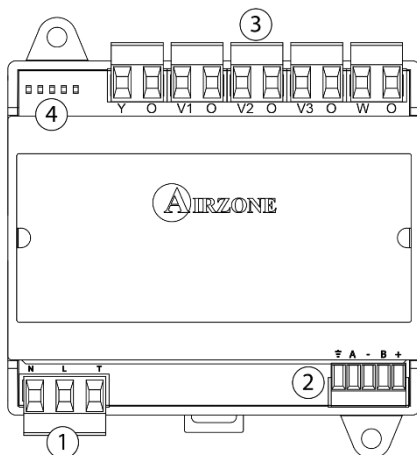

No.	Description	
①	Power supply	
②	AC unit bus	
③	Y-O	Cooling air demand
	V1-O	Speed 1
	V2-O	Speed 2
	V3-O	Speed 3
④	W-O	Heating air demand
	Status LEDs	

Assembly

Airzone control gateway-3 speeds fancoil is mounted on DIN rail or on wall. This module is externally powered at 110/230 Vac. It should be placed and mounted in accordance with the current electrotechnical regulations.

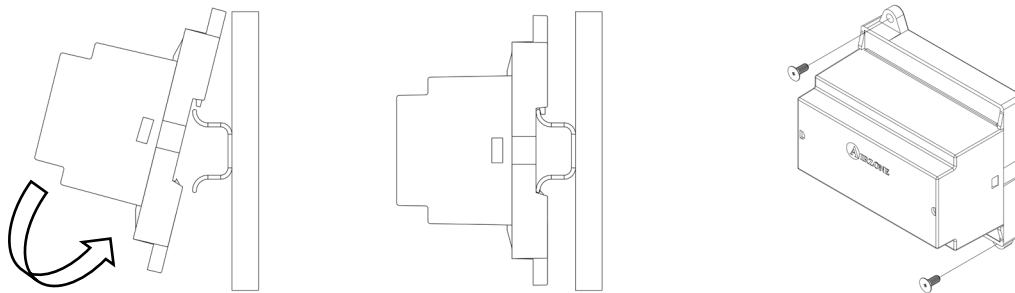

Note: To remove the module on DIN rail, pull the tab down to release it.

Connection

Fancoil control gateway is connected to the AC unit bus of the main board.

Connection diagram, 2-pipe installation

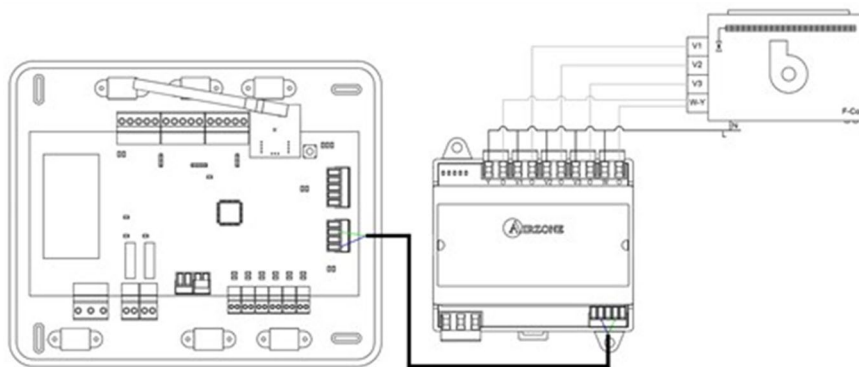

Connection diagram, 4-pipe installation

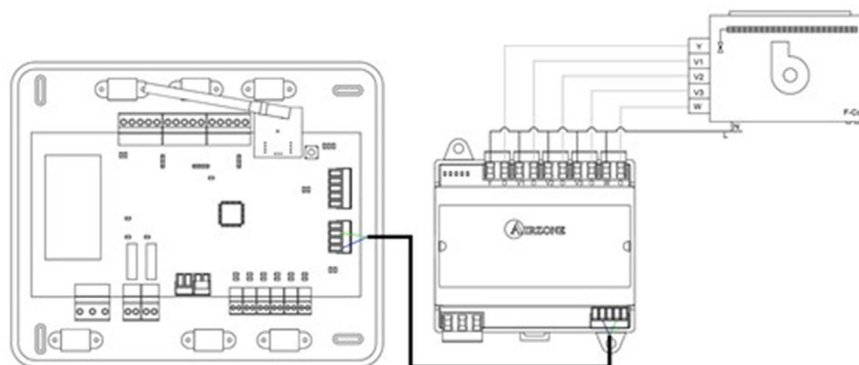

Control relay specs: $I_{max} = 10 \text{ A}$ at 110/230 Vac, voltage-free. Note that to control elements with a greater power, it is recommended to use contactors in accordance with the power required.

②

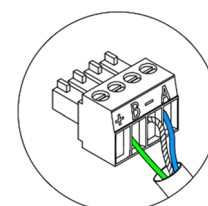

- A Blue
- B Green
- Shield

It is connected to the module through a 3-pin terminal ①. Attach the wires with the terminal screws following the color code.

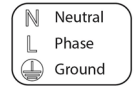
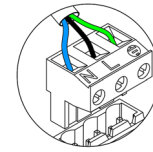

According to the current local and national regulations, it is mandatory to add a switch (or other element to disconnect the system) to the external supply wiring so that a constant separation between poles is guaranteed. The system will restart automatically if the supply is eventually turned off. **Use an independent circuit from the controlled system for the power supply.**

CONTROL GATEWAY FOR ELECTROMECHANICAL UNITS (AZX6ELECTROMECH)

Assembly

The electromechanical control gateway is mounted on DIN rail or on wall. This module is integrated into the AC unit bus of the main board. It has a 4-pin terminal. Disconnect the terminal to which you want to connect to the module and fit the connector. It should be placed and mounted in accordance with the current electrotechnical regulations.

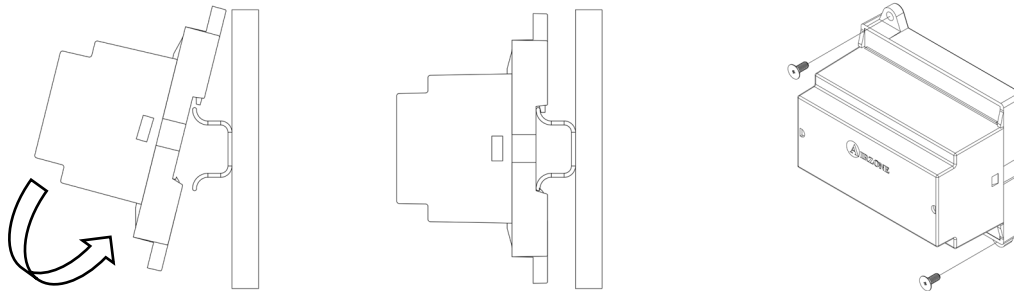

Note: To remove the module on DIN rail, pull the tab down to release it.

Connection

The electromechanical control gateway connects to the AC unit bus of the main board.

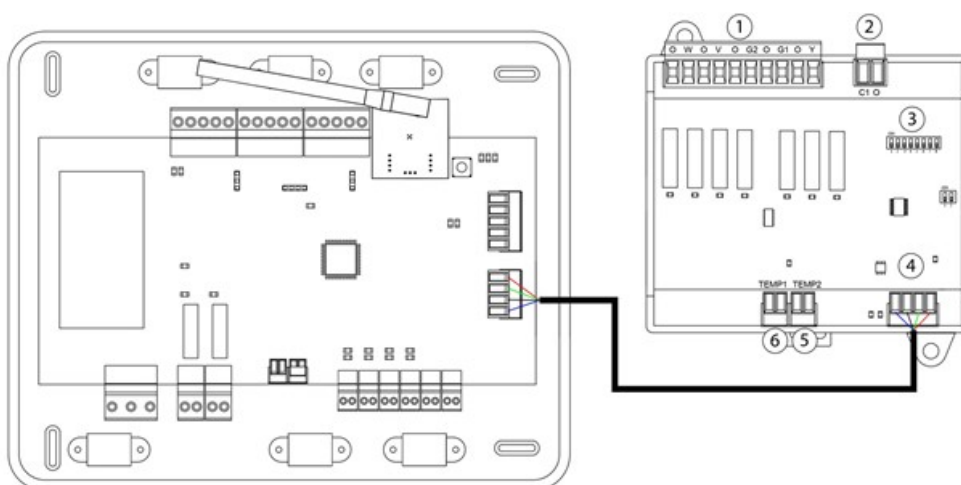

Meaning		
①	O-W	Heating mode
	O-V	Fan mode
	O-G2	Compressor 2
	O-G1	Compressor 1
	O-Y	Cooling mode
②	C1-O	Boiler
③		Microswitch
④		AC unit bus
⑤		Boiler probe
⑥		AC unit probe

Control relay specs: 24/48 Vac (voltage-free). Note that to control elements with a greater power, it is recommended to use contactors in accordance with the power required.

The operation logic of the microswitch is as follows:

Meaning		
	Start-up time of the compressor	ON: 4 min OFF: 10 seconds
	Continuous ventilation	ON: Always On unless in Stop mode OFF: Only if there is demand
	AC unit of 1 or 2 stages	ON: 2 stages OFF: 1 stage

The operation logic of the relays is as follows:

Air conditioning	Demand	O-W	O-V	O-G2	O-G1	O-Y	C1-O
Stop	-	--	--	--	--	--	--
Ventilation	Yes	--	ON	--	--	--	--
	No	--	--	--	--	--	--
Cooling Air (1 stage)	Yes	--	ON	--	ON*	ON	--
	No	--	--	--	--	ON	--
Cooling Air (2 stages)	If return T > 28°C	ON	ON	ON	ON	ON	--
	If return T < 28°C	ON	ON	--	ON*	ON	--
	No	ON	--	--	--	ON	--
Heating air (1 stage)	Yes	ON	ON	ON	ON*	--	--
	No	ON	--	--	--	--	--
Heating air (2 stages)	If return T < 18°C	ON	ON	ON	ON	--	--
	If return T > 18°C	ON	ON	--	ON*	--	--
	No	ON	--	--	--	--	--
Radiant heating	Yes	ON	--	--	--	--	--
	No	ON	--	--	--	--	--
Combined heating	Diff. > Z°C	ON	ON	ON	ON	--	ON
	Diff. < Z°C	ON	--	--	--	--	ON
	No	ON	--	--	--	--	--

***Note:** Alternative activation of the compressor outputs (O-G1 – O-G2).

It has a 4-pin terminal to connect it to the AC unit bus of the main board ^④. Attach the wires with the terminal screws following the color code.

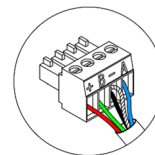

A	Blue
-	Black Shield
B	Green
12V	Red

WEBSERVER AIRZONE CLOUD WI-FI DUAL 2.4-5G (AZX6WSC5GER)

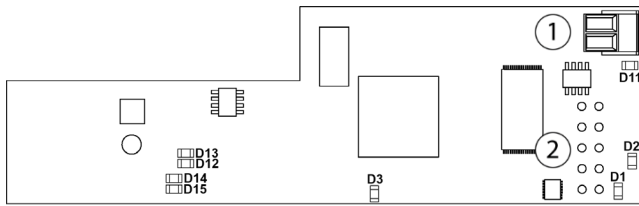

N°	Description
①	Automation bus output
②	Automation bus input



All Airzone systems must be connected to internet to offer technical support.

It is only necessary to connect **one Webserver Cloud per installation** (control of up to 32 systems).

Assembly

The Webserver is integrated into the automation bus of the Control board. It has a 5-pin terminal. Disconnect the terminal and fit the connector.

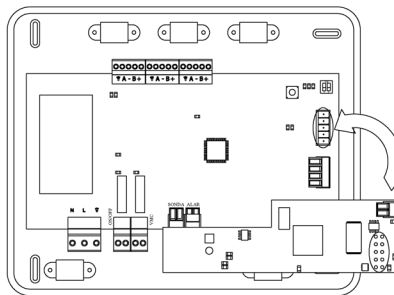

Connection

To connect with other system's main boards, use the 2-pin terminal to connect the Webserver Cloud to the automation bus of the main board. Use the proper cable: shielded twisted pair 2 wired: 2x0.22 mm² (AWG 24 – 2 wired). Attach the wires with the terminal screws following the color code.

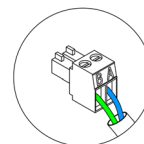

A Blue
B Green

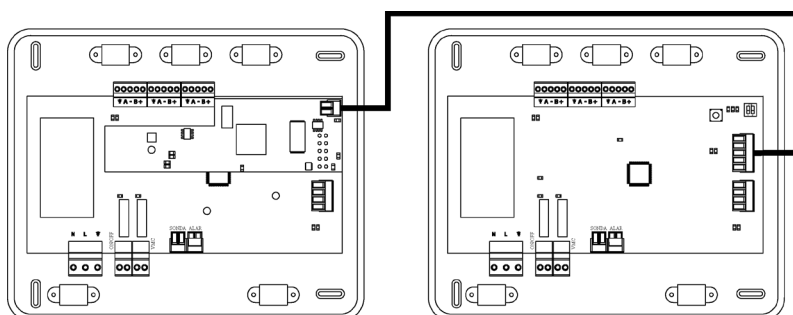

Note: For a proper operation of this module, all the control boards must be addressed (see section [Advanced Settings, System ID parameter](#)).

Configuration

To configure it, follow the steps described in the Airzone Cloud Webserver installation manual, available at [myzone.airzone.es \(https://doc.airzone.es/producto/Gama_AZ6/Airzone/Comunes/Manuales/MI_AZCLOUD_MUL.pdf\)](https://doc.airzone.es/producto/Gama_AZ6/Airzone/Comunes/Manuales/MI_AZCLOUD_MUL.pdf)

WEBSERVER HUB AIRZONE CLOUD DUAL (AZX6WSPHUB)

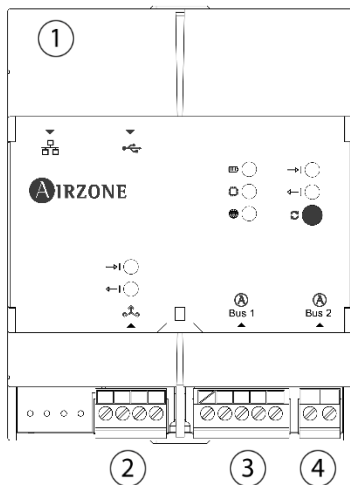

N°	Description
①	Ethernet
②	Modbus port
③	Airzone connection bus 1 – DM1
④	Airzone connection bus 2 – DM2

Assembly

The Webserver HUB is mounted on DIN rail or on wall. It should be placed and mounted in accordance with the current electrotechnical regulations.

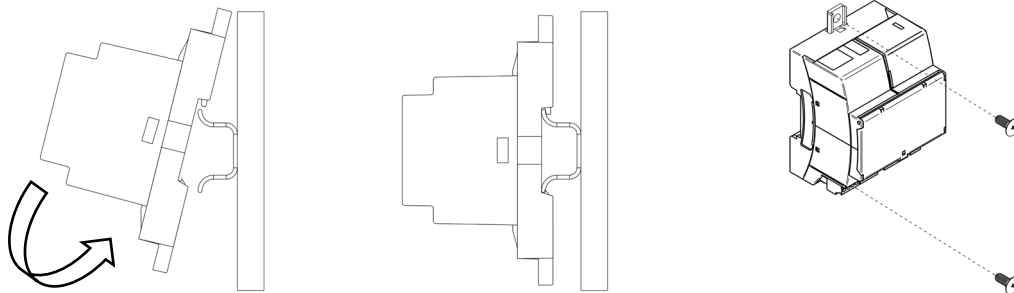

Note: To remove the module on DIN rail, pull the tab down to release it.

Connection

To connect with the first system main board, use the 5-pin terminal to connect the Webserver Cloud to the automation bus of the main board in order to provide power supply to the Webserver. Use the proper cable: shielded twisted pair 4 wired: $2 \times 0,22 \text{ mm}^2 + 2 \times 0,5 \text{ mm}^2$ (2 x AWG23 + 2 x AWG 20). Attach the wires with the terminal screws following the color code.

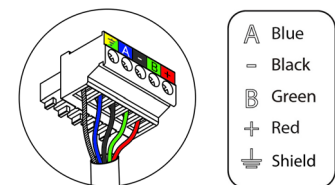

To connect with other system's main boards, use the 2-pin terminal to connect the Webserver Cloud to the automation bus of the other main boards. Use the proper cable: shielded twisted pair 2 wired: $2 \times 0,22 \text{ mm}^2$ (AWG 23 – 2 wired). Attach the wires with the terminal screws following the color code.

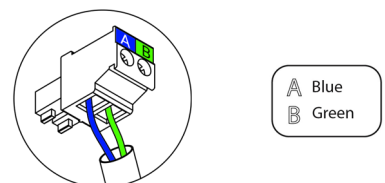

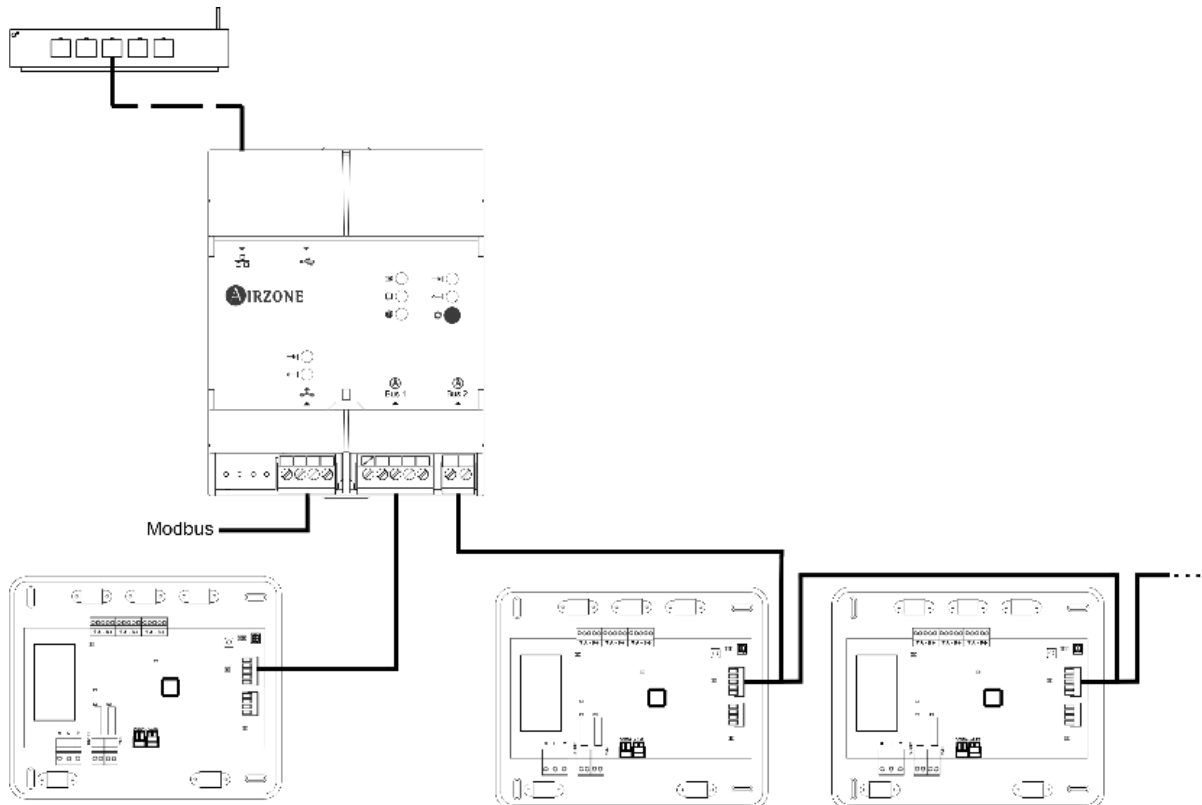

Configuration

To configure it, follow the steps described in the Airzone Cloud Webserver installation manual, available at [myzone.airzone.es \(https://doc.airzone.es/producto/Gama_AZ6/Airzone/Comunes/Manuales/MI_AZCLOUD_MUL.pdf\)](https://doc.airzone.es/producto/Gama_AZ6/Airzone/Comunes/Manuales/MI_AZCLOUD_MUL.pdf)

WEBSERVER HUB AIRZONE BACNET (AZX6WSPBAC)

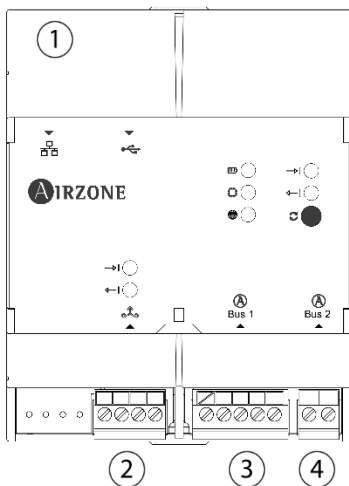

Nº	Description
①	Ethernet
②	Modbus port
③	Airzone connection bus 1 – DM1
④	Airzone connection bus 2 – DM2

Assembly

The Webserver HUB BACnet is mounted on DIN rail or on wall. It should be placed and mounted in accordance with the current electrotechnical regulations.

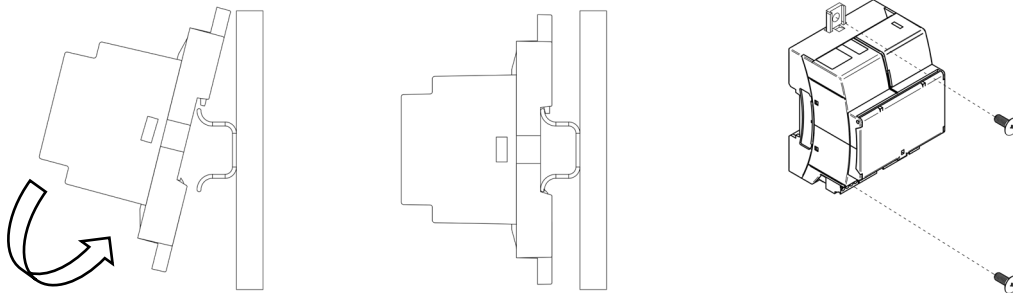

Note: To remove the module on DIN rail, pull the tab down to release it.

Connection

To connect with the first system main board, use the 5-pin terminal of the DM1 domotic bus. Use the proper cable: shielded twisted pair 4 wired: 2x0,22 mm² + 2x0,5 mm² (2 x AWG23 + 2 x AWG 20). Attach the wires with the terminal screws following the color code.

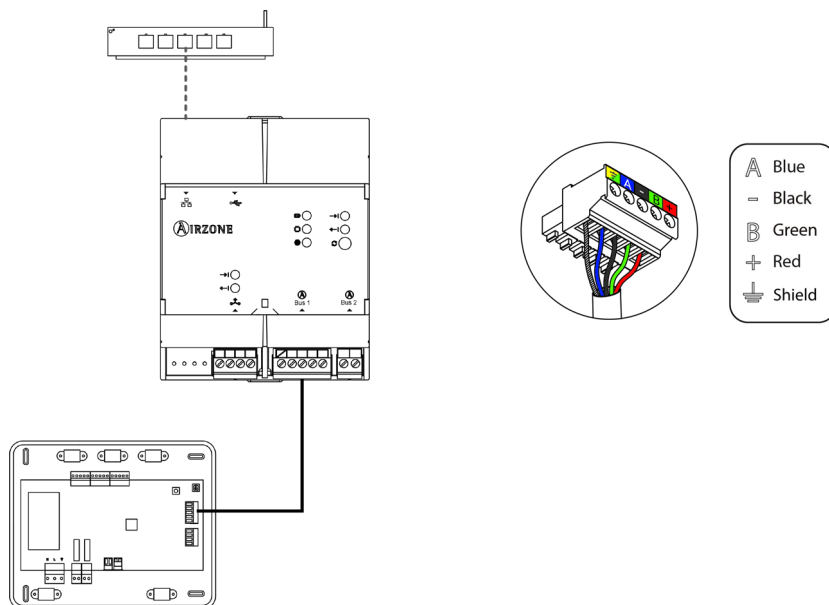

Configuration

To configure it, follow the steps described in the Airzone Cloud Webserver installation manual, available at myzone.airzone.es (http://doc.airzone.es/producto/Gama_AZ6/Airzone/Comunes/Manuales/MI_AZ6_BACNET_A4_EN.pdf)

WEBSERVER HUB AIRZONE-LUTRON (AZX6WSPLUT)

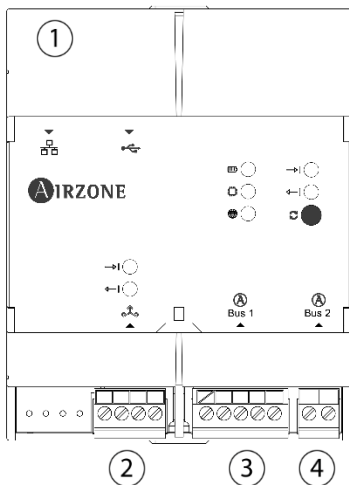

N°	Description
①	Ethernet
②	Modbus port
③	Airzone connection bus 1 – DM1
④	Airzone connection bus 2 – DM2

Assembly

The Webserver HUB Lutron is mounted on DIN rail or on wall. It should be placed and mounted in accordance with the current electrotechnical regulations.

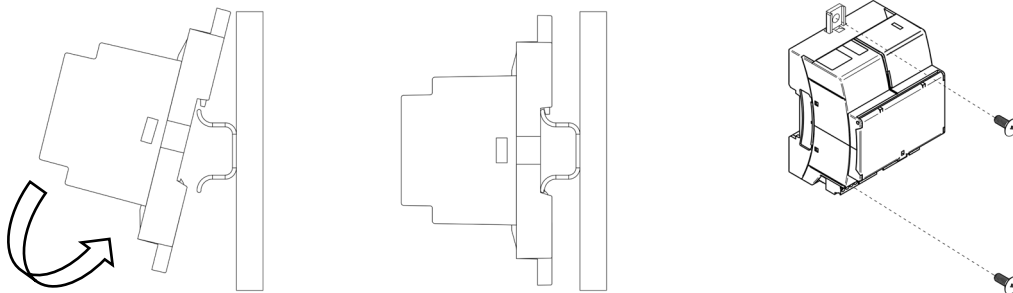

Note: To remove the module on DIN rail, pull the tab down to release it.

Connection

To connect with the first system main board, use the 5-pin terminal to connect the Webserver Cloud to the automation bus of the main board in order to provide power supply to the Webserver. Use the proper cable: shielded twisted pair 4 wired: $2 \times 0,22 \text{ mm}^2 + 2 \times 0,5 \text{ mm}^2$ (2 x AWG23 + 2 x AWG 20). Attach the wires with the terminal screws following the color code.

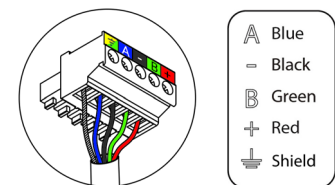

To connect with other system's main boards, use the 2-pin terminal to connect the Webserver HUB to the automation bus of the other main boards. Use the proper cable: shielded twisted pair 2 wired: $2 \times 0,22 \text{ mm}^2$ (AWG 23 – 2 wired). Attach the wires with the terminal screws following the color code.

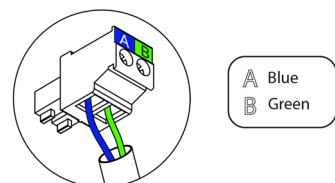

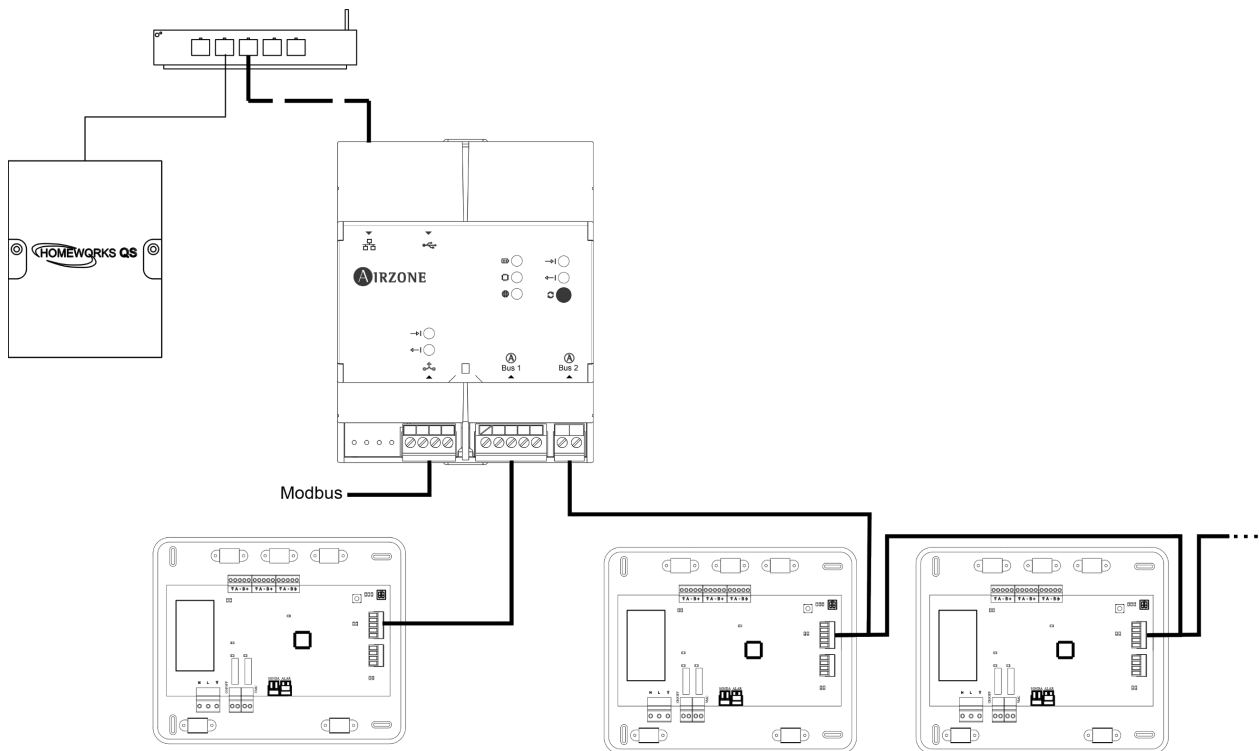

All Airzone systems must be connected to internet to offer technical support.

It is only necessary to connect **one Lutron integration gateway per installation** (control of up to 32 systems). All the system control boards must be correctly addressed.

Configuration

To configure it, follow the steps described in the Airzone Cloud Webserver installation manual, available at myzone.airzone.es (http://doc.airzone.es/producto/Gama_AZ6/Airzone/Comunes/Manuales/MI_AZ6_LUTRON_A4_EN.pdf)

AIRZONE SUPERMASTER CONTROLLER (AZX6CSMASTER [S/E] [B/G])

Important: This device is not compatible with the Production Control Board (AZX6CCP).

Assembly

Supermaster controllers can be mounted on wall (AZX6CSMASTERS) or wall-embedded (AZX6CSMASTERE).

Wall mounting

- Separate the back part of the thermostat from the wall support.
- Fix the support directly to the wall or using a patters.
- Put the back part of the controller on the support (once it is fixed) passing the cable through the hole. Make sure that the back part is fixed by the tabs. Make all the connections.
- Place the display on back part.

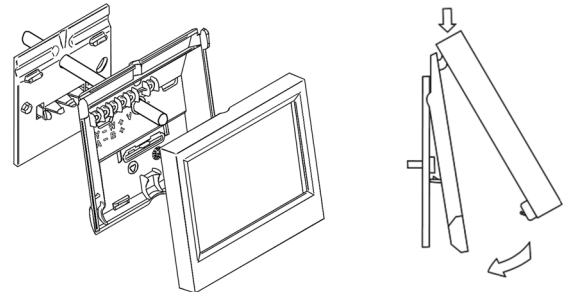

Embedded mounting

Embedded Supermaster thermostats are supplied in 100x100 junction boxes. Compatible junction boxes:

- Solera 362 (100x100 mm)
- Jangar 2174 (100x100 mm)
- IDE CT110 (100x100 mm)
- Fematel Ct35 (100x100 mm)

For a perfect mounting, follow these steps:

- Remove the sub-frame of the display from the rest of the assembly and make the connections.
- Use the washers and screws to secure the display into the patters.
- Place the sub-frame again. Make sure it is fixed properly.

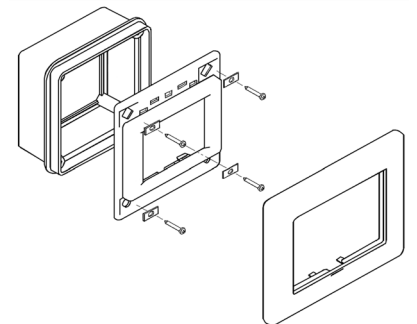

Connection

The Supermaster controller connects to the domotic bus of the main control board.

For wall-mounted thermostats, use the tabs located on the back of the thermostats. Attach the wires with the tab screws following the color code.

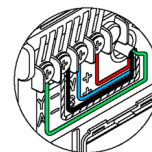

A	Blue
-	Black Shield
B	Green
+	Red

Wall-embedded Supermasters have a 5-pin terminal located on their back part. Attach the wires with the terminal screws following the color code.

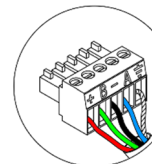

A	Blue
-	Black
B	Green
+	Red
⏏	Shield

Note: To configure it, follow the steps described in the user's manual, available at myzone.airzone.es/productos.

(http://doc.airzone.es/producto/Gama_AZ6/Airzone/Comunes/Manuales/MU_AZ6_SMAESTRO_A4_MUL.pdf)

Note: For a proper operation of this module, all the main control boards must be addressed (see section Advanced settings).

AIRZONE HYDRONIC PRODUCTION CONTROL BOARD (AZX6CCPGAWI)

Assembly

The production control board is supplied to be screwed to the wall. It should be placed and mounted in accordance with the current electrotechnical regulations. For the mounting of the main control board, follow the following steps:

- Locate the control board close to the unit to be controlled.
- Unscrew the cover securing the back part to the wall.
- Make all the connections and screw the cover again.

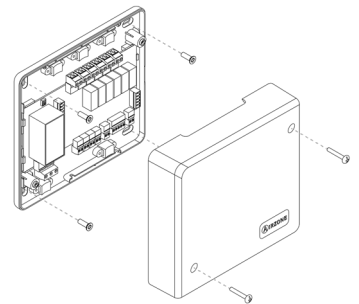

Connection

Production control board is connected to the AC unit bus of the main board.

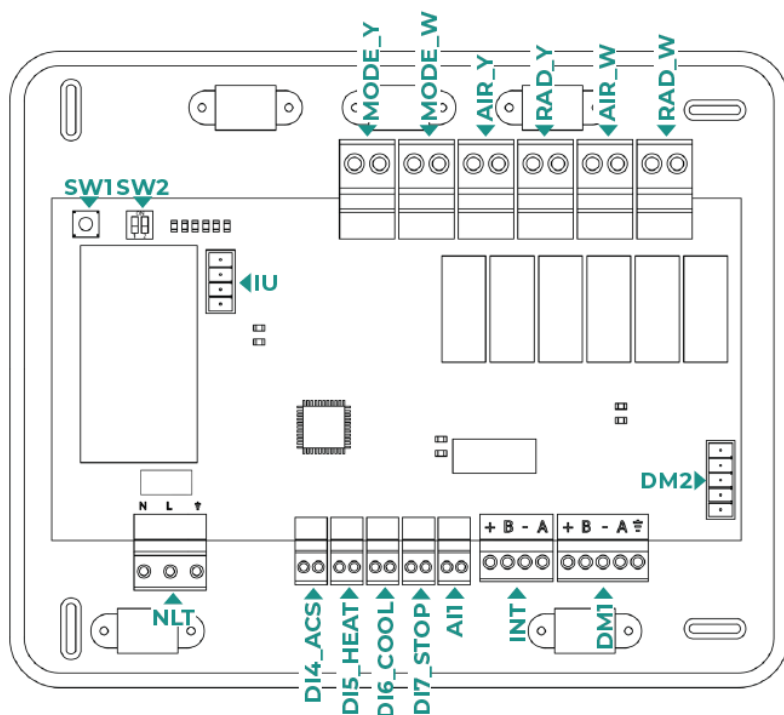

N°	Description
NLT	Power supply
DI4_ACS	Deactivates the air conditioning through AC unit during DHW production
DI5_HEAT	Sets the heating semiforced mode
DI6_COOL	Sets the cooling semiforced mode
DI7_STOP	Imposes the Stop mode in the system
AI1	Reserved for internal use
INT	Integration bus output
DM1/DM2	Domotic bus outputs
IU	Air to water domotic bus output
MODE_Y	Cooling mode
MODE_W	Heating mode
AIR_Y	Cooling air demand
RAD_Y	Cooling radiant demand
AIR_W	Heating air demand
RAD_W	Heating radiant demand
SW1	Systems search
SW2	Configuration

Power supply connector

This connector powers the main control board and all the elements connected to it. Externally powered at 110/230 Vac. It is connected through a 3-pin terminal. Attach the wires with the terminal screws following the color code. For added security, secure the wires using the turret.

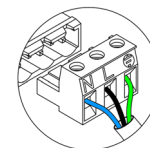

N Neutro | Neutral | Neutro
 L Fase | Phase | Fase
 T Tierra | Ground | Terra

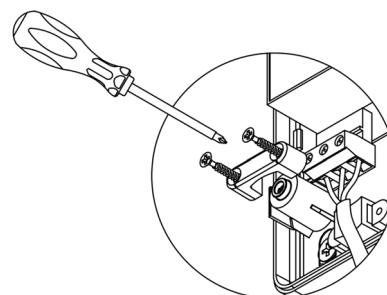
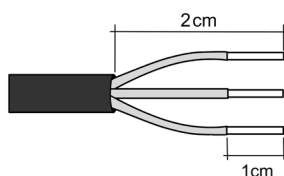

Important: According to the current local and national regulations, it is mandatory to add a switch (or other element to disconnect the system) to the external supply wiring so that a constant separation between poles is guaranteed. The system

will restart automatically if the supply is eventually turned off. **Use an independent circuit from the controlled system for the power supply.**

Remember: Once all the connections are made, make sure you replace the cover properly.

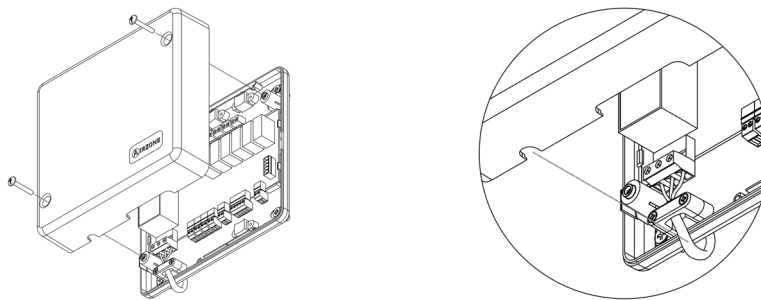

Digital inputs

The production control board has 4 digital inputs to externally control the Airzone systems. These input are configured as normally open. It is recommended to use a shielded cable to connect it.

- DI4_ACS: This input activates the DHW mode: all the Acuazone/Innobus Pro32 systems working on Air heat will stop and the message DHW will be displayed by the zone thermostats. This feature is recommended for Aerothermal installations when the Aerothermal unit starts producing DHW.
- DI5_HEAT: This input activates the semi-forced heating mode in all the system of the installation. These are the modes available to select: Stop, Heating and Ventilation.
- DI6_COOL: This input activates the semi-forced cooling mode in all the system of the installation. These are the modes available to select: Stop, Dry, Cooling and Ventilation.
- DI7_STOP: This input activates the Stop mode in all the system of the installation.
- AI1: Analog input reserved for internal use.

DM1 bus connector

The DM1 domotic bus allows the connection of system main control boards and the Webserver HUB Airzone Cloud Dual (AZX6WSPHUB).

It has two 5-pin terminals for the DM1 bus connection. This system can only be connected by bus. Remember that it is necessary to provide power supply through this port by connecting the 5-pins. Attach the wires with the terminal screws following the color code.

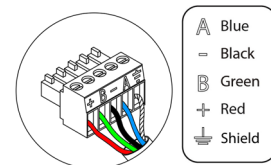

Note: For a proper operation of the main control board, all the main control board must be addressed (up to 32 systems).

DM2 domotic bus connector

The DM2 domotic bus allows the connection of control peripherals in order to manage all the systems connected to the production control board. These are the elements that can be connected:

- Webserver Airzone Cloud Wi-Fi Dual 2.4-5G (AZX6WSC5GER)
- Webserver Airzone Cloud Ethernet/WiFi (AZX6WEBSCLLOUD [C/R]).
- Webserver Airzone Cloud Carril Din Ethernet/WiFi (AZX6WSCLOUDDIN [C/R]).

It has a 5-pin terminal for the DM2 bus connection. This system can only be connected by bus. Attach the wires with the terminal screws following the color code.

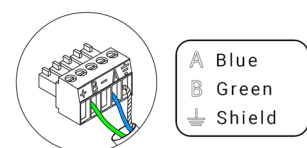

Note: Do not provide power supply in DM2 or IU ports. For externally powered elements at 110/230 Vac, it is only needed to connect "A" and "B" from the automation bus.

When connecting the Webserver Cloud (AZX6WSC5GER / AZX6WEBSCLLOUD [C/R]), remove the fixing post from the Webserver and put the connector in DM2.

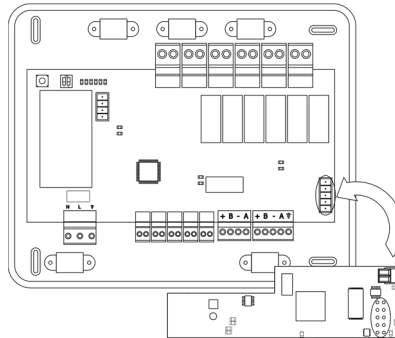

UI bus connector for Aerothermal gateway

The UI bus allows you to connect multiple gateways of for air-to-water equipment installed. These are the elements that can be connected:

- Airzone aerothermal gateway (AZX6GAW xxx).

In order to connect these gateways, disconnect the terminal of the UI bus and fit in the connector and the fixing post of the gateway.

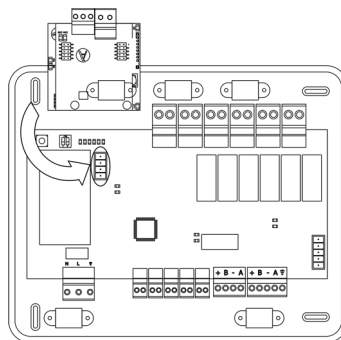

Control relays

This device has 6 relays for controlling the installation. The characteristics of the control relays are I_{max} of 10 A at 110/230 Vac (voltage-free. Note that to control elements with a greater power, it is recommended to use contactors in accordance with the power required.

Important: Remember to connect the neutral connector directly from the circuit to the element to be controlled.

Depending on the type of installation, the control relays will follow a different logic:

Aerothermal

Mode	Demand	Control Relays					
		MODE_Y	MODE_W	AIR_Y	RAD_Y	AIR_W	RAD_W
Stop	Off	--	--	--	--	--	--
Cooling mode	Air	ON	--	ON	--	--	--
	Radiant	ON	--	--	ON	--	--
	Off	--	--	--	--	--	--
Heating mode	Air	--	ON	--	--	ON	--
	Radiant	--	ON	--	--	--	ON
	Off	--	--	--	--	--	--
Dry	On	--	--	--	--	--	--
	Off	--	--	--	--	--	--
Ventilation	On	--	--	--	--	--	--
	Off	--	--	--	--	--	--

2 pipes / 3/ 4 pipes

Mode	Demand	Control Relays					
		MODE_Y	MODE_W	AIR_Y	RAD_Y	AIR_W	RAD_W
Stop	Off	--	--	--	--	--	--
Cooling mode	Air	ON	--	ON	--	--	--
	Radiant	ON	--	--	ON	--	--
	Off	ON	--	--	--	--	--
Heating mode	Air	--	ON	--	--	ON	--
	Radiant	--	ON	--	--	--	ON
	Off	--	ON	--	--	--	--
Heating mode	On	ON	--	--	--	--	--
	Off						
Ventilation	On	--	--	--	--	--	--
	Off						

RadianT

Mode	Demand	Control Relays					
		MODE_Y	MODE_W	AIR_Y	RAD_Y	AIR_W	RAD_W
Stop	Off	--	--	--	--	--	--
Cooling mode	Radiant	ON	--	--	ON	--	--
	Off	--	--	--	--	--	--
Heating mode	Radiant	--	ON	--	--	--	ON
	Off	--	--	--	--	--	--
Dew warning active	On	ON	--	ON	--	--	--
	Off	ON	--	ON	--	--	--

For Acuazone and Innobus Pro 32 systems versions v.4.4.1 or higher: In any configuration of the Acuazone central operating logic, zones with air flow stage configured as (Direct Expansion) DX will not generate air demand in the production control board. Remember that in both zoned or mixed configurations, when the air flow stage of a zoned area is modified, the same configuration will apply to the rest of the zones in the group.

Important: The following combinations will not generate air demand in the production control board:

- Communication gateway (AZX6QADAPTxxx / AZX6QADAPT3xxx / AZX6GTC xxx / AZX6ELECTROMECH) in Flexa 3.0, Innobus Pro6, Acuazone and Innobus Pro32 (v.4.4.0 or lower) main control boards.
- Gateway modules (AZDI6MCIFR [C/R] / AZDI6MCxxx [C/R] / AZDI6ZMOxxx [C/R]) in Acuazone e Innobus Pro32 (v.4.4.0 or lower) systems (when configured as a zoning system or mixed system).

Important: To guarantee the optimization of the production temperature of the aerothermal units, these device combinations do not generate demand to the production control board:

- Zoning module for Electrical Heating Element (AZDI6MZSRE [C/R]) in Acuazone and Innobus Pro32 systems regardless of the Main control board configuration.

SW1

Once all the main control boards have been addressed, you must save the configuration of the installation in the production control board. To do that, press SW1. If you make any changes in the installation, remember to save the new configuration.

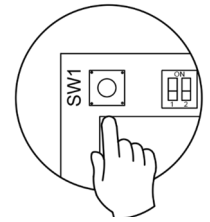

SW2

The microswitch SW2 sets the type of installation to control by the central production control. The operation logic of the microswitch is as follows:

Meaning			
Aerothermal	2 pipes	3/4 pipes	RadianT*

*Only for Airzone RadianT365 system (AZRA6).

Important: The control relays operation logic can be configured from SW2 or from the Production Parameters section on the advanced configuration menu. Configuration from the menu always has priority over SW2.

AIRZONE PRODUCTION CONTROL BOARD (AZX6CCP)

Assembly

The production control board is supplied in a patters that is screwed to Wall for a better fixing (4). It is should be placed and mounted in accordance with the current electrotechnical regulations. For the mounting of the main control board, follow the following steps:

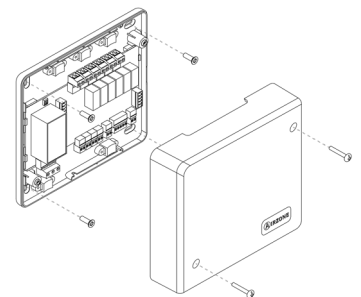

- Locate the production control board near the unit to control.
- Unscrew the cover securing the back part to the wall.
- Make all the connections and screw the cover again.

Connection

It connects to the domotic bus of the main control board.

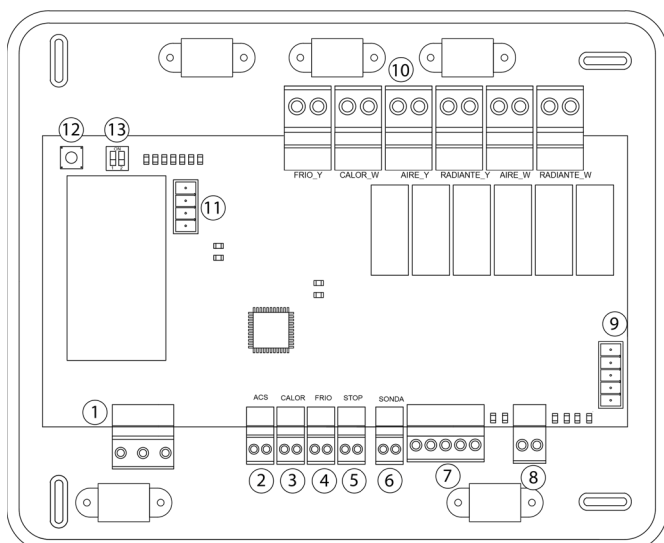

No.	Description		
1	Power		
2	Digital inputs		
...			
6			
7			External domotic bus 2
8	Internal domotic bus		
9	External domotic bus 1		
10	Control relays	FRIO_Y	Cooling mode
		CALOR_W	Heating mode
		AIRE_Y	Cooling air demand
		RADIANTE_Y	Cooling radiant demand
		AIRE_W	Heating air demand
		RADIANTE_W	Radiant heating demand
11	Aerothermal gateway bus		
12	SW1		
13	SW2		

Power supply connector

This connector powers the main control board and all the elements connected to it. Externally powered at 110/110/230 Vac. It is connected through a 3-pin terminal. Attach the wires with the terminal screws following the color code. For added security, secure the wires using the turret.

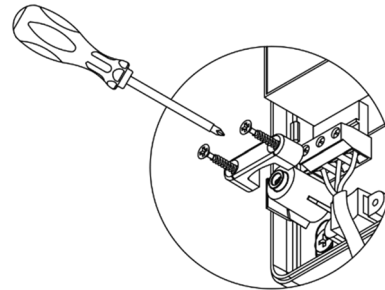
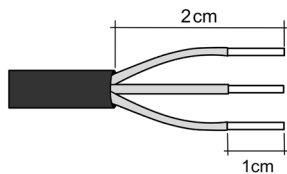
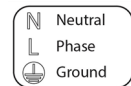
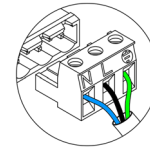

Important: According to the current local and national regulations, it is mandatory to add a switch (or other element to disconnect the system) to the external supply wiring so that a constant separation between poles is guaranteed. The system will restart automatically if the supply is eventually turned off.

Remember: Once all the connections are made, make sure you replace the cover properly.

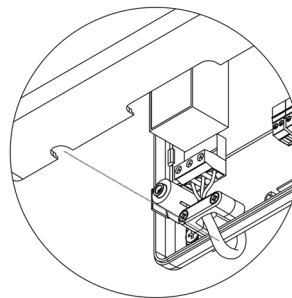
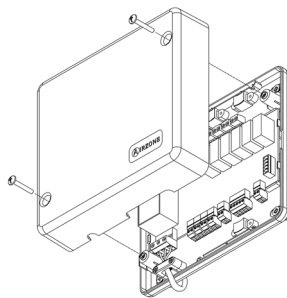

Digital inputs

The production control board you have 4 digital inputs to externally control the Airzone systems. These inputs are configured as normally open. It is recommended to use a shielded cable to connect it.

- ACS: This input activates the DHW mode: all the Acuazone/Innobus Pro32 systems working on Air heat will stop and the message ACS will be displayed by the zone thermostats. This feature is recommended for Aerothermal installations when the unit starts producing DHW.
- CALOR: This input activates the semi-forced heating mode in all the system of the installation. These are the modes available: Stop, Heating and Ventilation.
- FRIO: This input activates the semi-forced cooling mode in all the systems of the installation. These are the modes available: Stop, Dry, Cooling and Ventilation.
- STOP: This input activates the semi-forced cooling mode in all the systems of the installation.

The main control board has an analogical input for connecting a temperature probe to protect the boiler.

External domotic bus connector

The external domotic bus allows the connection of control peripherals in order to manage all the systems connected to the production control board. These are the elements that can be connected:

- Webserver Airzone Cloud Ethernet/Wifi (AZX6WEBSCLOUDC/AZX6WSC5GER). (External Domotic bus 1)
- KNX Integration gateway (AZX6KNXGTWAY).
- Webserver Airzone Cloud DIN Ethernet/Wifi (AZX6WSCLOUDDIN [C/R]).

It has two 5-pin terminals for connection of the domotic bus. This system can only be connected by bus. Attach the wires with the terminal screws following the color code.

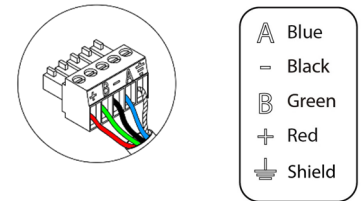

Note: For elements externally powered at 110/230 Vac, for the communications, it is only necessary to connect the poles "A" and "B" of the domotic bus.

When connecting the webserver Cloud (AZX6WEBSCLOUDC/AZX6WSC5GER), remove the fixing port from the Webserver and fit the connector into the external domotic bus 1.

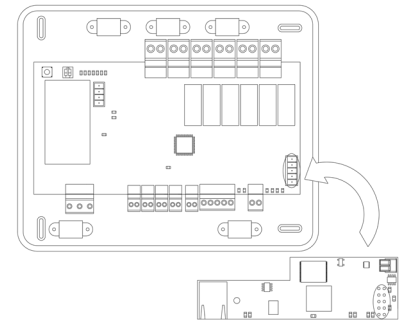

Indoor domotic bus connectors

The internal domotic bus allows you to interconnect the production control board to the main control board or mains control board. It has a 2-pin terminal for the domotic bus connection. This system can only be connected by bus. Attach the wires with the terminal screws following the color code (1).

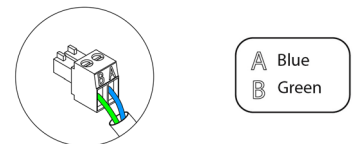

Note: For a proper operation of the main control board, all the main control board must be addressed (up to 32 systems) (see section Advanced Settings).

Aerothermal gateway bus connector

The AC unit bus allows you to connect multiple gateways of for air-to-water equipment installed. These are the elements that can be connected:

- Daikin aerothermal gateway (AZX6ACUACP [DAI/DA2]).

In order to connect these gateways, disconnect the terminal of the AC unit bus and fit in the connector and the fixing post of the gateway.

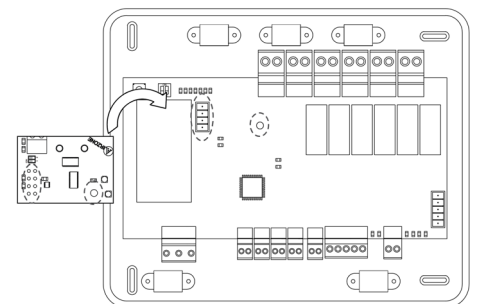

Control relays

This device has 6 relays for controlling the installation. The characteristics of the control relays are I_{max} of 10 A at 110/230 Vac (voltage-free. Note that to control elements with a greater power, it is recommended to use contactors in accordance with the power required.

Important: Remember to connect the neutral connector directly from the circuit to the element to be controlled.

Depending on the type of installation, the control relays will follow a different logic:

Aerothermal

Mode	Demand	Control relays					
		FRIO_Y	CALORB_W	AIRE_Y	RADIANTE_Y	AIRE_W	RADIANTE_W
Stop	Off	--	--	--	--	--	--
Cooling mode	Air	ON	--	ON	--	--	--
	Radiant	ON	--	--	ON	--	--
	Off	--	--	--	--	--	--
Heating mode	Air	--	ON	--	--	ON	--
	Radiant	--	ON	--	--	--	ON
	Off	--	--	--	--	--	--
Dry	On	--	--	--	--	--	--
	Off	--	--	--	--	--	--
Ventilation	On	--	--	--	--	--	--
	Off	--	--	--	--	--	--

2 pipes / 4 pipes

Mode	Demand	Control relays					
		FRIO_Y	CALORB_W	AIRE_Y	RADIANTE_Y	AIRE_W	RADIANTE_W
Stop	Off	--	--	--	--	--	--
Cooling mode	Air	ON	--	ON	--	--	--
	Radiant	ON	--	--	ON	--	--
	Off	ON	--	--	--	--	--
Heating mode	Air	--	ON	--	--	ON	--
	Radiant	--	ON	--	--	--	ON
	Off	--	ON	--	--	--	--
Heating mode	On	ON	--	--	--	--	--
	Off	ON	--	--	--	--	--
Ventilation	On	--	--	--	--	--	--
	Off	--	--	--	--	--	--

Important: To guarantee the optimization of the production temperature of the aerothermal units, these device combinations do not generate demand to the production control board:

- Airzone controller 3.0 gateway (AZX6GTCxxx) in Flexa 3.0 and Innobus Pro6 main control boards.
- Communication gateway (AZX6QADAPTxxx) in Flexa 3.0 and Innobus Pro6 main control boards.
- Airzone control gateway for electromechanical units (AZX6 ELECTROMECH) in Flexa 3.0 and Innobus Pro6 main control boards.

SW1

Once all the main control boards have been addressed, you must save the configuration of the installation in the production control board. To do that, press SW1 (3). If you make any changes in the installation, remember to save the new configuration. To reset the production control board, press SW1 until the LED D2 is off.

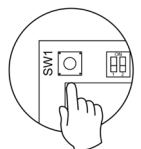

SW2

The microswitch SW2 sets the type of installation to control by the central production control. The operation logic of the microswitch is as follows:

Meaning		
Aerothermal	2 pipes	3/4 pipes

KNX INTEGRATION GATEWAY (AZXKNXGTWAY)

Assembly

KNX integration gateway is mounted on DIN rail. This module is powered through the domotic bus of the main control board and the KNX bus of the installation. It should be placed and mounted in accordance with the current electrotechnical regulations.

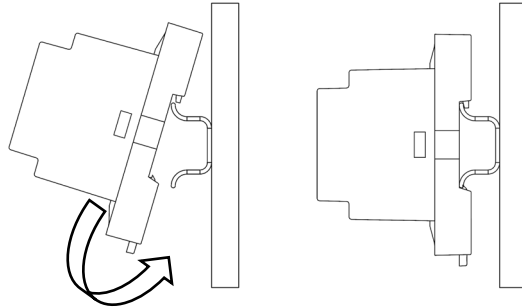

Note: To take the module away, pull the reed down to release it.

Connection

KNX gateway connects to the AC unit bus of the main board.

No.	Description
①	Programming key
②	KNX bus connection
③	Airzone bus connection

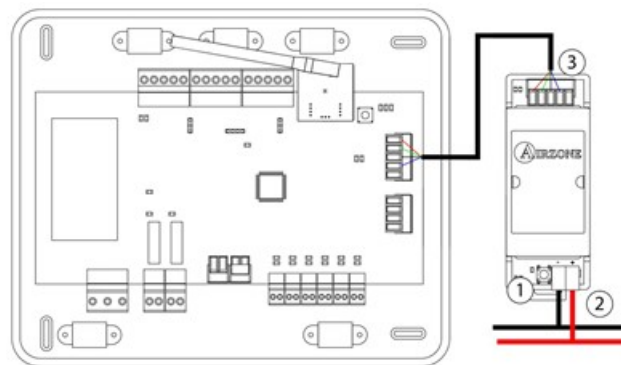

③

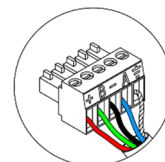

A	Blue
-	Black
B	Green
+	Red
⏏	Shield

Note: To configure it, follow the steps described in the KNX installation manual available at myzone.airzone.es

(http://doc.airzone.es/producto/Gama_AZ6/Airzone/Comunes/Manuales/MI_AZX6KNXGTWAY_A4_EN.pdf)

AIRZONE CONSUMPTION METER (AZX6ACCCON)

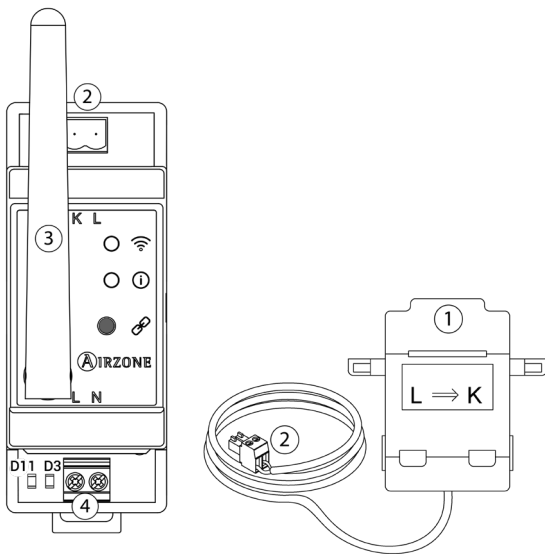

Nº	Meaning
①	Clamp meter
②	Sensor connection
③	Antenna
④	Power supply
	Button

Assembly

This module is mounted on DIN rail. It module is externally powered at 110/230 Vac. It should be placed and mounted in accordance with the current electrotechnical regulations.

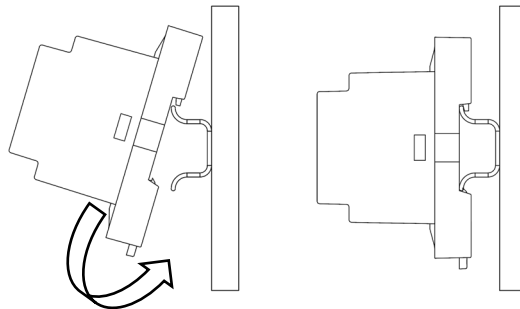

Note: To take the module away, pull the reed down to release it.

Connection

The Airzone consumption meter is connected by a clamp meter directly to the external air conditioning power supply wires to measure the power consumptions of the system.

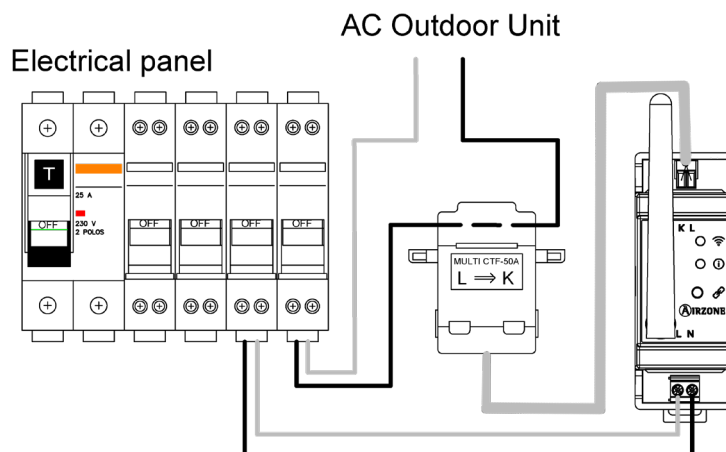

It is connected to the module through a 2-pin terminal. Attach the wires with the terminal screws following the color code.

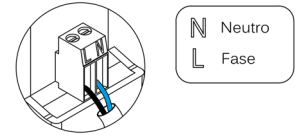

For the connection to the Airzone main board follow the next steps:

1. Turn on the radio channel of the system.



Reset



ASSEMBLY AND CONNECTION EVALUATION

Check the following aspects:

- The state of the LEDs of the main control board and the rest of control elements. Check the self-diagnose section of the data sheet of the elements.
- The opening dampers LEDs of the main control board light up sequentially.
- If all the thermostats are powered.

SYSTEM START-UP

AIRZONE BLUEFACE AND AIRZONE THINK SETUP

Important: Once the setup has been started, it must conclude. You will be able to modify the desired parameters later.

1 Language/Country

Select your language and country. These are the available languages: Spanish, English, French, Italian, German and Portuguese.

To associate a wireless Think thermostat, start the radio channel search:

Setting wireless device

- Open the radio channel. To do that, press on SW1. The LED D19 will remain solid red. Once open, you have 15 minutes to make the association. If that period of time expires, start the process over again. Remember not to open more than one module at the same time, it may alter the process. You can also open the channel association radio through the Blueface and Think (see section *System parameters*).

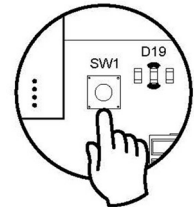

IMPORTANT: Do not open more than one radio channel at the same time, it may alter the process.

- Start the radio channel search, to do so, press Airzone to start the search.
- Verify **the range is correct** (30% minimum) and confirm.

2

Select the zone associated to the thermostat. All the zones have a corresponding control output (output for motorized elements or control relay for radiant elements). For example, the zone 1 will control the control relay output O1 of the Control Module of Radiant Elements (AZCE6OUTPUT8).

3

If necessary, the system allows you to associate more than one control output to a zone. It is possible to control multiple outputs from the same thermostat.

4

Select the operation of the thermostat:

- Master: Controls all the parameters of the installation.
- Zone: Controls all the parameters of the zone.

5 (only available in installations with AZDI6OUTPUT8 modules)

Select the stages to be controlled: Air, Radiant or Combined.

6

Press to finish the initial setup process, or access the advanced settings (system address, control stages, etc.) to change any other settings. Activate the basic function if required (see [Advanced Settings, Zone settings](#)).

Blueface

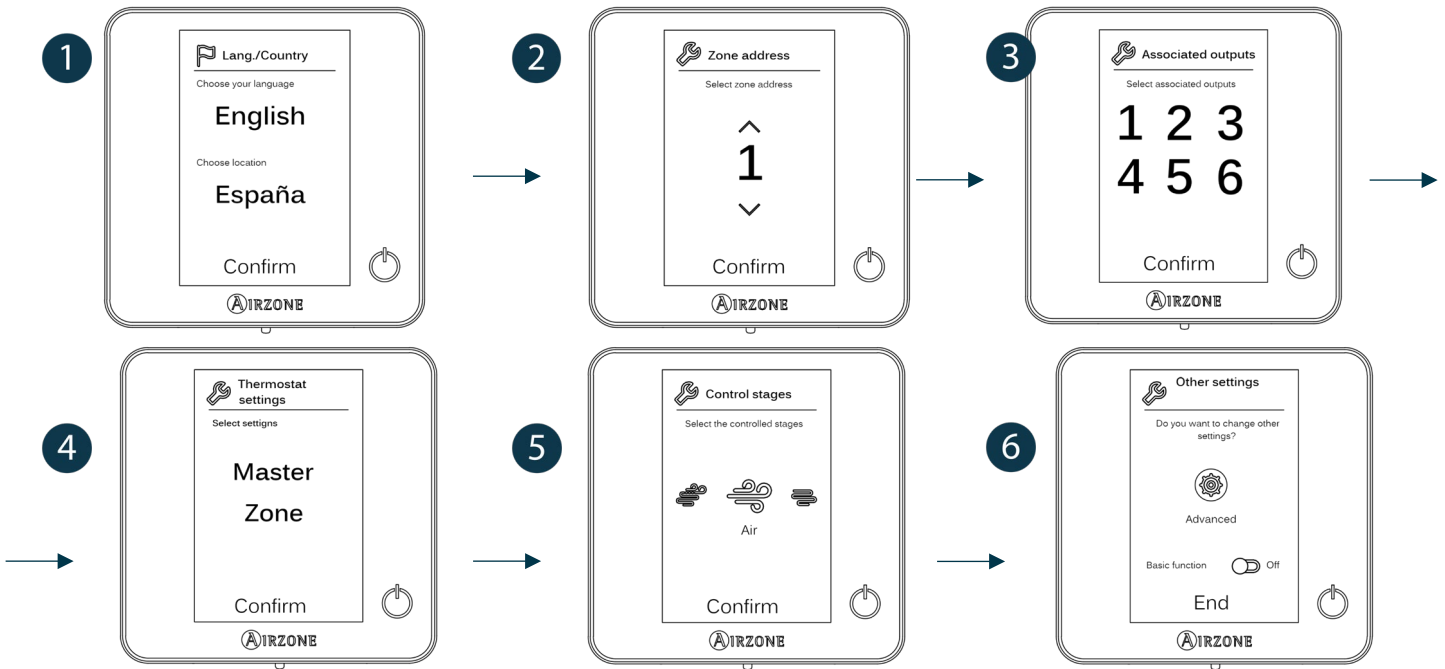

Think

Important: Use **AIRZONE** to confirm and **≡** to return.

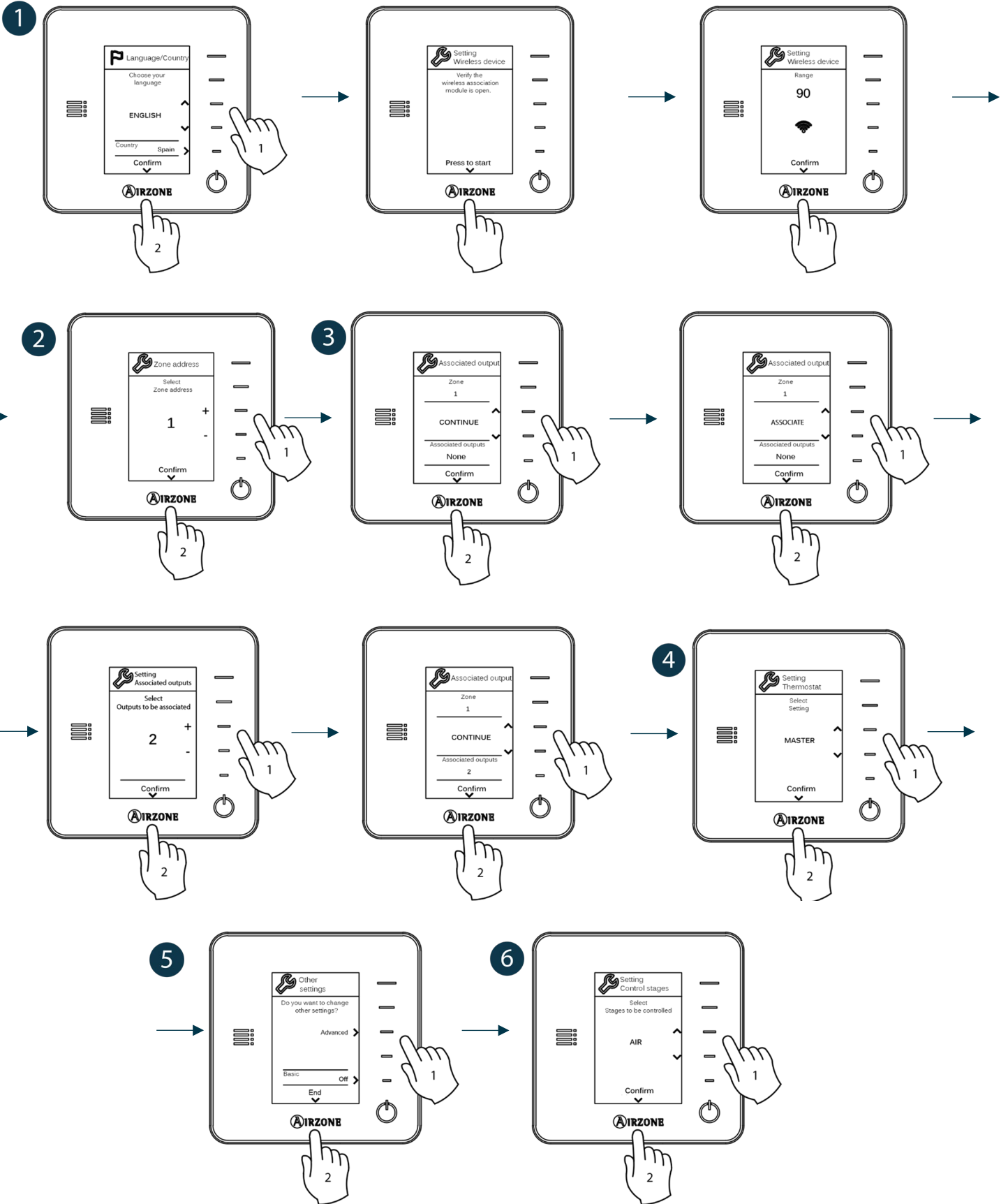

AIRZONE LITE SETUP

Important: To configure a Lite thermostat you must move it away from its base. Once the microswitches are configured, put it back in its original position.

1 Setting wireless device (only available for wireless thermostat)

Open the radio channel. To do that, press on SW1. The LED D19 will remain solid red. Once open, you have 15 minutes to make the association. If that period of time expires, start the process over again. Remember not to open more than one module at the same time, it may alter the process. You can also open the channel association radio through the Blueface and Think (see section [System parameters](#)).

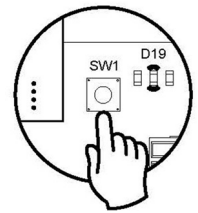

IMPORTANT: not to open more than one radio channel at the same time, it may alter the process.

2

Select the zone associated to the thermostat pulling up the microswitch of the corresponding zone.

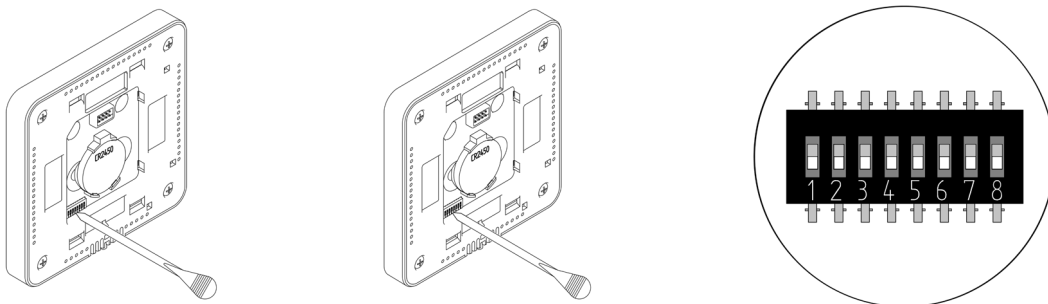

3

If required, select other control outputs associated to the zone. The address zone will be the one with a lower value.

4

Configure other functionalities of the LITE thermostat from the advanced configuration menu of a Blueface thermostat (see section *Advanced Settings*, [Zone parameters](#)).



Remember: If you need to change the zone number, reset the thermostat and start association process.

Lite thermostat reset



INITIAL CONFIGURATION EVALUATION

Check the following aspects:

- AC unit-system communication: Choose any mode (except STOP mode) and switch on the zone to generate demand. Verify that the selected operation mode in the Master thermostat is shown in the indoor unit thermostat and the set-point temperature changes.
- Opening-closing of the dampers and control outputs: Turn on the system and generate demand in all the zones. Then, switch off and on all the zones to verify the associated control outputs are correct.
- Verify that the static pressure of the duct system complies with the air distribution network conditions where is installed (check the Manufacturer's Manual of the equipment if you need to modify this parameter).

Important: For security reasons, the last zone will take around 4 minutes to close.

USER AND ZONE SETTINGS

USER SETTINGS - BLUEFACE THERMOSTAT



Language/Country. Select your language and country



Brightness. Select the brightness intensity and activate/deactivate the brightness on the screensaver.



- Zone state: Displays information about the zone state and settings
- Weather forecast: Only available with Airzone Cloud Webserver (AZX6WEBSCLLOUDC/AZX6WSC5GER and AZX6WSCLOUDDIN [C/R]).
- AC unit consumption: Only available for some configurations.
- If you deactivate the information feature, only the time and zone state will be displayed.



- Zone: Firmware, zone, association, actuator o communications status.
- System: Firmware, configuration and information about the controllers.
- Devices: Displays what elements are connected to the system.
- Webserver (*Only for system 1 Master thermostat*): Webserver status and settings, association to router.
- Errors: It warns you if any error occurs.

ZONE CONFIGURATION MENU – AIRZONE BLUEFACE THERMOSTAT



These are the values you can select:

- **OFF.** The timing is off.
- **30.** The zone turns off after 30 minutes.
- **60.** After the 30 minutes, the temperature increases or decreases in one degree and then after 30 more minutes, the zone turns off.
- **90.** After 30 minutes, the temperature increases or decreases in one degree. 30 minutes later, the process is repeated (± 1 degree). Then, after 30 more minutes the zone turns off.



Moreover, depending on the type of installation and configuration of your system, you will find other features:



- Maximum: The systems operates at maximum speed, regardless of the number of zones.
- Power: The system adjusts the speed to supply higher airflows.
- Standard: Configuration option by default. The systems adjust the speed depending on the number of zones.
- Silence: The speed is adjusted to reduce the noise level.
- Minimum: The systems operates at minimum speed, regardless of the number of zones.



Note: To access this setting, you must access to navigation by zones, to the area controlled by a thermostat Lite.

USER SETTINGS – AIRZONE THINK THERMOSTAT

AIRZONE

Zone navigation.

- OFF. The timing is off.
- 30. Zone turns off after 30 minutes.
- 60. It activates the timing. The temperature increases or decreases in one degree after 30 minutes and then after 30 more minutes, the zone turns off.
- 90. It activates the timing. After 30 minutes, the temperature increases or decreases in one degree. 30 minutes later, the process is repeated (± 1 degree). After 90 minutes, the zone will switch off.



Zone navigation. Access any zone and turn it on/off, check the information of the zone or change the set point.

In master Airzone Think thermostats, it is also possible to change the **Operating mode** from the control bar. This is the list of available modes:





In fan coil installations, if we have a Master Think thermostat, it is also possible to select the AC unit **Fan speed**:



High



Low



Medium



Automatic

ADVANCED SETTINGS

To access the advanced configuration menu of the Blueface and Think thermostats follow the following steps:

Blueface

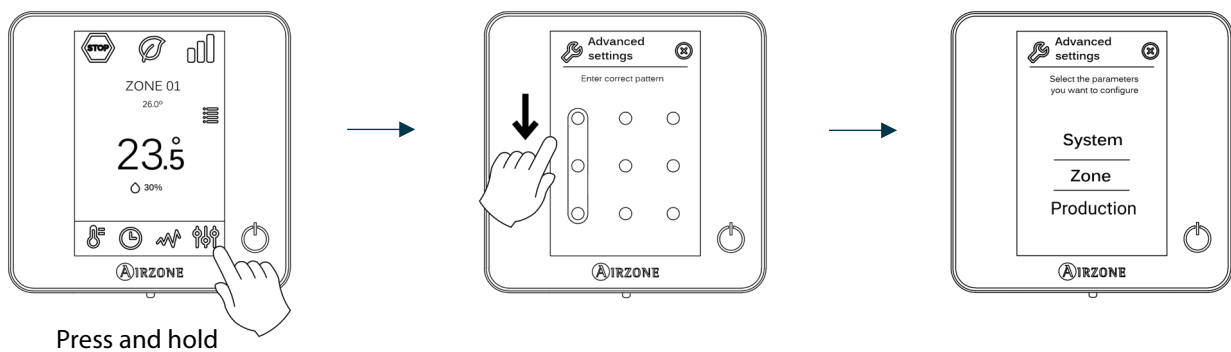

Think

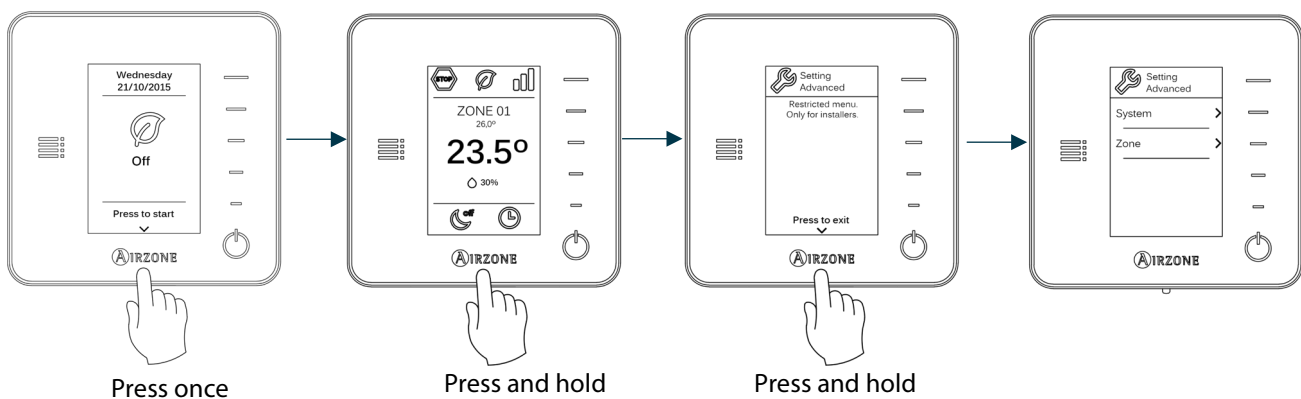

From this menu you can change the system and zone parameters.

SYSTEM SETTINGS

- **System address** (not available on systems with BACnet gateway). Defines the number of the system within your installation. The value 1 is shown by default. The system will display the available values (max = 247).

If the system has address 1 and there is a production control board (AZX6CCP) in the installation, it is possible to activate **Supermaster** feature which imposes the operating mode of system 1 to the rest of the systems connected to the AZX6CCP:

Operating mode: System 1	Available operating modes: Rest of the systems

- **Temperature range.** Selects the highest temperature in heating mode (19-30 °C) and the lowest temperature in cooling mode (18-26 °C). It is also possible to disable some of the modes. The highest temperature by default is 30°C. The lowest temperature by default is 18°C.
- **Combined stage.** (only available in installations with AZCE6OUTPUT8 modules) Enables activating and deactivating the combined stage of the "Control Stages" parameter in the user's Zone Settings Menu.
- **Hysteresis configuration.** Defines the temperature differential between room temperature and set-point temperature required to start applying the Algorithm RadianT. In installations with radiators, set this value to 0°C. It is set to 0°C by default.
- **Type of opening.** Use this to activate/deactivate the proportionality in the dampers of the system. The proportionality adjusts in 4 steps the damper opening or shutting based on the temperature demand of the zone, regulating the flow. It is configured as All/nothing by default.

**Note: If you change this parameter, all the dampers of the installation will be affected. It is not recommended for RINT and RIC intelligent grilles.*
- **Standby mode** (only for Blueface thermostats). Configuration of the operating logic of the motorized elements when there is no demand on the system. This is disabled by default.
- **Relay settings.** Allows you to modify the logic of operation of CMV/Boiler relay of the main control board (see section *Airzone main control board (AZCE6FLEXA3 / AZCE6IBPRO6), Connection*). It is configured as CMV by default.
- **Wireless module.** It activates/deactivates the wireless association module of the system.
- **Return temperature** (only available in installations with AZX6SONDPROTEC protection probes). Defines the cut-off temperatures of the system for both heating (32°C, 34°C and 36°C) and cooling mode (6°C, 8°C and 10°C) in order to protect the AC unit. The system highest temperature by default is 34°C and the lowest is 8°C.
- **Q-Adapt** (only for Think thermostats).
 - **In direct expansion units.** Select the control algorithm that best fits your installation. These are the available options:
 - Maximum: the system operates at maximum speed, irrespective of the number of zones.
 - Power: the speed of the system is higher than in standard mode to increase the flow.
 - Standard (by default): the system automatically regulates the speed based on the number of zones.
 - Silence: the speed of the system is lower than in standard mode to reduce the noise.
 - Minimum: the system operates at minimum speed, irrespective of the number of zones.

- **In 0-10 V Fancoil units.** Allows to control the minimum (1.5 V by default) and maximum (10 V by default) working fan voltage of the controlled unit, in steps of 0.1 V. The minimum voltage corresponds with the desired lowest speed for the unit and the maximum voltage corresponds with the highest speed. The medium speed corresponds with the mid point between both of them.
- **Radio channel.** It activates/deactivates the wireless association module of the system.
- **Information** (*only available for Think thermostats*). Displays information about:
 - Zone: Firmware, zone, association, actuator o communications status.
 - System: Firmware, configuration and information about the controllers.
 - Devices: Displays what elements are connected to the system.
 - Webserver: Firmware, IP address, gateway, MAC and PIN.
- **Reset system** (*only available for master thermostat Blueface*). Resets the system and returns to factory settings. To reconfigure the thermostats, please check [Initial setup](#).
- **Centralized Controller.** It allows defining whether or not your installation has a Centralized Controller. By default it will be disabled.
- **BACnet** (*only in installations with AZX6BACNET*). This parameter displays the Device ID, the uplink port, the IP address, the subnet mask and the Gateway IP and allows you to modify them. Press on the value you want to change, modify it and then press to confirm. The values by default are:
 - Device ID: 1000
 - Port: 47808
 - IP Address: DHCP
- **Protection mode** (*only available in Blueface thermostats and if the system detects an H2 error in the indoor unit*). This allows you to disable the delay in the closing of the motorized elements.

ZONE PARAMETERS

- **Associated outputs.** It displays and allows you to select the control outputs associated with the thermostat.
- **Thermostat settings.** Use this parameter to define the thermostat as Master or Zone.

**Note: It cannot be configured as Master if there is already another Master thermostat.*
- **Use mode.** The thermostats can be set in Basic or Advanced mode. They are set in advanced mode by default. These are the parameters you can control in basic mode:
 - On/Off.
 - Set-point temperature.
 - Operating mode (only if this is the master thermostat)
 - Fan Speed

If you need to reset the thermostat to advanced mode, access the advanced configuration menu and then activate the advanced use mode.
- **Control stages** (*only available in installations with AZCE6OUTPUT8 modules*). This parameter is used to configure both cooling and heating stages in a single zone or in all the zones. These are the features to be configured:
 - Air: It activates the heating/cooling air in the zone.
 - Radiant (*only for heating stages*): It activates the radiant heating in the zone.
 - Combined (*only for heating stages*): It activates both air and radiant heating in the zone selected and allows the user to select the desired heating stage that in the zone: Air, radiant or combined (see section *Zone Configuration menu - Blueface Thermostat, Heating stages*). The zone will start using the heating air stage. Once the room temperature reaches the differential preestablished (see parameter *Hysteresis Conf.*), the zone will activate the radiant stage.

- Off: It deactivates the cooling/heating stage in the zone.
- **Offset.** Allows you to correct ambient temperature that is measured in the various areas or in all of them, due to deviations by sources of heat/cold nearby, with a correction factor between - 2,5°C and 2,5°C in steps of 0,5°C. It is in 0°C by default.
- **Reset thermostat** (*not available in remote zones*). Resets the thermostat returning to Setup menu (see section Zone Configuration menu - Blueface Thermostat).

PRODUCTION SETTINGS

Important: Production control board settings are only available in AZX6CCPWSCC for the master Blueface thermostat of the system n°1.

- **Operation logic.** It allows to configure the operation logic for the control relays of the production control board:
 - Aerothermal unit (Default preset)
 - 2 pipes
 - 4 pipes
 - RadianT (*Recommended for RadianT365 systems*)
- Aerothermal

Mode	Demand	Control Relays					
		FRIO_Y	CALORB_W	AIRE_Y	RADIANTE_Y	AIRE_W	RADIANTE_W
Stop	Off	--	--	--	--	--	--
Cooling mode	Air	ON	--	ON	--	--	--
	Radiant	ON	--	--	ON	--	--
	Off	--	--	--	--	--	--
Heating mode	Air	--	ON	--	--	ON	--
	Radiant	--	ON	--	--	--	ON
	Off	--	--	--	--	--	--
Dry	On	--	--	--	--	--	--
	Off	--	--	--	--	--	--
Ventilation	On	--	--	--	--	--	--
	Off	--	--	--	--	--	--

- 2 pipes / 4 pipes

Mode	Demand	Control Relays					
		FRIO_Y	CALORB_W	AIRE_Y	RADIANTE_Y	AIRE_W	RADIANTE_W
Stop	Off	--	--	--	--	--	--
Cooling mode	Air	ON	--	ON	--	--	--
	Radiant	ON	--	--	ON	--	--
	Off	ON	--	--	--	--	--
Heating mode	Air	--	ON	--	--	ON	--
	Radiant	--	ON	--	--	--	ON
	Off	--	ON	--	--	--	--
Dry mode	On	ON	--	--	--	--	--
	Off	ON	--	--	--	--	--
Ventilation	On	--	--	--	--	--	--
	Off	--	--	--	--	--	--

Note: In this configuration, the indoor unit will remain in Standby mode once comfort has been reached in all zones

- **Activation delay.** It allows to set a delay time in the power on of the production unit, configurable in minutes, from 0 to 7. (Default preset to 3 minuts).
- **LWT temperatures.** *(Only available in installations with gateway AZX6GAW[XXX] provided that the aerothermal unit is not configured to work automatically, allowing the imposition of working temperatures).* It allows to set the LWT temperaturas for the heating and cooling modes of the aerothermal unit. Selectable values depends on each particular aerothermal unit. Default presets are:
 - Air in cooling mode: 10 °C
 - Radiant in cooling mode: 18 °C
 - Air in heating mode: 50 °C
 - Radiant in heating mode: 35 °C
- **DHW function.** *(Only available in installations with AZX6GAW XXX control gateways)* It allows to turn on/off the Domestic Heat Water (DHW) function in the systems connected to the CCP. Activated by default.
- **Cooling mixing valve** *(only available in installations with aerothermal gateway).* It allows you to configure the operation of your installation depending on whether or not you have a cooling mixing valve.

Select Manual in the case of having cooling mixing valves in your installation, in which case they must be set at 18°C. If the installation does not have a cooling mixing valve, select Auto so that the installation works automatically with the temperature read by the system. By default it is set as Manual.

SELF-DIAGNOSE

AIRZONE MAIN CONTROL BOARD (AZCE6FLEXA3 / AZCE6IBPRO6)

Airzone main control boards have integrated LEDs that detect unusual operations.

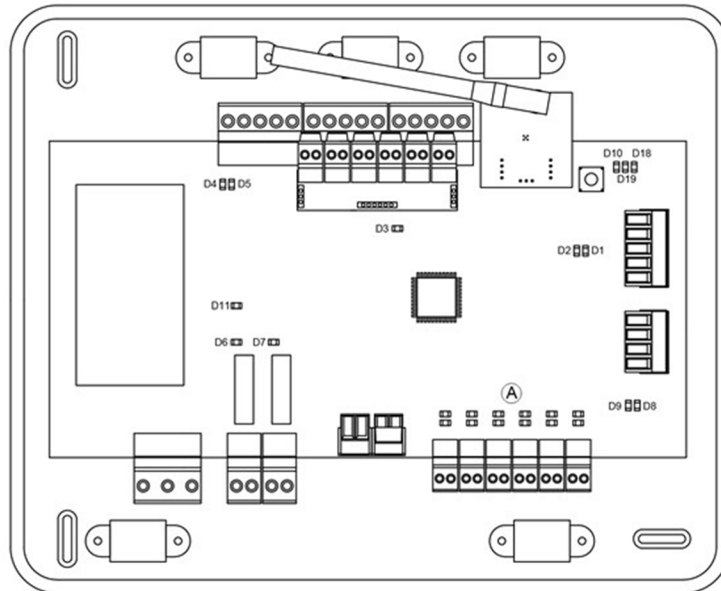

Meaning			
D1	Data reception from automation bus	Blinking	Green
D2	Data transmission from automation bus	Blinking	Red
D3	Main control board activity	Blinking	Green
D4	Data transmission from Airzone connection bus	Blinking	Red
D5	Data reception from Airzone connection bus	Blinking	Green
D6	AC unit On/Off	Blinking	Green
D7	CMV/Boiler	Blinking	Green
D8	Data transmission from AC unit bus	Blinking	Red
D9	Data reception from AC unit bus	Blinking	Green
D10	Wireless data packets reception	Switches	Green
D11	Main control board power supply	Solid	Red
D18	Associated element	Solid	Green
D19	Association channel: active	Solid	Red
A	Open dampers	On	Green
	Close dampers	On	Red

AIRZONE EXPANSION MODULE OF 2 ZONES (7 AND 8) (AZCE6EXP8Z)

Airzone expansion modules incorporates LEDs that detect unusual operations.

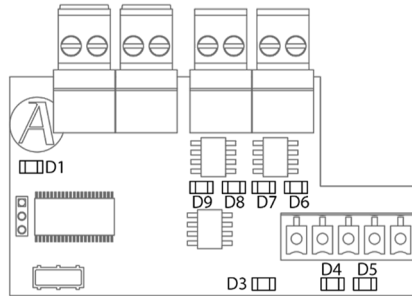

Meaning			
D1	Microcontroller operating	Blinking	Green
D3	Power supply	Solid	Red
D4	Transmission of Airzone connection bus data	Blinking	Red
D5	Reception of the Airzone connection bus data	Blinking	Green
D6	Close actuator zone 7	Blinking	Red
D7	Open actuator zone 7	Blinking	Green
D8	Close actuator zone 8	Blinking	Red
D9	Open actuator zone 8	Blinking	Green

AIRZONE CONTROL MODULE OF RADIANT ELEMENTS (AZCE6OUTPUT8)

Airzone control modules incorporate LEDs that detect malfunctions.

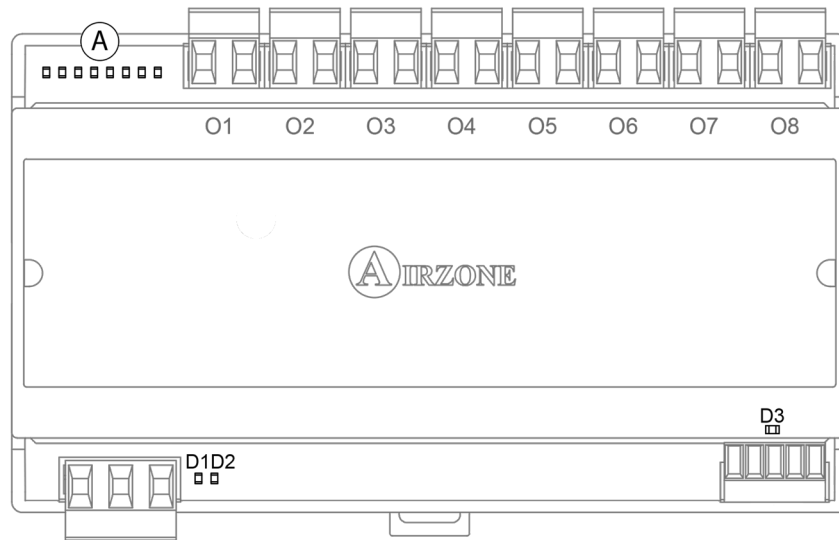

Meaning			
D1	Power supply	Solid	Red
D2	Module operating	Blinking	Green
D3	Data transmission and reception from automation bus	Blinking	Green
(A)	LEDs of relay state	Switches	Green

AIRZONE BLUEFACE AND THINK THERMOSTATS (AZCE6BLUEFACEC / AZCE6THINK [C/R])

Blueface Thermostat Warnings

Thermostat displays all the system warnings on the screensaver. If there is any error, it will be displayed on the screensaver, on the main screen and on "About errors", in user settings.

- **Anti-freezing.** It will be displayed in case of activation (See *Zone settings – Blueface thermostats*).
- **Window.** This warning indicates the air conditioning of the zone has been suspended due to open window. Only available if the window contact of the system is activated.
- **DHW:** DHW is active. If your system has DHW management and it is activated, you will see a message on your Blueface and the zone will be deactivated.
- **Low battery Lite.** Low battery warning. Informs about the involved zone when the icon is pressed.

Think Thermostat Warnings

Thermostat displays the system warnings on the screensaver.

- **Anti-freezing.** It will be displayed in case of activation (See *Zone settings – Blueface thermostats*).
- **Window.** This warning indicates the air conditioning of the zone has been suspended due to open window. Only available if the window contact of the system is activated.
- **DHW:** DHW is active. If your system has DHW management and it is activated, you will see a message on your Blueface and the zone will be deactivated
-  **battery Warning.**

Blueface and Think Thermostats errors

If any type of anomaly is detected, the word "Error" is displayed on the screensaver of these devices. There are two types of errors: blocking and non-blocking.

Blocking anomalies hinder the basic operation of the system, blocking the thermostat until the problem is solved. Non-blocking anomalies do not alter the operation of the system.

The errors that you can find your screen are:

Error of communication

- 1** Blueface thermostat - Main control board
- 8** Lite thermostat - Main control board
- 9** Gateway - Airzone system
- 10** BACnet gateway - Control board
- 11** Gateway - Indoor AC Unit
- 12** Webserver – Airzone System
- 13** Radiant elements control board - Main control board
- 14** Expansion module - Main control board
- 15** Consumption meter – Main control board
- 17** Lutron gateway - Airzone System
- C-02** Production control board – Central
- C-09** Aerothermic gateway – Production control board

AC unit error. Error in the AC unit.

Other errors

- 5** Open-circuit temperature probe
- 6** Short-circuit temperature probe
- 16** Measuring error in consumption meter

Error 1: Wired thermostat-Main control board communication error

This incident blocks the control of the zone. Check this error is not common to all thermostats. If so, verify the proper operation of the main board. To solve this incident check:

Main control board status: Correctly powered.

Main control board status: Airzone connection bus LEDs are operating properly.

Connection: Verify the polarity of the main control board and thermostat connectors.

Wiring: Check that the voltage between the poles (A/-) and (B/-) is correct (1.8 Vdc).

Restart the zone and re-associate it with the system:



Restart system: If the system is restarted, this error may be displayed in the thermostats at the beginning of the process. This message should disappear after around 30 seconds.

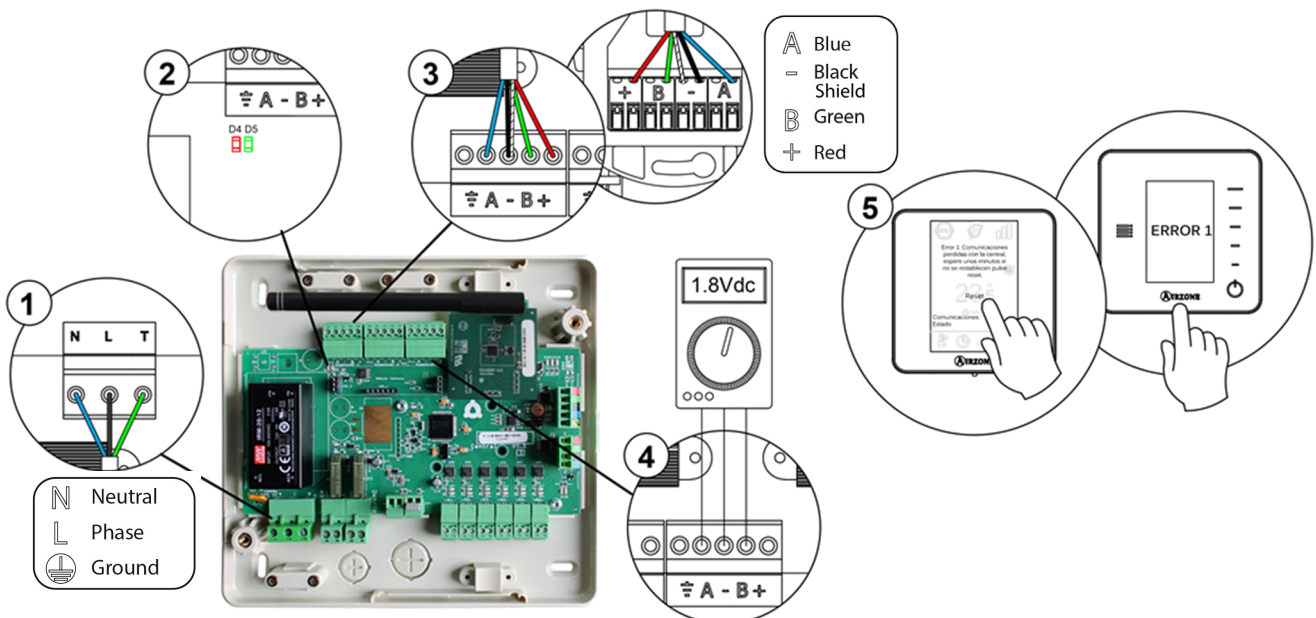

Error 1: Wireless thermostat-Main control board communication error

This incident blocks the control of the zone. Check this error is not common to all thermostats. If so, verify the proper operation of the main board. To solve this incident check:

1. Thermostat status: Check the signal range of the thermostat with the main board through the Information parameter (see section Advanced settings, system settings) or approach the thermostat to the main control board, if the thermostat recovers the communication, it is necessary to relocate it as it was out of range.
2. Main control board status: Correctly powered.
3. Main control board status: Proper operation of the LED of wireless communication.



Wireless module inside Advanced Settings, zone settings.

5. Restart system: If the system is restarted, this error may be displayed in the thermostats at the beginning of the process. This message should disappear after around 30 seconds.

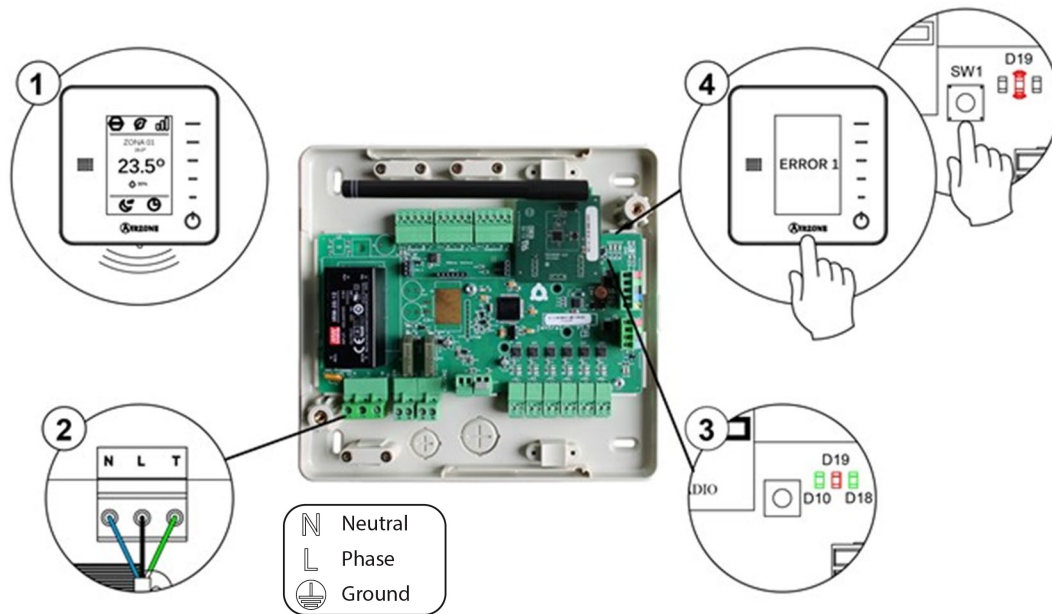

Error 5: Temperature probe - Open circuit

The zone ceases to measure the room temperature, therefore the zone cannot generate demand. Proceed to replace it of the device or sent it for repair.

Error 6: Temperature probe - Short circuit

The zone ceases to measure the room temperature, therefore the zone cannot generate demand. Proceed to replace it of the device or sent it for repair.

Error 8: Wired Lite thermostat not found

The zone ceases to measure the room temperature of an associated wired Lite thermostat, therefore the zone cannot generate demand. Check in your Blueface tharmostat which Lite thermostat is not working properly. To solve this incident check:

1. Connection: Check the polarity of the main control board and thermostat connectors.
2. Wiring: Check that the voltage between the poles (A/ -) and (B/ -) is correct (1.8 VDC for Supermaster)
3. Verify the thermostat microswitch corresponds with the zone associated. If not, activate it using the tab with the value needed.

Remember: *If you need to change the zone number, reset the thermostat and start association process.*

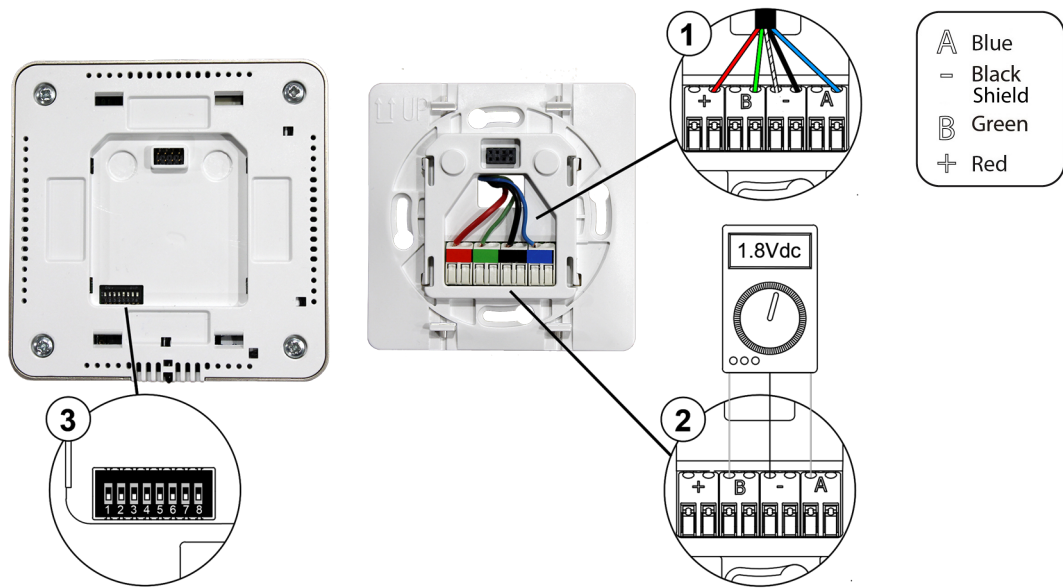

Error 8: Wireless thermostat Lite not found

The zone ceases to measure the room temperature of an associated wireless Lite thermostat, therefore the zone cannot generate demand. Check which Lite thermostat is not working properly. To solve this incident check:

1. Power supply: Check the battery and replace it if necessary.
2. Verify the thermostat microswitch corresponds with the zone associated. If not, activate it using the tab with the value needed. Note that, if you need to associate wireless devices, the wireless association module must be previously open (from SW1 button or from any thermostat, pressing *Wireless module* inside *Advanced settings, zone settings*).

Remember: *If you need to change the zone number, reset the thermostat and start association process.*



Error 9: Gateway-System communication error

The system loses communication with the AC unit. The system will open all the zones and deactivate the control from the thermostats, only allowing the operation of the unit from the thermostat of its manufacturer. To solve this incident check:

1. Verify the gateway is properly connected to the AC unit port of the main control board.
2. In DIN-rail gateways, check the polarity of the connectors of the gateway and the AC unit port of the main board.
3. Check the status of the LEDs of the gateway. To do this check the self-diagnose section or the technical sheet of the gateway.

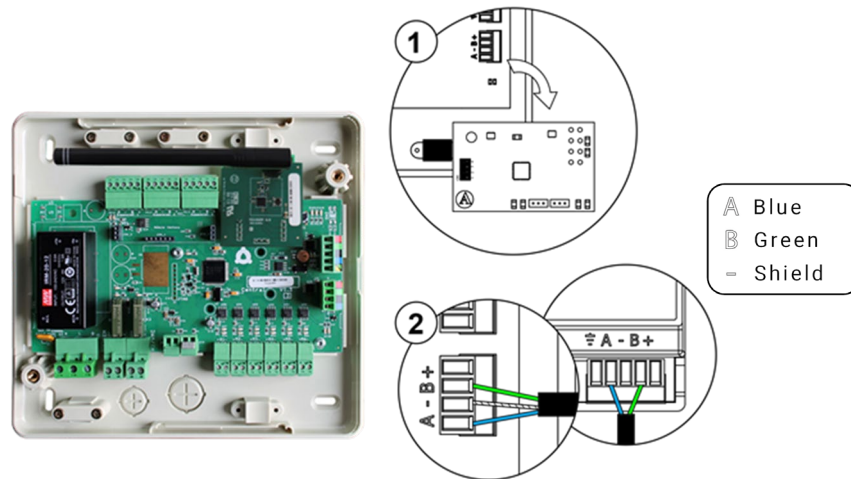

Error 10: Communication error between BACnet Integration Gateway – Systems

The system loses communication with the Airzone BACnet Interface. Check that the gateway is properly connected to the automation bus of the Main Board.

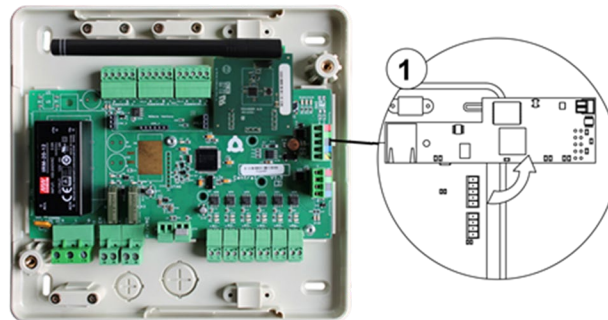

Error 11: Gateway-AC Unit communication error

The system loses communication with the AC unit. The system will open all the zones and deactivate the control from the thermostats, only allowing the operation of the unit from the thermostat of its manufacturer. To solve this incident check:

1. Verify if the Air unit is powered. To do this, check the thermostat of the AC unit is ON.
2. Verify the AC unit operates properly by itself. To do this, disconnect the A/C unit Airzone system and select the unit from the thermostat from the A/C unit.
3. Connection: Check the polarity and connection of the gateway connectors and the indoor unit. See the technical sheet of the gateway in question.
4. Wiring: In DIN-rail gateways, check that the voltage between the poles (A/ -) and (B/ -) is correct (1.8 Vdc).
5. Verify the status of the LEDs of the gateway is correct. To do this check the self-diagnose section or the technical sheet of the gateway.

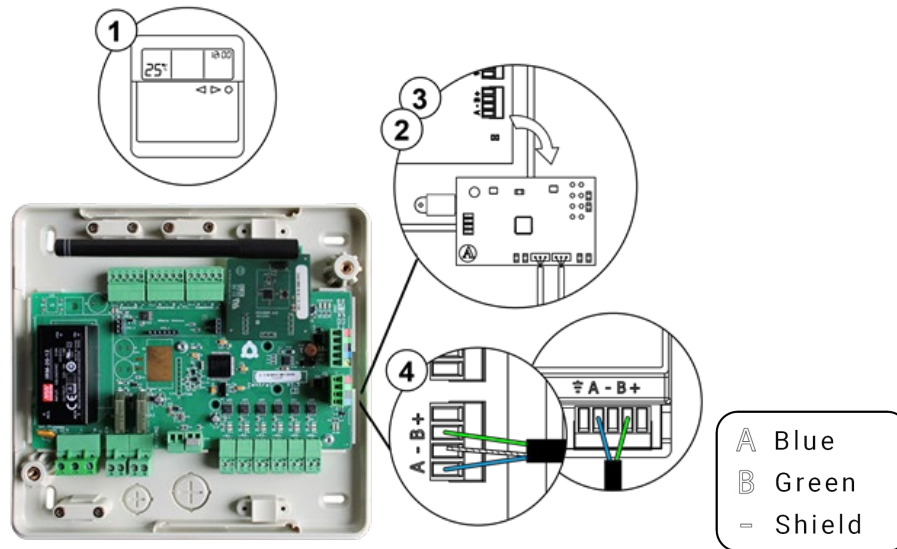

Error 12: Communication error between Airzone Cloud Webserver – system

The system loses communication with the Webserver. To solve this incident check:

1. Check that the Webserver is correctly connected to the Control board's automation bus.
2. For DIN rail Webserver version, check if the polarity of the Webserver and main board domotic port are correct.
3. Verify the status of the LEDs of the gateway is correct. To do this check the self-diagnose section or the technical sheet of the Webserver.

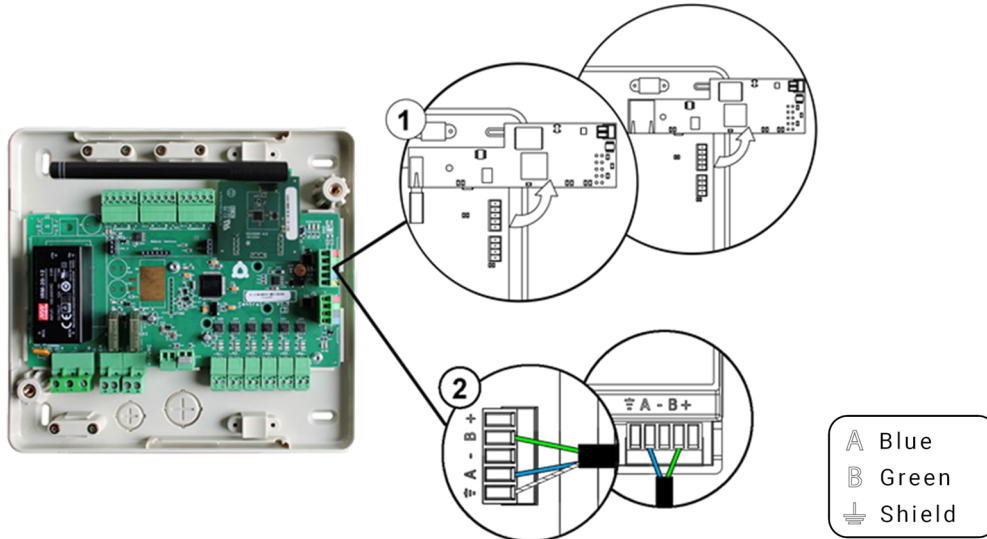

Error 13: Main board-Control module of radiant elements communication error

The device can not be controlled by the system. To solve this incident check:

1. Status of the control module of the radiant elements: Correctly powered.
2. Status of the control module of the radiant elements and the main control board: Airzone connection bus LEDs are operating properly.
3. Connection: Check the polarity of the connectors of the main control board and the radiant element board.
4. Wiring: Check that the voltage between the poles (A/ -) and (B/ -) is correct (1.8 Vdc).

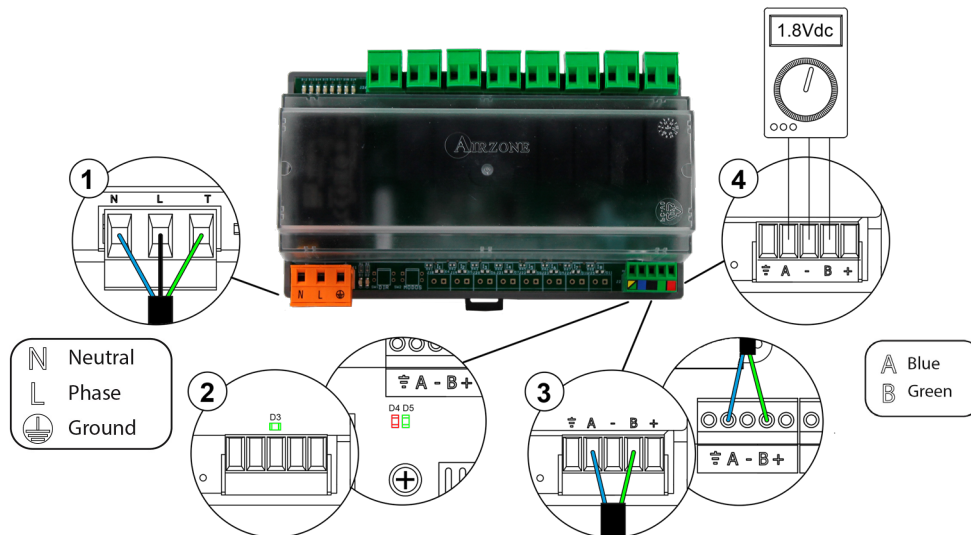

Error 14: Main control board-Expansion module communication error

Control of zones 7 and 8 is lost. To solve this incident check:

1. Verify that the module is correctly connected to the Airzone connection bus.
2. Module status: Airzone connection bus LEDs are operating properly.

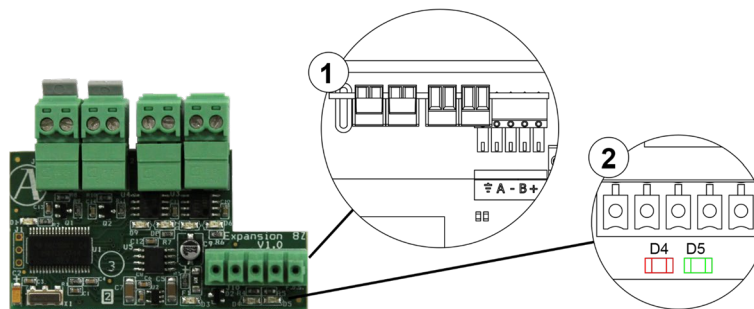

Error 15: Error in main control board - consumption meter communications

This issue does not allow the system to measure the consumption of the air conditioning unit. To resolve this issue, follow the steps below:



Status of the consumption meter: Check that the power supply is correct.

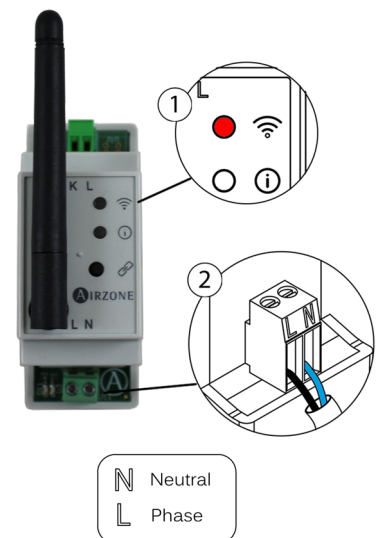

Error 16: Measurement error on the consumption meter

This issue do not allow the device to properly measure the power consumption of the air conditioning unit. To solve this issue:

1. Check that the amperometric clamp is properly connected to the air conditioning power supply cable.

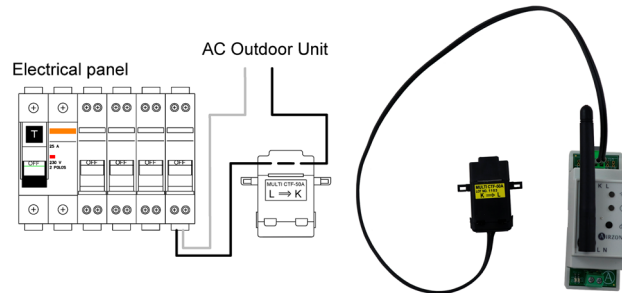

Error 17: Communication error between Lutron Integration Gateway – Systems

The system loses communication with the Airzone Lutron Interface. Check that the gateway is properly connected to the automation bus of the Main Board.

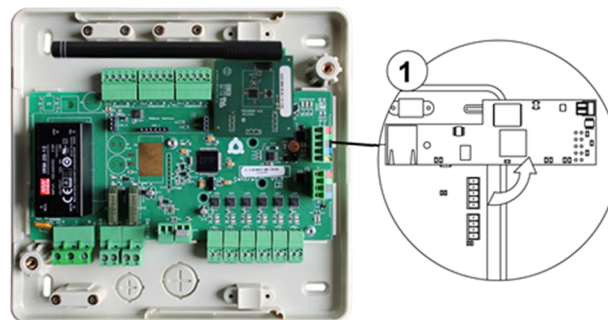

Error C-02: Main Control Board – Production Control Board communication error

This incident blocks the control of the zone. To solve this incident check:

1. Status of the control module of the radiant elements: Correctly powered.
2. Status of the Main Control Board: Expansion bus LEDs are operating properly.
3. Connection: Check the polarity of the connectors of the CCP and the Main Control Board of the system.

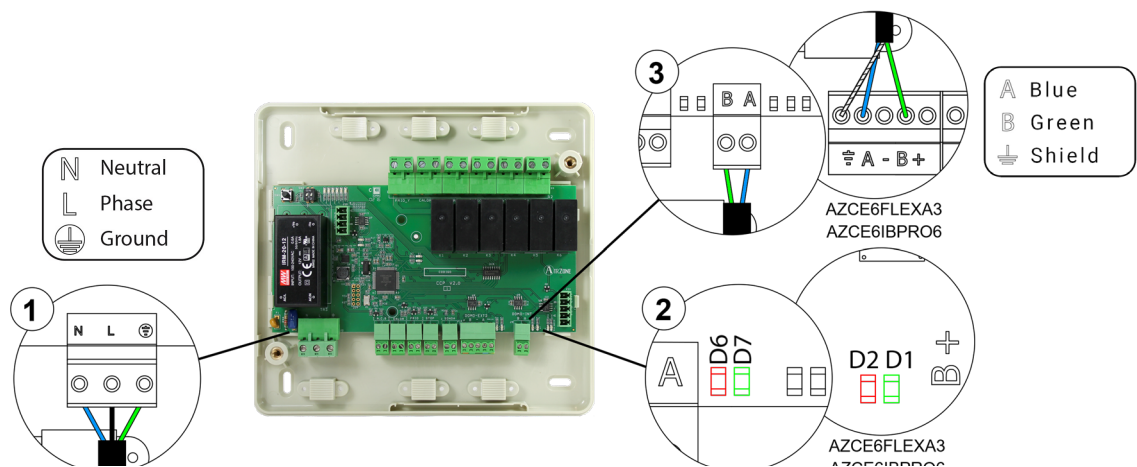

Error C-09: Aerothermal Gateway-Production Control Board Communication Error

The system loses communication with the Gateway and, therefore, with the aerothermal system. The control of the system will be disabled, enabling the system to work from the manufacturer's thermostat. To solve this incident check:

1. Verify that the Gateway is properly connected to the unit port of the Production Control Board.
2. Check the status of the LEDs of the gateway. To do this check the self-diagnose section or the technical sheet of the gateway.

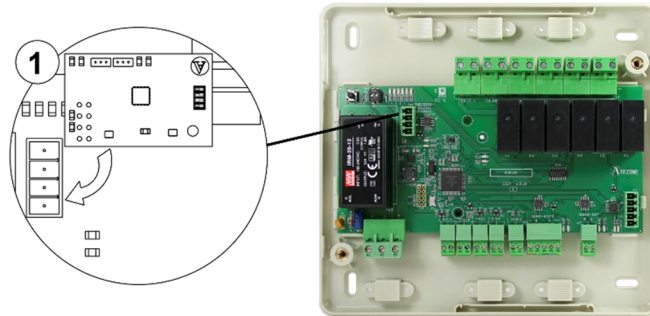

AC unit error: Error in the AC unit

Check the type of error in the AC unit thermostat and follow the instructions provided by the manufacturer.

AIRZONE LITE THERMOSTAT (AZCE6LITE [C/R])

Lite thermostats incorporate LEDs that detect malfunctioning.



This incident is blocking. It blocks the control of the zone. Check that "Error 1" not appear in all thermostats. If so, verify the proper operation of the main board. To solve this incident check:

1. Main control board status: Correctly powered.
2. Main control board status: Airzone connection bus LEDs are operating properly.
3. Connection: Verify the polarity of the main control board and thermostat connectors.
4. Wiring: Check that the voltage between the poles (A/ -) and (B/ -) is correct (1.8 Vdc).



6. Restart system: If the system is restarted, this error may be displayed in the thermostats at the beginning of the process. This message should disappear after around 30 seconds.

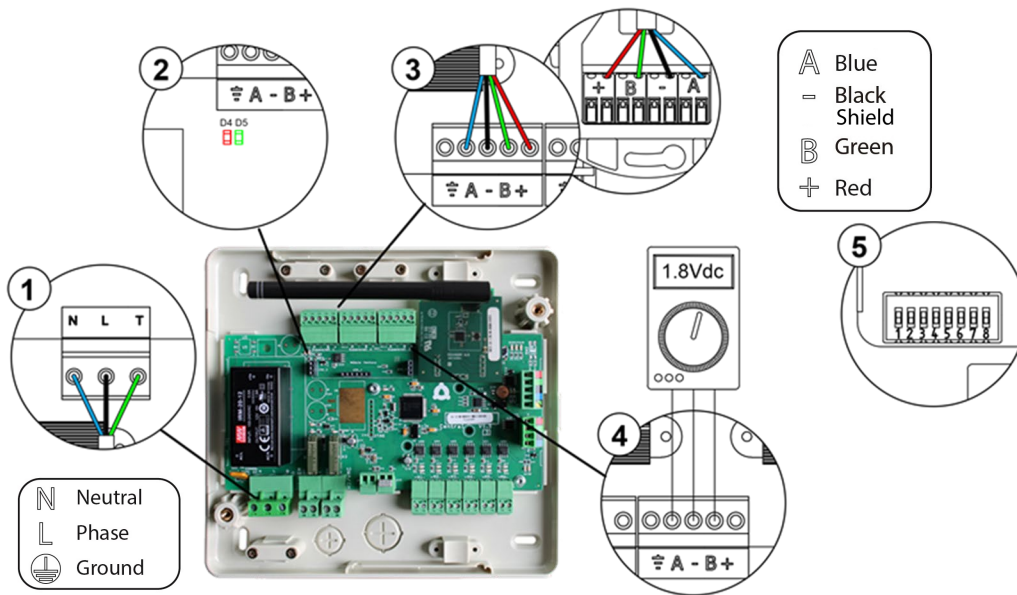

This incident is blocking. It blocks the control of the zone. Check that "Error 1" not appear in all thermostats. If so, verify the proper operation of the main board. To solve this incident, please check:

1. Thermostat status: Check the signal range of the thermostat. Move the thermostat closer to the main control board. If that way the communications are reestablished, it means it is necessary to relocate it permanently as it was out of range.
2. Main control board status: Correctly powered.
3. Main control board status: Proper operation of the LED of wireless communication.



Wireless module inside Advanced settings, zone settings.

5. Restart system: If the system is restarted, this error may be displayed in the thermostats at the beginning of the process. This message should disappear after around 30 seconds.

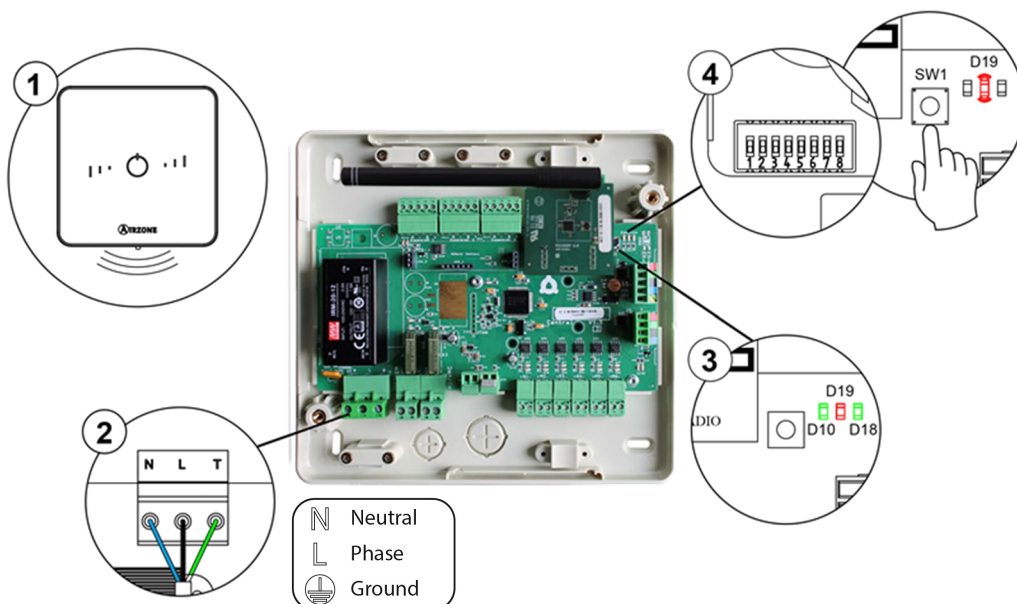

AIRZONE CONTROLLER 3.0 GATEWAY (AZX6GTCXXX)

Airzone controller 3.0 gateway incorporate LEDs that detect malfunctions.

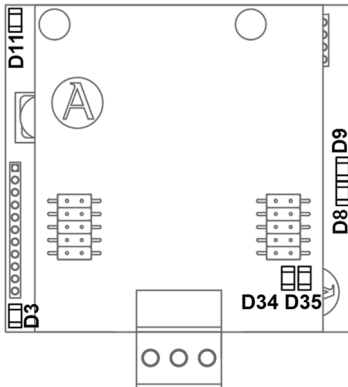

Meaning			
D3	Micro controller activity	Blinking	Green
D8	Data transmission to the Airzone system	Blinking	Red
D9	Data reception from the Airzone system	Blinking	Green
D11	Gateway power supply	Solid	Red
D34	Data transmission to the indoor unit	Blinking	Red
D35	Data reception from the indoor unit	Blinking	Green

In case of abnormal functioning check:

- Check the air conditioning unit is powered.
- Check the connections between the gateway and the AC unit and between the gateway and the thermostat of the AC unit (if applicable).
- Verify the status of the connectors in the wiring connecting gateway-AC unit and/or gateway-aerothermal thermostat.
- Verify the gateway is properly connected to the AC unit port of the main control board.

AIRZONE COMMUNICATION GATEWAYS (AZX6QADAPT XXX)

Inverter gateways incorporate LEDs that detect unusual operations. Consult the distribution of the LEDs in the data sheet supplied along with the product.

1) **Power LED D1: Off**

- Check the air conditioning unit is powered.
- Check the connections between the gateway and the AC unit and between the gateway and the thermostat of the AC unit (if applicable).
- Verify the status of the connectors in the wiring connecting gateway-AC unit and/or gateway-aerothermal thermostat.
- Verify the gateway is properly connected to the AC unit port of the main control board.

2) **Microprocessor operation LED D2: Not blinking**

- Contact Airzone After-Sales Department. Your microcontroller does not operate properly.

3) **Communication LEDs D3 and D4: Not blinking**

- Verify the gateway is properly connected to the AC unit port of the main control board.

4) **LEDs D5 and D6 of communication with the indoor unit: Not blinking**

- Check gateway-AC unit connection

5) **LEDs D7 and D8 of communication with the indoor unit thermostat: Not blinking**

- Check gateway-AC unit thermostat connection

0-10 V FANCOIL COMMUNICATION GATEWAY (AZX6010VOLTSZ)

Airzone 0-10 V Fancoil communication gateways incorporate LEDs that detect malfunctions.

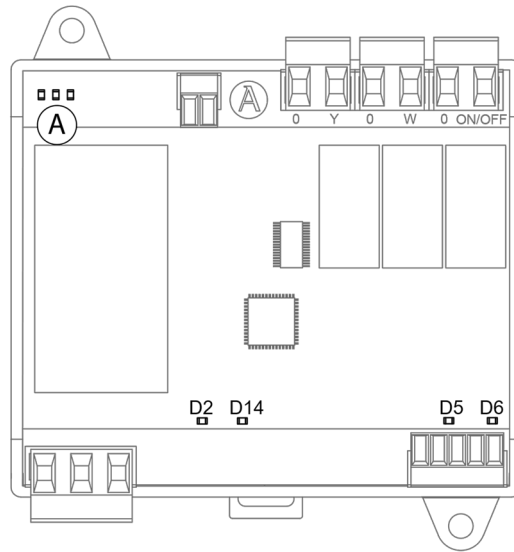

Meaning			
D2	Power supply	Solid	Red
D5	Data reception from AC unit bus	Blinking	Green
D6	Data transmission from AC unit bus	Blinking	Red
D14	Gateway performance	Blinking	Green
(A)	LEDs of relay state	Conmute	Green

FANCOIL COMMUNICATION GATEWAY (AZX6FANCOILZ)

Airzone Fancoil communication gateways incorporate LEDs that detect malfunctions.

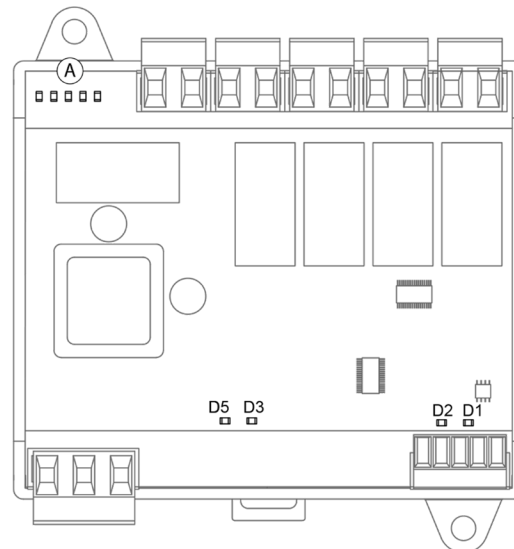

Meaning			
D1	Data reception from AC unit bus	Blinking	Green
D2	Data transmission from AC unit bus	Blinking	Red
D3	Gateway performance	Blinking	Green
D5	Power supply	Solid	Red
(A)	LEDs of relay state	Blinking	Green

AIRZONE CONTROL GATEWAY FOR ELECTROMECHANICAL UNITS (AZX6ELECTROMECH)

Airzone communication gateways for electromechanical units incorporate LEDs that detect malfunctions.

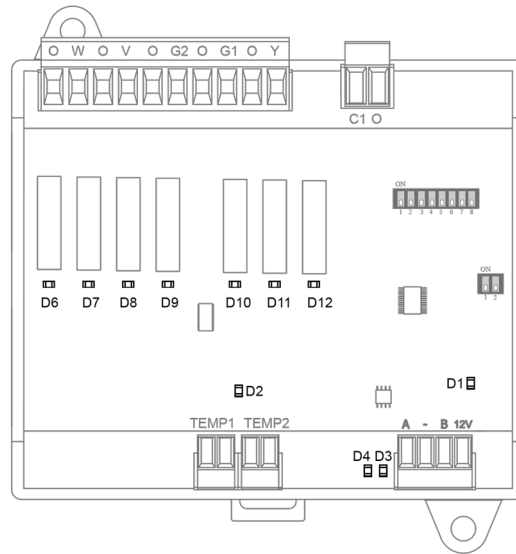

Meaning			
D1	Power supply	Solid	Red
D2	Microprocessor performance	Blinking	Green
D3	Data reception from AC unit bus	Blinking	Green
D4	Data transmission from AC unit bus	Blinking	Red
D6 ... D12	LEDs of relay state	Blinking	Green

WEBSERVER AIRZONE CLOUD (AZX6WEBSCLLOUDC/AZX6WSC5GER)

Airzone Cloud web servers incorporate LEDs that detect malfunctioning.

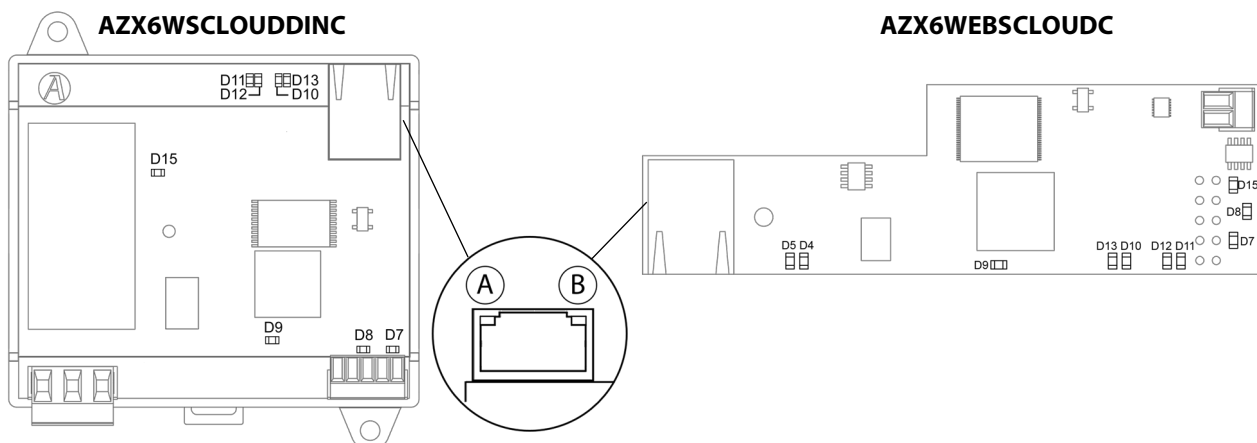

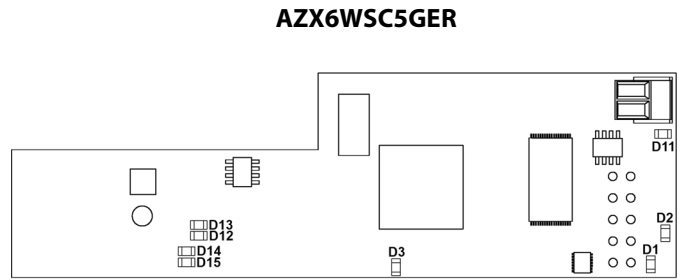
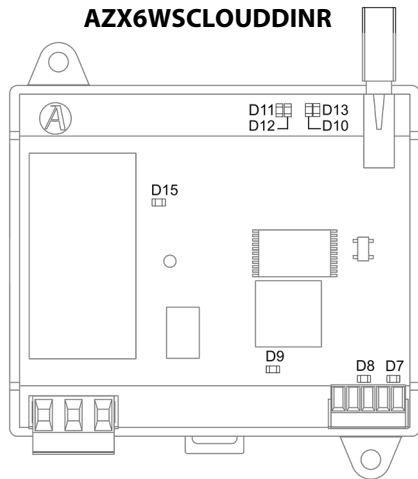

Meaning			
D5	(A)	Ethernet connected	Blinking Green
D4	(B)	Ethernet activity	Blinking Yellow / Red
D7		Data transmission from domotic bus (input and output)	Blinking Red
D8		Data reception from domotic bus (input and output)	Blinking Green
D9		Microprocessor performance	Blinking Green
D10		Connected to the Internet	Blinking Green
D11		Network data transmission	Blinking Red
D12		Network data reception	Blinking Green
D13		Configured as IP address through DHCP	Switch on Red
		Configured as Fixed IP address	Switch off Red
D15		Power supply	Solid Red

AIRZONE HYDRONIC PRODUCTION CONTROL BOARD (AZX6CCPGAWI)

Airzone cloud production control board incorporate LEDs that detect malfunctioning.

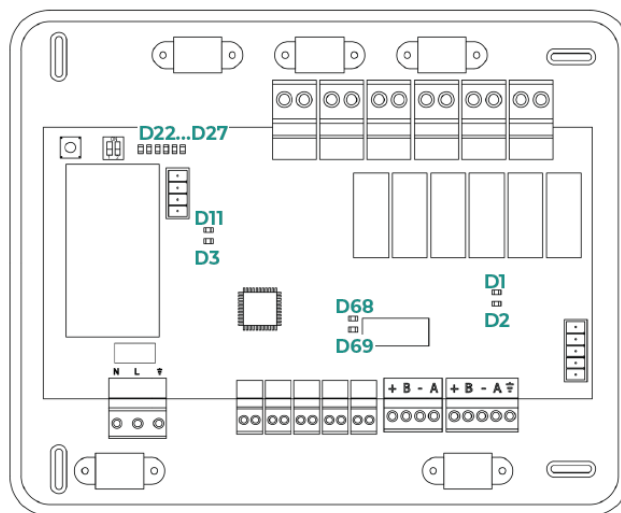

Meaning			
D1		Receiving data from domotic bus	Blinking Green
D2		Transmitting data from domotic bus	Blinking Red
D3		Microprocessor performance	Blinking Green
D11		Power supply	Solid Red
D22...D27		Leds of relay state	Switches Green
D68		Data transmission from integration bus	Blinking Red
D69		Data reception from integration bus	Blinking Green

CLOUD ETHERNET AIRZONE PRODUCTION CONTROL BOARD (AZX6CCPWSCC)

Airzone cloud production control board incorporate LEDs that detect malfunctioning.

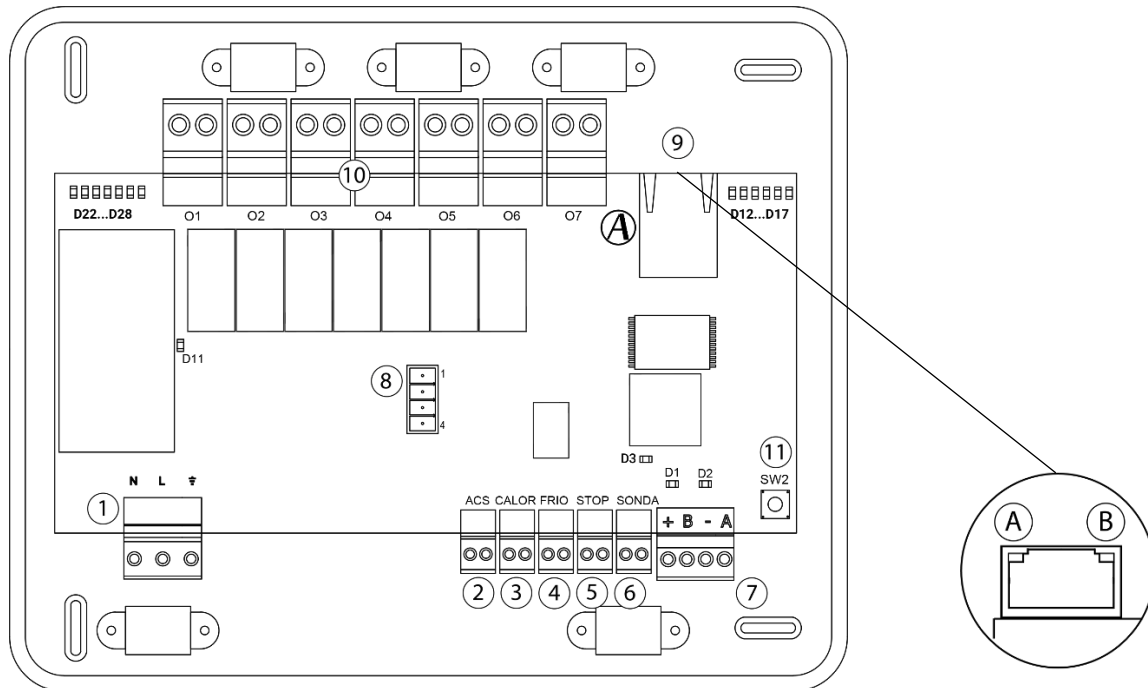

Meaning			
D1	Receiving data from domotic bus	Blinking	Green
D2	Transmitting data from domotic bus	Blinking	Red
D3	Microprocesor performance	Blinking	Green
D11	Power supply	Solid	Red
D12	Connected to the Internet	Blinking	Green
D13	Configured as IP address through DHCP	Switch on	Red
	Configured as Solid IP address	Switch off	
D14	Network data transmission	Blinking	Red
D15	Network data reception	Blinking	Green
D16	Ethernet activity	Blinking	Yellow / Red
D17	Ethernet conectado	Blinking	Green
	Ethernet connected		
(A)	Ethernet connected	Blinking	Green
(B)	Ethernet activity	Blinking	Yellow / Red
D22...D28	Leds of relay state	Switches	Green

AIRZONE PRODUCTION CONTROL BOARD (AZX6CCP)

Airzone production control boards incorporate LEDs that detect malfunctions.

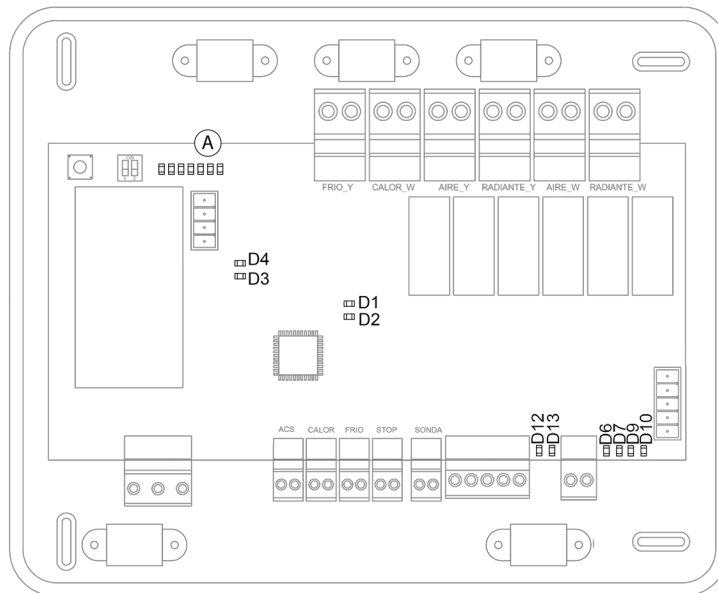

Meaning			
D1	Power supply	Solid	Red
D2	Microprocessor performance	Blinking	Green
D3	Data transmission from AC unit bus	Blinking	Red
D4	Data reception from AC unit bus	Blinking	Green
D6	Transmitting data from internal domotic bus	Blinking	Red
D7	Receiving data from internal domotic bus	Blinking	Green
D9	Transmitting data from external domotic bus 1	Blinking	Red
D10	Receiving data from external domotic bus 1	Blinking	Green
D12	Transmitting data from external domotic bus 2	Blinking	Red
D13	Receiving data from external domotic bus 2	Blinking	Green
(A)	LEDs of relay state	Solid	Green

AIRZONE AEROTHERMAL GATEWAYS (AZX6GAW XXX)

Aerothermal gateways incorporate LEDs that detect unusual operations.

Consult the distribution of the LEDs in the data sheet supplied along with the product.

Meaning			
D3	Micro controller activity	Blinking	Green
D8	Data transmission to the Airzone system	Blinking	Red
D9	Data reception from the Airzone system	Blinking	Green
D11	Gateway power supply	Solid	Red
D34	Data transmission to the indoor unit	Blinking	Red
D35	Data reception from the indoor unit	Blinking	Green

AIRZONE-KNX INTEGRATION GATEWAY (AZX6KNXGTWAY)

Airzone-KNX integration gateway incorporates LEDs that detect malfunctions.

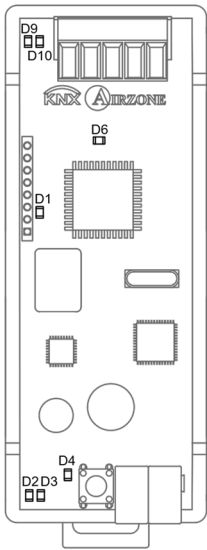

Meaning			
D1	Microprocessor performance	Blinking	Green
D2	Data reception from KNX bus	Blinking	Green
D3	Data transmission from KNX bus	Blinking	Red
D4	LED Programming	Solid	Red
D6	Power supply	Solid	Red
D9	Data reception from domotic bus	Blinking	Green
D10	Data transmission from domotic bus	Blinking	Red

AIRZONE-BACNET INTEGRATION GATEWAY AND AIRZONE-LUTRON INTEGRATION GATEWAY (AZX6BACNET AND AZX6GTILUT)

Airzone-bacnet and Airzone-Lutron integration gateways incorporates LEDs that detect malfunctions.

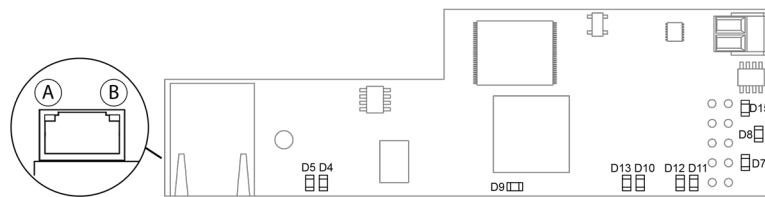

Significado				
D5	(A)	Ethernet connected	Blinking	Green
D4	(B)	Ethernet activity	Blinking	Yellow / Red
D7		Data transmission from automation bus	Blinking	Red
D8		Data reception from automation	Blinking	Green
D9		Microprocessor performance	Blinking	Green
D10		Connected to the Internet	Blinking	Green
D11		Network data transmission	Blinking	Red
D12		Network data reception	Blinking	Green
D13		Configured as IP address through DHCP	Switch on	Red
		Configured as Fixed IP address	Switch off	
D15		Power supply	Solid	Red

AIRZONE CONSUMPTION METER (AZX6ACCCON)

Airzone consumption meter incorporates LEDs that detect malfunctions.

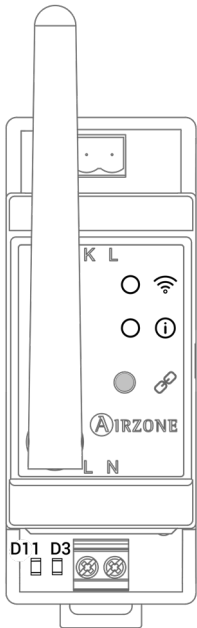

Meaning			
Wi-Fi	Green	Solid	Good signal
	Yellow	Solid	Medium signal
	Orange	Solid	Low signal
		Solid	Without signal
	Red	1 blinking	Main control board already associated
		2 blinking	Main control board not found
Purple	Blinking	Error of communication with main control board	
i	Blue	Solid	Not connected
		Blinking	Searching...
	Green	Solid	Connected
	Blinking	Data processing error	
D3	Gree	Blinking	Microprocessor performance
D11	Red	Solid	Power supply

NAVIGATION TREES

NAVIGATION TREE - BLUEFACE THERMOSTAT

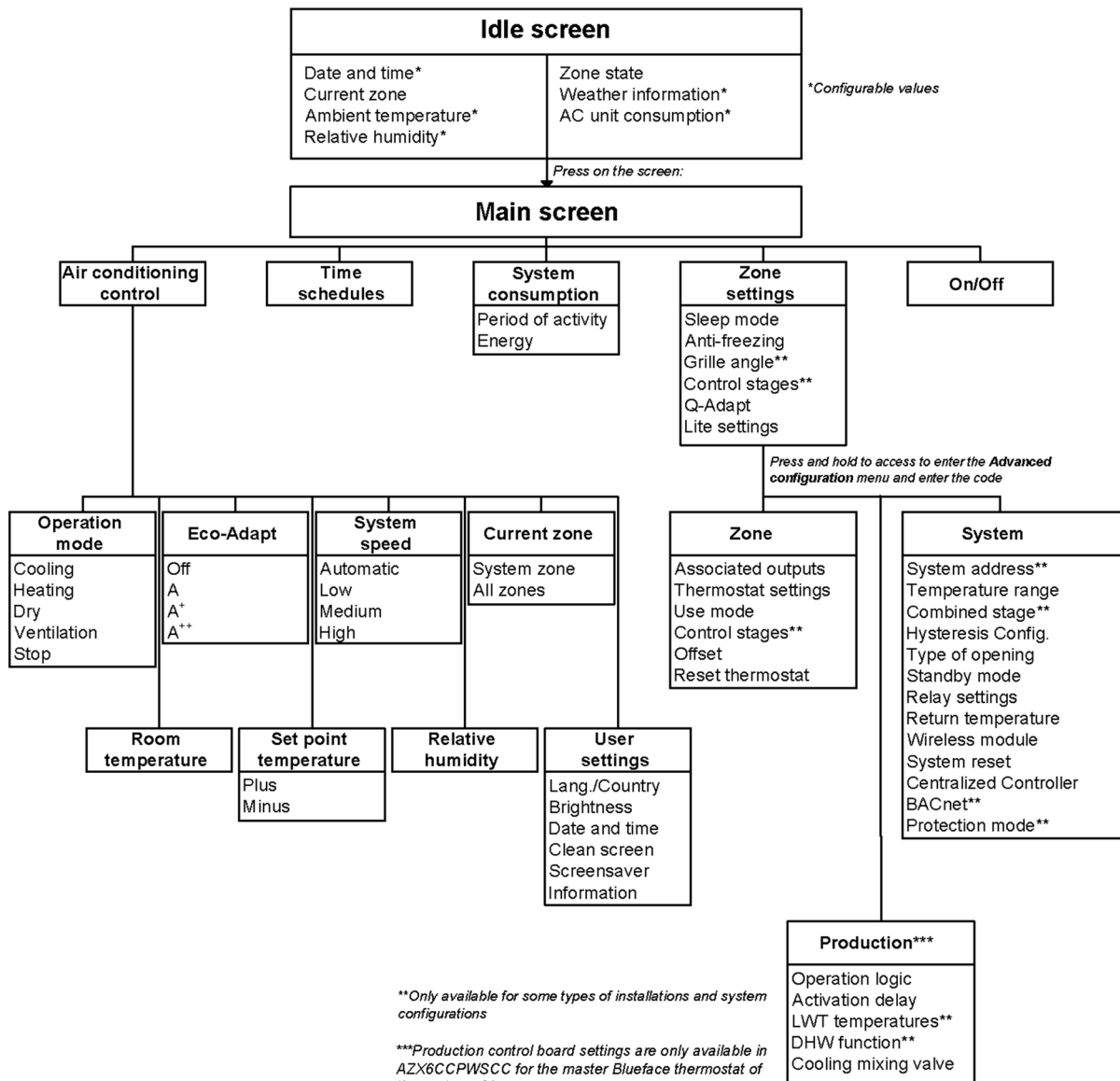
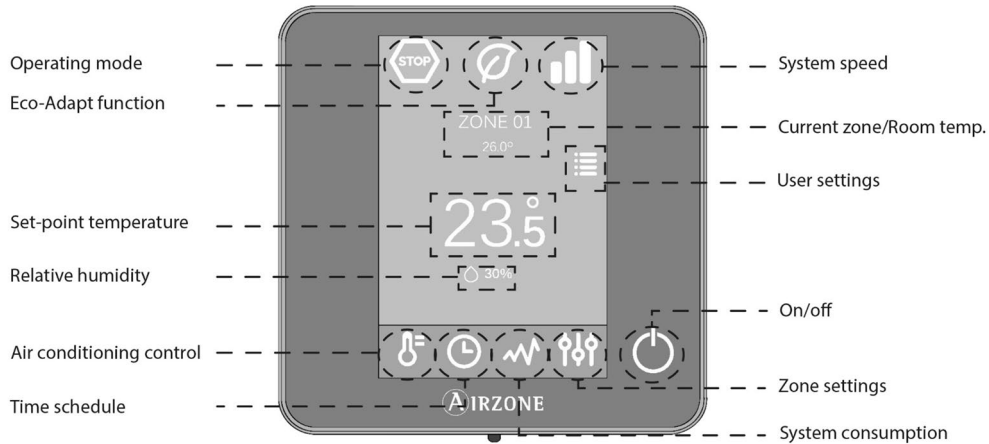

NAVIGATION TREE - THINK THERMOSTAT

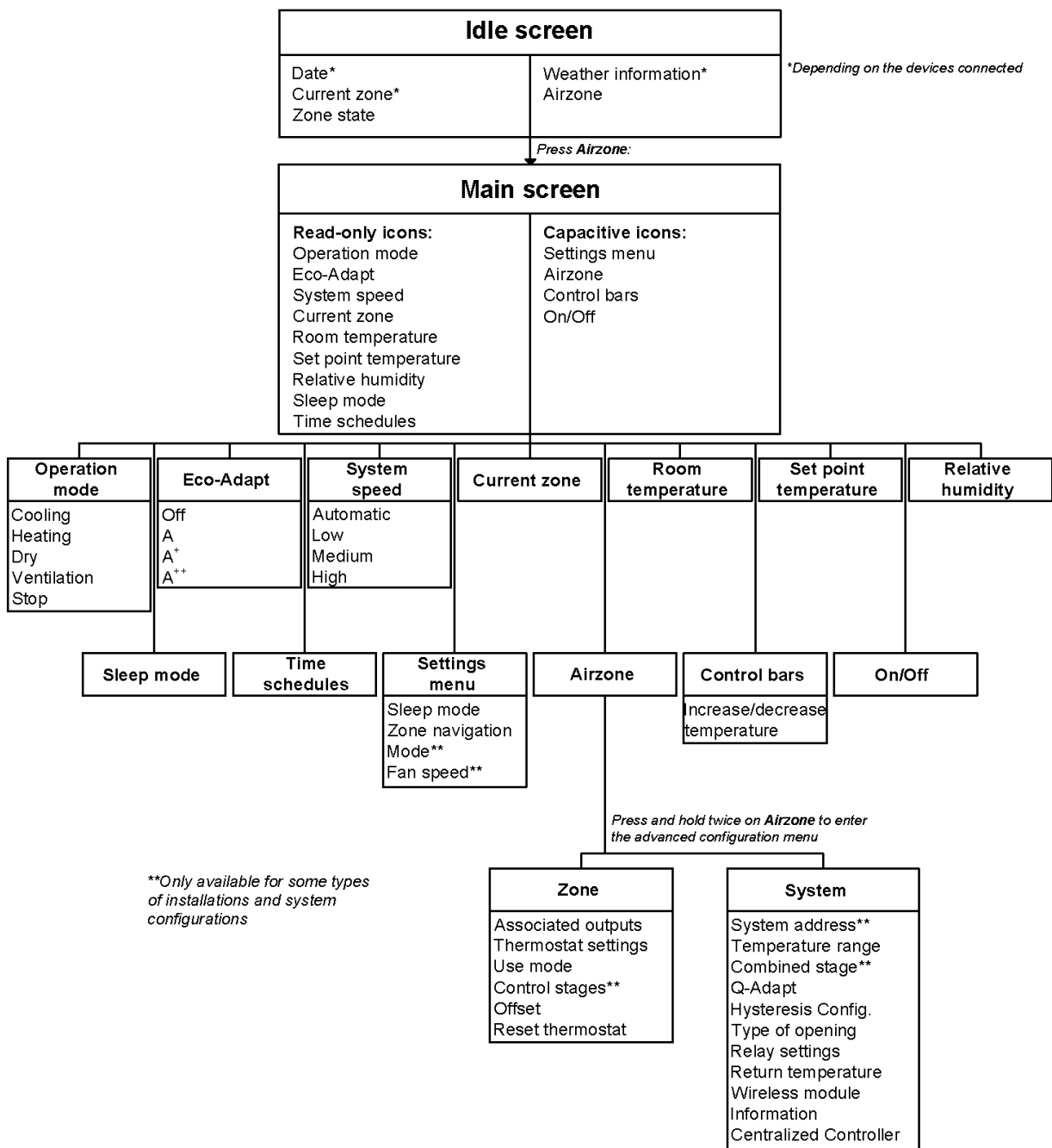
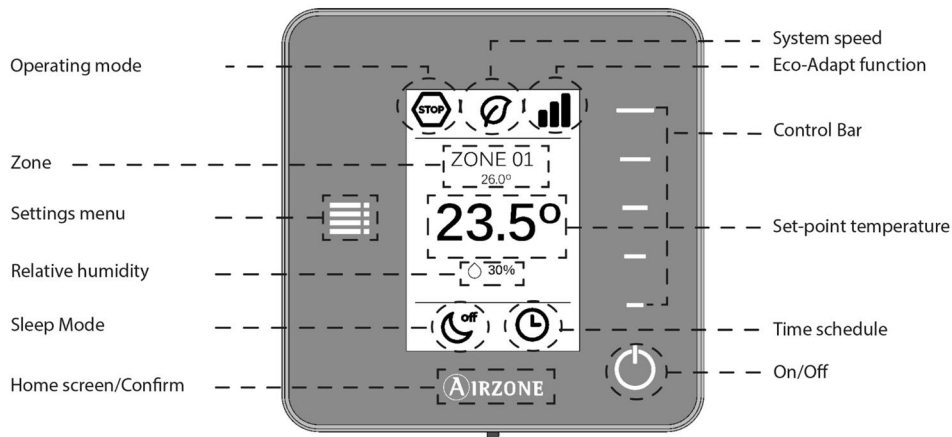

**Only available for some types of installations and system configurations

AIRZONE

Marie Curie, 21 - 29590

Campanillas - Málaga (España)

Téléfono: +34 900 400 445

Fax: +34 902 400 446

<http://www.myzone.airzone.es>

Parc Tertiaire Silic – Inmeuble Panama

45 Rue Villeneuve

94573 Rungis - France

Téléphone: +33 184 884 695

Fax: +33 144 042 114

<http://www.myzone.airzonefrance.fr>

Via Fabio Filzi, 19/E – 20032

Cormano – Milano - Italia

Telefono: +39 02 56814756

Fax: +39 02 56816158

<http://www.myzone.airzoneitalia.it>

