

APRICUM



MECip

KNX IP Router

Technical & Application Description

This document is property of the company named at the last page. Without written approval, it may not be reproduced or commercialised, distributed or presented to other individuals for commercial purpose. Details and information contained within may be subject to change without notice. For the accuracy of the document no warranty is given. All rights reserved.

Content

1	Product Description	3
1.1	Front Panel	4
1.2	LED Indication	5
1.3	Commissioning	6
1.4	Feature Summary	7
2	KNXnet/IP	8
2.1	IP Tunneling	8
2.2	IP Routing	8
2.3	IP Bootloader / Boot Mode	8
3	Operational Description	9
3.1	IP Router Application	9
3.2	IP Network	10
3.3	KNX Network Installation	11
3.4	Programming	12
3.4.1	Programming Button	12
3.4.2	Physical Address Assignment	12
3.5	Function Button	13
3.5.1	Manual Function	13
3.5.2	Factory Reset	13
3.5.3	Boot Mode Activation	13
3.5.4	LED Status Display	14
4	ETS Database Parameters	15
4.1	General	15
4.2	IP Configuration	16
4.3	KNX Multicast Address	17
4.4	Main Line (IP)	18
4.5	Subline (KNX TP)	19
5	Web Front-end	21
5.1	Accessing the MECip Web Front-End	21
5.1.1	via Windows Network UPnP	21
5.1.2	via IP Address	22
5.1.3	via MAC Address	22
5.2	Device Info	23
5.3	KNX	24
5.4	Firmware Update / Boot Mode	25
5.5	IP Tunneling Address Assignment	27
6	State of Delivery	28
6.1	Default Factory Setting	28
6.2	Technical Datasheet	29
6.3	Technical Drawings	30
7	Legal Notice	31
8	FAQ	32

1 Product Description

The KNX IP media coupler MECip works as a KNX IP Router to provide a bi-directional data connection between KNXnet/IP main line and KNX TP subline. KNX IP and KNX TP are coupled having a galvanic isolation in between. Extended frames and long telegrams with up to 240 bytes APDU length are supported.

MECip can be used to connect a KNX TP line or area to KNX IP or an Ethernet network. In this way, several TP lines, TP areas or different KNX TP installation systems can be connected via an IP Backbone, Ethernet network or the Internet. Telegram filtering is accomplished according to the installation place in the hierarchy (Physical Telegrams) and according to the built in filter tables for group communication (Group Telegrams). For detailed diagnosis, all operational modes/states are shown by a duo-LED display. Programming on IP side from the subline can be suppressed. Number of repetitions on subline can be reduced.

With the ETS (or compatible commissioning tool), MECip can also work as a KNX programming interface having no KNX communication objects for itself. Connecting a personal computer to the KNX TP bus can ideally be done via IP connection. For Tunneling and Routing up to four tunneling addresses can be used.

To ease commissioning and troubleshooting, special routing/repetition/confirmation ETS settings and a configurable Manual Function for short-time telegram filter switch-off are available. E.g. “transmit all group telegrams” can be activated by a single button press. After the set time period, MECip switches back to normal operation automatically. Another feature to increase the data throughput is the ability to send IACKs (on TP side) on own telegrams.

For IP Tunneling, up to four tunneling addresses can be used. A comfortable Web front-end to watch the busload history, to remotely control MECip in a network and to update the firmware via IP is provided. It is easy to identify the MECip in a network by remotely switching on its Programming LED.



In this document, physically addressed telegrams are named Physical Telegrams.



In this document, group oriented telegrams are named Group Telegrams.

1.1 Front Panel

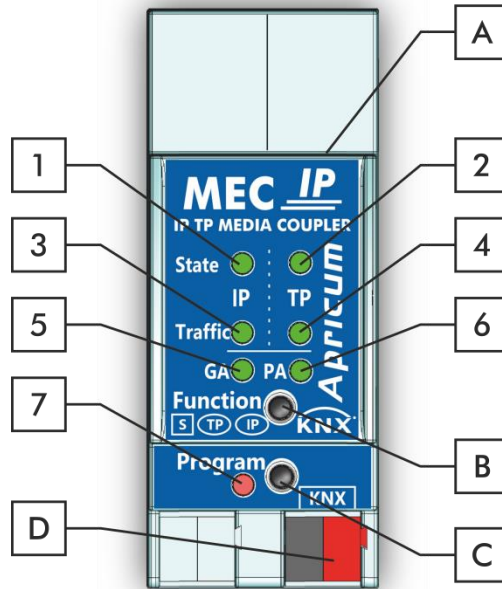

Figure 1: Front View

Table 1: Front Panel Elements

LEDs		Buttons / Connectors	
1	State IP (Main line)	A	Ethernet Connector
2	Bus State KNX TP (Subline)	B	Function Button
3	Telegram Traffic IP (Main line)	C	Programming Button
4	Telegram Traffic KNX TP (Subline)	D	KNX TP Connector
5	Group Address Routing*		
6	Physical Address Routing		
7	Programming LED		

* only group telegrams with main groups 0...13

1.2 LED Indication

If MECip is used as IP Router without physical address x.y.0, LED 6 (PA) works not like described here.

Table 2: LEDs Colours

Number	LED	Colour	Explanation / Range
1	State IP (Main line)	green	IP line OK
		orange	Manual Function active
		< off >	No IP connection
2	Bus State KNX TP (Subline)	green	Subline OK
		< off >	Subline not connected
3	Telegram Traffic IP (Main line)	blinking green	Telegram traffic extent indicated by blinking
		< off >	No telegram traffic
4	Telegram Traffic KNX TP (Subline)	blinking green	Telegram traffic extent indicated by blinking
		blinking red	Transmission error
		< off >	No telegram traffic
5	Group Address Routing	green	Filter table active
		orange	Route all
		red	Block all
		< off >	Routing of Group Telegrams is different on main line and subline
6	Physical Address Routing	green	Filtering active
		orange	Route all
		red	Block all
		< off >	Routing of Physical telegrams is different on main line and subline
7	Programming LED	red	Programming Mode / Boot Mode active
		blinking red	No IP connection
		< off >	Programming Mode / Boot Mode not active

1.3 Commissioning

Please note for commissioning with default settings:

- All telegrams are blocked because the filter table is not defined
- The Manual Function switch-off time is 120 min
- Physical address is 15.15.0

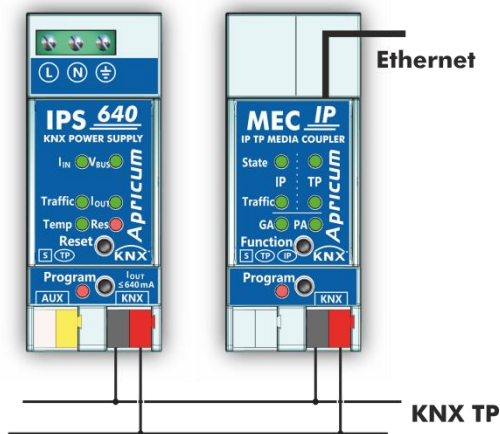

Figure 2: Connection Scheme

Please read carefully before first use:

- After connection to the KNX bus system, the device works with its default settings
- **Warning: Do not connect to 230 V. The device is supplied by the KNX bus and does not require any additional external power supply**
- The device may only be installed and put into operation by a qualified electrician or authorized personnel
- For planning and construction of electric installations the appropriate specifications, guidelines and regulations in force of the respective country have to be complied
- For mounting use an appropriate equipment according to IEC60715
- Installation on a 35 mm DIN rail (TH35)
- Connect the KNX bus line as for common KNX bus connections with a KNX bus cable, to be stripped and plugged into a KNX TP connector
- Do not damage electrical insulations during connecting
- Installation only in dry locations
- Accessibility of the device for operation and visual inspection must be provided
- For changing the configuration use the ETS
- The housing must not be opened
- Protect the device from moisture, dirt and damage
- The device needs no maintenance
- If necessary, the device can be cleaned with a dry cloth
- In the case of damage (at storage, transport) no repairs may be carried out by unauthorized personnel

1.4 Feature Summary

- MECip supports extended frames and long telegrams up to 240 bytes APDU length. (With all MEC couplers and UIM interfaces long messages e.g. for energy metering applications and visualization purposes can be processed.)
- MECip favourably replaces a common TP line/area coupler. The great advantage is using KNX IP as a fast KNX backbone medium.
- MECip works without external power supply.
- For IP Tunneling, four different tunneling connections, with a separate address for each, can be realized in parallel. Quick assignment can be done by the web front-end.
- IACK sending on sent out messages is ETS configurable.
- When there is no IACK response on the subline, MECip is able to repeat messages up to three times. Repetition can be configured for both Physical Telegrams and Group Telegrams via ETS (to ease troubleshooting). E.g. after an IACK response no repetition is following and the negative IACK/BUSY failure mechanism is maintained.
- For an ETS configurable time period, it is possible to switch off telegram filtering by only pressing a button on the device front panel. Without additional ETS download filtering is suspended. This is necessary for running fast diagnostics on site.
- Temporarily suspending telegram filtering eases commissioning and debugging. Without ETS download temporary access to other lines becomes possible.
- Automatic function for switching back to run-time telegram filtering after configurable suspension period (see Manual Mode). This avoids forgetting the reactivation of filtering.
- UPnP is available to discover the device within the IP network. This can only be realized by a proper network installation in terms of topology. With use of KNXnet/IP, ETS is able to recognize the communication interface device.
- Updating the firmware can easily be accomplished by a Web browser. The available Web front-end provides informative settings and enables to remotely switch the device into Programming Mode without use of the Programming Button.
- In networks with high busload the internal amount of communication buffers are capable of smoothing peaks in the communication load course.
- In the web front-end, a diagram of a 60 min busload history can be watched.
- MECip's ETS database entries are available for ETS4 and later.
- MECip supports KNXnet/IP, ARP, ICMP, IGMP, HTTP, UPnP discovery, UDP/IP, TCP/IP, DHCP und AutoIP.

2 KNXnet/IP

MECip is a KNX IP router. KNX IP routers are highly similar to TP line couplers. The only difference is that they use the IP communication medium as main line and the KNXnet/IP communication protocol. However, KNX end devices can be integrated directly via IP. This makes the Ethernet a real KNX medium.

As documented in the KNXnet/IP protocol specifications, KNX telegrams can be transmitted encapsulated in IP packets. Ethernet networks as well as Internet can be used to route or tunnel KNX telegrams. In this way, IP interfaces and IP routers are an alternative to USB data interfaces and TP line/area/backbone couplers, respectively. In the latter case, a TP backbone can be completely replaced by a fast Ethernet based line then called IP backbone.

2.1 IP Tunneling

The presence of the Internet Protocol (IP) has led to the definition of the KNXnet/IP protocol. KNXnet/IP offers the possibility for point-to-point connections for the ETS (KNXnet/IP Tunneling) and/or between supervisory system and KNX installation. The KNXnet/IP device management enables KNXnet/IP device configuring via the KNX network in order to reduce the time required for complete network configuration.

2.2 IP Routing

IP Routing is the way of interconnecting KNX lines and areas by IP network(s) via KNXnet/IP. In IP networks, the KNXnet/IP Routing defines the way of KNXnet/IP router communication.

2.3 IP Bootloader / Boot Mode

The IP bootloader function is used to update the firmware and completely rewrite the flash memory content. This is not just a simple application download. Both communication stack and application software are downloaded.

The firmware update procedure via IP is executed by a web front-end, which is independent from ETS, and makes use of special messages to speed up the process. To be protected, their contents are encrypted.



Entering Boot Mode is equivalent to activating the IP bootloader function.

3 Operational Description

In network installations MECip is used as KNX IP line/area coupler to couple KNX IP and KNX TP. After connecting to KNX TP, MECip operates with its default settings. Setting the correct physical address is necessary to include MECip in the present KNX bus system. Only physical addresses x.y.0 are allowed to be set.

3.1 IP Router Application

When MECip receives telegrams (for example during commissioning) that use physical addresses as destination addresses, it compares the physical addresses of the receiver with its own physical address and decides on that whether it has to route the telegrams or not.

When MECip receives telegrams that use group addresses as destination addresses, it reacts in accordance with the parameter settings. During normal operation (with Group Telegram routing set to filter), MECip only routes telegrams whose group addresses are entered in its filter table.

If a telegram is routed by MECip without receiving the corresponding acknowledgement, i.e. due to a missing receiver or to a transmission error, the telegram will be repeated up to three times (depending on the ETS setting). With the parameters „Repetitions if errors...“, this function can be configured separately for each line and both kinds of telegrams. It is recommended to use the default parameter setting.

IP Router is designed for use in 10/100 BaseT networks compliant to IEEE802.3. The AutoSensing function sets the baud rate (10 Mbit or 100 Mbit) automatically. IP address can be received from a DHCP server. For this, the automatic assignment setting of the IP address can be set by ETS (use DHCP). If set so and no DHCP server is found, MECip starts an AutoIP procedure and autonomously assigns the IP address. The IP address that MECip receives during its start-up (via DHCP or AutoIP) is retained until next start-up (e.g. due to power off or reprogramming). If MECip is supposed to have a fixed IP address (as well as subnet mask and standard gateway) it can be set by ETS.



ETS does not provide an unload procedure for applications.

3.2 IP Network

MECip sends telegrams from/to the TP network to/from the IP network in accordance with the KNXnet/IP protocol specification. According to the default setting these telegrams are sent as multicast telegrams to the multicast IP address 224.0.23.12 port 3671. The multicast IP address 224.0.23.12 is the defined address for the KNXnet/IP by KNX Association in conjunction with the IANA. It is recommended to use this default address as defined. Only if it becomes necessary due to the existing network, the address can be changed as shown in chapter 4.3 KNX Multicast Address. Important notes:

- All KNX IP devices that are intended to communicate with each other via IP must have the same IP multicast address.
- Multicast IP address 224.0.23.12 may need to be changed in respect of the network type and of the network components' settings.
- IGMP (Internet Group Management Protocol) is used for IP configuration to establish multicast group belonging.
- If the IP address is changed from the IP side it may happen that ETS does no longer recognize the device and connection cannot be maintained (tunneling uses IP addresses). So, it is recommended to change IP addresses and restart only from TP side.
- If problems occur for IP address assignment please ask your network administrator.
- According to the topology, the Tunneling addresses always have to be assigned in the range of subline addresses. For more information about additional physical addresses for tunneling please refer to IP Tunneling Address Assignment.
- To program devices of a line different to which the device used for (re)programming is connected the use of a correct topology is mandatory!

3.3 KNX Network Installation

For line coupler functionality in a KNX network MECip has to use the correct physical address of a coupler (x.y.0, $1 \leq x \text{ \& \ } y \leq 15$). In ETS, up to 225 addresses can be defined from 1.1.0 to 15.15.0.

For backbone coupler functionality in a KNX network MECip has to use the correct physical address of an area coupler (x.0.0, $1 \leq x \leq 15$). In ETS, up to 15 areas can be defined.

In a KNX system with MECip backbone couplers and MECtp line couplers, it is necessary to ensure that MECip has an address assigned from a free addressing area. Following figure illustrates a possible topology scenario.

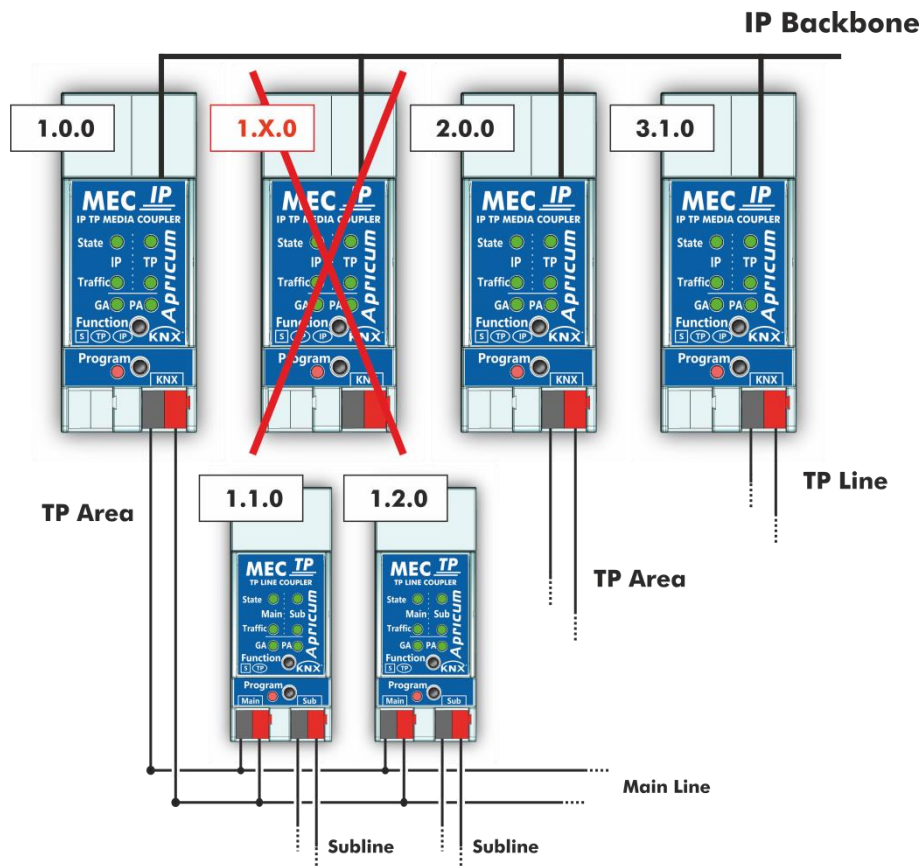

Figure 3: MECip Network Topology

Example: If a KNX IP router with address 1.0.0 already exists on the backbone no KNX IP router with address 1.x.0 can be added here. Even if no line coupler with address 1.1.0 exists on the subline of the 1.0.0 router. Vice versa, when line couplers with addresses 1.x.0 already exist in an installation, an IP router with address 1.0.0 cannot be added differently as shown in Figure 3.

3.4 Programming

3.4.1 Programming Button

To download the desired physical address or an ETS setting the Programming Mode must be activated. Successive pressing the Programming Button will turn on and off the Programming Mode. LED 7 lighting in red colour indicates Programming Mode is active. When Programming Mode is activated, the ETS is able to download the physical address.



A blinking red Programming LED indicates the Ethernet cable is not properly connected or no IP network connection is available.



Also when Boot Mode is active, successive pressing the Programming Button will turn on and off Programming Mode and Programming LED.

3.4.2 Physical Address Assignment

To configure the device an interface connection (IP, USB) to the KNX bus system is required. The device is supplied with the individual physical address 15.15.0. The KNX product database entry (available for ETS4 and higher) can be downloaded from the Apricum website and from the KNX Online Catalog.

The physical address can be assigned to the device by setting the desired address in the properties window of the ETS. After starting the ETS download and then pressing the Programming Button the device restarts itself.

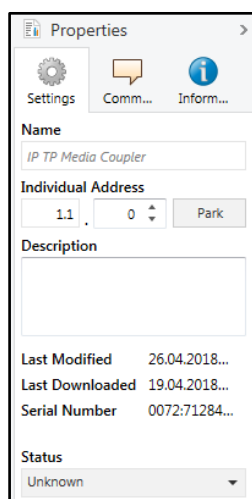

Figure 4: ETS Properties Window



In this document only the term “physical address” is used. The term “physical address” means the KNX physical address as well as the ETS individual address. Both terms are used by the KNX organisation interchangeably.

3.5 Function Button

The Function Button activates MECip’s special functions. Manual Function and Factory Reset can be activated. Device settings of MECip can be reset to manufacturer default values with the Factory Reset function. During the firmware update procedure the Function Button has to be pressed for Boot Mode activation.

3.5.1 Manual Function

During normal operation a rather short press (≈ 3 sec) activates and deactivates the Manual Function. LED 5 and LED 6 show the current filtering states.

When the Manual Function is active, either all Physical Telegrams or all Group Telegrams or both pass the MECip without filtering. After the Switch-off time period has elapsed MECip automatically switches back to normal operation. To configure the Manual Function and set the Switch-off time use the parameter tab General like shown in chapter 4.1 General. After switching back from Manual Function to normal operation the latest downloaded parameter setting / filter table entries are active again.

3.5.2 Factory Reset

A long press (≈ 15 sec) of the Function Button soon followed by a short press (≈ 3 sec) executes the Factory Reset. After the first press, the LED display lights like described in Table 4. After the second press, all parameters will be set to factory default (incl. physical address). Subsequently, LEDs indicate normal operation again.

3.5.3 Boot Mode Activation

To start the firmware update process, Boot Mode must be activated. During this process, a press on the Function Button is necessary. After a click on the “request update” button, MECip enters Boot Mode (see chapter 5.4 Firmware Update / Boot Mode).

BOOT MODE	Device is currently running in boot mode.
Device Info	Status: update authorized DHCP: false IP Address: 192.168.1.158 Subnet Mask: 255.255.255.0 Gateway: 192.168.1.201 DNS: 192.168.1.2 Http Port: 8080 MAC Address: 00-00-00-00-00-05 KNX Serial: FF-FF-FF-FF-FF-FF Hostname: KNX-IPRT-000005 Description: KNX IP Router UDN: uuid:1f6b0c73-6308-1f55-4a51-000000000005 Bootloader SW version: 2.2
Update	

Figure 5: Boot Mode is active

3.5.4 LED Status Display

Table 3: LED Status Display for Manual Function

Number	LED	Colour	Comment
1	State IP	orange	Lights red if not connected
2	Bus State KNX TP	green	
5	Group Address Routing	green:	filter
6	Physical Address Routing	orange:	route all
		red:	block all



Table 4: LED Status Display for Factory Reset after first Button Press

Number	LED	Colour	Comment
1	State IP	orange	Lights red if not connected
2	Bus State KNX TP	orange	
5	Group Address Routing	green:	filter
6	Physical Address Routing	orange:	route all
		red:	block all





Table 5: LED Status Display for Boot Mode

Number	LED	Colour	Comment
1	State IP	green	
2	Bus State KNX TP	blinking green	
3	Telegram Traffic IP	blinking green	not the same tempo as LED2
7	Programming LED	red	



4 ETS Database Parameters

All screen shots are related to the MECip database file R2-1g in ETS5.

4.1 General

The host name is the name with that the device appears within the Windows network.

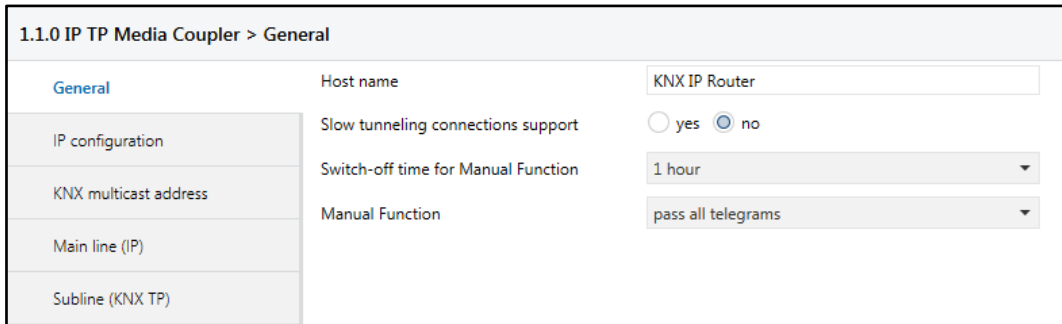

Figure 6: General Tab Parameters

Table 6: General Tab Parameter Settings

ETS Parameter	Setting [Factory Default]	Comment
Host name	<30 Characters allowed> [KNX IP Router]	Field to enter the device name providing an easy search of the device by ETS, by Windows Network and by KNXnet/IP visualisation systems.
Slow tunneling connections support	yes no [no]	Enable to support slow tunneling connections.
Switch-off time for Manual Function	10 min, 1 hour, 4 hours, 8 hours [1 hour]	After expiry of this time period the Manual Function is switched off automatically.
Manual Function	disabled pass all telegrams pass all Physical telegrams pass all Group telegrams [pass all telegrams]	Configuration setting for telegram routing when the Manual Function is active.

4.2 IP Configuration

Here, HTTP port and IP address assignment can be configured.

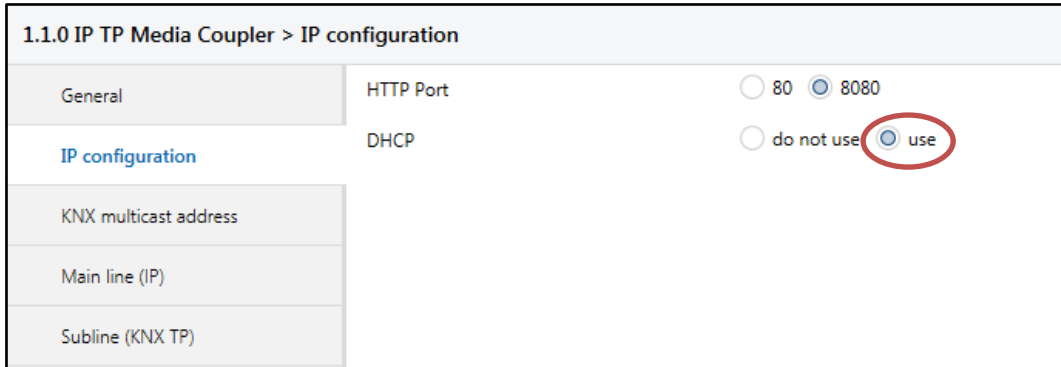

Figure 7: IP Configuration Tab Parameters, DHCP on

Table 7: IP Configuration Tab Parameter Settings, DHCP on

ETS Parameter	Setting [Factory Default]	Comment
HTTP Port	80 8080 [8080]	Select one of the two official system ports.
DHCP	do not use use [use]	If DHCP is used, no further IP parameters have to be set.

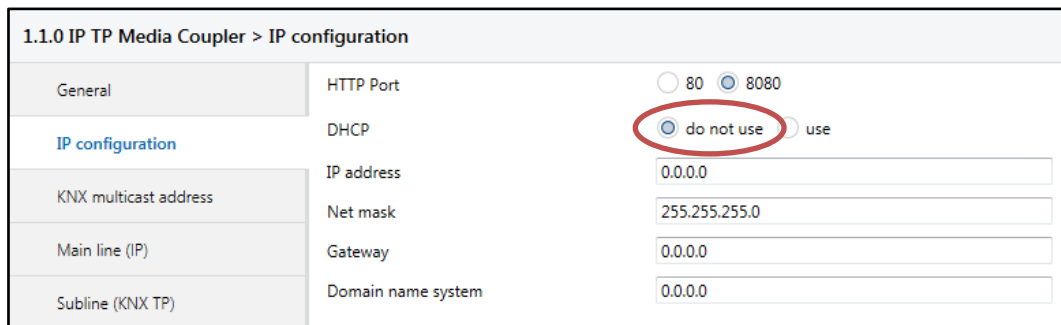

Figure 8: IP Configuration Tab Parameters, DHCP off

Table 8: IP Configuration Tab Parameter Settings, DHCP off

ETS Parameter	Setting [Factory Default]	Comment
IP address	0-255.0-255.0-255.0-255 [0.0.0.0]	IP Byte 1 to 4: manual input.
Subnet mask	0-255.0-255.0-255.0-255 [255.255.255.0]	SM Byte 1 to 4: manual input.
Default gateway	0-255.0-255.0-255.0-255 [0.0.0.0]	DG Byte 1 to 4: manual input.
DNS server	0-255.0-255.0-255.0-255 [0.0.0.0]	DNS Byte 1 to 4: manual input

4.3 KNX Multicast Address

For KNXnet/IP, the multicast address 224.0.23.12 is the defined address from KNX Association in conjunction with IANA. Change this address only if it becomes necessary due to the existing network. Make sure that during commissioning all KNX IP devices intended to communicate with each other via IP use the same multicast address. To ensure proper functioning, execute a manual restart after changing the multicast address.

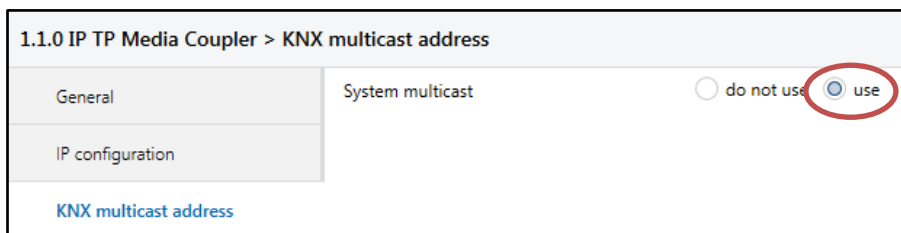

Figure 9: KNX Multicast Address Tab Parameters, System Multicast on

Table 9: KNX Multicast Address Tab Parameter Settings, System Multicast on

ETS Parameter	Setting [Factory Default]	Comment
System multicast	do not use use [use]	System multicast is 224.0.23.12, otherwise 239.0.0.0 will be set.

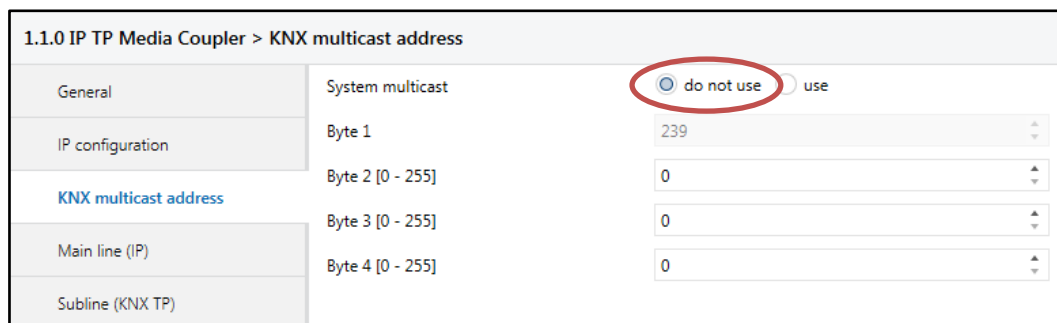

Figure 10: KNX Multicast Address Tab Parameters, System Multicast off

Table 10: KNX Multicast Address Tab Parameter Settings, System Multicast off

ETS Parameter	Setting [Factory Default]	Comment
System multicast	do not use use [use]	If System multicast is not used the multicast address has to be defined manually.
Byte 1 (of the IP address)	224 (System) 239 [239]	If System multicast address is used "224" is set permanently. Otherwise "239" is set permanently.
Byte 2 [0 - 255] (of the IP address)	0-255 [0]	Set manually if System multicast address is not used.
Byte 3 [0 - 255] (of the IP address)	0-255 [0]	Set manually if System multicast address is not used.
Byte 4 [0 - 255] (of the IP address)	0-255 [0]	Set manually if System multicast address is not used.

4.4 Main Line (IP)

For Group Telegrams and Physical Telegrams the setting “transmit all” is intended only for testing purposes. Please do not use for normal operation.

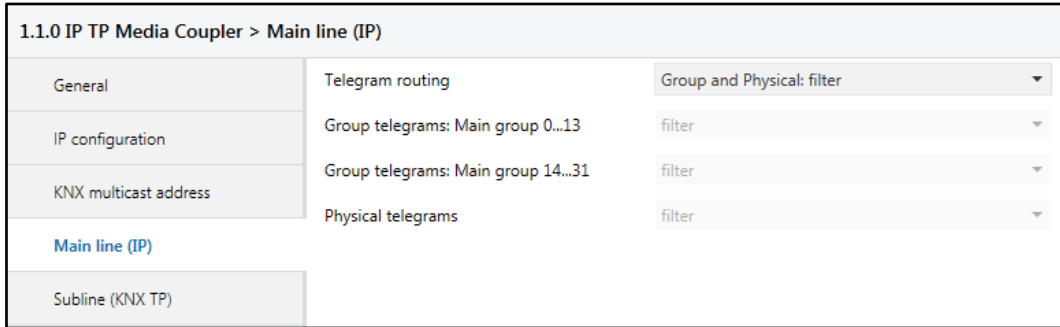

Figure 11: Main Line (IP) Tab Parameters

Table 11: Main Line (IP) Tab Parameter Settings

ETS Parameter	Setting [Factory Default]	Comment
Telegram routing	Group: filter, Physical: block Group and Physical: filter Group: route, Physical: filter Group and Physical: route configure [Group and Physical: filter]	block: no telegrams are routed.
		filter: telegrams entered in the filter table are routed.
		route: all telegrams are routed.
		configure: the following parameters must be set manually.
Group telegrams: Main group 0...13	transmit all (not recommended) block filter [filter]	<ul style="list-style-type: none"> Group telegrams (main group 0...13) are all routed. Group telegrams (main group 0...13) are all blocked. Group telegrams (main group 0...13) are routed if entered in the filter table.
Group telegrams: Main group 14...31	transmit all (not recommended) block filter [filter]	<ul style="list-style-type: none"> Group telegrams (main group 14...31) are all routed. Group telegrams (main group 14...31) are all blocked. Group telegrams (main group 14...31) are routed if entered in the filter table.
Physical telegrams	transmit all (not recommended) block filter [filter]	<ul style="list-style-type: none"> Physical telegrams are all routed. Physical telegrams are all blocked. Depending on the physical address Physical telegrams are routed.

4.5 Subline (KNX TP)

For Group Telegrams and Physical Telegrams the setting “transmit all” is intended only for testing purposes. Please do not use for normal operation.

Figure 12: Subline (KNX TP) Tab Parameters

Table 12: Subline (KNX TP) Tab Parameter Settings

ETS Parameter	Setting [Factory Default]	Comment	
Telegram routing	Group: filter, Physical: block Group and Physical: filter Group: route, Physical: filter Group and Physical: route configure [Group and Physical: filter]	block:	no telegrams are routed.
		filter:	telegrams entered in the filter table are routed.
		route:	all telegrams are routed.
		configure:	the following parameters must be set manually.
Group telegrams: Main group 0...13	transmit all (not recommended) block filter [filter]	<ul style="list-style-type: none"> Group telegrams (main group 0...13) are all routed. Group telegrams (main group 0...13) are all blocked. Group telegrams (main group 0...13) are routed if entered in the filter table. 	
Group telegrams: Main group 14...31	transmit all (not recommended) block filter [filter]	<ul style="list-style-type: none"> Group telegrams (main group 14...31) are all routed. Group telegrams (main group 14...31) are all blocked. Group telegrams (main group 14...31) are routed if entered in the filter table. 	
Physical telegrams	transmit all (not recommended) block filter [filter]	<ul style="list-style-type: none"> Physical telegrams are all routed. Physical telegrams are all blocked. Depending on the physical address Physical telegrams are routed. 	
Physical telegrams: Repetition if errors on subline	no up to 3 repetitions one repetition [up to 3 repetitions]	After subline transmission error (e.g. due to missing receiver) Physical telegrams <ul style="list-style-type: none"> are not repeated. are repeated max. 3 times. are repeated once. 	

ETS Parameter	Setting [Factory Default]	Comment
Group telegrams: Repetition if errors on subline	no up to 3 repetitions one repetition [up to 3 repetitions]	After subline transmission error (e.g. due to missing receiver) Group telegrams <ul style="list-style-type: none"> • are not repeated. • are repeated max. 3 times. • are repeated once.
Telegram confirmation on subline	if routed always [if routed]	<ul style="list-style-type: none"> • Routed telegrams to IP main line are confirmed by an ACK on the subline. • Each telegram on the subline is confirmed by an ACK.
Send confirmation on own telegrams	yes no [no]	<ul style="list-style-type: none"> • Telegrams sent out to the subline are confirmed by added ACK. • No ACK confirmation.
Configuration from subline (KNX TP)	allow block [allow]	If blocked an ETS download to the MECip can occur only via IP main line.

5 Web Front-end

The Web front-end can be used to read out MECip's actual device parameters (HTTP port, IP address, MAC address, ...), to update its firmware and to adjust the (additional) tunneling addresses. To identify a particular MECip of a KNX network the Programming LED/Programming Mode can be remotely switched on and off without pressing the on-device Programming Button.



To switch back from Boot Mode to normal operation it is necessary to run the firmware update procedure and then abort, or wait for the 10 min timeout.

5.1 Accessing the MECip Web Front-End

There are three ways to access the MECip. It can be accessed like a Microsoft Windows UPnP network device (Windows7 or later) and by a web browser. For access by a web browser either the IP address or the MAC address, together with the HTTP port, have to be known. How to use IP address and MAC address with the browser's URL bar is described in the following.



For access via web browser the HTTP port that is set by ETS (or the factory default parameter value) has to be used.



MECip is able to use both official HTTP system ports (80 and 8080).



Factory default HTTP port is 8080.

5.1.1 via Windows Network UPnP

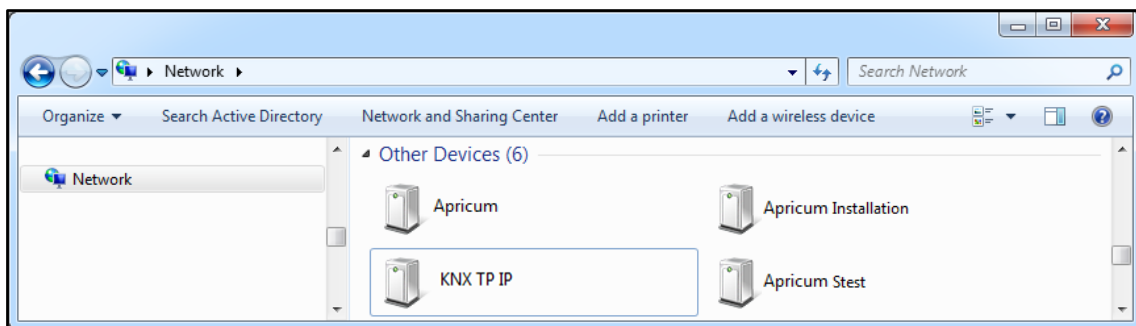

Figure 13: MECip as UPnP network device ("KNX TP IP")

When the UPnP network function is enabled, MECip appears in the Windows Network. A click on the MECip network device opens the Web front-end with the standard web browser. If MECip is not visible as an UPnP network device a manual restart is recommended. After that, the device becomes visible in the list of network devices.

5.1.2 via IP Address

When IP address and HTTP port (80 or 8080) are known, this information is sufficient to access the MECip Web front-end by a web browser. The actual IP address is shown in the ETS list of Discovered Interfaces.

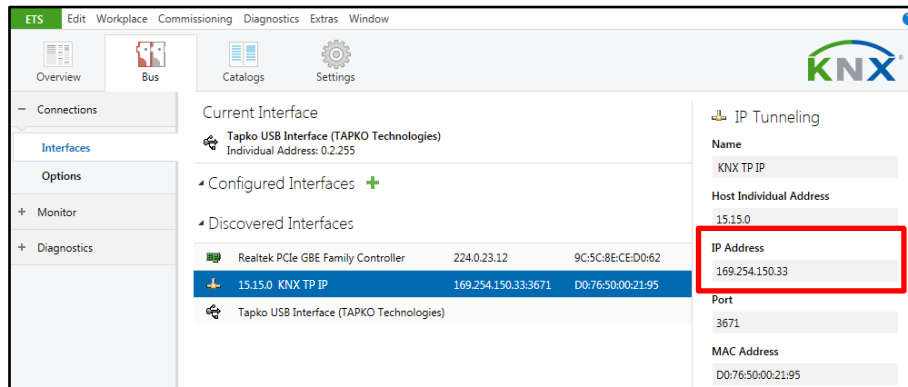

Figure 14: Identifying MECip’s IP address with ETS

According to MECip’s pre-set IP configuration (HTTP port, IP address and DHCP, respectively) in the URL bar has to be entered (without brackets):

```
http://[IP address]:[HTTP port]/
```

Example1: DHCP is not used. With the latest ETS download the IP address was set to 192.168.1.32 and HTTP port was set to 80. In the browser’s URL bar has to be entered “http://192.168.1.32:80/”.

Example2: With the latest ETS download HTTP port was set to 8080 and DHCP was activated. The DHCP server assigned a free IP address to MECip and ETS shows this IP address to be 192.168.1.201. In the browser’s URL bar has to be entered “http://192.168.1.201:8080/”.

5.1.3 via MAC Address

When NetBIOS is installed (by default on Windows systems and Linux systems containing SAMBA) the MAC address that is printed on a label on the side of the MECip housing can be used. Due to name resolution is mandatory to establish communication by Host name, activation of NetBIOS is necessary.

Use the MAC address in the form of AA-BB-CC-XX-YY-ZZ and the pre-set HTTP port to be entered in the browser’s URL bar as described here (without brackets):

```
http://knx-iprt-[XXYYZZ]:[HTTP port]/
```

Example: On the housing side MECip is labelled with MAC address D0-76-50-11-22-33 and the pre-set HTTP port is 8080. Then, in the web browser’s URL bar has to be entered “http://knx-iprt-112233:8080/”.

5.2 Device Info

After accessing the Web front-end the Device Info tab is shown. All general information about the current device settings is visible.



The screenshot displays the Apricum KNX-IP Router web interface. At the top, the Apricum logo and 'KNX-IP Router' are visible. Below this is a navigation menu with three tabs: 'Device Info' (selected), 'KNX', and 'Update'. The main content area is titled 'Device Information' and lists the following settings:

Parameter	Value
Status:	normal operation
DHCP:	true
IP Address:	192.168.1.37
Subnet Mask:	255.255.255.0
Gateway:	192.168.1.201
DNS:	192.168.1.2
Http Port:	8080
MAC Address:	D0-76-50-00-09-C5
Hostname:	KNX-IPRT-0009C5
Description:	KNX IP Router
UDN:	uuid:1f6b0c73-6308-1f55-4a51-d076500009c5
Application SW version:	2.0.3
Bootloader SW version:	2.2

Figure 15: Device Info Tab

5.3 KNX

Here, all KNX specific addresses are shown. Setting changes can easily be checked. With a simple click on “On” or “Off” Programming Mode can be switched on/off. This function is equivalent to a Programming Button press. Together with the Device Info tab it is easy to distinguish the regarded device (with a certain IP address or MAC address or serial number) from other similar devices in the same IP network.

Four tunneling addresses can be set. ETS sets the first tunneling address. With a click on “Set” the remaining ones are set. Moreover, routing multicast address, serial number of the device and a last-60-minutes KNX busload diagram are visible. The red curve shows the maximum busload history and the green one shows the average busload history both of the TP side.

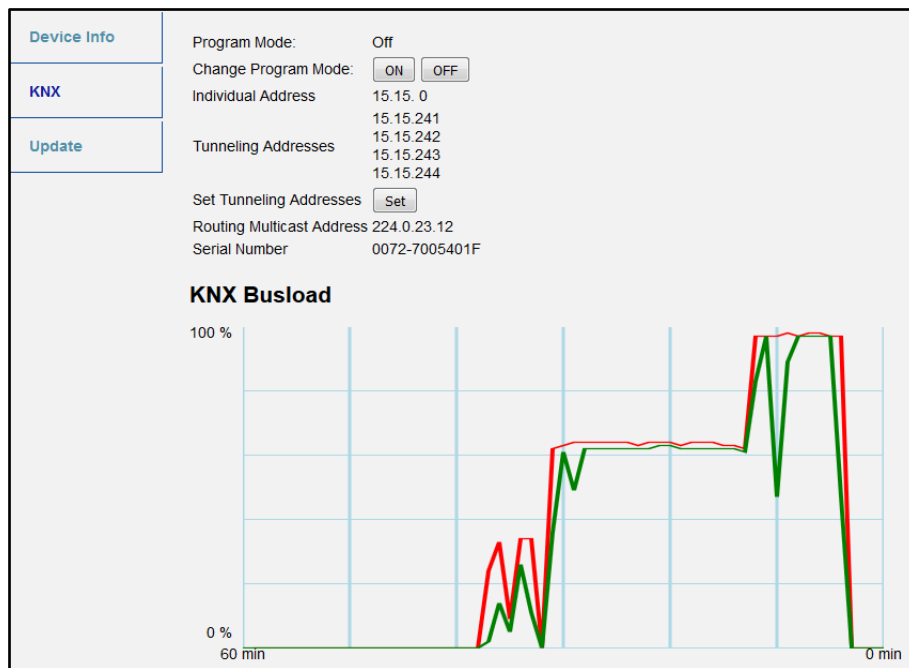

Figure 16: KNX Tab



The web browser used has to support SVG graphics.

5.4 Firmware Update / Boot Mode

Under the Update tab the MECip firmware can be updated via IP i.e. the Ethernet network like described in following steps. During the remote update process MECip enters Boot Mode. Then LEDs 1, 2, 3, and 7 light as described in Table 3.



If Boot Mode is already active only the Web front-end instructions from step 3 to step 5 must be followed (refresh, request update).



Boot Mode is still active after device reset and after factory reset.

To exit Boot Mode it is necessary to enter the Update tab of the Web front-end. Then either the firmware update has to be completed (if a new firmware is available) or the firmware update process has to be stopped by a click on the “Abort” button. After that MECip restarts and continues with normal operation.

Step 1: Open the Update tab of the Web front-end.

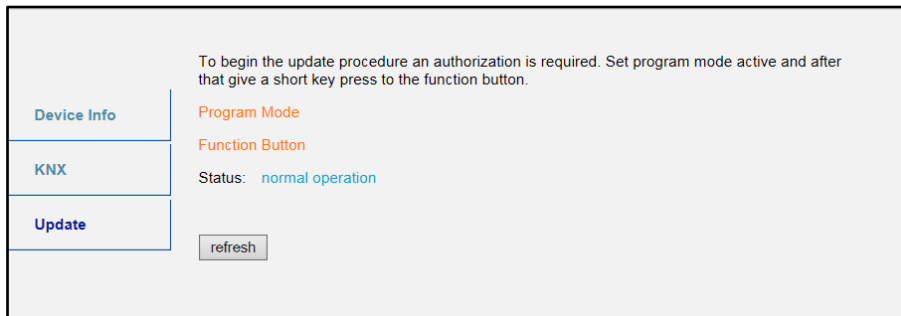

Figure 17: Update Tab

Step 2: Activate Programming Mode (KNX tab or Programming Button).

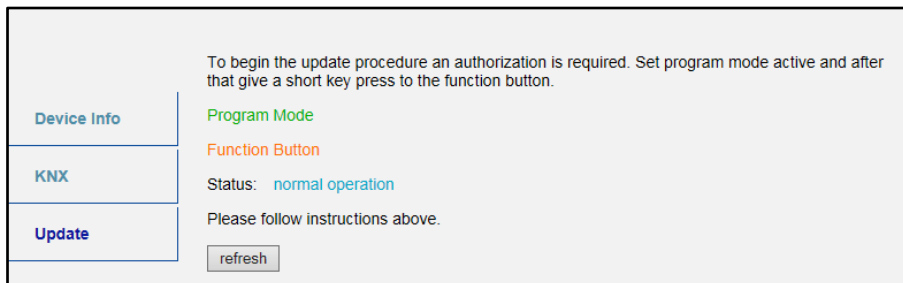

Figure 18: Update Tab and activated Programming Mode

Step 3: After Programming Mode activation give a short press to the Function Button. Then click on the “refresh” button (alternatively, refresh the browser).

The screenshot shows a web interface with a sidebar on the left containing three menu items: 'Device Info', 'KNX', and 'Update'. The 'Update' item is highlighted. The main content area displays the following text: 'Authorization valid. Please continue update procedure within 10 minutes.' Below this, there are two green status indicators: 'Program Mode' and 'Function Button'. The status is 'update authorized'. A message says 'Please press button below to continue.' and there is a 'refresh' button at the bottom.

Figure 19: Update Authorized

Step 4: When the „request update“ button appears it has to be pressed to select the update file and enter “Boot Mode”.

The screenshot shows a web interface with a sidebar on the left containing three menu items: 'Device Info', 'KNX', and 'Update'. The 'Update' item is highlighted. The main content area displays the following text: 'Requesting an update sets the device to boot mode and suspends KNX-IP communication. Otherwise the device will log out automatically after 10 minutes.' Below this, there are two green status indicators: 'Device Mode: update authorized' and 'Timeout: 8 min'. A message says 'Please press button below to continue.' and there is a 'request update' button at the bottom.

Figure 20: Request Update

Step 5: The update file can be selected and uploaded. After that, the device restarts. Clicking on the „Abort“ button cancels the firmware update procedure and the device exits Boot Mode.

The screenshot shows a web interface with a sidebar on the left containing three menu items: 'Device Info', 'KNX', and 'Update'. The 'Update' item is highlighted. The main content area displays the following text: 'To initiate a firmware update please select a valid file in hex-format below. Otherwise the device will log out automatically after 10 minutes.' Below this, there are two green status indicators: 'Status: update authorized'. There is a text input field for 'Select update file:' with a 'Durchsuchen...' button to its right. Below the input field are two buttons: 'Upload' and 'Abort'.

Figure 21: Select Update File

5.5 IP Tunneling Address Assignment

According to the host's physical address assignment the first tunneling address (additional physical address) of the MECip can only be set by ETS.



Please make sure: The additional physical addresses for tunneling and the host's physical address have to be different.

Step 1: Open the ETS Bus tab and select MECip as the "Current Interface". In the "IP Tunneling" window the already assigned host physical address can be read.

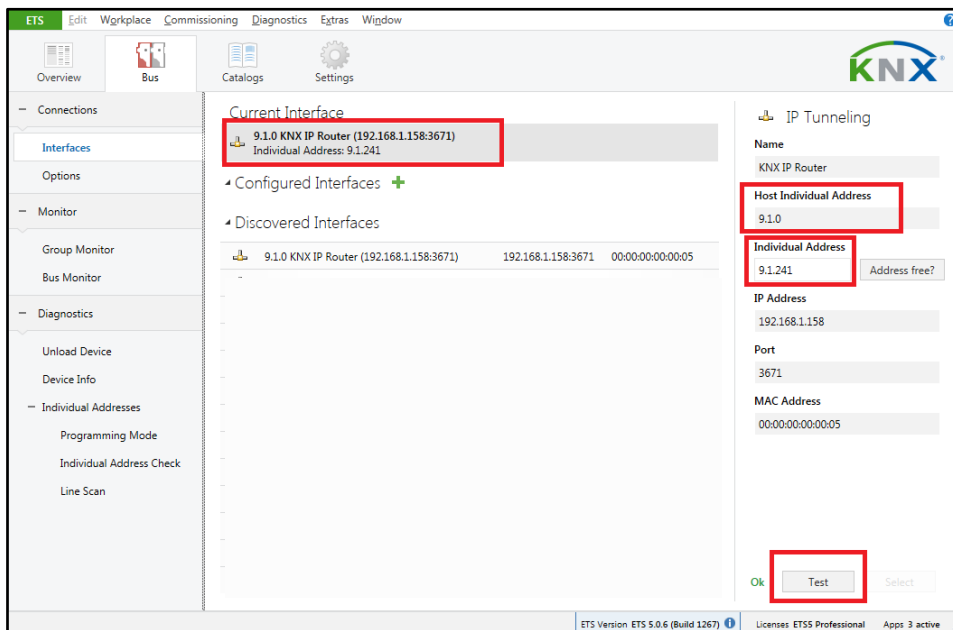

Figure 22: First Additional Physical Address (First Tunneling Address) Assignment

Step 2: Set the first additional physical address by the "Individual Address" field. Click on the "Test" button. If the green **Ok** appears, the first tunneling address is set. In this example it is "9.1.241".

Step 3: Now open the KNX tab of the Web front-end. Click on the "Set" button to set the remaining three tunneling addresses basing on the first tunneling address as follows.

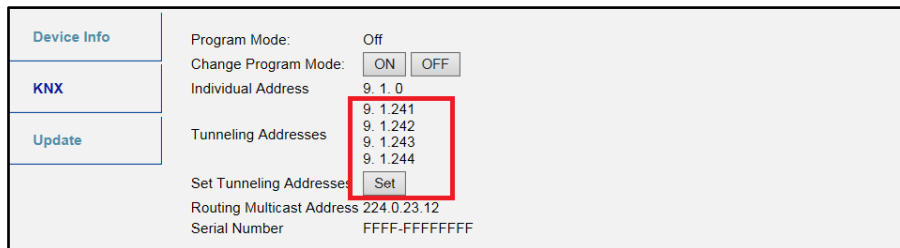

Figure 23: Additional Tunneling Address Assignment in the Web Front-end

6 State of Delivery

6.1 Default Factory Setting

Table 13: Default Factory Setting

General	
Physical Address	15.15.0
Tunneling Addresses	<ul style="list-style-type: none"> • 15.15.241 • 15.15.242 • 15.15.243 • 15.15.244
IP configuration	
IP address assignment	DHCP/AutoIP
IP routing multicast address	224.0.23.12
IP (IP Main line to KNX TP Subline)	
Group telegrams (main group 0...13)	filter (filter table is empty)
Group telegrams (main group 14...31)	route all
Physical telegrams	filter
KNX TP (KNX TP Subline to IP Main line)	
Group telegrams (main group 0...13)	filter (filter table is empty)
Group telegrams (main group 14...31)	route all
Physical telegrams	filter
Physical: Repetition if errors on subline (KNX TP)	up to 3 repetitions
Group: Repetition if errors on subline (KNX TP)	up to 3 repetitions
Telegram confirmations on subline (KNX TP)	if routed
Send confirmation on own telegrams	no
Configuration from subline (KNX TP)	allow

6.2 Technical Datasheet

Marking/Design	MECip
Current consumption	< 20 mA
Connections	IP (line): RJ45 socket for 100 Mbit and 10 Mbit BaseT, IEEE 802.3 networks KNX TP line: KNX TP connector (red/black), screwless, for single-core cable Ø 0.6...0.8 mm
LED Display elements	State (IP and TP) Traffic (IP and TP) Routing (GA and PA) Programming LED
Control elements	Function Button Programming Button
Mounting	35 mm top-hat rail (TH35) according to IEC60715
Protection type	IP20 according to IEC60529
Pollution degree	2 according to IEC60664-1
Protection class	III according to IEC61140
Overvoltage category	II according to IEC60664-1
Approbation	KNX-certified according to ISO/IEC14543-3
CE Marking	In compliance with directives 2014/35/EU (LVD), 2014/30/EU (EMC), 2011/65/EU (RoHS)
Standards	EN50581, EN60950-1, EN61000-6-2, EN61000-6-3, EN IEC 63044-5-1, EN IEC 63044-5-2, EN IEC 63044-5-3, IEC60950-1
Voltage supply	KNX: 21...30V DC (SELV)
Housing colour	Plastic PA66 housing, grey
Housing dimensions	H = 90 mm, W = 36 mm (2 modules), D = 71 mm
Mounting depth	64 mm
Weight	68 g
Operating temperature	-5...45 °C
Storage temperature	-20...60 °C
Ambient humidity	5...93 %, non-condensing

6.3 Technical Drawings



All dimensions shown here are specified in mm.



The total device width is 2 modules at 18 mm.

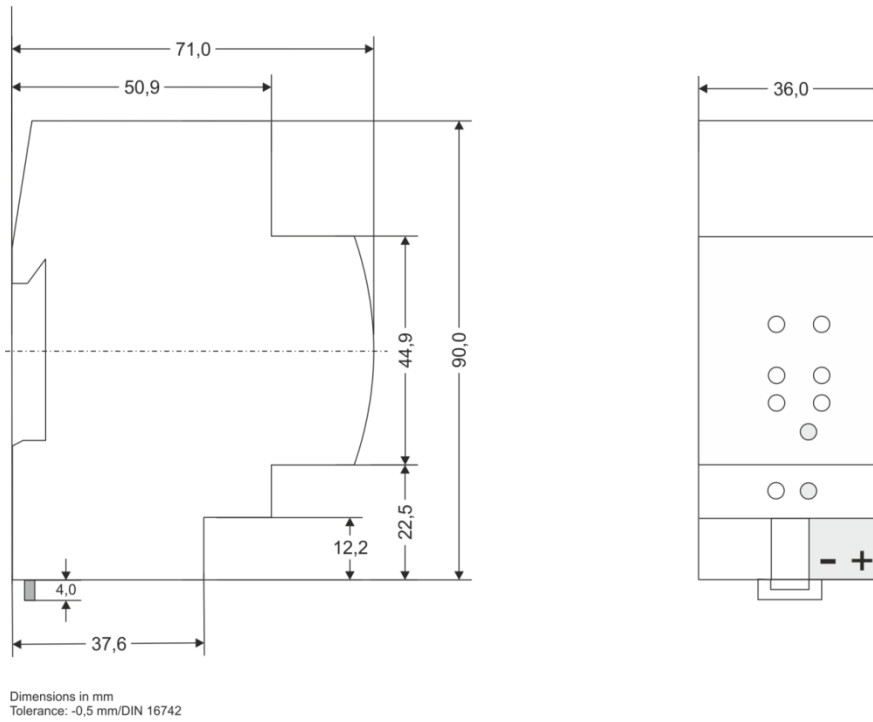

Figure 24: Dimension drawings

7 Legal Notice



Lw IP is used in developing the MECip.



Lw IP is licenced under the BSD licence.

Copyright (c) 2001-2004 Swedish Institute of Computer Science. All rights reserved.

Providing that the following conditions are met redistribution and use in source and binary forms, with or without modification, are permitted:

- Redistributions of the source code must retain the above copyright notice, this list of conditions and the following disclaimer.
- Redistributions in binary form must reproduce the above copyright notice, this list of conditions and the following disclaimer in the documentation and/or other materials provided with the distribution.
- The name of the author may not be used to endorse or promote products derived from this software without specific prior written permission.

THIS SOFTWARE IS PROVIDED BY THE AUTHOR ``AS IS AND ANY EXPRESS OR IMPLIED WARRANTIES, INCLUDING, BUT NOT LIMITED TO, THE IMPLIED WARRANTIES OF MERCHANTABILITY AND FITNESS FOR A PARTICULAR PURPOSE ARE DISCLAIMED. IN NO EVENT SHALL THE AUTHOR BE LIABLE FOR ANY DIRECT, INDIRECT, INCIDENTAL, SPECIAL, EXEMPLARY, OR CONSEQUENTIAL DAMAGES (INCLUDING, BUT NOT LIMITED TO, PROCUREMENT OF SUBSTITUTE GOODS OR SERVICES; LOSS OF USE, DATA, OR PROFITS; OR BUSINESS INTERRUPTION) HOWEVER CAUSED AND ON ANY THEORY OF LIABILITY, WHETHER IN CONTRACT, STRICT LIABILITY, OR TORT (INCLUDING NEGLIGENCE OR OTHERWISE) ARISING IN ANY WAY OUT OF THE USE OF THIS SOFTWARE, EVEN IF ADVISED OF THE POSSIBILITY OF SUCH DAMAGE.

8 FAQ

- **The firmware update finished successfully but the device doesn't work.**
To restart turn the power off and on again (dis-/reconnection of KNX TP line).
- **Is it Ok to connect and disconnect the Ethernet cable quickly?**
No! Don't do this. Before reconnection, wait for a few seconds.
- **What shows the Programming LED if the Ethernet cable is not connected?**
Similar to having no IP network available, the Programming LED is blinking red.
- **LED 2 Bus State KNX TP is continuously blinking green. Why?**
This indicates MECip is in Boot Mode. For more information and how to switch back to normal operation please refer to chapter 5.4.
- **I disabled DHCP and assigned a correct IP configuration, but I cannot access the Web front-end. Why?**
Reset the MECip and try again. More information about changing the IP network configuration can be found in chapter 4.2.
- **I try to access the Web front-end but I'm not successful. What can I do?**
Make sure the URL bar entry matches the correct IP address together with the right HTTP port or use the MAC address in exactly the way as explained (chapter 5.1). Then wait for about 5 or 10 seconds, refresh the browser and try again.
- **Is it possible to reach the Web front-end when the device is in Boot Mode?**
Yes, it is. The Web front-end is accessible also in Boot Mode (chapter 5.4). When Boot Mode is active, the Web front-end looks like illustrated in figure 5. To run a firmware update procedure and/or exit Boot Mode the Web front-end Update tab must be used. Otherwise, after 10 min Boot Mode will be switched off automatically.
- **I was able to reach the Web front-end. But when I try to use its tabs or buttons my browser only shows a connection error to me. What can I do?**
Refresh the browser window. The Web front-end will show up again.
- **How can I find out the actual IP address of my MECip?**
The Device Info tab of the Web front-end and the list of Discovered Interfaces in ETS both show the actual IP address.

MECip

Product:

KNX IP Router

Doctype:

Technical & Application Description

Release Number / Release Date:

R2.9 / June 2020

Editor:

Peter Hauner

Web:

www.apricum.com/mecip

Contact:

apricum@apricum.com

Telephone:

+385 21 507600