

(EN)



8044 01 00

KNX thermostat with display and integrated bus application unit

8066 01 00

KNX room controller with display and integrated bus application unit

Safety instructions

(EN)

Electrical equipment may only be installed and assembled by a qualified electrician. Always follow the relevant accident prevention regulations.

Failure to comply with these installation instructions may result in damage to the device, fire or other hazards.

When installing and laying cables, always comply with the applicable regulations and standards for SELV electrical circuits.

The CE declaration of conformity of the KNX thermostat, KNX room controller has taken place in the Hager/Berker System. In this context, we can only guarantee complete safety and functionality if suitable power supplies are used (see Accessories, Technical Data).

These instructions are an integral component of the product and must be retained by the end user.

Design and layout of the device

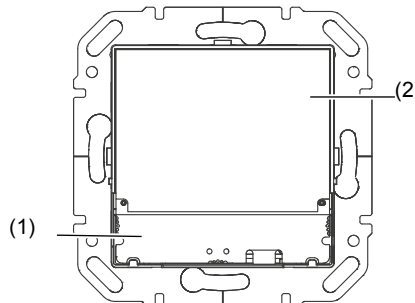

Figure 1: Front view

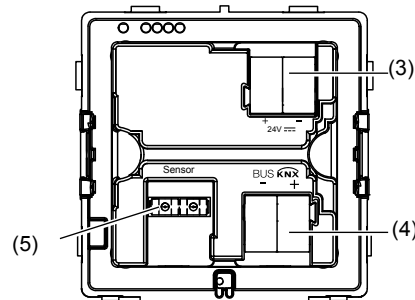

Figure 2: Rear view

- (1) Touch-sensitive control surface
- (2) Display area
- (3) Connecting terminal auxiliary voltage 24 V_{SELV}
- (4) KNX bus connection terminal
- (5) Connecting terminal of external temperature sensor (not in scope of delivery, enclosed with the temperature sensor)

Function

System information

This device is a product of the KNX system and corresponds to the KNX guidelines. Detailed specialised knowledge obtained from KNX training courses is required for understanding. The planning, installation and commissioning are carried out with the help of KNX-certified software.

system link start-up

The function of the device is software-dependent. The software is to be taken from the product database. You can find the latest version of the product database, technical descriptions as well as conversion and additional support programmes on our website.

easy link start-up

The function of the device is configuration-dependent. The configuration can also be done using devices developed specially for simple setting and start-up.

This type of configuration is only possible with devices of the easy link system. easy link stands for easy, visually supported start-up. Preconfigured standard functions are assigned to the in/outputs by means of a service module.

Correct use

- Single room temperature control in KNX installations
- Installation into wall box according to DIN 49073
- Auxiliary voltage supply according to EN 61558 or in the context of the specifications (see Technical data)

Product characteristics

- Start-up and programming in S-mode and E-mode
- Measurement of the room temperature and comparison with set temperature
- Touch-sensitive control surface
- Setpoint specification by selecting the operating mode
- Operating modes comfort, standby, economy mode, frost/heat protected, holiday mode
- Heating and cooling mode
- Ventilation function
- Timer function
- Display of statuses and power consumption
- Push-button functions such as switching, dimming, blind/roller shutter etc. (only KNX room controllers)
- Connection for external temperature sensor (see Accessories)

Functional description

The device compares the current room temperature with the set temperature and controls heating and cooling devices according to the current requirements.

 The heating system must also be suitable for the heating or cooling mode.

The set temperature is defined by the operating mode and can be changed via the menu **operating mode** - holiday mode or settings. The selected operating mode, current time and measured room temperature are indicated in the display as an example (figure 3). The display contents can be represented in different ways depending on the setting. The upper status line symbolically represents the status of the device currently set (6).

Room controller variant

The room controller also has push-button functions in addition to the thermostat. This allows e.g. lighting to be switched/dimmed or roller shutters/blinds to be moved. This first requires making settings in the ETS or service-module easy link. Up to 3 control surfaces can be freely configured for these functions per display page. A maximum of 9 functions are freely programmable.

Operation

Display elements and operating concept

The display is subdivided into a display area and control surface. In the upper rows of the display (6) only symbols indicate the set/active parameters in the basic display. Below this e.g. the current room temperature (7), current display of an external temperature sensor (11) and the current date or current time (10) are visualised in basic operation. In the setting mode, both areas are used for displaying possible selection and parameter values.

The lower row of the display area (8) changes its display depending on the menu item. Symbols indicate the active/inactive functions that can be triggered using the touch control surface (9) below.

- Push button operation:
Switching on/off, confirming or changing a function of a function parameter by pressing the respective touch control surface below the displayed symbols.
- Slider operation:
By "swiping" from left to right or right to left over the touch-sensitive control surface it is possible

to switch to the next/previous page, exit the current operating level or cancel the parameter entry/change.

Operating a function or load

Loads, such as lighting or blinds, are operated using the touch-sensitive control surface and is dependent on the device configuration.

- Press a touch control surface (9) below the symbols (8).

The stored function is executed.

- The actuation pulse lasts for the duration of the actuation. Depending on the function, short and long touches can trigger different actions, e.g. switching/dimming.

Operation in the basic display

The following functions are active in the basic display:

- **- / + :** Increase/decrease room temperature setpoint.

- The temperature can be varied between 7 ... 40°C for each operating mode. The display changes to red when the heating energy is supplied or to blue when cooled.

- Extension of the comfort operating mode.

Display of comfort extension via ☺ .

Or:

- **☾ / ☀** Change-over between comfort mode and economy mode.

- The functions for the basic display can be set and configured individually in the ETS.

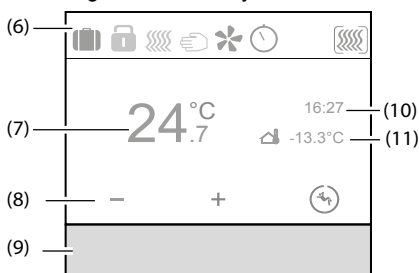

Figure 3: Basic display

- (6) Status line with symbols
- (7) Current room temperature display
- (8) Display of the active functions
- (9) Touch-sensitive control surface
- (10) Display of date/time
- (11) Temperature display of the external temperature sensor

Setting the parameters and values

- Change to the next/previous page by swiping your finger over the touch control surface (9).



Figure 4: Slider function

- By "swiping" your finger over the touch-sensitive control surface you cancel the parameter setting on each menu level and change to the next higher menu level.

Pressing one of the three touch areas (figure 5) below the function symbols causes the corresponding function to be executed.



Figure 5: Touch areas of the touch control surface

Menu Status - A1

The current state of the parameterised devices, such as window contact request, status of the connected loads, dewpoint operation, is displayed in the menu status. A symbol and the corresponding value display with unit can be assigned to the current status.

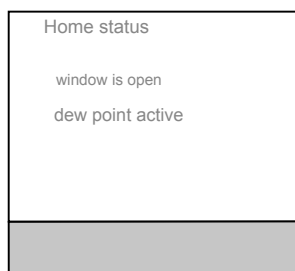

Figure 6: Menu status

Menu No Problem - A2

The No Problem menu allows you to reset the thermostat to one of the two last parameter settings saved (figure 7).

- If one of the last saved settings is selected, the current parameters in the device will be overwritten with the last settings saved.

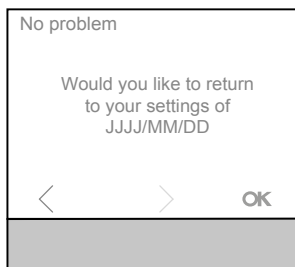

Figure 7: Menu No Problem

Settings menu - A3

In the settings menu, the basic functions and parameters of the device are to be set/changed manually.

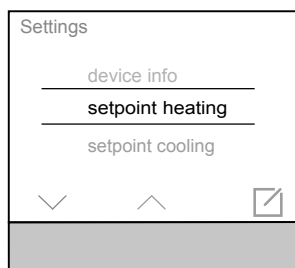

Figure 8: Settings menu

- Select the parameter with ^ / v .
 - Confirm the selection with □ .
- The selected parameter will open in a new screen.

Setpoint heating:

Setting of the temperature setpoint for the operating modes Comfort, Standby and Night Reduction.

Setpoint cooling:

Setting of the temperature setpoint for the operating modes Comfort, Standby and Night Reduction.

Internal sensor:

Parameter for setting the temperature adjustment with the temperature sensor in the device.

External sensor:

Parameter for setting the temperature adjustment with an external temperature sensor.

Heating or cooling mode:

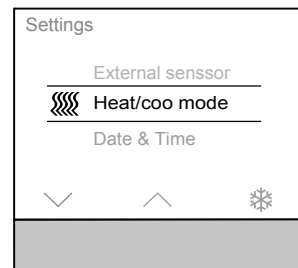

Figure 9: Heating or cooling mode selection

- Press touch control surface under ☸ .

The operating mode (figure 9) changes from heating ☸ to cooling ☸ .

- In the function line (8) the inactive operating mode is displayed on the right, which can be activated using the control surface.

Date/time:

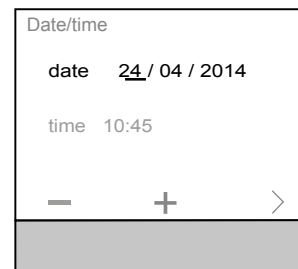

Figure 10: Date/time setting

- Date and time are not set in the default state.

The respective value selected can be changed (figure 10).

- Increase/decrease numerical value with - / + .

- Change to the next adjustable value with > .

- At the last value to be set, the display changes from > to OK .

- Confirm the entry with OK .

24^h/12^h Time format

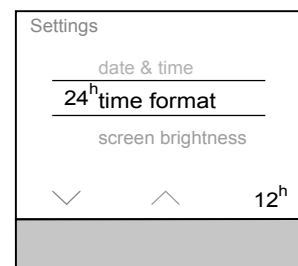

Figure 11: Time format setting

- Press touch control surface under 12^h for the 12^h display.

The time format changes from the 24^h to 12^h display. In the function line (8) the 24^h appears in order to switch back again to 24^h (figure 11).

Screen brightness:

Individual adjustment of the screen brightness for operation. The display is not switched off completely with at value 0%, residual brightness is always still present.

Screensaver:

Basic setting for the screensaver (brightness, screensaver symbol).

Language:

Changeover of the display and menu language to German, English, French,...

Programming mode:

Activation of the programming mode. The device can be loaded with the physical address and application software.

Reset:

Resetting to the factory settings. Afterwards, the device must be reprogrammed and set.

Info:

Display of system information using the touch control surface under , such as the manufacturer, software version, last ETS download date and phys. address.

Timer menu - A4

In the timer menu you have to set on which weekdays or sections of the week and at what times the operating modes Comfort, Standby or Economy mode (Night Reduction) should be switched on and off.

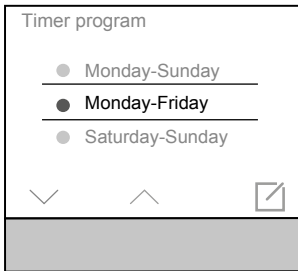



Figure 12: Setting timer

Setting switching times for operating mode change-over

- Select a section of the week or weekday with ∇ / \wedge .
- Confirm with  (figure 12).

The display changes for setting the switching time (figure 13).

The operating mode Economy (Night Reduction)  is selected automatically.

If necessary, change with \wedge to select another operating mode (figure 14).

- Set the switch-on/switch-off time with $- / +$ (figure 13).

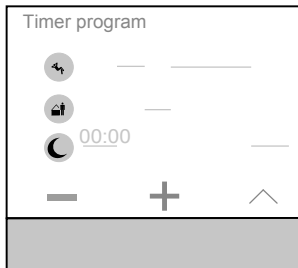

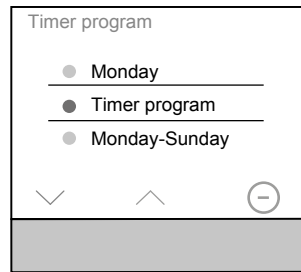

Figure 13: Setting the switching time

 The operation should be repeated for additional switching times.

- Swipe your finger over the touch control surface. The display returns to the **Timer** submenu. The coloured circle next to the weekday or section of the week changes colour. Weekdays or sections of the week with the same coloured circle are configured with the same timers.

Activating/deactivating timer



Activating/deactivating the timer

- Select the **timer** parameter with ∇ / \wedge .
- Switch timer on/off using \odot / \bullet .
-  If the timer is activated, the set programming block is automatically executed once a week recurrently. If the timer is deactivated, adjustments to the temperature setpoint or operating mode must be set manually.

Optimisation:

The KNX thermostat/room controller "learns" independently which lead time is required to reach the desired temperature.



Holiday mode menu - A5

In the holiday mode menu the set temperature can be lowered to an adjustable minimum temperature in absence.



Figure 15: Activating holiday mode

- Activate the holiday mode with .

 The symbol changes to the display .

In the status line (6) of the basic display  indicates the holiday mode.

The display changes for setting the operating mode for the holiday mode (figure 16).

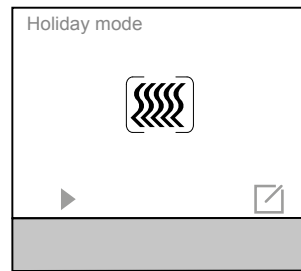



Figure 16: Selecting operating mode for holiday mode

- Select the desired operating mode for the period of absence. The display additionally indicates the number of days for the holiday mode.



Figure 17: Setting duration of holiday mode

- Increase/decrease the number of days of absence with $- / +$.
- Confirm the setting with **OK**. The holiday mode operating mode is activated for the duration of the set days. The display switches to the holiday mode display (figure 17).
- Deactivate the holiday mode prematurely with the  touch area. In the status line (6) of the basic display the  symbol for the holiday mode disappears.

Or:

- Confirm the entry with .

Operating mode menu - A6

In the operating mode menu, you can select between three operating modes (figure 19):

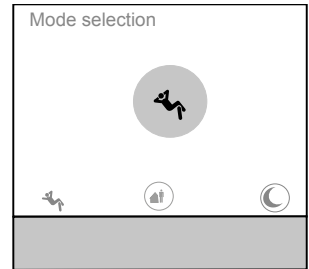







Figure 18: Selecting operating mode

- Comfort  in presence
- Standby  in absence
- Economy (nighttime operation)  for the night reduction
- Activate the desired mode using the touch control surface. In the status line (6) of the basic display the symbol  /  /  indicates the respective holiday mode.

Extractor fan menu- A7

In the extractor fan menu, extractor fan stages from 0 ... 6 can be set.

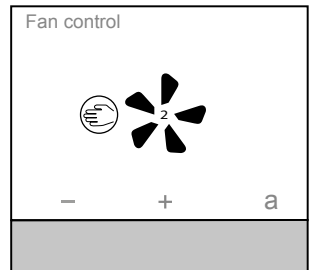



Figure 19: Setting of the extractor fan stages

- Increase/decrease the extractor fan stage with touch control surface $- / +$. The number in the extractor fan symbol indicates the set stage.
- Press touch control surface **a**. The extractor fan function switches to automatic operation. The symbol **a** provides the option of returning back to manual operation .

Individually set pages for push-button functions - A8... (only with room controller)

- i** Before individually setting the display pages, the corresponding functions must be activated and parameterised in the ETS.
- i** A maximum of 9 display pages can be configured. Up to 3 touch control surfaces can be freely assigned with functions per display page.

Example: Switching/dimming a light in the living room (figure 20).

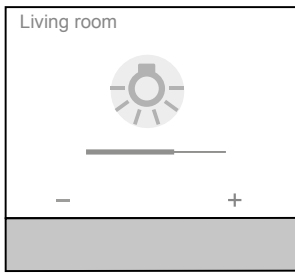

Figure 20: Example of push-button function

- Press touch control surface = / + briefly. The lighting is switched on/off.
- Keep touch control surface = / + pressed. The lighting is dimmed brighter/darker.
- i** The possible functions for the freely configurable control surfaces can be found in the application description on the Internet.

Information for electricians

Installation and electrical connection

⚠ DANGER!

Touching live parts in the installation environment can result in an electric shock.

An electric shock can be lethal!

Disconnect the connecting cables before working on the device and cover all live parts in the area!

⚠ CAUTION!

Risk of polarity reversal when connecting the auxiliary voltage supply.

The device could get damaged!

Be sure that the polarity is correct.

- i** Do not install the device in multiple combinations with other electrical devices. Its heat generation influences the temperature measurement of the device.
 - i** Do not install the thermostat near any sources of interference, e.g. electric stoves, refrigerators, draughts or sunshine. This influences the temperature measurement of the device.
 - i** Observe the layout requirements for SELV installations.
 - i** When installing and laying cables, the network cable and bus cable must be laid a distance of at least 0.10 m.
 - i** The housing should be installed in a place that is easily accessible. The user habits are decisive when determining the installation height. We recommend an installation height of approx. 1.5 m from the centre of the device to the finished floor.
- (1) Touch-sensitive control surface
 - (2) Display interface
 - (1) Supporting ring with spreader claws
 - (2) Adapter ring for integration in the different design lines
 - (3) Thermostat insert
 - (4) Design cover (not within scope of delivery)
 - (5) Frame (not within scope of delivery)

- (6) Spring clips

Connecting and installing the device

The flush-mounted or hollow-wall box is installed in the wall and plastered in. Ductworks with connection cables are inserted into the wall box.

- Mount supporting ring (12) onto wall box.
- Remove protective foil from the thermostat insert (14).
- Attach design cover (15) to the thermostat insert (14).
- Attach adapter ring (13) to the thermostat insert (14) at the back.
- Hold the design frame (16) on the wall box and guide the bus and auxiliary voltage cable out of the wall box through the design frame.
- i** The second wire pair (yellow/white) of the KNX bus cable may be used for the connection of auxiliary voltage.
- Connect the bus cable via the connecting terminal (4). Be sure that the polarity is correct: red +, black -.
- Connect auxiliary voltage via a connecting terminal (3). Be sure that the polarity is correct: yellow +, white -.
- i** Auxiliary voltage must not exceed 24 V_{AC}. Therefore, only use a power supply listed under Accessories or which complies with the Specifications (see Technical data).

Optional:

- Lay an external temperature sensor (see Accessories) in a ductwork and guide out the sensor head at the measurement point.
- i** When choosing the installation location for the external temperature sensor, observe the above information.
- Connect external temperature sensor via connecting terminal (5).
- Press thermostat insert (14) with design frame (16) in correct position onto the supporting ring until it snaps into place.

Dismantling the device

- Remove thermostat insert (14) and design frame (16) from the supporting ring (12).
- Disconnect connection and supply cables.

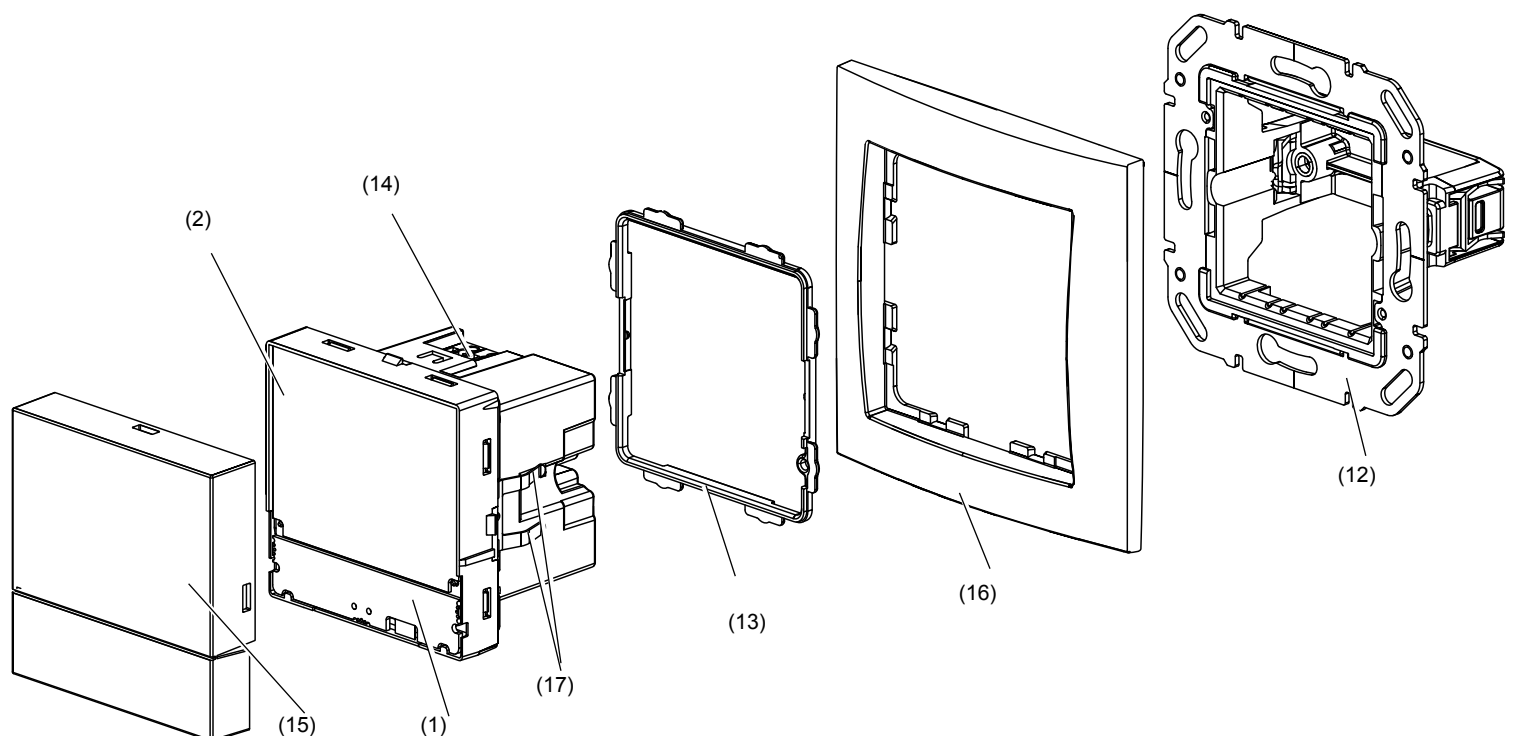



Figure 21: Assembly of the device

Start-up

system link - Loading the physical address and application software

The device is mounted and connected to the bus and auxiliary voltage cables. In the **Settings** menu **Programming mode** is displayed.

 The physical address is only ever assigned for one device. Only one device can ever be in programming mode.

- Switch on bus and auxiliary voltage.
- **Start programming mode** in the display (2).
Programming display visible in the display.
- Load the physical address into the device.
Programming **display** disappears in the display.
- Load application software into the device.
- Note down the physical address on the enclosed label.
- Stick label onto the device.

easy link

Information on the system configuration can be taken from the extensive description of the service module easy link.

Appendix

Technical data

KNX medium	TP 1
Configuration mode	S-Mode, E-Controller
Rated voltage KNX	21 ... 32 V $\overline{\text{---}}$ SELV
Auxiliary voltage	24 V $\overline{\text{---}}$ +/- 6 % SELV
Current consumption KNX	max. 10 mA
Current consumption 24 V auxiliary voltage	25 mA
Max short-circuit current	< 740mA
Connection mode KNX	KNX connecting terminal
Power reserve battery	\approx 4 h
Operating altitude	< 2000 m
Operating temperature	-5 ... +45 °C
Storage/transport temperature	-25 ... +70 °C
Screen diagonal	1.93''
Screen size	38.28 x 30.26 mm
Cable length ext. temperature sensor	max. 10 m
Degree of protection	IP21
Impact protection	IK 04
Protection class	III
Test mark	KNX, CE
Electric strength	1500 V
Overvoltage category	III
Degree of contamination	2
Control function	class A
Mode of action	type 2
Voltage and current declared for the needs of EMC emission test	24 V $\overline{\text{---}}$ /30V $\overline{\text{---}}$ (KNX) / 0A
Independent installation device for built-in installation	

Specification for separate auxiliary voltage supply

Output voltage	24 V $\overline{\text{---}}$ +/- 6 % SELV
Output current	max. 700 mA
Overvoltage class	III
Short-circuit current	700 mA
Standards	EN 61558

Troubleshooting

Bus operation is not possible

Cause 1: Bus voltage is not present.

Check bus connection terminal for correct polarity.

Start programming mode (Menu **Settings A3 - Programming mode**).

Cause 2: Auxiliary voltage is not present.

Check connecting terminal of the auxiliary voltage for correct polarity.

Check auxiliary voltage by means of measuring device.

Accessories

Cover for KNX thermostat with display	809601xx
Temperature sensor	EK090, EK089. EK088
KNX power supply 320 mA + 24 V $\overline{\text{---}}$, 640 mA	TXA114
Power supply 24 V $\overline{\text{---}}$	TGA200

Warranty

We reserve the right to make technical and formal changes to the product in the interest of technical progress.

Our products are under guarantee within the scope of the statutory provisions.

If you have a warranty claim, please contact the point of sale or ship the device postage free with a description of the fault to the appropriate regional representative.



Correct Disposal of this product

(Waste Electrical & Electronic Equipment).

(Applicable in the European Union and other European countries with separate collection systems).

This marking shown on the waste or its literature indicates that it should not be disposed with other household waste at the end of its working life. To prevent possible harm to the environment or human health from uncontrolled waste disposal, please separate this product from other types of wastes and recycle it responsibly to promote the sustainable reuse of material resources.

Household users should contact either the retailer where they purchased this product, or their local government office, for details of where and how they can take this device for environmentally safe recycling.

Business users should contact their supplier and check the terms and conditions of the purchase contract. This product should not be mixed with other commercial wastes of disposal.

Usable in all Europe  and in Switzerland

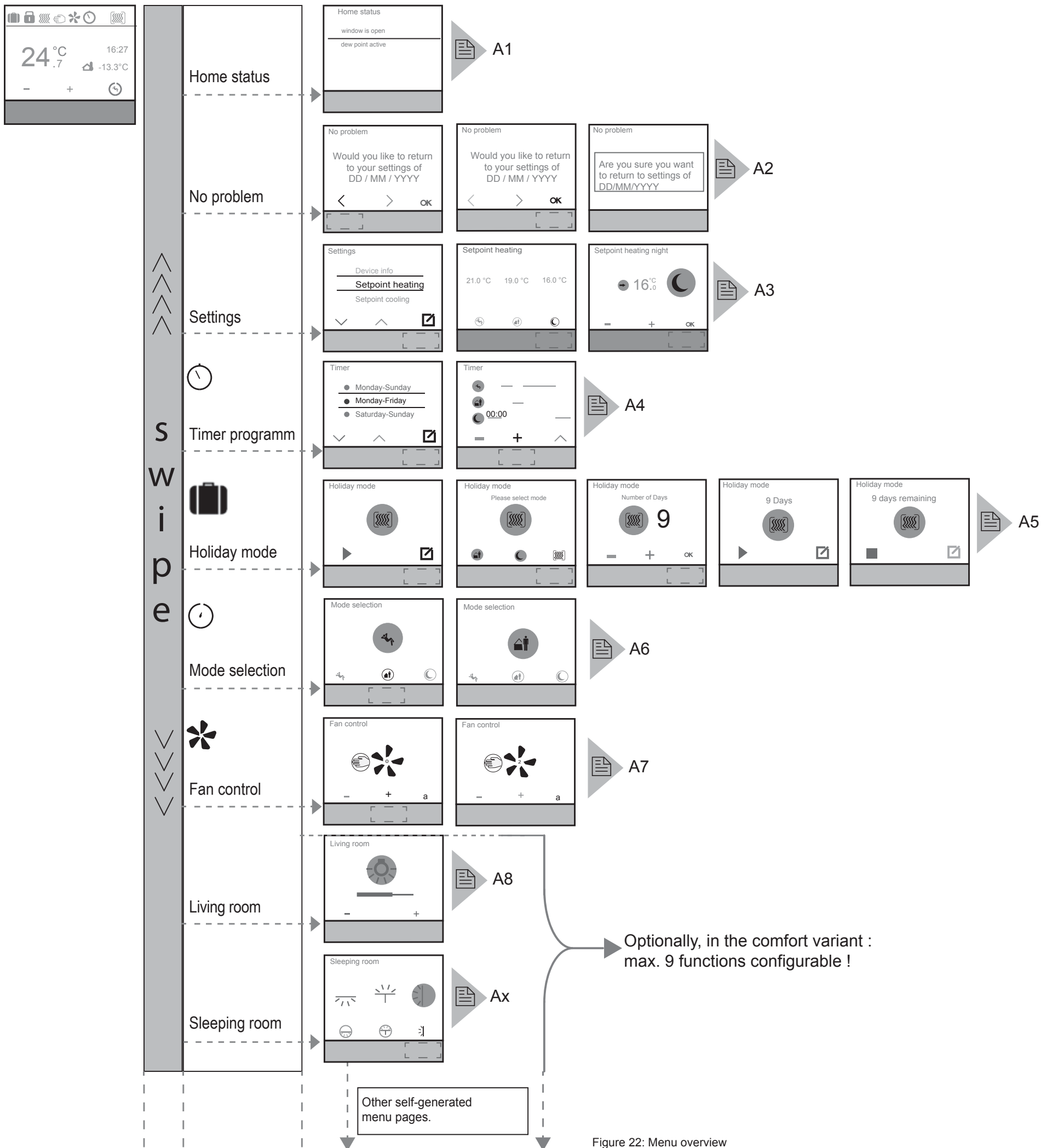

Figure 22: Menu overview