

SMARTtouch (monochrome, colour)
Type: 6136/100C-500-102, 6136/100CB-102
6936/100C-102, 6936/100CB-102

Intelligent Installation Systems



Contents

SMARTtouch (colour)	6x36/100C(-500)-101	2 - 4
SMARTtouch B&O	6x36/100CB-101	2 - 5
Application programs		2 - 6
Circuit diagram		2 - 6
Installation of the supplementary software (RCP tool)		2 - 7
Functions of the panel software		2 - 10
Functional description: Basic settings		2 - 15
Functional description: Homepage		2 - 22
Functional description: Monitoring function		2 - 22
Functional description: Touch surfaces/Symbols		2 - 29
Functional description: Time programs		2 - 51
Functional description: IR control		2 - 56
Functional description: Room thermostat		2 - 62
Functional description: Lightscenes		2 - 71
Functional description: Alarm function		2 - 75
Functional description: Presence simulation		2 - 77
Functional description: Logical functions		2 - 79

Innovations -102

The design of this display is available in four different colours.

The light scene function has 40 memo objects and the alarm function has 50 alarm objects.

The simulated presence records telegrams from up to 20 objects (1bit or 1 byte) via the bus and sends them again to the bus corresponding to the recording.

In the message function each message received can be activated or deactivated via a separate communication object.

Touch buttons with the application „Button“ have a feedback object.

If a touch button with the application „Dimmer with slider“ is pressed long, an additional window with a sliding control (slider) for dimming opens.

Via the logic function „Time function“ the functions of staircase lighting, switch-on delay and/or switch off delay can be implemented.

The room thermostat is used to set the „Temperature display in adjustment mode“. Alternative to the „Setpoint“, also the „Relative current setpoint (+/- K)“ can be displayed.

Each page can be protected against unauthorized access by means of a PIN. There are four hierarchic levels.

The screen saver can be deactivated by the user.

The jump function can refer directly to the information page.

For cleaning purposes the display can be temporarily blocked via a communication object.

For a better overview during project planning, descriptive text may be added to light scenes, the time programs and the individual pages. The text appears in the function view. Instead of „Page 1“, for example, „Living room“ is displayed.

The parameter software also has the option of searching for internal addresses.

A larger display makes it easier for the user to administer the individual time programs.

Innovations -101

The panel has an improved page management function. Up to 21 independent pages with various hyperlink functions and operator levels can now be created. It is also possible to retrieve the system page, the „Extras“ page, the alarm control unit or the alarm messages from each page via a touch surface.

The end user can retrieve and save several functions (up to 20) one after the other and is thus able to create macros. If a touch surface is assigned a macro function, all the stored functions are retrieved in sequence with only one operation. The panel can manage up to 32 different macros.

User-defined symbols can be stored in the panel and represented on the buttons. The panel software generates the symbol which should be displayed in the panel using *.bmp, *.jpg or *.gif files and automatically adapts the image size.

When the panel is inactive, it switches on a screen saver. This can be images from the multimedia/SD card which are displayed in sequence or an image that is stored in the memory of the panel. A single image must be loaded beforehand from the multimedia/SD card into the panel's memory via the menus of the panel software. The multimedia/SD card can then be removed.

If the screen saver or a background image is displayed, an additional basic function such as „Basic lighting ON“ can be retrieved onto the display via a long push button action (approx. 5 s, corresponds to a long operation).

The preview display has been improved. The preview window now always displays the function which has just been parameterised. It is possible to check the function of individual pages

and hyperlink functions via the preview window.

The signalling function is carried out as an additional function and no longer has its own page. Up to 30 independent inputs can now be integrated in the alarm control unit i.e. only a cyclical monitoring of the input is carried out if required.

Alternatively, each page can be designed with symbols for CD, TV, DVD, video or tuner control and used for controlling media.

Status feedback objects can be activated for switch, dimmer and shutter touch surfaces as well as hyperlink functions and linked with separate group addresses or actions.

The system time is backed up in the event of a mains failure. The internal time can be synchronised via the bus, via the system frequency or via an internal quartz clock in the panel.

In order to control KNX room thermostats, a 1-byte communication object for toggling between the room temperature modes can be enabled in the settings of a room thermostat touch surface or in the room thermostat function.

The timer channels can now also send 2-byte values, lightscenes or macro numbers.

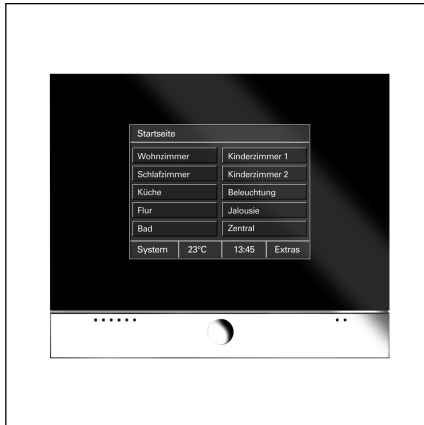

The SMARTtouch panel is a high-quality KNX touch-sensitive display. The panel offers approx. 210 operator functions with a colour display. It is used as a control, monitoring and indication unit for the complete KNX installation which can be operated across different rooms.

The touch-sensitive display can be provided with a frame made out of
– black glass with chrome flap,
– black glass with aluminium flap or
– white glass with aluminium flap.
The display has background illumination

The integrated loudspeaker can e.g. feed back operations acoustically or signal alarm and fault messages.

The panel has a pen for operation and a slot for a multimedia/SD card.

The operation and control is carried out in a clear menu structure via the touch surfaces which are labelled in clear text. The functional assignment of the touch surfaces can be created individually and is dependent on the parameterisation.

All the functions of the panel are listed in the table below “Functional overview” (see below).

Technical Data

Power supply	– Nominal voltage	230 V AC $\pm 10\%$
	– Bus voltage (TP only)	24 V DC
	– Power consumption	< 20 VA
Operating and display elements	– Touch-sensitive display	320 x 240 pixels 256 colours
Connections	– Power supply	Screw plug-in terminals up to 2.5 mm ²
	– KNX bus connection (TP only)	Bus connecting terminal
	– Multimedia/SD card	1 module slot at the front
Type of protection	– IP 20, EN 60 529	
Protection class	– II	
Ambient temperature range	– Operation	0 °C to + 45 °C
	– Storage and transport	- 20 °C to + 60 °C
Dimensions	– Panel with cover frame	218 x 185 x 67 mm (W x H x D)
	– Flush-mounted box	200 x 164 x 60 (W x H x D)
Weight	–	0.742 kg
Certification	–	KNX-certified
CE norm	–	in accordance with the EMC guideline and the low voltage guideline

Functional overview:

– Number of operator pages	21
– Number of possible functions per operator page	5, 8 or 10
– Total number of operator functions	210
– Scope of time programs	20 channels, 10 switching times each
– Scope of scenes	32 scenes with max. 40 objects (loads)
– Scope of macros	32 macros, each with 20 functions
– Number of alarm signals	50
– Monitoring function	Monitoring of up to 30 signalling inputs (e.g. window contacts, movement detectors)
– Presence simulation	max. 20 devices
– IR remote control channels	16
– Integrated room thermostat	Measuring range from 0°C to 40°C
– Info function	
– Alarm clock/Timer function	
– Representation of background images	
– Child protection	
– Number of logic functions (AND, OR, NAND, NOR, multiplexer, multiplier, GATE, time function, temperature comparator, status conv.)	20

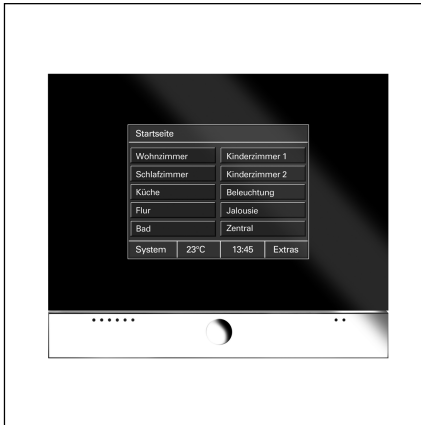

The SMARTtouch panel is a high-quality KNX touch-sensitive display. The panel offers approx. 210 operator functions with a colour display. It is used as a control, monitoring and indication unit for the complete KNX installation which can be operated across different rooms.

The touch-sensitive display can be provided with a frame made out of
– black glass with chrome flap,
– black glass with aluminium flap or
– white glass with aluminium flap.
The display has background illumination.

The integrated loudspeaker can e.g. feed back operations acoustically or signal alarm and fault messages.

The panel has a pen for operation and a slot for a multimedia/SD card.

The SMARTtouch B&O panel is identical to the “standard” SMARTtouch panel. In addition, it can be controlled remotely via a Bang & Olufsen remote control Beo4 e.g. to retrieve a light-scene in the panel. The SMARTtouch B&O panel can further also be operated via the Busch-Jaeger IR remote control.

All the functions of the panel are listed in the table below “Functional overview” (see below).

Technical Data

Power supply	– Nominal voltage	230 V AC $\pm 10\%$
	– Bus voltage (TP only)	24 V DC
	– Power consumption	< 20 VA
Operating and display elements	– Touch-sensitive display	320 x 240 pixels 256 colours
Connections	– Power supply	Screw plug-in terminals up to 2.5 mm ²
	– KNX bus connection (TP only)	Bus connecting terminal
	– Multimedia/SD card	1 module slot at the front
Type of protection	– IP 20, EN 60 529	
Protection class	– II	
Ambient temperature range	– Operation	0 °C to + 45 °C
	– Storage and transport	- 20 °C to + 60 °C
Dimensions	– Panel with cover frame	218 x 185 x 67 mm (W x H x D)
	– Flush-mounted box	200 x 164 x 60 (W x H x D)
Weight	– 0.742 kg	
Certification	– KNX-certified	
CE norm	– in accordance with the EMC guideline and the low voltage guideline	

Functional overview:

– Number of operator pages	21
– Number of possible functions per operator page	5, 8 or 10
– Total number of operator functions	210
– Scope of time programs	20 channels, 10 switching times each
– Scope of scenes	32 scenes with max. 40 objects (loads)
– Scope of macros	32 macros, each with 20 actions
– Number of alarm signals	50
– Monitoring function	Monitoring of up to 30 signalling inputs (e.g. window contacts, movement detectors)
– Presence simulation	max. 20 devices
– IR remote control channels	16
– Integrated room thermostat	Measuring range from 0°C to 40°C
– Info function	
– Alarm clock/Timer function	
– Representation of background images	
– Child protection	
– Number of logic functions (AND, OR, NAND, NOR, multiplexer, multiplier, GATE, time function, temperature comparator, status conv.)	20

Application programs	Number of communication objects	Max. number of group addresses	Max. number of associations
for SMARTtouch panel Twisted Pair: Panel TP/1	approx. 1000	approx. 6000	approx. 6000
for SMARTtouch panel Powernet: Panel PL/1	approx. 1000	approx. 6000	approx. 6000

Note

If the SMARTtouch panel 6x36/100CB-101 should be used, there is no separate entry for it in the ETS or Power-Project database.

In this case, the SMARTtouch panel 6x36/100C must be used. The difference between them is that the SMARTtouch panel 6x36/100CB can react to signals of the Bang&Olufson IR remote control Beo4. (*See also IR control*)

Circuit diagram

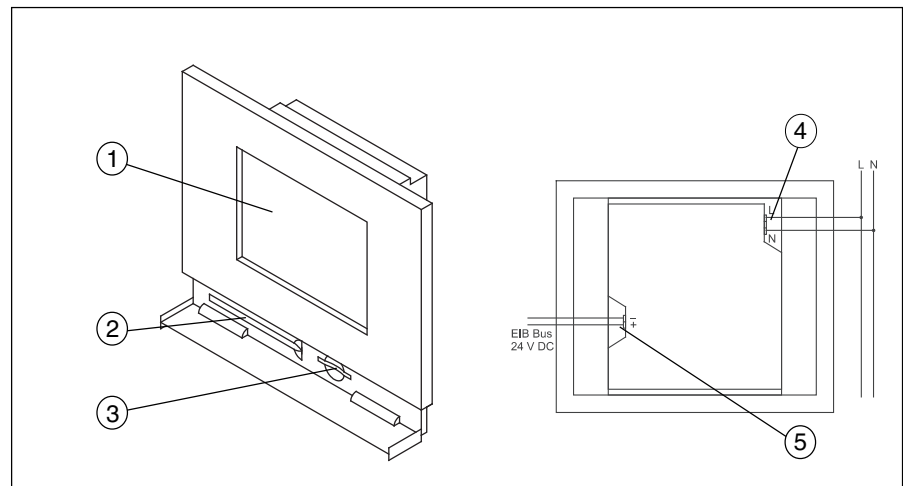

- 1 Touch-sensitive display 320 x 240 pixels, colour
- 2 Operating pen

- 3 MMC/SD card reader
- 4 230 V power supply
- 5 24 V KNX bus voltage (TP only)

Note

Do not lead any live cables behind the device through the flush-mounted box. Separation of the TP bus and mains cable!

Installation of the supplementary software (RCP tool)

To be able to parameterise SMARTtouch panel in ETS 3 or in Power-Project (from version 4.5 onwards), the supplementary software RCP-Tool must be installed. You can find this software on the Internet at www.Busch-Jaeger.de.

The software can be plugged into ETS 3 and/or Power-Project. That means that as soon as you retrieve the parameters of a panel in ETS or Power-Project, the panel software is opened automatically in which you carry out all further settings.

Before you start the installation of the panel software, please ensure that ETS or Power-Project has already been installed on your computer.

The following section describes the individual installation steps.

An installation wizard helps you to install the panel software. This is started by double clicking on the file "Setup.exe" and can run in either "German" or "English".



The panel software requires at least Windows 98. You require full administrator rights of the operating system in order to install the panel software.



Once you have confirmed the welcome screen with "Next", you can enter your name and the name of your company in the "User info" dialog. If sever-

al users work on the computer in which you wish to install the software, you can limit access to the software. This means that either all the users can start the software or only you.

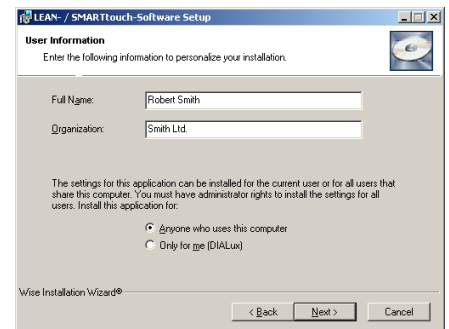

The installation path for the panel software is defined in the next dialog. By default, this is "C:\Program Files\EIB-Programs\". It is advisable to keep this path as e.g. Power-Project has the same default installation path. All KNX programs and additional KNX software can thus be easily located on the hard disk.

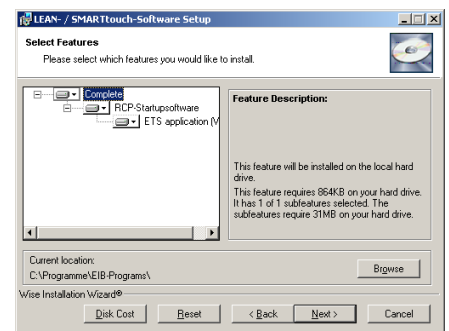

In the “Select functions” dialog, you define the VD3 file should be copied locally onto the hard disk. You require these to be able to use the SMARTtouch panel in connection with an ETS version. (Also observe the note at the end of this chapter).

By default, the files are copied into the following directory:
C:\Program Files\EIB-Programs\RCP-Tool\VDX

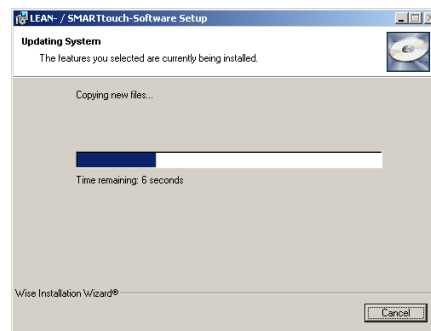

Once you have confirmed the “Select functions” dialog with “Next”, the installation wizard carries out an initialisation. This means that all the required files are compiled together and stored temporarily. The dialog “Updating the system” is shown for visual monitoring purposes.

All the required files are then copied into the appropriate directories. The installation is concluded with an automatic amendment of the Windows registration entries.

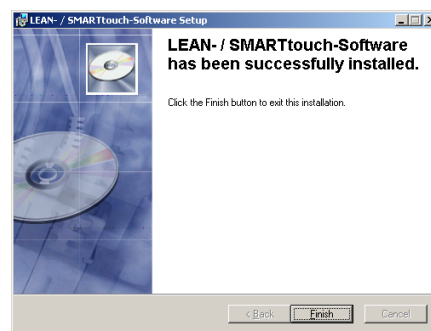

The computer must be restarted depending on the operating system used.

Note

Once you have installed the panel software, you must import the product data (VD3 files) in the ETS database if you wish to parameterise a panel with ETS.

To do so, please retrieve the ETS import tool ETS 3 and import the VD3 file (ETS 3) from the default directory C:\Program Files\EIB-Programs\RCP-Tool\VDX.

You must import the VD3 file in full.

Caution:

The import of individual files is not possible.

Note:

Please note possible software updates (Service-Releases) in the internet under www.busch-jaeger.de

Commissioning a panel

The commissioning of a panel is possible either via a multimedia/SD card (not included) or with “standard” bus programming.

Due to the high level of functionality, full programming via the bus takes a long time depending on the configuration and medium (Twisted Pair or Powernet).

The use of the multimedia/SD card is therefore recommended for quick and simple commissioning.

It is not advisable to carry out full bus programming via Powernet.

The menu item “Download” of the commissioning tool therefore has two further submenus via which the user can select the required commissioning method. If he selects programming via multimedia card, the configuration is stored on a card which is connected to the PC.

With a project that is saved in this way, the panel itself can be commissioned by inserting the card. The slot for the multimedia/SD card is located behind the chrome flap of the panel.

Several projects can be stored on one multimedia card. After inserting the card in the panel, the user can select the required project which should be loaded into the panel.

To do so, the "Commissioning" option from the "System" menu of the panel must be retrieved.

Note 1:

If the panel is in the "Commissioning" menu with the option "Read multimedia/SD card" selected and a short bus/mains voltage failure occurs (approx. 2-3s), the device no longer reacts to push button actions and does not respond to telegrams from the bus. The bus/mains voltage must be reset to be able to operate the device.

Note 2:

If a USB card reader is used to write the multimedia/SD card under the Windows 2000 operating system, the reader may not be correctly enabled by the operating system once it has been accessed. The panel then issues a corresponding signal.

Access to the multimedia/SD card can in most cases only be re-established once the computer has been restarted. This error no longer occurs under the Windows XP operating system.

Functions of the panel software

If you have inserted a SMARTtouch panel in Power-Project or in ETS, open the panel software by retrieving the “Edit device” dialog (Power-Project) or the parameters (ETS) of the panel. The panel software starts automatically with the following interface.

The method of operation of the panel software is identical to that of Power-Project or ETS. The “standard” group addresses and the internal group

addresses are arranged on the left-hand side. Internal group addresses are not sent on the bus and are therefore used to relieve the load on the bus. A touch surface can for example be linked with a lightscene via an internal group address. The group addresses and the internal group addresses are linked with the communication objects in the centre using drag & drop.

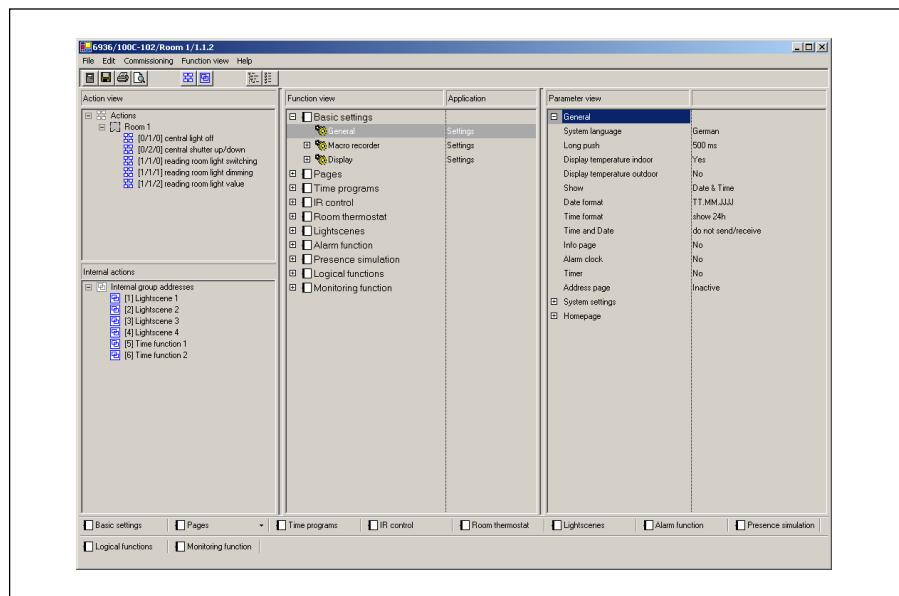

The functions and applications are arranged with all the communication objects in the centre. If necessary, the individual functions/applications must first be activated so that the communication objects become visible. The functions are defined via a pull-down menu.

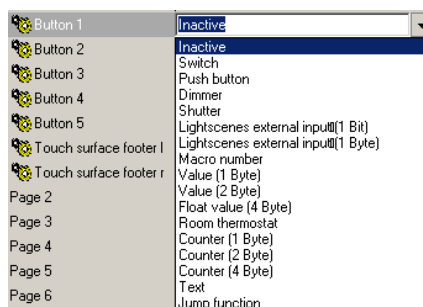

The parameters of the individual functions are displayed on the right-hand side. The parameters of the function

that is marked in the centre are always displayed.

To obtain a better overview, individual functions can be temporarily hidden via the function view.

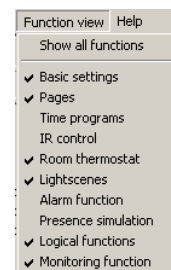

The buttons at the bottom always jump directly to the selected function. This is particularly advisable if the function tree in the centre has been fully extended.



Functions of the panel software

Copying a panel

Only one panel can be parameterised at one time. To provide several panels with the same functionality (generation of a duplicate of a previously configured panel), please proceed as follows:

Retrieve the function “Save as...” from the File menu. The project is stored with the file ending *.rcp. Now close the panel software. Please insert a new panel in ETS or Power-Project. This can be in the same or another project. Then open the panel software for the inserted panel. Select the function “Open” in the File menu and select the previously saved file.

During the import, the following window is displayed in which you can select whether the import should be carried out with or without group addresses.

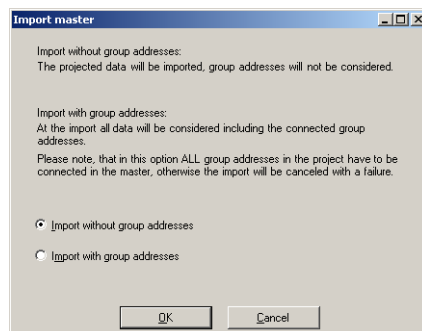

During an import with group addresses, you must ensure that all the group addresses or actions are already located in the project with identical EIS types to the template. Otherwise, you can only import the data without group addresses. You must then however link them again.

Auto backup file

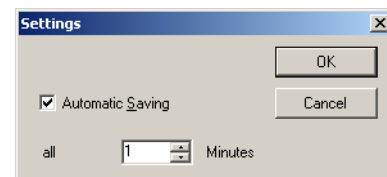

When you retrieve the menu item “Settings” under the File menu, you can set the period, after which the panel software will carry out an automatic backup. This is a temporary file with the extension „*.paf“ which is stored on your hard disk (C://Documents and settings/User/lokal settings/Temp/*paf).

If e.g. your computer crashes, you can retrieve the last automatic backup with the menu item “Reset” under the File menu.

Copying functions

To shorten the configuration time, it is possible to copy the settings of a function (touch surface, time function, light-scene). To do so, click on the function with the right mouse button which should be copied.

Note:

Only touch surfaces with identical applications or functions can be duplicated.

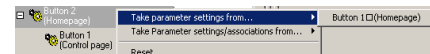

Parameter	Switch time 1	Switch time 2	Switch time 3
Time	00:00	Copy time program	00:00
Weekday	Monday to Frid	Edit time program	Monday to Frida
Status	Off/Up	Reset time program	Off/Up
Astro	Inactive	Inactive	Inactive
Locking	not before .. o'clock	not before .. o'clock	not before .. o'cl
Blocking time	00:00	00:00	00:00
Switching function	always inactive	always inactive	always inactive

Functions of the panel software

Insertion of background images (only SMARTtouch colour)

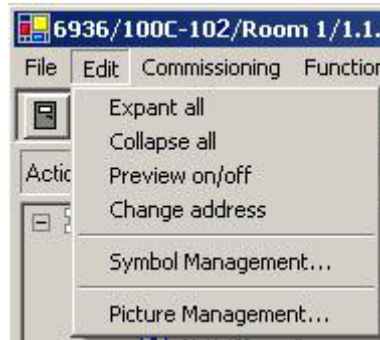

If the function “Manage images...” is retrieved from the “Edit” menu, a dialog window opens via which the images can be imported into the panel software.

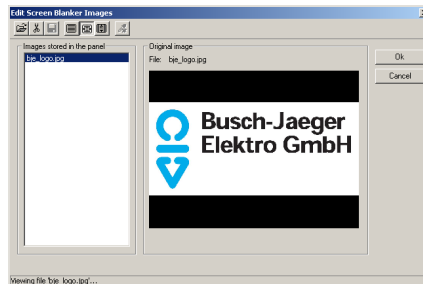

To do so, select the required file via the “Open” symbol - graphics files of the type *.jpg, *.bmp or *.gif can be imported. The graphic is then displayed in the preview window. The image is prepared for storage in the panel via the button “Save background image in the panel”.

So that the background images are the correct size, the imported images are calculated directly in the panel software so that they match the size (320 x 240 pixels) that can be displayed in the panel.

If a project is stored on a multimedia/SD card for commissioning, a “Pictures” folder is created at the same time by the panel software. This folder contains all the background images in the appropriate size.

The background images are used as screen savers. The screen saver is switched on automatically when the panel is not operated for an extended period. The images which are stored in the “Pictures” folder on the multime-

dia/SD card are displayed in sequence in screen saver mode.

An image can be stored in the panel via the menus so that the multimedia/SD card can be removed again. If the screen saver is now switched on, the previously stored image is displayed. It is possible for example to display a company logo.

Insertion of user-defined symbols

The panel software offers the possibility not only of displaying text on a button but also of storing symbols. These can be prefabricated symbols which are already contained in the panel software or user-defined symbols. User-defined symbols must first be imported in the panel software. To do so, the “Manage symbols” dialog window is retrieved via the “Edit” menu.

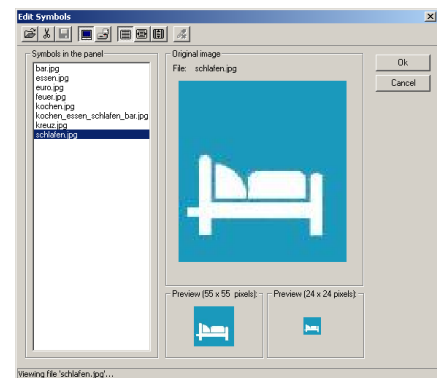

In a similar way to the function of importing background images, various graphics files (*.jpg, *.bmp or *.gif) can be imported via the “Open” symbol in the “Manage symbols” dialog window. The panel software can manage a total of 126 different files.

In addition to the large preview window, the panel software also displays the graphic in the format 55x55 and 24x24 pixels. The symbol graphic is shown in the panel in these two sizes. The panel software carries out any compression of the graphics file automatically.

Busch-Jaeger Elektro supplies additional symbols to those which are already stored in the panel software. These symbols are automatically stored in the “Symbols” directory in the “EIB programs” folder during the installation of the panel software.

Search address

Via a right click on a group address (action) or an internal address link made on the control panel can

Functions of the panel software

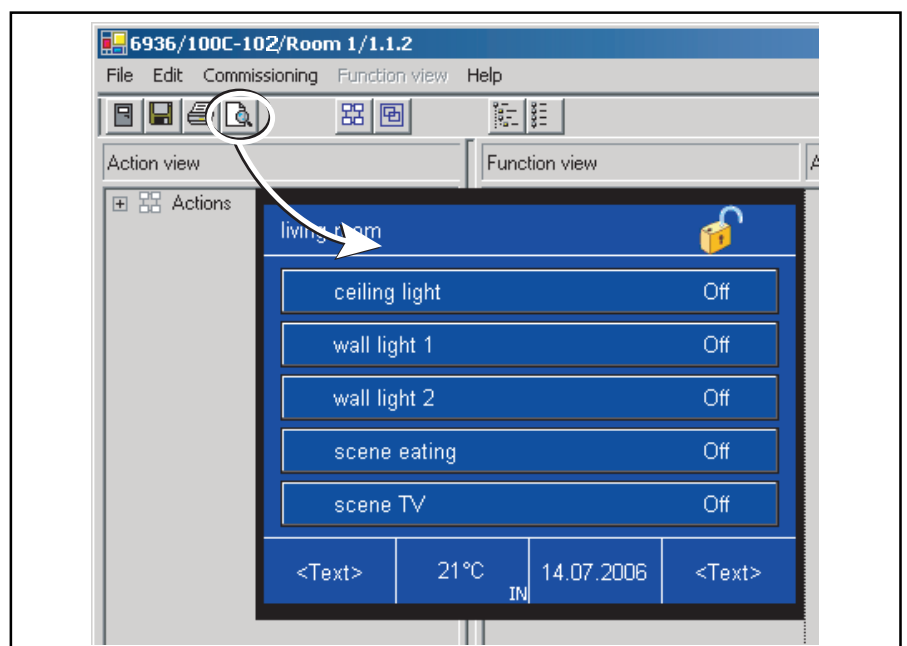

Preview

The panel software has the option to display a preview window. This preview window indicates all the configured buttons, symbols and text as they will later be used in the panel.

A functional check can also be carried out via the preview window. This means that a mouse click on a button in the preview window has the same effect as touching the button on the panel.

The preview window always displays the page which has just been configured. If the parameters of page 1 are modified for example, the preview indicates page 1. If page 15 is set, the preview displays page 15. If however hyperlink functions are configured in the pages so that it is possible to change from page 1 to page 15 by pressing a button, the preview also changes from page 1 to page 15 by clicking with the mouse on the appropriate button.

Functions of the panel software

Important note 1

If you have inserted a SMARTtouch panel in ETS 3, you may no longer retrieve the following function:

– **Shrink database**

The reason for this lies in the database structure of ETS 3. It is not large enough to take all the panel information. The panel information is stored temporarily in several files on the hard disk. **If you carry out the function mentioned above, the files are no longer taken into account and the result is data loss or damage to the database.**

Important note 2

The latest control panel (part number with „102“) also has a more recent firmware than the previous models (part number without „102“). The different firmware versions make it impossible to load a project created with the current control panel software into an „older“ control panel.

If additional functions or pages which already existed in the previous version of the panel software should be added to an „older“ panel, this can be carried out in the usual way. This means that the panel software detects whether it is an „older“ panel (e.g. because it has been configured in a PowerProject or ETS project) and then only displays the functions which can also be used in the panel.

If the hardware of an „older“ panel should fail so that it must be replaced by a newer version, there are two procedures to follow:

1. The functions must all be reconfigured using the current panel software. More recent panel functions could be offered to the customer at the same time.
2. The current panel software must be provided with the older firmware variants by the manufacturer. This means that all the new functions cannot be configured and thus the panel adopts the behaviour of the previous model.

Functional description: Basic settings

General

By default, the panel always has the languages German and English. When the panel software is retrieved for the first time, it is possible to select a third system language which is automatically transferred to the panel during the commissioning phase. The system language is defined via the appropriate general parameters. The following left-justified languages can be selected:

- Czech
- Danish
- German
- English
- Spanish
- Italian
- Dutch
- Polish
- Russian
- Swedish
- Chinese

If a right-justified style of writing is chosen, the text on the individual buttons always runs from left to right. To display a writing style from left to right, additional spaces must be added when entering text, so that the text is positioned at the right edge of the touch button. The following right-justified languages can be selected:

- Arabic
- Hebrew

The panel distinguishes between a short and long push button action e.g. when dimming or moving shutters. It is possible to set the period which the panel detects as a long push button action. By default, the period is set at 500 ms.

Temperature display

The panel has an internal temperature sensor. The measured value is displayed on the homepage. The display can also be deactivated via the setting "Display temperature indoors".

The outside temperature is not displayed by default. The display can be activated via the display "Display temperature outdoors". The outside temperature is the temperature value which the panel receives via the 2-byte communication object "Temperature outside". It can be recorded e.g. by a "standard" KNX temperature sensor and sent via its 2-byte communication object "Actual value".

If the indoor and outdoor temperature should be displayed simultaneously, the corresponding point on the display changes every 5 s.

Date and Time

The panel can display the date and time. The display can be carried out in the German format (TT.MM.JJJJ; 24h) or in the English format (MM.TT.JJJJ; 12h).

The panel can send and receive the date and time on the KNX via the two 3-byte communication objects "Date" and "Time". The panel can thus act as a master clock for other KNX devices or as an extension unit. In its function as an extension unit, the date and time can e.g. be sent by an KNX DCF-77 receiver on the bus. By default, the date and time are neither sent nor received.

If the panel does not receive any time and date information via the KNX, there are two possibilities for synchronising the internal clock. This can be carried out via the system frequency or via an internal quartz clock. In the European association of system operators (countries of the UCTE, Union for the Co-ordination of Transmission of Electricity), synchronisation via the system frequency is advisable as a very precise control of the 50 Hz system frequency takes place here. In all other countries, the internal quartz clock should be used for synchronisation.

If the date **and** the time should be displayed on the panel, the corresponding display switches between date and time every 5 s.

Note:

The date and time do not need to be reset after a bus/mains voltage failure as the panel can store the time and date for 24 hours. In the case of a TP panel, the energy store is loaded via the bus voltage.

Info page, alarm clock, timer

The panel has an info page, an alarm clock and a timer. All three functions can be activated in the basic settings. The user accesses these functions via the "Extras" page.

With the info page, it is possible to leave a short message on the panel with the help of the pen. Other users can detect by the "Info page" symbol at the top of the display that a message has been stored in the panel. If the info page is deleted, the "Info page" symbol is immediately removed from the display.



Via the alarm clock or timer signal, it is possible to trigger an acoustic signal via the panel at a specific time or once a given period has elapsed.

Address page

The contact person, company, telephone, fax and email of the electrical company which carried out the installation can be stored on the address page. In the event of changes, the customer (end user) does not need to search in his documentation to find the right contact person. He will find all the relevant data directly in the panel.

System settings

The system settings are not enabled as standard. This means that a four digit code (by default 0000) must be entered on the display so that changes can be carried out. Only authorised personnel may therefore view and modify the system settings. It is possible however to enable the system settings in principle e.g. in enclosed rooms with users who are permitted to carry out settings. The system settings can also be fully disabled.

Caution:

If you disable the system settings completely, the menu item "Commissioning" on the panel can no longer be selected. In this case, you must carry

out a long operation at the bottom left of the display and thereby switch on the mains voltage. The menu item "System" becomes visible and the panel can e.g. be commissioned with the multimedia/SD card. The display then inverts all the operating elements.

If the system settings are saved with the help of a code, the code is defined via the parameter "Code for system settings".

The following settings can be carried out in the system settings on the display:

- Change date
- Change time
- Display lighting
- Volume
- Contrast / brightness
- Signal tones
 - Alarm messages
 - Timer / alarm clock
 - Incorrect input
 - Push button click
- Touchscreen adjustment
- Commissioning
 - EIB programming
 - Reading multimedia/SD card
 - System info
 - Screen saver
 - Reset
- Synchronisation of the clock
- Change PIN 1
- Change PIN 2
- Change PIN 3
- Change PIN 4

(see also diagram for modifying system settings)

The time which has been stored in the parameter "Background illumination on for" is modified via "Background illumination".

The volume and the contrast or brightness must be adapted to the environment and requirements of the end user.

The complete touch surface is synchronised again with the touchscreen adjustment. To do so, the operating pen must be clicked precisely on specific points which are indicated on the display.

The commissioning can be carried out both via the KNX and via the multimedia/SD card module slot. **For Powernet variants, it is not advisable to**

Changing system settings directly on the SMARTtouch panel display

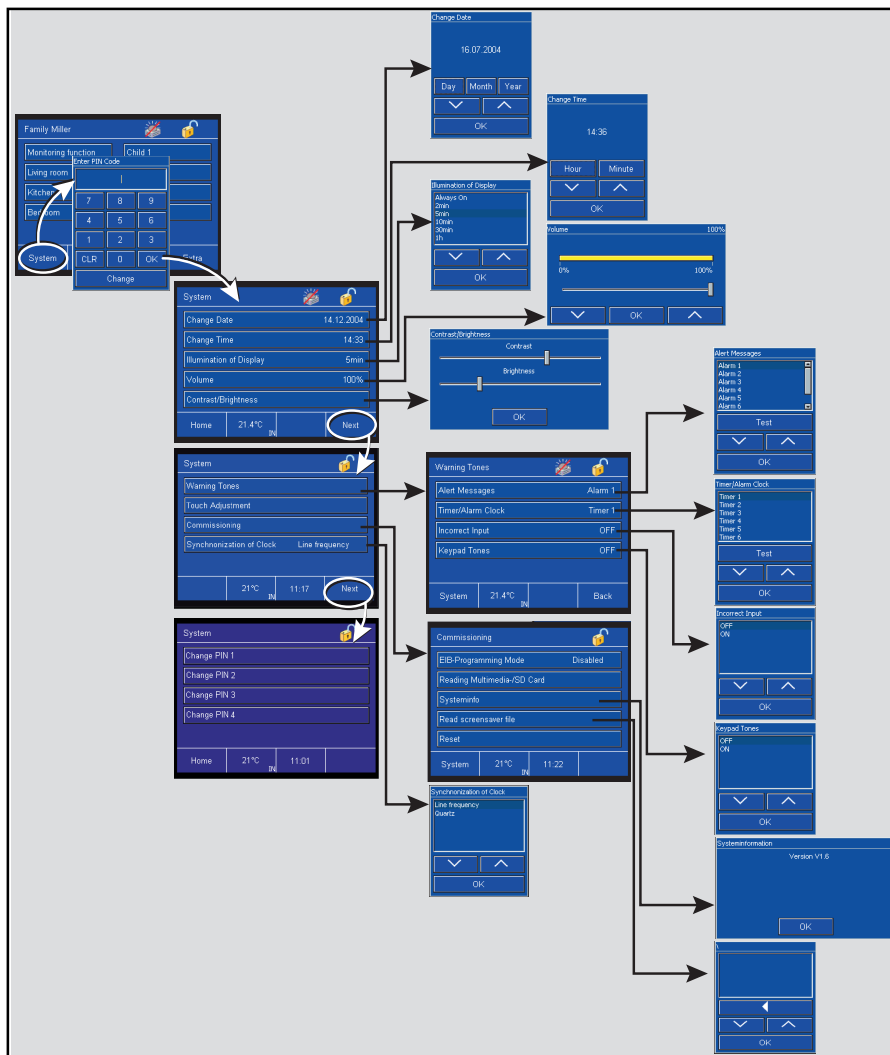

carry out the programming via the bus as this is very time-consuming and faults caused by cyclical transmitters (e.g. room thermostats or movement detectors) can lead to the programming being interrupted.

Via the macro function of the panel, it is possible to store several functions (up to 20) which can be retrieved via the panel.

Start page

Up to 21 pages with 5, 8 or 10 operator elements, touch surfaces or symbols can be created in the panel. The first page is set by default as the start page i.e. the first page is the page from which further pages can be accessed. This is carried out via hyperlink functions (see also hyperlink functions under the functional description of touch surfaces). Each of the 21 other pages can be declared as a start page via the setting "Use as start page".

To do so, at least one touch surface must be assigned the function "Macro retrieval". The communication object "Macro number" of the touch surface is linked via an internal address to the "Macro actuator" communication object. In addition, an external group address can be linked to the 1-byte communication object "Macro actuator" so that a macro function can also be retrieved by a switch sensor. Up to 32 different macros can be stored in the panel.

Macro recorder

Example:
 A user always switches the background brightness on when entering the house and sets the comfort mode

to regulate the room temperature. Normally, he has to click through several pages to do so. Via the macro function, the user is able to retrieve these functions, which he always retrieves in sequence, with a single mouse click.

To store a macro, the macro touch surface must be pressed for a long period (approx. 3s). The panel then displays a window after each operation of a touch surface in which the user can decide whether or not he would like to store the function in the macro. After the last function which should be stored, the saving of macros can be finished in the same window.

To retrieve the macro function, the user only needs to touch the macro touch surface once and the panel carries out all the functions in the stored sequence.

Background illumination

The backlighting of the panel is switched on automatically as soon as the display is operated. After the adjustable period "Background illumination on for", the backlighting is switched off again, provided that the panel is not operated again.

In the basic settings, the panel has three 1-bit communication objects. All three are used for controlling the backlighting.

The backlighting can be switched via the "Background illumination" object. If an ON telegram is received from the KNX, the backlighting is switched on while an OFF telegram switches it off again. The object can be linked with an internal address or external group address/action.

If the display has been switched on via an external group address/action, the internal overshoot time starts from the receipt of the telegram. The backlighting switches off automatically once the overshoot time has elapsed. If the backlighting should be permanently lit, the parameter "Background illumination on for" should be set to "always on".

The object "Status background illumination" sends an ON telegram as soon as the backlighting has been switched on. If the backlighting is ex-

tinguished after the set overshoot time, the object sends an OFF telegram.

The object "Status background illumination" is temporarily disabled via the "Enable status" object. If the "Enable status" object receives an ON telegram, the status object sends telegrams. If an OFF telegram is received, no status telegrams are sent.

If an ON telegram is received on object „Block display“, operation of the control panel is blocked until an OFF telegram has been received on the communication object. This function could be used, for example, to temporarily deactivate the unit for cleaning purposes via an external button, to prevent a function error being triggered during cleaning.

Screen saver (only SMARTtouch colour)

If the parameter "Display screen saver" is activated, when the SMARTtouch colour panel is inactive, it displays all the images in sequence which are located in the "Pictures" folder on the multimedia/SD card or the image stored in the panel. The panel proceeds in alphabetical order. The period between the images can be set - by default it is set to 1 min.

Basic function

If the backlighting is switched off or the screen saver is active, a so-called basic function can be triggered by pressing the display for a long period.

The basic function is a single telegram which is used e.g. to send a central function such as "Basic lighting ON".

The basic function can of course also send an ON telegram. The value that should be sent is defined via the parameter "Send".

The communication object of the basic function can send a 1-byte value instead of a 1-bit value. This can either be an absolute value between 0 and 255, a percentage between 0 and 100% or a lightscene or macro number.

Page access

In the control panel up to 21 pages with 5, 8 or 10 operating elements, touch buttons or symbols can be configured. The jump to a single page can be controlled with a PIN. This means that the user activates a touch button to jump to a different page, but before the page is displayed and can be operated he must enter a four-digit code.

The default setting of this function is inactive, it must be activated for each single jump via parameter „PIN code key“. Four „Levels“ are available. The four levels have a hierarchical structure; i.e. when a user knows the PIN of level 2 he can automatically operate all pages protected by level 1. Level 3 has access to level 2 and level 4 to all levels.

The PINs can be set via the system parameters. The user can change the individual PINs directly on the control panel. The changes are written into the flash memory and are retained when there is a bus or power failure.

Note:

During a download the PINs changed by the user are overwritten with the PINs set in the control panel software.

Background colour

Menu item „Background colour“ influences the colour of the display. Four different colour variations can be selected. The „classic“ version corresponds to the display of the previous model up to 101. Also „blue“, „bright“ or „black“ can be selected as alternative. The changes that are made here for the background colour of the individual image sectors (header, status line, display area), for the colour of the fonts and the buttons, apply to all pages of the control panel.

Communication objects

General (Outside temperature, date and time)

No.	Type	Object name	Function
0	2 byte	Temperature outside	Receive
1	3 byte	Date	Send/Receive
2	3 byte	Time	Send/Receive

Communication objects

For external retrieval of the macro function

No.	Type	Object name	Function
0	1 byte	Macro actuator	Receive

Communication objects

For background illumination of the display with active basic function

No.	Type	Object name	Function
0	1 bit	Background illumination	Receive
1	1 bit	Status background illumination	Send
2	1 bit	Enable status	Receive
3	1 bit	Lock display	Receive
4	1 bit	Basic function	Send

Communication objects

with 1-byte basic function (value, lightscene/macro)

No.	Type	Object name	Function
3	1 byte	Basic function	Send

General parameters

The default setting for the values is **printed in bold type**.

General:	
– System language	German English Country-specific
– Long push	300 ms / 500 ms / 750 ms / 1 s
– Display temperature indoors	No / Yes
– Display temperature outdoors	No / Yes
– Show	Date Time Date & Time
– Date format	TT.MM.JJJJ MM.TT.JJJJ
– Time format	show 24 h show 12 h
– Time and Date	receive from the bus send to the bus do not send/receive
– Info page	No / Yes
– Alarm clock	No / Yes
– Timer	No / Yes
Address field:	
– Headline of the address field	“Address Installer”
– Company	“Mustermann”
– Contact person	“Mr. Muster”
– Telephone	“+44 ...”
– Fax	“+44 ...”
– E-mail	“mustermann@...co.uk”
System settings:	
– Enable system settings for end customers	Yes With code No ^{*1}
– Code for system settings (0000...9999)	0000

*1 Caution: Observe the note on page 15

Display parameters

The default setting for the values is **printed in bold type**.

- Page PIN Code 1	1111
- Page PIN Code 2	2222
- Page PIN Code 3	3333
- Page PIN Code 4	4444
- Background colour	classic blue bright black
- Overwrite code at download	No / Yes
Macro recorder:	
- Telegram rate between two macro telegrams	01:00

Start page:	
- Use as start page	Page 1 / Page 2 / ... / Page 21
- Page automatically in the foreground	Inactive Active
- Delay	01:01

Display parameters:	
- Background illumination on for	always on 2 min 5 min 10 min 30 min 1 h
- Send telegram after long operation	No 1 bit 1 byte (0...255) 1 byte (0%...100%) Lightscene/macro (1...32)
Only for 1 bit:	
- Send	Off / On
Only for 1 byte (0...255):	
- Send	255
Only for 1 byte (0%...100%):	
- Send	0%
Only for lightscene/macro (1...32):	
- Send	1
Only for SMARTtouch panel (colour):	
- Display screen saver	Inactive Active
Only for active screen saver:	
- Period between images	1:00

Functional description: Touch surfaces (Homepage)

Homepage

The start page of the panel is page 1 by default but each of the 21 other pages can be declared the start page. If a submenu (pages 2 to 21, system, "Extras", alarm control unit or alarm messages) has been retrieved via the touch surfaces, the panel changes back automatically to the last operator page after a long period of inactivity. To do so, the parameter "Page automatically in the foreground" must be activated. The preset delay after which the panel displays the start page is 1:01 min and is adjustable.

Note:

If you do not require the panel to revert back automatically to the start page, you must ensure that all the hyperlink functions concur with this i.e. you cannot create a page from which the user cannot access the previous page or the start page. The preview window of the panel software offers the opportunity to check the configuration of the various pages and their hyperlink functions.

Hyperlink functions to submenus and operator functions can also be created on the start page itself.

Note:

When a page is activated the standard headline page 1 ..21 can be replaced by any text (e.g. „living room“, „bedroom“, or „lighting“). This text is also adopted in the tree of the parameter software, to maintain a better overview when configuring parameters.

Monitoring function (only SMARTtouch)

A signalling function can also be retrieved via any touch surface on the panel. To do so, the touch surface must be assigned a hyperlink function. "Alarm control unit" must then be selected in the hyperlink parameter.

In the dialog field "Monitoring function" which is retrieved via the first touch surface, the panel can be armed or deactivated and an overview of all the alarm and fault messages can be retrieved.

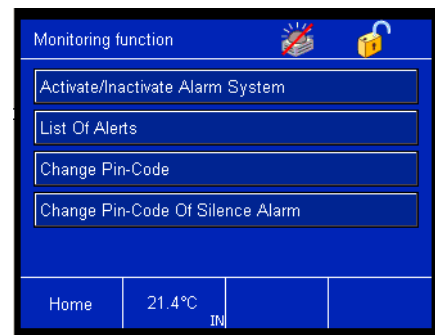

Note:

The monitoring function is not used to set up a VDS-certified alarm system but merely offers the opportunity of monitoring e.g. windows, doors or interior rooms via KNX-type movement detectors. It is **not** a replacement for an alarm system.

Please consider that the installation goes into the disarmed mode after a mains voltage failure, because the setting of the inputs can be undefined after a mains voltage recovery. To prevent the case you have to buffer the mains voltage over a UPS.

Inputs (Monitoring function)

The monitoring function can monitor up to 30 inputs. Each input has its own 1-bit communication object available "Input ...". The parameter "Number of inputs" determines how many inputs are actually visible.

It can be set for each input via the parameter "Type of input" whether it is a window, a movement detector which may or may not be in the entrance area, a "standard" door or one of three doors in the entrance area. All inputs will be treated in the same way up to the movement detector in the entrance area, that means arming is also possible if the detector in the entrance area is switched on.

Attention:

In order that the installation does not activate directly after the arming, the time delay up to the arming has to be set larger than the follow-up time of the movement detector.

Text can be freely assigned to each individual input via the parameter "Description of the input". If an input is now triggered on the panel, not only the input number is shown but also a

clear text description such as “Bathroom window open”.

The input objects are linked via group addresses with the sensor objects (binary inputs, magnetic contacts, switch/key bolt contact, ...) of the window, movement detector or doors that are to be monitored. The linked sensors must send their input signals, both “0” and “1”, cyclically on the bus so that the panel knows the status of the installation at any time.

The inputs are not monitored cyclically by default. This can be set for each individual input via the parameter “Cyclical monitoring of the inputs”.

If e.g. a movement detector is prevented from detecting movements through sabotage, the panel notes the sabotaged movement detector as it has not sent out any telegrams within the “Monitoring time of inputs”. The panel thus automatically sets the linked input to fault mode.

The “Monitoring time of inputs” can be adjusted and represents a compromise between a high bus load and system reliability. The monitoring time should be set too short, particularly in Powerline installations.

Note:
Set the cyclic period of the sensors (binary inputs or movement detectors) to sensible values.

Example:

- Monitoring time of the inputs:
10 min
- Cyclic period of the sensors:
4.5 min

It is therefore guaranteed that a telegram is received at least twice within the monitoring time.

If the mains voltage fails, the inputs initially remain inactive on mains voltage recovery. The time until the inputs become active is set via the parameter “Monitoring of inputs after mains voltage recovery”.

If an ON telegram is set while the system is “armed”, the input is triggered. That means that the “Text for on” is entered in the panel in the list of monitoring functions. If an input fails, the “Text for failure” is entered in the list of faults. Both the “Text for on” and the “Text for failure” can be freely set for each input.

Each input can be activated or deactivated via a 1-bit communication object „Enable input ...“. When the object receives an ON telegram, telegrams received on the associated input object are evaluated. When OFF telegrams are received, telegrams from the input object are ignored until an ON telegram is received again on the enable object.

Note:

After bus / mains voltage has been restored or after the first start-up the inputs are enabled as default. I.e., a „1“ is present at all enable objects.

The individual input objects can be activated or deactivated both in an „armed“ and in a „disarmed“ state.

The monitoring function has two communication objects “Releasing inputs” and “Failure inputs” which can send out the input states. The two objects can adopt 1-byte or 14-byte values. This is dependent on the setting “Type of output”.

In the case of a 1-byte output variable, when an input is triggered in the armed state, the number of the input which has been triggered is sent to the 1-byte object “Releasing inputs”. If an input fails, the number of the input which has failed is sent to the 1-byte object “Failure inputs”.

If the “Type of output” is set to 14 bytes, the “Message text at releasing” of the respective input is sent to the 14-byte object “Releasing inputs” when an input is triggered. In the event of a fault, the 14-byte object “Failure inputs” sends the “Message text at failure” of the input. Both text elements can be freely assigned to each input and contain up to 13 characters.

The transmitted 14-byte text can open a pop-up window on the display with the help of the alarm functionality, which immediately displays a visual and/or acoustic fault or a trigger. The user does not therefore need to first change to the list of alarm and fault messages but sees directly that there is a problem with the installation.

If at least one input has a fault, the installation can be armed directly. The input or inputs must first be acknowledged in order to arm the system. The faulty inputs are removed from the mo-

monitoring as a result. The acknowledgement can either be carried out directly on the panel or via the 1-bit communication object "Failure reset inputs".

Example:

The installation should be armed externally at an entrance door with the help of a key-operated switch. The movement detector in the cellar is however currently faulty i.e. it no longer sends a cyclical telegram and is thus faulty. So that the user can still arm his system, he must first acknowledge the faulty input. This can e.g. be carried out via a 1-fold switch sensor.

Note:

Using this function, it is possible to arm the installation even if an input is faulty. The input is temporarily removed from the monitored installation through the acknowledgement.

If the parameter "Delete failure message at external display" is set to "yes", a so-called zero string is sent to the object "Failure inputs" in the event of a fault acknowledgement with the value zero. This means that a telegram is sent whose useful information consists of bits with the value "0". Display text on an external display is thus reset.

Arming (Monitoring function)

The installation can be armed internally or externally. Internally means entering a four-digit PIN code directly on the panel. This is defined via the setting "Code for arming/disarming". The code can however also be modified by the user. To do so, the old code must be entered once and the new code must be entered twice.

Note:

Please note the setting "Overwrite code at download". If "yes" is selected, the code which has been modified by the user is overwritten with the original code after each reconfiguration of the panel.

The system can be armed externally via a maximum of three 1-bit communication objects "Arming ...". Each object can be controlled via a separate group address. This is necessary if the system should be armed from several entry doors. It is defined via "Number of entry doors" whether one, two or three arming objects are displayed.

If the installation was armed external (e. g. over a key switch), it can be disarmed over these or over the PIN-Code at the panel. If it will be disarmed over the PIN-Code, all objects (Arming 1 up to 3) will be reset. At the same time the objects send the value zero on the bus (to reset the activation device like e. g. a key switch).

Note:

If the installation was armed over two or three external activation devices, it can be disarmed either central at the panel over the PIN-Code, whereby also all external arming objects will be reset, or "all" external activation devices have been set to "disarmed" one after the other. After that the installation goes into the disarmed mode. Then a disarming switch at the panel is not necessary.

When the system is armed, all the input objects must send the value "0" cyclically i.e. all the windows must be closed and the movement detectors cannot report any movement. If the input should not send any "0" values cyclically due to a fault, the panel can be acknowledged directly via the panel or via the object "Failure reset inputs" of the input i.e. removed from the monitoring. It is then possible to arm the system.

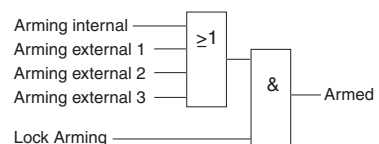

The system can be armed via the first "Arming" object, the second object or the third. The inputs are linked with an OR function. In addition, an "Activate arming" object is enabled via a corresponding parameter. If the object is visible, arming is enabled with an ON telegram. An OFF telegram disables the possibility of arming the system.

Once the panel has been armed, a delay period elapses until the panel is actually triggered by an input signal. The period is set via "Time delay at arming". If e.g. the panel is located in the entrance area of a house, the user must still be given the opportunity to leave the house before the system is armed. If this delay did not exist, in many cases an alarm would always be triggered immediately after arming the system.

Armed status (Monitoring function)

It is indicated via two 1-bit communication objects that the system is in the armed state. The object "Armed status" sends an ON telegram as soon as the system is armed (once the "Time delay at arming" has elapsed). If the system is disarmed, the object sends an OFF telegram. It would therefore be possible e.g. for an LED of a switch sensor which is mounted at an entrance door to be switched.

The second object "Armed status flashing" must first be enabled via the corresponding parameter. A telegram sequence is then sent via this object once the system is armed so that e.g. an external lamp flashes three times. The user who has armed his house via a key bolt contact is therefore informed before he reaches his house that the system is now set. Depending on the status of the actuator, six telegrams are sent with the following useful information:

1 - 0 - 1 - 0 - 1 - 0 or
0 - 1 - 0 - 1 - 0 - 1

Alarm (Monitoring function)

If an ON telegram is received at an input in the armed state, the panel triggers an alarm. There are four different alarm messages (objects).

Internal alarm:

The internal alarm is triggered immediately and without a delay. An ON telegram is sent to the 1-bit communication object "Internal alarm". This could trigger an additional horn in the house or be linked with the alarm function of the panel itself. In the latter case, a message and if necessary a signal tone is displayed/triggered at the panel itself.

Alarm

The alarm is a continuous alarm and is sent via the 1-bit communication object "Alarm" with a time delay. The "Time delay as long as alarm release" can be set. A warning lamp for example could be addressed via this object. Example:

A system has been armed directly on the panel in the hallway. The user comes home and automatically triggers an internal alarm. He now has the "Time delay as long as alarm release" to prevent an acoustic signal e.g. an outdoor siren.

Alarm impulse

The 1-bit object "Alarm impulse" is used to address a horn in front of the house. In the event of an alarm, this may only be triggered for maximum 3 min (legal regulation). This means that an ON telegram is sent to the object once the "Time delay as long as alarm release" has elapsed. The period "Time of the external audio signal" now starts. If this has elapsed, an OFF telegram is sent. The "Time of the external audio signal" can be set to 1 min, 2 min or 3 min.

Silent alarm

The silent alarm is retrieved by entering the PIN code for the silent alarm.

Example:

An intruder has entered the house in the night and forces the owner to cancel the alarm. Normally, the owner would enter the PIN code to deactivate the system and the system would be disarmed. If he however enters the PIN code for the silent alarm, the objects "Alarm", "Internal alarm" and "Alarm impulse" are reset but the 1-bit communication object "Silent alarm" sends an ON telegram. A telephone dialling device or similar could be addressed via this object.

The PIN code for the silent alarm is defined in the panel software in a similar way to the PIN code for arming/disarming the system. The user can modify the PIN code, whereby he presses the touch surface that is assigned the monitoring function and retrieves the function "Code for silent alarm" in the subsequent window (only visible in the disarmed state).

Input failure if armed (Monitoring function)

If an input failure occurs while the system is armed, this does not trigger an alarm. To inform the user about this input failure, there is the 1-bit communication object "Inputs failure if armed". In the event of faults, an ON telegram is sent via this object.

Installation status (Monitoring function)

As soon as the status of the panel changes, the new status is sent via the object "Installation status". The object is 1 bit or 14 bytes dependent on

the setting "Type of output variable". The system knows two or three different states depending on the object type.

1-bit object type:

- set/ready to set (value 0)
- unset (value 1)

14-byte object type (output in clear text):

- unset
- ready to set
- set

The following table indicates which values are sent for the different bit sizes:

State	1 bit	14 byte
Set	0	Unset
Ready to set	0	Ready to set
Set	1	Set

Example: Detached house

BM1 and BM2:
Movement detectors

MK1 to MK6:
Magnetic contacts

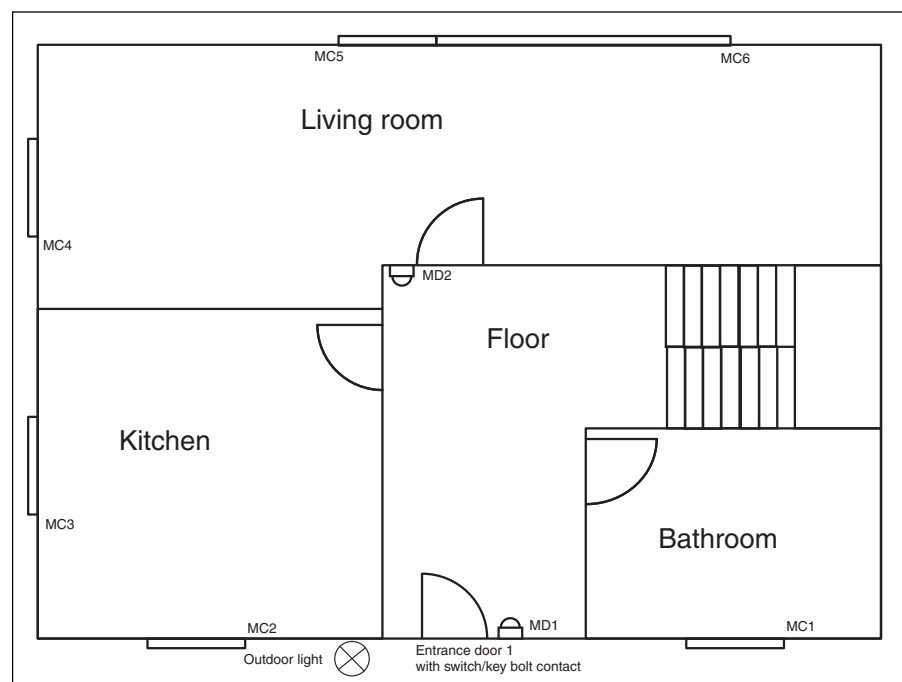

The diagram above shows an application example for the monitoring function of the SMARTtouch panel.

The states of the magnetic contacts MC1 to MC6 and the switch/key bolt contact of the entrance door are recorded with binary inputs or universal interfaces and sent on the KNX. The detectors MD1 and MD2 are KNX movement detectors and send their signals immediately on the bus.

The magnetic contacts and the movement detectors are linked via group addresses/actions with the inputs of the panel. The switch/key bolt contact with a group address is assigned to an arming object.

When the user leaves the house, he arms the system by locking up. If the external light is also controlled via KNX, it can signal via the object "Armed status flashing" that the system is now armed. If the user does not receive a flashing status, he knows that there is a problem with the installation. A window is still open perhaps.

Functional description of the signalling function

Function	Application
Signalling function	Inactive Signalling function

Only if signalling function is active:

Touch surface in left footer	Hyperlink function
Touch surface in right footer	Hyperlink function

Communication objects

for signalling function (with 1-byte signals and 1-bit installation status)

No.	Type	Object name	Function
0	1 bit	Arming 1	Send/Receive
1	1 bit	Arming 2	Send/Receive
2	1 bit	Arming 3	Send/Receive
3	1 bit	Activate arming	Receive
4	1 bit	Alarm	Send
5	1 bit	Internal alarm	Send
6	1 bit	Silent alarm	Send
7	1 bit	Alarm impulse	Send
8	1 bit	Armed status	Send
9	1 bit	Armed status flashing	Send
10	1 byte	Releasing inputs	Send
11	1 byte	Failure inputs	Send
12	1 bit	Failure reset inputs	Receive
13	1 bit	Inputs failure if armed	Send
14	1 bit	Installation status	Send
15	1 bit	Entry 1	Receive
16	1 bit	Activate Entry 1	Receive
17	1 bit	Entry 2	Receive
18	1 bit	Activate Entry 2	Receive
19	1 bit	Entry 3	Receive
20	1 bit	Activate Entry 3	Receive
21	1 bit	Entry 4	Receive
22	1 bit	Activate Entry 4	Receive
23	1 bit	Entry 5	Receive
24	1 bit	Activate Entry 5	Receive
25	1 bit	Entry 5	Receive
26	1 bit	Activate Entry 5	Receive
27	1 bit	Entry 6	Receive
28	1 bit	Activate Entry 6	Receive
29	1 bit	Entry 7	Receive
30	1 bit	Activate Entry 7	Receive
31	1 bit	Entry 8	Receive
32	1 bit	Activate Entry 8	Receive
33	1 bit	Entry 9	Receive
34	1 bit	Activate Entry 9	Receive
35	1 bit	Entry 10	Receive
36	1 bit	Activate Entry 10	Receive
37	1 bit	Entry 11	Receive
38	1 bit	Activate Entry 11	Receive
39	1 bit	Entry 12	Receive
40	1 bit	Activate Entry 12	Receive
41	1 bit	Entry 13	Receive
42	1 bit	Activate Entry 13	Receive
...			
73	1 bit	Entry 30	Receive
74	1 bit	Activate Entry 30	Receive

Communication objects

for signalling function (with 14-byte signals and 14-byte installation status)

No.	Type	Object name	Function
...			
10	14 byte	Releasing inputs	Send
11	14 byte	Failure inputs	Send
...			
14	14 byte	Installation status	Send
...			

Parameters for left touch surface

The default setting for the values is **printed in bold type**.

– Name of touch surface	<Text>
– Jump to page	Page 1 / Page 2 / ... / Page 21 / System / Extras / Alarm control unit / Alarm messages

Parameters for right touch surface

The default setting for the values is **printed in bold type**.

– Name of touch surface	<Text>
– Jump to page	Page 1 / Page 2 / ... / Page 21 / System / Extras / Alarm control unit / Alarm messages

Parameters for signalling function

The default setting for the values is **printed in bold type**.

General:	
– Code for arming/disarming (0000...9999)	0000
– Code for silent alarm (0000...9999)	0000
– Overwrite code at download	No / Yes
– Number of entry doors	None (internal monitoring) 1 2 3
– Type of arming/disarming	Internal lock/PIN code/ push button Block lock External lock/PIN code/ transponder Bolt switch contact
– Monitoring time of inputs	1 min / 3 min / 5 min / 10 min / 20 min / 30 min
– Number of inputs (1...30)	8
– Monitoring of inputs after mains voltage recovery	20 s / 30 s / 1 min / 5 min / 10 min
– Time delay at arming	None / 10 s / 15 s / 20 s / 25 s / 30 s / 35 s / 40 s / 1 min
– Time delay as long as alarm release	None / 10 s / 15 s / 20 s / 25 s / 30 s / 35 s / 40 s / 1 min
– Time of the external audio signal	1 min / 2 min / 3 min
– Activate arming via object	No / Yes
– Armed status flashing	No / Yes
– Delete failure message at external display	No / Yes
– Type of output	1 Byte / 14 Byte

Input parameters

The default setting for the parameters is **printed in bold type**.

Separate for each input:	
– Type of input ...	Window Watch dog sensor Watch dog sensor in the entry area Door (not in the entry area) Entry door 1 Entry door 2 Entry door 3
– Description of the input	<Text>
– Text for on	<Text>
– Text for failure	<Text>
– Message text at releasing (max. 13 characters)	<Text>
– Message text at failure (max. 13 characters)	<Text>
– Cyclical monitoring of the inputs	Inactive Active

Functional description of touch surfaces/symbol (page 1...21)

Up to 21 independent pages can be created in the panel. Either 5 or 10 touch surfaces or 8 symbols can be represented on a page. Each touch surface or symbol can be assigned one of the following functions:

- Switch
- Push button
- Dimmer
- Shutter
- Lightscenes external input (1 bit or 1 byte)
- Macro number
- Room thermostat
- Values (1 byte or 2 byte)
- Floating point value
- Counter
- Text
- Hyperlink function

Alternatively, a page can be used for controlling media. If a page is assigned the media control function, operating elements for the following media are available (parameter setting: media device):

- CD
- TV
- DVD
- Video
- Tuner

The operating elements for media control can adopt the push button and dimmer functions (see also the description of the pushbutton and dimmer). That means that if a page is assi-

gned the function of media control, "normal" KNX telegrams are sent via this page. Media devices are required in addition which can evaluate these push button or dimmer telegrams.

Each touch surface can adopt various functions. Depending on the set function, the panel software displays different communication objects and parameters.

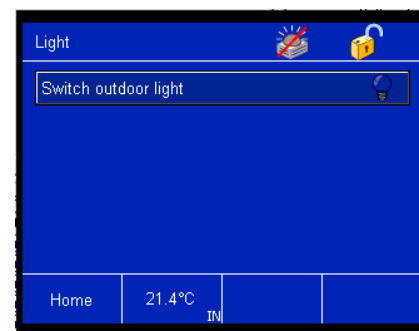

The "Name of touch surface" is always on the left-hand side of the touch surface. This can be freely assigned to each touch surface with the corresponding parameter.

The status display is on the right-hand side of the touch surface. This can either be a symbol or text.

Page setup with 5 touch surfaces, 10 touch surfaces, 8 symbols or media control (from left to right)

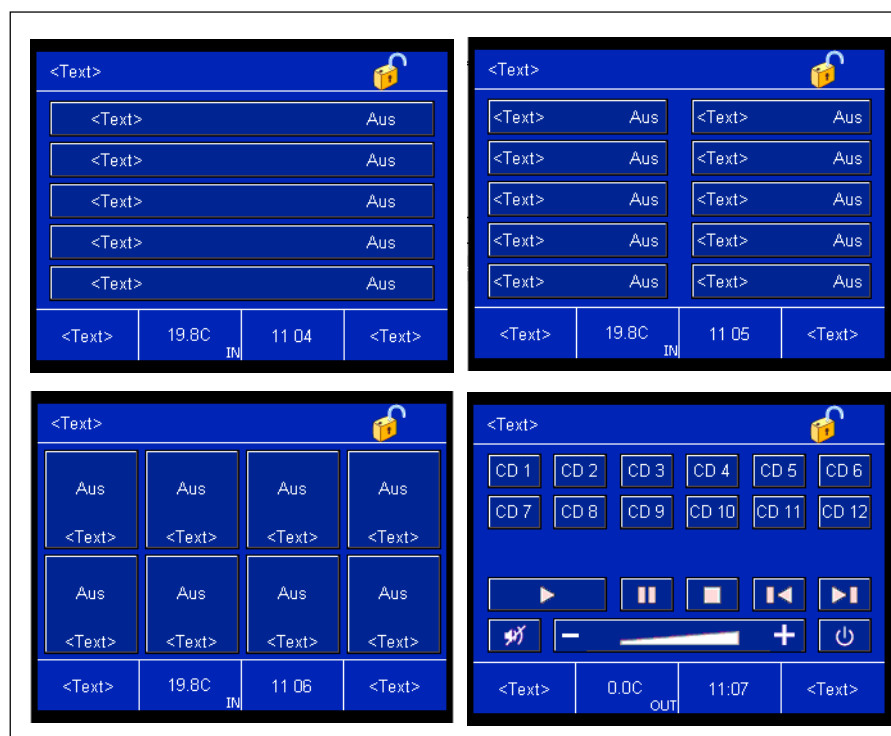



If this button is “Active”, a window opens when the touch surface is operated. The “Name of touch surface” appears in the window as a heading. The buttons (designated here with “ON” and “OFF”) can be described with text or adopt symbols. This operation mode is set by default (“Operation” parameter, “via pop-up window”).

Some touch surfaces can also send a value directly on the bus (“Operation” parameter, “Direct”). That means that no further windows are opened when the touch surface is pressed. Instead, the preset value e.g. “Send ON telegram” is sent directly. For some touch surfaces, the panel detects in addition whether the touch surface has been pressed on the right- or left-hand side. Depending on the side that is pressed, the device is switched on or off, dimmed brighter or darker or a shutter is raised or lowered.

As soon as a touch surface is operated, the panel sends a corresponding telegram to the linked communication object. In some windows, a slide rule appears in addition to the buttons. If the button on the slide rule is set to a new position, the linked object also sends the new value automatically.

If the status display or the button description should adopt a symbol, it can be selected from a pull-down menu. The panel software always indicates all the context-related symbols. (*See also the parameter listings of the individual functions*)

If the predefined symbols are insufficient, there is the possibility of integrating user-defined symbols in the panel and then displaying them on the individual touch surfaces or dialog windows. They must previously be read in via the function “Edit”, “Manage symbols...” (see also the functions of the panel software “Inserting symbols”).

If user-defined symbols have been imported, they can be selected under “Button description” or “Status display” with the setting “User-defined symbol”. It is advisable to keep the preview window open in order to have direct control as to whether the imported symbol matches the total image.

Page access

The jump to a single page can be controlled with a PIN. This means that the user activates a touch button to jump to a different page, but before the page is displayed and can be operated he must enter a four-digit code.

The default setting of this function is inactive, it must be activated for each single jump via parameter „PIN code key“. Four „Levels“ are available. The four levels have a hierarchical structure; i.e. when a user knows the PIN of level 2 he can automatically operate all pages protected by level 1. Level 3 has access to level 2 and level 4 to all levels.

The PINs can be set via the system parameters. The user can change the individual PINs directly on the control panel. The changes are written into the flash memory and are retained when there is a bus or power failure.

The levels are set under the general parameters since they apply to all pages. (*See also „Page access“ under „Control panel software functions“*)

Switch

If the function of the touch surface is defined as “Switch”, the panel sends ON or OFF telegrams via the associated 1-bit object “Switch”.

In the default setting, the touch surface sends OFF telegrams when the right-hand side is pressed and sends ON telegrams when the left-hand side is pressed. The method of operation of the touch surface can be inverted via the parameter “Behaviour”.

An additional 1-bit communication object “Status feedback” can be enabled via the parameter “Status display via status feedback”. If a switch actuator has a separate status feedback object, this additional object can be used to check whether the actuator has actually been switched. Otherwise, the

confirmation is always displayed in the panel that a touch surface has been operated.

Note:

The use of a status feedback object should be undertaken with care in Powernet installations since Powernet telegrams are sent at a slower speed (1200 Bit/s) than Twisted Pair telegrams (9600 Bit/s). The bus load must therefore be kept as low as possible for Powernet.

Push button

In the "Push button" function, a touch surface has either one or two communication objects. They can be 1-bit or 1-byte objects. ON, OFF, TOGGLE or value telegrams can be sent on the KNX via the object or both objects. The number of objects is set via the corresponding parameter while the size of the communication objects is set via "Object type".

For 1-bit communication objects, the pulse edge can be set individually. In the "Push button" function, there is a 1-bit communication object "Switch" available for defined switching. ON, OFF or TOGGLE telegrams can be sent on the KNX via this object.

The touch surface can thus be adapted to a wide variety of applications. If e.g. inching mode should be implemented, the setting "Send on at rising edge, off at falling edge" should be selected.

In the 1-byte object selection, values from "0" to "255" or from "0%" to "100" can be sent via the push button function.

For the 2-byte object selection, temperature values from -20°C to 100°C can be sent out in steps of 0.5°C via the button function.

Via parameter „Status display via feedback“ an additional 1-bit communication object „Response (1-bit)“ can be enabled. If a switching actuator has a separate feedback object, the additional object can be used to check whether the actuator has really switched. Otherwise the panel will always display the confirmation that the touch button has been actuated.

Note:

Feedback objects should be used with care for Powernet installations because Powernet telegrams are sent at a lower speed (1200 bit/s) than twisted-pair telegrams (9600 bit/s). The bus load should therefore be kept as low as possible for Powernet.

Dimmer

With the "Dimmer" function, an ON or OFF command is sent to the 1-bit communication object "Switch" after a short operation of the corresponding touch surface. If the surface is operated for a longer period, the panel sends commands for dimming brighter or darker to the 4-bit object "Dim". If the touch surface is released after a long operation, the panel immediately sends the command "Stop dimming".

The behaviour of the buttons can be set. This means it is possible to dim brighter or darker via the left or right button (switch on, off or toggle).

The status display of the button can also display the direct value (0%...100% or 0...255) as an alternative to the text or symbol display. To do so, the 1-byte object of the touch surface must first be linked with that of the dimming actuator.

An additional 1-bit or 1-byte communication object "Status feedback" can be enabled via the parameter "Status display via status feedback". If a switch actuator has a separate status feedback object, this additional object can be used to check whether the actuator has actually been switched or the percentage value indicated by the dimming actuator output.

Note:

The use of a status feedback object should be undertaken with care in Powernet installations since Powernet telegrams are sent at a slower speed (1200 Bit/s) than Twisted Pair telegrams (9600 Bit/s). The bus load must therefore be kept as low as possible for Powernet.

Dimmer with slider

When the surface of the „Dimmer with slider“ function is briefly pressed, an on or off command is signaled on the 1-bit communication object „Switching“. If the button is pressed longer,

a sliding bar is displayed. When the slider is adjusted, telegrams with percentage values are signaled on the 1-byte communication object „Value“.

The behaviour of the buttons can be set. This means it is possible to dim brighter or darker via the left or right button (switch on, off or toggle).

The status display of the button can also display the direct value (0%...100% or 0...255) as an alternative to the text or symbol display. To do so, the 1-byte object of the touch surface must first be linked with that of the dimming actuator.

An additional 1-bit or 1-byte communication object “Status feedback” can be enabled via the parameter “Status display via status feedback”. If a switch actuator has a separate status feedback object, this additional object can be used to check whether the actuator has actually been switched or the percentage value indicated by the dimming actuator output.

Note:

The use of a status feedback object should be undertaken with care in Powernet installations since Powernet telegrams are sent at a slower speed (1200 Bit/s) than Twisted Pair telegrams (9600 Bit/s). The bus load must therefore be kept as low as possible for Powernet.

Shutter

In the “Shutter” function, the touch surface has two 1-bit communication objects “Move” and “Step”. After a long operation, the panel sends telegrams to the linked shutter actuators to raise or lower the shutters. After a short operation, it sends telegrams to stop shutter movement or for louvre adjustment.

With the setting “Behaviour”, it is defined whether the shutter moves upwards or downwards when the right or the left touch surface is pressed.

Two additional 1-bit or 1-byte communication objects “Status feedback” can be enabled via the parameter “Status display via status feedback”. In the case of two 1-bit status feedback ob-

jects, one of the objects is used to display the state “Shutter UP” and the other is used to display “Shutter DOWN”. The current actual position of a shutter can be read at the 1-byte object. Shutter actuators which can send their current status via additional communication objects are a prerequisite for using status feedback objects.

Note:

The use of a status feedback object should be undertaken with care in Powernet installations since Powernet telegrams are sent at a slower speed (1200 Bit/s) than Twisted Pair telegrams (9600 Bit/s). The bus load must therefore be kept as low as possible for Powernet.

The shutter function has an additional communication object “Wind alarm”. If a wind alarm function has been integrated for example in the installation via a weather station, the object can be used to inform the user that a wind alarm has been triggered. In the event of a wind alarm (ON telegram), a prohibition sign appears on the push button and the operation is disabled.



Lightsscenes external input (1 bit)

In the function “Lightsscenes external input (1 bit)”, the touch surface has a 1-bit communication object. Two lightsscenes can be sent via this object. On each operation of the pulse edge, the active lightscene changes (from 0 to 1, from 1 to 0).

Lightsscenes external input (1 byte)

With the function “Lightsscenes external input (1 byte)”, one of 32 lightsscenes can be sent via a 1-byte communication object. The setting “Lightsscene number” defines which lightscene is sent.

The user has the option of storing lightsscenes himself. To do so, the parameter “Store scene by long push” must be set to “possible”. After a long operation of the touch surface (> 3 s), a bit is additionally set to “1” in the 1-

byte lightscene telegram. A lightscene module (generally the SMARTtouch panel) therefore knows that the requested lightscene should be stored and not retrieved. (See also "Functional description: Lightscenes")

Note:

If lightscenes are called, which are put down in the LEAN-/SMARTtouch panel, the call should be made by an internal group address. Take care, that every touch surface object, which should send out lightscenes, and the lightscene number object of the lightscene function, is linked via a common internal group address. Which lightscene number will be send out by the single touch surface, is set in the parameters of the respective touch surface.

Macro number

A touch surface can be linked with the macro actuator function via the "Macro number" function, at best via an internal address. The macro number which has been specified via the "Macro number" setting is sent via the 1-byte communication object "Macro number".

A "new" macro can be stored via a long push button action (approx. 3 s). This means that the user can save several functions as a macro which he continually retrieves and thus all the stored functions can be retrieved in sequence via a single operation of the macro touch surface.

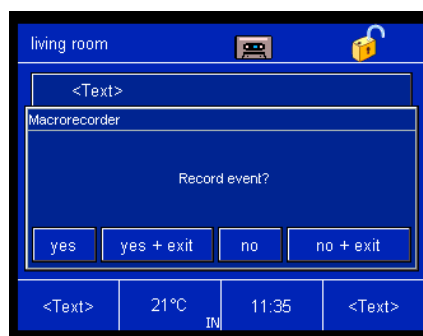

In the "Save macros" mode, the panel displays a dialog after each executed function in which the user can define whether or not he wishes to save this function in the macro. At the same time, he can finish the storing of macros in the same window. Up to 20 functions can be stored in a macro.

Value (1 byte, 2 byte)

The "Value" function causes the touch surface to send value telegrams via the associated "Value" object. Depending on whether the function "Value (1 byte)" or "Value (2 byte)" has been selected, the communication object is 1 byte or 2 bytes in size.

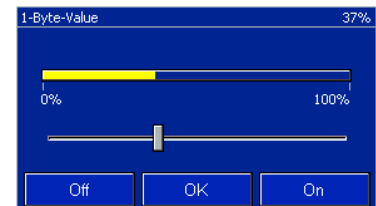

The 1-byte value function can display or send the following physical variables:

- Brightness
- Wetness (display only)
- Volume
- Value
- Temperature offset
- Current (display only)
- Wind direction (display only)

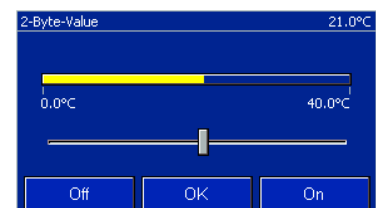

The 2-byte value function has the following variables by default:

- Temperature
- Illumination
- Wind force

The values will be send out direct during the operation of the slide control.

The respective physical variables are defined via the parameter "Display type". There is also the possibility of setting the "Display type" to "free scalable" for both values (1 byte and 2 byte). Other values than the preset values can thus also be displayed.

You can set the object value and the display value separate over the selection „freely scalable“. The object value is the value, which is send out over the 1-Byte- resp. 2-Byte-Object „Value“. The maximum resp. minimum object value, as well as the smallest resp. largest display value can be set individual (0...255 at 1-Byte, -99.999...+99.999 at 2-Byte). By this it

is possible to show a larger value and at the same time the send out values limited on a smaller area.

With the freely scalable setting, it is possible to parameterise the number of decimal places, the minimum and maximum object value and the minimum and maximum display value.

If the touch surface is pressed (“show and send”), the panel indicates a slide rule in the open window. The individual values can be set via this slide. A display in the upper section of the window indicates the exact value. The value is adjusted upwards or downwards by the smallest possible unit via the fields “On” or “Off”.

Floating point value

With the “Floating value” function, a touch surface can display and/or send a value of -99,999 to +99,999. There is a 4-byte communication object “Floating point value” available for this function.

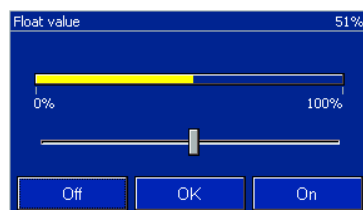

If the “Floating value” touch surface is pressed, the panel displays a slide rule and three buttons in the open window. Values can be set intuitively via the slide rule by adjusting the control button. Depending on the setting, the value can be increased or decreased via the buttons. The values will be send out directly during the operation of the slide control.

The displayed or transmitted values can adopt up to three decimal places, depending on the setting. The default setting is a percentage value (0...100%).

The object value and the display value can be set separately in the parameters. The object value is the value which is sent via the 4-byte object “Floating point value”. The maximum or minimum object as well as the smallest or largest display value can be set individually (from -99,999 to +99,999). It is therefore possible to display a larger value and

to simultaneously limit the transmitted value to a smaller range.

Room thermostat

If the function of the touch surface is defined as “Room thermostat”, the touch surface is used to control a room thermostat in order to change operating mode in the thermostat.



Since the room thermostat touch surface is an active button, a window with three further buttons “Standby”, “Comfort” and “Night” opens when it is pressed. Each of these three buttons has a 1-bit communication object by default. The objects “Comfort/Standby”, “Night” and “Frost/heat protection” are linked via a group address to objects with the same names in a room thermostat.

Room thermostats in accordance with the KNX standard have the option of toggling between operating modes via a 1-byte communication object. To be able to operate this room thermostat, the setting “Toggle operating modes” must be modified to “1 byte”. The size of the 1-byte value corresponds to the operating mode in this case and is defined in the same way in both the panel and the room thermostats, in accordance with the KNX standard.

The actual temperature can be read via the pop-up window which opens once the touch surface is pressed. This function must be activated beforehand by the corresponding parameters. The operating mode and the actual temperature are not only displayed in the pop-up window but also on the button itself.

Note:

The integrated room thermostat of the panel is retrieved via a push button action on the temperature display in the bottom line of the display.

Counter

If a touch surface is assigned the function "Counter", it is used to indicate counter contents. These can be counts with and without leading signs. It depends on the setting "Display type" as to whether the display has a leading sign.

Three different bit sizes can be displayed. It is defined directly via the functional selection whether a 1-byte, 2-byte or a 4-byte count should be displayed. Depending on the selection, a 1-byte, 2-byte or a 4-byte communication object "Counter value" is available for receiving new count values.

Via parameters „Smallest display value“ and „Largest display value“ the value displayed on the touch button can be restricted.

Via parameters „Minimum object value“ and „Maximum object value“ the value on the communication object „Counter value“ can be restricted.

Text

The "Text" function enables a 14-byte long text element to be displayed on the touch surface or sent. The function has a 14-byte communication object "Text" for receiving and sending text.

It is defined via the "Text" setting in the parameters whether the text should only be displayed or displayed and sent. If text should also be sent, the text is defined in the field "Message text". The text may be 13 characters long.

Hyperlink function

Each touch surface can be assigned a hyperlink function. This means that by pressing the touch surface, it is possible to change to any page (pages 1 to 21), to the system page, to the "Extras" page, to the „Info“ page, to the alarm control unit or to the page with the alarm messages.

As the combination of pages is unlimited, it is important to keep the page

structure at the forefront during the planning stage.

Example 1:

In a detached house, the panel starts with the following options:

- Lounge
- Kitchen
- Bedroom
- Children's room 1
- Children's room 2
- Study
- Further rooms
- House scenes
- Alarm messages
- Alarm control unit

The two footer buttons refer to the system page and the "Extras" page. On the "Further rooms" page, the user gains access to the following:

- Hallway
- Cellar
- Attic
- etc.

Example 2:

In a conference room, the panel starts with the following options:

- Scene selection
- Lighting
- Shutters
- Heating
- System

Note1:

The preview window in the panel software can be very helpful during the configuration. All the hyperlink functions for individual pages can be tested here without having to load the project into the panel. It would be unfortunate to have defined a hyperlink function to a page from which the user cannot change back. The panel must therefore be recommissioned and this is only possible by temporarily isolating the voltage.

An additional 1-bit communication object "Status feedback (Receive)" can be enabled via the parameter "Status display via status feedback". The status of the object is then displayed on the touch surface e.g. "ON" or "OFF".

Note2:

If a jump function to the information page is to be implemented, it should be noted that the information page has been switched to „active“ under general parameters.

**Functional description of operator
 function pages 1...21**

Function	Application
Page 1	Inactive Operator function Media control
Page 2	Inactive Operator function Media control
...	
Page 21	Inactive Operator function Media control

**Functional description of operator
 function touch surfaces/symbols
 (pages 1...21)**

Function	Application
Touch surface 1 (symbol 1)	Inactive Switch Push button Dimmer Dimmer with slider Shutter Lightscenes extension input (1 bit) Lightscenes extension input (1 byte) Macro number Value (1 byte) Value (2 byte) Floating point value (4 byte) Room thermostat Counter (1 byte) Counter (2 byte) Counter (4 byte) Text Hyperlink function
...	
Touch surface 10 (symbol 8)	Inactive Switch Push button Dimmer Dimmer with slider Shutter Lightscenes extension input (1 bit) Lightscenes extension input (1 byte) Macro number Value (1 byte) Value (2 byte) Floating point value (4 byte) Room thermostat Counter (1 byte) Counter (2 byte) Counter (4 byte) Text Hyperlink function
Touch surface of left footer	Hyperlink function
Touch surface of right footer	Hyperlink function

Communication objects
for "Switch" touch surfaces

No.	Type	Object name	Function
0	1 bit	Switch	Send/Receive
1	1 bit	Status feedback (1 bit)	Receive

Communication objects
for "Push button" touch surfaces with one 1-bit object

No.	Type	Object name	Function
0	1 bit	Switch 1	Send/Receive

Communication objects
for "Push button" touch surfaces with two 1-bit object

No.	Type	Object name	Function
0	1 bit	Switch 1	Send/Receive
1	1 bit	Switch 2	Send/Receive

Communication objects
for "Push button" touch surfaces with one 1-byte object

No.	Type	Object name	Function
0	1 byte	Value 1	Send/Receive

Communication objects
for "Push button" touch surfaces with two 1-byte object

No.	Type	Object name	Function
0	1 byte	Value 1	Send/Receive
1	1 byte	Value 2	Send/Receive

Communication objects
for "Push button" touch surfaces with one 2-byte object

No.	Type	Object name	Function
0	2 byte	Value 1	Send/Receive

Communication objects
for "Push button" touch surfaces with two 2-byte object

No.	Type	Object name	Function
0	2 byte	Value 1	Send/Receive
1	2 byte	Value 2	Send/Receive

Communication objects
for "Push button" touch surfaces with 1-bit status feedback

No.	Type	Object name	Function
...			
3	1 bit	Status feedback (1 bit)	Receive

Communication objects
for "Dimmer" touch surfaces with 1-bit status feedback

No.	Type	Object name	Function
0	1 bit	Switch	Send/Receive
1	4 bit	Dim	Send
2	1 byte	Value	Receive
3	1 bit	Status feedback	Receive

Communication objects
for "Dimmer" touch surfaces with 1-byte status feedback

No.	Type	Object name	Function
...			
3	1 byte	Value	Receive

Communication objects
for "Dimmer with slider" touch surfaces with 1-bit status feedback

No.	Type	Object name	Function
0	1 bit	Switch	Send/Receive
1	1 byte	Value	Receive
2	1 bit	Status feedback	Receive

Communication objects
for "Dimmer with slider" touch surfaces with 1-byte status feedback

No.	Type	Object name	Function
...			
2	1 byte	Value	Receive

Communication objects
for "Shutter" touch surfaces with 1-bit status feedback

No.	Type	Object name	Function
0	1 bit	Move	Send/Receive
1	1 bit	Step	Send
2	1 bit	Wind alarm	Receive
3	1 bit	Value (Status feedback) 1 bit, raise	Receive
4	1 bit	Value (Status feedback) 1 bit, lower	Receive

ABB i-bus® KNX
ABB Powernet KNX

SMARTtouch (colour)
Type: 6x36/100x..., 6x36/100CB...

Communication objects
for "Shutter" touch surfaces with 1-byte
status feedback

Nr.	Typ	Objektname	Funktion
...			
3	1 byte	Value (Status feedback) 1 byte	Receive

Communication objects
for "1-bit lightscenes" touch surfaces

No.	Type	Object name	Function
0	1 bit	Lightscene number	Send/Receive

Communication objects
for "1-byte lightscenes" touch surfaces

No.	Type	Object name	Function
0	1 byte	Lightscene number	Send/Receive

Communication objects
for "Macro" touch surfaces

No.	Type	Object name	Function
0	1 byte	Macro number	Send/Receive

Communication objects
for "1-byte value" touch surfaces

No.	Type	Object name	Function
0	1 byte	Value	Send/Receive

Communication objects
for "2 byte value" touch surfaces

No.	Type	Object name	Function
0	2 byte	Value	Send/Receive

Communication objects
for "Floating value" touch surfaces

No.	Type	Object name	Function
0	4 byte	Floating point value	Send/Receive

Communication objects
for "Room thermostat" touch surfaces
with 1-bit toggling of operating mode

No.	Type	Object name	Function
0	1 bit	Standby/Comfort	Send/Receive
1	1 bit	Night	Send/Receive
2	1 bit	Frost/heat protection	Send/Receive
3	2 byte	Actual value	Receive

Communication objects
for "Room thermostat" touch surfaces
with KNX 1-byte toggling of operating
mode

No.	Type	Object name	Function
0	1 byte	Toggling of operating mode	Send/Receive
...			

Communication objects
for "2-byte counter" touch surfaces

No.	Type	Object name	Function
0	2 byte	Counter value	Receive

Communication objects
for "4-byte counter" touch surfaces
(Control page)

No.	Type	Object name	Function
0	4 byte	Counter value	Receive

Communication objects
for "1-byte counter" touch surfaces

No.	Type	Object name	Function
0	1 byte	Counter value	Receive

Communication objects
for "Text" touch surfaces

No.	Type	Object name	Function
0	14 byte	Text	Send/Receive

Communication objects
for hyperlink functions with status
feedback

No.	Type	Object name	Function
0	1 bit	Status feedback (Receive)	Receive

Page parameters (page 1...21)
The default setting for the values is **printed in bold type**.

Parameters: "Switch" touch surface
The default setting for the values is **printed in bold type**.

- Name of page	<Text>
- Representation of operator page	5 touch surfaces 10 surfaces 8 symbols
- Name of button	<Text>
- Operation	Direct Via pop-up
- Behaviour	Left=Off, Right=On Left=On, Right=Off
- Status display	Text Symbol User-defined symbol
Only if "Text" is selected:	
- Text for on	On
- Text for off	Off
Only if "Symbol" is selected:	
- Status display via status feedback	No / Yes
- Button description	Text Symbol User-defined symbol
Only if "Text" is selected:	
- Text for on	On
- Text for off	Off
Only if "Symbol" is selected:	
	<i>(see below)</i>

Symbols for "Switch" or "Push button" touch surface

Symbols for status display ON/OFF:

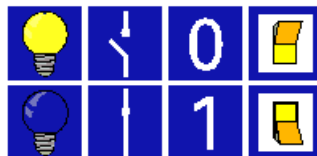

Symbols for button description ON/OFF:

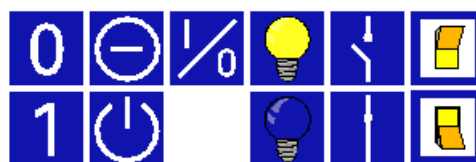

Parameters: "Push button" touch surface

The default setting for the values is printed in bold type.

– Name of button	<Text>
– Operation	Direct Via pop-up with single button operation
– Number of objects	1 / 2
– Object type	1 bit 1 byte (0...255) 1 byte (0%...100%) 2 byte
Only for 1 bit and 1 object:	
– Behaviour	send OFF on rising edge send OFF on falling edge send OFF for both edges send ON on falling edge send OFF on rising edge, send ON on falling edge send ON on rising edge send ON on rising edge, send OFF on falling edge send ON for both edges send TOGGLE on rising edge send TOGGLE on falling edge
Only for 1 bit and 2 objects:	
– Behaviour	send OFF on rising edge (object 1), send ON on falling edge (object 2) send OFF on rising edge, send ON on falling edge (objects 1 and 2) send ON on rising edge (object 1), send OFF on falling edge (object 2) send ON for both edges (objects 1 and 2)
Only for 1 byte (0...255) and 1 object:	
– Value 1	0
– Behaviour	send value 1 on rising edge send value 1 on falling edge send value 1 for both edges
Only for 1 byte (0...255) and 2 objects:	
– Value 1	0
– Value 2	255
– Behaviour	send value 1 (object 1) on rising edge, send value 2 (object 2) on falling edge send value 2 (object 2) on rising edge, send value 1 (object 1) on falling edge
Only for 1 byte (0%...100%) and 1 object:	
– Value 1	0%
– Behaviour	send value 1 on rising edge send value 1 on falling edge send value 1 for both edges
Only for 1 byte (0%...100%) and 2 objects:	
– Value 1	0%
– Value 2	100%
– Behaviour	send value 1 (object 1) on rising edge, send value 2 (object 2) on falling edge send value 2 (object 2) on rising edge, send value 1 (object 1) on falling edge

Parameters: “Push button” touch surface

The default setting for the values is **printed in bold type**.

Only for 2 Byte and 1 object:	
- Value 1	- 20
- Behaviour	send value 1 on rising edge send value 1 on falling edge send value 1 for both edges
Only for 2 byte and 2 objects:	
- Value 1	-20
- Value 2	100
- Behaviour	send value 1 (object 1) on rising edge, send value 2 (object 2) on falling edge send value 2 (object 2) on rising edge, send value 1 (object 1) on falling edge
- Schaltflächenbeschriftung	Text Symbol Symbol benutzerdefiniert
nur bei Text:	
- Schaltflächentext	Taster
nur bei Symbol:	
- Display switching status by status feedback	No / Yes
- Display switching status	Text Symbol User-defined symbol
nur bei Text:	
- Text für 1	Ein
- Text für 0	Aus
nur bei Symbol:	
(siehe unten)	
nur bei Wert:	
- Wert 1	1
- Wert 2	0

Symbols for “Push button” touch surface

Symbols for status display ON/OFF:

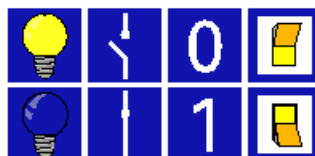

Symbols for button description ON/OFF:



Parameters: “Dimmer” touch surface

The default setting for the values is **printed in bold type**.

– Name of button	<Text>
– Operation	Direct Via pop-up
– Behaviour	Left brighter on, right darker off Left darker off, right brighter on Left brighter toggle, right darker toggle Left darker toggle, right brighter toggle
– Button description	Text Symbol
– Name of button	<Text>
– Operation	Direct Via pop-up
Only if “Text” is selected:	
– Text for ON resp. brighter	On
– Text for OFF resp. darker	Off
Only if “Symbol” is selected:	<i>(see below)</i>
Status display via status feedback	No 1 bit 1 byte (0%...100%) 1 byte (0...255)
Only for 1-bit status feedback:	
– Display switching status	Text Symbol User-defined symbol
Only if “Text” is selected:	
– Text for ON resp. brighter	On
– Text for OFF resp. darker	Off
Only if “Symbol” is selected:	<i>(see below)</i>
Only for 1-byte status feedback:	
– Display switching status	Direct value display

Symbols for button description ON/OFF or brighter/darker:

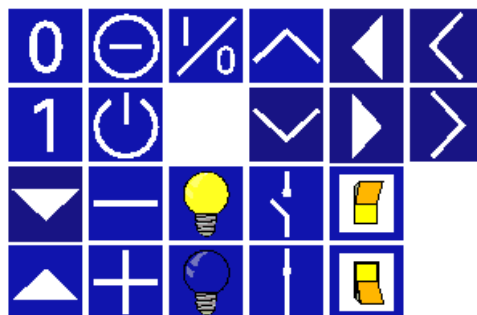

Symbols for status display ON/OFF or brighter/darker:

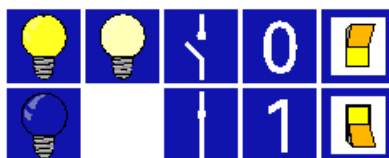

Parameters: "Shutter" touch surface
 The default setting for the values is **printed in bold type**.

- Name of button	<Text>
- Operation	Direct Via pop-up
- Behaviour	Left=up/right=down Left=down/right=up
- Status feedback object	No 1 bit 1 byte
- Button description	Text Symbol User-defined symbol
Only if "Text" is selected:	
- Text for 1 resp. down	Down
- Text for 0 resp. up	Up
Only if "Symbol" is selected:	
- Display switching status	Text Symbol User-defined symbol
Only if "Text" is selected:	
- Text for lower	DOWN
- Text for raise	UP
Only if "Symbol" is selected:	
	(see below)

Symbols for button description 1-0 or UP/DOWN:

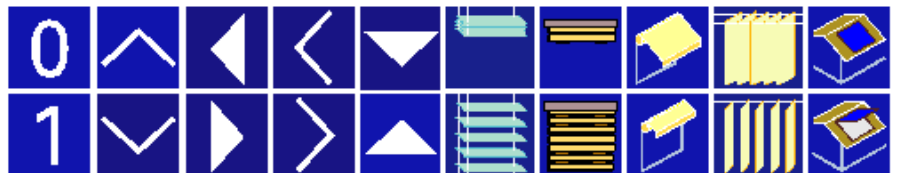

Symbols for status display 1-0 or UP/DOWN:



**Parameters: “1-bit lightscenes”
 touch surface**
 The default setting for the values
 is **printed in bold type**.

– Name of button	<Text>
– Operation	Direct Via pop-up
– Lightscene number	0 / 1
– Store scene by long push	not possible
– Button description	Text Symbol User-defined symbol
Only if “Text” is selected:	
– Text for lightscene call	Start
Only if “Symbol” is selected:	<i>(see below)</i>
– Display switching status	Text Symbol User-defined symbol
Only if “Text” is selected:	
– Text if scene is active	Active
Only if “Symbol” is selected:	<i>(see below)</i>

Symbols for button description “Lightscene retrieval”:

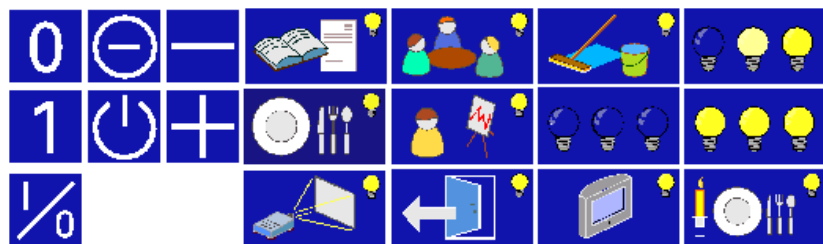

Symbols for status display if scene is active:

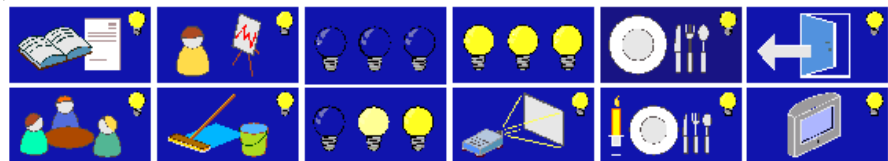

Parameters: "1-byte lightscenes" touch surface
 The default setting for the values is **printed in bold type**.

- Name of button	<Text>
- Operation	Direct Via pop-up
- Lightscene number	1 / 2 / 3 / ... / 31 / 32
- Store scene by long push	not possible possible
- Button description	Text Symbol User-defined symbol
Only if "Text" is selected:	
- Text for lightscene call	Start <i>(see below)</i>
Only if "Symbol" is selected:	
- Display switching status	Text Symbol User-defined symbol
Only if "Text" is selected:	
- Text if scene is active	Active <i>(see below)</i>
Only if "Symbol" is selected:	<i>(see below)</i>

Symbols for button description "Lightscene retrieval":

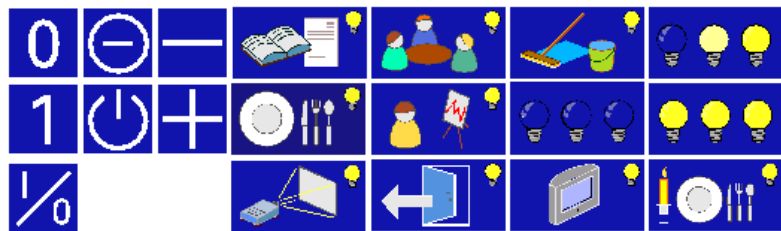

Symbols for status display if scene is active:

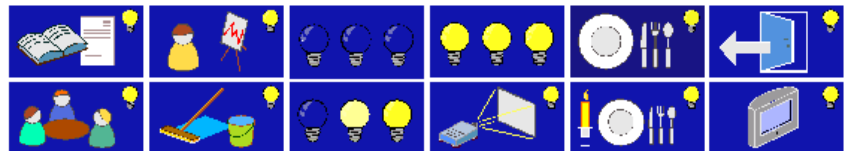

Parameters: “Macro” touch surface
The default setting for the values is **printed in bold type**.

– Name of button	<Text>
– Save macro via long push button action	Possible
– Display switching status	Text Symbol User-defined symbol
Only if “Text” is selected:	
– Text if macro is active	Active
Only if “Symbol” is selected:	
– External retrieval via	1 byte
– Macro number	1 / 2 / 3 / ... / 31 / 32

Symbols for status display if macro is active:

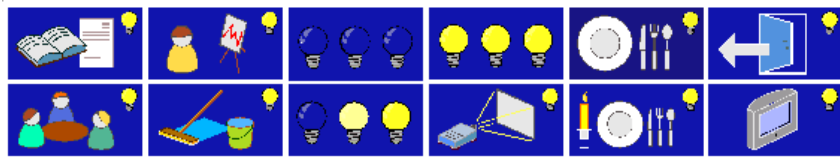

Parameters: “1-byte value” touch surface
The default setting for the values is **printed in bold type**.

– Name of button	<Text>
– Display type	Brightness Wetness Volume Value Temperature offset (-5K...+5K) Current Wind direction free scalable
Only for brightness, volume and value:	
– Value	show only show and send
– Range of values	0% to 100% 0 to 255
Only for “show and send”:	
– Button description	Text Symbol
Only if “Text” is selected:	
– Text for value increasing	On
– Text for value lowering	Off
Only if “Symbol” is selected: (see below)	
Only for wetness:	
– Value	show only
– Range of values	0% to 100% 0 to 255
Only for temperature offset:	
– Value	show and send
– Range of values	-5K to +5K
– Button description	Text Symbol
Only if “Text” is selected:	
– Text for value increasing	On
– Text for value lowering	Off
Only if “Symbol” is selected: (see below)	

Parameters: “1-byte value” touch surface

The default setting for the values is **printed in bold type**.

Only for current:	
– Value	show only
– Range of values	0 to 51.5 mA 0 to 25.5 A
Only for “free scalable”:	
– Text for Unit	<Text>
– Decimal places	0 / 1 / 2
– Minimum object value	0...255
– Maximum object value	0...255
– Lowest display value	0...255
– Highest display value	0...255
– Value	show only show and send
Only for “show and send”:	
– Button description	Text Symbol
Only if “Text” is selected:	
– Text for value increasing	On
– Text for value lowering	Off
Only if “Symbol” is selected: <i>(see below)</i>	

Symbols for button description:

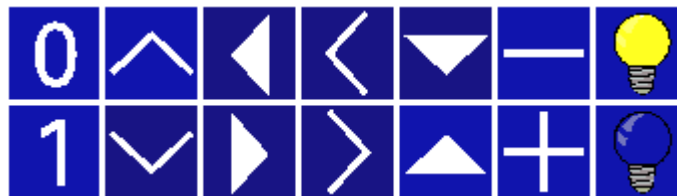

Parameters: “2-byte value” touch surface

The default setting for the values is **printed in bold type**.

– Name of button	<Text>
– Display type	Temperature Illumination Wind force free scalable
Only for temperature:	
– Range of values	-0.0°C ... 40.0°C -99.9°C ... 600.0°C -5K ... +5K
Only for -0.0°C...40.0°C:	
– Increment	0.25°C / 0.5°C / 1°C / 2°C
Only for -99.9°C...600.0°C:	
– Increment	3°C / 5°C / 10°C / 20°C
Only for -5K...+5K:	
– Increment	0.1K / 0.2K / 0.5K / 1K
– Value	show only show and send
Only for “show and send”:	
– Button description	Text Symbol
Only if “Text” is selected:	
– Text for value increasing	On
– Text for value lowering	Off
Only if “Symbol” is selected:	
– Range of values	0...100,000 lux
Only for wind force:	
– Range of values	0...200 m/s
Only for “free scalable”:	
– Text for Unit	<Text>
– Decimal places	0 / 1 / 2 / 3
– Minimum object value	-99.999... 0 ...99.999
– Maximum object value	-99.999... 100 ...99.999
– Lowest display value	-99.999... 0 ...99.999
– Highest display value	-99.999... 100 ...99.999
– Button description	Text Symbol User-defined symbol
Only if “Text” is selected:	
– Text for value increasing	On
– Text for value lowering	Off
Only if “Symbol” is selected:	
	(see below)

Symbols for button description:



Parameters: “Floating value” touch surface

The default setting for the values is **printed in bold type**.

– Name of button	<Text>
– Display type	freely scalable
– Text for unit	%
– Decimal places	0 / 1 / 2 / 3
– Minimum object value	-99.999... 0 ...99.999
– Maximum object value	-99.999... 100 ...99.999
– Lowest display value	-99.999... 0 ...99.999
– Highest display value	-99.999... 100 ...99.999
– Value	show only show a
Only for “show and send”:	
– Button description	Text Symbol
Only if “Text” is selected:	
– Text for value increasing	On
– Text for value lowering	Off
Only if “Symbol” is selected:	(see below)

Symbols for button description:



Parameters: “Room thermostat” touch surface

The default setting for the values is **printed in bold type**.

– Name of button	<Text>
– Operation	Via pop-up
– Behaviour	Only show standby/comfort, night and frost Show and send standby/comfort, night and frost
– Unit	°C
– Toggling of operating mode	1 bit 1 byte
Only for show and send:	
– Display actual value	No / Yes
– Button description	Text Symbol User-defined symbol
Only if “Text” is selected:	
– Text for comfort	Comfort
– Text for standby	Standby
– Text for night reduction	Night
Only if “Symbol” is selected:	(see below)

Symbols for button description:



Parameters: “2-byte counter” touch surface

The default setting for the values is **printed in bold type**.

– Name of button	<Text>
– Display type	without leading sign with leading sign
– Display switching status	Count value
– Lowest display value	0
– Highest display value	255
– Minimum object value	0
– Maximum object value	255
– Value	show only show and send only send

Parameters: “4-byte counter” touch surface

The default setting for the values is **printed in bold type**.

– Name of button	<Text>
– Display type	without leading sign with leading sign
– Display switching status	Count value
– Lowest display value	0
– Highest display value	65535
– Minimum object value	0
– Maximum object value	65535
– Value	show only show and send only send

Parameters: “1-byte counter” touch surface

The default setting for the values is **printed in bold type**.

– Name of button	<Text>
– Display type	without leading sign with leading sign
– Display switching status	Count value
– Lowest display value	0
– Highest display value	4294967295
– Minimum object value	0
– Maximum object value	4294967295
– Value	show only show and send only send

Parameters: “Text” touch surface

The default setting for the values is **printed in bold type**.

– Name of button	<Text>
– Text	show only show and send
Only for “show and send”:	
– Message text (max. 13 characters)	Text

Parameters: “Hyperlink” touch surface

The default setting for the values is **printed in bold type**.

– Name of button	<Text>
– Jump to page	Page 1 / Page 2 / ... / Page 21 / System / Extras / Alarm control unit / Alarm messages
– PIN-Code-Key (Priority)	No PIN Code Step 1 Step 2 Step 3 Step 4

Functional description: Time programs

Settings

Depending on the parameterisation, the SMARTtouch panel offers up to 20 switch channels. The number of channels that should be enabled is defined in the general settings.

In addition, there is the possibility of "Enable time programs for end customers" via the corresponding parameter. The modification option can be given a code or fully disabled.

Changes made by the end customer are stored in the memory of the panel and are not lost on mains voltage failure. If however changes are made to the rest of the panel configuration and then programmed into the panel, the panel software overwrites by default the time settings of the end customer. This behaviour can be modified via the setting "Overwrite time switch settings at download".

A so-called astro function can also be activated for the individual switching times. This means that a set switching time adapts itself to sunrises and sunsets. With the option "Town selection", it is possible to select a town in Germany which is closest to the installation site of the panel. If the exact coordinates are known, the longitude and latitude can also be entered.

Holiday

The SMARTtouch panel has the option of setting each individual channel to a so-called holiday function. The setting "active on holidays" can be selected for each switching time on the switch channel.

Under the menu item "Extra" on the panel, you can find the "Holiday" touch surface which you use to activate the holiday function. Two further buttons "Start of holiday" and "End of holiday" are activated which you can use to enter the required date. If the date for the "Start of holiday" is reached, all the corresponding holiday time programs are activated automatically.

Individual time programs can thus be retrieved in the holiday period (holiday profile). When the date for the "End of holiday" is reached, the holiday time programs are automatically deactivated.

The holiday function is activated via the 1-bit communication object "Holi-

day". An ON telegram switches the function on while an OFF telegram switches it off again. The linking of the object "Holiday" with an internal address of the panel can of course also be carried out.

Note:

Please note that only those switch channels which you have explicitly selected via the parameter "Switching function" switch on and off in the holiday function. This is carried out separately for each switching time on the channel.

Switch channels

Each switch channel has at least one 1-bit, 1-byte or 2-byte communication object. Switch, shutter and/or dimming actuators can thus be addressed and lightscenes or macros can be retrieved. The bit size is defined via the setting "Function".

Alternatively, it can also be defined via the "Function" parameter whether a room thermostat should be addressed via the switch channel. In this case, the switch channel has the two 1-bit objects "Standby/Comfort" and "Night" or a KNX 1-byte communication object "Toggling of operating mode" available. It is possible to toggle the 1-bit room thermostat communication objects "Comfort" and "Night" or the KNX 1-byte object directly. Either the internal objects of the panel which are linked via an internal group address or an external room thermostat are addressed. In the latter case, the objects must be linked with a corresponding external group address.

If the function setting is set to "Value (2 byte) (0...50°C)", a 2-byte communication object is available to the switch channel which can be used to send temperature values to room thermostats. It is possible via this object to send a new base setpoint to a room thermostat at a specified time.

An additional 1-bit enable object can be activated on each switch channel. This is carried out via the parameter "Activation object". If an enable object is activated, this must receive an ON telegram so that the time switch channel is able to switch.

The switch channels of the SMARTtouch panel have 10 switching times

Diagram for setting the switching times directly on the panel, if this option is enabled

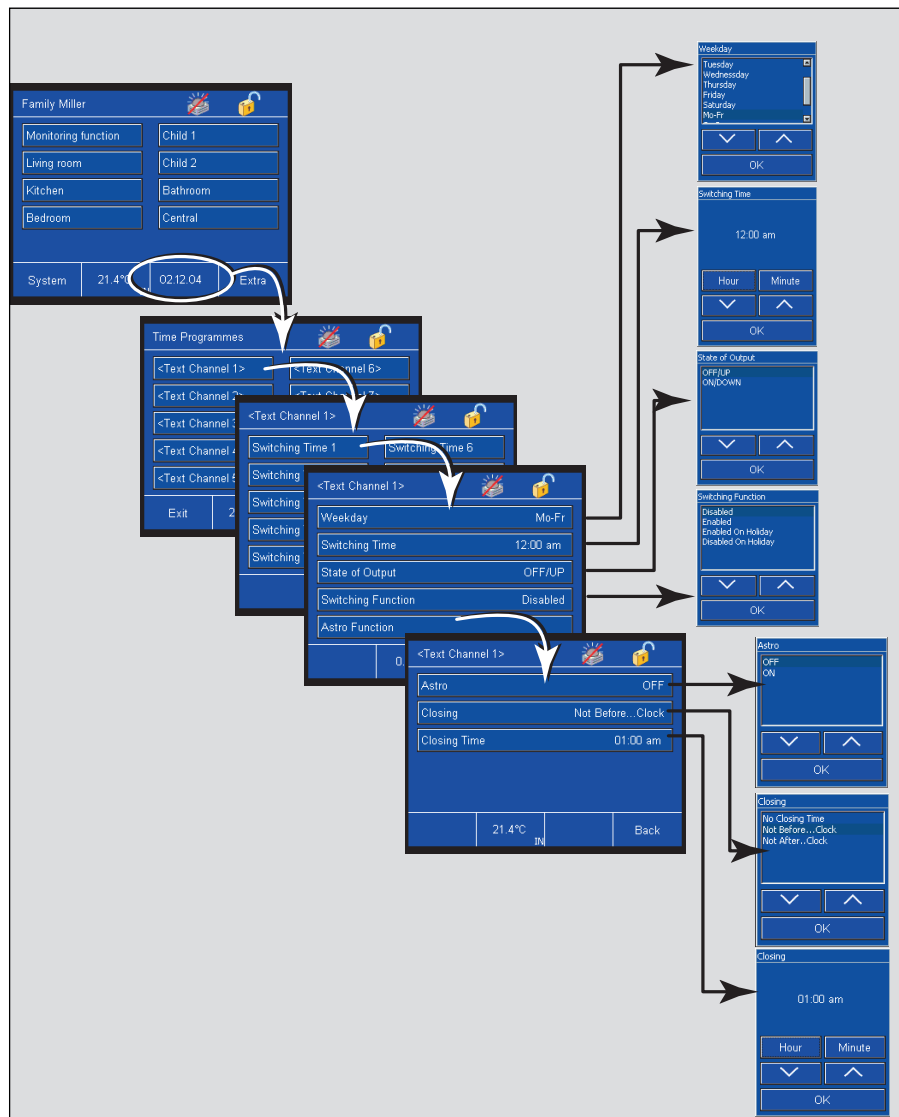

each. The switching times can either be set on the panel (see diagram) or in the parameters of the panel software. After the switching time is set, it is displayed on the touch button of the control panel.

It can be defined on which day of the week and at which switching time the channel should be switched.

If a 1-bit function is set, it is possible to switch either OFF/UP or ON/DOWN. If a 1-byte function is set, a value between 0 and 255 or a percentage value of 0% to 100% can be sent. The room thermostat function makes it possible to change to the comfort, standby or night operating mode of the room thermostat.

In addition, the astro functionality can be activated for each channel. Blok-

king times can also be set such as "not before 05:00" or "not after 22:00". The automatic adjustment of the astro programs are restricted due to the position of the sun which changes daily. For example, a shutter would never be lowered later than 22:00, even if a further connection would be necessary according to the ASTRO calendar.

In addition, there is the possibility of integrating each channel in the holiday functionality (see also "Holiday")

Functional description: Time programs

Note:

The function of a switch channel (Switch 1 bit, Value 1 byte, Value 2 byte or Room thermostat 2x1 bit or 1x1 byte) is defined in the parameters.

Note:

If a text under "Name of time channel" is entered under the parameters of the individual switching channels (e.g. "External lighting" or "Night mode"), this text will also be adopted in the tree of the parameter software, to provide a better overview when configuring parameters. The lettering "Switching channel 1", "Switching channel 2" etc., are then replaced by "External lighting", "Night mode", etc.

Function	Application
General	Settings
Switch channel 1	Switch
Switch channel 2	Switch
Switch channel 3	Switch
Switch channel 4	Switch
Switch channel 5	Switch
Switch channel 6	Switch
Switch channel 7	Switch
Switch channel 8	Switch
Switch channel 9	Switch
Switch channel 10	Switch
Switch channel 11	Switch
Switch channel 12	Switch
Switch channel 13	Switch
Switch channel 14	Switch
Switch channel 15	Switch
Switch channel 16	Switch
Switch channel 17	Switch
Switch channel 18	Switch
Switch channel 19	Switch
Switch channel 20	Switch

Communication objects
for time programs (General)

No.	Type	Object name	Function
0	1 bit	Holiday	Receive

Communication objects
for "Switch" switch channel

No.	Type	Object name	Function
0	1 bit	Switch	Send
2	1 bit	Enable	Send/Receive

Communication objects
for 1-byte value switch channel

No.	Type	Object name	Function
0	1 byte	Value	Send
2	1 bit	Enable	Send/Receive

Communication objects
for RT switch channel

No.	Type	Object name	Function
0	1 bit	Standby/Comfort	Send
1	1 bit	Night	Send
2	1 bit	Enable	Send/Receive

Communication objects
for RT switch channel with KNX 1-byte toggling of operating mode

No.	Type	Object name	Function
0	1 byte	Toggling of operating mode	Send
2	1 bit	Enable	Send/Receive

Communication objects
for 1-byte value switch channel

No.	Type	Object name	Function
0	2 byte	Value	Send
2	1 bit	Enable	Send/Receive

Communication objects
for lightscenes or macro switch channel

No.	Type	Object name	Function
0	1 byte	Lichtscene/Macro	Send
2	1 bit	Enable	Send/Receive

Parameters: General settings

The default setting for the values is **printed in bold type**.

General	
– Number of switch channels 1...20	1 / 2 / 3 / 4 / ... / 19 / 20
– Overwrite time switch settings at download	No / Yes
– Enable time programs for end customers	Yes With code No
– Coordinates for astro displacement	via town selection via input of coordinates
Only for town selection:	
– Town	Berlin / Bielefeld / Bremen / Essen / Flensburg / Frankfurt / Hamburg / Hannover / Kassel / Köln / Mönchengladbach/ München / Nürnberg / Saarbrücken / Stuttgart / Dresden / Wien / Salzburg / Graz / Linz / Innsbruck / Bregenz / London / Madrid / Rome / Brussels / Amsterdam / Zurich / Paris / Stockholm / Oslo / Helsinki / Copenhagen / Warsaw / Riga / Prague / Bratislava / Moscow / Ekatarienburg / Bangkok / Peking / Singapore / Luxemburg / Lissabon / Genf / Dublin / Kuwait
Only for coordinates:	
– Latitude	51.216
– Longitude	7.633

**General parameters for switch
channels (separate for each switch
channel)**

The default setting for the values is **printed in bold type**.

Note

The "Name of time channel" (e.g. "External lighting" or "Night mode") will also be adopted in the tree of the parameter software, to provide a better overview during configuring of parameters.

General	
– Name of time channel	<Text>
– Function	1 Bit 1 Byte (0...255) 1 Byte (0...100%) RT (Standby/Comfort Night) RT (Standby/Comfort Night)/1 byte Value (2 byte) (0...50°C) Lightscene/Macro (1...32)
– Activation object	No / Yes
Only for "Yes":	
– Activation object after mains voltage recovery	Disabled Enabled

Parameters for switching times (separate for each switching time)

The default setting for the values is **printed in bold type**.

– Time	00:00
– Weekday	Monday Tuesday Wednesday Thursday Friday Saturday Sunday Monday to Friday Monday to Saturday Monday to Sunday Saturday and Sunday
Only for 1-bit function:	
– Status	Off/Up On/Down
Only for 1-byte function (0...255)	
– Status	0
Only for 1-byte function (0...100%):	
– Status	0% / 10% / 20% / ... / 90% / 100%
Only for RT function and RT 1 byte:	
– Status	Standby Comfort Night
Only for value function (2 byte) (0...50°C):	
– Status	0
Only for function "Lightscene/Macro (1...32)":	
– Status	1
– Astro	Inactive Active
– Locking	Inactive not before ... o'clock not after ... o'clock
– Blocking time	00:00
– Switching function	always inactive always active active on holidays inactive on holidays

Functional description: IR control

General

The SMARTtouch panel can be addressed via IR remote control. All the panel types operate together with the Busch-Ferncontrol® IR hand-held transmitter. The SMARTtouch B&O panel can alternatively also be controlled by the Bang&Olufson remote control Beo4.

The receiving range of a panel can be set. The IR colours “white”, “blue” or “white & blue”. It is possible to switch between colours with the help of a slide switch directly on the Busch-Ferncontrol® hand-held transmitter. If the IR range is set to “white & blue”, the panel software indicates the individual push button pairs twice - once for the “white” IR range and a further time for the “blue” IR range.

The parameter “Bang&Olufson” only operates together with the SMARTtouch panel 6x36/100CB. If the IR range is set to “Bang&Olufson”, the panel can either be operated via the Busch-Ferncontrol® IR hand-held transmitter or the Bang&Olufson Beo4 IR remote control.

Push button assignment

The individual push button pairs of the Busch-Ferncontrol® IR hand-held transmitter or the Bang & Olufson remote control Beo4 can be assigned the following functions:

- Switch,
- Dimmer,
- Shutter,
- Push button,
- Value
- and Lightscene external input.

The memo buttons of the IR hand-held transmitter or the push buttons green, orange, red, blue and stop of the Bang & Olufson remote control Beo4 can be used for sending lightscene numbers.

Switch

With the “Switch” function, a 1-bit communication object “Switch” is enabled for the push button pair. Switching telegrams are sent via this object to the linked actuators. The parameter “Behaviour” defines whether the right or the left push button switches “ON”. The setting “TOGGLE” means that toggling is always carried out when the right or

left push button is pressed i.e. the communication object adopts a new value after each operation.

Example:

If the object currently has the value “1”, the object adopts the value “0” after an operation and sends it. If the object has the value “0”, the object value changes to “1” after an operation. The value “1” is of course also sent out after a change.

Dimmer

If the function of a push button pair is defined as a dimmer, the push button pair has two communication objects - a 1-bit object “Switch” for sending switching telegrams and a 4-bit object “Dim” for sending dimming telegrams.

A switching telegram (ON or OFF telegram) is always sent after a short operation. If a push button is operated for a long period (>0.5 s), a dimming telegram is triggered.

The parameter “Behaviour” defines whether dimming brighter or darker is carried out when the right or left push button is pressed.

Shutter

The shutter functionality of a push button pair causes a push button pair to send stop/step telegrams after a short operation and up/down telegrams after a long operation (>0.5 s) to linked shutter actuators.

The shutter function has two 1-bit communication objects - “Step” (stop/step) and “Move” (up/down).

The “Behaviour” parameter defines whether the shutter is raised or lowered when the right or left push button is pressed.

Push button

Via the “Push button” function, it is possible to send telegrams when a push button of the pair is pressed, released or pressed and released. A 1-bit communication object “Switch left” or “Switch right” is available for each push button of the pair.

The behaviour is defined via the corresponding parameter. When the push button is operated (on release), an

ON, OFF or TOGGLE telegram can be sent. "TOGGLE" means that toggling is always carried out when the right or left push button is switched i.e. the communication object adopts a new value after each operation.

Example:

If the object currently has the value "1", the object adopts the value "0" after an operation and sends it. If the object has the value "0", the object value changes to "1" after an operation. The value "1" is of course also sent out after a change.

Value

A value telegram can also be triggered with a push button operation. To do so, the function must be set to "Value". In this case, the push button pair indicates a 1-byte communication object "Value" via which the value can be sent.

The parameters "Value push button left" and "Value push button right" define which values should be sent when the right or left push button is pressed. Various values between "0" and "255" can be set for the right and left push button.

Lightscene external input

The function "Lightscene external input" enables one of 32 lightscenes to be sent on each push button of the pair. The lightscenes are sent to linked lightscene modules via a 1-byte communication object "Lightscene number". This can either be the internal lightscenes which are stored in the panel or an external lightscene module.

The settings "Lightscene number left" and "Lightscene number right" define which lightscene number is sent.

By default, it is not possible to store lightscenes via the IR hand-held transmitter. This can be enabled via the parameter "Save lightscenes". In this case, the panel sends the lightscene number plus the save information if a push button is pressed for longer than 3 s. This means that an additional bit is set in the lightscene telegram so that the linked lightscene modules know that they must now query the current status values of the actuators.

Lightscene number

If the "Lightscene number" function is used, only one push button e.g. M1 or M2 (no push button pair) is available for sending a lightscene. The function enables the retrieval of one of 32 lightscenes. The lightscenes are sent to linked lightscene modules via a 1-byte communication object "Lightscene number". These can either be the internal lightscenes which are stored in the panel or an external lightscene module.

The setting "Lightscene number" defines which lightscene number is sent.

By default, it is not possible to store lightscenes via the IR hand-held transmitter. This can be enabled via the parameter "Save lightscenes". In this case, the panel sends the lightscene number plus the save information if a push button is pressed for longer than 3 s. This means that an additional bit is set in the lightscene telegram so that the linked lightscene modules know that they must now query the current status values of the actuators.

Remote control via Bang & Olufsen hand-held transmitter Beo4

The IR hand-held transmitter offers the following options for controlling the panel.



- Button description Beo4:**
- Light: Changing of illumination
 - Record: Saving of lightscene
 - 0 – 9: Light 1 up to 10
 - A: Lightscene 1
 - C: Lightscene 2
 - D: Lightscene 3
 - F: Lightscene 4
 - B: On or dimming brighter
 - E: Off or dimming darker
 - Stop: All Off

Switching and dimming:

Press the “LIGHT” button on the remote control. The text “LIGHT” appears in the display of the remote control. This mode is active for 25 seconds. If the display switches to audio/video playback again, the “LIGHT” button must be pressed again.

Once the LIGHT mode is active, the push buttons for triggering the required function follow. See the table.

The format LIGHT + 1 + B means that the three push buttons must be pressed in sequence (not simultaneously).

Function	Push buttons
Light 1 on	LIGHT + 1 + B
Light 1 dimming brighter	LIGHT + 1 + B, B long push
Light 1 off	LIGHT + 1 + E
Light 1 dimming darker	LIGHT + 1 + E, E long push
Light 2 up to 9 analogue to Light 1	–
Light 10 on	LIGHT + 0 + B
Light 10 dimming brighter	LIGHT + 0 + B, B long push
Light 10 off	LIGHT + 0 + E
Light 10 dimming darker	LIGHT + 0 + E, E long push

Retrieving and saving lightscenes

Press the “LIGHT” button on the remote control. The text “LIGHT” appears in the display of the remote control. This mode is active for 25 seconds. If the display switches to audio/video playback again, the “LIGHT” button must be pressed again.

Once the LIGHT mode is active, the push buttons for triggering the required function follow. See the table.

The format LIGHT + A means that the two push buttons must be pressed in sequence (not simultaneously).

Function	Push buttons
Call Lightscene 1	LIGHT + A
Call Lightscene 2	LIGHT + C
Call Lightscene 3	LIGHT + D
Call Lightscene 4	LIGHT + F
Save Lightscene 1	LIGHT + LIST* + GO + A
Save Lightscene 2	LIGHT + LIST* + GO + C
Save Lightscene 3	LIGHT + LIST* + GO + D
Save Lightscene 4	LIGHT + LIST* + GO + F

*Press the list button until STORE appears in the display.

ALL OFF

All the loads are switched off with one push button action when the “STOP” button is pressed.

Functional description: IR control
 General settings.

– IR range	white
	blue
	white & blue
	Bang & Olufson (only 6x36/100CB)

Functional description: IR control for
 Busch-Ferncontrol® IR hand-held
 transmitter

blue=blue infrared range

white=white infrared range

Function	Application
Push button pair 1 (blue/white)	Inactive Switch Dimmer Shutter Push button Value Lightscene external input
Push button pair 2 (blue/white)	Inactive Switch Dimmer Shutter Push button Value Lightscene external input
...	
Push button pair 5 (blue/white)	Inactive Switch Dimmer Shutter Push button Value Lightscene external input
Memo push button M1 (blue/white)	Inactive Lightscene number
Memo push button M2 (blue/white)	Inactive Lightscene number
Memo push button Rot (blue/white)	Inactive Lightscene number

Functional description: IR remote control for Bang&Olufson remote control Beo4

Function	Application
Push button 1 up/down	Inactive Switch Dimmer Shutter Push button Value Lightscene external input
Push button 2 up/down	Inactive Switch Dimmer Shutter Push button Value Lightscene external input
...	
Push button 9 up/down	Inactive Switch Dimmer Shutter Push button Value Lightscene external input

Functional description: IR control for Bang&Olufson remote control

Push button 0 up/down	Inactive Switch Dimmer Shutter Push button Value Lightscene external input
Push button A green	Inactive Lightscene number
Push button B orange	Inactive Lightscene number
Push button C red	Inactive Lightscene number
Push button D blue	Inactive Lightscene number
Push button stop	Inactive Lightscene number

Communication objects for "Switch"

No.	Type	Object name	Function
0	1 bit	Switch	Send/Receive

Communication objects for "Dimmer"

No.	Type	Object name	Function
0	1 bit	Switch	Send/Receive
1	1 bit	Dim	Send

Communication objects for "Shutter"

No.	Type	Object name	Function
0	1 bit	Move	Send
1	1 bit	Step	Send

Communication objects for "Push button"

No.	Type	Object name	Function
0	1 bit	Switch left	Send
1	1 bit	Switch right	Send

Communication objects for "Value"

No.	Type	Object name	Function
0	1 byte	Value	Send

Communication objects for "Lightscene external input" and "Lightscene number"

No.	Type	Object name	Function
0	1 byte	Lightscene number	Send

ABB i-bus® KNX
ABB Powernet KNX

SMARTtouch (colour)
Type: 6x36/100x..., 6x36/100CB...

Parameters: IR control “Switch”

The default setting for the values is **printed in bold type**.

– Behaviour	Left=on, right=off Left=off, right=on Left=toggle, right=toggle
-------------	--

Parameters: IR control “Dimmer”

The default setting for the values is **printed in bold type**.

– Behaviour	Left brighter on, right darker off Left darker off, right brighter on Left brighter toggle, right darker toggle Left darker toggle, right brighter toggle
-------------	---

Parameters: IR control “Shutter”

The default setting for the values is **printed in bold type**.

– Behaviour	Left=up/right=down Left=down/right=up
-------------	---

Parameters: IR control “Push button”

The default setting for the values is **printed in bold type**.

– Push button left	Send off at rising flank Send off at falling flank Send off at both flanks Send on at falling flank Send off at rising flank, on at falling flank Send on at rising flank Send on at rising flank, off at falling flank Send on at both flanks Toggle at rising flank Toggle at falling flank
– Push button right	Send off at rising flank Send off at falling flank Send off at both flanks Send on at falling flank Send off at rising flank, on at falling flank Send on at rising flank Send on at rising flank, off at falling flank Send on at both flanks Toggle at rising flank Toggle at falling flank

Parameters: IR control “Value”

The default setting for the values is **printed in bold type**.

– Value push button left	0...255
– Value push button right	0...255

Parameters: IR control “Lightscene external input”

The default setting for the values is **printed in bold type**.

– Lightscene number left (1...32)	1
– Lightscene number right (1...32)	2
– Save lightscenes	not possible possible

Parameters: IR control “Lightscene number”

The default setting for the values is **printed in bold type**.

– Lightscene number memo push button (1...32)	11
– Save lightscenes	not possible possible

Functional description: Room thermostat

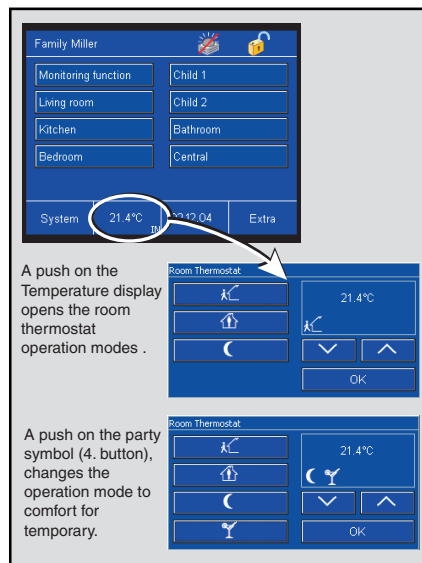

The SMARTtouch panel has an integrated room thermostat. This has a comparable functionality to the usual KNX room thermostats.

Operating modes

The room thermostat function has four operating modes:

- Frost protection mode:
The room temperature control is out of service; the room is only heated if the room temperature has fallen so low that there is a risk of the heating installation freezing.
- Comfort mode:
The setpoint for the room temperature is set to a value which enables "normal use" of the room at a pleasant temperature.
- Standby mode:
The room temperature is lowered (e.g. during temporary absence) so that heating costs are saved but the comfort temperature can be reached again quickly.
- Night mode:
If the room is not used for an extensive period during the night; the

room temperature is lowered to a pleasant night temperature and can be increased again relatively quickly in the morning.

It is possible to toggle between these operating modes through switching telegrams to the communication objects "Frost protection", "Night" and "Comfort" or via the panel display (see also the diagram of the operating modes). The frost/heat protection has the highest priority i.e. it is not possible to switch to another operating mode in this case. To do so, the frost/heat protection mode must first be deactivated e.g. by closing an open window. Comfort mode has the next highest priority followed by night mode. If none of the three operating modes is active, the room thermostat is in standby mode.

Alternatively, the 1-byte communication object "Toggling of operating mode" can be used. This is always necessary when room thermostats are used in accordance with the KNX standard.

Party time (Comfort extension)

If the panel is switched to night mode via the bus (or internally), the party time can be activated via the panel display (change to comfort mode, see diagram top left). Once the party time has elapsed, the thermostat switches back to night mode.

During the party time, the symbols for night and party are shown together in the display. By pressing the party button again, the party time can be reset manually to night reduction.

This function can also be used for the temporary deactivation of the heat and frost protection. As in night mode, it is possible to switch to comfort mode for the parameterised period. The

Priorities of the operating modes

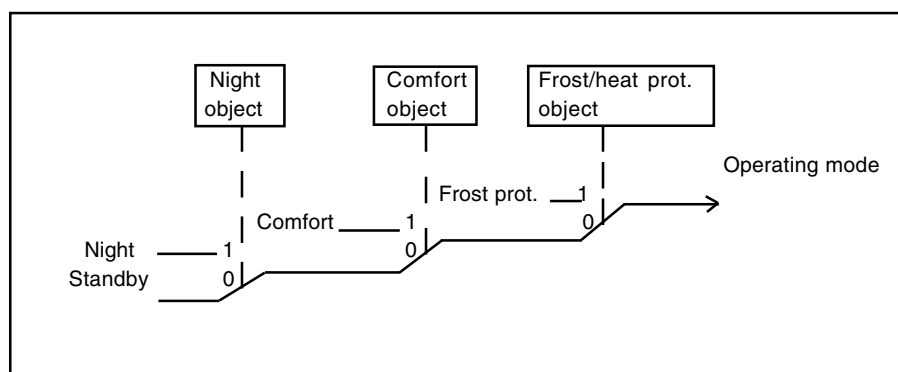

function is switched on and off in the same way. The symbols for frost protection and party are shown together in the display during this comfort extension.

If the party time is inactive, the first button with comfort/standby toggling also directly operates the comfort object. It is therefore possible to set the operating mode directly to comfort mode while in night mode. When the frost or heat protection mode is active, toggling via the first button is stored in the comfort object.

The recording of the actual temperature is normally carried out by a built-in temperature sensor. It is also possible to switch to an external measurement with the parameter "Actual value survey". Temperature values which are received via the object "Actual temperature" can thus be used for control purposes. If no new values are received for 30 min, the thermostat suspends its function and no more control value telegrams are sent.

Setpoint values

The following setpoint values can be set for heating mode: "Base setpoint in °C (16..31) (Comfort temperature heating)", "Lowering standby operation heating ... (1..15)", "Lowering night operation heating in K (1..15)" and "Setpoint frost protection in °C (4..10)".

For cooling mode, the comfort temperature can be set via the "Dead zone between heating and cooling in K (1..8)". The setpoint adjustments for standby and night mode refer to this value: "Increasing standby operation cooling" and "Increasing night operation cooling".

If e.g. a room should be cooled at 25°C in comfort mode with a base setpoint of 22°C, a dead zone of 3°C must be set. If it should now be cooled at 27°C in standby mode, the value must be increased by 2°K. Cooling in night mode from 29°C requires an increase in this value of 4°K.

To protect against uncontrolled overheating of rooms, it is possible to assign a setpoint for heat protection after which cooling takes place. If heat protection is not required, cooling can be switched off.

The base setpoint can be modified as often as necessary via the bus. To do

Setpoints in the different operating modes

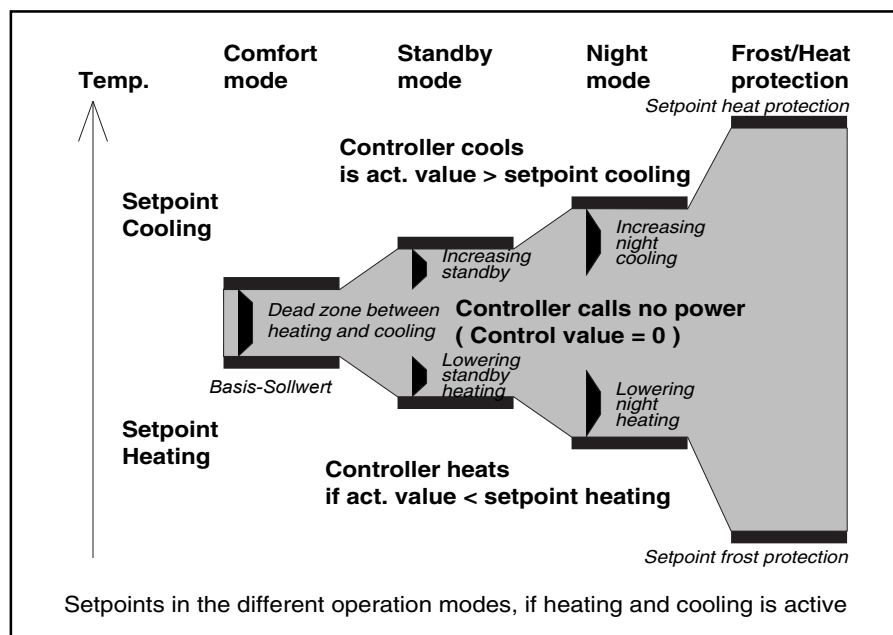

so, a 2-byte temperature value must be sent to the object "Base setpoint".

The setpoint temperature can be changed manually via the rocker buttons on the panel display. The parameters "Area for manual setpoint setting", "Maximum increasing of setpoint at heating" and "Maximum lowering of control value at cooling" determine the scope for modifying the setpoint. If a new telegram is sent to the communication object "Base setpoint" after a manual setpoint adjustment, the manual setpoint adjustment can also be reversed.

The display can then show the absolute setpoint value in °C or the adjustment in K. (Parameter "Display temperature adjustment as difference")

Heating/cooling

To be able to address the various controller types for heating or cooling mode, the room thermostat can be parameterised as a continuous or switching controller. In the case of a switching controller, it is possible to choose between a PWM controller ("PI controller") and a "Two-position controller".

In the case of a continuous control response and a switching PWM controller, the preset control parameters regarding the installation type of the heating or air conditioning system can be used. If other control parameters are needed, they can be set individually via the free parameterisation option. This option should only be

used if the user has sufficient experience in control technology.

The continuous controller sends its control value to a 1-byte object. Electromotive or electrothermal drives which are connected to heating actuators with PWM control can thus be controlled.

To prevent unnecessary bus loads, it is possible to set by how much the control value must change in order to be sent on the bus. The setting is carried out as a percentage. The sending of the control value is preset by a cyclic period, provided it has not been modified. This cycle time should not be set too low (e.g. every 10 min).

In the case of a switching PWM controller, the output value of the controller (0...255) is converted into an ON/OFF ratio. If e.g. a control value of 70% should be issued, the ON time is 7 min and the OFF time is 3 min at a preset cycle time of 10 min. The dynamic range can also be limited in the same way as a continuous controller. The parameters "PWM cycle is 0% up to control value" and "PWM cycle is 100% up to control value" are used for this purpose. If e.g. a maximum control value of 80% is set, the controller automatically sends the value 255 when a control value of 204 is exceeded. (See also the diagram below)

To optimise the control characteristics of the heating or cooling system, the "Cycle time of the control value" can be set. To set the correct cycle time, the type of heating or cooling as well

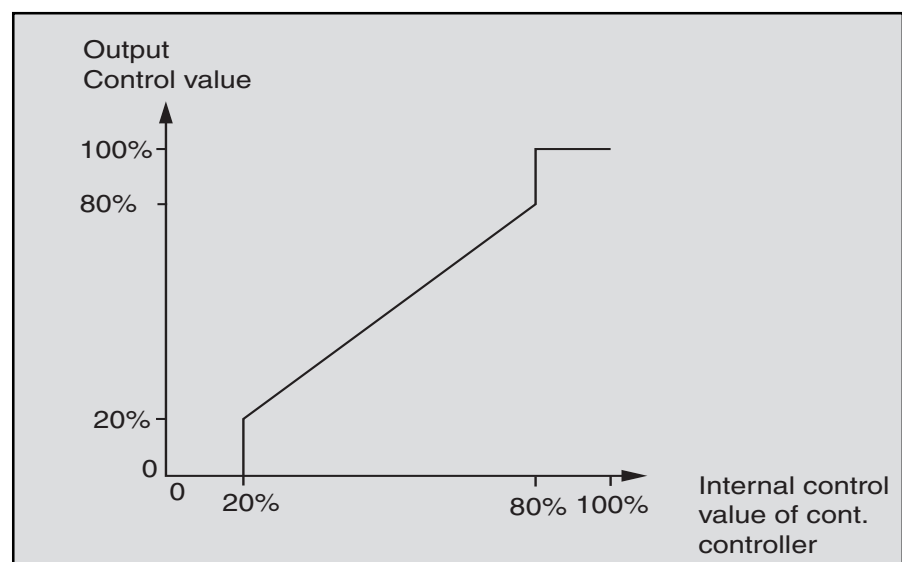

as the valve drive used should be taken into account. The following recommendations can be used:

a) Electrothermal valve drive:

To fully open an electrothermal valve drive takes approx. 2-3 minutes. A shorter cycle time than 15 minutes is therefore not advisable.

b) Floor heating:

The time constant of a floor heating system is very high. A cycle time of 20 minutes is therefore sufficient.

c) Warm water heating:

Electrothermal drives are frequently used here. A cycle time of 15 minutes produces very good results.

d) Electric fan heating:

Cycle times between 10 and 15 minutes are recommended, depending on the electric heating and spatial conditions.

If a two-position controller is used for heating or cooling control, it is possible to select the hysteresis by which the setpoint fluctuates. If e.g. the setpoint in heating mode is 20°C and the hysteresis is 0.5 K, the controller switches on at 19.75°C and switches off again at 20.25°C. The hysteresis that is set then depends on how quickly the heating can heat up the room or how quickly the cooling cools down the room as well as how sensitive the customer is to temperatures. The hysteresis should not be set too low as otherwise the valve drive continually opens and closes. The hysteresis should however not be set too high as the temperature fluctuations in the room are then relatively high.

To increase the accuracy of the control, the parameter "Lowering of hysteresis" is used. If this parameter is active the hysteresis is reduced e.g. every minute by 0.1 K, if required until 0 K. The temperature fluctuations are effectively reduced during the control by the lowered hysteresis. If a reduction should be used, it is advisable to select a reduction that is less than one fifth of the hysteresis.

e.g. Hysteresis 0.5 K =>
Reduction < 0.1 K/min

In certain cases (floor heating), it may be necessary to install a fast-acting additional system to enable you to heat the room up quickly. If the "Additional heating" is active, the panel has a second heating system available with a switching control

(1 bit) or a quasi continuous control which regulates the heating with the 1-byte values 0% and 100%.

With the parameters "Level distance from the base level to the additional level in K" and "Hysteresis (one-sided)", it is determined when the additional level is switched on and when it is switched off. If e.g. the setpoint for the second heating level is set at 18°C with a hysteresis at 0.5 K (one-sided), the thermostat switches on at 18°C and switches off at 18.5°C.

As some valve drives close at a 1-byte value of 255 or a 1-bit value of 1 and open at the corresponding inverted values, the "Effective mode" can be inverted.

The toggling between heating and cooling is carried out automatically by the room thermostat. If this is not required, the "Toggle between heating and cooling" can be carried out by an external, central control via the 1-bit object "Toggle heating cooling". In this setting, the heating or cooling symbols are permanently visible during the corresponding operating mode. If an ON telegram is received at the operating mode object, the heating mode is switched on. If an OFF telegram is received, the cooling mode is switched on.

Automatic shading

To prevent the room warming up due to sunlight, automatic shading can be carried out by lowering one or several blinds. The object "Shading" is used for this purpose.

The parameter "Shading setpoint" determines at which temperature the blinds should be lowered.

If the temperature falls below the set shading temperature, no commands for lowering the blinds are sent. The blinds could be raised at a specific time e.g. with a central command.

Group master mode

In rooms such as large open-plan offices, it can be difficult to achieve effective control throughout the room with only one panel operating as a room thermostat. In such cases, it is advisable to divide the room into se-

veral zones in which one room thermostat is used per zone. So that these room thermostats always use the same setpoint, there is the possibility of activating the parameter "Group master operation mode" for one device. In this case, this device has the 2-byte communication object "Base setpoint for slaves" which is linked with the 2-byte communication objects "Base setpoint - Telegr. temperature" of the other devices. The manual setpoint adjustment should then be disabled for these objects. The operating modes heating/cooling or frost/night/comfort must be set exactly the same on the master and slave devices by configuring or assigning the same group addresses to the operating mode objects.

Offset

If the measured temperature is corrupted by the self-heating of the panel, an offset value can be set for the room temperature measurement (setting "Offset value in K x 0.1 K").

The installation site of the panel and the appropriate selection of parameter settings is decisive in the accurate recording of temperatures.

ABB i-bus® KNX
 ABB Powernet KNX

SMARTtouch (colour)
 Type: 6x36/100x..., 6x36/100CB...

Functional description: Room thermostat

Function	Application
RT	Inactive Heating/Heating and cooling

Communication objects

No.	Type	Object name	Function
0	1 bit	Frost protection	Receive
1	1 bit	Night	Send/Receive
2	1 bit	Comfort	Send/Receive
3	2 byte	Base setpoint	Receive
4	2 byte	Actual temperature	Send
5	2 byte	Act. setpoint	Send
6	1 bit	Shading	Send
7	1 bit	Heating switched	Send
8	1 bit	Additional heating switched	Send
9	1 bit	Cooling switched	Send
10	1 bit	Toggle heating cooling	Send/Receive
11	1 byte	Toggling of operating mode	Receive

No.	Type	Object name	Function
...			
5	2 byte	Base setpoint for slaves	Send
...			
7	1 byte	Heating continuously	Send
8	1 byte	Additional heating continuously	Send
9	1 byte	Cooling continuously	Send
...			

Parameters: Room thermostat
The default setting for the values is **printed in bold type**.

General:	
– Control heating	Active
– Control additional heating	Inactive Active
– Control cooling	Inactive Active
– Operation mode after reset	Comfort Standby Night Frost protection
– Cyclic sending of actual value and setpoint in mm.ss (03:00...60:00)	14:50
– Change of actual temp. for automatic sending	Inactive / 0.2 K / 0.4 K / 0.6 K / 0.8 K / 1.0 K / 1.5 K / 2.0 K
– Automatic shading (see also setpoints)	Inactive Active
– Party time (extension of comfort mode)	Inactive / 30 min / 1 h / 1.5 h / 2 h / 2.5 h / 3 h / 4 h
– Display heating/cooling is active	If operation mode is active At heating resp. cooling
– Group master operation mode	Inactive Active
– Disable frost/heat protection manually (extension of comfort mode)	Locked Free
– Actual value survey	Internal External
– Toggle between heating and cooling	automatic via object
– Offset value in K x 0.1 K	-127... 0 ...+127
Setpoints general:	
– Area for manual setpoint setting	Disabled / +- 1K / +- 3K / +- 5K
– Maximum increasing of setpoint at heating in K (0...5)	3
Only for cooling:	
– Maximum lowering of setpoint at cooling in K (0...5)	3
– Send actual setpoint at change	Inactive Active
– Manual setpoint setting	Reset at receiving of base setpoint Hold at receiving of base setpoint
Only for shading:	
– Shading setpoint	Comfort temperature + 2K Comfort temperature + 4K Comfort temperature + 6K Comfort temperature + 8K
– Temperature display at setpoint adjustment	Act. setpoint Base setpoint
– Temperature adjustment display as difference	No Yes

Parameters: Room thermostat
The default setting for the values is **printed in bold type**.

Setpoints heating:	
– Base setpoint in °C (16...31) Comfort temperature heating	21
– Lowering standby operation heating in K (1...15)	2
– Lowering night operation heating in K (1...15)	4
– Setpoint frost protection in °C (4...10)	7
– Level distance from the base level to the additional level in K	1...3...5
Controlling/Control value heating:	
– Output of control value	continuously switched
– Control type	Two-position controller PI controller
Only for two-position controller:	
– Hysteresis	0.3K / 0.5K / 0.7K / 1K / 1.5K / 2K
– Lowering of hysteresis	Inactive 0.2 K/min 0.1 K/min 0.06 K/min 0.04 K/min 0.03 K/min 0.02 K/min
– Cycle time of the control value in mm:ss (03:00...60:00)	14:50
Only for continuous controller:	
– Change for automatic sending of control value	Inactive / 2% / 5% / 10%
Only for PI controller:	
– Control parameters	via installation type free setting of parameters
Only for installation type:	
– Type of heating system	Warm water heating (1.5K/100min) Electric heating (1.5K/50min) Floor heating (4K/200min)
Only for free parameterisation:	
– Proportional area	1.0K / 1.5K / 2.0K / 2.5K / 3K / 4K / 6K / 8K / 10K
– Reset time in min.	I part inactive / 10 min / 20 min / 30 min / ... / 100 min / ... / 240 min
Only for switched controller:	
– PWM cycle	3min / 5min / 10min / 15min / 20min / 30min / 40min / 50min / 60min
– PWM cycle is 0% up to control value	0% / 10% / 20% / 30%
– PWM cycle is 100% up to control value	70% / 80% / 90% / 100%
– Effective mode	Normal Inverted
Only for additional heating:	
– Hysteresis (one-sided)	0.3K / 0.5K / 0.7K / 1.0K / 1.5K / 2.0K
– Cycle time for automatic sending of the control value e in mm:ss (03:00...60:00)	14:50
– Control value type	switched quasi contin. (1 Byte: 0% or 100%)
– Effective mode	Normal Inverted

Parameters: Room thermostat
The default setting for the values is **printed in bold type**.

Only for cooling:	
Setpoints cooling:	
– Dead zone between heating and cooling in K (1...8)	1... 4 ...8
– Increasing standby operation cooling	1... 2 ...8
– Increasing night operation cooling	1... 4 ...8
– Setpoint heat protection	Cooling switched off 30°C 35°C 40°C 44°C
Controlling/Control value cooling:	
– Output of control value	continuously switched
– Control type	Two-position controller PI controller
Only for two-position controller:	
– Hysteresis	0.3K / 0.5K / 0.7K / 1.0K / 1.5K / 2.0K
– Lowering of hysteresis	Inactive 0.2 K/min 0.1 K/min 0.06 K/min 0.04 K/min 0.03 K/min 0.02 K/min
– Cycle time of the control value in mm:ss (03:00...60:00)	04:46
– Effective mode	Normal Inverted
Only for PI controller:	
– Control parameters	via installation type free setting of parameters
– Type of cooling system	Cooling ceiling (5K/240min) SplitUnit/Fan cooling (4K/90min)
– PWM cycle	3min / 5min / 10min / 15min / 20min / 30min / 40min / 50min / 60min
– PWM cycle is 0% up to control value	0% / 10% / 20% / 30%
– PWM cycle is 100% up to control value	70% / 80% / 90% / 100%
– Effective mode	Normal Inverted
Only for free parameterisation:	
– Proportional area	1.0K / 1.5K / 2.0K / 2.5K / 3K / 4K / 6K / 8K / 10K
– Restet time in min.	I part inactive / 10 min / 20 min / ... 100 min / ... / 200 min / 240 min
Only for continuous controller:	
– Cycle time of the control value in mm:ss (03:00...60:00)	04:46
– Effective mode	Normal Inverted
– Change for automatic sending of control value	Inactive / 2% / 5% / 10%

Functional description: Lightscenes
General settings

General

The SMARTtouch panel can be used to send and save lightscenes. Up to 40KNX actuators can be addressed via the memo communication objects. The number of memo objects available to the panel is dependent on the type used and on the setting "Number of objects per lightscene". This can be a maximum of 40 objects.

The 1-byte communication object "Lightscene number" is used for retrieving lightscenes. The panel receives one of 32 lightscene numbers at this object. These lightscene numbers can be retrieved internally in the panel e.g. via a touch surface with the appropriate settings or externally via an KNX switch sensor.

Note:

You have to link the touch surface objects to the object „lightscene number“ via a common internal group address, if you want to call up lightscenes over the touch surfaces of the LEAN-/SMARTtouch panel. The lightscene number which should call up, is set in the parameters of the respective touch surface (see also „Functional description: Touch surfaces (Control page) – Lightscenes external input (1 byte)").

If the panel receives a lightscene telegram at its memo objects, it will send switching, value or lightscene telegrams in sequence to linked actuators. The "Telegram rate between two lightscene telegrams" can be set. In the Powernet version, this should not be set too low as otherwise the bus load is excessively increased. The preset value of "1 s" should be sufficient and should be changed if necessary. In the Twisted Pair variant, the telegram rate is not critical and can be lowered if necessary.

Lightscene

The size of the memo communication objects can be adapted to switch, dimming or shutter actuators. This means that if a switch or shutter actuator should be addressed via a memo object, the object is 1 bit. If a dimming actuator should be addressed, the object is 1 byte. The bit size is defined individually for each memo object via the parameter "Actuator type".

The SMARTtouch panel software displays various options depending on the selection. Alternatively, an actuator can also be "Inactive" within a scene. The standard scene headlines 1...32 can be replaced with any text (e.g. "Rise" or "Dining"). This text is also adopted in the tree of the parameter software, to maintain a better overview when configuring parameters.

With the selection "Switch or shutter actuator", it is possible to set "Off/Up" or "On/Down".

If "Dim actuator" is set as the actuator type, percentage values between 0% and 100% can be defined in 10% steps. A shutter actuator with 1-byte positioning can also be controlled via the 1-byte object.

The size of a memo object can also be set to 2 bytes via the setting "Actuator type". In this case, the object is used to send temperature values between -20 and 100°C. Connected room thermostats can receive a new base setpoint via this object.

If the parameter "Actuator type" is set to "Lightscene number", the corresponding memo object has a size of 1 byte and sends one of 32 lightscene numbers. There is therefore the possibility of cascading lightscenes if the 20 memo objects are not sufficient for special applications.

Note:

A macro function can also be retrieved via the lightscene number.

Saving lightscenes

If the end customer would like to carry out changes to the predefined lightscenes, he can do this without any great effort. He must first set all the lamps and/or shutters to the required position i.e. he dims or moves the individual components via separate KNX switch sensors or via the touch surfaces of the panel. He then triggers a lightscene storage telegram with a long operation (> 3 s) of a lightscene touch surface or an additional lightscene switch sensor. This telegram is received at the object "Lightscene number". The individual memo objects now send read requests to the linked KNX actuators. If the read flag is set for these objects, the actuators send

back their current values in response telegrams. These values are stored in the panel and are not lost in the event of a bus voltage failure.

If changes are carried out on the SMARTtouch panel and then programmed in the panel, lightscenes that have been stored by end customers are likewise not lost by default. This behaviour can also be modified via the parameter "Overwrite lightscene settings at download". All the lightscenes can thus be reset to the preset options which were carried out with the panel software.

Functional description: Lightscenes

General settings

General:

- Number of objects per lightscene (1...40)	8
- Telegram rate between two lightscene telegrams	130ms / 260ms / 520ms / 1s / 2s / 4s / 10s / 35s
- Overwrite lightscene settings at download	No / Yes

Functional description: Lightscenes

Application

Function	Application
Lightscene actuator	Lightscene

Communication objects for 1-bit actuator types

No.	Type	Object name	Function
0	1 byte	Lightscene number	Receive
1	1 bit	Memo object 1	Send/Receive
2	1 bit	Memo object 2	Send/Receive
3	1 bit	Memo object 3	Send/Receive
4	1 bit	Memo object 4	Send/Receive
5	1 bit	Memo object 5	Send/Receive
...			
37	1 bit	Memo object 37	Send/Receive
38	1 bit	Memo object 38	Send/Receive
39	1 bit	Memo object 39	Send/Receive
40	1 bit	Memo object 40	Send/Receive

Communication objects for 1-byte actuator types (Dim actuators, 1-Byte Values, Lightscens)

No.	Type	Object name	Function
0	1 byte	Lightscene number	Receive
1	1 byte	Memo object 1	Send/Receive
2	1 byte	Memo object 2	Send/Receive
3	1 byte	Memo object 3	Send/Receive
4	1 byte	Memo object 4	Send/Receive
5	1 byte	Memo object 5	Send/Receive
...			
37	1 byte	Memo object 37	Send/Receive
38	1 byte	Memo object 38	Send/Receive
39	1 byte	Memo object 39	Send/Receive
40	1 byte	Memo object 40	Send/Receive

Communication objects for 2-byte actuator types

No.	Type	Object name	Function
0	1 byte	Lightscene number	Receive
1	2 byte	Memo object 1	Send/Receive
2	2 byte	Memo object 2	Send/Receive
3	2 byte	Memo object 3	Send/Receive
4	2 byte	Memo object 4	Send/Receive
5	2 byte	Memo object 5	Send/Receive
...			
37	2 byte	Memo object 37	Send/Receive
38	2 byte	Memo object 38	Send/Receive
39	2 byte	Memo object 39	Send/Receive
40	2 byte	Memo object 40	Send/Receive

Parameters: Lightscenes

The default setting for the values is **printed in bold type**.

Note:

The standard scene headlines 1...32 can be replaced with any text (e.g. "Rise" or "Dining"). This text is also adopted in the tree of the parameter software, to maintain a better overview when configuring parameters.

Separate for each scene:	
– Name	<Scene 1...32>
Separate for each actuator type (1...40):	
– Actuator type	Switch or shutter actuator Dim actuator Value (0...255) Value (2 byte) -20 to 100°C Lightscene number
Only for switch or shutter actuator:	
Separate for each scene (1...32):	
– Scene ...	Off / Up On / Down Inactive
Only for dim actuator:	
Separate for each scene (1...32):	
– Scene	0% / 10% / 20% / 30% / 40% / 50% / 60% / 70% / 80% / 90% / 100%
Only for value (0...255):	
– Scene ...	0
Only for value (2 byte) -20 to 100°C:	
– Scene ...	0
Only for lightscene number:	
– Scene ...	1 / 2 / ... / 31 / 32

Functional description: Alarm function

The panel offers the possibility of displaying up to 50 different alarm messages. The parameter "Number of alarm messages" defines the required number.

Each alarm message has its own communication object "Alarm 1" to "Alarm 50". The communication objects can either be 1 bit or 14 byte. The setting "Type of the alarm object" sets the size of the object. Each alarm object can thus be set individually.

The alarm function can be used in combination with the inputs of the monitoring function (see page 18) or on its own. In combination with the monitoring function, the inputs and the alarm objects must be linked via internal group addresses.

If a telegram e.g. an ON telegram is received at an alarm object, a window is opened in the screen of the panel, in which the alarm text is displayed. The alarm text can be freely entered in the panel software. The panel simultaneously triggers a signal tone. The duration of the signal tone can be set and it can also be deactivated.

All alarm messages which occur or have occurred can be displayed via a further window in the panel. The window is opened by pressing the "Extras" button followed by "Alarm messages/Fault messages". All alarm and fault messages are displayed with the date, time and acknowledgement.

The acknowledgement of an alarm message is carried out via the "OK" button in the alarm text window. If the setting "Send zero at acknowledge" has been activated with "yes" for a 1-bit alarm object, the group address that is linked with the alarm object is sent on the bus with the value "0".

In the case of a 14-byte alarm object, an individual acknowledgement text (max. 13 characters) can be sent with the acknowledgement.

Via the acknowledgement object "Acknowledge global", a group address is sent as soon as an acknowledgement has been carried out at one of the alarm objects.

Functional description: Alarm function

Function	Application
Alarm messages	Inactive Settings

Communication objects for 1-bit alarm messages

No.	Type	Object name	Function
0	1 bit	Acknowledge global	Send
1	1 bit	Alarm 1	Send/Receive
2	1 bit	Alarm 2	Send/Receive
3	1 bit	Alarm 3	Send/Receive
4	1 bit	Alarm 4	Send/Receive
5	1 bit	Alarm 5	Send/Receive
...			
47	1 bit	Alarm 47	Send/Receive
48	1 bit	Alarm 48	Send/Receive
49	1 bit	Alarm 49	Send/Receive
50	1 bit	Alarm 50	Send/Receive

Communication objects for 14-byte alarm messages

No.	Type	Object name	Function
...			
1	14 byte	Alarm 1	Send/Receive
2	14 byte	Alarm 2	Send/Receive
3	14 byte	Alarm 3	Send/Receive
4	14 byte	Alarm 4	Send/Receive
5	14 byte	Alarm 5	Send/Receive
...			
47	14 byte	Alarm 47	Send/Receive
48	14 byte	Alarm 48	Send/Receive
49	14 byte	Alarm 49	Send/Receive
50	14 byte	Alarm 50	Send/Receive

Parameters: Alarm function
The default setting for the values is **printed in bold type**.

General:	
– Number of alarm messages (1...50)	5
Separate for each alarm message:	
Alarm message...:	
– Type of the alarm object ...:	1 Bit / 14 Byte
Only for 1 bit:	
– Text for alarm message	<Text>
– Text at acknowledge	<Text>
– Send zero at acknowledge	No / Yes
Only for 14 byte:	
– Send text at acknowledge	No / Yes
Only if "Yes" is selected:	
– Text at acknowledge	<Text>
– Time of the audio signal	No signal 30 s 1 min 2 in 5 min 10 min 30 min 1 h

Functional description: Presence simulation

The panel has an integrated presence simulation function. This means that the panel can send out telegrams fully independently and conveys the impression that the house is occupied.

If the simulated presence is active the control panel software shows 20 1-bit or 1-byte communication objects "Simulation 1" to "Simulation 20". Switch and/or blind actuators can be triggered via the 1-bit communication objects and value objects can be triggered by different actuators via the 1-byte communication objects. In addition, it also shows a 1-bit communication object "Enable" for activating or deactivating the simulated presence.

The presence simulation is activated with an ON telegram at the "Activation" object. An OFF telegram deactivates it again.

If the presence simulation is not active (OFF telegram has been received at the activation object), it portrays "normal" telegram traffic. The panel learns the habits of the occupants of the house. The panel has a memory which records telegrams for seven days. On the eighth day, the memory location of the first of the seven days is overwritten.

If the panel only had three days to carry out a recording, only these three days are repeated when the function is activated.

Only one telegram per object can be received and stored within the period of one minute. If more than 20 telegrams are recorded within a 24-hour period, the oldest telegram is removed from the memory.

The panel ignores cyclical transmitters during the recording. This means it only records an actual change.

Once an ON telegram has been received at the "Activation" object, the panel first waits until the "Waiting time up to the activation" has elapsed. Only then does the simulation start. The delay can be set between 30 s and 2 min.

The activated presence simulation sends the information that has been recorded over several days on a 1:1 basis.

It is a good idea to integrate functions in the presence simulation which are not linked with a holiday function of a time channel. This could be e.g. the lounge light, the kitchen light and above all the hallway light.

To permit the function to continue to be carried out without any difficulty after a mains/bus voltage failure, all recorded telegrams are immediately stored in the unit's flash memory. Also the status of communication object "Enable" is stored in the flash memory. This enables the unit to know whether the function is active and which telegrams are to be signaled after the mains/bus voltage failure.

Functional description: Presence simulation

Function	Application
Simulation	Inactive Active

Communication objects with 1-Bit-Simulation-Communication objects

No.	Type	Object name	Function
0	1 bit	Activation	Receive
1	1 bit	Simulation 1	Send/Receive
2	1 bit	Simulation 2	Send/Receive
3	1 bit	Simulation 3	Send/Receive
4	1 bit	Simulation 4	Send/Receive
5	1 bit	Simulation 5	Send/Receive
6	1 bit	Simulation 6	Send/Receive
7	1 bit	Simulation 7	Send/Receive
8	1 bit	Simulation 8	Send/Receive
9	1 bit	Simulation 9	Send/Receive
10	1 bit	Simulation 10	Send/Receive
11	1 bit	Simulation 11	Send/Receive
12	1 bit	Simulation 12	Send/Receive
13	1 bit	Simulation 13	Send/Receive
14	1 bit	Simulation 14	Send/Receive
15	1 bit	Simulation 15	Send/Receive
16	1 bit	Simulation 16	Send/Receive
17	1 bit	Simulation 17	Send/Receive
18	1 bit	Simulation 18	Send/Receive
19	1 bit	Simulation 19	Send/Receive
20	1 bit	Simulation 20	Send/Receive

Communication objects with 1-Byte-Simulation-Communication objects

No.	Type	Object name	Function
0	1 byte	Activation	Receive
1	1 byte	Simulation 1	Send/Receive
2	1 byte	Simulation 2	Send/Receive
3	1 byte	Simulation 3	Send/Receive
4	1 byte	Simulation 4	Send/Receive
5	1 byte	Simulation 5	Send/Receive
6	1 byte	Simulation 6	Send/Receive
7	1 byte	Simulation 7	Send/Receive
8	1 byte	Simulation 8	Send/Receive
9	1 byte	Simulation 9	Send/Receive
10	1 byte	Simulation 10	Send/Receive
11	1 byte	Simulation 11	Send/Receive
12	1 byte	Simulation 12	Send/Receive
13	1 byte	Simulation 13	Send/Receive
14	1 byte	Simulation 14	Send/Receive
15	1 byte	Simulation 15	Send/Receive
16	1 byte	Simulation 16	Send/Receive
17	1 byte	Simulation 17	Send/Receive
18	1 byte	Simulation 18	Send/Receive
19	1 byte	Simulation 19	Send/Receive
20	1 byte	Simulation 20	Send/Receive

Parameters: Presence simulation
The default setting of the values is printed in bold type.

- Waiting time up to the activation	30s / 40s / 50s / 1min / 1.1min / 1.2min / 1.5 min / 2 min
-------------------------------------	---

Functional description: Logical functions (1...8)

E1: Input 1
 E2: Input 2
 A: Output

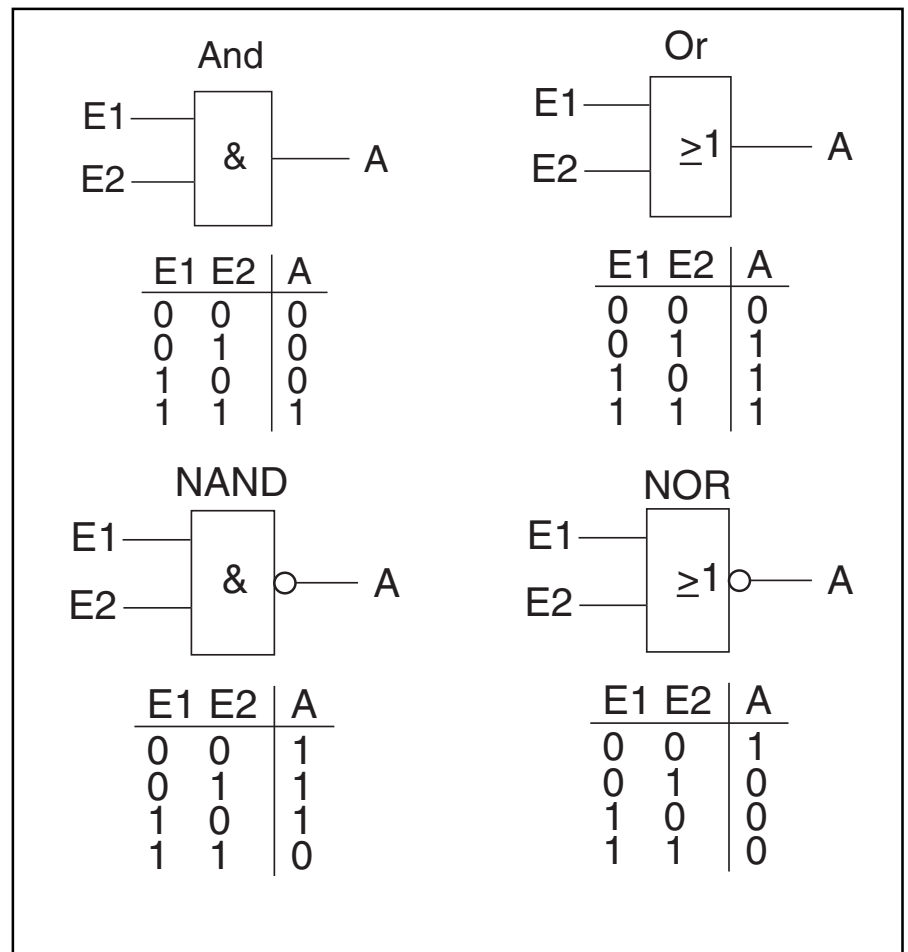

Up to 20 different logic functions can be integrated with up to 10 inputs in the panel. Each logic function can adopt one of the following functions:

- AND
- OR
- NAND
- NOR
- Multiplexer
- Multiplier
- Gate
- Time function
- Temperature comparator 111O
- Temperature comparator 211O
- Status converter

AND, OR, NAND and NOR

If the function is defined with AND, OR, NAND or NOR, up to four input communication objects can be enabled per logic function. The size of the inputs can either be 1 bit or 1 byte. When a new telegram is received at the input, it is switched according to the selected function. In addition, the inputs can be inverted together. Example of "AND" 1-byte inputs:

If the inputs are 1 byte, all the input values must be greater than "0" in order to achieve a positive result.

Example of inverted "AND" 1-byte inputs:
 If the inputs are 1 byte and inverted, all the input values must be equal to "0" in order to achieve a positive result.

Each function has an output object to which the result determined from the inputs is sent. The output object can be 1 bit or 1 byte, depending on the parameterisation. The default value which should be sent in the event of a positive result can be set. In addition, a delay for sending the output signal can also be selected.

It is also possible to set an output filter. This means that either only "On", only "Off" or "On and Off" can be sent for a 1-bit output object. With a 1-byte output object, it can be set whether "only the given value", "only Off" or "only the given value and Off" should be sent.

So that the inputs are not undefined after a voltage failure and subsequent voltage recovery, there is the parameter "Behaviour of inputs after reset". The inputs can either be read i.e. send read requests to the linked objects which leads to an increased bus load or the inputs can adopt default values which can be defined in the parameters.

Multiplexer

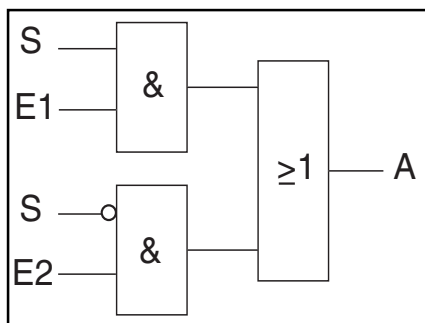

Via the "Multiplexer" logic function, the input data to the output can be controlled directly. The function has four communication objects "Controller", "Input 1", "Input 2" and "Output". The diagram above indicates the function of a 1-bit multiplexer (S=Controller, E1=Input 1, E2=Input 2, A= Output).

The bit size of the inputs and outputs can be set to 1 byte or 2 byte via the parameter "Object type input/output". The above functionality is thereby retained. That means that only input 1 is visible at the output if the control input has the value "1". Input 2 is switched to the output as soon as the control input has the value "0".

Note:

The output is only sent when there is an actual change of the inputs. If e.g. the control input changes without the input value changing, the output signal remains as it is. A new output value is sent only if an input signal changes.

Multiplier

The "Multiplier" function enables up to four output telegrams to be sent with an input telegram. The input communication object is 1 bit. The output communication objects can either be 1 bit or 1 byte. The size is set via a corresponding parameter.

It can be defined via the setting "Starting conditions" whether a duplication of an input telegram should be triggered after an ON or OFF telegram. Moreover, there is the possibility of sending output telegrams with a time delay. By default, a delay of 1 s is defined.

The useful information (values) which should be sent with the output telegrams can be set individually for each output via a corresponding parameter. For 1-bit outputs, this is "On" or "Off" while for 1-byte outputs, values between "0" and "255" can be assigned.

Gate

With the "Gate" logic function, it is possible to filter specific signals and to disable the signal flow temporarily. The function has three communication objects "Control input", "Input" and "Output".

The control input or output can be 1 bit, 4 bits, 1 byte or 2 bytes. The object types for input and output can also be set to "unassigned". This means that the bit size can be freely assigned. The first internal or external group address which is assigned and is already linked with another communication object defines the size.

The control is always carried out from input to output provided that this is permitted by the control input. The activation via the control input can be carried out via an ON or an OFF telegram. If the setting "Control input" is set to "ON telegram" for example, only telegrams from the input to the output are routed if a "1" has previously been received at the control input.

For 1-bit input and output objects, it can be set whether the input signals should be saved or not "During the blocking". If the setting "Store input signal" is selected, the output sends its value if a telegram has been received at the input during the blocking.

If the input and output objects are 1 bit, it is possible to invert the output. An inversion element can therefore be implemented by a gate.

It is also possible to block signals via the "Filter function" setting. The following settings are possible: "Filter not-

hing", "Filter ON" or "Filter OFF". This function is e.g. only necessary if the ON telegram from a sensor is of interest and this sensor does not have a filter function in its application program.

Time function

There are two 1-bit communication objects for the time function, namely "Input" and "Output".

If parameter "Staircase light function" is switched active, the time for the staircase light is triggered via the 1-bit communication object "Input" after the receipt of an ON telegram and an ON telegram is sent out on the 1-bit communication object "Output". After expiration of the light-on time, an OFF telegram is sent out via the output object.

The time for the staircase light is set with the corresponding parameter. A time from 10 s to 99:59 min can be set.

If an ON telegram is again received on the input communication object during the staircase light delay time, the delay time can be restarted (re-triggered). If this action is required, the parameter "Retrigger" should be set on "Yes".

Also a switch-on delay can be activated. This means that the staircase light time is started and an ON telegram is sent on the output object only after the switch-on delay time has expired.

When parameter "Staircase light function" is deactivated, there is a switch-off delay time in addition to the switch-on delay time. This means that when an ON telegram is received on the input object, the switch-on delay time expires first. After it has expired, an ON telegram is sent on the output object. If an OFF telegram is received on the input object, the switch-off delay time starts. After it has expired, an OFF telegram is sent on the output object.

Temperature comparator

The two temperature comparator functions correspond to the functions of the DIN rail mounted logic module.

Temperature comparator 1110

With the function "Temperature comparator 1110", a temperature is compared with an internally defined temperature value. The function makes an input available with a 2-byte communication object. Temperature telegrams which are triggered by an KNX temperature sensor are received at this object and compared.

The value which the temperature at input 1 should be compared with, is defined in the parameter "Comparative value in °C". This comparative value (input 2) can adopt values between -30 °C and +70 °C.

Application example:

Monitoring of a warehouse. Food should be stored in the warehouse at a temperature below 12 °C. An KNX temperature sensor is installed for this purpose. If the storage temperature exceeds 12 °C, a cooling unit is switched on in order to keep the food fresh.

So that telegrams are not triggered continually, if the temperature values for comparison are almost identical, it is advisable to set a hysteresis. By default, this is set at 1.5 K. This means that if the temperature of the comparative value has a value of 12 °C and the temperature at the input exceeds a value of 12 °C, a telegram is not immediately triggered at the output. It is only triggered when it exceeds 12.75 °C. The output is reset when a temperature falls below 11.25 °C.

The output communication object is 1 bit by default. ON or OFF telegrams are sent to this object. It is defined in the parameters when a telegram is sent. Depending on the setting "Telegram will be sent at", telegrams are triggered if an input is greater than another input or if the result changes. A change in the result means that the value of the input has exceeded or fallen below the comparative value.

In addition, it can be set whether an ON telegram or an OFF telegram is sent when the value exceeds or falls below the comparative value.

1-byte values can also be sent to the output object. To do so, the parameter "Object type of the output" must be set to "1 byte". In a similar way to the

switch output, different conditions can also be set to determine when a telegram should be sent. The value which is sent is defined with the settings "It will be sent if input > comparative value" or "...if input < comparative value". Values between 0 and 255 can be sent.

The output value is sent cyclically if the setting "Send output cycle" is activated. The cycle time is set by default at 9:59 but can be adapted to a required cycle time.

Temperature comparator 2I1O

Two temperatures can be compared with this function. There are two separate inputs available with 2-byte communication objects. Temperature telegrams which are triggered by KNX temperature sensors are received at these objects and compared with each other.

Application example:
Summer/wintertime conversion in a ventilation control system. An KNX temperature sensor is installed in the supply air and discharge air ducts. If the incoming temperature is identical to or warmer than the outgoing temperature, it is possible to switch to summer mode.

The output communication object is 1 bit by default. ON or OFF telegrams are sent to this object. It is defined in the parameters when a telegram is sent. Depending on the setting "Telegram will be sent at", telegrams are triggered if an input is greater than another input or if the result changes. A change in the result means that the value of input 1 has exceeded or fallen below the value of input 2.

In addition, it can be set whether an ON telegram or an OFF telegram is sent when the value of one input exceeds or falls below the value of the other input.

1-byte values can also be sent to the output object. To do so, the parameter "Object type of the output" must be set to "1 byte". In a similar way to the switch output, different conditions can also be set to determine when a telegram should be sent. The value which is sent is defined with the settings "It will be sent if input 1 > input 2" or "...if

input 1 < input 2". Values between 0 and 255 can be sent.

The output value is sent cyclically if the setting "Send output cycle" is activated. The cycle time is set by default at 9:59 but can be adapted to a required cycle time.

Status converter

The status converter function records input values and sends a 14-byte piece of text to the output object on receipt of a telegram at the input objects.

Up to four 1-bit input objects can be created. Output text can be defined for each logic input state.

Example:

The three 1-bit inputs can in theory have the following states:

Input 1	Input 2	Input 3
0	0	0
0	0	1
0	1	0
0	1	1
1	0	0
1	0	1
1	1	0
1	1	1

Separate text can be defined for each input state which is immediately sent via the 14-byte output communication object when the state is met.

Alternatively, the input value can also be set to 1 byte. In this case, the sending of the text is triggered via the 14-byte output object on receipt of a 1-byte value at the input object. Up to 16 different input values or output values can be defined.

Functional description: Logical functions (1...8)

Function	Application
Logical function 1	Inactive AND OR NAND NOR Multiplexer Multiplier Gate Time function Temperature comparator 1110 Temperature comparator 2110 Status converter
Logical function 2	Inactive AND OR NAND NOR Multiplexer Multiplier Gate Time function Temperature comparator 1110 Temperature comparator 2110 Status converter
...	
Logical function 19	Inactive AND OR NAND NOR Multiplexer Multiplier Gate Time function Temperature comparator 1110 Temperature comparator 2110 Status converter
Logical function 20	Inactive AND OR NAND NOR Multiplexer Multiplier Gate Time function Temperature comparator 1110 Temperature comparator 2110

Communication objects for 1-bit inputs (AND, OR, NAND and NOR)

No.	Type	Object name	Function
0	1 bit	Output	Send/Receive
1	1 bit	Input 1	Receive
2	1 bit	Input 2	Receive
...			
10	1 bit	Input 10	Receive

Communication objects for 1-byte inputs (AND, OR, NAND and NOR)

No.	Type	Object name	Function
0	1 bit	Output	Send/Receive
1	1 byte	Input 1	Receive
2	1 byte	Input 2	Receive
...			
10	1 byte	Input 10	Receive

Communication objects for 1-bit multiplexer

No.	Type	Object name	Function
0	1 bit	Controller	Receive
1	1 bit	Input 1	Receive
2	1 bit	Input 2	Receive
3	1 bit	Output	Send

Communication objects for 1-byte multiplexer

No.	Type	Object name	Function
0	1 bit	Controller	Receive
1	1 byte	Input 1	Receive
2	1 byte	Input 2	Receive
3	1 byte	Output	Send

Communication objects for 2-byte multiplexer

No.	Type	Object name	Function
0	1 bit	Controller	Receive
1	2 byte	Input 1	Receive
2	2 byte	Input 2	Receive
3	2 byte	Output	Send

Communication objects for 1-bit multiplier

No.	Type	Object name	Function
0	1 bit	Input	Receive
1	1 bit	Output 1	Send
2	1 bit	Output 2	Send
3	1 bit	Output 3	Send
4	1 bit	Output 4	Send

Communication objects for 1-byte multiplier

No.	Type	Object name	Function
0	1 bit	Input	Receive
1	1 byte	Output 1	Send
2	1 byte	Output 2	Send
3	1 byte	Output 3	Send
4	1 byte	Output 4	Send

Communication objects for gate function

No.	Type	Object name	Function
0	1 bit	Control input	Receive
1	1 bit	Input	Send/Receive
2	1 bit	Output	Send/Receive

Communication objects for gate function with 4-bit input

No.	Type	Object name	Function
...			
1	4 bit	Input	Send/Receive

Communication objects for gate function with 1-byte input

No.	Type	Object name	Function
...			
1	1 byte	Input	Send/Receive

Communication objects for gate function with 2-byte input

No.	Type	Object name	Function
...			
1	2 byte	Input	Send/Receive

Communication objects for Time function

Nr.	Type	Object name	Function
0	1 bit	Input	Receive
1	1 bit	Output	Send

Communication objects for temperature comparator 1110 with 1-bit output

No.	Type	Object name	Function
0	2 byte	Input	Receive
1	1 bit	Output	Send

Communication objects for temperature comparator 1110 with 1-byte output

No.	Type	Object name	Function
0	2 byte	Input	Receive
1	1 byte	Output	Send

Communication objects for temperature comparator 2110 with 1-bit output

No.	Type	Object name	Function
0	2 byte	Input 1	Receive
1	2 byte	Input 2	Receive
2	1 bit	Output	Send

Communication objects for temperature comparator 2110 with 1-byte output

No.	Type	Object name	Function
0	2 byte	Input 1	Receive
1	2 byte	Input 2	Receive
2	1 byte	Output	Send

Communication objects for status converter with 4x1-bit inputs

No.	Type	Object name	Function
0	1 bit	Input 1 (1 bit)	Receive
1	1 bit	Input 2 (1 bit)	Receive
2	1 bit	Input 3 (1 bit)	Receive
3	1 bit	Input 4 (1 bit)	Receive
4	14 byte	Output (14 byte)	Send

Communication objects for status converter with 1-byte input

No.	Type	Object name	Function
0	1 byte	Input (1 byte)	Receive
5	14 byte	Output (14 byte)	Send

Parameters: AND, OR, NAND and NOR logic functions

The default setting for the values is printed in bold type.

– Used inputs	1 / 2 / 3 / 4
– Type of input	1 Bit / 1 Byte
– Invert inputs	No / Yes
– Behaviour of inputs after reset	Reading Given value
Only for 1 bit:	
– Given value	Off / On
Only for 1 byte:	
– Given value	0
– Type of output	1 Bit / 1 Byte
– Behaviour of the output	Send always At change
– After overwriting of output	Take value Do not take value
– Delay of the output telegram	No / Yes
Only if “Yes” is selected:	
– Time delay	00:00 / ... / 04:59 / ... / 99:59
Only for 1 bit:	
– Output filter	Send only on Send only off Send on and off
Only for 1 byte:	
– Output filter	Send only given value Send only off Send given value and off
– Given value (1...255)	1

Parameters: Multiplexer

The default setting for the values is printed in bold type.

– Object type input/output	1 Bit 1 Byte 2 Byte
----------------------------	----------------------------------

Parameters: Multiplier

The default setting for the values is printed in bold type.

General:	
– Starting conditions	OFF telegram ON telegram
– Telegram delay (s)	01:00
Separate for each output:	
– Object type Output ...	1 Bit / 1 Byte
Only for 1 bit:	
– Display output ...	Off / On
Only for 1 byte:	
– Display output ...	0

Parameters: Gate function

The default setting for the values is printed in bold type.

– Control input	Activate at OFF Activate at ON
– Object type of input and output	1 Bit 4 Bit 1 Byte 2 Byte not assigned
Only for 1 bit:	
– During the blocking	Do not store input signal Store input signal
– Filter function	Filter nothing Filter ON Filter OFF
– Invert output	No / Yes

Parameter Time function

The default setting for the values is **printed in bold type**.

- Staircase lighting active Only for staircase lighting	No / Yes
- Time for staircase lighting (00:10 - 99:59 min)	01:00
- Retrigger	No / Yes
- Switch on delay Only for switch on delay	No / Yes
- Time delay (00:10 - 99:59 min)	01:00
Only if staircase lighting is inactive	
- Switch off delay Only for switch off delay	No / Yes
- Time delay (00:10 - 99:59 min)	01:00

Parameters: Temperature comparator 1110 (1 input 1 output)

The default setting for the values is **printed in bold type**.

General:	
- Comparative value (in °C)	18
- Hysteresis	1.5
- Object type of the output	1 Bit / 1 Byte
- Telegram will be sent at	Input is greater than comparative value Input is less than comparative value Output changing
Only for 1 bit:	
- It will be sent if Input > Comparative value	OFF telegram ON telegram
- It will be sent if Input < Comparative value	OFF telegram ON telegram
Only for 1 byte:	
- It will be sent if Input > Comparative value	0
- It will be sent if Input < Comparative value	255
- Send output cycle	No / Yes
Only if "Yes" is selected:	
- Cycle time (mm:ss)	09:59

Parameters: Temperature comparator 2110 (2 inputs 1 output)

The default setting for the values is **printed in bold type**.

General:	
- Object type of the output	1 Bit / 1 Byte
- Telegram will be sent at	Input 1 is greater than input 2 Input 1 is less than input 2 Output changing
Only for 1 bit:	
- It will be sent if Input 1 > Input 2	OFF telegram ON telegram
- It will be sent if Input 1 < Input 2	OFF telegram ON telegram
Only for 1 byte:	
- It will be sent if Input 1 > Input 2	0
- It will be sent if Input 1 < Input 2	255
- Send output cycle	No / Yes
Only if "Yes" is selected:	
- Cycle time (mm:ss)	09:59

Parameters: Status converter
 The default setting for the values
 is **printed in bold type**.

– Type of input	1 bit 1 byte
Only for 1 bit:	
– Number of inputs	1 / 2 / 3 / 4
(Following parameters only for 2 inputs)	
– Output (14 bytes) for input value I2, I1=00	Inactive Active
Only if “Active” is selected:	
– Output text (14 bytes) for input value I2, I1=00	<Text>
– Output (14 bytes) for input value I2, I1=00	Inactive Active
Only if “Active” is selected:	
– Output text (14 bytes) for input value I2, I1=00	<Text>
...	
– Output (14 bytes) for input value I2, I1=00	Inactive Active
Only if “Active” is selected:	
– Output text (14 bytes) for input value I2, I1=00	<Text>
Only for 1 byte:	
– Number of input/output values	1 / 2 / 3 / 4 / ... / 15 / 16
(Following parameters only for 3 input/output values)	
– Input value 1	0
– Output text (14 bytes) for input value 0	<Text>
– Input value 2	0
– Output text (14 bytes) for input value 1	<Text>
– Input value 3	0
– Output text (14 bytes) for input value 2	<Text>