

EAE ROSA THERMOSTAT

Product Manual Rosa Thermostat



Content

1. General.....	4
2. Device Technology.....	4
2.1 Button Definitions	4
2.2 Connection Diagram	4
2.3 Technical Data	5
2.4 Dimensions	5
3. Communication Object Table	6
4. Parameters and Communication Objects	17
4.1 General.....	17
4.1.1 Parameters.....	18
4.1.2 Communication Objects	19
4.2 Rockers and Buttons	19
4.2.1 Rockers	20
4.2.2 Push Buttons	30
4.3 Temperature Sensor.....	38
4.3.1 Parameters.....	39
4.3.2 Communication Objects	41
4.4 Thermostat.....	42
4.4.1 Parameters.....	43
4.4.2 Communication Objects.....	44
4.4.3 Control Types	45
4.4.3.1 Main Stages	45
4.4.3.2 Additional Stages.....	46
4.4.4 Heating Control Main Stages	47
4.4.4.1 PI Continuous	48
4.4.4.2 PI PWM	50
4.4.4.3 On/Off.....	52
4.4.4.4 Fan Coil	53
4.4.4.5 Split Unit	55
4.4.5 Heating Control Additional Stages	56
4.4.5.1 PI Continuous	56
4.4.5.2 PI PWM	59
4.4.5.3 On/Off.....	62

4.4.5.4	Fan Coil	64
4.4.5.5	Split Unit	66
4.4.6	Cooling Control Main Stages.....	67
4.4.7	Cooling Control Additional Stages.....	67
4.4.8	Fan Control	68
4.4.8.1	Parameter.....	68
4.4.8.2	Communication Objects.....	69
4.5	Setpoints.....	70
4.5.1	Parameter	71
4.5.2	Communication Objects.....	73
4.6	Local Control	77
4.6.1	Parameters	77

1. General

Extendable up to 4 folds, Rosa thermostats offer a wide range of functional flexibility with integrated programmable switches.

Buttons on Rosa thermostats can be programmed to control lighting, shutter/blind drivers, speakers, make scene calls and mimic panic buttons. Each button can be programmed independently for a different function.

2. Device Technology

2.1 Button Definitions



- 1. Programmable Button Group 1
- 2. Fan Speed (1, 2, 3, A)
- 3. Operation Mode (Comfort, Night, Away, OFF)
- 4. Setpoint Temperature UP
- 5. Setpoint Temperature DOWN
- 6. Programmable Button Group 2

2.2 Connection Diagram

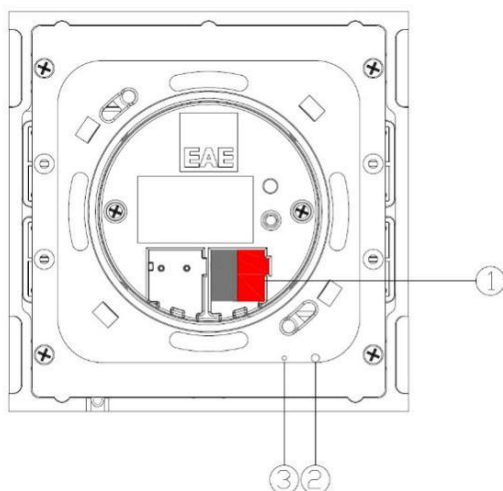

- 1. KNX Port Terminal
- 2. Programming Button
- 3. Programming LED

2.3 Technical Data

Protection Type	IP20	EN 60529
Safety Class	II	EN 61140
Supply	Voltage Range Supply Voltage Power Consumption	21-30V DC, Supply from EIB/KNX line 20 mA 20 mA x 30V
Operation LEDs	Programming LED for each fold	1 to 5 RGB LEDs for physical address identification
Button Operation Life	100.000	
Temperature	Operating Storage Transport	-5° C + 45° C -25° C + 55° C -25° C + 70° C
CE	In accordance with EMC guideline and low voltage regulation	

2.4 Dimensions

Dimensions (mm)	a	b	h
2 Fold Thermostat	90	9	90
3 Fold Thermostat	90	9	111,5
4 Fold Thermostat	90	9	133

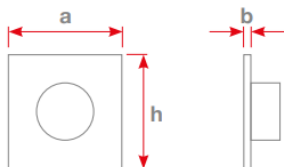

Assembly Detail

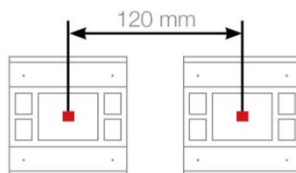

Important note!

The distance between the two thermostats should be at least **120 mm** from center to center.

3. Communication Object Table

No.	Object Name	Object Function	Number of Bits	Flags
0	General, operation	Active	1	CT
1	Rocker 1, switch	On/Off	1	CWT
	Rocker 1, shutter	Up/Down	1	CWT
	Rocker 1, value[0,1]	Send	1	CWT
	Rocker 1, value[0...255]	Send	8	CWT
	Rocker 1, value[0...65535]	Send	16	CWT
	Rocker 1, value[-32768...32768]	Send	16	CWT
	Rocker 1, value[0...4294967295]	Send	32	CWT
	Rocker 1, value(4-byte float)	Send	32	CWT
	Button 1, switch	On/Off	1	CWT
	Button 1, shutter	Up/Down	1	CWT
	Button 1, value[0,1]	On/Off	1	CWT
	Button 1, value[0...255]	Send	8	CWT
	Button 1, value[0..65535]	Send	16	CWT
	Button 1, value[-32768...32768]	Send	16	CWT
	Button 1, value[0...4294967295]	Send	32	CWT
	Button 1, value(4-byte float)	Send	32	CWT
	2	Rocker 1, dimming	Send	4
Rocker 1, shutter		Stop/Lamella Adj	1	CWT



No.	Object Name	Object Function	Number of Bits	Flags
	Button 1, dimming	Send	4	CRWT
	Button 1, shutter	Stop/Lamella Adj	1	CWT
	Button 1, value[0,1]	On/Off	1	CWT
	Button 1, value[0...255]	Send	8	CWT
	Button 1, value[0...65535]	Send	16	CWT
	Button 1, value[-32768...32768]	Send	16	CWT
	Button 1, value[0...4294967295]	Send	32	CWT
	Button 1, value(4-byte float)	Send	32	CWT
3	Rocker 1, shutter	Top Position	1	CWT
	Rocker 1, (Status)	On/Off	1	CWT
	Button 1, shutter	Top Position	1	CWT
	Button 1, (Status)	On/Off	1	CWT
4	Rocker 1, shutter	Bottom Position	1	CWT
	Button 1, shutter	Bottom Position	1	CWT
5	Button 2, switch	On/Off	1	CWT
	Button 2, shutter	Up/Down	1	CWT
	Button 2, value[0,1]	On/Off	1	CWT
	Button 2, value[0...255]	Send	8	CWT
	Button 2, value[0..65535]	Send	16	CWT
	Button 2, value[-32768...32768]	Send	16	CWT
	Button 2, value[0...4294967295]	Send	32	CWT
Button 2, value(4-byte float)	Send	32	CWT	
6	Button 2, dimming	Send	4	CRWT
	Button 2, shutter	Stop/Lamella Adj	1	CWT
	Button 2, value[0,1]	On/Off	1	CWT



No.	Object Name	Object Function	Number of Bits	Flags
	Button 2, value[0...255]	Send	8	CWT
	Button 2, value[0...65535]	Send	16	CWT
	Button 2, value[-32768...32768]	Send	16	CWT
	Button 2, value[0...4294967295]	Send	32	CWT
	Button 2, value(4-byte float)	Send	32	CWT
7	Button 2, shutter	Top Position	1	CWT
	Button 2, (Status)	On/Off	1	CWT
8	Button 2, shutter	Bottom Position	1	CWT
9	Rocker 2, switch	On/Off	1	CWT
	Rocker 2, shutter	Up/Down	1	CWT
	Rocker 2, shutter	Send	1	CWT
	Rocker 2, value[0...255]	Send	8	CWT
	Rocker 2, value[0...65535]	Send	16	CWT
	Rocker 2, value[-32768...32768]	Send	16	CWT
	Rocker 2, value[0...4294967295]	Send	32	CWT
	Rocker 2, value(4-byte float)	Send	32	CWT
	Button 3, switch	On/Off	1	CWT
	Button 3, shutter	Up/Down	1	CWT
	Button 3, value[0,1]	On/Off	1	CWT
	Button 3, value[0...255]	Send	8	CWT
	Button 3, value[0..65535]	Send	16	CWT
	Button 3, value[-32768...32768]	Send	16	CWT
	Button 3, value[0...4294967295]	Send	32	CWT
	Button 3, value(4-byte float)	Send	32	CWT



No.	Object Name	Object Function	Number of Bits	Flags
10	Rocker 2, dimming	Send	4	CRWT
	Rocker 2, shutter	Stop/Lamella Adj	1	CWT
	Button 3, dimming	Send	4	CRWT
	Button 3, shutter	Stop/Lamella Adj	1	CWT
	Button 3, value[0,1]	On/Off	1	CWT
	Button 3, value[0...255]	Send	8	CWT
	Button 3, value[0...65535]	Send	16	CWT
	Button 3, value[-32768...32768]	Send	16	CWT
	Button 3, value[0...4294967295]	Send	32	CWT
	Button 3, value(4-byte float)	Send	32	CWT
11	Rocker 2, shutter	Top Position	1	CWT
	Rocker 2, (Status)	On/Off	1	CWT
	Button 3, shutter	Top Position	1	CWT
	Button 3, (Status)	On/Off	1	CWT
12	Rocker 2, shutter	Bottom Position	1	CWT
	Button 3, shutter	Bottom Position	1	CWT
13	Button 4, switch	On/Off	1	CWT
	Button 4, shutter	Up/Down	1	CWT
	Button 4, value[0,1]	On/Off	1	CWT
	Button 4, value[0...255]	Send	8	CWT
	Button 4, value[0..65535]	Send	16	CWT
	Button 4, value[-32768...32768]	Send	16	CWT
	Button 4, value[0...4294967295]	Send	32	CWT
	Button 4, value(4-byte float)	Send	32	CWT



No.	Object Name	Object Function	Number of Bits	Flags
14	Button 4, dimming	Send	4	CRWT
	Button 4, shutter	Stop/Lamella Adj	1	CWT
	Button 4, value[0,1]	On/Off	1	CWT
	Button 4, value[0...255]	Send	8	CWT
	Button 4, value[0...65535]	Send	16	CWT
	Button 4, value[-32768...32768]	Send	16	CWT
	Button 4, value[0...4294967295]	Send	32	CWT
	Button 4, value(4-byte float)	Send	32	CWT
15	Button 4, shutter	Top Position	1	CWT
	Button 4, (Status)	On/Off	1	CWT
16	Button 4, shutter	Bottom Position	1	CWT
17	Rocker 3, switch	On/Off	1	CWT
	Rocker 3, shutter	Up/Down	1	CWT
	Rocker 3, value[0,1]	Send	1	CWT
	Rocker 3, value[0...255]	Send	8	CWT
	Rocker 3, value[0...65535]	Send	16	CWT
	Rocker 3, value[-32768...32768]	Send	16	CWT
	Rocker 3, value[0...4294967295]	Send	32	CWT
	Rocker 3, value(4-byte float)	Send	32	CWT
	Button 5, switch	On/Off	1	CWT
	Button 5, shutter	Up/Down	1	CWT
	Button 5, value[0,1]	On/Off	1	CWT
	Button 5, value[0...255]	Send	8	CWT
	Button 5, value[0..65535]	Send	16	CWT
	Button 5, value[-32768...32768]	Send	16	CWT



No.	Object Name	Object Function	Number of Bits	Flags
	Button 5, value[0...4294967295]	Send	32	CWT
	Button 5, value(4-byte float)	Send	32	CWT
18	Rocker 3, dimming	Send	4	CRWT
	Rocker 3, shutter	Stop/Lamella Adj	1	CWT
	Button 5, dimming	Send	4	CRWT
	Button 5, shutter	Stop/Lamella Adj	1	CWT
	Button 5, value[0,1]	On/Off	1	CWT
	Button 5, value[0...255]	Send	8	CWT
	Button 5, value[0...65535]	Send	16	CWT
	Button 5, value[-32768...32768]	Send	16	CWT
	Button 5, value[0...4294967295]	Send	32	CWT
	Button 5, value(4-byte float)	Send	32	CWT
19	Rocker 3, shutter	Top Position	1	CWT
	Rocker 3, (Status)	On/Off	1	CWT
	Button 5, shutter	Top Position	1	CWT
	Button 5, (Status)	On/Off	1	CWT
20	Rocker 3, shutter	Bottom Position	1	CWT
	Button 5, shutter	Bottom Position	1	CWT
21	Button 6, switch	On/Off	1	CWT
	Button 6, shutter	Up/Down	1	CWT
	Button 6, value[0,1]	On/Off	1	CWT
	Button 6, value[0...255]	Send	8	CWT
	Button 6, value[0..65535]	Send	16	CWT
	Button 6, value[-32768...32768]	Send	16	CWT



No.	Object Name	Object Function	Number of Bits	Flags
	Button 6, value[0...4294967295]	Send	32	CWT
	Button 6, value(4-byte float)	Send	32	CWT
22	Button 6, dimming	Send	4	CRWT
	Button 6, shutter	Stop/Lamella Adj	1	CWT
	Button 6, value[0,1]	On/Off	1	CWT
	Button 6, value[0...255]	Send	8	CWT
	Button 6, value[0...65535]	Send	16	CWT
	Button 6, value[-32768...32768]	Send	16	CWT
	Button 6, value[0...4294967295]	Send	32	CWT
	Button 6, value(4-byte float)	Send	32	CWT
23	Button 6, shutter	Top Position	1	CWT
	Button 6, (Status)	On/Off	1	CWT
24	Button 6, shutter	Bottom Position	1	CWT
25	Rocker 4, switch	On/Off	1	CWT
	Rocker 4, shutter	Up/Down	1	CWT
	Rocker 4, value[0,1]	Send	1	CWT
	Rocker 4, value[0...255]	Send	8	CWT
	Rocker 4, value[0...65535]	Send	16	CWT
	Rocker 4, value[-32768...32768]	Send	16	CWT
	Rocker 4, value[0...4294967295]	Send	32	CWT
	Rocker 4, value(4-byte float)	Send	32	CWT
	Button 7, switch	On/Off	1	CWT
	Button 7, shutter	Up/Down	1	CWT
	Button 7, value[0,1]	On/Off	1	CWT
	Button 7, value[0...255]	Send	8	CWT



No.	Object Name	Object Function	Number of Bits	Flags
	Button 7, value[0..65535]	Send	16	CWT
	Button 7, value[-32768...32768]	Send	16	CWT
	Button 7, value[0...4294967295]	Send	32	CWT
	Button 7, value(4-byte float)	Send	32	CWT
26	Rocker 4, dimming	Send	4	CRWT
	Rocker 4, shutter	Stop/Lamella Adj	1	CWT
	Button 7, dimming	Send	4	CRWT
	Button 7, shutter	Stop/Lamella Adj	1	CWT
	Button 7, value[0,1]	On/Off	1	CWT
	Button 7, value[0...255]	Send	8	CWT
	Button 7, value[0...65535]	Send	16	CWT
	Button 7, value[-32768...32768]	Send	16	CWT
	Button 7, value[0...4294967295]	Send	32	CWT
	Button 7, value(4-byte float)	Send	32	CWT
27	Rocker 4, shutter	Top Position	1	CWT
	Rocker 4, (Status)	On/Off	1	CWT
	Button 7, shutter	Top Position	1	CWT
	Button 7, (Status)	On/Off	1	CWT
28	Rocker 4, shutter	Bottom Position	1	CWT
	Button 7, shutter	Bottom Position	1	CWT
29	Button 8, switch	On/Off	1	CWT
	Button 8, shutter	Up/Down	1	CWT
	Button 8, value[0,1]	On/Off	1	CWT
	Button 8, value[0...255]	Send	8	CWT



No.	Object Name	Object Function	Number of Bits	Flags
	Button 8, value[0..65535]	Send	16	CWT
	Button 8, value[-32768...32768]	Send	16	CWT
	Button 8, value[0...4294967295]	Send	32	CWT
	Button 8, value(4-byte float)	Send	32	CWT
30	Button 8, dimming	Send	4	CRWT
	Button 8, shutter	Stop/Lamella Adj	1	CWT
	Button 8, value[0,1]	On/Off	1	CWT
	Button 8, value[0...255]	Send	8	CWT
	Button 8, value[0...65535]	Send	16	CWT
	Button 8, value[-32768...32768]	Send	16	CWT
	Button 8, value[0...4294967295]	Send	32	CWT
	Button 8, value(4-byte float)	Send	32	CWT
31	Button 8, shutter	Top Position	1	CWT
	Button 8, (Status)	On/Off	1	CWT
32	Button 8, shutter	Bottom Position	1	CWT
49	Window (Status)	Open/Close	1	CW
50	Regulation	On/Off	1	CWT
51	Additional Heat Control Value	On/Off	1	CT
	Additional Heat Control Value (%0...%100)	Send	8	CT
	Additional Heat/Cool Control Value	On/Off	1	CT
	Additional Heat/Cool Control Value (%0...%100)	Send	8	CT
52	Additional Cool Control Value	On/Off	1	CT
	Additional Cool Control Value (%0...%100)	Send	8	CT
53	Split Error	True/False	1	CT
	Split Heat Error	True/False	1	CT



No.	Object Name	Object Function	Number of Bits	Flags
54	Split Cool Error	True/False	1	CT
55	Current Temperature (°C / °F)	Temperature	16	CRT
56	Current Setpoint (°C / °F)	Temperature	16	CRT
57	Operating Mode	Send	8	CW
	Comfort Mode	Enable	1	CW
58	Night Mode	Enable	1	CW
59	Away Mode	Enable	1	CW
60	Protect Mode	Enable	1	CW
61	Heat Control Value	On/Off	1	CT
	Heat Control Value (%0...%100)	Send	8	CT
	Heat/Cool Control Value	On/Off	1	CT
	Heat/Cool Control Value (%0...%100)	Send	8	CT
62	Cool Control Value	On/Off	1	CT
	Cool Control Value (%0...%100)	Send	8	CT
63	Switchover (0=Cool, 1=Heat)	Control Mode	1	CRWT
	Switchover (1=Heat, 3=Cool)	Control Mode (Status)	1	CRT
	Switchover (0=Cool, 1=Heat)	Control Mode	8	CRWT
	Switchover (1=Heat, 3=Cool)	Control Mode (Status)	8	CRT
64	(Status) Control Mode (0=Cooling, 1=Heating)	cooling/heating	1	CRT
65	Fan Speed 0	On/Off	1	CT
66	Automatic Fan Speed	On/Off	1	CWT
67	Fan Speed	Send	8	CWT
	Fan Speed 1	Enable	1	CWT
68	Fan Speed 2	Enable	1	CWT



No.	Object Name	Object Function	Number of Bits	Flags
69	Fan Speed 3	Enable	1	CWT
70	Change Setpoint (°C / °F)	Temperature	16	CW
71	External Temperature Sensor (°C / °F)			
72	Spot Temperature Sensor (°C / °F)			
73	Reset On Site	0/1	1	CW
74	Operating Mode (Status)	Send	8	CRT
	Comfort (Status)	True/False	1	
75	Night (Status)	True/False	1	
76	Away (Status)	True/False	1	
77	Protect (Status)	True/False	1	
78	Regulation (Status)	On/Off	1	
79	Setpoint Comfort (°C / °F)	Temperature	16	CW
	Setpoint Heating Comfort (°C / °F)			
80	Setpoint Night (°C / °F)	Temperature	16	CW
	Setpoint Heating Night (°C / °F)			
81	Setpoint Away (°C / °F)	Temperature	16	CW
	Setpoint Heating Away (°C / °F)			
82	Setpoint Cooling Comfort (°C / °F)	Temperature	16	CW
83	Setpoint Cooling Night (°C / °F)	Temperature	16	CW
84	Setpoint Cooling Away (°C / °F)	Temperature	16	CW
85	Setpoint Comfort (Status) (°C / °F)	Temperature	16	CRT
	Setpoint Heating Comfort (Status) (°C / °F)			
86	Setpoint Night (Status) (°C / °F)	Temperature	16	CRT
	Setpoint Heating Night (Status) (°C / °F)			

No.	Object Name	Object Function	Number of Bits	Flags
87	Setpoint Away (Status) (°C / °F)	Temperature	16	CRT
	Setpoint Heating Away (Status) (°C / °F)			
88	Setpoint Cooling Comfort (Status) (°C / °F)	Temperature	16	CRT
89	Setpoint Cooling Night (Status) (°C / °F)	Temperature	16	CRT
90	Setpoint Cooling Away (Status) (°C / °F)	Temperature	16	CRT

Table 1

4. Parameters and Communication Objects

4.1 General

General parameters include configuration of “in operation bit”, total rocker count, telegram limitations, telegram delay, window status, LED Control, LCD controls and Displaying Temperature settings.

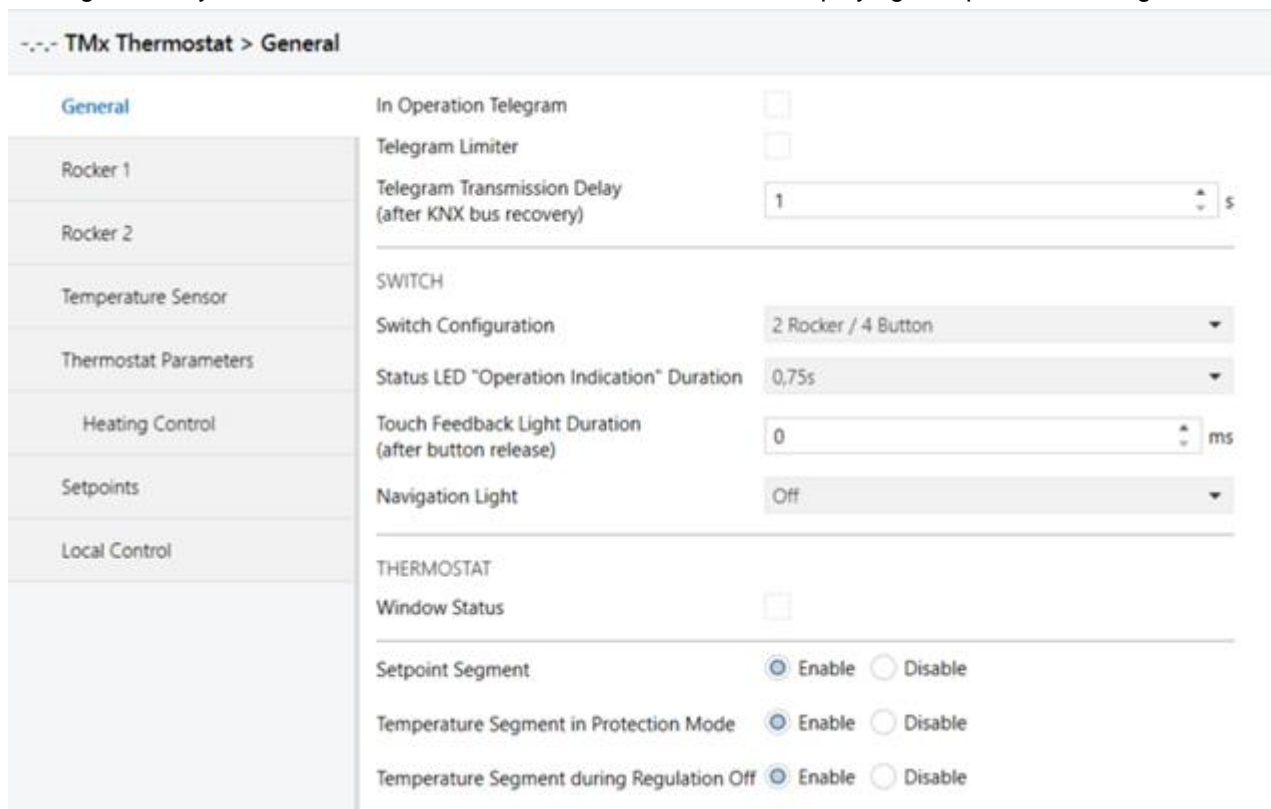

Figure 1

Parameter	Settings	Description
In Operation Telegram	checked/ unchecked	In operation can be used to ensure that device is alive and connected to KNX line.
In Operation Value	0/1	Visible when “In Operation Telegram” checked. Bit value to send as device alive operation
In Operation Sending Interval[sec]	0... 300 ...65535	Visible when “In Operation Telegram” checked. Cyclic time period for sending in operation bit
Telegram Limiter	checked/ unchecked	Limits the number of telegrams to send in certain time period
Telegram Limit Period Duration	50ms , 100ms, ..., 30s, 1min	Visible when “Telegram Limiter” checked. Time period to check telegram numbers
Maximum Telegram Count in Period	1 ...255	Visible when “Telegram Limiter” checked. Maximum number of telegrams will be sent in telegram limit period duration
Telegram Transmission Delay (after KNX bus recovery)	1 ...255	Device's first sending telegram duration after reset or bus return.
Switch Configuration	1, 2, 3, 4	Number of rockers should be selected compatible with device to be able to use rockers and buttons correctly.
Status LED “Operation Indication” Duration	0.75s , 1.5s, 2.25s, 3.25s	LEDs on duration when status LEDs used as operation indication with rocker or buttons.
Touch Feedback Light Duration (after button release)	0 ...3000 ms	LED indication duration after releasing the button.
Navigation Light	Off , Low, Medium, High Brightness	This parameter allows to choose dimming level of Navigation LED.
Window Status	checked/ unchecked	Enables communication object which will be used to detect window status. When window detected as open thermostat automatically enters “Protect Mode” with error and detected as close will return to the previous mode.
DPT Window Object	0=Closed, 1=Open 0=Open, 1=Closed	Windows status input object trigger type.
Delay for open action [in sec]	0 ...65535	This parameter allows to set delay time for Window Status action. (0=Instant)
Setpoint Segment	Enable/Disable	When disabled current setpoint value will replace temperature segment on LCD and blink for a few seconds, otherwise additional setpoint segment will be used.
Temperature Segment in Protection Mode	Enable/Disable	It allows to show current temperature on LCD display when Protection Mode is active.
Temperature Segment during Regulation Off	Enable/Disable	It allows to show current temperature on LCD display when Regulation is off.

Table 2

4.1.2 Communication Objects

No	Object Name	Function	Data Type	Flags
0	General – In operation	Active	1 bit DPT 1.002	CT
In operation value (0,1) selected through “In operation bit” parameter will be sent via the group address which is linked to this communication object				
49	Window Status	Open/Close	1 bit DPT 1.009	CW
If window status enabled, this communication object will be used to detect window status. If window detected as open, thermostat will wait until delay time passed. If the windows is still open and the related parameter is set with delay, then thermostat will enter to protection mode and will not response mode change commands (over communication object or operating mode button) until window detected as closed through this communication object. Otherwise, the window open action will not be processed.				

Table 3

4.2 Rockers and Buttons

Total number of rockers can be selected through “Rocker Count” parameter in “General” tab. Buttons on the thermostat can be used as rockers or buttons. Select the desired operation from the “Rocker N” (N: Rocker number) tab (Figure 2). If configured as buttons, 2 Button tabs will be visible under “Rocker N” tab (Figure 3). Both rockers and buttons have 5 functions, no function, switch, switch and dim, shutter and value operation.

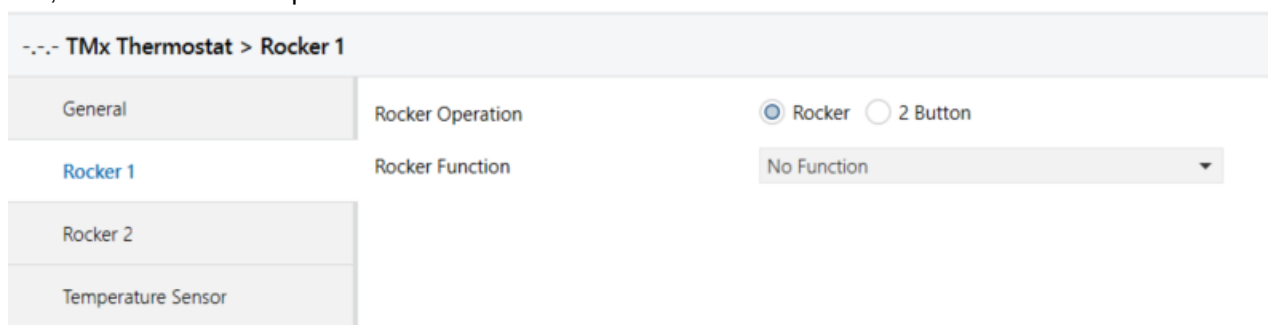

Figure2



Figure3

4.2.1 Rockers

Number of rockers should be selected in “General” tabs in parameters and should be chosen as compatible with the device that will be configured. Rockers are numbered from top to bottom, topmost rocker as Rocker 1, below it Rocker 2, and so on. Rockers can be configured as 4 different operations and 1 function to disable rocker (No Function). Operation selection can be configured with “Rocker Function” parameter. Every function enables different parameters and communication objects that will be explained in the following chapters.

Parameter	Setting	Description
Rocker Operation	Rocker/2 Push Button	Selects the function of rocker
Rocker Function	No Function	Disables the rocker
	Switch	Rocker can be used to send on/off telegrams. (For more information Chapter 4.2.1.1)
	Switch and Dim	Rocker can send on/off and dimming telegrams. (For more information Chapter 4.2.1.2)
	Shutter	Rocker can control shutter, venetian blind, blind, roller and awning. (For more information Chapter 4.2.1.3)
	Value Operation	Rocker buttons can send predefined values from different data types. (For more information Chapter 4.2.1.4)

Table 4

Rockers also have status LEDs which can be configured to indicate state of the operation that is configure.

4.2.1.1.1 Switch

Selecting “Switch” as “Rocker Function” enables to send 1 bit On(1)/Off(0) telegrams to the group address that is linked to respective communication object. Status LEDs can be configured to notify the current status of operation directly with buttons or using communication objects for confirmation to show current status.

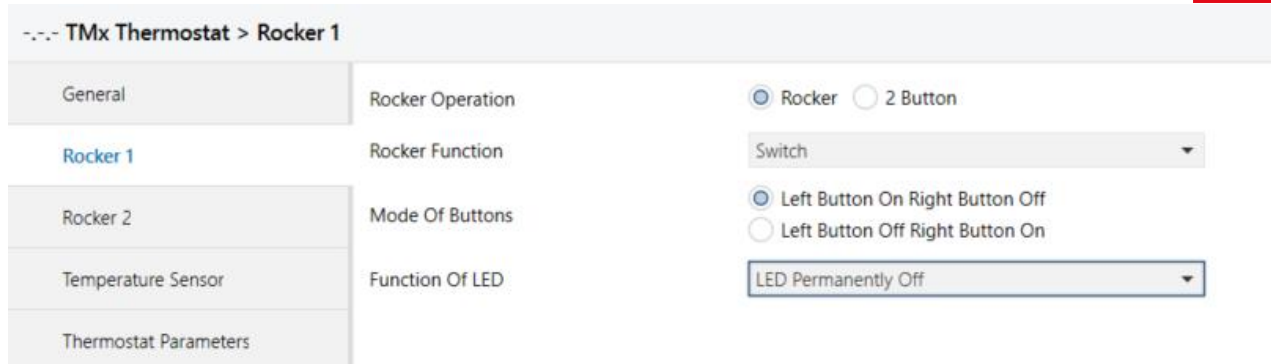

Figure 4

4.2.1.1.1 Parameters

Parameter	Setting	Description
Mode of Buttons	Left Button On Right Button Off Left Button Off Right Button On	Select which button is ON button and which button is OFF button.
Function of LED	LED Permanently Off	Button LED is always Off.
	LED Permanently On	Button LED is always On.
	Status Indication	Status LED of last pressed rocker button is on, other rocker button is off. If “Separate Comm Object” parameter selected as “Enable” status LEDs will wait for confirmation from communication object before changing state.
	Inverted Status Indication	Status LED of last pressed rocker button is off, other rocker button is on. If “Separate Comm Object” parameter selected as “Enable” status LEDs will wait for confirmation from communication object before changing state.
	Operation Indication	Status LED of the pressed rocker button will be on for the time period selected at “Light Duration of LED” parameter at “General” tab.
Separate Comm Object	Enable/Disable	Only visible when “Function of LED” selected as “Status Indication” or “Inverted Status Indication”. This communication objects is the input of confirmation for status LEDs. If selected “Enable” respective communication object should be linked to an appropriate group address

Table 5

4.2.1.1.2 Communication Objects

No	Object Name	Function	Data Type	Flags
1	Rocker1 – Telegr.switch	On/Off	1 bit	CWT

			DPT 1.001	
On/Off telegrams will be sent to group address that is linked to this communication object.				
3	Rocker1 – Status Comm.Obj.	On/Off	1 bit DPT 1.002	CWT
Confirmation for On/Off switch telegrams will be received from this communication object. If these communications object visible, it must link to an appropriate group address. Otherwise status LEDs will not function correctly. If status confirmation not to be used the communication object should be disabled by “Separate Comm Object” parameter.				

Table 6

4.2.1.2 Switch and Dim

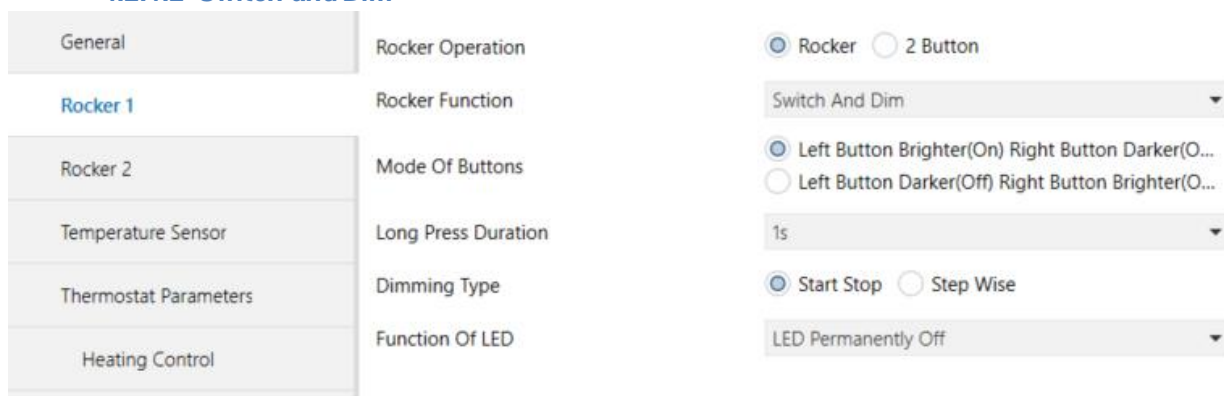

Figure 5

Rockers can be configured with switching and dimming capability. When configured as “Switch and Dim” rocker buttons will have two modes switch mode and dim mode. When rocker button pressed shorter than time period specified in “Long Press Duration” parameter, rocker button will act as a switch. In switch mode rocker buttons will behave as normal switches as explained in Chapter 4.1.1. When rocker buttons pressed longer than “Long Press Duration” rocker will enter “Dim mode”. Dimming capability can be used in two different types “Start Stop” and “Step Wise”. Which type to use can be configured in “Dimming Type” parameter.

Dimming - Start Stop Type

When rocker button pressed (and not released) and pressed duration exceeds “Long Press Duration” time “Increase, %100” (When on button pressed) or “Decrease, %100”(When off button pressed) dimming level will be send using respective communication object. When button is released “Increase, Break” or “Decrease, Break” value will be sent to stop dimming operation.

Dimming - Step Wise Type

When rocker button pressed (and not released) and pressed duration exceeds “Long Press Duration” time, a step value level configured in “Step Value” parameter will be send using respective communication object. Until button is released same step value will be send periodically with a time interval defined in “Step Send Interval”.

4.2.1.2.1 Parameters

Parameter	Setting	Description
-----------	---------	-------------

Mode of Buttons	Left Button Brighter (On) Right Button Darker(Off) / Left Button Brighter(Off) Right Button Darker(On)	Select which rocker button is on button and which rocker button is off button
Long Press Duration	300ms / 400ms / 500ms / 600ms / 800ms / 1s / 1.2s / 1.5s/ 2s / 3s / 4s / 5s / 6s / 7s / 8s / 9s / 10s	Time interval to switch from “switch mode” to “dimming mode”.
Dimming Type	Start Stop / Step Wise	Select dimming type. (Chapter 4.2.1.2)
Step Value	%100 / %50 / %25 / %12.5 / %6.25 / %3.13 / %1.56	Visible when dimming type is Step Wise. Selects the dimming resolution that will be sending at every “Step Send Interval”.
Step Send Interval	300ms / 400ms / 500ms / 600ms / 800ms / 1s / 1.2s / 1.5s / 2s / 3s / 4s / 5s / 6s / 7s / 8s / 9s / 10s	Visible when dimming type is Step Wise. Selects the time interval to send dimming increase/decrease values
Function of LED	LED Permanently Off	LED always off
	LED Permanently On	LED always on
	Status Indication	Status LED of last pressed rocker button is on, another rocker button is off. If “Separate Comm Object” parameter selected as “Enable” status LEDs will wait for confirmation from communication object before changing state.
	Inverted Status Indication	Status LED of last pressed rocker button is off, another rocker button is on. If “Separate Comm Object” parameter selected as “Enable” status LEDs will wait for confirmation from communication object before changing state.
	Operation Indication	Status LED of the pressed rocker button will be on for the time period selected at “Light Duration of LED” parameter at “General” tab.
Separate Comm Object	Enable / Disable	Only visible when “Function of LED” selected as “Status Indication” or “Inverted Status Indication”. This communication object is the input of confirmation for status LEDs. If selected as “Enable”, the respective communication object should be linked to an appropriate group address.

Table 7

4.2.1.2.2 Communication Objects

No	Object Name	Function	Data type	Flags
1	Rocker 1 – switch	On/Off	1 bit DPT 1.001	CWT
On/Off telegrams will be send to group address that is linked to this communication object.				
2	Rocker 1 – dimming	Dim	4 bit DPT 3.007	CWT
Dimming values will be send to group address that is linked to this communication object.				
3	Rocker 1-Status Comm.Obj.	On/Off	1 bit DPT 1.002	CWT
Confirmation for On/Off switch telegrams will be received from this communication object. If these communication object visible, it must link to an appropriate group address. Otherwise status LEDs will not function correctly. If status confirmation not to be used the communication object should be disabled by “Separate Comm Object” parameter.				

Table 8

4.2.1.3 Shutter

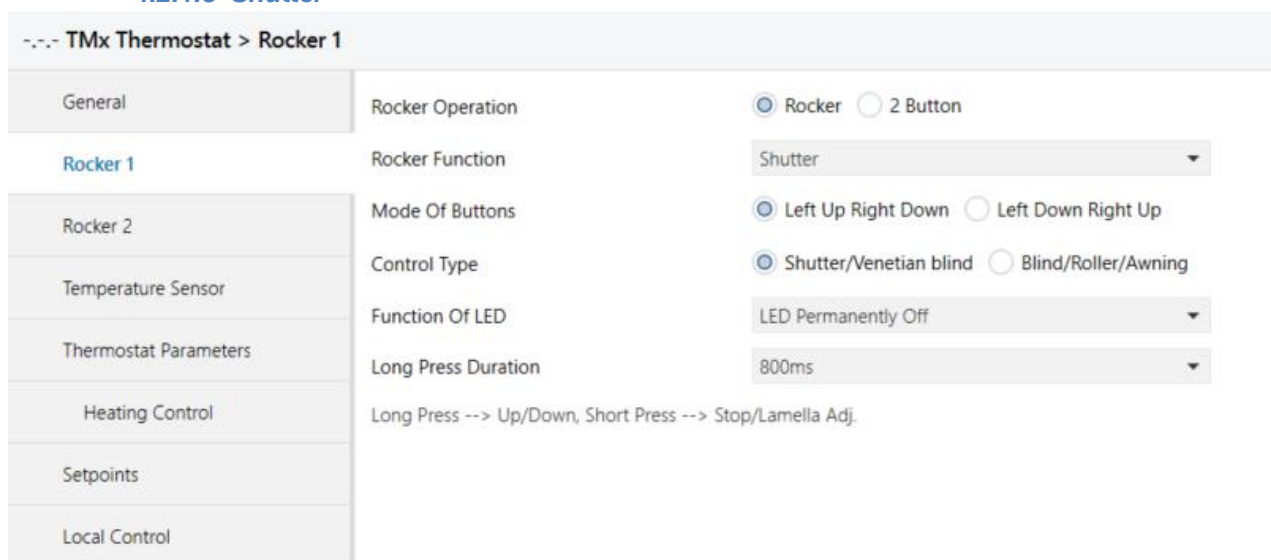

Figure 6

Selecting “Shutter” for “Rocker Operation” enables shutter operation for rocker buttons. Shutter functions can be configured to control two different shutter operations “Shutter/Venetian Blind” function or “Blind/Roller/Awning” function.

Shutter/Venetian Blind Function

Firstly, select which rocker button is used for “up” operation, which rocker button is used for “down” operation by “Mode of Buttons” parameter. Both buttons have two functions as “short press” function and “long press” function, “Long Press Duration” parameter configures the limit time period for “long press” operation. “Long Press” will be used to move the blind upwards or downwards. “Short press” has two different functions whether blind is moving or not. When blind is moving “short press” acts as a stop button that stops the blinds movement, when blind is not moving “short press” function is used to adjust lamella position.

	Short Press	Long press
Up Button – Blind Moving	Stop	Up
Down Button – Blind Moving	Stop	Down
Up Button – Blind Stopped	Lamella Down	Up
Down Button – Blind Stopped	Lamella Up	Down

Table 9

When “Up Button” long pressed “Up” telegram will be transmitted using “Rocker1 – Shutter UP/DOWN” communication object and shutter will start moving upwards until it reaches “Top Position” or “STOP” telegram transmitted using “Rocker1 – STOP/Lamella Adj.” communication object by short pressing “Up Button” or “Down Button”.

When “Down Button” long pressed “Down” telegram will be transmitted using “Rocker1 – Shutter UP/DOWN” communication object and shutter will start moving downwards until it reaches “Bottom Position” or “STOP” telegram transmitted using “Rocker1 – STOP/Lamella Adj.” communication object by short pressing “Up Button” or “Down Button”.

When blind is not moving “Up Button” and “Down Button” operate as lamella adjustment and respective telegram will be send using “Rocker1-STOP/Lamella Adj.” communication object.

Blind/Roller/Awning Function

Selecting “Control Type” parameter as “Blind/Roller/Awning” disables lamella adjustment functions of rocker buttons. In this control type, when “Up Button” pressed “Up” telegram will be send using “Rocker1 – shutter. UP/DOWN” communication object and pressed again while blind is moving “STOP” telegram will be send using “Rocker1 – STOP/Lamella adj.” communication object. When “Down Button” pressed “DOWN” telegram will be sending using “Rocker1 – shutter. UP/DOWN” communication object and pressed again while blind is moving “STOP” telegram will be send using “Rocker1 – STOP/Lamella adj.” communication object.

4.2.1.3.1 Parameters

Parameter	Setting	Description
-----------	---------	-------------

Mode of Buttons	LeftUpRightDown Left Down Right Up	Select which rocker button is “Up Button” and which rocker button is “Down Button”.
Control Type	Shutter/Venetian Blind Blind/Roller/Awning	Selects control type of blinds. Shutter/Venetian Blind function includes “Lamella Control” and Blind/Roller/Awning function does not include “Lamella Control”.
Function of LED	LED Permanently Off	LED always off
	LED Permanently On	LED always on
	Status Indication	Visualize blind’s state using status LEDs of up and down buttons. *[5]
	Operation Indication	Status LED of the pressed rocker button will be on for the time period selected at “Light Duration of LED” parameter at “General” tab.
Long Press Duration	300ms/ 400ms/ 500ms/ 600ms/ 800ms / 1s/ 1.2s/ 1.5s/ 2s/ 3s/ 4s/ 5s/ 6s/ 7s/ 8s/ 9s/ 10s	Time interval to switch from short press to long press

Table 10

***[5] LED Function – Status Indication**

Status indication operates the same way for “Shutter/Venetian Blind” and “Blind/Roller/Awning”. LEDs status respective to blind’s state is given below

	Up Button - Status LED	Down Button - Status LED
Moving upward	Blink	Off
Moving downward	Off	Blink
At top position	On	Off
At bottom position	Off	On
Stop between top - bottom	Off	Off

Table 11

When “Function of Led” selected as “Status Indication”, “Top Position” and “Bottom Position” communication objects given below must be linked to the appropriate group addresses for the status LEDs to function correctly.

4.2.1.3.2 Communication Objects

No	Object Name	Function	Data Type	Flags
1	Rocker1-shutter UP/DOWN	Up/Down	1 bit DPT 1.008	CWT

This communication object will be used to start blind movement.				
2	Rocker1 – STOP/Lamella adj.	Stop/Lamella adj.	1 bit DPT 1.002	CWT
When “Control Type” parameter is “Shutter/Venetian Blind” this communication object is used to stop movement of blind and adjust lamella position, otherwise when “Control Type” parameter is “Blind/Roller/Awning” only used for stopping blind movement.				
3	Rocker1-Top Position	True/False	1 bit DPT 1.002	CWT
This communication object should be linked to an appropriate group address that will be used to detect whether blind is at “Top Position” (True) or not (False).				
4	Rocker1-Bottom Position	True/False	1 bit DPT 1.002	CWT
This communication object should be linked to an appropriate group address that will be used to detect whether blind is at “Bottom Position” (True) or not (False).				

Table 12

4.2.1.4 Value Operation

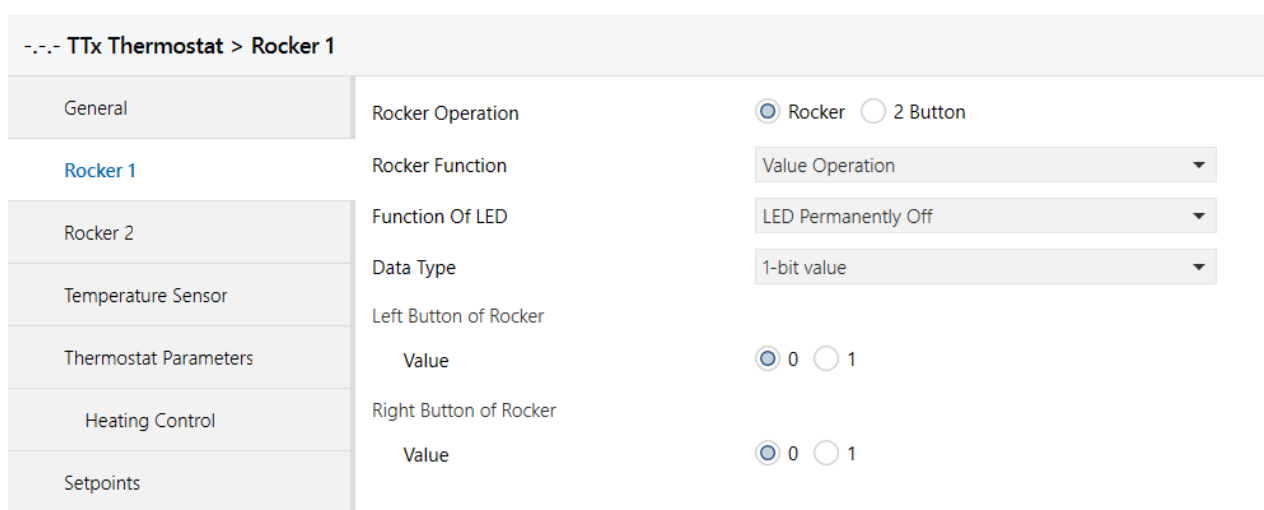

Figure 7

Rocker buttons can be configured to send predefined values from different data types. Values selected for both rocker buttons will be transmitted over the same communication object.4.2.1.4.1

4.2.1.4.1 Parameters

Parameter	Setting	Description
Function of Led	LED Permanently Off	LED always off
	LED Permanently On	LED always on

	Operation Indication	Status LED of the pressed rocker button will be on for the time period selected at “Light Duration of LED” parameter at “General” tab.
Data Type	No Reaction 1-bit value 1-byte value [0...255] 1-byte percent value [%0...%100] 2-byte value [-32768...32767] 2-byte value [0...65535] 4-byte float value 4-byte value [0...4294967295]	Select data type.
Left Button of Rocker		
Value	0/1	Visible when “Data Type” selected as “1-bit value”.
Value	0...255	Visible when “Data Type” selected as “1-byte value”.
Value	0...80...100 %	Visible when “Data Type” selected as “1-byte percent value”.
Value	-32768...0...32767	Visible when “Data Type” selected as “2-byte value [-32768...32767]”.
Value	0...65535	Visible when “Data Type” selected as “2-byte value [0...65535]”.
Integer Part	-128...0...127	Visible when “Data Type” selected as “4-byte float value”.
Fractional Part	0...99	Visible when “Data Type” selected as “4-byte float value”.
Value	0...4294967295	Visible when “Data Type” selected as “4-byte value [0...4294967295]”.
Right Button of Rocker – Operate the same way as Left Button of Rocker		

Table 13

4.2.1.4.2 Communication Objects

No	Object Name	Function	Data type	Flags
	Button 1 – value[0,1]	True/False	1 bit DPT 1.002	CWT



No	Object Name	Function	Data type	Flags
1	Enabled when "Data Type" selected as "1 bit value"			
	Button 1- value[0...255]	Send	1 byte DPT 5.010	CWT
	Enabled when "Data Type" selected as "1byte value [0...255]"			
	Button 1- value[0...255]	Send	1 byte DPT 5.001	CWT
	Enabled when "Data Type" selected as "Percent value [%0...%100]"			
	Button 1- value[-32768...32767]	Send	2 byte DPT 8.001	CWT
	Enabled when "Data Type" selected as "2 byte value [-32768...32767]"			
	Button 1- value[0...65535]	Send	2 byte DPT 7.001	CWT
	Enabled when "Data Type" selected as "2 byte value [0...65535]"			
	Button 1- value(4-byte float)	Send	4 byte DPT 14.068	CWT
	Enabled when "Data Type" selected as "4 byte value [floating point]"			
	Button 1-value[0...4294967295]	Send	4 byte DPT 12.001	CWT
	Enabled when "Data Type" selected as "4 byte value [0...4294967295]"			
	2	Button 1-long – value[0,1]	True/False	1 bit DPT 1.002
Enabled when "Long Press Data Type" selected as "1 bit value"				
Button 1-long – value[0...255]		Send	1 byte DPT 5.010	CWT
Enabled when "Long Press Data Type" selected as "1byte value [0...255]"				
Button 1- value[0...255]		Send	1 byte DPT 5.001	CWT
Enabled when "Long Press Data Type" selected as "Percent value [%0...%100]"				
Button 1 - long - value[-32768...32767]		Send	2 byte DPT 8.001	CWT
Enabled when "Long Press Data Type" selected as "2 byte value [-32768...32767]"				
Button 1- long - value[0...65535]		Send	2 byte DPT 7.001	CWT
Enabled when "Long Press Data Type" selected as "2 byte value [0...65535]"				
Button 1- long - value(4-byte float)		Send	4 byte DPT 14.068	CWT
Enabled when "Long Press Data Type" selected as "4 byte value [floating point]"				

No	Object Name	Function	Data type	Flags
	Button 1- long - value[0...4294967295]	Send	4 byte DPT 12.001	CWT
Enabled when "Long Press Data Type" selected as "4 byte value [0...4294967295]"				

Table 14

4.2.2 Push Buttons

Number of rockers should be selected in "General" tabs in parameters and should be chosen as compatible with the device that will be configured. Push buttons are numbered from top to bottom – right to left, topmost right push button as push button 1, near it push button 2, and so on. Push buttons can be configured as 4 different operations and 1 function to disable push button (No Function). Operation selection can be configured from "Push Button N" (N: Push button number) tab, visible when "Rocker Operation" selected as "2 Push Buttons". Every function enables different parameters and communication objects that will be explained in the following chapters.

Parameter	Setting	Description
Push Button Function	No Function	Disables the push button
	Switch	Push buttons can be used to send on/off telegrams. (For more information Chapter 4.2.2.1)
	Switch and Dim	Push buttons can send on/off and dimming telegrams. (For more information Chapter 4.2.2.2)
	Shutter	Push button can control shutter, venetian blind, blind, roller and awning. (For more information Chapter 4.2.2.3)
	Value Operation	Push button can send predefined values from different data types. (Refer Section 4.2.2.4)

Table 15

Push buttons also have status LEDs which can be configured to indicate state of the operation that is configured.

2.2.2 Thermostat > Push Button 1

General	Push Button Function	Switch
Rocker 1	Command On Press	Toggle
Push Button 1	Command On Release	No Command
Push Button 2	Function Of LED	Status Indication
	Separate Comm Object	<input type="radio"/> Enable <input checked="" type="radio"/> Disable

4.2.2.1 Switch

Selecting "Switch" as "Push Button Function" enables to send 1 bit On(1)/Off(0) telegrams to the group address that is linked to respective communication object. Pressing and releasing buttons can be assigned to different commands (On, Off, Toggle and No Command). Status LEDs can be configured to notify the

current status of operation directly with buttons or using communication objects for confirmation to show current status.

4.2.2.1.1 Parameters

Parameter	Setting	Description
Command on Press	On/Off/Toggle/ No command	Selects button function when button pressed.
Command on Release	On/Off/Toggle/ No command	Selects button function when button released.
Function of LED	LED permanently Off	LED always Off
	LED permanently On	LED always On
	Status Indication	Last transmitted command “on” -> LED on Last transmitted command “off” -> LED off If “Separate Comm Object” enabled, status LEDs will wait for confirmation before changing status.
	Inverted Status Indication	Last transmitted command “on” -> LED off Last transmitted command “off” -> LED on If “Separate Comm Object” enabled, status LEDs will wait for confirmation before changing status.
	Operation Indication	Status LED of the pressed push button will be on for the time period selected at “Light Duration of LED” parameter at “General” tab. Last transmitted command value has no effect to the status led operation.
Separate Comm Object	Enable/ Disable	Only visible when “Function of LED” selected as “Status Indication” or “Inverted Status Indication”. This communication objects is the input of confirmation for status LEDs. If selected “Enable” respective communication object should be linked to an appropriate group address.

Table 16

4.2.2.1.2 Communication Objects

No	Object Name	Function	Data Type	Flags
1	Button 1	switch	1 bit DPT 1.001	CWT
On/Off telegrams will be send to group address that is linked to this communication object.				
3	Button 1	Status Comm.Obj.	1 bit DPT 1.002	CWT
Confirmation for On/Off switch telegrams will be received from this communication object. If these communications object visible, it must link to an appropriate group address. Otherwise status LEDs will not function correctly. If status confirmation not to be used the communication object should be disabled by “Separate Comm Object” parameter.				

Table 17

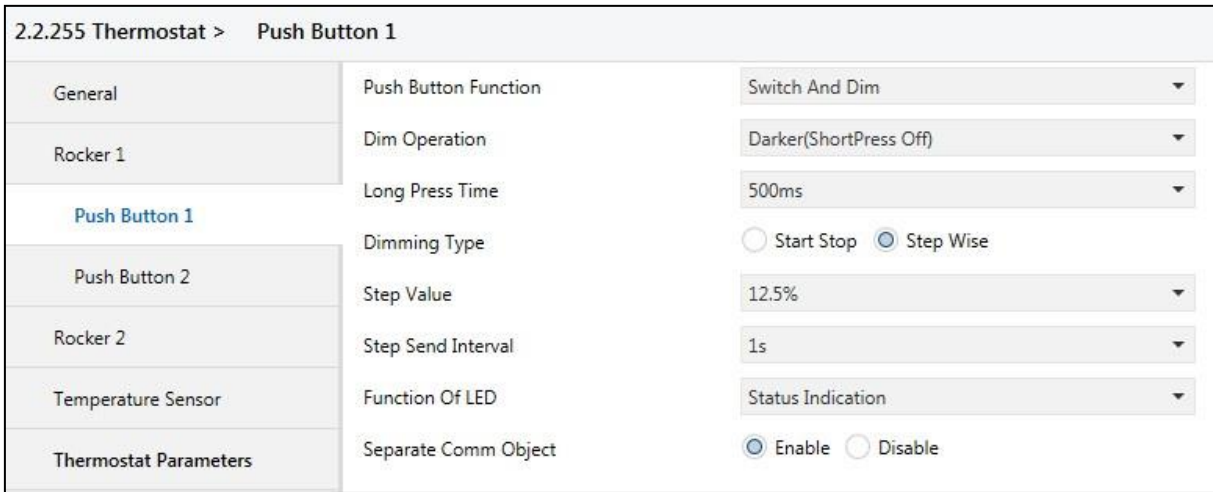

Figure 9

When push button function selected as “Switch and Dim” push button can be configured in three different ways to control brightness value.

	Short Press	Long press
Darker(Short Press Off)	Off (%0)	Decrease, (%XX)
Brighter(Short Press On)	On(%100)	Increase,(%XX)
Darker/Brighter(Short Press Toggle)	Toggle between Darker/Brighter	Decrease,(%XX)/ Increase,(%XX)

Table 18

%XX values can have different values relative to the “Dimming Type” parameter. “Dimming Type” parameter allows two different types of dimming functionality “Start Stop” and “Step Wise”.

Dimming - Start Stop Type

When push button pressed (and not released) and pressed duration exceeds “Long Press Duration” time “Increase, %100” (When button in Brighter mode) or “Decrease, %100” (When button in Darker mode) dimming level will be send using respective communication object. When button released “Increase, Break” or “Decrease, Break” value will be sent.

Dimming - Step Wise Type

When push button pressed (and not released) and pressed duration exceeds “Long Press Duration” time, a step value level configured in “Step Value” parameter will be send using respective communication object. If button mode is “Darker”, “Decrease, % [Step Value]”, else button mode is “Brighter”, “Increase, % [Step Value]” values will be send. Until button is released same step value will be send periodically with a time interval defined in “Step Send Interval”.

4.2.2.2.1 Parameters

Parameter	Setting	Description
-----------	---------	-------------

Dim Operation	Darker(Short Press Off) Brighter(Short Press On) Darker/Brighter (Short Press Toggle)	Select push button dim operation. (For more information Chapter 4.2.2.2)
Long Press Time	300ms/400ms/500ms/600ms/800ms/ 1s /1.2s/1.5s/2s/3s/4s/5s/6s/7s / 8s / 9s / 10s	Time interval to switch from “switch/toggle mode” to “dimming mode”.
Dimming Type	Start Stop / Step Wise	Select dimming type. (For more information Chapter 4.2.2.2)
Step Value	%100 / %50 / %25 / %12.5 / %6.25 / %3.13 / % 1.56	Visible when dimming type is Step Wise. Selects the dimming resolution that will be sending at every “Step Send Interval”.
Step Send Interval	300ms/400ms/500ms/600ms/800ms/ 1s /1.2s/1.5s/2s/3s/4s/5s/6s/7s / 8s / 9s / 10s	Visible when dimming type is Step Wise. Selects the time interval to send dimming increase/decrease values
Function of LED	LED Permanently Off	LED always off
	LED Permanently On	LED always on
	Status Indication	Last transmitted command “on” -> LED on Last transmitted command “off” -> LED off If “Separate Comm Object” enabled, status LEDs will wait for confirmation before changing status.
	Inverted Status Indication	Last transmitted command “on” -> LED off Last transmitted command “off” -> LED on If “Separate Comm Object” enabled, status LEDs will wait for confirmation before changing status.
	Operation Indication	Status LED of the pressed push button will be on for the time period selected at “Light Duration of LED” parameter at “General” tab.
Separate Comm Object	Enable / Disable	Only visible when “Function of LED” selected as “Status Indication” or “Inverted Status Indication”. This communication objects is the input of confirmation for status LEDs. If selected “Enable” respective communication object should be linked to an appropriate group address.

Table 19

4.2.2.2.2 Communication Objects

No	Object Name	Function	Data type	Flags
1	Button 1 – switch	On/Off	1 bit DPT 1.001	CWT
On/Off telegrams will be send to group address that is linked to this communication object.				
2	Button 1 – dimming	Dim	4 bit DPT 3.007	CWT
Dimming values will be send to group address that is linked to this communication object.				
3	Button 1-Status Comm.Obj.	On/Off	1 bit DPT 1.002	CWT

Confirmation for On/Off switch telegrams will be received from this communication object. If these communications object visible, it must link to an appropriate group address. Otherwise status LEDs will not function correctly. If status confirmation not to be used the communication object should be disabled by "Separate Comm Object" parameter.

Table 20

4.2.2.3 Shutter

2.2.255 Thermostat > Push Button 1		
General	Push Button Function	Shutter
Rocker 1	Button Function	Up
Push Button 1	Control Type	<input checked="" type="radio"/> Shutter/Venetian blind <input type="radio"/> Blind/Roller/Awning
Push Button 2	Function Of LED	Status Indication
Rocker 2	Long Press Duration	300ms
	Long Press --> Up/Down, Short Press --> Stop/Lamella Adj.	

Figure 10

Selecting "Shutter" for "Push Button Function" enables shutter operation for push buttons. Shutter functions can be configured to control two different shutter operations "Shutter/Venetian Blind" function or "Blind/Roller/Awning" function. In both functions push button can be configured as 3 different button function; Up, Down and Toggle. When push button selected as up or down, that button can only move the blind and lamella to the configured direction. For example, if configured as up button, push button can be used to move the blind up and adjust the lamella down. If push button configured as toggle button, single button can be used to move the blind up – down and adjust lamella up – down.

Shutter/Venetian Blind Function

When "Controller Type" configured as "Shutter/Venetian Blind", lamella operations of blind control will be enabled as "short press" function of the push button. Also, "Button Function" parameter enables the use of push button 3 different ways;

Up: "Long Press" moves the blind upwards; "Short Press" operates two different ways, short pressed while the blind is moving, stops the blind, short pressed while the blind is not moving adjust the lamella position down.

Down: “Long Press” moves the blind downwards; “Short Press” operates two different ways, short pressed while the blind is moving, stops the blind, short pressed while the blind is not moving adjust the lamella position up.

Toggle: “Long Press” moves the blind upwards or downwards toggling the last “Long Press” action. For example, if last state was up, when push button long pressed, it will send “Down” telegram. Every time push button long pressed it will toggle its last state. If push button short pressed while the blind is moving upward or downward “Short Press” will stop the blind, if the blind is not moving “Short Press” will adjust the lamella. Lamella adjustment will operate respective to the last state, for example if the last “Long Press” action was up, then lamella will be adjusted down when push button short pressed and if the last “Long Press” action was down, then lamella will be adjusted up when push button short pressed.

Blind/Roller/Awning Function

When “Controller Type” configured as “Blind/Roller/Awning Function” lamella operations of blind control will be disabled and “short press” will only stop the movement of the blind. “Button Function” parameter enables the use of push button 3 different ways;

Up: “Long Press” moves the blind upwards; “Short Press” stops the blind.

Down: “Long Press” moves the blind downwards; “Short Press” stops the blind.

Toggle: “Long Press” action moves the blind upwards or downwards toggling the last “Long Press” action. For example, if last state was up, when push button long pressed it will send “Down” telegram.

Every time push button long pressed it will toggle its last state. “Short Press” stops the blind whether it’s moving upwards or downwards

4.2.2.3.1 Parameters

Parameter	Setting	Description
Push Button Function	Up / Down / Toggle	Chapter 4.2.2.3
Control Type	Shutter/Venetian Blind Blind/Roller/Awning	Selects control type of blinds. Shutter/Venetian Blind function includes “Lamella Control” and Blind/Roller/Awningfunction does not include “Lamella Control”.
Function of LED	LED Permanently Off	LED always off
	LED Permanently On	LED always on

	Status Indication	Visualize blind's state using status LEDs of up and down buttons. *[6]
	Operation Indication	Status LED of the pressed rocker button will be on for the time period selected at "Light Duration of LED" parameter at "General" tab.
Long Press Duration	300ms / 400ms/ 500ms/ 600ms/ 800ms/ 1s/ 1.2s/ 1.5s/ 2s/ 3s/ 4s/ 5s/ 6s/ 7s/ 8s/ 9s/ 10s	Time interval to switch from short press to long press

Table 21

4.2.2.3.2 Communication Objects

*[6] LED Function – Status Indication

Status indication operates the same way for "Shutter/Venetian Blind" and "Blind/Roller/Awning". LEDs status respective to blind's state and "Button Function" configuration given below;

	Up Mode	Down Mode	Toggle Mode
Moving upward	Blink	Off	Blink
Moving downward	Off	Blink	Blink
At top position	Off	Off	Off
At bottom position	Off	Off	Off
Stop between top - bottom	Off	Off	Off

Table 22

When "Function of Led" selected as "Status Indication", "Top Position" and "Bottom Position" communication objects given below must be linked to the appropriate group addresses for the LEDs to function correctly.

4.2.2.4 Value Operation

--- Tx Thermostat > Button 1

General	Button Function	Value Operation
Rocker 1	Function Of LED	LED Permanently Off
Button 1	Data Type	1-bit value
Button 2	Value	<input checked="" type="radio"/> 0 <input type="radio"/> 1
Rocker 2	Long Press Request	<input type="radio"/> Yes <input checked="" type="radio"/> No
Temperature Sensor		

Figure 11

Push button can be configured to send predefined values from different data types. Additionally, a long press request can be enabled to be used as a secondary value operation.

Parameter	Setting	Description
Function of Led	LED Permanently Off	LED always off
	LED Permanently On	LED always on
	Operation Indication	Status LED of the pressed rocker button will be on for the time period selected at "Light Duration of LED" parameter at "General" tab.
Data Type	No Reaction	Select data type.
	1-bit value	
	1-byte value [0...255]	
	1-byte percent value [0%...100%]	
	2-byte value [-32768...32767]	
	2-byte value [0...65535]	
	4-byte value [float value]	
	4-byte value [0...4294967295]	
Value	0/1	Visible when "Data Type" selected as "1-bit value".
Value	0...255	Visible when "Data Type" selected as "1-byte value [0...255]".
Value	0...80...100	Visible when "Data Type" selected as "1-byte percent value [0%...100%]".
Value	-32768...0...32767	Visible when "Data Type" selected as "2-byte value [-32768...32767]".
Value	0...65535	Visible when "Data Type" selected as "2-byte value [0...65535]".
Integer Part	-128...0...127	Visible when "Data Type" selected as "4-byte value [float value]".
Fractional Part	0...99	Visible when "Data Type" selected as "4-byte value [float value]".
Value	0...4294967295	Visible when "Data Type" selected as "4-byte value [0...4294967295]".

Parameter	Setting	Description
Long Press Request	No / Yes	Enable/Disable long press duration
Long Press Duration	1s / 1.5s / 2s / 3s / 5s	Select time period for long press operation.
Long Press Data Type	No Reaction	Select data type.
	1-bit value	
	1-byte value [0...255]	
	1-byte percent value [0%...100%]	
	2-byte value [-32768...32767]	
	2-byte value [0...65535]	
	4-byte value [float value]	
	4-byte value [0...4294967295]	
Value	0/1	Visible when "Long Press Data Type" selected as "1-bit value".
Value	0...255	Visible when "Long Press Data Type" selected as "1-byte value [0...255]".
Value	0...80...100	Visible when "Long Press Data Type" selected as "1-byte percent value [0%...100%]".
Value	-32768...0...32767	Visible when "Long Press Data Type" selected as "2-byte value [-32768...32767]".
Value	0...65535	Visible when "Long Press Data Type" selected as "2-byte value [0...65535]".
Integer Part	-128...0...127	Visible when "Long Press Data Type" selected as "4-byte value [float value]".
Fractional Part	0...99	Visible when "Long Press Data Type" selected as "4-byte value [float value]".
Value	0...4294967295	Visible when "Long Press Data Type" selected as "4-byte value [0...4294967295]".

Table 23

4.3 Temperature Sensor

Temperature sensor and temperature status parameters should be configured from “Temperature Sensor” tab.

TTx Thermostat > Temperature Sensor

General	Temperature Unit	<input checked="" type="radio"/> Celsius (°C) <input type="radio"/> Fahrenheit (°F)
Rocker 1	Internal Sensor Offset	0 x0.1K
Button 1	Send Temperature	<input type="radio"/> Cyclic <input checked="" type="radio"/> Cyclic and Change
Button 2	Cyclic Sending Interval	30 s
Rocker 2	Minimum Change	1 x0.1K
Temperature Sensor		
Thermostat Parameters	TEMPERATURE REFERENCE	Temperature Measurement: Internal Sensor
Heating Control	SPOT TEMPERATURE PROTECTION	Spot Temperature Sensor: <input type="checkbox"/>
Additional Heating Control		

Figure 12

4.3.1 Parameters

Parameter	Function	Description
Temperature Unit	Celsius(°C) / Fahrenheit(°F)	Select temperature unit. After selection all temperature related parameters and communication objects should be enter as selected unit.
Internal Sensor Offset	-128... 0 ...127 (x0.1K)	Offset value entered here will be added to measured temperature. It can be used to compensate for temperature difference caused by thermostat placement. Entered value will be multiplied with 0.1
Send Temperature	Cyclic / Cyclic and Change	Selects whether temperature will be sent periodically or periodically and in case of a change in temperature. Minimum change value defined in “Minimum Difference” parameter.

Parameter	Function	Description
Cyclic Sending Interval	10... 30 ...65535 s	Cyclic time period to send temperature from "Current Temperature" communication object.
Minimum Change	1...255 (0.1K)	Only visible if "Send Temperature" selected as "Cyclic and Change". Selects minimum change in temperature that will trigger transmission of temperature.
Temperature Measurement	Internal Sensor	Temperature info can be taken from internal, external KNX temp sensor or weighted average of both sensors. If External or Weighted is selected, " <i>External Temperature Sensor</i> " group object will be appeared.
	External Sensor	
	Weighted Average	
External Sensor Temp. Unit	Celsius	External sensor temp unit can be set as desired. If the "Same" is selected, the temp unit will be the same as well as Main Temperature Unit.
	Fahrenheit	
	Same	
External Sensor Monitoring Timeout	15... 30 ...65535 s	If "External Temperature Sensor" object value has not been updated at the end of the monitoring timeout, the temperature reading will fallback to Internal Sensor.
External Sensor Weight	1... 50 ...99 %	This parameter appears when the Temperature Measurement is selected as "Weighted Average". In this case, External Temperature value weightness can be selected. For e.g. Weight is 20% , Internal Sensor is 24°C and External Sensor is 26°C. The result will be = $(24 \times 0.8) + (26 \times 0.2) = \mathbf{24.4^{\circ}\text{C}}$
Temperature Shown on LCD	Internal Sensor	This parameter allows to show current temperature from Internal or External Sensor on LCD Screen
	External Sensor	
Temperature Shown on KNX	Internal Sensor	This parameter allows to show current temperature from Internal or External Sensor via KNX object "Current Temperature."
	External Sensor	
Spot Temperature Sensor	changed / unchanged	This parameters allows the limit the room temperature via using an external KNX Temperature sensor. It is using for heat / cool protection. When the heat or cool limit temperature is reached, the thermostat controller output will be set to zero. When this parameter is activated, a " <i>Spot Temperature Sensor</i> " object will be appeared.
Sensor Temp. Unit	Celsius	

Parameter	Function	Description
	Fahrenheit	Spot sensor temp unit can be set as desired. If the “Same” is selected, the temp unit will be the same as well as Main Temperature Unit.
	Same	
Heat Limit Temperature	0... 28 ...255 K	Heat Protection Value of Spot Temperature Sensor
Cool Limit Temperature	0... 18 ...255 K	Cool Protection Value of Spot Temperature Sensor
Limit Protection Deactivation Hysteresis	1... 20 ...255 x0.1K	This parameter determines the heat/cool limit deactivation hysteresis levels.It prevents switching between protection and regular mode due to small temperature changes.
Limit Protection Activation Delay	0 ...65535 s	This parameter determines the switching delay to protection mode when the limit reached. It prevents switching between protection and regular mode due to limit temperature reaching for a short time.
Monitoring Timeout	15... 60 ...65535 s	If “SpotTemperature Sensor” object value has not been updated at the end of the monitoring timeout, the temperature reading will fallback to Internal Sensor.

Table 24

4.3.2 Communication Objects

No	Object name	Function	Data Type	Flags
55	Current Temperature (°C)	Temperature	2 byte DPT 9.001	CRT
	Current Temperature (°F)	Temperature	2 byte DPT 9.027	CRT
Communication objects DPT should be decided according to the selected temperature unit. Temperature telegrams will be sent when a temperature change defined at “Minimum Difference” parameter occurs or cyclic time period overflows.				
71	External Temperature Sensor (°C)	Temperature	2 byte	CW

			DPT 9.001	
	External Temperature Sensor (°F)	Temperature	2 byte DPT 9.027	CW
External temperature sensor writing objects.				
72	Spot Temperature Sensor (°C)	Temperature	2 byte DPT 9.001	CW
	Spot Temperature Sensor (°F)	Temperature	2 byte DPT 9.027	CW
Spot temperature sensor writing objects.				

Table 25

4.4 Thermostat

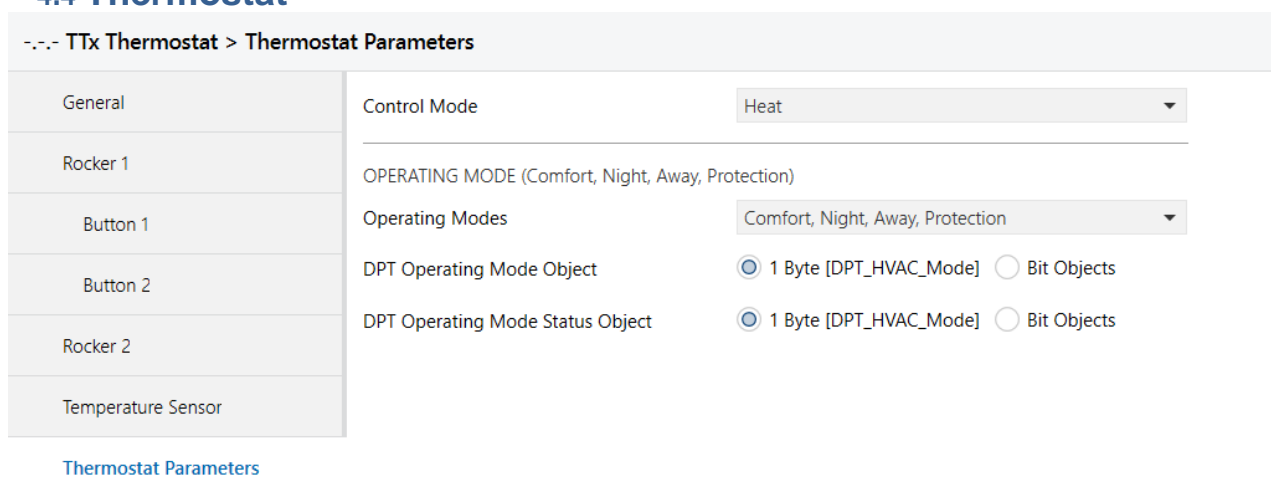

Figure 13

Parameters related to thermostat control should be configured in this tab. Whether thermostat will be used for heating, cooling or both and heating, cooling or both with additional stage should be

selected here. When any control is activated a new tab will be open under “Thermostat Parameters” tab. Controller operation should be configured in respective tabs for heating, cooling and if enabled fan control. When control mode selected as “Heat/Cool”, configuration parameters for switchover (transition from heating to cooling or vice versa) conditions should be entered here.

4.4.1 Parameters

Parameter	Setting	Description
Control Mode	Heat Cool Heat/Cool Heat with Additional Stage Cool with Additional Stage Heat/Cool with Heat Additional Stage Heat/Cool with Cool Additional Stage Heat/Cool with Heat/Cool Additional Stage	This parameter allows to choose the control mode of thermostat which is used for heating only, cooling only or both and heating, cooling or both with additional stages.
Control Objects of Main Stage	Seperate / Joint	Only visible when “Control Mode” is “Heat/Cool” or “Heat/Cool w/Additional Stage”. This parameters allows to choose the control objects of Main Stage are merged or not.
Control Objects of Additional Stage	Seperate / Joint	Only visible when “Control Mode” is “Heat/Cool with Heat/Cool Additional Stage”. This parameters allows to choose the control objects of Additional Stage are merged or not.
Control Mode (Heat, Cool, Heat/Cool)		
Switchover Method	Automatic Manual (via Object) Manual (Local and via Object)	Selects whether control mode switchover will be controlled by thermostat or controlled manually using related communication object or local button.
Heat/Cool Switchover Hysteresis (+/-)	5... 15 ...255 x0.1K	This parameter allows to set Temperature difference between ambient temperature and setpoint temperature to change Control mode. When the difference value is reached, the control mode will be changed automatically (if control mode switchover is automatic) or Heating or Cooling control will be shut down until the Control Mode change manually.
DPT Switchover Object	1 Bit [DPT_Heat/Cool] 1 Byte [DPT_HVAC_Control_Mode]	Selects the control mode switchover communication object type.
Switchover Cyclic Sending Interval	1... 5 ...255 min	Selects cyclic time period (in minutes) to transmit control mode switchover object.
Operating Mode (Comfort, Night, Away, Protect)		

Parameter	Setting	Description
Operating Modes	Comfort Comfort, Protection Comfort, Night, Protection Comfort, Night, Away, Protection	This parameter allows to select Operating Modes.
DPT Operating Mode Object	1 Byte [DPT_HVAC_Mode] Bit Objects	Selects the data type for operating mode switchover communication objects type.
DPT Operating Mode Status Object	1 Byte [DPT_HVAC_Mode] Bit Objects	Selects the data type for operating mode status communication objects type.

Table 26

4.4.2 Communication Objects

No	Object Name	Function	Data Type	Flags
57	Operating Mode	Select Operating Mode	1 byte DPT 5.011	CW
	Comfort mode	Enable	1 bit DPT 1.003	CW
58	Night Mode	Enable	1 bit DPT 1.003	CW
59	Away Mode	Enable	1 bit DPT 1.003	CW
60	Protect Mode	Enable	1 bit DPT 1.003	CW
<p>“Operating Mode” is visible when “Switchover Comm Object Type” is “1 byte”. Values for enabling different operating modes;</p> <p>0: Comfort Mode, 1: Night Mode, 2: Away Mode, 3: Protect Mode.</p>				
<p>“Comfort Mode”, “Night Mode”, “Away Mode” and “Protect Mode” are visible when “Switchover Comm Object Type” is “Bit Objects”. Sending “True (1)” to this communication objects enables respective operating mode.</p>				
63	Switchover	Control Mode	1 bit DPT 1.100	CRWT
	Switchover	Control Mode Status	1 bit DPT 1.100	CRT

	Switchover	Control Mode	1 byte DPT 20.105	CRWT
	Switchover	Control Mode Status	1 byte DPT 20.105	CRT
64	Switchover	Status Control Mode (0=Cooling, 1=Heating)	1 bit DPT 1.100	CRT
<p>When “Switchover Type” is “Automatic” acts as a status communication object and sends current control mode telegram from this communication object.</p> <p>When “Switchover Type” is “Manual (via Object)” acts as a control communication object and current control mode can be changed using this communication object.</p>				
74	Status Operating Mode	Operating Mode Status	1 byte DPT 5.010	CRT
	Status Comfort	Enabled	1 bit DPT 1.002	CRT
75	Status Night	Enabled	1 bit DPT 1.002	CRT
76	Status Away	Enabled	1 bit DPT 1.002	CRT
77	Status Protect	Enabled	1 bit DPT 1.002	CRT
<p>“Status Operating Mode” is visible when “Status Comm Object Type” is “1 byte”. Values for different operating modes;</p> <p>0: Comfort Mode, 1: Night Mode, 2: Away Mode, 3: Protect Mode.</p> <p>“Status Comfort”, “Status Night”, “Status Away” and “Status Protect” are visible when “Status Comm Object Type” is “4 bits”. When “Status Comm Object Type” is “4 bits” and an operating mode switchover occurs a “False (0)” telegram will be send from previous operating modes communication object.</p> <p>For example; while in Night mode and “Enable Away Mode” telegram received,</p> <p>Status Night -> False then Status Away -> True</p>				

Table27

4.4.3 Control Types

Thermostat uses 5 different control types; these are PI Continuous, PI-PWM, On/Off, Fan Coil and Split. This control types can be used for Additional Control as well. Operation of every control type will be explained in the following chapters.

	Control Type	Output Type	Fan
PI Continuous	PI	1 byte (%0...%100)	Disabled
PI-PWM	PI	1 bit (On - Off)	Disabled
On/Off	On/Off	1 bit(On - Off)	Disabled
Fan Coil	PI	1 byte (%0...%100)	Enabled
Split	None	None	Enabled

Table 28

4.4.3.1 Main Stages

4.4.3.1.1 PI Continuous

Uses PI algorithm to calculate control signal and 1 byte (%0...%100) floating values as output, PI values should be selected compatible with the room that wants to be controlled. Default values are given for an average room and for different rooms PI values must be readjusted for better performance. As a general rule;

KP value: Changes the speed of the control and decreasing KP value increase the control speed. If given too low might cause overshoot, and given too large cause control to operate too slow.

KI value: More inactive the system smaller KI value should be.

Note finding optimum values for a specific room might require some trial and error. Using default values as a reference point and increase and decreasing these values according to the directions given above might increase controller performance.

4.4.3.1.2 PI PWM

Uses PI algorithm as controller to calculate control signal and 1 bit value as output, since PI algorithm outputs 1 byte floating value PWM method used to realize this output as 1 bit. PWM (Pulse with Modulation) requires a PWM cycle as period and uses control output to calculate duty cycle. For example, PWM cycle: 10 min, PI output: %20, Then an "on" telegram will be send at the beginning of 10 min cycle and "off" telegram at $10 \times 20 / 100 = 2$ min. Note that PI values and PWM cycle should be selected appropriate to room. As a general rule more inactive the system larger the PWM cycle should be.

4.4.3.1.3 On/Off

On/Off controller operate as a simple switch around the given setpoint using hysteresis values.

Hysteresis values prevent the thermostat from oscillation and give larger margin to turning heat or cool on or off. When system is more active hysteresis values should be given larger and more inactive values can be given smaller.

4.4.3.1.4 Fan Coil

Fan coil uses the same control type and same output type as "PI Continuous", only difference fan coil enables "Fan Control" parameters and communication objects

4.4.3.1.5 Split Unit

Split controller does not control directly the split AC, so ambient temperature must be controlled by split AC's controller. Therefore, "Ambient Temperature" and "Setpoint Temperature" of split ACs communication objects should be linked to "Current Temperature" and "Current Setpoint" communication objects. Otherwise, split unit will be unaware of setpoint and ambient temperature and temperature control will not function correctly.

"Split Heat" and "Split Cool" communication objects are given to only to notify the split AC when there is a control mode change (heat - cool). Also, If both heating and cooling controller is configured as "Split Unit", "Split Heat/Cool" communication object can be merged in "Thermostat Parameters" tab via

4.4.3.2 Additional Stages

Additional stages can be combined with 5 different ways which are heating with additional heating, cooling with additional cooling, heat/cool with additional heating, heating/cooling with additional cooling and heating/cooling with additional heating/cooling.

Additional stages can be activated always with main controller stage or difference to setpoint.

4.4.3.2.1 PI Continuous Additional Stage

This control type is the same as PI-Continuous except activation process. The activation process will be explained.

4.4.3.2.2 PI PWM Additional Stage

This control type is the same as PI-PWM except activation process. The activation process will be explained.

4.4.3.2.3 On/Off Additional Stage

This control type is the same as On/Off except activation process. The activation process will be explained.

4.4.3.2.4 Fan coil Additional Stage

This control type is the same as Fan Coil except activation process. The activation process will be explained.

4.4.3.2.5 Split Unit Additional Stage

This control type is the same as Split Unit except activation process. The activation process will be explained.

4.4.4 Heating Control Main Stages

Selection of the heating control type, parameters of the selected control type should be configured here. 5 Heating Control types are available which are PI Continuous, PI PWM, On/Off, FanCoil and Split Unit.

--- TTx Thermostat > Heating Control		
General	Controller Type	PI Continuous
Rocker 1	Control Value	<input checked="" type="radio"/> Normal <input type="radio"/> Inverse
Rocker 2	Sending of Control Value	<input type="radio"/> Cyclic <input checked="" type="radio"/> Cyclic and Change
Temperature Sensor	Cyclic Sending Interval	5 min
Thermostat Parameters	Minimum Change	4 %
Heating Control	Maximum Control Signal	100 %
Setpoints	Minimum Control Signal	5 %
Local Control	Spot Heat Protection	<input type="checkbox"/>
	Controller Algorithm	<input checked="" type="radio"/> PID <input type="radio"/> Alternative PI
	Proportional Band	30 x0.1°C
	Ti	60 min
	Td	0 min

Figure 14

For more information how the PI parameters should be selected Chapter 4.4.3.1.1

Parameter	Setting	Description
Control Value	Normal / Inverse	Invert the output of the controller. For example, if normal output is %80, then inverted output is %20.
Sending of Control Value	Cyclic / Cyclic and Change	Control values will be sent cyclically only or cyclical and "Minimum Change" of heating control value is reached.
Cyclic Sending Interval	1... 5 ...255 min	Time period to send heating control value over "Heating Control Value" communication object.
Minimum Change	1... 4 ...25 %	This parameter appears when the "Sending of Control Value" is selected as "Cyclic and Change". It determines minimum control output change for transmitting the heating control value.
Maximum Control Signal	0... 100 %	Maximum control signal value.
Minimum Control Signal	0 ...100 %	Minimum control signal value
Spot Heat Protection	checked / unchecked	This parameter enables the Heat Protection via using Spot Temperature Sensor. Spot Temperature sensor must be enabled in "Temperature Sensor" page to show this parameter.
Controller Algorithm	PID / Alternative PI	Controller algorithm can be selected via using this parameter.
Proportional Band	1... 30 ...255 x 0.1°C	This parameter shown when the "Controller Algorithm" is selected as "PID"
Ti	0... 60 ...255 min	This parameter shown when the "Controller Algorithm" is selected as "PID"
Td	0 ...255 min	This parameter shown when the "Controller Algorithm" is selected as "PID"
Proportional Gain KP	1... 66 ...255	This parameter shown when the "Controller Algorithm" is selected as "Alternative PI". Proportional gain of PI algorithm
Integral Gain Ki	1... 32 ...255 /1000	This parameter shown when the "Controller Algorithm" is selected as "Alternative PI". Integral gain of PI algorithm, given value divided by 1000.

Parameter	Setting	Description
Reverse Differential Action Band	5...15...255 x 0.1	This parameter shown when the "Controller Algorithm" is selected as "Alternative PI". Reverse Differential Action Band, given value multiplied by 0.1

Table 29

4.4.4.1.2 Communication Objects

No	Object Name	Function	Data Type	Flags
61	Heat Control Value	Send	1 byte DPT 5.001	CT

Heating actuator will be controlled through this communication object.

Table 30

4.4.4.2 PI PWM

TTx Thermostat > Heating Control

General	Controller Type	PI PWM
Rocker 1	Control Value	<input checked="" type="radio"/> Normal <input type="radio"/> Inverse
Rocker 2	Pwm Period	10 min
Temperature Sensor	Signal Minimum Switching Time	0 s
Thermostat Parameters	Maximum Control Signal	100 %
	Minimum Control Signal	5 %
Heating Control	Spot Heat Protection	<input type="checkbox"/>
Setpoints	Controller Algorithm	<input checked="" type="radio"/> PID <input type="radio"/> Alternative PI
Local Control	Proportional Band	30 x0.1°C
	Ti	60 min
	Td	0 min

Figure 15

For more information how the PI parameters and PWM cycle should be selected Chapter 4.4.3.1.2

Parameter	Setting	Description
Control Value	Normal / Inverse	Invert the output of the controller. For example, if normal output is 1, then inverted output is 0.
PWM period	1... 10 ...255 min	This parameter determines PWM period.
Signal Minimum Switching Time	0 ...255 s	This parameter determines additional time for minimum switching time. For e.g. The valve opening delay time can be covered with this parameter.
Maximum Control Signal	0... 100 %	Maximum control signal value.
Minimum Control Signal	0... 5 ...100 %	Minimum control signal value
Spot Heat Protection	checked / unchecked	This parameter enables the Heat Protection via using Spot Temperature Sensor. Spot Temperature sensor must be enabled in "Temperature Sensor" page to show this parameter.
Controller Algorithm	PID / Alternative PI	Controller algorithm can be selected via using this parameter.
Proportional Band	1... 30 ...255 x 0.1°C	This parameter shown when the "Controller Algorithm" is selected as "PID"
Ti	0... 60 ...255 min	This parameter shown when the "Controller Algorithm" is selected as "PID"
Td	0 ...255 min	This parameter shown when the "Controller Algorithm" is selected as "PID"
Proportional Gain KP	1... 66 ...255	This parameter shown when the "Controller Algorithm" is selected as "Alternative PI". Proportional gain of PI algorithm
Integral Gain Ki	1... 32 ...255 /1000	This parameter shown when the "Controller Algorithm" is selected as "Alternative PI". Integral gain of PI algorithm, given value divided by 1000.
Reverse Differential Action Band	5... 15 ...255 x 0.1	This parameter shown when the "Controller Algorithm" is selected as "Alternative PI". Reverse Differential Action Band, given value multiplied by 0.1

Table 31



*[4] "PWM Cycle" and "Minimum Control Signal" parameters should be configured considering the limitations of the actuator. For example; when actuator is Solenoid valve with a response time of 120 seconds,

- PWM cycle configured as 10 minutes (Chapter 4.4.3.1.2)
- "Minimum Control Signal" should be bigger than $120 \cdot 100 / (10 \cdot 60) = \%20$
- PWM cycle configured as 20 minutes
- "Minimum Control Signal" should be bigger than $120 \cdot 100 / (20 \cdot 60) = \%10$

4.4.4.2.2 Communication Objects

No	Object Name	Function	Data Type	Flags
61	Heat Control Value	Send	1 bit DPT 1.002	CT
Heating actuator will be controlled through this communication object.				

Table 32

4.4.4.3 On/Off

TTx Thermostat > Heating Control

General	Controller Type	On / Off
Rocker 1	Control Value	<input checked="" type="radio"/> Normal <input type="radio"/> Inverse
Rocker 2	Cyclic Sending Interval	5 min
Temperature Sensor	Hysteresis (+/-)	10 x0.1K
Thermostat Parameters	Spot Heat Protection	<input type="checkbox"/>

Figure 16

Heating control parameters for on/off controller type should be configured here. For more information about on/off controller read Chapter 4.4.3.1.3.

Parameter	Setting	Description
Control Value	Normal / Inverse	Invert the output of the controller. For example, if normal output is 1, then inverted output is 0.
Cyclic Sending Interval	1...5...255	Time period to send heating control value over "Heating Control Value" communication object.
Hysteresis (1/10 K)	1...10...255	Hysteresis value (Chapter 4.4.3.1.3)
Spot Heat Protection	checked / unchecked	This parameter enables the Heat Protection via using Spot Temperature Sensor. Spot Temperature sensor must be enabled in "Temperature Sensor" page to show this parameter.

Table 33

4.4.4.3.2 Communication Objects

No	Object Name	Function	Data Type	Flags
61	Heat Control Value	Send	1 bit DPT 1.002	CT

Heating actuator will be controlled through this communication object.

Table 34

4.4.4.4 Fan Coil

--- TTx Thermostat > Heating Control

General	Controller Type	Fan Coil
Rocker 1	Control Value	<input checked="" type="radio"/> Normal <input type="radio"/> Inverse
Rocker 2	Sending of Control Value	<input type="radio"/> Cyclic <input checked="" type="radio"/> Cyclic and Change
Temperature Sensor	Cyclic Sending Interval	5 min
Thermostat Parameters	Minimum Change	4 %
	Maximum Control Signal	100 %
	Minimum Control Signal	5 %
Heating Control	Spot Heat Protection	<input type="checkbox"/>
Fan Control	Controller Algorithm	<input checked="" type="radio"/> PID <input type="radio"/> Alternative PI
Setpoints	Proportional Band	30 x0.1°C
Local Control	Ti	60 min
	Td	0 min

Figure 17

Heating control parameters for fan coil controller type should be configured here. For more information about on/off controller read Chapter 4.4.3.1.4.

Parameter	Setting	Description
Control Value	Normal / Inverse	Invert the output of the controller. For example, if normal output is %80, then inverted output is %20.
Sending of Control Value	Cyclic / Cyclic and Change	Control values will be sent cyclically only or cyclical and "Minimum Change" of heating control value is reached.
Cyclic Sending Interval	1... 5 ...255 min	Time period to send heating control value over "Heating Control Value" communication object.
Minimum Change	1... 4 ...25 %	This parameter appears when the "Sending of Control Value" is selected as "Cyclic and Change". It determines minimum control output change for transmitting the heating control value.
Maximum Control Signal	0... 100 %	Maximum control signal value.
Minimum Control Signal	0 ...100 %	Minimum control signal value
Spot Heat Protection	checked / unchecked	This parameter enables the Heat Protection via using Spot Temperature Sensor. Spot Temperature sensor must be enabled in "Temperature Sensor" page to show this parameter.
Controller Algorithm	PID / Alternative PI	Controller algorithm can be selected via using this parameter.
Proportional Band	1... 30 ...255 x 0.1°C	This parameter shown when the "Controller Algorithm" is selected as "PID"
Ti	0... 60 ...255 min	This parameter shown when the "Controller Algorithm" is selected as "PID"
Td	0 ...255 min	This parameter shown when the "Controller Algorithm" is selected as "PID"
Proportional Gain KP	1... 66 ...255	This parameter shown when the "Controller Algorithm" is selected as "Alternative PI". Proportional gain of PI algorithm
Integral Gain Ki	1... 32 ...255 /1000	This parameter shown when the "Controller Algorithm" is selected as "Alternative PI". Integral gain of PI algorithm, given value divided by 1000.

Parameter	Setting	Description
Reverse Differential Action Band	5... 15 ...255 x 0.1	This parameter shown when the "Controller Algorithm" is selected as "Alternative PI". Reverse Differential Action Band, given value multiplied by 0.1

Table 35

4.4.4.4.2 Communication Objects

No	Object Name	Function	Data Type	Flags
61	Heat Control Value	Send	1 byte DPT 5.001	CT

Heating actuator will be controlled through this communication object.

Table 36

4.4.4.5 Split Unit

--- TTx Thermostat > Heating Control

General	Controller Type	Split Unit
Rocker 1	Cyclic Sending Interval	5 min
Rocker 2	Communication Error Object	<input type="radio"/> Enable <input checked="" type="radio"/> Disable
Temperature Sensor	Spot Heat Protection	<input type="checkbox"/>

Figure 18

Split unit controller does not directly control temperature, since temperature control is split unit's responsibility. "Current Temperature" and "Current Setpoint" communication objects should be linked to split units "Ambient Temperature" and "Setpoint Temperature" communication objects.

4.4.4.5.1 Parameters

Parameter	Setting	Description
Cyclic Sending Interval	1... 5 ...255 min	Time period to send heating control value over "Heating Control Value" communication object.
Communication Error Object	Enable / Disable	Enables "Split Heat Error" communication object. "True" telegram from this communication objects cause thermostat to enter "Protection Mode" with error. (For more information Chapter 4.5.2)
Spot Heat Protection	checked / unchecked	This parameter enables the Heat Protection via using Spot Temperature Sensor. Spot Temperature sensor must be enabled in "Temperature Sensor" page to show this parameter.

Table 37

4.4.4.5.2 Communication Objects

No	Object Name	Function	Data Type	Flags
51	Split Heat	On/Off	1 bit DPT 1.001	CT
Visible if "Send On/Off at Control Mode Switchover" parameter enabled. This communication object is not a control object, it will send "True" when control mode is "Heat" and "False" when control mode is "Cool" and can be used to enable the split unit.				
53	Split Heat Error	True/False	1 bit DPT 1.002	CW
Visible if "Communication Error Object" parameter enabled. "True" telegram causes the thermostat to enter "Protect Mode wit Error" and thermostat stay in this state until "False" telegram received (For more information Chapter 4.5.2).				

Table 38

4.4.5 Heating Control Additional Stages

Selection of the additional heating control type, parameters of the selected control type should be configured here.

5 Additional Heating Control types are available which are PI Continuous, PI PWM, On/Off, FanCoil and Split Unit.

4.4.5.1 PI Continuous

TTx Thermostat > Additional Heating Control

General	Controller Type	PI Continuous
Rocker 1	Control Value	<input checked="" type="radio"/> Normal <input type="radio"/> Inverse
Rocker 2	Sending of Control Value	<input type="radio"/> Cyclic <input checked="" type="radio"/> Cyclic and Change
Temperature Sensor	Cyclic Sending Interval	5 min
Thermostat Parameters	Minimum Change	4 %
Heating Control	Maximum Control Signal	100 %
	Minimum Control Signal	5 %
	Spot Heat Protection	<input type="checkbox"/>
	Controller Algorithm	<input checked="" type="radio"/> PID <input type="radio"/> Alternative PI
	Proportional Band	30 x0.1°C
	Ti	60 min
	Td	0 min
	Additional Stage Activation	<input type="radio"/> Always <input checked="" type="radio"/> On Difference to Setpoint
	Activation Difference (Away from Setpoint)	40 x0.1K
	Deactivation Difference (Close to Setpoint)	10 x0.1K
	Controller Algorithm Hysteresis Override	<input type="checkbox"/>

Figure 14

For more information how the PI parameters should be selected Chapter 4.4.3.1.1

Parameter	Setting	Description
Control Value	Normal / Inverse	Invert the output of the controller. For example, if normal output is %80, then inverted output is %20.
Sending of Control Value	Cyclic / Cyclic and Change	Control values will be sent cyclically only or cyclical and "Minimum Change" of heating control value is reached.
Cyclic Sending Interval	1... 5 ...255 min	Time period to send heating control value over "Heating Control Value" communication object.
Minimum Change	1... 4 ...25 %	This parameter appears when the "Sending of Control Value" is selected as "Cyclic and Change". It determines minimum control output change for transmitting the heating control value.
Maximum Control Signal	0... 100 %	Maximum control signal value.
Minimum Control Signal	0 ...100 %	Minimum control signal value
Spot Heat Protection	checked / unchecked	This parameter enables the Heat Protection via using Spot Temperature Sensor. Spot Temperature sensor must be enabled in "Temperature Sensor" page to show this parameter.
Controller Algorithm	PID / Alternative PI / Disabled	Controller algorithm can be selected via using this parameter.
Proportional Band	1... 30 ...255 x 0.1°C	This parameter shown when the "Controller Algorithm" is selected as "PID"
Ti	0... 60 ...255 min	This parameter shown when the "Controller Algorithm" is selected as "PID"
Td	0 ...255 min	This parameter shown when the "Controller Algorithm" is selected as "PID"
Proportional Gain KP	1... 66 ...255	This parameter shown when the "Controller Algorithm" is selected as "Alternative PI". Proportional gain of PI algorithm
Integral Gain Ki	1... 32 ...255 /1000	This parameter shown when the "Controller Algorithm" is selected as "Alternative PI".

Parameter	Setting	Description
		Integral gain of PI algorithm, given value divided by 1000.
Reverse Differential Action Band	5... 15 ...255 x 0.1	This parameter shown when the "Controller Algorithm" is selected as "Alternative PI". Reverse Differential Action Band, given value multiplied by 0.1
Additional Stage Activation	Always / On Difference to Setpoint	Additional Stage can be activated always or depends to setpoint difference.
Activation Difference (Away from Setpoint)	10... 40 ...255 x 0.1K	Additional stage will be activated depends on temperature difference between current temperature and setpoint. Given value will be multiplied with 0.1
Deactivation Difference (Close to Setpoint)	1... 10 ...255 x 0.1K	Additional stage will be deactivated depends on temperature difference between current temperature and setpoint. Given value will be multiplied with 0.1
Controller Algorithm Hysteresis Override	checked / unchecked	The controller algorithm will be disabled when this parameter is selected. When this parameter is selected, the maximum control signal of additional stage will be applied.

Table 29

4.4.5.1.2 Communication Objects

No	Object Name	Function	Data Type	Flags
51	Additional Heat Control Value	Send	1 byte DPT 5.001	CT
Heating actuator will be controlled through this communication object.				

Table 30

--- TTx Thermostat > **Additional Heating Control**

General	Controller Type	PI PWM
Rocker 1	Control Value	<input checked="" type="radio"/> Normal <input type="radio"/> Inverse
Rocker 2	Pwm Period	10 min
Temperature Sensor	Signal Minimum Switching Time	0 s
Thermostat Parameters	Maximum Control Signal	100 %
Heating Control	Minimum Control Signal	5 %
Additional Heating Control	Spot Heat Protection	<input type="checkbox"/>
Fan Control	Controller Algorithm	<input checked="" type="radio"/> PID <input type="radio"/> Alternative PI
Setpoints	Proportional Band	30 x0.1°C
Local Control	Ti	60 min
	Td	0 min
	Additional Stage Activation	<input type="radio"/> Always <input checked="" type="radio"/> On Difference to Setpoint
	Activation Difference (Away from Setpoint)	40 x0.1K
	Deactivation Difference (Close to Setpoint)	10 x0.1K
	Controller Algorithm Hysteresis Override	<input type="checkbox"/>

Figure 15

For more information how the PI parameters and PWM cycle should be selected Chapter 4.4.3.1.2

4.4.5.2.1 Parameters

Parameter	Setting	Description
Control Value	Normal / Inverse	Invert the output of the controller. For example, if normal output is 1, then inverted output is 0.
PWM period	1... 10 ...255 min	This parameter determines PWM period.
Signal Minimum Switching Time	0 ...255 s	This parameter determines additional time for minimum switching time. For e.g. The valve opening delay time can be covered with this parameter.
Maximum Control Signal	0... 100 %	Maximum control signal value.
Minimum Control Signal	0... 5 ...100 %	Minimum control signal value

Parameter	Setting	Description
Spot Heat Protection	checked / unchecked	This parameter enables the Heat Protection via using Spot Temperature Sensor. Spot Temperature sensor must be enabled in "Temperature Sensor" page to show this parameter.
Controller Algorithm	PID / Alternative PI	Controller algorithm can be selected via using this parameter.
Proportional Band	1... 30 ...255 x 0.1°C	This parameter shown when the "Controller Algorithm" is selected as "PID"
Ti	0... 60 ...255 min	This parameter shown when the "Controller Algorithm" is selected as "PID"
Td	0 ...255 min	This parameter shown when the "Controller Algorithm" is selected as "PID"
Proportional Gain KP	1... 66 ...255	This parameter shown when the "Controller Algorithm" is selected as "Alternative PI". Proportional gain of PI algorithm
Integral Gain Ki	1... 32 ...255 /1000	This parameter shown when the "Controller Algorithm" is selected as "Alternative PI". Integral gain of PI algorithm, given value divided by 1000.
Reverse Differential Action Band	5... 15 ...255 x 0.1	This parameter shown when the "Controller Algorithm" is selected as "Alternative PI". Reverse Differential Action Band, given value multiplied by 0.1
Additional Stage Activation	Always / On Difference to Setpoint	Additional Stage can be activated always or depends to setpoint difference.
Activation Difference (Away from Setpoint)	10... 40 ...255 x 0.1K	Additional stage will be activated depends on temperature difference between current temperature and setpoint. Given value will be multiplied with 0.1

Parameter	Setting	Description
Deactivation Difference (Close to Setpoint)	1... 10 ...255 x 0.1K	Additional stage will be deactivated depends on temperature difference between current temperature and setpoint. Given value will be multiplied with 0.1
Controller Algorithm Hysteresis Override	checked / unchecked	The controller algorithm will be disabled when this parameter is selected. When this parameter is selected, the control signal of additional stage will be "1" during activated.

Table 31

*[4] "PWM Cycle" and "Minimum Control Signal" parameters should be configured considering the limitations of the actuator. For example; when actuator is Solenoid valve with a response time of 120 seconds,

- PWM cycle configured as 10 minutes (Chapter 4.4.3.1.2)
- "Minimum Control Signal" should be bigger than $120 \cdot 100 / (10 \cdot 60) = \%20$
- PWM cycle configured as 20 minutes
- "Minimum Control Signal" should be bigger than $120 \cdot 100 / (20 \cdot 60) = \%10$

4.4.5.2.2 Communication Objects

No	Object Name	Function	Data Type	Flags
51	Additional Heat Control Value	Send	1 bit DPT 1.002	CT

Heating actuator will be controlled through this communication object.

Table 32

--- TTx Thermostat > **Additional Heating Control**

General	Controller Type	On / Off
Rocker 1	Control Value	<input checked="" type="radio"/> Normal <input type="radio"/> Inverse
Rocker 2	Cyclic Sending Interval	5 min
Temperature Sensor	* Additional stage hysteresis is in effect.	
Thermostat Parameters	Spot Heat Protection	<input type="checkbox"/>
Heating Control	Additional Stage Activation	<input type="radio"/> Always <input checked="" type="radio"/> On Difference to Setpoint
Additional Heating Control	Activation Difference (Away from Setpoint)	40 x0.1K
Fan Control	Deactivation Difference (Close to Setpoint)	10 x0.1K

Figure 16

Heating control parameters for on/off controller type should be configured here. For more information about on/off controller read Chapter 4.4.3.1.3.

4.4.5.3.1 Parameters

Parameter	Setting	Description
Control Value	Normal / Inverse	Invert the output of the controller. For example, if normal output is 1, then inverted output is 0.
Cyclic Sending Interval	1... 5 ...255 min	Time period to send heating control value over "Additional Heating Control Value" communication object.
Hysteresis (1/10 K)	1... 10 ...255 x 0.1K	Hysteresis value (Chapter 4.4.3.1.3) This parameter will be enabled If the Additional Stage Activation is selected "Always"
Spot Heat Protection	checked / unchecked	This parameter enables the Heat Protection via using Spot Temperature Sensor. Spot Temperature sensor must be enabled in "Temperature Sensor" page to show this parameter.
Additional Stage Activation	Always / On Difference to Setpoint	Additional Stage can be activated always or depends to setpoint difference.
Activation Difference (Away from Setpoint)	10... 40 ...255 x 0.1K	Additional stage will be activated depends on temperature difference between current temperature and setpoint. Given value will be multiplied with 0.1



Parameter	Setting	Description
Deactivation Difference (Close to Setpoint)	1... 10 ...255 x 0.1K	Additional stage will be deactivated depends on temperature difference between current temperature and setpoint. Given value will be multiplied with 0.1

Table 33

4.4.5.3.2 Communication Objects

No	Object Name	Function	Data Type	Flags
51	Additional Heat Control Value	Send	1 bit DPT 1.002	CT
Heating actuator will be controlled through this communication object.				

Table 34

TTx Thermostat > Additional Heating Control

General	Controller Type	Fan Coil
Rocker 1	Control Value	<input checked="" type="radio"/> Normal <input type="radio"/> Inverse
Rocker 2	Sending of Control Value	<input type="radio"/> Cyclic <input checked="" type="radio"/> Cyclic and Change
Temperature Sensor	Cyclic Sending Interval	5 min
Thermostat Parameters	Minimum Change	4 %
Heating Control	Maximum Control Signal	100 %
	Minimum Control Signal	5 %
Additional Heating Control	Fan Speed	Fan Speed 3
Fan Control	Spot Heat Protection	<input type="checkbox"/>
Setpoints	Controller Algorithm	<input checked="" type="radio"/> PID <input type="radio"/> Alternative PI
Local Control	Proportional Band	30 x0.1°C
	Ti	60 min
	Td	0 min
	Additional Stage Activation	<input type="radio"/> Always <input checked="" type="radio"/> On Difference to Setpoint
	Activation Difference (Away from Setpoint)	40 x0.1K
	Deactivation Difference (Close to Setpoint)	10 x0.1K
	Controller Algorithm Hysteresis Override	<input type="checkbox"/>

Figure 17

Heating control parameters for fan coil controller type should be configured here. For more information about on/off controller read Chapter 4.4.3.1.4.

4.4.5.4.1 Parameters

Parameter	Setting	Description
Control Value	Normal / Inverse	Invert the output of the controller. For example, if normal output is %80, then inverted output is %20.
Control Value	Cyclic / Cyclic and Change	Control values will be sent cyclically only or cyclical and "Minimum Change" of heating control value is reached.
Cyclic Sending Interval	1... 5 ...255 min	Time period to send heating control value over "Heating Control Value" communication object.

Parameter	Setting	Description
Minimum Change	1... 4 ...25 %	This parameter appears when the "Sending of Control Value" is selected as "Cyclic and Change". It determines minimum control output change for transmitting the additional heating control value.
Fan Speed	Auto, Fan Speed 1, 2, 3	Fan Speed of the Additional Fan Coil can be chosen when it is activated.
Maximum Control Signal	0... 100 %	Maximum control signal value.
Minimum Control Signal	0 ...100 %	Minimum control signal value
Spot Heat Protection	checked / unchecked	This parameter enables the Heat Protection via using Spot Temperature Sensor. Spot Temperature sensor must be enabled in "Temperature Sensor" page to show this parameter.
Controller Algorithm	PID / Alternative PI / Disabled	Controller algorithm can be selected via using this parameter.
Proportional Band	1... 30 ...255 x 0.1°C	This parameter shown when the "Controller Algorithm" is selected as "PID"
Ti	0... 60 ...255 min	This parameter shown when the "Controller Algorithm" is selected as "PID"
Td	0 ...255 min	This parameter shown when the "Controller Algorithm" is selected as "PID"
Proportional Gain KP	1... 66 ...255	This parameter shown when the "Controller Algorithm" is selected as "Alternative PI". Proportional gain of PI algorithm
Integral Gain Ki	1... 32 ...255 /1000	This parameter shown when the "Controller Algorithm" is selected as "Alternative PI". Integral gain of PI algorithm, given value divided by 1000.
Reverse Differential Action Band	5... 15 ...255 x 0.1	This parameter shown when the "Controller Algorithm" is selected as "Alternative PI". Reverse Differential Action Band, given value multiplied by 0.1
Additional Stage Activation	Always / On Difference to Setpoint	Additional Stage can be activated always or depends to setpoint difference.

Parameter	Setting	Description
Activation Difference (Away from Setpoint)	10... 40 ...255 x 0.1K	Additional stage will be activated depends on temperature difference between current temperature and setpoint. Given value will be multiplied with 0.1
Deactivation Difference (Close to Setpoint)	1... 10 ...255 x 0.1K	Additional stage will be deactivated depends on temperature difference between current temperature and setpoint. Given value will be multiplied with 0.1
Controller Algorithm Hysteresis Override	checked / unchecked	The controller algorithm will be disabled when this parameter is selected. When this parameter is selected, the control signal of additional stage will be 100% during activated.

Table 35

4.4.5.4.2 Communication Objects

No	Object Name	Function	Data Type	Flags
51	Additional Heat Control Value	Send	1 byte DPT 5.001	CT
Heating actuator will be controlled through this communication object.				

Table 36

4.4.5.5 Split Unit

TTx Thermostat > Additional Heating Control

General	Controller Type	Split Unit
Rocker 1	Cyclic Sending Interval	5 min
Rocker 2	Fan Speed	Fan Speed 3
Temperature Sensor	Spot Heat Protection	<input type="checkbox"/>
Thermostat Parameters	Additional Stage Activation	<input type="radio"/> Always <input checked="" type="radio"/> On Difference to Setpoint
Heating Control	Activation Difference (Away from Setpoint)	40 x0.1K
	Deactivation Difference (Close to Setpoint)	10 x0.1K

Additional Heating Control

Figure 18

Split unit controller does not directly control temperature, since temperature control is split unit's responsibility "Current Temperature" and "Current Setpoint" communication objects should be linked to split units "Ambient Temperature" and "Setpoint Temperature" communication objects.

Parameter	Setting	Description
Cyclic Sending Interval	1... 5 ...255 min	Time period to send heating control value over "Additional Heating Control Value" communication object.
Fan Speed	Auto, Fan Speed 1, 2, 3	Fan Speed of the Additional Fan Coil can be chosen when it is activated.
Spot Heat Protection	checked / unchecked	This parameter enables the Heat Protection via using Spot Temperature Sensor. Spot Temperature sensor must be enabled in "Temperature Sensor" page to show this parameter.
Additional Stage Activation	Always / On Difference to Setpoint	Additional Stage can be activated always or depends to setpoint difference.
Activation Difference (Away from Setpoint)	10... 40 ...255 x 0.1K	Additional stage will be activated depends on temperature difference between current temperature and setpoint. Given value will be multiplied with 0.1
Deactivation Difference (Close to Setpoint)	1... 10 ...255 x 0.1K	Additional stage will be deactivated depends on temperature difference between current temperature and setpoint. Given value will be multiplied with 0.1

Table 37

4.4.5.5.2 *Communication Objects*

No	Object Name	Function	Data Type	Flags
51	Split Heat	On/Off	1 bit DPT 1.001	CT
Visible if "Send On/Off at Control Mode Switchover" parameter enabled. This communication object is not a control object, it will send "True" when control mode is "Heat" and "False" when control mode is "Cool" and can be used to enable the split unit.				

Table 38

4.4.6 Cooling Control Main Stages

Cooling control Main Stage parameters are same as Heating Control Main Stage.

4.4.7 Cooling Control Additional Stages

Cooling control Additional Stage parameters are same as Heating Control Additional Stage.

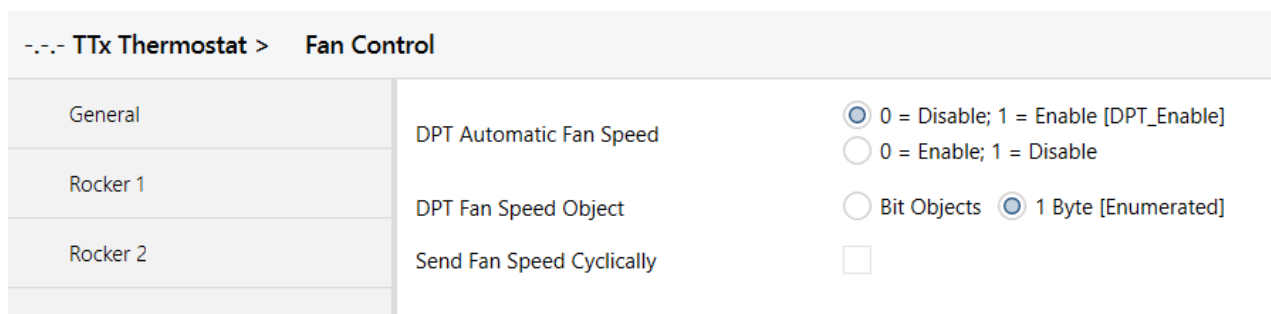

Figure 19

When heating control or cooling control selected as “Fan Coil” or “Split Unit”, “Fan Control” tab will be visible. Note that, if both heat and cool controllers configured as “Fan Coil” or “Split Unit”, only one set of communication objects and parameters for fan control will be enabled.

When fan control enabled, “Fan Speed” parameters of different operating modes in “Setpoints” tab will also be visible and “LCD Fan Speed” icons will be activated. Since fan speed communication objects are used as control objects and status objects, change in fan speed will be visible from LCD Fan Speed icons.

4.4.8.1 Parameter

Parameter	Setting	Description
DPT Automatic Fan Speed	0 = Disable; 1 = Enable [DPT_Enable] 0 = Enable; 1 = Disable	Telegram value to enable automatic fan speed might differ between different actuators; use this parameter to change the telegram value for enabling automatic fan speed.
DPT Fan Speed Object	Bit Objects / 1 Byte [Enumerated]	Selects the data type to control fan speed.
Reset Values of Unselected Fan Objects	Yes / No	This parameter allows to transmit status of unused fan level in every fan speed change.
Additional Method for Turning Off Fan (Fan Coil only)	Disabled Transmit "0" at Fan Speed 1 Transmit "0" at Fan Speed 2 Transmit "0" at Fan Speed 3 Transmit "0" at Fan Speed 1 & 2 & 3	This parameter allows to transmit "0" value for turning off the fan levels.
Send Fan Speed Cyclically	checked / unchecked	This parameter allows to transmit the fan speed status periodically.
Cyclic Sending Interval	1... 5 ...255 min	Time period to send heating control value over “Heating Control Value” communication object.
Also Send Auto-Fan Value	checked / unchecked	This parameter allows to transmit the "Fan Auto" status in every cycle.

Table 39

No	Object Name	Function	Data Type	Flags
65	Fan Speed 0	Send	1 bit DPT 1.002	CT
"1" value will be transmitted from this group object when the fan speed is "0" or OFF.				
66	Automatic Fan Speed	Send	1 bit DPT 1.002	CWT
Automatic fan speed will be enabled/disabled through this communication object. Telegram value to enable automatic fan speed should be selected in "Comm Object Value to Enable Automatic Fan Speed" parameter.				
67	Fan Speed	Send	1 byte DPT 5.010	CWT
	Fan Speed 1	Enable	1 bit DPT 1.002	CWT
"Fan Speed" communication object visible when "Fan Speed Object Type" is "1 byte" and fan speed controlled and status received with given values; 0 = Fan Speed 0, 1 = Fan Speed 1, 2 = Fan Speed 2, 3 = Fan Speed 3				
"Fan Speed 1" communication object visible when "Fan Speed Object Type" is "3 bits" and sending "True" telegram to this communication objects sets fan speed to fan speed 1.				
68	Fan Speed 2	Enable	1 bit DPT 1.002	CWT
"Fan Speed 2" communication object visible when "Fan Speed Object Type" is "3 bits" and sending "True" telegram to this communication objects sets fan speed to fan speed 2.				
69	Fan Speed 3	Enable	1 bit DPT 1.002	CWT
"Fan Speed 3" communication object visible when "Fan Speed Object Type" is "3 bits" and sending "True" telegram to this communication objects sets fan speed to fan speed 3.				

Table 40

TTx Thermostat > Setpoints

General	Send Setpoint	<input type="radio"/> Cyclic <input checked="" type="radio"/> Cyclic and Change
Rocker 1	Cyclic Sending Interval	60 s
Rocker 2	Setpoint Button Step Value	0,5K
Temperature Sensor	Operating Mode Setpoint Objects	<input type="radio"/> Enable <input checked="" type="radio"/> Disable
Thermostat Parameters	SETPOINT LIMITS	
Heating Control	Maximum Setpoint	40 °C
Additional Heating Control	Minimum Setpoint	0 °C
Cooling Control	Setpoint Range Limiting (Mode based)	<input checked="" type="checkbox"/>
Additional Cooling Control	Allowed Range (+/-)	5 K
Fan Control	HEATING & COOLING SETPOINTS	
	Multi Setpoint	<input type="radio"/> Enable <input checked="" type="radio"/> Disable
	RETURN TO ETS PROGRAMMED VALUES	
	After Reset	<input type="radio"/> Yes <input checked="" type="radio"/> No
	After Mode Change	<input type="radio"/> Yes <input checked="" type="radio"/> No
	Reset on Site Object	<input type="radio"/> Yes <input checked="" type="radio"/> No
	COMFORT MODE	
	Setpoint	25 °C
	Fan Speed	Auto
	NIGHT MODE	
	Setpoint	23 °C
	Fan Speed	Auto
	AWAY MODE	
	Setpoint	21 °C
	Fan Speed	Auto
	PROTECTION MODE	
	Heat Protection Limit	40 °C
	Frost Protection Limit	5 °C
	Protection Deactivation Hysteresis	20 x0.1K
	Fan Speed	Fan Speed 3

Setpoints

Local Control	
---------------	--

Figure 25

4.5.1 Parameter



Parameter	Setting	Description
Send Setpoint	Cyclic / Cyclic and Change	Control values will be sent cyclically only or cyclical and "Minimum Change" of heating control value is reached.
Cyclic Sending Interval	10... 60 ...65535 s	Time period to send heating control value over "Heating Control Value" communication object.
Setpoint Button Step Value	0.1K, 0.5K , 1K	This parameter determines the step value of Setpoint.
SETPOINT LIMITS		
Maximum Setpoint	0... 40 ...99 °C / °F	This parameter determines the maximum value of Setpoint.
Minimum Setpoint	0 ...99 °C / °F	This parameter determines the minimum value of Setpoint.
Setpoint Range Limiting (Mode based)	checked / unchecked	This parameter is limiting the Setpoint changes.
Allowed Range (+/-)	1... 5 ...30 K	This parameter is shown when the "Setpoint Range Limiting" is selected. Given value will be applied plus and minus side of Setpoint. For e.g. Limit is 5 and Comfort Setpoint 25 C. The setpoint can decrease until 20 C, increase until 30 C.
HEATING & COOLING SETPOINTS		
Multi Setpoint	Enable / Disable	This parameter will be available If the Control Mode Switchover is selected as " <i>Manual</i> " in Thermostat Parameters Screen.
RETURN TO ETS PROGRAMMED VALUES		
After Reset	Yes / No	Setpoint values will be returned to last ETS programmed values after device reset.
After Mode Change	Yes / No	Setpoint values will be returned to last ETS programmed values after any operating mode change.
Reset on Site Object	Yes / No	Setpoint values will be returned to last ETS programmed values after Reset on Site Object is enabled.
Reset on Site Value	0 / 1 / Any Value	This parameter allows to reset device using by group object.

Parameter	Setting	Description
COMFORT MODE		
Setpoint	0... 25 ...99 °C / °F	This parameter allows to set default Setpoint Temperature of Comfort Mode.
Setpoint Heating	0... 25 ...99 °C / °F	Multi Setpoint parameter must be enabled to see these parameters. Heating and Cooling setpoints for Comfort Mode can be set independently.
Setpoint Cooling	0... 25 ...99 °C / °F	
Fan Speed	Auto / Fan Speed 1 / 2 / 3	Fan speed value can be set for Comfort Mode.
NIGHT MODE		
Setpoint	0... 23 ...99 °C / °F	This parameter allows to set default Setpoint Temperature of Comfort Mode.
Setpoint Heating	0... 23 ...99 °C / °F	Multi Setpoint parameter must be enabled to see these parameters. Heating and Cooling setpoints for Night Mode can be set independently.
Setpoint Cooling	0... 23 ...99 °C / °F	
Fan Speed	Auto / Fan Speed 1 / 2 / 3	Fan speed value can be set for Night Mode.
AWAY MODE		
Setpoint	0... 21 ...99 °C / °F	This parameter allows to set default Setpoint Temperature of Comfort Mode.
Setpoint Heating	0... 21 ...99 °C / °F	Multi Setpoint parameter must be enabled to see these parameters. Heating and Cooling setpoints for Away Mode can be set independently.
Setpoint Cooling	0... 21 ...99 °C / °F	
Fan Speed	Auto / Fan Speed 1 / 2 / 3	Fan speed value can be set for Away Mode.
PROTECTION MODE		
Heat Protection Limit	0... 40 ...99 °C / °F	This parameter allows to define Heat Protection. When the heat protection limit temperature reached, the cooling mode will be activated automatically.
Frost Protection Limit	0... 5 ...99 °C / °F	This parameter allows to define Frost Protection. When the frost protection limit temperature reached, the heating mode will be activated automatically.
Protection Deactivation Hysteresis	10... 20 ...255 x0.1	This parameter determines the deactivation hysteresis of Protection Mode
Fan Speed	Auto / Fan Speed 1 / 2 / 3	Fan speed value can be set for Protection Mode.

Table 41

No	Object Name	Function	Data Types	Flags
50	Regulation	On/Off	1 bit	CWT
			DPT 1.002	
Thermostat regulation can be turned on/off using this communication object. Also, when regulation controlled through “Operating Mode Button”, the regulation status will be sent using this communication object.				
55	Current Temperature °C	Temperature	2 byte DPT 9.001	CRT
	Current Temperature °F	Temperature	2 byte DPT 9.027	CRT
Current temperature value will be sent Celsius or Fahrenheit using this communication object, when the room temperature has changed or cyclically.(configured “Temperature Sensor” tab)				
56	Current Setpoint (°C)	Temperature	2 byte DPT 9.001	CRT
	Current Setpoint (°F)	Temperature	2 byte DPT 9.027	CRT
Setpoint value will be sent by Celsius or Fahrenheit(configured “Temperature Sensor” tab) using this communication object, when user has changed setpoint via thermostat.				
70	Change Setpoint (°C)	Temperature	2 byte DPT 9.001	CW
	Change Setpoint (°F)	Temperature	2 byte DPT 9.027	CW
Setpoint Temperature for CURRENT mode can be set using this communication object.Temperature value should be compatible with selected “Temperature Unit” and setpoint limitations.				
79	Setpoint Comfort °C	Temperature	2 byte DPT 9.001	CW
	Setpoint Comfort °F		2 byte DPT 9.027	
	Setpoint Heating Comfort °C		2 byte DPT 9.001	
	Setpoint Heating Comfort °F		2 byte DPT 9.027	

No	Object Name	Function	Data Types	Flags
Setpoint temperature for Comfort mode can be set by "Setpoint Comfort" communication object. If Multi Setpoint is enabled, Setpoint will be changed by "Setpoint Heating Comfort" group object.				
80	Setpoint Night °C	Temperature	2 byte DPT 9.001	CW
	Setpoint Night °F		2 byte DPT 9.027	
	Setpoint Heating Night °C		2 byte DPT 9.001	
	Setpoint Heating Night °F		2 byte DPT 9.027	
Setpoint temperature for Night mode can be set by "Setpoint Night" communication object. If Multi Setpoint is enabled, Setpoint will be changed by "Setpoint Heating Night" group object.				
81	Setpoint Away °C	Temperature	2 byte DPT 9.001	CW
	Setpoint Away °F		2 byte DPT 9.027	
	Setpoint Heating Away °C		2 byte DPT 9.001	
	Setpoint Heating Away °F		2 byte DPT 9.027	
Setpoint temperature for Away mode can be set by "Setpoint Away" communication object. If Multi Setpoint is enabled, Setpoint will be changed by "Setpoint Heating Away" group object.				
82	Setpoint Cooling Comfort °C	Temperature	2 byte DPT 9.001	CW
	Setpoint Cooling Comfort °F		2 byte DPT 9.027	
If Multi Setpoint is enabled, Setpoint will be changed by "Setpoint Cooling Comfort" group object.				
83	Setpoint Cooling Night °C	Temperature	2 byte DPT 9.001	CW
	Setpoint Cooling Night °F		2 byte DPT 9.027	

No	Object Name	Function	Data Types	Flags
If Multi Setpoint is enabled, Setpoint will be changed by "Setpoint Cooling Night" group object.				
84	Setpoint Cooling Away °C	Temperature	2 byte DPT 9.001	CW
84	Setpoint Cooling Away °F		2 byte DPT 9.027	
If Multi Setpoint is enabled, Setpoint will be changed by "Setpoint Cooling Away" group object.				
85	Setpoint Comfort (Status) °C	Temperature	2 byte DPT 9.001	CRT
	Setpoint Comfort (Status) °F		2 byte DPT 9.027	
	Setpoint Heating Comfort (Status) °C		2 byte DPT 9.001	
	Setpoint Heating Comfort (Status) °F		2 byte DPT 9.027	
Setpoint temperature for Comfort mode can be transmitted(read) using the "Setpoint Comfort Status" communication object. If Multi Setpoint is enabled, Setpoint Temperature will be transmitted by "Setpoint Heating Comfort Status" group object.				
86	Setpoint Night (Status) °C	Temperature	2 byte DPT 9.001	CRT
	Setpoint Night (Status) °F		2 byte DPT 9.027	
	Setpoint Heating Night (Status) °C		2 byte DPT 9.001	
	Setpoint Heating Night (Status) °F		2 byte DPT 9.027	
Setpoint temperature for Night mode can be transmitted(read) using the "Setpoint Night Status" communication object. If Multi Setpoint is enabled, Setpoint Temperature will be transmitted by "Setpoint Heating Night Status" group object.				
87	Setpoint Away (Status) °C	Temperature	2 byte DPT 9.001	CRT
	Setpoint Away (Status) °F		2 byte DPT 9.027	

No	Object Name	Function	Data Types	Flags
	Setpoint Heating Away (Status) °C		2 byte DPT 9.001	
	Setpoint Heating Away (Status) °F		2 byte DPT 9.027	
Setpoint temperature for Away mode can be transmitted(read) using the "Setpoint Away Status" communication object. If Multi Setpoint is enabled, Setpoint Temperature will be transmitted by "Setpoint Heating Away Status" group object.				
88	Setpoint Cooling Comfort (Status) °C	Temperature	2 byte DPT 9.001	CRT
	Setpoint Cooling Comfort (Status) °F		2 byte DPT 9.027	
If Multi Setpoint is enabled, Setpoint will be transmitted(read) by "Setpoint Cooling Comfort Status" group object.				
89	Setpoint Cooling Night (Status) °C	Temperature	2 byte DPT 9.001	CRT
	Setpoint Cooling Night (Status) °F		2 byte DPT 9.027	
If Multi Setpoint is enabled, Setpoint will be transmitted(read) by "Setpoint Cooling Night Status" group object.				
90	Setpoint Cooling Away (Status) °C	Temperature	2 byte DPT 9.001	CRT
	Setpoint Cooling Away (Status) °F		2 byte DPT 9.027	
If Multi Setpoint is enabled, Setpoint will be transmitted(read) by "Setpoint Cooling Away Status" group object.				

Table 42

4.6 Local Control



Figure 26

4.6.1 Parameters

Parameter	Setting	Description
Setpoint Button	Enable / Disable	Enable/Disable setpoint buttons on thermostat.
Operating Mode Button	Enable / Disable	Enable/Disable operating mode button on thermostat

Table 53

When any of the thermostat buttons disabled “Lock Icon” on the thermostat will be activated.

Disabling buttons will not affect secondary functions of those buttons.

For example, even setpoint buttons are disabled, long press of setpoint buttons will still operate as backlight dim.