

Binary output 4 channels 10A

Product code: EK-FA1-TP



Datasheet STEKFA1TP_EN

KNX binary output for independent switching of max. 4 groups of electrical loads. It has to be used in KNX installations for control of homes and buildings.



Description

The ekinex® binary output EK-FA1-TP is a S-mode KNX rail mounting modular device for independent switching of 4 groups of electrical loads; to this purpose the outputs of the device are equipped with potential-free relay contacts. The device is equipped with an integrated bus communication module and is designed for rail mounting in distribution boards and cabinets. To operate the device receives a telegram from the bus, sent by a KNX device (such as a pushbutton, a sensor or another switching or control device), that causes the opening or the closing of one or more relays. The manual operation of an output channel is possible also using the corresponding lever on the front side. The position of the lever simultaneously indicates the switching status of the relay. The bistable relays ensure the maintenance of the status also in case of failure of the bus voltage. The device is powered by the KNX bus line with SELV voltage 30 Vdc and does not require any auxiliary power supply.

Main characteristics

- On/off switching of individual loads or groups of loads
- Configurable as normally open or normally closed switch
- Manual switching through levers (also in case of bus voltage failure)
- Status feedback of the outputs through the position of the levers
- Logical gates and forced mode for each channel
- Block function for each channel
- Time scheduling: delay for switching on and off, staircase lighting function with pre-warning signal
- Integration in scenes
- Operating hours counter configurable via bus
- Auxiliary power supply not necessary

Other characteristics

- Housing in plastic material
- Mounting on 35 mm rail (according to EN 60715)
- Protection degree IP20 (according to EN 60529)
- Overvoltage class III (according to EN 60664-1)
- Classification climatic 3K5 and mechanical 3M2 (according to EN 50491-2)
- Pollution degree 2 (according to IEC 60664-1)
- 4 modular units (1 unit = 18 mm)
- Weight 205 g
- Dimensions 72 x 90 x 70 mm (WxHxD)

Technical data

Power supply

- 30 Vdc from KNX bus line
- Current consumption < 12 mA
- Power consumption 360 mW

Outputs

- Number: 4
- Rated voltage (Un): 230 Vac
- Rated current (In): 10 A
- Switched power: 2200 W

Symbol	Load type	Current
	Incandescent lamps	10 A
	Fluorescent lamps	10 A
	Drives ($\cos\phi \geq 0,6$)	10 A
	Electronic transformer for low voltage incandescent lamps (e.g. halogen lamps)	10 A
	Magnetic-core transformer for low voltage incandescent lamps (e.g. halogen lamps) ($\cos\phi \geq 0,6$)	10 A

Environmental conditions

- Operating temperature: - 5 ... + 45°C
- Storage temperature: - 25 ... + 55°C
- Transport temperature: - 25 ... + 70°C
- Relative humidity: 95% not condensing

Switching, display and connection elements

The device is equipped with switches for manual operation and status feedback, a programming pushbutton, a programming LED, and terminal blocks for connecting outputs and KNX bus line.

Switching elements

- Pushbutton for switching between the normal and programming operating mode
- Lever switches for manual operation of the channels (tool necessary)

Thanks to the lever switches located on the front of the device, the connected loads can be manually controlled in the absence of voltage on the KNX bus or when the programming has not yet been carried out.



Warning! The manual control of the device through the lever switches should be carried out only in case of emergency. The operation of the lever switches does not trigger any bus telegram.

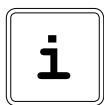
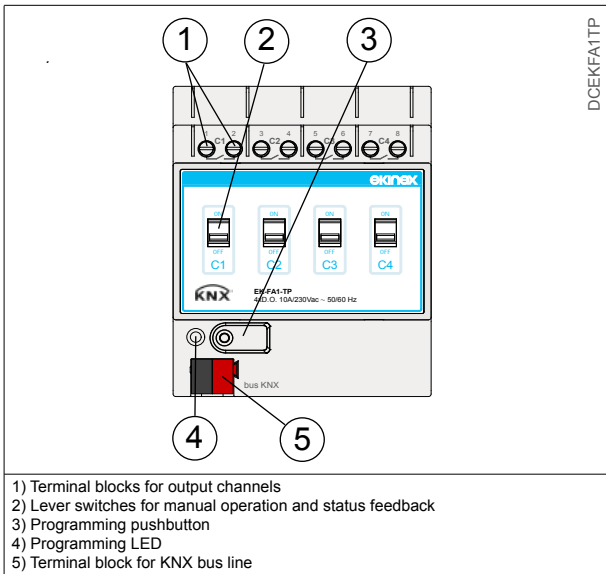

Note. In case of failure of the bus voltage, the switching of the loads is possible only if they are still powered with the mains voltage 230 Vac. The relay status in case of failure and reset of the bus can be set during the device configuration.

Display elements

- Red LED for displaying the active operating mode of the device (on = programming, off = normal operation)
- Switches for displaying the status of the outputs (lever up = closed contact, lever down = opened contact)

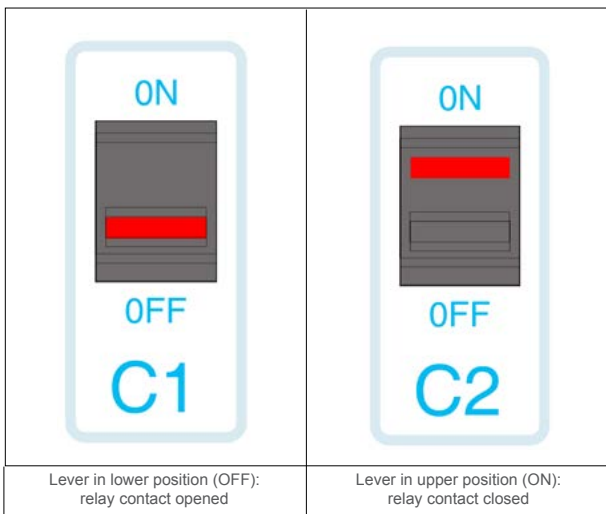

Mounting

The device has degree of protection IP20, and is therefore suitable for use in dry interior rooms. The housing is made for rail mounting according to EN 60715 in boards or cabinets for electrical distribution. The installation is in horizontal position, the correct position is when the KNX bus terminal is located at the bottom and the terminals for the outputs are located at the top. For the installation of the device on the rail proceed as follows:

- with the aid of a tool bring the locking device in the fully lowered position (1);
- place the upper edge of the rear inner profile on the upper edge of the rail (2);
- rotate the device towards the rail (3);
- push the locking device upward until it stops (4).

Before removing the device, be sure the inputs have been

disconnected and the bus terminal has been extracted from its slot. Use a screwdriver to slide down the locking device and remove the device from the rail.

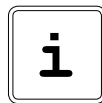
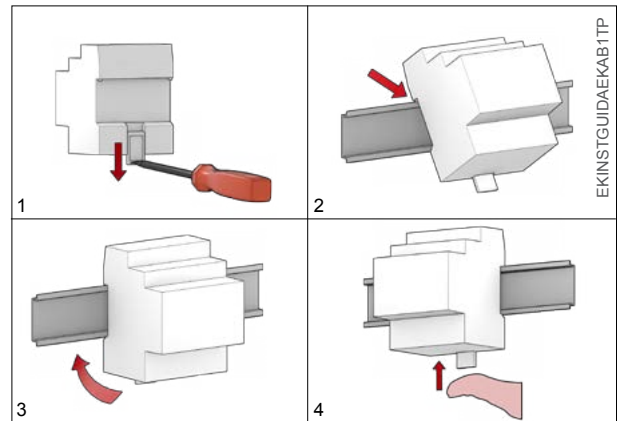

Note. It is recommended that the installation of the device always ensure the full accessibility of the front side to allow the operation of the pushbuttons.

Connection of the KNX bus line

The connection of the KNX bus line is made with the terminal block (black/red) included in delivery and inserted into the slot of the housing.

Characteristics of the KNX terminal block

- spring clamping of conductors
- 4 seats for conductors for each polarity
- terminal suitable for KNX bus cable with single-wire conductors and diameter between 0.6 and 0.8 mm
- recommended wire stripping approx. 5 mm
- color codification: red = + (positive) bus conductor, black = - (negative) bus conductor

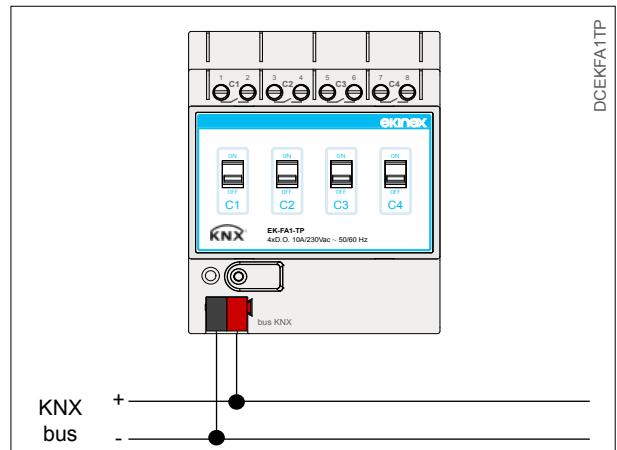

Warning! In order to supply the KNX bus lines use only a KNX bus power supply (e.g. ekinex EK-AB1-TP or EK-AG1-TP). The use of other power supplies can compromise the communication and damage the devices connected to the bus.

Connection of the loads

The connection of the loads is made with screw terminals located on the upper front of the device.

Characteristics of the terminals

- screw clamping of conductors
- maximum cross section of conductor 2.5 mm² (single-wire) or 1.5 mm² (multi-wire)

- recommended wire stripping approx. 6 mm
- torque max 0.8 Nm

In case of connection of loads powered at SELV voltage, it is necessary to leave an output channel unused (corresponding to a pair of terminals) between the outputs connected to loads with different voltages.



Warning! The electrical connection of the device can be carried out only by qualified personnel. The incorrect installation may result in electric shock or fire. Before making the electrical connections, make sure the power supply has been turned off.

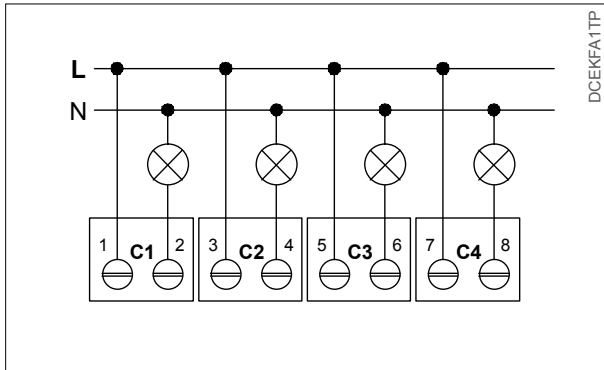

Warning! Sockets controlled via bus must be clearly identified. Controlling loads with mobile installation (e.g. household appliances connected to mains sockets) must be planned and realized with a careful evaluation of the risks that may arise in the case of control without direct visual contact with the load (remote control). Connecting loads different than those planned, remote controlling without direct verification of the current conditions of the connected load or automatic controlling based on scenes or time-scheduling can cause serious damage to people and objects.

Configuration and commissioning

Configuration and commissioning of the device require the use of the ETS® (Engineering Tool Software) program V4 or later releases. These activities must be carried out according to the design of the building automation system done by a qualified planner.

Configuration

For the configuration of the device parameters the corresponding application program or the whole ekinex® product database must be loaded in the ETS program. For detailed information on configuration options, refer to the application manual of the device available on the website www.ekinex.com

Product code	Application software (## = release)	Communication objects (max nr.)	Group addresses (max nr.)
EK-FA1-TP	APEKFA1TP##.knxprod	76	254

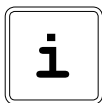

Note. The configuration and commissioning of KNX devices require specialized skills. To acquire these skills, you should attend the workshops at KNX certified training centers.

Commissioning

For commissioning the device the following activities are required:

- make the electrical connections as described above;
- turn on the bus power supply;

- switch the device operation to the programming mode by pressing the programming pushbutton located on the front side of the housing. In this mode of operation, the programming LED is turned on;
- download into the device the physical address and the configuration with the ETS® program.

At the end of the download the operation of the device automatically returns to normal mode; in this mode the programming LED is turned off. Now the bus device is programmed and ready for use.

Dimensions [mm]

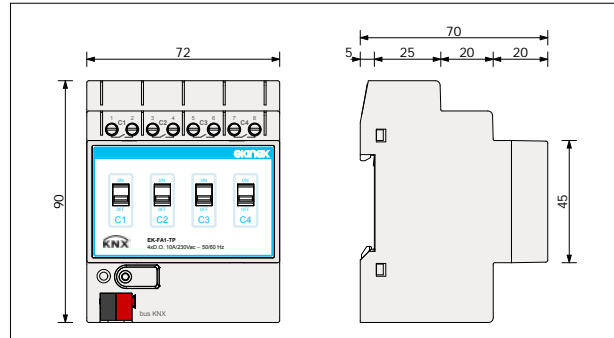

Marks

- KNX
- CE: the device complies with the Low Voltage Directive (2006/95/EC) and the Electromagnetic Compatibility Directive (2004/108/EC). Tests carried out according to EN 50491-2:2010, EN 50491-3:2009, EN 50491-4-1:2012, EN 50491-5-1:2010, EN 50491-5-2:2010, EN 50428:2005 +A1:2007 + A2:2009

Maintenance

The device is maintenance-free. To clean use a dry cloth. It must be avoided the use of solvents or other aggressive substances.

Disposal



At the end of its useful life the product described in this datasheet is classified as waste from electronic equipment in accordance with the European Directive 2002/96/EC (WEEE), and cannot be disposed together with the municipal undifferentiated solid waste.



Warning! Incorrect disposal of this product may cause serious damage to the environment and human health. Please be informed about the correct disposal procedures for waste collecting and processing provided by local authorities.

Documentation

This datasheet refers to the release A1.0 of the ekinex® device EK-FA1-TP, and is available for download at www.ekinex.com as a PDF (Portable Data Format) file.

File name	Device release	Updating
STEKFA1TP_EN.pdf	A1.0	03 / 2014

Warnings

- Installation, electrical connection, configuration and commissioning of the device can only be carried out by qualified personnel in compliance with the applicable technical standards and laws of the respective countries
- The use of the device in security applications is not allowed. The device may however be used for auxiliary

signaling functions

- Opening the housing of the device causes the immediate end of the warranty period
- In case of tampering, the compliance with the essential requirements of the applicable directives, for which the device has been certified, is no longer guaranteed
- ekinex® KNX defective devices must be returned to the manufacturer at the following address: SBS S.p.A. Via Circonvallazione s/n, I-28010 Miasino (NO) Italy

Other information

- This datasheet is aimed at installers, system integrators and planners
- For further information on the product, please contact the ekinex® technical support at the e-mail address: support@ekinex.com or visit the website www.ekinex.com
- ekinex® is a registered trademark of SBS S.p.A.
- KNX® and ETS® are registered trademarks of KNX Association cvba, Brussels

© SBS S.p.A. 2014. The company reserves the right to make changes to this documentation without notice.