

## Room temperature controller with LC-display

Codes: EK-EP2-TP-...

EK-EQ2-TP-... (with R.H. sensor)



Datasheet STEKEQ2TP\_IT

KNX thermostat with LC-display for the independent thermal regulation of a room or a zone. It has to be used in KNX installations for control of homes and buildings.



### Description

The ekinex® room temperature controller is a KNX S-mode device for the independent temperature regulation of a room or a zone in a building. In combination with one or more KNX actuators, the room temperature controller is able to control the heating and cooling emission of a series of terminal units for the thermal exchange (such as radiators, fan-coils, floor and ceiling radiant panels, etc.). The device is provided with a LC-display with adjustable backlight, sensors for temperature and brightness measuring and two freely configurable inputs for the connection of e.g. window contacts or temperature sensors. The device is equipped with an integrated KNX bus communication module and is designed for wall installation on a flush mounting box. For controlling the room temperature controller functions the integrated 2-fold pushbutton is used. It is provided with four LED for each channel programmable e.g. as status feedback or orientation night-light. The device is powered by the KNX bus line and does not require any auxiliary power supply.

### EK-EQ2-... versions

The EK-EQ2-... versions are provided with a relative humidity sensor and additional functions that use the physical value measured by the sensor.

### Versions and accessories

The device has to be completed with a set of 2 square rockers specific for the room temperature controller; depending on the version, a square frame of the form or flank series may be necessary. A metallic support, the fixing screws and the terminal for connection of the KNX bus line are delivered with the device.

| Code            | LED colors   | Accessories   |
|-----------------|--------------|---|
| EK-EP2-TP       | blue / green | set of rockers EK-TSQ-G...-EP2 and square frame form (EK-FOQ-...) or flank (EK-FLQ-...) |
| EK-EP2-TP-RW    | white / red  |   |
| EK-EQ2-TP       | blue / green | set of rockers EK-TSQ-G...-EP2  |
| EK-EQ2-TP-RW    | white / red  |   |
| EK-EP2-TP-BG-NF | blue / green | (on the 'NF (No Frame) version no frame has to be mounted)                              |
| EK-EP2-TP-RW-NF | white / red  |   |
| EK-EQ2-TP-BG-NF | blue / green |   |
| EK-EQ2-TP-RW-NF | white / red  |   |

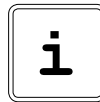

**Note.** Rockers and frame (when necessary) for the completion of the device must be ordered separately. For more information on materials, colors and finishes available, see also the ekinex® product catalog or browse [www.ekinex.com](http://www.ekinex.com)

### Main functional characteristics

The characteristics common to all versions are:

- Temperature and brightness measuring through integrated sensors with possibility of sending the value on the bus
- 2-point (on/off) or proportional (PWM or continuous) room temperature regulation
- Ventilation control with continuous or 3-speed regulation
- Seasonal modes: heating and cooling with possibility of local or via bus seasonal changeover
- Operating modes: comfort, standby, economy and building protection with different setpoint for heating and cooling
- Manual or automatic control of fan-coil units with 2 or 4-pipes hydraulic distribution
- Automatic switching of the operating modes depending on presence or window opening
- Weighted average of two temperature values
- Temperature displaying (measured, setpoint and outdoor values as °C or °F), alarms and errors (with alphanumeric coding)
- Floor temperature limitation and antincondensation (for radiant panels)
- Antistratification function
- Automatic switching between operating modes through card holder contact
- Delayed start of a fan ("hot-start") with time-scheduling or depending on the water temperature measured at the coil for thermal exchange
- Window opening reporting

The EK-EQ2-... versions offer additional functions for:

- Relative humidity measuring through the integrated sensor with possibility of sending the value on the bus
- Humidification and dehumidification control
- Sending on the bus of the condition internal or external with regard to a configurable comfort area
- Calculation of psychrometric values (dew-point temperature, absolute humidity, enthalpy and perceived temperature)
- Displaying of perceived temperature, relative humidity (measured and setpoint in %) and CO<sub>2</sub> concentration (in %, received from the bus)

### Other characteristics

- LC-display with adjustable backlight
- 2 rockers for device control
- 4 leds for each rocker freely programmable
- Case in plastic material
- Wall installation in round or square flush mounting box with 60 mm distance between fixing holes

- Protection degree IP20 (according to EN 60529)
- Classification climatic 3K5 and mechanical 3M2 (according to EN 50491-2)
- Pollution degree 2 (according to IEC 60664-1)
- Weight 70 g (85 g cwith mounting support)
- Dimensions 82 x 75 x 35 mm (WxHxD)

### Technical data

- Power supply 30 Vdc from KNX bus line
- Current consumption < 13 mA

### Environmental conditions

- Operating temperature: - 5 ... + 45°C
- Storage temperature: - 25 ... + 55°C
- Transport temperature: - 25 ... + 70°C
- Relative humidity: 95% not condensing

### Device operation

The device can be configured to operate as a stand-alone device (local control) or slave device (control via bus).

#### Using as a stand-alone device

The control is carried out locally with the two rockers on the front side of the device. During the configuration it is possible to enable selectively the available functions. Depending on the configuration done with ETS, it is possible to:

- change temporarily the setpoint of the current operating mode;
- display an information sequence;
- control a ventilation terminal device;
- change the setpoint values for the operating modes comfort, standby and economy;
- adjust the intensity of the backlight;
- display the physical address and the firmware release of the device;
- change the heating/cooling mode (seasonal changeover).

#### Using as a slave device

The control is carried out remotely by another KNX device acting as a supervisor that sends to the thermostat via bus the operational parameters: e.g. setpoint values, operating modes or seasonal modes. The possibility of changing locally the operational conditions, received via bus by the master device, are limited in comparison to the use as a stand-alone device and are indicated on the display by the symbol M (Manual). In this case, the operating parameters of the room temperature controller can be changed centrally at the master device.

### LC-display

The thermostat has an LC-display with adjustable backlight that occupies vertically the left half of the front side. Depending on the information to be displayed, a combination of digits and symbols can be switched on. Thanks to the integrated light sensor, the light intensity emitted from the display can be adjusted automatically to the light conditions of the room.



### Symbols

| Simb.           | Meaning   |      |             |
|-----------------|---|------|-------------|
| 000 °C/B        | Temperature (in °C or °F), relative humidity (in %), CO <sub>2</sub> concentration (in ‰) |      |             |
| ⚠               | Alarm, error  | 🌙    | Economy     |
| 🪟               | Window opening  | 👤    | Standby     |
| CO <sub>2</sub> | CO <sub>2</sub> concentration   | 👤    | Comfort     |
| 🌡               | Internal temperature  | 🔥    | Heating     |
| 🌡               | External temperature  | M    | Manual      |
| 🌡               | Relative humidity   | 🕒    | Slave       |
| SET             | Setpoint  | ❄    | Cooling     |
| 🛡               | Building protection   | OFFA | Fan control |

### Rockers

The symbols on the rockers are predefined and cannot be modified. The areas marked by the symbols + (plus) and - (minus) allow the change of the temperature setpoint, the fan speed or to select a setting, while those marked by the ●●● symbols allow e.g. the displaying of a sequence of information, the change of the operating mode, the ventilation control, the seasonal changeover (heating/cooling) or the access and confirmation a setting change.

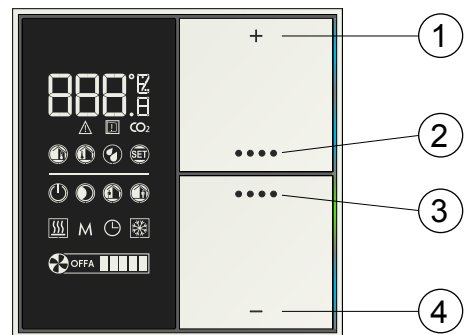

- 1) + (plus) symbol: increase of value
- 2) ●●● symbol: display of information (short pressing), change of setpoint (long pressing), confirm of a setting
- 3) ●●● symbol: ventilation control, change of operating mode, operation exit
- 4) - (minus) symbol: decrease of value

### Seasonal operating modes

The device allows the control of the room temperature for both modes of operation of the thermal system: heating and cooling. If a 4-pipe hydraulic distribution is present, the device can be configured so that the switching between heating and cooling modes is done automatically for the same room and in the same day, if the central system provides simultaneously warm and cold conveying fluids. The active mode of the system is displayed by an appropriate symbol.

### Operating modes

| Symbol | Seasonal operating mode / device status   |
|--------|---|
| 🔥      | Heating seasonal operating mode, request of the device satisfied or achieved setpoint |
| 🔥      | Heating seasonal operating mode, device requesting heating or setpoint not achieved   |
| ❄      | Cooling seasonal operating mode, request of the device satisfied or achieved setpoint |
| ❄      | Cooling seasonal operating mode, device requesting cooling or setpoint not achieved   |

The device has four operating modes with setpoint values to be set independently for the operation in heating and cooling. The setpoint values as well as the using during the day of the various operating modes depend on a number of specific factors such as the building type, the use of the room, the individual perception of heat and cold, the 'inertia characteristic of the room terminals, etc. and should be carefully considered with the planner of the heating system, the customer and the user.

#### Comfort

The comfort operating mode is generally set when people occupy continuously a room.

#### Standby

The standby operating mode is set in case of absence of short duration from the room. This mode provides a small attenuation of the temperature compared to comfort mode; the attenuation assumes a different direction depending on the seasonal mode setting (lower temperature for heating, higher temperature for cooling).

#### Economy

The economy operating mode is set for example in case of prolonged absence from the room, during the night hours, etc. and provides an bigger attenuation of temperature larger than the standby mode.

#### Building protection

The building protection operating mode is provided with a temperature threshold; when exceeded, warm or cold conveying fluid is requested to the thermal generator to avoid potential damages to the building (equipment, furnishings, devices) caused by too low (frost protection) or too high (overheating protection) internal temperatures. The building protection function is effective only when the thermal generator (boiler or chiller) is regularly operating. If configured and connected to a window contact, the device automatically switches to the building protection mode at the window opening and switches back to the previous mode at the window closing.

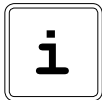

**Note.** If the device is in the building protection mode, when the temperature exceeds the threshold setting, the valve of the hydraulic circuit is opened even if the fan is switched off.

#### Changing operating mode

If the device is configured to operate as a slave, the setting of the operating mode is done via bus by another KNX device with supervising function (such as a timer or a centralised control and visualisation unit) of the building automation system. The only change of operating mode enabled manually is the recalling of the comfort mode for a configurable time interval with ETS. If the device is configured for stand-alone operation, the change of the operating mode is done manually using the rockers for the control of the room temperature controller functions.

#### Ventilation control

The device allow the control of the ventilation function. The regulation may be continuous or stepwise (max 3 speed levels).

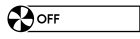
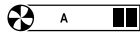
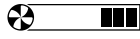
| Symbol  | Fan operation   |
|---|---|
|  | Switched off mode (OFF): the fan is switched off and the regulation can not activate it, independently from the the difference between the measured temperature and the current temperature setpoint. |
|  | Automatic mode (A): the fan speed is automatically regulated depending on the difference between the measured temperature and the current temperature setpoint.                                       |
|  | Manual mode: the fan speed is manually forced to the level corresponding to the number of bars switched on (from 1 to 5).   |

#### Mounting position

For the temperature control function the value of the room temperature may be measured by the temperature sensor integrated in the device, by another KNX temperature sensor, by a temperature sensor connected to one input, or be calculated as a weighted average value of two different sources.

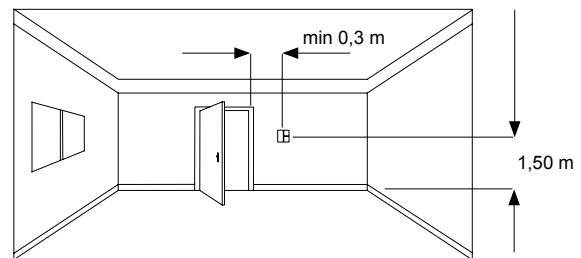

If the temperature value measured by the integrated sensor is used, for an optimal temperature control the device must be installed taking care of:

- installing the device on an inner wall of the room at a height of about 1.5 m from the floor;
- not shielding the device with curtains, furniture or other;
- verifying that from the duct connected to the wall box does not come airflows that might affect the temperature measurement;
- avoiding the installation close to heat sources (such as domestic appliances or lighting devices), pipes for the distribution of hot or cold water and terminal devices for heating and cooling;
- avoiding the installation where the device may be subject to direct sunlight through glass surfaces.

If these conditions can not be satisfied, it is appropriate to use a weighted average value between two temperature values measured in the same room according to the different possibilities offered from the device (temperature sensor connected to an input or a KNX temperature sensor). If a second temperature value can not be measured, it is also possible to correct the value measured by the sensor integrated in the device using the appropriate offset parameter in the ETS application program.

#### Mounting

The device has degree of protection IP20, and is therefore suitable for use in dry interior rooms. The installation of the device requires the following steps:

- fix the metallic support (f) with the screws supplied (e) on the wall box (g);
- if required, snap a square frame (d) of the form or flank series, inserting it from the rear of the device (b) ;
- connect the sensors or the contacts required to the 4-poles screw terminal block on the rear of the device;
- insert the terminal for the bus (red/black), previously connected to the bus cable, in its slot on the rear side

(see also: "Connection of the KNX bus line". At this point it is recommended to carry out the commissioning of the device (see also "Configuration and commissioning") or at least the download of the physical address;

- e) install the device (b) on the metallic support (f) through the spring system, tightening then the two screws. Mounting the device follow also the indication TOP (arrow tip pointing up) on the rear side of the device;
- f) snap the two rockers (a) onto the device for the operation of the room temperature controller.

The device can only be mounted on a round or square wall flush mounting box with 60 mm distance between fixing holes. If necessary, the metallic support for mounting on the wall box can also be ordered separately using the code EK-SMQ.

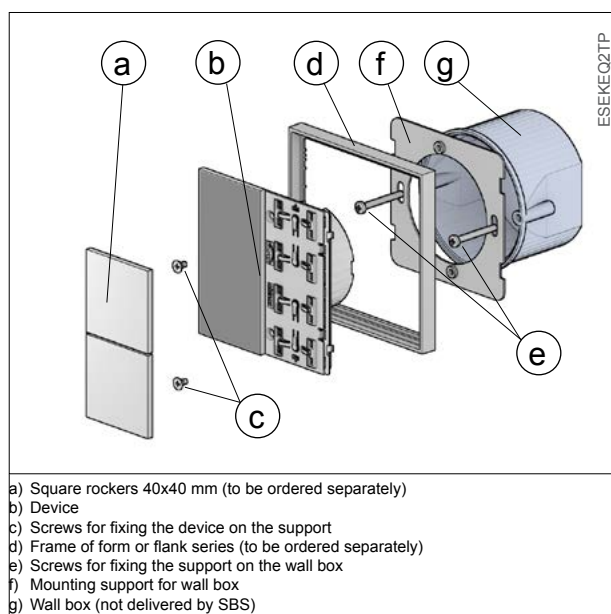

- a) Square rockers 40x40 mm (to be ordered separately)
- b) Device
- c) Screws for fixing the device on the support
- d) Frame of form or flank series (to be ordered separately)
- e) Screws for fixing the support on the wall box
- f) Mounting support for wall box
- g) Wall box (not delivered by SBS)

### Switching and display elements

The device is equipped with a backlit LC-display, 2 mechanisms for rockers mounting, 4 programmable LEDs for each channel, a programming LED and a programming pushbutton.

#### Switching elements

- Pushbutton (3) for switching between the normal and programming operating modes
- Mechanisms (8) for room temperature control functions to be completed with 2 square rockers

#### Display elements

- LC-display (1) with digits and symbols for displaying the operating conditions of the device
- Red LED (4) for indication of the active operating mode (on = programming, off = normal operation)
- Eight freely programmable LEDs with lightguide (5); e.g. as status feedback or as orientation nightlight

### Measuring elements

The devices is provided with three sensors:

- temperature sensor (not visible, positioned behind the passage 7);
- relative humidity sensor (6);
- brightness sensor (2).

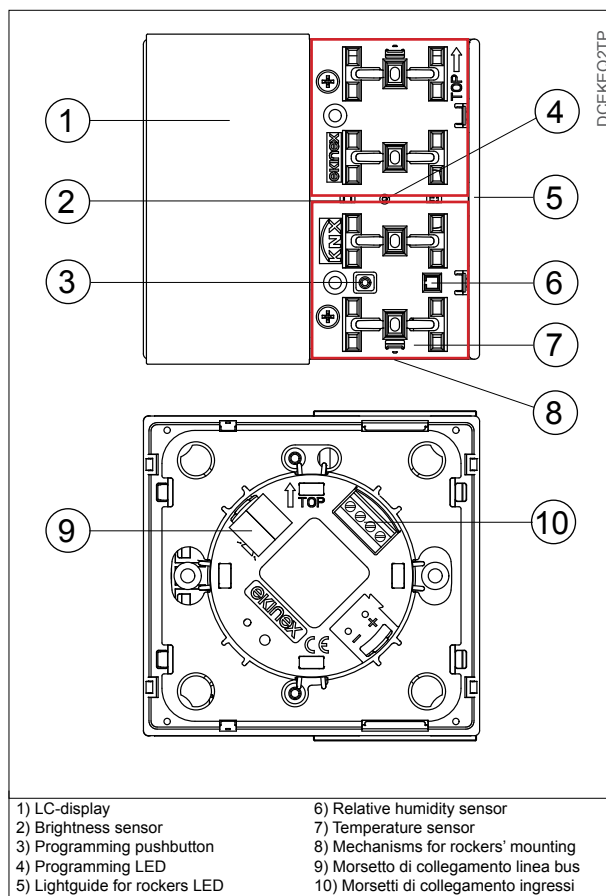

- |                               |                                       |
|-------------------------------|---------------------------------------|
| 1) LC-display                 | 6) Relative humidity sensor           |
| 2) Brightness sensor          | 7) Temperature sensor                 |
| 3) Programming pushbutton     | 8) Mechanisms for rockers' mounting   |
| 4) Programming LED            | 9) Morsetto di collegamento linea bus |
| 5) Lightguide for rockers LED | 10) Morsetti di collegamento ingressi |

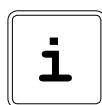

**Note.** Programming pushbutton and LED are accessible from the front side of the device. The device addressing may be easily carried out after the assembly of the frame, removing the rockers. Once the addressing has been carried out, the device configuration can be later downloaded without pressing the programming pushbutton.

#### Temperature sensor

The integrated temperature sensor measures the temperature value in a range from 0 °C to +40 °C with a resolution of 0.1 K. The measured value can be corrected by the environmental influences by means of an offset parameter. In order to avoid that too rapid temperature fluctuations negatively affect the regulation process, an acquisition filter can be set. If necessary, for the regulation can be used a weighted average between the value measured by the integrated sensor and another temperature value measured in the room by a temperature sensor connected to one of the inputs of the device or received via bus by another KNX device. The value measured by the sensor can be sent on the bus.

#### Relative humidity sensor (only for EK-EQ2-TP-...)

The measurement of the relative humidity of the room air mass significantly extends the functions of thermal regulation and allows to increase comfort and safety of operation. In combination with the HVAC system, the device allows to perform a real building climatic control independently for each room or zone, adding to heating and cooling of the possibility of controlling the dehumidification and humidification of the rooms. The value measured by the sensor can be sent on the bus.

#### Brightness sensor

The integrated sensor measures the brightness value in the room; the measured value can be corrected by the en-

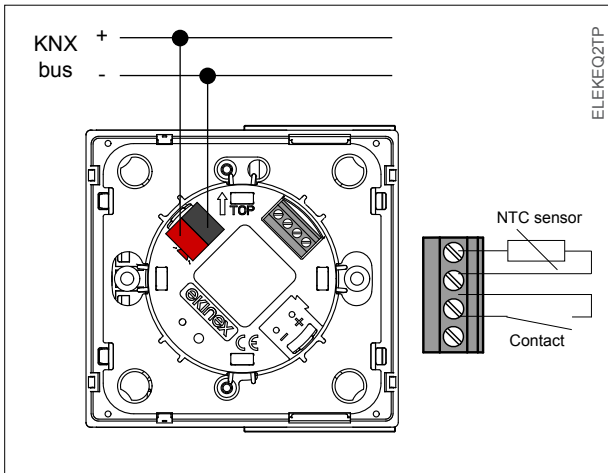

**Warning!** The electrical connection of the device can be carried out only by qualified personnel. The incorrect installation may result in electric shock or fire. Before making the electrical connections, make sure the power supply has been turned off.

environmental influences with a specific multiplier and sent on the bus.

### Connection of the KNX bus line

The connection of the KNX bus line is made with the terminal block (black/red) included in delivery and inserted into the slot of the housing.

#### Characteristics of the KNX terminal block

- spring clamping of conductors
- 4 seats for conductors for each polarity
- terminal suitable for KNX bus cable with single-wire conductors and diameter between 0.6 and 0.8 mm
- recommended wire stripping approx. 5 mm
- color codification: red = + (positive) bus conductor, black = - (negative) bus conductor

### Connection of the inputs

The connection of the inputs is made with the screw terminals (10) located at the rear side of the device. The maximum cable length is 10 m.

#### Characteristics of the terminals

- screw clamping of conductors
- maximum cross section of conductor 1 mm<sup>2</sup> (multi-wire)
- recommended wire stripping approx. 5 mm
- torque max 0.2 Nm



**Warning!** In order to supply the KNX bus lines use only KNX bus power supplies (e.g. ekinex EK-AB1-TP or EK-AG1-TP). The use of other power supplies can compromise the communication and damage the devices connected to the bus.

### Available applications

If configured as analogic, to an input it is allowed exclusively the connection of NTC temperature sensors with characteristic resistance value of 10 kΩ at 25°C,  $\beta = 3435$ .

### Configuration and commissioning

Configuration and commissioning of the device require the use of the ETS® (Engineering Tool Software) program V4 or later releases. These activities must be carried out according to the design of the building automation system done by a qualified planner.

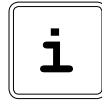

**Note.** The configuration and commissioning of KNX devices require specialized skills. To acquire these skills, you should attend the workshops at KNX certified training centers.

### Configuration

For the configuration of the device parameters the corresponding application program or the whole ekinex® product database must be loaded in the ETS program. For detailed information on configuration options, refer to the application manual of the device available on the website [www.ekinex.com](http://www.ekinex.com).

| Configuration | Application                               |
|---------------|---|
| Digital       | [D] window sensor                         |
|               | [D] card holder sensor                    |
|               | [D] anticondensation sensor               |
| Analogic      | [A] coil battery temperature sensor       |
|               | [A] room temperature sensor               |
|               | [A] antistratification temperature sensor |
|               | [A] floor surface temperature sensor      |
|               | [A] outdoor temperature sensor            |
|               | [A] generic temperature sensor (NTC type) |



**Warning!** Each input of the device is independently configurable as digital or analogic. The connection to an input of a device which does not match the parameter configuration carried out with ETS causes the impossibility to perform the desired function.

### Commissioning

For commissioning the device the following activities are required:

- make the electrical connections as described above;
- turn on the bus power supply;
- switch the device operation to the programming mode by pressing the programming pushbutton located on the front side in the area for the mounting of the rockers. In this mode of operation, the programming LED is turned on;
- download into the device the physical address and the configuration with the ETS® program.

| Code          | Application program (## = release) | Comm. objects (max nr.) | Group addr. (max nr.) |
|---------------|------------------------------------|-------------------------|-----------------------|
| EK-EP2-TP-... | APEKEP2TP##.knxprod                | 63                      | 63                    |
| EK-EQ2-TP-... | APEKEQ2TP##.knxprod                | 83                      | 83                    |

At the end of the download the operation of the device automatically returns to normal mode; in this mode the programming LED is turned off. Now the bus device is programmed and ready for use.

### Displaying physical address and firmware release

If enabled for this purpose with ETS, the device can display anytime its physical address and firmware release by the combined pressing of rockers. To display the information, simultaneously press – (minus) and ●●● on the upper rocker for more than 3 s. The display shows in sequence the number of area (A), line (L), device (d) and the firmware release (F). To scroll through the information press ●●● on the upper rocker. The display returns to the default information at the end of the time interval set with ETS or pressing ●●● on the lower rocker.

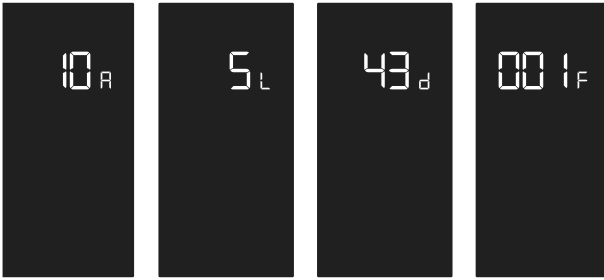

### Dimensions [mm]

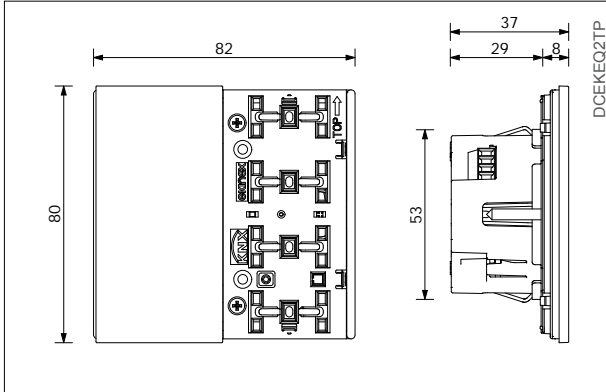

### Marks

- KNX
- CE: the device complies with the Low Voltage Directive (2006/95/EC) and the Electromagnetic Compatibility Directive (2004/108/EC). Tests carried out according to EN 50491-5-1:2010, EN 50491-5-2:2010

### Maintenance

The device is maintenance-free. To clean use a dry cloth. It must be avoided the use of solvents or other aggressive substances.

### Disposal



At the end of its useful life the product described in this datasheet is classified as waste from electronic equipment in accordance with the European Directive 2002/96/EC (WEEE), and cannot be disposed together with the municipal undifferentiated solid waste.



**Warning!** Incorrect disposal of this product may cause serious damage to the environment and human health. Please be informed about the correct disposal procedures for waste collecting and processing provided by local authorities.

### Documentation

This datasheet refers to the release A1.0 of the ekinex® devices EK-EP2-TP and EK-EQ2-TP, and is available for download at [www.ekinex.com](http://www.ekinex.com) as a PDF (Portable Data Format) file.

| File name         | Device release | Updating  |
|-------------------|----------------|-----------|
| STEKEPQ2TP_EN.pdf | A1.0           | 01 / 2015 |

### Warnings

- Installation, electrical connection, configuration and commissioning of the device can only be carried out by qualified personnel in compliance with the applicable technical standards and laws of the respective countries
- Opening the housing of the device causes the immediate end of the warranty period
- In case of tampering, the compliance with the essential requirements of the applicable directives, for which the device has been certified, is no longer guaranteed
- ekinex® KNX defective devices must be returned to the manufacturer at the following address: SBS S.p.A. Via Circonvallazione s/n, I-28010 Miasino (NO) Italy

### Other information

- This datasheet is aimed at installers, system integrators and planners
- For further information on the product, please contact the ekinex® technical support at the e-mail address: [support@ekinex.com](mailto:support@ekinex.com) or visit the website [www.ekinex.com](http://www.ekinex.com)
- Each ekinex® device has a unique serial number on the label. The serial number can be used by installers or system integrators for documentation purposes and has to be added in each communication addressed to the SBS technical support in case of malfunctioning of the device
- ekinex® is a registered trademark of SBS S.p.A.
- KNX® and ETS® are registered trademarks of KNX Association cvba, Brussels

© SBS S.p.A. 2015. The company reserves the right to make changes to this documentation without notice.