

eKinex

CONTROL YOUR LIVING SPACE

Application Manual

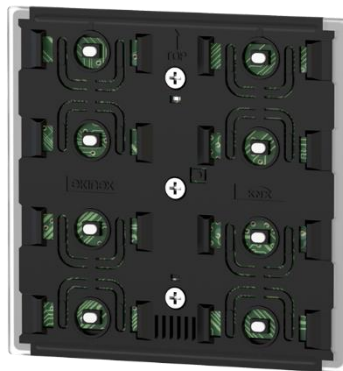

**KNX pushbutton
EK-ED2-TP 2-4 button**

Contents

1	Scope of the document.....	5
2	Product description	6
2.1	Completion of the device	6
2.2	Rocker functions	8
2.3	LED indicators.....	8
2.4	Light and temperature sensors	8
2.5	Customization of rocker plates	9
3	Switching, display and connection elements.....	10
4	Configuration	11
5	Commissioning	11
6	Function description	12
6.1	Offline operation.....	12
6.2	Online operation.....	12
6.3	Software working cycle	13
6.4	Pushbutton inputs	13
6.4.1	Pushbutton input events.....	13
6.4.2	Lock function	13
6.4.3	State variables (communication objects)	13
6.4.4	Binding between Events and Communication objects	14
6.4.5	Repeated send	14
6.4.6	Input coupling.....	14
6.4.7	Single or independent input mode	15
6.4.8	Coupled input mode	15
6.4.9	Dimming function	17
6.4.10	Shutter / venetian blind function.....	19
6.5	LED indicators.....	22
6.5.1	General parameters	22
6.5.2	Individual parameters.....	22
6.5.3	Technical Alarm indicator	22
6.6	Light and temperature sensors	23
6.6.1	Light sensor	23
6.6.2	Temperature sensor	23
6.7	Room thermostat	24
6.7.1	Use of sensors	24
6.7.2	Applications	24
6.7.3	Control algorithms	24
6.7.3.1	Two-point control with hysteresis	25
6.7.3.2	Continuous Proportional-Integral control	27
6.7.3.3	PWM Proportional-Integral control.....	28
6.7.4	Setpoint management	29
6.7.5	Operating modes.....	30
6.7.6	Heating/cooling switch over	31
6.7.7	Window switch management	32
6.7.8	Valve protection function	32

6.7.9	Temperature control alarm	33
6.8	Logic functions	33
7	Application program for ETS	35
7.1	About EK-ED2-TP	36
7.2	General settings	37
7.3	Internal sensors	40
7.3.1	Light sensor	40
7.3.2	Temperature sensor	41
7.4	Rockers configuration	43
7.4.1	Independent or single: send values or sequences	44
7.4.2	Independent or single: dimming	44
7.4.3	Independent or single: shutter or venetian blind	45
7.4.4	Independent or single: scene	45
7.4.5	Coupled: switch	46
7.4.6	Coupled: dimming	46
7.4.7	Coupled: shutter or venetian blind	46
7.5	Rocker x: Function A/B configuration	46
7.5.1	Independent or single	46
7.5.2	Independent or single: Lock function enabled	48
7.5.3	Independent or single: send values or sequences	49
7.5.4	Independent or single: dimming	52
7.5.5	Independent or single: shutter or venetian blind	53
7.5.6	Independent or single: scene	54
7.5.7	Coupled	55
7.5.8	Coupled: Lock function enabled	55
7.5.9	Coupled: switch	55
7.5.10	Coupled: dimming	56
7.5.11	Coupled: shutter or venetian blind	57
7.6	LED configuration	58
7.7	Temperature control	60
7.7.1	Settings	60
7.7.2	Sensors from bus	63
7.7.3	Weighted temperature value	64
7.7.4	Heating	65
7.7.5	Cooling	68
7.8	Logic functions	70
8	Appendix	72
8.1	Summary of KNX communication objects	72
8.2	Warning	75
8.3	Other information	75

Revision	Modifications	Date
1.1.0	Changed some communication objects references.	30/01/2017
1.0.0	Emission	23/03/2016

1 Scope of the document

This application manual describes application details for the A1.0 release of the ekinex® KNX pushbutton interface EK-ED2-TP (2-4 rockers).

The document is aimed at the system configurator as a description and reference of device features and application programming. For installation, mechanical and electrical details of the device please refer to the technical description datasheet.

Application manual and application programs for ETS are available for download at www.ekinex.com.

Item	File name (## = release)	Version	Device rel.	Update
Product datasheet	STEKED2TP_EN.pdf	EK-ED2-TP		
Application manual	MAEKED2TP_EN.pdf	EK-ED2-TP	A1.0	03/2016
Application program	APEKED2TP##.knxprod	EK-ED2-TP		

You can access the most up-to-date version of the full documentation for the device using following QR codes:

2-4 rocker interface EK-ED2-TP:

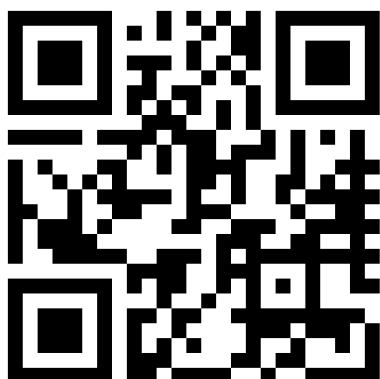

2 Product description

The ekinex® KNX 4-rocker pushbutton unit EK-ED2-TP is a wall-mounting device for on/off switching of loads, dimming of lighting devices, control of motor drives or other programmable switching and control functions. The pushbutton is equipped with an integrated temperature sensor and can act as a room probe or thermostat, both in heating and cooling mode. When acting as a room thermostat, the device is not equipped with a user interface for displaying room conditions and modifying the setpoint temperature; therefore, it must be paired with an external supervision device. Terminals such as radiators, electrical radiators and radiant panels can be controlled.

This unit is equipped with an integrated KNX bus communication module and is designed for wall installation on flush mounting box; commands are constituted by rockers with 2 active plus a neutral rest position. The device has also two programmable LEDs for each function which can be used for instance as a status signal or orientation nightlight.

For final use, this unit must be completed with frontal plates for commands and a frame, which must be ordered separately in order to obtain the desired aesthetic look; regardless of the detail, several kinds of plates are available (square or rectangular) which can be combined in order to obtain different rockers' combinations.

This device is also fitted with a light intensity sensor, whose measurements can be read and used as desired by any KNX device connected to the bus.

The device is powered by the KNX bus line with a 30 VDC SELV voltage and does not require auxiliary power.

Product code	Number and type of rockers	Rocker size	Frame
EK-ED2-TP (blue-green led couples) EK-ED2-TP-RW (red-white led couples)	2 rectangular vertical	40 x 80 mm	<i>Form or Flank</i> series
EK-ED2-TP-BG-NF (no frame line, blue-green led couples) EK-ED2-TP-RW-NF (no frame line, red-white led couples)	4 square 4 rectangular horizontal	40 x 80 mm 80 x 20 mm	No frame

The supply includes, inside the box:

- 1 adapter;
- 1 metallic support;
- 2 pairs of fixing screws;
- 1 KNX terminal block for the connection of the bus line.

2.1 Completion of the device

For full installation and operation, the unit must be completed with:

- A rocker faceplate (according to the chosen number and disposition);
- An ekinex® *Form* or *Flank* series 1-place square or 2-place rectangular frame (with the exception of the rocker interfaces of No Frame series NF);
- An ekinex® 1-window square or 2-window rectangular plate

Rocker placement

Combining the 3 available models of rockers (rectangular vertical, square horizontal and rectangular horizontal) different configurations are allowed, as shown in the following picture.

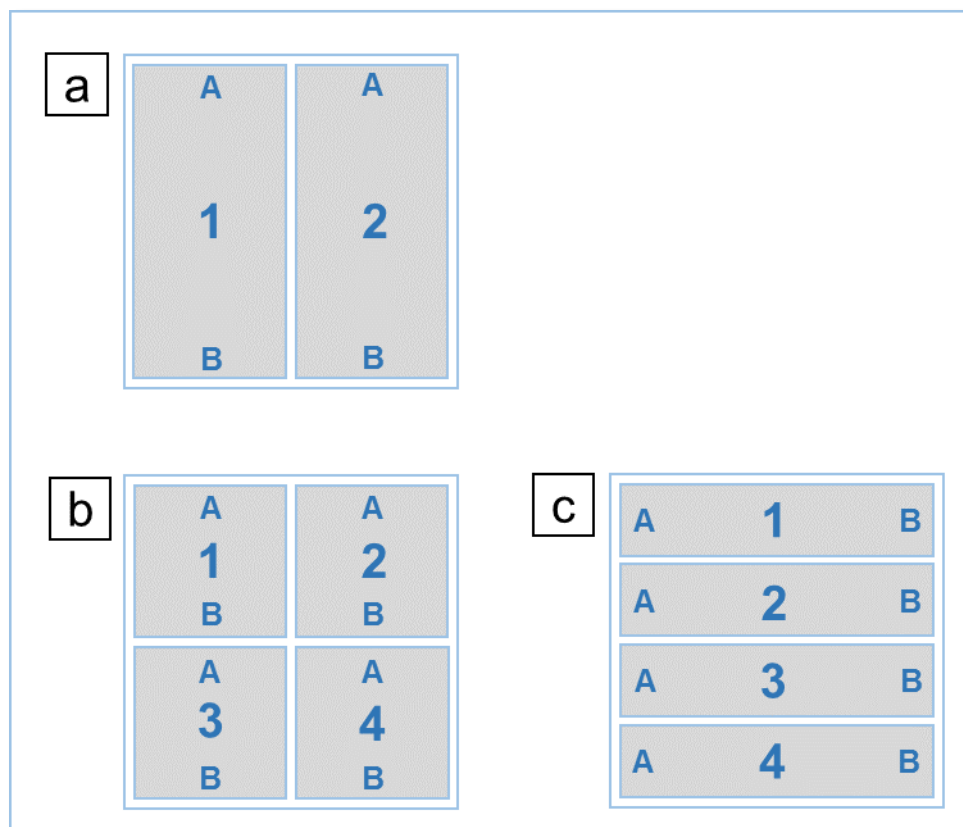

Figure 1 - Rocker combination

2.2 Rocker functions

Each one of two active positions of the rockers (side for rectangular rockers, superior and inferior for square ones) corresponds to an *action*, i.e. an input, or physical pushbutton, of the device. Such actions, in relation to a single rocker, will be labelled with letters A and B.

When one side of a rocker is pressed, the device sends on the KNX bus the telegram (or sequence) associated to the corresponding function according to how the device is programmed.

In the most common situation, for instance, one side of the rocker might send an “ON” telegram for a lighting unit, while the other side would send the “OFF” telegram for the same unit. Another typical application would be for one side of the rocker to increase the brightness of a dimmed light (and respectively decrease it for the opposite side), or to raise / lower a curtain or blind and so on.

The two functions associated with a rocker can also be programmed to perform exactly the same operation, thereby effectively causing one rocker to act as a single pushbutton.



The use of the entire activation surface of the rocker as if it is a single rocker is programmed by defining the function B as “in parallel with function A as a single function”. This use is configurable only in combinations a), b) and c) (see **Errore. L'origine riferimento non è stata trovata.**): for instance, it is possible to link only one function to combination a) with a single square rocker.

In combination d) with 4 rectangular horizontal rockers it is possible to link only functions other than function A and function B.

2.3 LED indicators

Each one of the 2 rocker sides is equipped with 4 high efficiency LEDs with different colour combinations blue/green and red/white, which can be freely programmed (also with functions not related to the rockers' functions) e.g. as status feedbacks of the loads or as orientation nightlight.

For a more detailed description of LED position and related settings please refer to the application section of this manual.

2.4 Light and temperature sensors

The light sensor is placed in the middle of the front plate of the naked unit, where a small hole is noticeable; it is designed to pick up the ambient light through the gap between rocker faceplates. The temperature sensors is embedded inside the plastic casing, close to the bottom edge of the front plate.

Both sensors are filtered by the software of the device in order to supply a stable measurement of real environmental parameters, avoiding short transitory disturbances.

The rocker plate assembly is arranged in such a way as to prevent that the sensors are obstructed in their function. Only in combination a) (see **Errore. L'origine riferimento non è stata trovata.**), though, one of the rocker is placed in front of the light sensor; the user must therefore be aware that in such configuration the light sensor feature is not available.

There is a reminder in the application program that reminds the user of the limitation if this combination is selected.

2.5 Customization of rocker plates

Rocker plates can be customized with predefined symbols and texts; for more information see the standard library on the ekinex® catalogue or the website www.ekinex.com. On request, a customization is also possible with symbols and texts chosen by the customer.



For further technical information, please also refer to the product datasheet STEKED2TP_IT.pdf available on the ekinex website www.ekinex.com.

3 Switching, display and connection elements

The front side of the device is fitted with mounting hooks for the rocker faceplates; between the hooks there are the pushbuttons and on the lateral sides the LEDs for status indication are placed.

On the rear side, the device is equipped with a programming pushbutton, a programming status LED and terminals for connecting the KNX bus line.

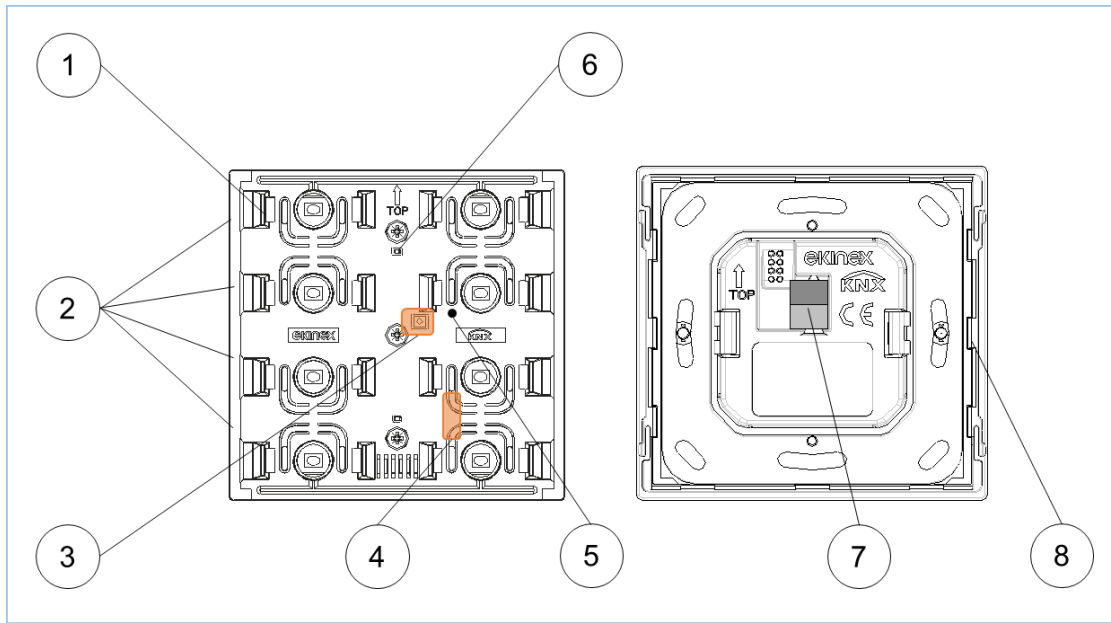

Figure 1 – Switching, display and connection elements

- | | |
|---------------------------|------------------------------------|
| 1. Rocker faceplate hooks | 5. Programming pushbutton |
| 2. LED diffusers | 6. Programming LED |
| 3. Light intensity sensor | 7. Terminal block for KNX bus line |
| 4. Temperature sensor | 8. Adapter |

4 Configuration

The exact functionality of the device depends on the software settings.

In order to configure and commission the device you need ETS4 or later releases and the ekinex® application program, APEKED2TP##.knxprod, which can be downloaded from the ekinex website www.ekinex.com.

The application program allows the configuration of all working parameters for the device.

The device-specific application program has to be loaded into ETS or, as alternative, the whole ekinex® product database can be loaded; at this point, all the instances of the selected device type can be added to the project.

For every single device, ETS allows to set the operating parameters separately for each function as described in detail in the following chapters.

The configuration can, and usually will, be performed completely offline; the actual transfer of the programmed configuration to the device takes place in the commissioning phase.

Product code	EAN	No. of channels	ETS application software (## = release)	Communication objects (max no.)	Group addresses (max no.)
EK-ED2-TP		8	APEKED2TP##.knxprod	221	254



Configuration and commissioning of KNX devices require specialized skills; to acquire these skills, you should attend training courses at a training centre certified by KNX.

For further information: www.knx.org.

5 Commissioning

After the device has been configured within the ETS project according to user requirements, the commissioning of the device requires the following activities:

- electrically connect the device, as described in the product datasheet, to the bus line on the final network or through a purposely setup network for programming;
- apply power to the bus;
- switch the device operation to programming mode by pressing the programming pushbutton located on the rear side of the housing. In this mode of operation, the programming LED is turned on steady;
- upload the configuration (including the physical address) to the device with the ETS program.

At the end of the upload, the operation of the device automatically returns to normal mode; in this mode the programming LED is turned off. Now the device is programmed and ready for use on the bus.

6 Function description

After switching on the bus, which also acts as a power supply, the device becomes fully functional after a very short time needed for reinitialization. A delay is programmable for the device to become active on the bus in order to avoid a bus traffic overload during the first moments of start-up of the whole network.

In case of a bus power failure (voltage lower than 19 V for 1 s or more), the device becomes unreactive: the timing functions are not active, neither are the programmed group addresses. As soon as the bus voltage is restored, the device will resume operation in its previous state (which is saved on power fail), unless different initialization settings are programmed.

6.1 Offline operation

A fully unprogrammed device does not operate in standby mode. Since the operation relies entirely on the exchange of information through communication objects, there is no part of the device that can operate independently from a KNX bus.

6.2 Online operation

In general the device works like a configurable digital sensor that is listening to own inputs or outputs of other devices. On input events the device performs output functionality over KNX bus like sending values or controlling external devices like KNX actuators.

6.3 Software working cycle

The main purpose of the software is following:

- Handle user pushbutton presses and generate bus telegrams according to the assigned functions;
- Implement pushbutton interlock and timing functions;
- Handle incoming bus messages in order to update the status of pushbutton activations and LED indicators;
- Respond to bus messages requesting feedback on the status of the inputs.

The status of the device and specifically of its entities (pushbutton / rocker activation status and LED indicators) relies on KNX *communication objects*, which can be freely defined and bound in various ways to the physical elements of the device.

There are also special events on which it is possible to trigger additional features. These events are the bus failure and recovery, and the download of a new configuration with ETS.

6.4 Pushbutton inputs

The press of a pushbutton can be bound to different effects on a state variable.

6.4.1 Pushbutton input events

A button press can be handled either as an “on-off” event (“on” means when the button is pushed, “off” when it is released), or as a “short press - long press” event (whereby a time period can be defined to discriminate the duration of the “long” from the “short” press).

In both cases, for each of the two available events a separate action can be assigned that operates on a selected variable (actually, more than one; see below for details).

6.4.2 Lock function

For each input (or channel if inputs are coupled, see below), a lock feature can be enabled which allows to block the operation of an input through a message on a communication object.

When in a locked state, the input is effectively disabled.

A value (for each transition) can be specified to be assigned to the communication object upon entering or exiting the locked state.

The locked state can also be automatically activated when the bus is connected.

6.4.3 State variables (communication objects)

The variable that is changed by the input events can be one of the types available for KNX communication objects, i.e. for instance a 1-bit value (on-off), a 2-bit value or an integer value of larger size.

In all cases, each of the two events can:

- change the value of the variable to one of two definable values within its range (which is trivial in the case of the 1-bit value);
- toggle between the two defined values
- do nothing (value is unaffected)

This state variable, once assigned a group address, is actually a **KNX communication object**; as such, it undergoes the usual rules for communication objects, among which – for instance – the effect of flags to determine how the change of value affects the transmission of the objects.

6.4.4 Binding between Events and Communication objects

The above description is a little simplified in order to ease comprehension; as a matter of fact, to each event can be assigned not just one, but several communication objects (up to 8), even of different types. Each of these communication objects can have its own behaviour and its own associated value set.

6.4.5 Repeated send

For most features, is it possible to set the device to send a telegram not just when a value changes as a consequence of an input transition, but also at regular intervals whenever that value setting is active.

This behaviour, also referred to as Cyclical Transmission, can be set separately for each of the two values that are associated to an input (or both, or none of them).

If an input is set to “*send values or sequences*” mode, repeated send is not available if more than 1 Communication Object is assigned to that input.

6.4.6 Input coupling

The 8 pushbutton inputs described can be considered, and used, as independent; however, due to the physical structure of the device and the nature of the functions it most frequently performs, these inputs can be naturally grouped in pairs, which in the application program are referred to as *channels*. Each channel is made of a pair of inputs, and is physically associated to a rocker.

Since the channels of the device are labelled 1 to 4, the inputs are labelled 1A / 1B for channel 1, 2A / 2B for channel 2 and so on. The same numbering is used whether the channel pairing is used or not.

In order to specify channel pairings, each rocker can be configured in two ways: single mode and coupled mode. This setting appears among rocker-level settings rather than input-level settings, because only inputs belonging to the same rocker can be coupled. The only combinations allowed for coupling are in fact 1A with 1B, 2A with 2B, and so on.

- In *single mode*, each input operates independently, has its own parameters and communication objects. This is the mode of operation described so far.
- In *coupled mode*, 2 inputs operate logically grouped under a channel in order to perform a common functionality; therefore, they operate on shared communication objects.

It is possible to configure some of the inputs in single mode and the others in coupled mode, with the pairing constraints just described.

It must be mentioned that there is actually a third way to configure an input pair, which lies somehow halfway between the two modes above (although it is considered as a variation of the single mode): each second input, i.e. inputs 1B, 2B, 3B etc., can be configured to perform exactly the same function as its first input. In this fashion, both pushbuttons associated with a rocker are effectively operated “in parallel”, so as to operate the whole rocker as a single, larger control (either pushbutton or switch, according to programmed operation).

Single and coupled modes have a similar functionality, but differ for the configuration.

6.4.7 Single or independent input mode

Each single input can be configured for one of following different features:

1. *Send values or sequences*

An event triggers the transmission on the bus of configurable values or sequence of values.

These values can be of a logical type or a numerical type with a different size.

A sequence of values can be made of up to 8 communication objects of different value types.

Time delays can set between values in the sequence.

2. *Dimmer control*

This mode is intended to be used with dimming actuators for the control of lighting devices.

The functionality is triggered on short press and long press events.

On short press events, the device sends on/off telegrams to the dimming actuator.

On long press events, the dimming percentage is varied up or down until the button is released.

3. *Shutter or Venetian blind control*

This mode is intended to be used together with actuators for the control of motorized blinds, shutters and similar devices. These actuators have functions for blind opening and closing; two movement types are selectable, i.e. continuous movement and stepwise movement. On input events, the device sends operation telegrams to the actuators.

The operation is configurable through following parameters:

- If *toggle* mode is enabled, on each activation of the same input the movement direction is inverted; if it is disabled, the movement direction is fixed and it can be set to “up” or “down”.
- If *blinds* mode is enabled, the device sends “full movement” telegrams on long press and “step” telegrams on short press; if it is disabled, the device sends “full movement” telegrams on long press and “stop” telegrams on short press.

4. *Scene function output*

This mode is intended to be used together with several KNX actuators that support using a scene function; this function allows storing and recalling a communication object value on an actuator.

In this mode, the role of the device is to send a “store / recall scene” telegram to the actuator on a long / short press event.

This mode has two possible configurations:

- Activate pre-set scene on short press, and store current setting as scene value on long press
- Activate two different scenes on long and short press.

6.4.8 Coupled input mode

Each pair of coupled inputs, corresponding to the two sides of a same rocker, can be configured for one of following different features (only the differences from the single mode are highlighted):

1. *Switch control*

Both inputs in a pair are bound to the same communication object; unlike single mode, the object can only be of the 1-bit type (on-off), therefore building a conventional switching behaviour.

The user can configure which of the two inputs sets the “off” or resp. “on” value.

2. *Dimmer control*

The functionality is triggered on short press and long press events of the inputs in the pair.

The user can configure which of the two inputs sets the “up” or resp. “down” value.

On short press events, the input configured as “up” sends an “on” switching telegram to the dimming actuator; while the “down” input sends an “off” telegram.

On long press events, the dimming percentage is varied up or down until the button is released.

3. *Shutter or Venetian blind control*

The two inputs of a pair are assigned to opposite movement directions; these can be assigned to inputs as desired, i.e. A up / B down or the other way around.

The *blinds* mode can also be set, and it works exactly as in single mode.

In coupled mode, there is no provision for a *scene* control feature.

6.4.9 Dimming function

The dimming function is a device application profile included in KNX specifics. Those specifics define the basic requirements for interface mechanisms, in addition to which some aspects regarding the operating modes, peculiar for each device (for both command or actuation devices) are to be considered.



All the information contained in this section have the purpose of illustrating specific device functions, and therefore are not to be necessarily considered exhaustive or applicable to other cases. In order to obtain a complete or generally applicable documentation, please refer to the official KNX documentation.

For further information, visit the website www.knx.org.

The dimmer control type is essentially based on a 4-bit communication object, whose data has the following format:

[3.007] Dimming (4 bit)		Step code	Step width														
<p>Move: 0 = Decrease, 1 = Increase</p> <p>Step width (001b...111b) or Stop (000b)</p>	<p>Bit number</p> <table border="1"> <tr> <td>3</td> <td>2</td> <td>1</td> <td>0</td> </tr> </table>	3	2	1	0	<p>Increase</p> <table border="1"> <tr> <td>1</td> <td>x</td> <td>x</td> <td>x</td> </tr> </table>	1	x	x	x	<p>Increase (100%)</p> <table border="1"> <tr> <td>1</td> <td>0</td> <td>0</td> <td>1</td> </tr> </table>	1	0	0	1	001	100%
	3	2	1	0													
	1	x	x	x													
	1	0	0	1													
		<p>Decrease</p> <table border="1"> <tr> <td>0</td> <td>x</td> <td>x</td> <td>x</td> </tr> </table>	0	x	x	x	<p>Decrease (100%)</p> <table border="1"> <tr> <td>0</td> <td>0</td> <td>0</td> <td>1</td> </tr> </table>	0	0	0	1	010	50%				
	0	x	x	x													
	0	0	0	1													
		<p>Stop</p> <table border="1"> <tr> <td>0</td> <td>0</td> <td>0</td> <td>0</td> </tr> </table>	0	0	0	0		011	25%								
0	0	0	0														
				100	12%												
				101	6%												
				110	3%												
				111	1%												

The transmission of telegrams containing data of such format tells the actuator to perform an increase or a decrease, by an amplitude equal to the specified step, or to stop an ongoing variation.

The increase or decrease of an intensity value by the actuator is not instantaneous but gradual; therefore, an increase / decrease command with interval equal to the maximum allowed value has the effect of starting the intensity variation in the desired direction, which will continue until the maximum (or minimum) value has been reached. Such variation can be stopped, once the desired intensity value has been reached, by sending a “stop” command.

It is normally possible, and desirable, to have the possibility to instantly switch on or off the load (i.e. to instantaneously bring its value from 0% to 100%). In order to achieve that, an “On / Off” command based on another object is used; this is the same object used for the normal load switch, which is present also in absence of a dimming mechanism.

The command device – in this case, the rocker unit – will define the operations to generate a sequence of commands with an opportune order and time interval, in order to achieve the desired command effect.

In case of unit EK-Ex2-TP, the defined operations and related commands are the following:

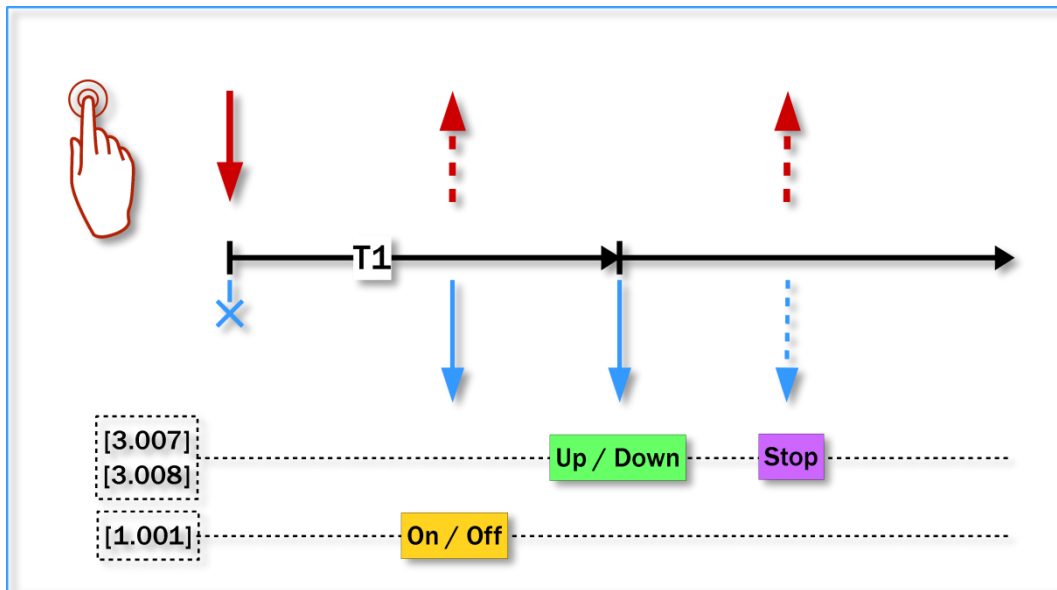

Figure 2 – Dimmer mode command sequence

- Short press: instantaneous switch on / off (toggle on / off on a switch object);
- Long press: increase / decrease value until 100% / 0%;
- Release: stop increase / decrease.

Please note that the same mechanism can be applied to the shutter or venetian blind control (in that case, “maximum / minimum” is substituted with “open / close”). For this purpose, the data type (DPT) 3.008 exists, whose structure and values are identical to those already described; in order to control a shutter with the same mode, it is possible to connect a communication object type 3.007 command side, to an object type 3.008 actuator side (if foreseen). In this case, obviously, the object type “On / Off” which allows instantaneous switch on / off is not used.

6.4.10 Shutter / venetian blind function

The “Shutter / venetian blind” function is a bundle of application profiles included in KNX specifics. As for dimming function, such specifics define basic requirements related to interface mechanisms, in addition to which some aspects regarding the operating modes, peculiar for each device (for both command or actuation devices) are to be considered.



All the information contained in this section have the purpose of illustrating specific device functions, and therefore are not to be necessarily considered exhaustive or applicable to other cases. In order to obtain a complete or generally applicable documentation, please refer to the official KNX documentation.

For further information, visit the website www.knx.org.

In case of shutters, the actuator brings a mechanic component from one point to another in a gradual way, with possibility to stop at intermediate points; the command is carried out by 2 lines which, when activated (one line at a time) make the actuator move in the corresponding direction.

A venetian blind is essentially a shutter that, in addition to the up / down movement, is also equipped with slats that can be opened / closed same way as a shutter (gradual movement between extreme points). The peculiarity is that normally the slat's movement and the up / down movement are controlled by the same two lines; therefore, the activation of the electromechanic device must be carried out according to a specific sequence. For further detail please check the actuator's documentation; in this document all we need to point out is that, command side, the control sequences can be considered as independent from these aspects.

The basic control for a shutter or a venetian blind is essentially based on three 1-bit communication objects:

- [1.008] Move Up/Down
- [1.007] Stop – Step Up/Down
- [1.017] Dedicated Stop

The effect of the commands linked to these objects is the following:

- The command “Move”, when received, starts the movement of the shutter in the indicated direction.
- The command “Stop – Step” has two functions: if the shutter is stopped, it moves by one step in the indicated direction (the duration is set in the actuator), if not, it stops the ongoing movement without doing anything else.
- The command “Stop” just stops the ongoing movement.

In addition, other types of control objects are normally available (“dimmer” type, absolute position, etc.) but they are not part of the basic control on which this manual is about; for further information please refer to the actuators' manual or KNX specifics.

In the simplest version, on command side:

- In order to control a shutter at least the objects “Move” and “Stop” are required (and present).
- In order to control a venetian blind at least the objects “Move” and “Stop – Step” are required (and present).

On actuator side – whether it is a shutter or a venetian blind – the presence of objects “Move” and “Stop – Step” must be guaranteed, while the presence of the object “Stop” is optional (but usually present).

As for the operations to perform on the command device, in our specific case the rocker unit, in order to generate a sequence of these commands with the proper order and time interval, there are multiple possibilities.

In case of ekinex input devices, two modes are available – indicated as “Shutter” and “Venetian blind” based on their typical destination – which are illustrated in the following figure.

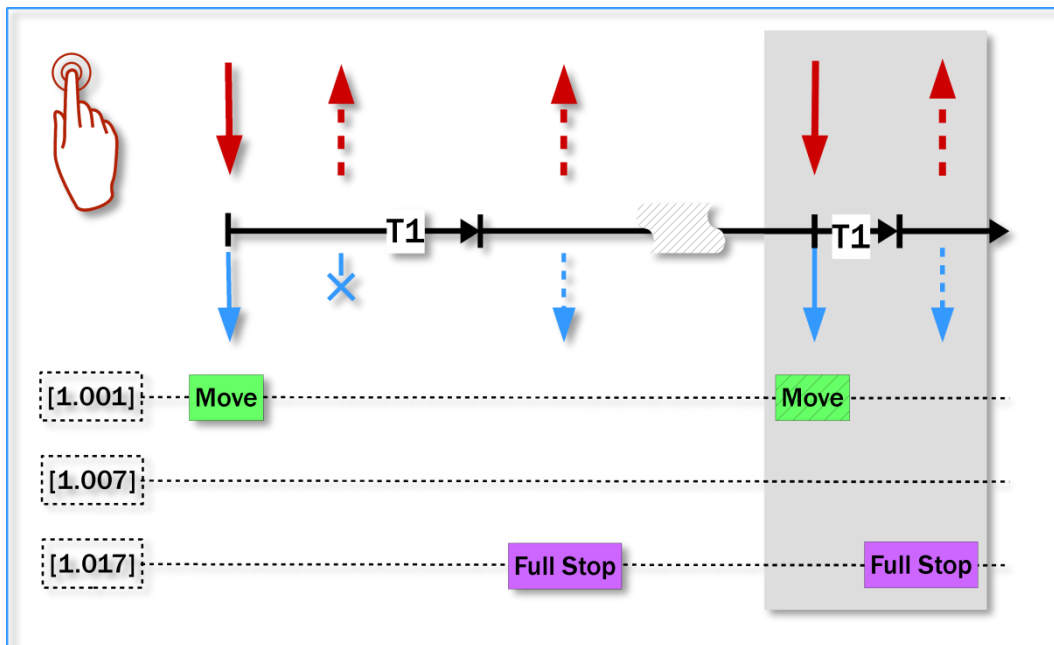

Figure 3 – “Shutter” mode command sequence

In “Shutter” mode, when a rocker is pressed – or a digital input is activated – the shutter starts moving in the corresponding direction (which can be alternatively in the two directions if the rocker is in independent mode and has been configured as *toggle*).

If the rocker is released quickly, the shutter will continue its run until full opening or closing; it is still possible to stop it by pressing again the rocker with a long press.

If the rocker is pressed with a long press, when it is released – which will be in correspondence with the desired position – the shutter will stop.

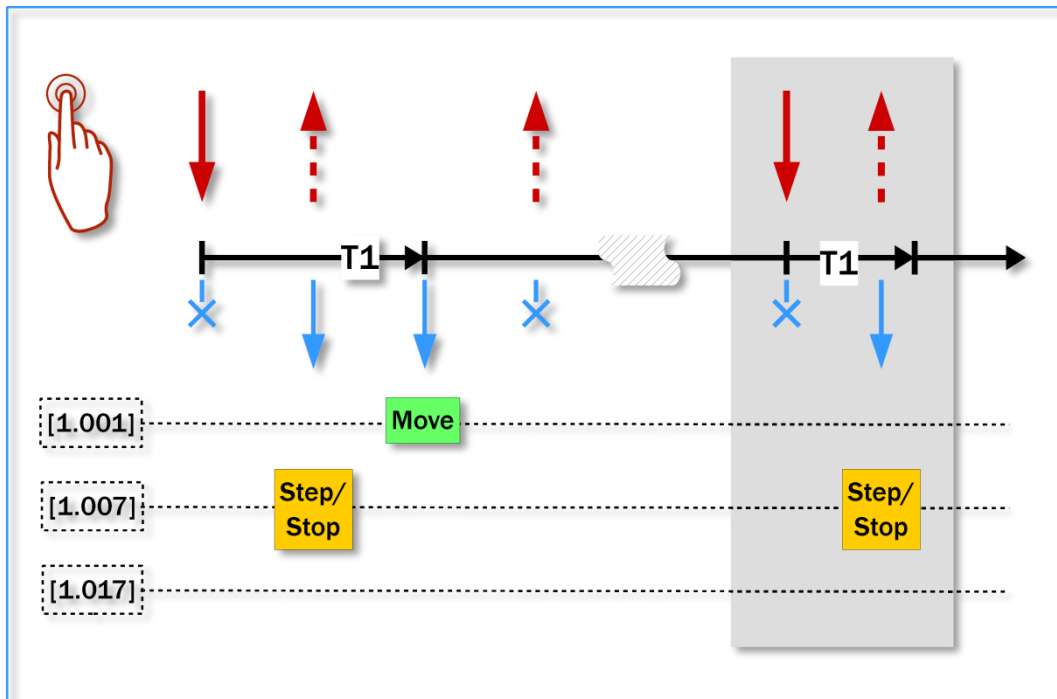

Figure 4 – “Venetian blind” mode command sequence

In “Venetian blind” mode, on release of a rocker after a short press, the venetian blind performs a step; this operation, normally – i.e. even if the actuator is indeed configured for a venetian blind – is used for the slats regulation.

If the rocker is pressed with a long press, when the threshold time is reached, a “Move” command is issued, which will bring the venetian blind to full open or close. In order to stop it at an intermediate position, the rocker needs to be pressed again (short press).

6.5 LED indicators

The LED indicators associated with each input are two (first colour and second colour) and can be singularly addressed, even if the corresponding inputs are coupled.

6.5.1 General parameters

All LEDs have a common intensity value, which can be set from the bus through a communication object or with a fixed setting from 0 to 100% in 10% steps.

An automatic change in intensity with ambient light can be obtained through a parameter setting found in the “*Light sensor*” section (see below).

6.5.2 Individual parameters

Each LED can be driven in one of following ways:

- Fixed value (always on or always off);
- Lit when the corresponding input is activated. In this option, an additional off-delay can be specified after the button is released;
- Status set from the bus through a communication object. In this case, the LED can be set to be flashing when active (with a choice of different on/off time combinations), and the on/off light status can be inverted with respect to the communication object status (so as to have the LED on when the CO has an “off” value).

6.5.3 Technical Alarm indicator

The device has a peculiar indicator feature called *Technical Alarm*: if it is enabled, all LEDs at the four corners of the device can be activated flashing through a KNX bus telegram. In particular, the activation of the technical alarm generates the blue LEDs activation in BG version (colour of the LEDs: green and blue), while the red LEDs activation in RW version (colour of the LEDs: red and white). For further information about the LEDs position and configuration parameters please refer to the application section of this manual.

This feature is meant as an indicator for a generic alarm condition, but it can be used in a custom way as the user sees fit.

6.6 Light and temperature sensors

The values from the embedded light and temperature sensors, unless they are disabled, can be read from the bus by other devices. In addition, their behaviour can be modified through following parameters:

6.6.1 Light sensor

The raw value read from the sensor can be multiplied by a settable factor in order to obtain a custom-scaled value.

The sensor value can periodically be sent on the bus with a specified transmission interval; in addition, the value can be sent whenever a specified variation occurs. These mechanisms can be used together; they can also be individually disabled.

The definition of threshold values for the light intensity is also possible; two independent threshold point settings are available, each of them with its own related communication object.

Each threshold has an associated limit value, for which it can be specified if the activation happens for higher or lower values.

The activation trigger has a definable hysteresis (from 5% to 40%) and an optional retransmission time interval; these two parameters are in common to both thresholds.

A parameter setting allows using the light intensity value measured by the sensor to determine the LED intensity, with different proportionality degrees and both with a direct or inverse relation (i.e. increase the LED intensity when ambient light increases or vice-versa).

The above functions are not mutually exclusive, i.e. they can be activated together as desired.

6.6.2 Temperature sensor

The raw value read from the sensor can be corrected with a small offset (-5 °C to +5 °C in steps of 0.5 °C), in order to compensate for environmental factors and achieve a better precision.

As for the light intensity, also for the temperature sensor the sensor value can periodically be sent on the bus with a specified transmission interval, and whenever a specified variation occurs.

6.7 Room thermostat

6.7.1 Use of sensors

The temperature controller integrated inside the pushbutton allows the room temperature acquisition in the following ways:

- 1) from the temperature sensor integrated inside the device;
- 2) via bus from another KNX device, e.g. another ekinex® pushbutton

In order to optimize or correct the temperature regulation in particular cases (big rooms, when there is a strong asymmetry in temperature distribution, when the pushbutton is installed in wrong or unsuitable positions, etc.) the device can use a weighted mean between two temperature values. The weights are assigned according to the *Relative weight* parameter, which assigns a proportion to the values.

Note on mounting position



If the integrated temperature regulator is used, the device must be preferably installed on an internal wall, at 1,5 m of height and at least 0,3 m of distance from doors. The device cannot be installed near heat sources such as radiators or domestic appliances or in positions subjected to direct solar irradiation. If necessary, for the regulation can be used a weighted mean value between the measured temperature acquired by the integrated sensor and a value received via bus from another KNX device.

6.7.2 Applications

The applications that can be configured are peculiar to thermal plants with a single stage and concern the following terminals: radiators, electric radiators and radiant panel systems.

The temperature control can be:

- two point control with hysteresis, ON-OFF command type;
- proportional-integral, with ON-OFF command, PWM or continuous type.

6.7.3 Control algorithms

The picture below shows the components of a common generic control system for ambient temperature. The room thermostat measures the actual temperature of the air mass (T_{eff}) and constantly compares it to the setpoint value (T_{set}).

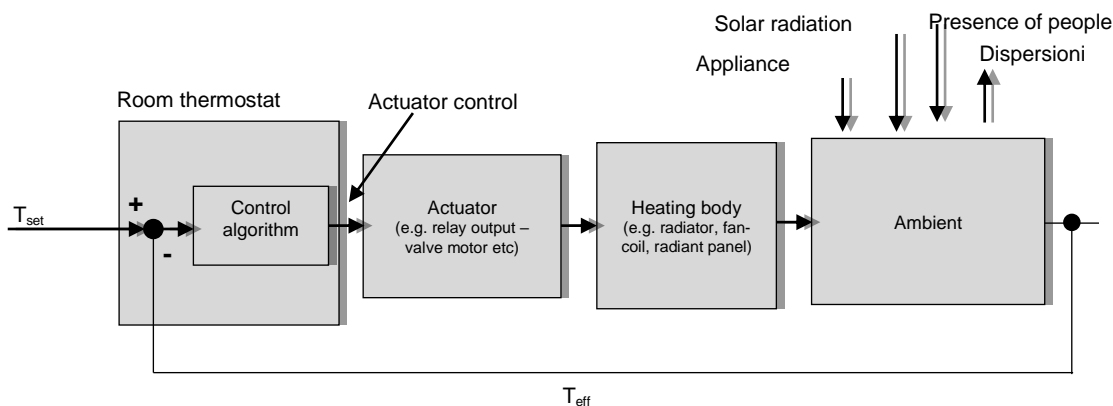

The control algorithm, basing on the difference between T_{set} and T_{eff} , processes a command value which can be analogue or On / Off type; the command is represented by a CO that is transmitted via bus, periodically or event based, to a KNX actuator device.

The output of the actuator device is the driving variable of the control system, which can be e.g. a flow rate of water or air. The control system realized by the room thermostat is of feedback type, namely the algorithm takes into account the effects on the system in order to change the control action on the same entity.

6.7.3.1 Two-point control with hysteresis

This control algorithm, which is also known as On / Off, is the most classic and popular. The control provides for the on / off switching of the system following a hysteresis loop, i.e. two threshold levels are considered for the switching instead of a single one.

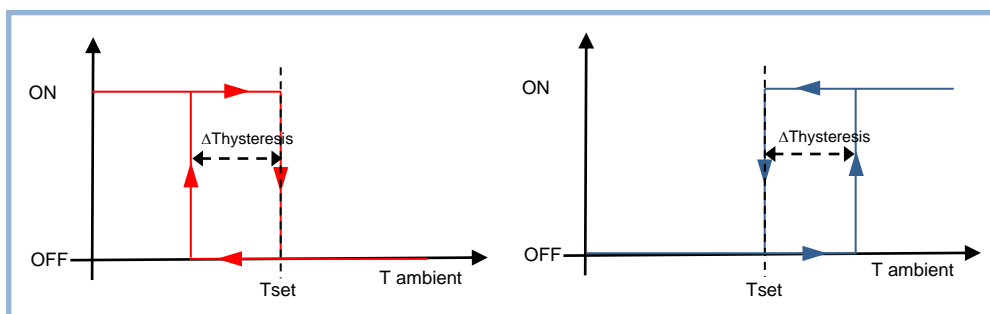

Heating mode: when the measured temperature is lower than the value of the difference ($T_{set} - \Delta T_{hysteresis}$), whereby $\Delta T_{hysteresis}$ identifies the differential adjustment of the boilers, the device activates the heating system by sending a message or KNX telegram to the actuator that handles the heating system; when the measured temperature reaches the desired temperature (Setpoint), the device disables the heating system by sending another message. In this way, there are two decision thresholds for activation and deactivation of the heating, the first being the level ($T_{set} - \Delta T_{hysteresis}$) below which the device activates the system, whereas the second is the desired temperature above which the heating system is deactivated.

Cooling mode: When the measured temperature is higher than the value of the difference ($T_{set} + \Delta T_{hysteresis}$), whereby $\Delta T_{hysteresis}$ identifies the differential adjustment of the cooler, the device activates the air conditioning system by sending a message or KNX telegram to the actuator that handles it; when the measured temperature falls below the desired temperature T_{set} the device turns off the air conditioning system by sending another message. In this way, there are two decision thresholds for activation and deactivation of the cooling: the first being the level ($T_{set} + \Delta T_{hysteresis}$) above which the device activates the system, whereas the second is the desired temperature below which the air conditioning system is deactivated. In the ETS application program, two different parameters are available for the hysteresis value for both heating and cooling: the values usually differ depending on the system type and its inertia.

In those applications where floor or ceiling radiant panels are present, it is possible to realize a different 2-point room temperature control. This type of control must be paired either to a proper regulation system for flow temperature that takes into account all internal conditions or an optimizer that exploits the thermal capacity of the building to adjust the energy contributions. In this type of control the hysteresis ($\Delta T_{hysteresis}$) or the room temperature high limit ($T_{set} + \Delta T_{hysteresis}$) represent the maximum level of deviation that the user is willing to accept during plant conduction.

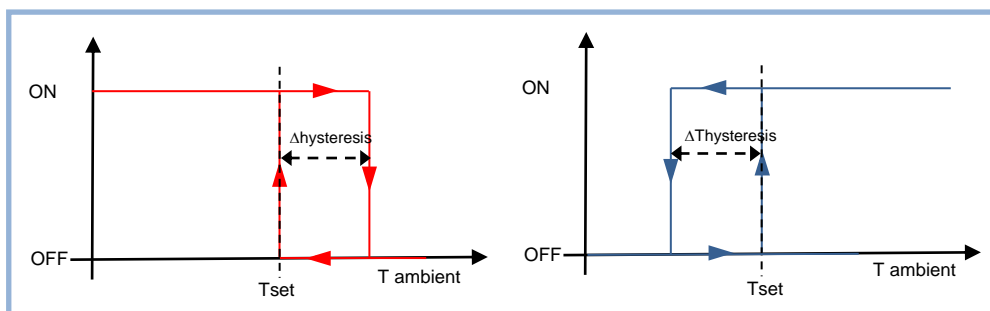

Heating mode – When the measured temperature is lower than the desired temperature T_{set} , the device activates the heating system by sending a message or KNX telegram to the actuator that handles it; when the measured temperature reaches the value $(T_{set} + \Delta T_{hysteresis})$, whereby $\Delta T_{hysteresis}$ identifies the differential adjustment of the boilers the device disables the heating system by sending another message. In this way, there are two decision thresholds for activation and deactivation of the heating, the first being the desired temperature T_{set} below which the device activates the system, whereas the second is the value $(T_{set} + \Delta T_{hysteresis})$, above which the heating system is deactivated.

Cooling mode – When the measured temperature is higher than the desired temperature T_{set} , the device activates the air conditioning system by sending a message or KNX telegram to the actuator that handles it; when the measured temperature reaches the value $(T_{set} - \Delta T_{hysteresis})$, whereby $\Delta T_{hysteresis}$ identifies the differential adjustment of the air conditioning system, the device disables the air conditioning system by sending another message. In this way, there are two decision thresholds for activation and deactivation of the air conditioning system: the first being the desired temperature T_{set} above which the device activates the system, whereas the second is the value $(T_{set} - \Delta T_{hysteresis})$ below which the air conditioning system is deactivated.

In the ETS application program, two different parameters are available for the hysteresis value for both heating and cooling: the values usually differ depending on the system type and its inertia.

In the ETS application program, the default 2-point hysteresis control algorithm foresees inferior hysteresis for heating and superior for cooling. If Heating and/or cooling type = floor radiant panels or ceiling radiant panels, it is possible to select the hysteresis position according to the described second mode, i.e. with superior hysteresis for heating and inferior for cooling.

The desired temperature (T_{set}) is generally different for each one of the 4 operating modes and for heating/cooling modes. The different values are defined for the first time during ETS configuration and can be modified later on. In order to optimize energy saving (for each extra degree of room temperature, outbound dispersions and energy consumption go up 6%), it is possible to take advantage of the multi-functionality of the domotic system, for example with:

- Hour programming with automatic commutation of the operating mode by means of KNX supervisor;
- Automatic commutation of the operating mode according to presence of people in the room;
- Automatic commutation of the operating mode according to window opening for air refreshment;
- Circuit deactivation when desired temperature is reached;
- Flow temperature reduction in case of partial load.

6.7.3.2 Continuous Proportional-Integral control

The continuous proportional-integral (PI) controller is described by the following equation:

$$\text{control variable}(t) = Kp \times \text{error}(t) + Ki \times \int_0^t \text{error}(\tau) dt$$

whereby:

$\text{error}(t) = (\text{Setpoint} - \text{Measured temperature})$ in heating

$\text{error}(t) = (\text{Measured temperature} - \text{Setpoint})$ in cooling

$Kp = \text{proportional constant}$

$Ki = \text{integral constant}$

The control variable is composed by 2 numbers, one depending proportionally from the error and one depending from the integral of the error itself.

Practically, some more intuitive values are used:

$$\text{Proportional Band BP [K]} = \frac{100}{Kp}$$

$$\text{Integral Time Ti [min]} = \frac{Kp}{Ki}$$

The Proportional Band is the error value that determines the maximum span of the control variable at 100%.

For example, a controller with Proportional Band = 5 K regulates at 100% when Setpoint = 20°C and Measured Temperature is ≤ 15 °C in heating mode; in cooling mode, it regulates at 100% when Setpoint = 24°C and Measured Temperature is ≥ 29°C. As shown in figure, a controller with a narrow Proportional Band provides higher control variable values for smaller errors compared to a controller with a wider Proportional Band.

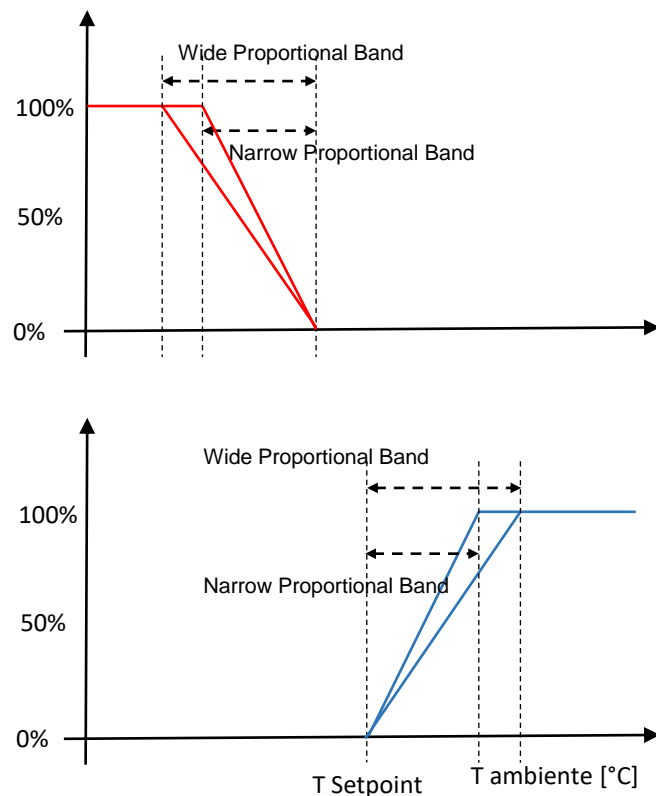

Integral Time is the amount of time necessary to repeat the value of the control variable of a purely proportional controller, when error is constant. For example, with a purely proportional controller with Proportional Band = 4 K, if Setpoint = 20°C and Measured Temperature = 18°C, the control variable will be 50%. If Integral Time = 60 minutes, if error remains constant, the control variable will be 100% after 1 hour, i.e. the controller will add to the control variable a contribution equal to the value due to its proportional part.

In heating and air conditioning systems, a purely proportional controller cannot guarantee reaching the Setpoint. An integral action is mandatory in order to reach the Setpoint: for this reason, the integral action is also called automatic reset.

6.7.3.3 PWM Proportional-Integral control

The proportional-integral PWM (Pulse Width Modulator) controller uses an analogue control variable to modulate the duration of the time intervals in which a binary output is in the On or Off state. The controller operates in a periodic manner over a cycle, and in each period it maintains the output to the On value for a time proportional to the value of the control variable. As shown in the figure, by varying the ratio between the ON time and the OFF time, the average time of activation of the output varies, and consequently the average intake of heating or cooling power supplied to the environment.

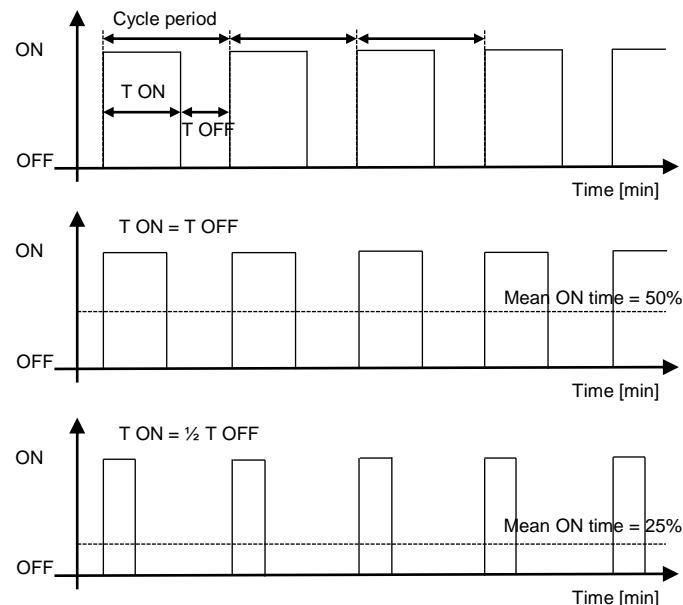

This type of controller is well suited for use with On / Off type actuators, such as relays and actuators for zone valves, which are less expensive (both for electrical and mechanical components) than proportional actuators. A distinctive advantage of this type of controller, compared with the raw On / Off controller already described, is that it eliminates the inertia characteristics of the system: it allows significant energy savings, because you avoid unnecessary interventions on the system introduced by the 2-point control with hysteresis and it only provides the power required to compensate for losses in the building.

Every time the user or the supervisor changes the desired temperature setpoint, the cycle time is interrupted, the control output is reprocessed and the PWM restarts with a new cycle: this allows the system to reach its steady state more quickly.

Terminal type	Proportional Band [K]	Integral Time [min]	Cycle Period [min]
Radiators	5	150	15-20
Electrical heaters	4	100	15-20
Fan-coil	4	90	15-20
Floor radiant panels	5	240	15-20

Guidelines for choosing the proper parameters of a PMW Proportional-Integral controller:

- Cycle time: for low-inertial systems such as heating and air conditioning systems, short cycle times must be chosen (10-15 minutes) to avoid oscillations of the room temperature.
- Narrow proportional band: wide and continuous oscillations of the room temperature, short setpoint settling time.
- Wide proportional band: small or no oscillations of the room temperature, long setpoint settling time.
- Short integral time: short setpoint settling time, continuous oscillations of the room temperature.
- Long integral time: long setpoint settling time, no oscillations of the room temperature.

6.7.4 Setpoint management

The pushbutton is not equipped with any local interface to control the integrated room thermostat, therefore the temperature setpoint modifications need to be managed through communication objects coming from a supervisory device.

Three setpoint management modes are foreseen:

- Single setpoint
- Relative setpoints, heating/cooling switch over from bus
- Relative setpoints, automatic heating/cooling switch over

Single setpoint mode

In this mode, a unique communication object is exposed (*Input Setpoint*) to modify the desired temperature. This object can be updated cyclically or on event of change by the supervisory device. If power goes down, the last value is retained into the pushbutton's non-volatile memory. In case the object is not updated, the temperature controller acts anyway on default setpoints (both heating and cooling) set in the application program during commissioning.



If a temperature controller is set on both heating and cooling mode, it is necessary that the supervisory device also updates the input seasonal mode object (*Heating/cooling status in*, [1.100] DPT_Heat_Cool) in order to coherently switch over the controller's action.

If window contacts for energy saving are used, when detecting an open window the input setpoint freezes and the pre-set building protection setpoint is activated (the relative communication object is exposed and is different in heating or cooling mode).

Relative setpoints, heating/cooling switch over from bus

In this mode, 4 communication objects are exposed, one for each operating mode:

- Comfort setpoint
- Stand-by offset
- Economy offset
- Building protection setpoint

Stand-by and economy setpoints are represented as attenuations to the comfort setpoint in order to facilitate the supervisor management: by uniquely modifying the comfort setpoint, references for attenuated modes are automatically transferred. The values modified from bus are retained in the pushbutton's non-volatile memory.

With this mode, the supervisory device can develop an hour-based time scheduling by sending to the pushbutton the current operating mode (comm. obj. *HVAC mode in* [20.102] DPT_HVAC Mode). The default value for *HVAC mode in* corresponds to the comfort setpoint value.

Same as single setpoint management, if the temperature controller is set as both heating and cooling mode, it is necessary that the supervisory device also updates the input seasonal mode object (*Heating/cooling status in*, [1.100] DPT_Heat_Cool) in order to coherently switch over the controller's action.

Relative setpoints, automatic heating/cooling switch over

In this mode, 3 communication objects are exposed, for all operating modes:

- Comfort heating setpoint
- Building protection heating setpoint
- Building protection cooling setpoint

Stand-by and economy setpoints are represented as attenuations to the comfort setpoint and can only be modified in the application program during commissioning: by uniquely modifying the comfort setpoint, references for attenuated modes and for comfort cooling setpoint mode (through switch over dead band) are automatically transferred. The values modified from bus are retained in the pushbutton's non-volatile memory.

With this mode, the supervisory device can develop an hour-based time scheduling by sending to the pushbutton the current operating mode (comm. obj. *HVAC mode in* [20.102] DPT_HVAC Mode). The default value for *HVAC mode in* corresponds to the comfort setpoint value.

The switch over between operating modes is automatic and the information can be sent to other devices through communication object *Heating/cooling status out*, [1.100] DPT_Heat_Cool). Please refer to the section about heating/cooling switch over to learn more about switch over modes.

6.7.5 Operating modes

In Single Setpoint mode, 2 levels for each operating mode are available:

- Temperature setpoint
- Building protection setpoint

Time scheduling for attenuation can be realized by the supervisor, by directly modifying the temperature setpoint.

In Relative Setpoint mode, 4 different operating modes are available, which are mutually exclusive to one another:

- comfort;
- stand-by;
- economy;
- building protection.

Through ETS application program, it is possible to assign 2 different setpoint values to each operating mode, for comfort and building protection level, and two different attenuation levels for stand-by and economy, corresponding to both heating and cooling. Stand-by and economy setpoints are represented as attenuations to the comfort setpoint in order to facilitate the supervisor management: by uniquely modifying the comfort setpoint, references for attenuated modes are automatically transferred.

Each setpoint, except when automatic heating/cooling switch over is active, is exposed through communication objects. Setpoints and attenuations can be modified remotely through the exposed communication objects. The building protection setpoint intervention must be planned in ETS application program, as these parameters concern the safety and protection of the plant's components (especially during heating).

6.7.6 Heating/cooling switch over

The switch over between both heating and cooling mode can take place in 2 ways:

1. from KNX bus, through a communication object;
2. automatically, through a command from the internal logic of the device;

Switchover from bus

In mode 1, the switch over command is issued through KNX bus and therefore it is performed by a different KNX device, e.g. the ekinex® Touch&See unit. The integrated temperature controller acts as a "slave": the switch over is carried out by input communication object [DPT 1.100 heat/cool].

Automatic switch over

Mode 2 is suitable for applications with heating / cooling systems with a 4-pipe configuration (e.g. fan-coils or radiant ceiling panels). Also in this case the information can be transmitted on the bus through an output communication object [DPT 1.100 heat/cool]; the difference with mode 1 is that the switch over is performed automatically by the machine, basing on the values of current temperature and setpoint. The automatic switch over is achieved by introducing a dead band as shown in the following figure.

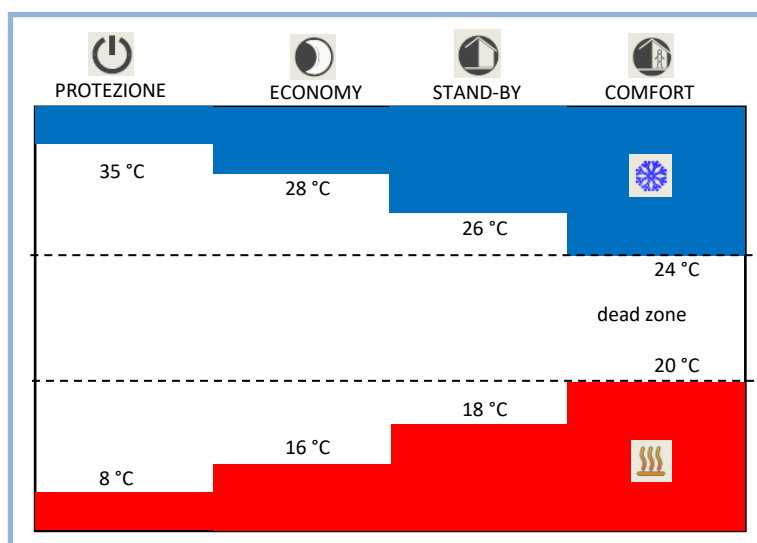

The figure shows that, as long as the actual measured temperature is below the heating mode setpoint, the heating mode is selected; similarly, if the value is greater than the cooling setpoint, then cooling mode is selected. If the value is within the dead band, the operation mode remains unchanged until the value itself passes over the threshold value associated with the opposite mode.



The 4 setpoints for heating mode and the 4 setpoints for cooling mode are not exposed through communication objects to avoid inconsistencies between the different levels of temperature. In this case, a single communication object is published, which corresponds to the comfort heating setpoint. Every time this parameter is changed, the whole dead band changes with it, as well as all setpoints related to the 4 operating modes: the automatic switch over is then triggered outside the defined dead band.

6.7.7 Window switch management

Window switch management is an optional feature, oriented to energy saving, which becomes available only if the *Temperature control* function is enabled in the application program.

Whenever a condition of opened window is detected, the operating mode is forced to “building protection” and it remains forced as long as the open window condition is active. The program provides a time delay parameter for detection, in order to discriminate between an occasional short-term opening (e.g. to provide air exchange in the room) from an unintentional opening that justifies the power-saving function to be recalled.

The operating mode determined from Window switch management has priority on all operating mode settings imposed by the scheduler (in case *Setpoint management* = relative setpoint)

The physical detection of window openings is normally performed through switches that can be connected to KNX input devices; the pushbutton exposes up to 2 1-bit communication objects (*Temperature control* tab ⇒ External sensors) which can be synchronized to the switches' states.

The internal logic performs a logical OR operation of the acquired contacts: the energy saving function is therefore activated if at least one window switch activation is detected. In order to determine the physical state of the contact corresponding to the “open window” state, two different options can be selected:

- NC (normally closed): open contact stands for closed window, closed contact stands for open window;
- NO (normally open): open contact stands for open window, closed contact stands for closed window;

6.7.8 Valve protection function

The function is suitable for both heating and cooling systems that use water as thermal conveying fluid and are provided with motorized valves for the interception of a zone or of a single room. Long periods of inactivity of the system can lead to the blockage of valves: to prevent this, the room temperature controller may periodically send a command to open / close the valve in the period of inactivity of the system. This possibility is further defined by the frequency and duration of the valve control.

6.7.9 Temperature control alarm

The integrated temperature controller can stop the internal control algorithm for one of the following reasons:

- For an external event, which can be configured and linked to the *Thermal generator lock* communication object;
- For an internal temperature sensor's fault (measured room temperature too low while NTC resistance value is too high or vice versa);
- For a timeout (data not updated by the bus) when a weighted mean between the internal sensor's value and an auxiliary external sensor's value is used.

When one of these events occur, the internal controller stops the control algorithm and the command output is taken to complete closing position (OFF or 0%): this state is signalled through the communication object *Temperature control alarm*.

6.8 Logic functions

The KNX pushbutton allows to use some useful logic functions (AND, OR, NOT and exclusive OR) in order to implement complex functions in the building automation system.

You can configure:

- 8 channels of logical functions
- 4 inputs for each channel

Each object value, if desired, can be individually inverted by inserting a NOT logic operator.

The inputs created by the objects are then logically combined as shown in the following figure:

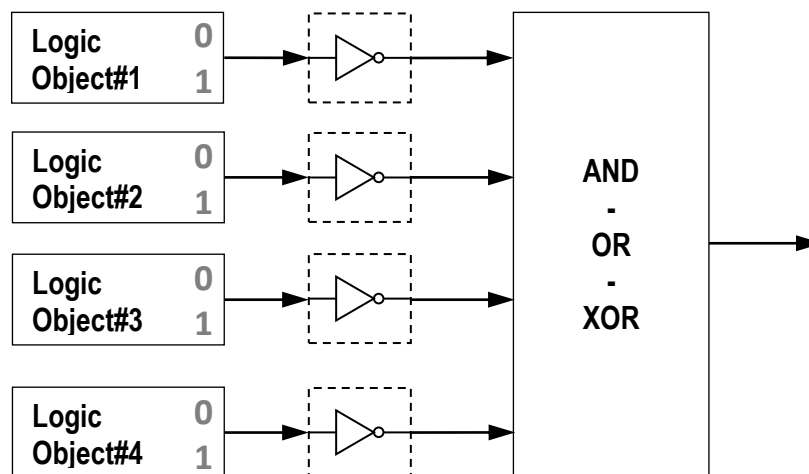

Figure 5 – Logic combination function

The logic block on the right side of the figure has the following function, based on the selected operation:

- OR – the output is ON if at least one input is ON;
- AND – the output is ON if all inputs are ON;
- XOR – the output is ON if an odd number of inputs is ON;

This last function is more intuitive when there are only 2 inputs: in this case, the output is ON when one input or the other one is ON, but not the two of them simultaneously.

Please note that in this description, with “input” and “output” we refer only to the logic block; for the device operation, the effective “inputs” are given by communication objects, so also the possible activation of NOT logic operators has to be considered.

The following figures show the basic logic functions, assuming 2 inputs and only one logic communication object:

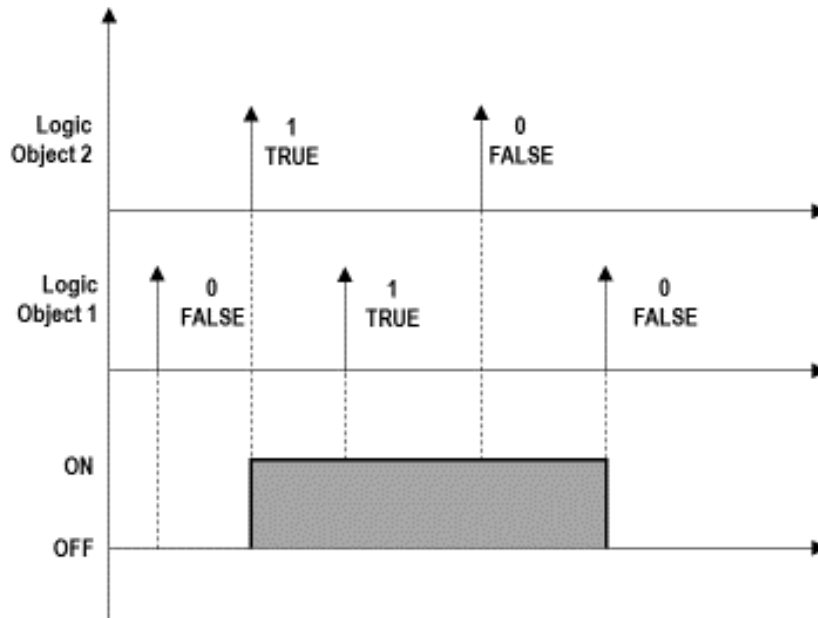

Figure 6 – Logic function OR

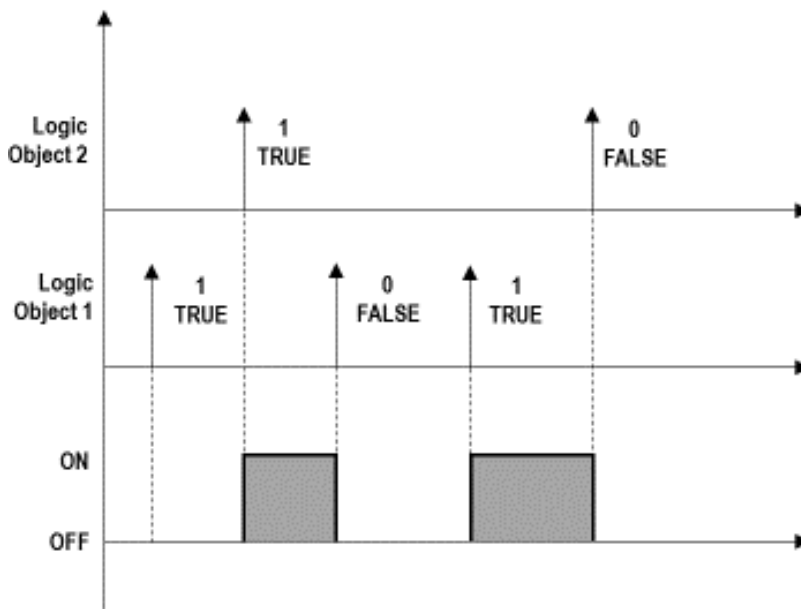

Figure 7 – Logic function AND

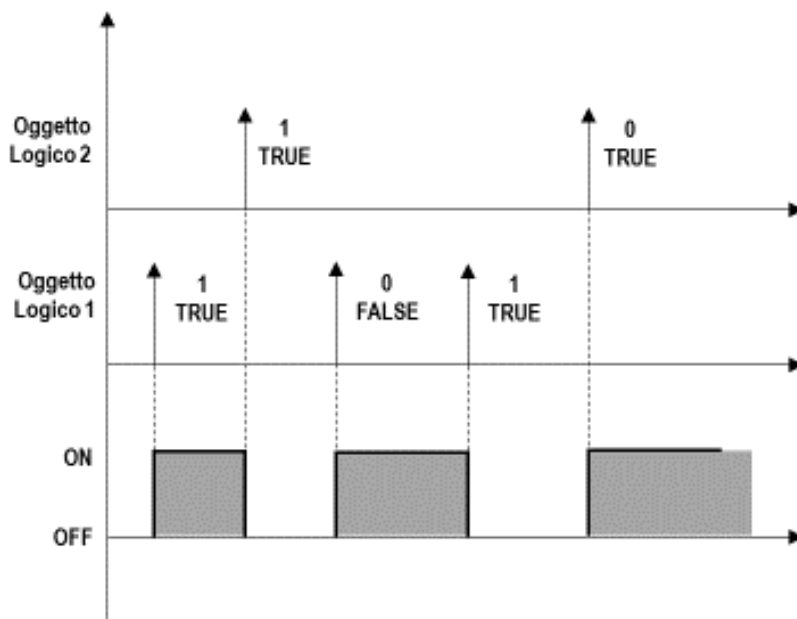

Figure 8 – Logic function Exclusive OR (XOR)

For each channel, a parameter *Delay after bus voltage recovery* is available: this parameter represents the time interval between the bus voltage recovery and the first reading of the input communication objects for evaluating the logic functions.



In case of incorrect connection of the input communication object or electrical trouble on bus resulting in a failed input reading request, the logic output of the corresponding channel can be calculated by setting the input values to default.

The communication function representing the logic function output is sent on the bus on event of change; alternatively, a cyclic sending can be set.

7 Application program for ETS

In the following chapters, there is the list of folder, parameters and communication objects of the application program.

Every channel, and every input or input pair under a channel, offers the same set of communication objects and parameters, but they may all be independently configured.

Hereafter, all channel-specific settings are listed grouped by channel; a generic channel number is referenced as “x” (where x = 1...4), while a generic input is referenced as “xx” (xx = 1A, 1B, 2A, ... 4B).



The parameter values highlighted in bold represent the default value.

The device settings are divided in two main groups: the *general* settings and the *channel-specific* settings. The settings are grouped in folders. The following figure shows the tree structure of the application program, with the main folders:

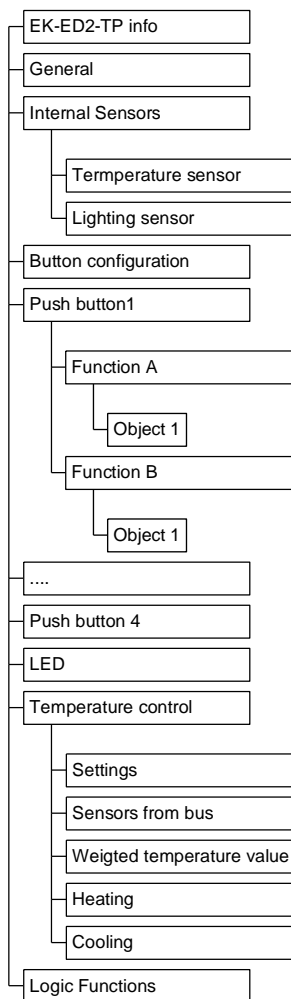

In order to use the device as a temperature sensor or as a room temperature controller it is sufficient to enable the temperature sensor in the *Internal sensors* folder. Consequently, also the *Temperature control* folder is activated: therefore, it is possible to select an auxiliary temperature sensor to perform a weighted mean with the main sensor and it is possible to configure the controller's options for room temperature.

7.1 About EK-ED2-TP

The folder **About EK-ED2-TP** is for information purposes only and does not contain parameters to be set. The information given is:

© Copyright SBS S.p.A. 2016
Software applicativo per ETS4
Versione 1.00 (o successive)
Comando a 2-4 pulsanti

SBS S.p.A.
Via Circonvallazione s/n
I-28010 Miasino (NO) Italy
www.ekinex.com
info@ekinex.com

7.2 General settings

The parameters in this section define the overall behaviour of the device, including the setting that defines which and how many channels are available.

Parameter name	Conditions	Values
Rockers configuration		See Fig. 10 and 11 for available options
	<i>Specifies the configuration of installed rocker plates, thereby determining how physical pushbuttons will be associated to logical inputs and coupled in rocker pairs.</i>	
Leds intensity from bus	-	yes / no
	<i>Specifies whether the intensity value of LEDs should be set through a communication object.</i>	
Leds intensity	Leds intensity from bus = no	0%..100% (50%)
	<i>Fixed intensity value of LEDs.</i>	
Delay after bus voltage recovery	-	hh:mm:ss.fff (00:00:04.000)
	<i>Delay before bus telegrams can be sent after a recovery of the bus voltage. The delay time affects the transmission generated by an event as well as the cyclical transmission. For the cyclical transmission: after the delay time finished, the cycle restarts and the first telegram will be sent after the cycle time.</i>	
Technical alarm	-	enabled / disabled
	<i>Enables a communication objects that activates an alarm indication through a bus telegram. The indication is made by flashing the four LEDs at the corners of the device. This indication is made available to the user for any purpose he sees fit (not necessarily an actual alarm).</i>	
Room temperature controller		enabled / disabled
	<i>Enables the folder containing the parameters for room temperature control.</i>	
Logic functions		enabled / disabled
	<i>Enables the folders to configure AND, OR e XOR logic functions and their relative input and output communication objects.</i>	

Object name	Conditions	Dimens.	Flags	DPT	No. Comm. Obj.
Technical alarm	Technical alarm = enabled	1 bit	C-W--	[1.005] alarm	0
Brightness value	Light sensor = enabled	2 Byte	CR-T-	[9.004] lux (Lux)	1
Temperature value	Temperature sensor = enabled	2 Byte	CR-T-	[9.001] temperature (°C)	3

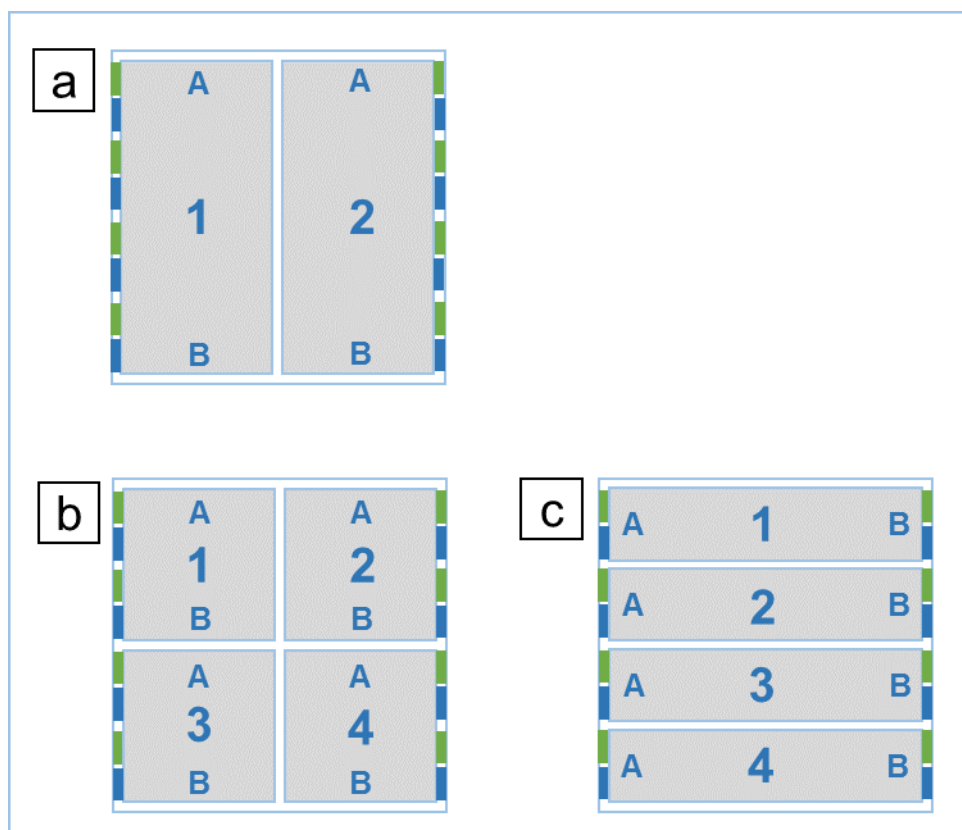

Figure 9 – BG version rockers' combination

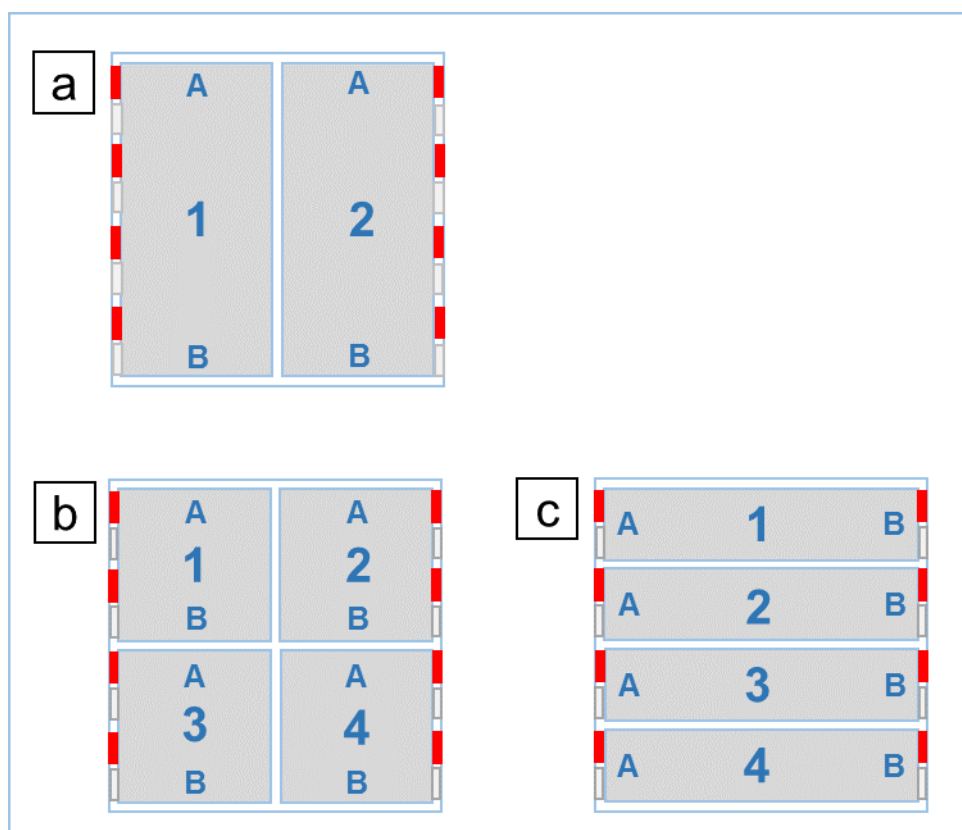

Figure 10 – RW version rockers' combination

The rockers' configuration is equivalent in BG (green and blue leds) and in RW (red and white).

Available rocker plate configuration options for 2-4 rocker pushbutton:

- a. 2 vertical rectangular rockers
- b. 4 square rockers
- c. 4 rectangular horizontal rockers

7.3 Internal sensors

Parameter name	Conditions	Values
Light sensor		disabled / enabled
	<i>Enables the light sensor by making the corresponding communication object available.</i>	
Temperature sensor		disabled / enabled
	<i>Enables the temperature sensor by making the corresponding communication object available.</i>	

Object name	Conditions	Dimens.	Flags	DPT	No. Comm. Obj.
Brightness value	Light sensor = enabled	2 Byte	CR-T-	[9.004] lux (Lux)	1
Temperature value	Temperature sensor = enabled	2 Byte	CR-T-	[9.001] temperature (°C)	3

7.3.1 Light sensor

Parameter name	Conditions	Values
Sensor value multiplier x0.1	Light sensor = enabled	1...255 (10)
	<i>Scale multiplier to be applied to the raw measured light intensity value. The specified value must be 10 times the desired value, e.g. a parameter value of 68 results in a multiplier value of 6.8.</i>	
Minimum change of value to send	Light sensor = enabled	0...670760 (50)
	<i>Minimum change in light intensity required to trigger the transmission of a new value. The parameter is referred to the value obtained after the correction through the scale factor. A value of 0 means that changes in the intensity value do not trigger transmission.</i>	
Transmission interval	Light sensor = enabled	hh:mm:ss (00:05:00)
	<i>Interval between cyclical transmissions. A value of 00:00:00 disables cyclical transmission.</i>	
LED intensity correlation	Light sensor = enabled	high inverse medium inverse small inverse none small direct medium direct high direct
	<i>Specifies whether the intensity value of LEDs should be related to the ambient light intensity as measured by the sensor, and to which degree. A direct correlation means that a higher ambient light intensity causes the LED to be brighter; the opposite holds for an inverse correlation.</i>	
Threshold 1	Light sensor = enabled	not active above below
	<i>Enables a first threshold level for light intensity values and defines whether the threshold activation occurs above or below the defined level.</i>	

Parameter name	Conditions	Values
Value [Lux]	Light sensor = enabled Threshold 1 = above or below	0...670760 (500)
	<i>Value for the first light intensity threshold level.</i>	
Threshold 2	Light sensor = enabled	not active above below
	<i>Enables a second threshold level for light intensity values and defines whether the threshold activation occurs above or below the defined level.</i>	
Value [Lux]	Light sensor = enabled Threshold 2 = above or below	0...670760 (500)
	<i>Value for the second light intensity threshold level.</i>	
Hysteresis	Light sensor = enabled Threshold 1 and/or 2 = above or below	5%...40% (15%)
	<i>Hysteresis value to be applies both light intensity threshold level.</i>	
Cyclic sending interval	Light sensor = enabled Threshold 1 and/or 2 = above or below	never , 1 min...120 min (choose among predefined values)
	<i>Defines whether the threshold activations must be cyclically transmitted on the bus and at which interval.</i>	

Object name	Conditions	Dimens.	Flags	DPT	No. Comm. Obj.
Light threshold 1 - Switch	Light sensor = enabled Threshold 1 = above or below	1 bit	CR-T-	[1.001] switch	20
	<i>Signals the activation status of first threshold.</i>				
Light threshold 2 - Switch	Light sensor = enabled Threshold 2 = above or below	1 bit	CR-T-	[1.001] switch	37
	<i>Signals the activation status of second threshold.</i>				

7.3.2 Temperature sensor

Parameter name	Conditions	Values
Filter type	Temperature sensor = enabled	low average high
	<i>Low = average value every 4 measurements Average = average value every 16 measurements High = average value every 64 measurements</i>	
Measured temperature correction	Temperature sensor = enabled	0°C [range -2,5°C ... +2,5°C]
Minimum change of value to send [K]	Temperature sensor = enabled	0,5 [range 0 ... 5]
	<i>If the parameter is set to 0, no value is sent for change</i>	

Parameter name	Conditions	Values
Cyclic sending interval	Temperature sensor = enabled	no sending [other values in range 30 s ... 120 min]
Threshold 1	Temperature sensor = enabled	not active below above
Value [°C]	Temperature sensor = enabled, Threshold 1 = above or below	7 [range 0 ... 50]
Threshold 2	Temperature sensor = enabled	not active below above
Value [°C]	Temperature sensor = enabled, Threshold 2 = above or below	45 [range 0 ... 50]
Hysteresis	Temperature sensor = enabled, Threshold 1 e/o Threshold 2 = above or below	0,4 K [other values in range 0,2 K ... 3 K]
Cyclic sending interval	Temperature sensor = enabled, Threshold 1 e/o Threshold 2 = above or below	no sending [other values in range 30 s ... 120 min]

Object name	Conditions	Dim.	Flags	DPT	No. Comm. Obj.
Temperature threshold 1 - Switch	Temperature sensor = enabled, Threshold 1 = above or below	1 Bit	CR-T--	[1.001] switch	162
Temperature threshold 2 - Switch	Temperature sensor = enabled, Threshold 2 = above or below	1 Bit	CR-T--	[1.001] switch	163

7.4 Rockers configuration

Parameter name	Conditions	Values
Rocker x	-	disabled independent or single coupled copy parameters from rocker*
<p>Set operation mode for inputs corresponding to Rocker x.</p> <p>The identification of which Rocker and associated input pushbuttons are corresponding to a given number (e.g. 1A – 2B – 4A etc.) is done according to parameter “General / Rockers configuration”.</p> <p>* This option is only available for rockers no. 2 and above. If selected, the corresponding rocker can be made to perform the exact same kind of function as another specified rocker, but <u>basing on different communication objects</u>.</p> <p>This allows sparing time in configuring the device, at the same time assuring that there is no inconsistency between two rockers that are meant to be configured in exactly the same way.</p> <p>To assign the same configuration is just a shortcut for the selection of configuration options; it is in no way implied that the two rockers share any of the involved communication objects (each rocker has its own independent objects).</p>		
Function A	Rocker x = independent or single	enabled / disabled
<p>Enables or disables the capability to generate events for the first pushbutton of the rocker.</p>		
Type	Rocker x = independent or single Function A = enabled	send values or sequences dimming shutter or venetian blind scene
<p>Determines the kind of function performed by the FIRST rocker input.</p> <p>Further parameters for the selected function will appear in the individual rocker configuration sections (see below).</p>		
Function B	Rocker x = independent or single	disabled enabled in parallel with function A, as a single function copy parameters from function A
<p>Enables or disables the capability to generate events for the second pushbutton of the rocker.</p> <p>If not disabled, the pushbutton can be given an own independent function (enabled), used as an “alias” of the first input (in parallel), or perform the exact same kind of function as first input (copy parameters), but possibly <u>basing on a different communication object</u>.</p>		
Type	Rocker x = independent or single Function B = enabled	send values or sequences dimming shutter or venetian blind scene
<p>Determines the kind of function performed by the SECOND rocker input.</p> <p>Further parameters for the selected function will appear in the individual rocker configuration sections (see below).</p>		
Type	Rocker x = coupled	switch dimming shutter or venetian blind
<p>Determines the kind of function performed by the FIRST and SECOND rocker input.</p> <p>Further parameters for the selected function will appear in the individual rocker configuration sections (see below).</p>		
Rocker to copy from	Rocker x = copy parameters from rocker (x > 1)	1..4*
<p>* The values that can be chosen obviously do not include the number of the rocker for which the selection is made.</p>		

7.4.1 Independent or single: send values or sequences

Object name	Conditions	Dimens.	Flags	DPT	No. Comm. Obj.
Rocker x – Switching status [type], object n	Rocker x = independent or single Function x = enabled Type = send values or sequences	according to the configuration (1-bit)	CRWTU	according to the configuration ([1.001] switch)	5, 22 (1A, 1B) 39, 56 (2A, 2B) 73, 90 (3A, 3B) 107, 124 (4A, 4B)
<p>Up to 8 objects can be defined for binding with the same event. The listed CO numbers are those referring to object nr. 1; the COs for each subsequent object are following in sequence. To obtain the CO numbers for object number n, just add (n-1) to the listed numbers. E.g.: COs associated to input 3A (of Rocker 3) have numbers from 81 to 89. The number of CO no. 5 is therefore 81+(5-1) = 85. The size and type of the individual objects can be configured as described in following sections.</p>					

7.4.2 Independent or single: dimming

Object name	Conditions	Dimens.	Flags	DPT	No. Comm. Obj.
Rocker x – Switching command	Rocker x = independent or single Function x = enabled Type = dimming	1 bit	CRWTU	[1.001] switch	13, 30 (1A, 1B) 47, 64 (2A, 2B) 81, 98 (3A, 3B) 115, 132 (4A, 4B)
<p>Send a command to a dimming actuator to switch the light on or off. The command is triggered by a short press on the input. The value sent can be a fixed value or it can be toggled at each input activation.</p>					
Rocker x – Dimming up / down / stop command	Rocker x = independent or single Function x = enabled Type = dimming	4 bit	CR-T-	[3.*] 3-bit control	14, 31 (1A, 1B) 48, 65 (2A, 2B) 82, 99 (3A, 3B) 116, 133 (4A, 4B)
<p>Send a command to a dimming actuator to change dimming intensity (brighter or darker). Three values are used which mean start increase, start decrease or stop the change.</p> <p style="text-align: center;"> <small>Increase</small> <small>Decrease</small> 1 0 0 0 0 0 0 1 </p> <p style="text-align: center;"> <small>Stop dimming</small> 0 0 0 0 </p> <p>Increase/decrease values are sent when a long press action occurs and stop value on press release. The value sent can be a fixed value or it can be toggled at each input activation.</p>					

7.4.3 Independent or single: shutter or venetian blind

Object name	Conditions	Dimens.	Flags	DPT	No. Comm. Obj.
Rocker x – Dedicated stop command	Rocker x = independent or single Function x = enabled Type = shutter or venetian blind	1 bit	CRWTU	[1.017] trigger	13, 30 (1A, 1B) 47, 64 (2A, 2B) 81, 98 (3A, 3B) 115, 132 (4A, 4B)
<i>Immediately stop any movement of the blind. The object is sent on a short press if the blind mode is disabled and at the end of a long press if the venetian blind mode is enabled.</i>					
Rocker x – Stop – step up/down command	Rocker x = independent or single Function x = enabled Type = shutter or venetian blind Blind mode = enabled	1 bit	CR-T-	[1.007] step	16, 33 (1A, 1B) 50, 67 (2A, 2B) 84, 101 (3A, 3B) 118, 135 (4A, 4B)
<i>Move the blind to fully open or fully closed position. The object is sent at the end of a long press.</i>					
Rocker x – Move up / down command	Rocker x = independent or single Function x = enabled Type = shutter or venetian blind	1 bit	CRWTU	[1.008] up/down	17, 34 (1A, 1B) 51, 68 (2A, 2B) 85, 102 (3A, 3B) 119, 136 (4A, 4B)
<i>Increase or decrease the opening of the blind stepwise. The object is sent on a short press.</i>					

7.4.4 Independent or single: scene

Object name	Conditions	Dimens.	Flags	DPT	No. Comm. Obj.
Rocker x – Scene number	Rocker x = independent or single Function x = enabled Type = scene	1 Byte	CR-T-	[17.*] Scene number [18.*] Scene control	18, 35 (1A, 1B) 52, 69 (2A, 2B) 86, 103 (3A, 3B) 120, 137 (4A, 4B)
<p><i>Store or recall a scene. The lowest 6 bits in the byte form the code of the scene, while the highest bit is the operation code (store or recall).</i></p> <p style="text-align: center;">1 Byte</p> <div style="text-align: center;"> <pre> graph TD subgraph Bit_7 [7] B7[7] end subgraph Bit_6 [6] B6[6] end subgraph Bit_5 [5] B5[5] end subgraph Bit_4 [4] B4[4] end subgraph Bit_3 [3] B3[3] end subgraph Bit_2 [2] B2[2] end subgraph Bit_1 [1] B1[1] end subgraph Bit_0 [0] B0[0] end B7 --- Op["0 = recall, 1 = save"] B6 --- SN["scene number (1-64)"] B5 --- SN B4 --- SN B3 --- SN B2 --- SN B1 --- SN B0 --- NU["not used"] </pre> </div>					

7.4.5 Coupled: switch

Object name	Conditions	Dimens.	Flags	DPT	No. Comm. Obj.
Rocker x – Switching command	Rocker x = coupled Function x = enabled Type = switch	1-bit	CRWTU	[1.001] switch	13, 47, 81, 115

7.4.6 Coupled: dimming

Object name	Conditions	Dimens.	Flags	DPT	No. Comm. Obj.
Rocker x – Switching command	Rocker x = coupled Function x = enabled Type = dimming	1 bit	CRWTU	[1.001] switch	13, 47, 81, 115
<i>See notes for independent input.</i>					
Rocker x – Dimming up / down / stop command	Rocker x = independent or single Function x = enabled Type = dimming	4 bit	CR-T-	[3.*] 3-bit control	14, 48, 82, 116
<i>See notes for independent input.</i>					

7.4.7 Coupled: shutter or venetian blind

Object name	Conditions	Dimens.	Flags	DPT	No. Comm. Obj.
Rocker x – Dedicated stop command	Rocker x = coupled Function x = enabled Type = shutter or venetian blind Blind mode = disabled	1 bit	CRWTU	[1.017] trigger	13, 47, 81, 115
<i>See notes for independent input.</i>					
Rocker x – Stop – step up/down command	Rocker x = coupled Function x = enabled Type = shutter or venetian blind Blind mode = enabled	1 bit	CR-T-	[1.007] step	16, 50, 84, 118
<i>See notes for independent input.</i>					
Rocker x – Move up / down command	Rocker x = coupled Function x = enabled Type = shutter or venetian blind	1 bit	CRWTU	[1.008] up/down	17, 51, 85, 119
<i>See notes for independent input.</i>					

7.5 Rocker x: Function A/B configuration

7.5.1 Independent or single

For the *independent* or single channel setting, all parameters listed below are referred to either Function A or Function B (whichever are enabled).

In the following sections, it is implicitly understood that for the listed parameters to appear, the corresponding functions xA and/or xB must be enabled.

The entries assigned to "Object n" are repeated so many times as the number of configured objects according to the *Number of Communication Objects* parameter.

For all Type values:

Parameter name	Conditions	Values
Lock function	-	enabled / disabled
	<i>Enables or disables the capability of locking the input through a remote command (telegram).</i>	
Lock function – Invert lock device signal	Rocker x = independent or single Type = send values or sequences	not inverted / inverted
	<i>Allows interpreting a "lock activate" telegram as unlock and vice-versa.</i>	
Lock function – Lock after bus recovery	Rocker x = independent or single Type = send values or sequences	no / yes
	<i>If active, after returning from a bus failure or power-off the device will retain the lock status it had before. Otherwise (in the default case), the device will restart in the non-locked condition.</i>	

7.5.2 Independent or single: Lock function enabled

Object name	Conditions	Dimens.	Flags	DPT	No. Comm. Obj.
Rocker xx – Lock function	Rocker x = Independent or single Lock function = enabled	1 bit	C-W--	[1.003] enable	4, 21 (1A, 1B) 38, 55 (2A, 2B) 72, 89 (3A, 3B) 106, 123 (4A, 4B)

When the lock function is enabled, for each input or rocker the user can define an action to execute when a lock or unlock command is received.

Details are shown in the following sections; a resume of all options is shown in the table below.

Channel mode	Input type	Behaviour at locking	Behaviour at unlocking
independent	send values or sequences	none as close or short press as open or long press	
coupled	switching	none off on toggle	none off on as previous
independent			
coupled	dimming		
independent			
independent	scene	none send first scene send second scene	
independent	shutter or venetian blind	none up down	
coupled			

7.5.3 Independent or single: send values or sequences

Parameter name	Conditions	Values
Number of communication objects	Rocker x = independent or single Type = send values or sequences	1...8 (1)
<i>Number of communication objects configured in association with the button event.</i>		
Lock function – Behaviour at locking	Rocker x = independent or single Type = send values or sequences	none as close or short press as open or long press
<i>Allows performing the operation associated to the specified event when a locking command is received. You can choose between operations linked to two possible closing (or short press, depending on the configuration) or opening (or long press) events.</i>		
Lock function – Behaviour at unlocking	Rocker x = independent or single Type = send values or sequences	none as close or short press as open or long press
<i>Allows performing the operation associated to the specified event when an unlocking command is received. You can choose between operations linked to two possible closing (or short press, depending on the configuration) or opening (or long press) events.</i>		
Event	Rocker x = independent or single Type = send values or sequences	close / open contact short / long press
<i>Type of event that should be used as trigger for an action.</i>		
Long press time	Rocker x = independent or single Type = send values or sequences Event = short / long press	hh:mm:ss.fff (00:00:03.000)
<i>Minimum push time for a press in order to be recognized as a long press.</i>		
Object n – Send delay	Rocker x = independent or single Type = send values or sequences	hh:mm:ss.fff (00:00:00.00)
<i>Delay before the object is transmitted on the bus. By defining a delay after the event occurs and before the object value is sent, it is possible to associate a time defined sequence of values to an input event.</i>		
Object n – Send cyclically	Rocker x = independent or single Type = send values or sequences Number of communication objects = 1	none off / value 1 on / value 2 both off and on / both values
<i>Defines which of the values, if any, must be cyclically retransmitted whenever activated. The cyclical transmission is only available if the number of communication objects to link is 1.</i>		
Object n – Cyclic sending interval	Rocker x = independent or single Type = send values or sequences Number of communication objects = 1 Send cyclically ≠ none	hh:mm:ss (00:02:00)
<i>Interval between cyclical transmissions.</i>		
Object n – send dimension	Rocker x = independent or single Type = send values or sequences	1 bit value 2 bits value 1 byte unsigned value 1 byte percentage 1 byte signed value 2 bytes unsigned value 2 bytes signed value 2 bytes floating value
<i>Defines size and type of the values to be sent when an event occurs.</i>		
Object n – Close or Short press	Rocker x = independent or single Type = send values or sequences send dimension = 1 bit	none on off toggle

Parameter name	Conditions	Values
	Rocker x = independent or single Type = send values or sequences send dimension = 2 bit	none disable enable off / up enable on / down enable off / up ↔ disable enable on / down ↔ disable enable off / up ↔ enable on / down
	Rocker x = independent or single Type = send values or sequences send dimension = any byte value	none send value 1 send value 2 send value 1 ↔ send value 2
<i>Value change behaviour caused by either a Close or a Short Press event (according to event configuration)</i>		
Object n – Open or Long press	Rocker x = independent or single Type = send values or sequences send dimension = 1 bit	none on off toggle
	Rocker x = independent or single Type = send values or sequences send dimension = 2 bit	none disable enable off / up enable on / down enable off / up ↔ disable enable on / down ↔ disable enable off / up ↔ enable on / down
	Rocker x = independent or single Type = send values or sequences send dimension = any byte value	none send value 1 send value 2 send value 1 ↔ send value 2
<i>Value change behaviour caused by either an Open or a Long Press event (according to event configuration)</i>		
Object n – Value 1	Rocker x = independent or single Type = send values or sequences send dimension = any byte value	0...255 (1 byte unsigned value) 0...100 (1 byte percentage) -128...127 (1 byte signed value) 0...65535 (2 bytes unsigned value) -32768... 32767 (2 bytes signed value) -671088.64...670760.96 (2 bytes floating value)
<i>First value available for association in send events</i>		
Object n – Value 2	Rocker x = independent or single Type = send values or sequences send dimension = any byte value	same as value 1
<i>Second value available for association in send events</i>		

Object name	Conditions	Dimens.	Flags	DPT	No. Comm. Obj.
Rocker xx – Switching status [type] Object n	Rocker x = Independent or single Type = send values or sequences	See table below	CR-TU	See table below	5, 22 (1A, 1B) 39, 56 (2A, 2B) 73, 90 (3A, 3B) 107, 124 (4A, 4B)
<p><i>The listed CO numbers are those referring to object nr. 1; the COs for each subsequent object are following in sequence.</i></p> <p><i>To obtain the CO numbers for object number n, just add (n-1) to the listed numbers.</i></p> <p><i>E.g.: COs associated to input 3A (of Rocker 3) have numbers from 81 to 89. The number of CO no. 5 is therefore 81+(5-1) = 85.</i></p>					

Sizes and DPTs are as follows:

<i>Dimens.</i>	<i>DPT</i>
1 bit	[1.001] switch
2 bit	[2.*] 1-bit controlled
1 byte unsigned value	[4.*] character [5.*] 8-bit unsigned value [20.*] 1-byte
1 byte percentage	[4.*] character [5.*] 8-bit unsigned value [20.*] 1-byte
1 byte signed value	[6.*] 8-bit signed value
2 bytes unsigned value	[7.*] 2-byte unsigned value
2 bytes signed value	[8.*] 2-byte signed value
2 bytes floating value	[9.*] 2-byte float value

7.5.4 Independent or single: dimming

Parameter name	Conditions	Values
Long press time	Rocker x = independent or single Type = dimming	hh:mm:ss.fff (00:00:03.000)
<i>Minimum push time for a press in order to be recognized as a long press.</i>		
Toggle mode	Rocker x = independent or single Type = dimming	enabled / disabled
<i>When enabled, causes the short press to toggle the on-off status of the destination CO; otherwise, a fixed status can be assigned to the short press.</i>		
Long action	Rocker x = independent or single Type = dimming Toggle mode = enabled	darker brighter darker ↔ brighter
<i>Defines the function to be assigned to the long press. If the toggle mode is enabled, the Short press action is already defined as toggle.</i>		
Short / Long action	Rocker x = independent or single Type = dimming Toggle mode = disabled	off / darker on / brighter off / darker ↔ brighter on / darker ↔ brighter
<i>Defines the function to be assigned to the long and short press.</i>		
Send cyclically	Rocker x = independent or single Type = dimming	none off / value 1 on / value 2 both off and on / both values
<i>Defines which of the values, if any, must be cyclically retransmitted whenever activated.</i>		
Cyclic sending interval	Rocker x = independent or single Type = dimming Send cyclically ≠ none	hh:mm:ss (00:02:00)
<i>Interval between cyclical transmissions.</i>		
Lock function – Behaviour at locking	Rocker x = independent or single Type = dimming	none off on toggle
<i>Value to be assigned to the object when a locking command is received.</i>		
Lock function – Behaviour at unlocking	Rocker x = independent or single Type = dimming	none off on as previous
<i>Value to be assigned to the object when an unlocking command is received.</i>		

7.5.5 Independent or single: shutter or venetian blind

Parameter name	Conditions	Values
Long press time	Rocker x = independent or single Type = shutter or venetian blind	hh:mm:ss.fff (00:00:03.000)
<i>Minimum push time for a press in order to be recognized as a long press.</i>		
Toggle mode	Rocker x = independent or single Type = shutter or venetian blind	enabled / disabled
<i>When enabled, causes the short press to toggle the on-off status of the destination CO; otherwise, a fixed status can be assigned to the short press.</i>		
Up / Down action	Rocker x = independent or single Type = shutter or venetian blind Toggle mode = disabled	up down
<i>Defines the movement direction to be assigned to the button press.</i>		
Blind mode	Rocker x = independent or single Type = shutter or venetian blind	enabled / disabled
<i>If blinds mode is enabled, the device sends "full movement" telegrams on long press and "step" telegrams on short press; if it is disabled, the device sends "full movement" telegrams on long press and "stop" telegrams on short press.</i>		
Lock function – Behaviour at locking	Rocker x = independent or single Type = shutter or venetian blind	none up down
<i>Operation to perform when a locking command is received.</i>		
Lock function – Behaviour at unlocking	Rocker x = independent or single Type = shutter or venetian blind	none up down
<i>Operation to perform when an unlocking command is received.</i>		

7.5.6 Independent or single: scene

Parameter name	Conditions	Values
First scene number	Rocker x = independent or single Type = scene	1...64 (1)
<i>Main scene number to be assigned to button press. It is named "first" for the case that an alternative scene number is used.</i>		
Learning mode	Rocker x = independent or single Type = scene	enabled / disabled
<i>When enabled, a long key press can be used to program the selected scene by storing the current parameters.</i>		
Long press time	Rocker x = independent or single Type = scene Learning mode = enabled	hh:mm:ss.fff (00:00:03.000)
<i>Minimum push time for a press in order to be recognized as a long press.</i>		
Scene activation	Rocker x = independent or single Type = scene Learning mode = disabled	send first scene only toggle between two scenes
<i>Allows the key to be used to alternate between two different scenes.</i>		
Second scene number	Rocker x = independent or single Type = scene Learning mode = disabled Scene activation = toggle between two scenes	1...64 (2)
<i>Alternate scene number to be assigned to button press.</i>		
Lock function – Behaviour at locking	Rocker x = independent or single Type = scene	none send first scene send second scene
<i>Operation to perform when a locking command is received.</i>		
Lock function – Behaviour at unlocking	Rocker x = independent or single Type = scene	none send first scene send second scene
<i>Operation to perform when an unlocking command is received.</i>		

7.5.7 Coupled

For a *coupled* channel, all the parameters are referred to the single menu entry for Function xA and xB.

In the following sections, it is implicitly understood that for the listed parameters to appear, the corresponding functions xA and xB must be enabled.

For all Type values:

Parameter name	Conditions	Values
Lock function	Rocker x = coupled	enabled / disabled
<i>Enables or disables the capability of locking the input through a remote command (telegram).</i>		

7.5.8 Coupled: Lock function enabled

Object name	Conditions	Dimens.	Flags	DPT	No. Comm. Obj.
Rocker xx – Lock function	Rocker x = coupled Lock function = enabled	1 bit	C-W--	[1.003] enable	4, 38, 72, 106

7.5.9 Coupled: switch

Parameter name	Conditions	Values
xA and xB use	Rocker x = coupled Type = switch	A on, B off A off, B on
<i>Allows to invert side A and side B functionalities</i>		
Send cyclically	Rocker x = coupled Type = switch	none off / value 1 on / value 2 both off and on / both values
<i>Defines which of the values, if any, must be cyclically retransmitted whenever activated.</i>		
Cyclic sending interval	Rocker x = coupled Type = switch Send cyclically ≠ none	hh:mm:ss (00:02:00)
<i>Interval between cyclical transmissions.</i>		
Lock function – Behaviour at locking	Rocker x = coupled Type = switch	none on off toggle
<i>Value to be assigned to the object when a locking command is received.</i>		
Lock function – Behaviour at unlocking	Rocker x = coupled Type = switch	none on off as previous
<i>Value to be assigned to the object when an unlocking command is received.</i>		

7.5.10 Coupled: dimming

Parameter name	Conditions	Values
Long press time	Rocker x = coupled Type = dimming	hh:mm:ss.fff (00:00:03.000)
<i>Minimum push time for a press in order to be recognized as a long press.</i>		
xA and xB use	Rocker x = coupled Type = dimming	A increases, B decreases A decreases, B increases
Send cyclically	Rocker x = coupled Type = dimming	none off / value 1 on / value 2 both off and on / both values
<i>Defines which of the values, if any, must be cyclically retransmitted whenever activated.</i>		
Cyclic sending interval	Rocker x = coupled Type = dimming Send cyclically ≠ no	hh:mm:ss (00:02:00)
<i>Interval between cyclical transmissions.</i>		
Lock function – Behaviour at locking	Rocker x = coupled Type = dimming	none on off toggle
<i>Value to be assigned to the object when a locking command is received.</i>		
Lock function – Behaviour at unlocking	Rocker x = coupled Type = dimming	none on off as previous
<i>Value to be assigned to the object when an unlocking command is received.</i>		

7.5.11 Coupled: shutter or venetian blind

Parameter name	Conditions	Values
Long press time	Rocker x = coupled Type = shutter or venetian blind	hh:mm:ss.fff (00:00:03.000)
	<i>Minimum push time for a press in order to be recognized as a long press.</i>	
xA and xB use	Rocker x = coupled Type = shutter or venetian blind	A up, B down A down, B up
Blind mode	Rocker x = coupled Type = shutter or venetian blind	enabled / disabled
	<i>If blinds mode is enabled, the device sends "full movement" telegrams on long press and "step" telegrams on short press; if it is disabled, the device sends "full movement" telegrams on long press and "stop" telegrams on short press.</i>	
Lock function – Behaviour at locking	Rocker x = coupled Type = shutter or venetian blind	none up down
	<i>Operation to perform when a locking command is received.</i>	
Lock function – Behaviour at unlocking	Rocker x = coupled Type = shutter or venetian blind	none up down
	<i>Operation to perform when an unlocking command is received.</i>	

For other communication objects related to *coupled* mode, please refer to the general *Rockers Configuration* section.

7.6 LED configuration

Following parameters are repeated for each of the available LEDs.

LED parameters settings are always listed grouped by rocker (regardless whether the inputs are coupled or not): for each rocker *x*, available LEDs are marked as LED First Colour (green in BG version, red in RW) and LED Second Colour (blue in BG version, white in RW).



Figure 11 – Number convention for LED couples

Parameter name	Conditions	Values
LED X First colour/Second colour	-	fixed when contact closed status from bus
Always	LED X First colour/Second colour = fixed	on / off
	<i>Status for a fixed LED condition</i>	
Off delay	LED X First colour/Second colour = when contact closed	hh:mm:ss.ff (00:02:00.00)
	<i>Delay before LED goes off</i>	
Blinking	LED X First colour/Second colour = status from bus	no / yes
Signal from bus	LED X First colour/Second colour = status from bus	not inverted / inverted
	<i>Specifies whether the LED status from the bus should be inverted, i.e. LED on when an "off" command is received on the communication object. This feature is useful because the condition for the LED to switch on can be linked to a communication object related to the state of another device, which may have an opposite logic.</i>	

Object name	Conditions	Dimens.	Flags	DPT	No. Comm. Obj.
LED X – First colour	LED first colour 1 = status from bus	1 bit	CRWTU-	[1.001] switch	140, 142, 144, 146, 148, 150, 152, 154
LED X - Second colour	LED second colour 1 = status from bus	1 bit	CRWTU-	[1.001] switch	141, 143, 145, 147, 149, 151, 153, 155

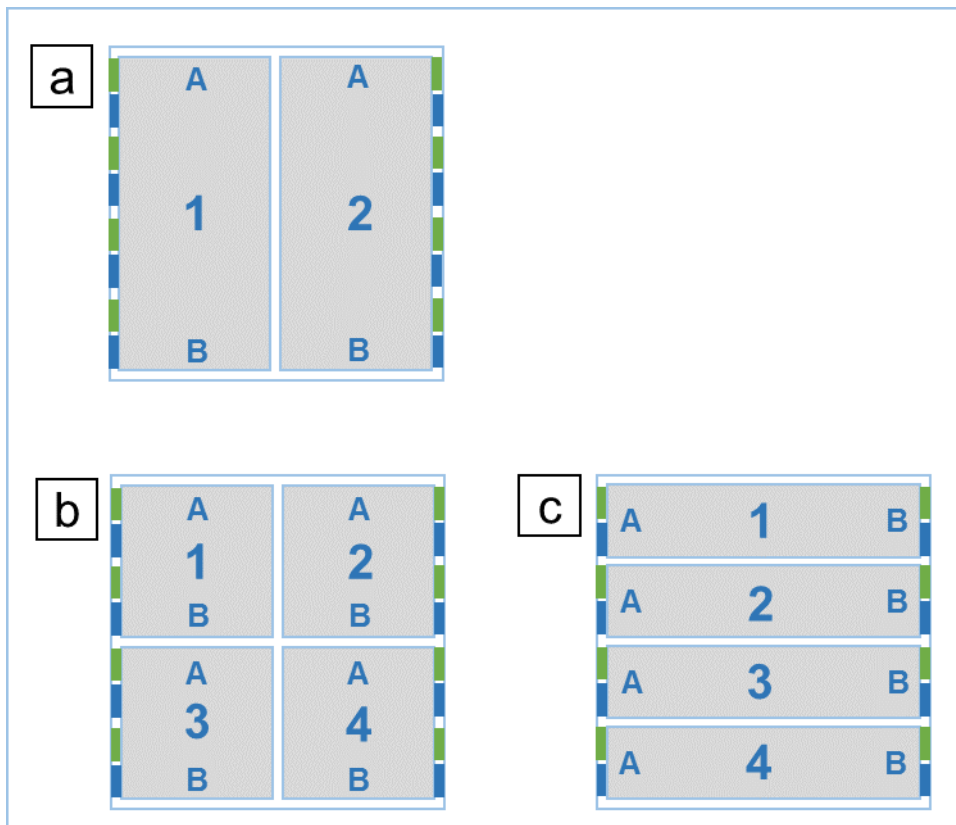

		Rocker combinations			
		a)	b)	c)	d)
	LED				
Independent A/B functions	1	1A	1A	1A	1A
Parallel A/B functions		1A	1A	1A	not allowed
Independent A/B functions	2	1A	1A	1B	2A
Parallel A/B functions		1A	1A	1A	not allowed
Independent A/B functions	3	1B	1B	3A	3A
Parallel A/B functions		1A	1A	3A	not allowed
Independent A/B functions	4	1B	1B	3B	4A
Parallel A/B functions		1A	1A	3A	not allowed
Independent A/B functions	5	1A	2A	2A	1B
Parallel A/B functions		1A	2A	2A	not allowed
Independent A/B functions	6	1A	2A	2B	2B
Parallel A/B functions		1A	2A	2A	not allowed
Independent A/B functions	7	1B	2B	4A	3B
Parallel A/B functions		1A	2A	4A	not allowed
Independent A/B functions	8	1B	2B	4B	4B
Parallel A/B functions		1A	2A	4A	not allowed

This table shows the LEDs (according to the adopted convention) activated with a press on the areas, according to the adopted rocker combination.

7.7 Temperature control

The *Temperature control* folder allows the pushbutton to be configured as a room temperature controller and also allows filtrating, through a weighted mean average, the reading from the internal sensor with the reading from an auxiliary sensor added on the bus.

The folder is active only if the room temperature sensor has been enabled: *Internal sensors* ⇒ Temperature sensor = enabled.

It includes the following secondary folders: Settings

- Settings
- Sensors from bus
- Weighted temperature value
- Heating
- Cooling

7.7.1 Settings

The *Settings* includes the parameters to perform the basic configuration of the room temperature controller:

- Heating and cooling function
- Setpoint management mode: single or relative
- Separated actuator command or common in heating/cooling
- Heating/cooling switch over type
- Valve protection function activation

This folder is always active.

Parameter name	Conditions	Values
Thermostat function		disabled heating cooling both heating and cooling
Setpoint management		Single setpoint Relative setpoints
	<i>In case the option "Single setpoint" is selected and Thermostat function = heating, the temperature controller acts on heating mode; in case Thermostat function = cooling, the temperature controller acts on cooling mode. In case Thermostat function = both heating and cooling, the current seasonal mode needs to be specified by the proper communication object.</i>	
Command Communication Object	Thermostat function = both heating and cooling	separated / unique
Heating-cooling switch over	Thermostat function = both heating and cooling, Setpoint management = Relative setpoints	from bus / automatic
	<i>In case Setpoint management = single setpoint, the heating-cooling switch over must be carried out from bus.</i>	

Parameter name	Conditions	Values
Cyclic sending interval setpoint		no sending [other values in range 30 s ... 120 min]
<i>In case Setpoint management = single setpoint, the actual setpoint value takes only into account the actual state of the contacts window (if the corresponding function is enabled).</i> <i>In case Setpoint management = relative setpoints, the actual setpoint value also depends on the operating mode set manually by the user or automatically by another KNX supervising device with the possibility of time scheduling.</i>		
Valve protection function		disabled / enabled
<i>It enables the function that activates the drive for the valve control during periods of inactivity of the system.</i>		
Frequency	Valve protection function = enabled	once a day, once a week , once a month
Time interval	Valve protection function = enabled	10 s [other values in range 5 s ... 20 min]

All communication object are active only if parameter *Settings* ⇒ Thermostat function ≠ disabled

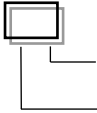
Object name	Conditions	Dim.	Flags	DPT	No. Comm. Obj.
Thermal generator lock		1 Bit	-WC---	[1.001] switch	160
Temperature control alarm		1 Bit	CR-T-	[1.005] alarm	161
Actual setpoint		2 Byte	CR-T--	[9.001] temperature (°C)	171
Heating / cooling status out	Thermostat function = both heating and cooling, Heating-cooling switch over = automatic	1 Bit	CR-T--	[1.100] heating/cooling	168
<i>The communication object is sent over the bus after an internally elaborated switching event.</i> [1.100] DPT Heat/Cool 1 Bit 					
Heating / cooling status in	Thermostat function = both heating and cooling, Heating-cooling switch over = from bus	1 Bit	C-W---	[1.100] heating/cooling	169
<i>The communication object is received from the bus. At the switching event the internal regulator switches the conduction mode.</i>					

Object name	Conditions	Dim.	Flags	DPT	No. Comm. Obj.
HVAC mode in	Setpoint management = Relative setpoints	1 Byte	C-W---	[20.102] HVAC mode	170
<p><i>Bits 5, 8 are reserved.</i></p> <p>[20.102] DPT HVAC Mode 1 Byte</p> <p>AUTO COMFORT STAND-BY</p> <p>0 0 0 0 0 0 0 1 0 0 1 0</p> <p>ECONOMY PROTECTION</p> <p>0 0 1 1 0 1 0 0</p>					

7.7.2 Sensors from bus

Sensors from bus are KNX devices (or traditional sensors interfaced to the bus by means of KNX devices) which send values or states to the pushbutton via bus. The folder allows activating an auxiliary temperature sensor and 2 window contacts to automatically recall the building protection setpoint: the automatic recall function must be individually configured for the 2 conduction modes in *Heating and/or Cooling* folder.



The internal pushbutton control system cyclically monitors the updating status of the values of the external sensors (from bus) when the timeout setting expires. In case no updated value has been received, the regulation function is suspended and the actuation valves are closed. An alarm is issued on the bus through communication object *Temperature control alarm* (please refer to *Settings* folder).

The folder is always active.

Parameter name	Conditions	Values
Room temperature (from bus)		disabled / enabled
	<i>Enables a temperature bus sensor. The measured value can be used to calculate a weighted mean average with the integrated temperature sensor.</i>	
Analog sensor timeout (from bus)		00:05:00 hh:mm:ss [range 00:00:00 ... 18:12:15]
	<i>The field has format hh:mm:ss (hours : minutes : seconds): the default value 00:05:00 corresponds to a timeout of 5 minutes. The value 00:00:00 means that the timeout of the analogic sensors is disabled.</i>	
Window contact 1		disabled / enabled
	<i>It enables a bus sensor for detecting the state of opening / closing of a window or a door.</i>	
Signal	Window contact 1 = enabled	not inverted / inverted
Window contact 2		disabled / enabled
	<i>It enables a bus sensor for detecting the state of opening / closing of a window or a door.</i>	
Signal	Window contact 2 = enabled	not inverted / inverted

Object name	Conditions	Dim.	Flags	DPT	No. Comm. Obj.
Room temperature (from bus)	enabled	2 Byte	C-W---	[9.001] temperature (°C)	164
Windows contact sensor 1 (from bus)	enabled	1 Bit	C-W---	[1.019] window/door	165
Windows contact sensor 2 (from bus)	enabled	1 Bit	C-W---	[1.019] window/door	166

7.7.3 Weighted temperature value

The *Weighted temperature value* folder allows calculating a weighted mean average between the integrated temperature sensor value and the temperature sensor from bus value. The calculated temperature is then used as main temperature value in the integrated room temperature controller's algorithm.

The folder is active if: *Sensors from bus* ⇒ Room temperature (from bus) = enabled.

Parameter name	Conditions	Values
Relative weight		100% main sensor 90% / 10% 80% / 20% 70% / 30% 60% / 40% 50% / 50% 40% / 60% 30% / 70% 20% / 80% 10% / 90% 100% sensor from bus
<i>The main sensor is always the integrated sensor; the sensor from bus needs to be activated in Sensors from bus folder.</i>		
Minimum change of value to send [K]		0,5 [other values in range 0 ... 5 K]
<i>If the parameter is set to 0, no value is sent for change</i>		
Cyclic sending interval		no sending [other values in range 30 s ... 120 min]

Object name	Conditions	Dim.	Flags	DPT	No. Comm. Obj.
Weighted temperature	Cyclic sending interval ≠ no sending	2 Byte	CR-T--	[9.001] temperature °C	167

7.7.4 Heating

The *Heating* folder allows setting:

- The default value for single and relative setpoints (comfort, standby and economy setpoints);
- Control algorithm type (2-point hysteresis, PWM or continuous) and internal parameters;
- Building protection mode activation based on up to 2 window contacts' status.

Conditions of activation: *Settings* ⇒ Thermostat function = heating or both heating and cooling.

Parameter name	Conditions	Values
Temperature setpoint [°C]	Setpoint management = Single setpoint	21 [range 10 ... 50]
Comfort temp. setpoint [°C]	Setpoint management = Relative setpoints	21 [range 10 ... 50]
Standby temp. offset [0,1 K]	Setpoint management = Relative setpoints	- 30 [range -10 ... -50]
Economy temp. offset [0,1 K]	Setpoint management = Relative setpoints	-50 [range -10 ... -50]
Building protection temp. setpoint [°C]		7 [range 2 ... 10]
Control type		2 point hysteresis, PWM (pulse width modulation) continuous
Hysteresis	Control type = 2 point hysteresis	0,3 K [other values in range 0,2 K ... 3 K]
Hysteresis position	Control type = 2 point hysteresis	below above
	<i>The above hysteresis is suitable in case of special applications requiring mixing group control.</i>	
Cyclic sending interval	Control type = 2 point hysteresis, continuous	no sending [other values in range 30 s ... 120 min]
Min. change of value to send [%]	Control type = continuous	10 [range 0 ... 100]
PWM cycle time	Control type = PWM (pulse width modulation)	15 min [range 5 ... 240 min]

Parameter name	Conditions	Values
Min control value [%]	Control type = PWM and continuous	15 % [range 0 %...30 %]
Max control value [%]	Control type = PWM and continuous	85 % [range 70 %...100 %]
Heating type	Control type = continuous or PWM	radiators (5 K / 150 min) electric (4 K / 100 min) floor radiant panels (5 K / 240 min) ceiling radiant panels (5 K / 180 min) other
Proportional band [0,1 K]	Control type = continuous or PWM, Heating type = other	40 [range 5 ... 100]
Integral time [min]	Control type = continuous or PWM, Heating type = other	90 [range 0 ... 255 min]
Use window contacts to activate building protection mode	Sensors from bus ⇒ Window contact 1 = enabled, or Sensors from bus ⇒ Window contact 2 = enabled	disabled / enabled
	<i>Parameter enabling window contact function.</i>	
Waiting time before activating building protection mode	Use window contacts to activate building protection mode = enabled	00:01:00 hh:mm:ss [range 00:00:00 ... 18:12:15]
	<i>Time interval before the device automatically switches to building protection mode.</i>	

All communication objects are active if *Settings* ⇒ Thermostat function = heating or both heating and cooling.

Object name	Conditions	Dim.	Flags	DPT	No. Comm. Obj.
Input setpoint	Setpoint management = Single setpoint	2 Byte	CRWTU-	[9.001] temperature (°C)	172
Heating comfort setpoint	Setpoint management = Relative setpoints	2 Byte	CRWTU-	[9.001] temperature (°C)	172
Heating standby offset	Setpoint management = Relative setpoints, Heating/cooling switch over = manual	2 Byte	CRWTU-	[9.002] temperature difference (K)	174
Heating economy offset	Setpoint management = Relative setpoints, Heating/cooling switch over = manual	2 Byte	CRWTU-	[9.002] temperature difference (K)	176
Heating building protection setpoint		2 Byte	CRWTU-	[9.001] temperature (°C)	178
Heating out command	Control type = 2 point hysteresis or PWM	1 Bit	CR-T--	[1.001] switch	180

<i>Object name</i>	<i>Conditions</i>	<i>Dim.</i>	<i>Flags</i>	<i>DPT</i>	<i>No. Comm. Obj.</i>
Heating out command	Control type = continuous	1 Byte	CR-T--	[5.001] percentage (0..100%)	180

7.7.5 Cooling

The *Cooling* folder allows setting:

- The default value for single and relative setpoints (comfort, standby and economy setpoints) in case of manual heating/cooling switch over;
- The default value for the switch over dead band and for standby and economy attenuation in case of automatic heating/cooling switch over;
- Control algorithm type (2-point hysteresis, PWM or continuous) and internal parameters;
- Building protection mode activation based on up to 2 window contacts' status.

Conditions of activation: *Settings* ⇒ Thermostat function = heating or both heating and cooling.

Parameter name	Conditions	Values
Temperature setpoint [°C]	Setpoint management = Single setpoint	23 [range 10 ... 50]
Switch over dead band	Setpoint management = Relative setpoints, Heating/cooling switch over = automatic	20 [range 10 ... 40]
Comfort temp. setpoint [°C]	Setpoint management = Relative setpoints, Heating/cooling switch over = from bus	23 [range 10 ... 50]
Standby temp. offset [0,1 K]	Setpoint management = Relative setpoints	30 [range 10 ... 50]
Economy temp. offset [0,1 K]	Setpoint management = Relative setpoints	50 [range 10 ... 80]
Building protection temp. setpoint [°C]		36 [range 30 ... 50]
Control type	Command for both heating and cooling = separated	2 point hysteresis, PWM (pulse width modulation), continuous
	<i>If in Settings the parameter Thermostat function = both heating and cooling and Command communication object = unique, the parameter Cooling type is bound to the choice done for Heating.</i>	
Hysteresis	Control type = 2 point hysteresis	0,3 K [other values in range 0,2 K ... 3 K]
Hysteresis position	Control type = 2 point hysteresis	above below
	<i>The below hysteresis is suitable in case of special applications requiring mixing group control.</i>	
Cyclic sending interval	Control type = 2 point hysteresis, continuous	no sending [other values in range 30 s ... 120 min]
Min. change of value to send [%]	Control type = continuous	10 [range 0 ... 100]
PWM cycle time	Control type = PWM (pulse width modulation)	15 min [range 5 ... 240 min]

Parameter name	Conditions	Values
Min control value [%]	Control type = PWM	15 [range 0...30]
Max control value [%]	Control type = PWM	85 [range 70...100]
Cooling type	Control type = continuous or PWM	floor radiant panels (5 K / 240 min) ceiling radiant panels (5 K / 180 min) other
Proportional band [0,1 K]	Control type = continuous or PWM, Cooling type = other	40 [range 5 ... 100]
Integral time [min]	Control type = continuous or PWM, Cooling type = other	90 [range 0 ... 255 min]
Use window contacts to activate building protection mode	Sensors from bus ⇒ Window contact 1 = enabled, or Sensors from bus ⇒ Window contact 2 = enabled	disabled / enabled
	<i>Parameter enabling window contact function.</i>	
Waiting time before activating building protection mode	Use window contacts to activate building protection mode = enabled	00:01:00 hh:mm:ss [range 00:00:00 ... 18:12:15]
	<i>Time interval before the device automatically switches to building protection mode.</i>	

All communication objects are active if *Settings* ⇒ Thermostat function = heating or both heating and cooling.

Object name	Conditions	Dim.	Flags	DPT	No. Comm. Obj.
Input setpoint	Setpoint management = Single setpoint	2 Byte	CRWTU-	[9.001] temperature (°C)	172
Cooling comfort setpoint	Setpoint management = Relative setpoints, Heating/cooling switch over = from bus	2 Byte	CRWTU-	[9.001] temperature (°C)	173
Cooling standby offset	Setpoint management = Relative setpoints, Heating/cooling switch over = from bus	2 Byte	CRWTU-	[9.002] temperature difference (K)	175
Cooling economy offset	Setpoint management = Relative setpoints, Heating/cooling switch over = from bus	2 Byte	CRWTU-	[9.002] temperature difference (K)	177
Cooling building protection setpoint		2 Byte	CRWTU-	[9.001] temperature (°C)	179
Cooling out command	Control type = 2 point hysteresis or PWM	1 Bit	CR-T--	[1.001] switch	181
Cooling out command	Control type = continuous	1 Byte	CR-T--	[5.001] percentage (0..100%)	181

7.8 Logic functions

Conditions of activation: *General* ⇒ Logic functions = enabled.

Parameter name	Conditions	Values
Logic function X		enabled / disabled
Logic operation	Logic function X = enabled <i>XOR (eXclusive OR)</i>	OR / AND / XOR
Delay after bus voltage recovery	Logic function X = enabled	hh:mm:ss.fff (00:00:04.000)
	<i>Time interval between the bus voltage recovery and the first reading of the input communication objects for evaluating the logic functions</i>	
Cyclic sending interval	Logic function X = enabled	no sending [other values in range 30 s ... 120 min]
	<i>No sending means that the output state of the logic function is updated on the bus only on change. Different values imply cyclic sending on the bus of the output state.</i>	
Logic object 1	Logic function X = enabled	enabled / disabled
Logic object 1 negated	Logic function X = enabled, Logic object 1 = enabled	no / yes
	<i>By negating the logic state of the corresponding object, it is possible to create complex combinatory logics. For example: Output=(NOT(Logic object 1) OR Logic object 2).</i>	
Logic object 2	Logic function X = enabled	enabled / disabled
Logic object 2 negated	Logic function X = enabled, Logic object 2 = enabled	no / yes
Logic object 3	Logic function X = enabled	enabled / disabled
Logic object 3 negated	Logic function X = enabled, Logic object 3 = enabled	no / yes
Logic object 4	Logic function X = enabled	enabled / disabled
Logic object 4 negated	Logic function X = enabled, Logic object 4 = enabled	no / yes

<i>Object name</i>	<i>Conditions</i>	<i>Dim.</i>	<i>Flags</i>	<i>DPT</i>	<i>No. Comm. Obj.</i>
Logic function X – Input 1	Logic function X = enabled, Logic object 1 = enabled	1 Bit	--WTU-	[1.001] switch	182, 187, 192, 197, 202, 207, 212, 217
Logic function X – Input 2	Logic function X = enabled, Logic object 2 = enabled	1 Bit	--WTU-	[1.001] switch	183, 188, 193, 198, 203, 208, 213, 218
Logic function X – Input 3	Logic function X = enabled, Logic object 3 = enabled	1 Bit	--WTU-	[1.001] switch	184, 189, 194, 199, 204, 209, 214, 219
Logic function X – Input 4	Logic function X = enabled, Logic object 4 = enabled	1 Bit	--WTU-	[1.001] switch	185, 190, 195, 200, 205, 210, 215, 220
Logic function X – Output	Logic function X = enabled	1 Bit	CR-T--	[1.001] switch	186, 191, 196, 201, 206, 211, 216, 221

8 Appendix

8.1 Summary of KNX communication objects

The following list contains the KNX communication objects for all corresponding *Data Point Types* (DPT) defined by the application program according to the performed configurations.

The list is ordered by object number; if the same object is linked to different inputs, the first input or rocker is referenced.

Object name	Dimens.	Flags	DPT	No. Comm. Obj.
Technical alarm	1 Bit	C-W--	[1.5] DPT_Alarm	0
Brightness value	2 Byte	CR-T-	[9.4] DPT_Value_Lux	1
Temperature value	2 Byte	CR-T-	[9.1] DPT_Value_Temp	3
Rocker xx – Lock function	1 Bit	C-W--	[1.3] DPT_Enable	4, 21, 38, 55, 72, 89, 106, 123
Rocker x – Switching status [type], object n*	See table A1	CR-TU	See table A1	5..12, 22.. 29, 39.. 46, 56.. 63, 73.. 80, 90.. 97, 107.. 114, 124.. 131
* The numbers of listed C.O.s are referred to the first of 8 objects (for each input); the next C.O.s are sequential. In order to obtain the C.O. number for the n-th object, simply add (n-1) to the referred numbers. E.g.: he C.O.s linked to input 3A have numbers starting from 81. The number of the 5th C.O. linked to that input will be 81+ (5-1) = 85.				
Rocker xx – Switching command	1 Bit	CRWTU	[1.1] DPT_Switch	13, 30, 47, 64, 81, 98, 115, 132
Rocker xx – Dedicated stop command	1 Bit	CRWTU	[1.17] DPT_Trigger	13, 30, 47, 64, 81, 98, 115, 132
Rocker xx – Dimming up / down / stop command	4 Bit	CR-T-	[3.*] DPT_Control_Dimming, DPT_Control_Blinds	14, 31, 48, 65, 82, 99, 116, 133
Rocker xx – Stop – step up/down command	1 Bit	CR-T-	[1.7] DPT_Step	16, 33, 50, 67, 84, 101, 118, 135
Rocker xx – Move up / down command	1 Bit	CRWTU	[1.8] DPT_UpDown	17, 34, 51, 68, 85, 102, 119, 136
Rocker xx – Scene number	1 Byte	CR-T-	[17.1] DPT_SceneNumber [18.1] DPT_SceneControl	18, 35, 52, 69, 86, 103, 120, 137
Light threshold 1 - Switch	1 Bit	CR-T-	[1.1] DPT_Switch	20
Light threshold 2 - Switch	1 Bit	CR-T-	[1.1] DPT_Switch	37
LED X – First colour	1 Bit	CRWTU	[1.1] DPT_Switch	140, 142, 144, 146, 148, 150, 152, 154
LED X – Second colour	1 Bit	CRWTU	[1.1] DPT_Switch	141, 143, 145, 147, 149, 151, 153, 155
Thermal generator lock	1 Bit	-WC---	[1.1] DPT_Switch	160
Temperature control alarm	1 Bit	CR-T-	[1.5] DPT_Alarm	161

Object name	Dimens.	Flags	DPT	No. Comm. Obj.
Temperature threshold 1 – Switch	1 Bit	CR-T-	[1.1] DPT_Switch	162
Temperature threshold 2 – Switch	1 Bit	CR-T-	[1.1] DPT_Switch	163
Room temperature (from bus)	2 Byte	CR-T-	[9.1] DPT_Value_Temp	164
Windows contact sensor 1 (from bus)	1 Bit	-WC---	[1.19] DPT_Window_Door	165
Windows contact sensor 2 (from bus)	1 Bit	-WC---	[1.19] DPT_Window_Door	166
Weighted temperature	2 Byte	CR-T-	[9.1] DPT_Value_Temp	167
Heating / cooling status out	1 Bit	R-CT--	[1.100] DPT_Heat_Cool	168
Heating / cooling status in	1 Bit	-WC---	[1.100] DPT_Heat_Cool	169
HVAC mode in	1 Byte	-WC---	[20.102] DPT_HVACMode	170
Actual setpoint	2 Byte	R-CT--	[9.1] DPT_Value_Temp	171
Input setpoint	2 Byte	-WC---	[9.1] DPT_Value_Temp	172
Heating comfort setpoint	2 Byte	RWCTU-	[9.1] DPT_Value_Temp	172
Cooling comfort setpoint	2 Byte	RWCTU-	[9.1] DPT_Value_Temp	173
Heating standby offset	2 Byte	RWCTU-	[9.2] DPT_Value_Tempd	174
Cooling standby offset	2 Byte	RWCTU-	[9.2] DPT_Value_Tempd	175
Heating economy offset	2 Byte	RWCTU-	[9.2] DPT_Value_Tempd	176
Cooling economy offset	2 Byte	RWCTU-	[9.2] DPT_Value_Tempd	177
Heating building protection setpoint	2 Byte	RWCTU-	[9.1] DPT_Value_Temp	178
Cooling building protection setpoint	2 Byte	RWCTU-	[9.1] DPT_Value_Temp	179
Heating out command	1 Byte	R-CT--	[5.1] DPT_Scaling	180
Heating out command	1 Bit	R-CT--	[1.1] DPT_Switch	180
Both heating and cooling out command	1 Bit	R-CT--	[1.1] DPT_Switch	180
Both heating and cooling out command	1 Byte	R-CT--	[5.1] DPT_Scaling	180
Cooling out command	1 Byte	R-CT--	[5.1] DPT_Scaling	181
Cooling out command	1 Bit	R-CT--	[1.1] DPT_Switch	181
Logic function X – Input 1	1 Bit	-WCTU-	[1.1] DPT_Switch	182, 187, 192, 197, 202, 207, 212, 217
Logic function X – Input 2	1 Bit	-WCTU-	[1.1] DPT_Switch	183, 188, 193, 198, 203, 208, 213, 218
Logic function X – Input 3	1 Bit	-WCTU-	[1.1] DPT_Switch	184, 189, 194, 199, 204, 209, 214, 219
Logic function X – Input 4	1 Bit	-WCTU-	[1.1] DPT_Switch	185, 190, 195, 200, 205, 210, 215, 220
Logic function X – Output	1 Bit	R-CT--	[1.1] DPT_Switch	186, 191, 196, 201, 206, 211, 216, 221

Table A1. Dimensions e DPT for C.O.s with independent inputs:

Dimens.	DPT
1 bit	[1.001] switch
2 bit	[2.*] 1-bit controlled
1 byte unsigned value	[4.*] character
	[5.*] 8-bit unsigned value [20.*] 1-byte
1 byte percentage	[4.*] character
	[5.*] 8-bit unsigned value

<i>Dimens.</i>	<i>DPT</i>
	[20.*] 1-byte
1 byte signed value	[6.*] 8-bit signed value
2 bytes unsigned value	[7.*] 2-byte unsigned value
2 bytes signed value	[8.*] 2-byte signed value
2 bytes floating value	[9.*] 2-byte float value

8.2 Warning

- Installation, electrical connection, configuration and commissioning of the device can only be carried out by qualified personnel.
- Opening the housing of the device causes the immediate end of the warranty period.
- ekinex® KNX defective devices must be returned to the manufacturer at the following address:

SBS S.p.A. Via Circonvallazione s / n, I-28010 Miasino (NO) Italy.

8.3 Other information

- This application manual is aimed at installers, system integrators and planners
- For further information on the product, please contact the ekinex® technical support at the e-mail address: support@ekinex.com or visit the website www.ekinex.com
- ekinex® is a registered trademark of SBS S.p.A.
- KNX® and ETS® are registered trademarks of KNX Association cvba, Brussels

© SBS S.p.A. 2017. The company reserves the right to make changes to this documentation without notice.