



WS1 Color

Control System for Buildings and for Conservatories

WS1 Color 60145, 60135-60138 (white), 60146, 60139-60142 (alu)



WS1000 Color

Control System for Buildings and for Conservatories

WS1000 Color 60121-60124 (white), 60125-60128 (alu)



1. Description	7
1.1. Field of application	8
1.1.1. Delivery scope	8
1.2. Connection and control options	9
1.2.1. Automatic functions in overview	11
2. Operation and use	15
2.1. Weather data display (starting image)	16
2.2. The touch display	18
2.3. Manually operate drives and devices	19
2.3.1. The „Manual“ menu	19
2.3.2. Internal buttons (group buttons)	21
2.3.3. Remote control	21
2.4. Navigation in the System menu	22
2.4.1. Input keyboard for names and codes	23
2.5. Slideshow	23
3. Automatic settings	25
3.1. Automatic settings	26
3.1.1. Safety notice for automatic and alarm functions	26
Power failure, maintenance works, etc. (restart of control)	27
3.1.2. Automatic settings for drive groups and devices	27
3.1.3. Drives and devices without automatic functions	27
3.1.4. Automatic awning settings	27
3.1.5. Automatic blind and roller shutter settings	33
3.1.6. Automatic window settings	40
3.1.7. Automatic ventilation settings	48
3.1.8. Automatic heating settings	53
3.1.9. Automatic air-conditioner settings	55
3.1.10. Automatic light settings	57
3.1.11. Automatic roof gutter heating settings	58
3.1.12. Set up alarm	59
3.1.13. Setting motion detectors	60
3.2. Adjust general automatic settings	60
3.2.1. Adjust twilight value	61
3.2.2. Adjust movement delays (shading elements)	61
3.2.3. Set timer	61
3.2.4. Adjust ventilation block	62
3.2.5. Set night-time re-cooling (ventilation)	63
3.2.6. Adjust frost alarm	64

3.2.7. Set movement limitations (window)	65
3.2.8. Setting a wind delay (shades)	65
3.2.9. Define automatic reset	66

4. Installation 67

4.1. Procedure	68
4.1.1. Installation notes	68
4.1.2. Notes on wireless equipment	69
4.1.3. Safety notice for automatic and alarm functions	69
Power failure, maintenance works, etc. (restart of control)	70
4.2. Installation of the P04i-GPS Weather Station	70
4.2.1. Installing the weather station	70
Installation location	70
Device design	72
Preparation for installation	72
Fitting the lower part with mounting	73
Connection	75
Closing the installation	76
4.2.2. Notes on mounting and commissioning	76
4.2.3. Maintenance of the weather station	77
4.3. Installation of a WGTH-UP Indoor Sensor	77
4.3.1. Installation of the indoor sensor	78
Installation location	78
Layout	78
Rear view	79
Installation	79
4.3.2. Notes on mounting and commissioning	79
4.3.3. Establish radio connection with WGTH-UP	79
4.4. Installation of the control unit	80
4.4.1. Installation of the control unit WS1000 Color	80
Preparing the installation location	80
Preparing for installation	81
Wall-fitting	82
Cavity wall fitting	83
Assembling the control unit with concealed box	83
Structure of the connector board WS1000 Color	84
Connection diagram	85
Installation of the control unit WS1 Color	87
Preparing the installation location	87
Preparing for installation	88
Wall-fitting	89
Cavity wall fitting	90
Assembling the control unit with concealed box	90
Structure of the connector board WS1 Color	91
Connection diagrams	92

4.4.2. Connect drives and devices	94
Connect drive groups	94
Connect devices to the multifunctional outputs	94
Connect devices to the multifunctional inputs	95
4.4.3. Connecting drives and devices wirelessly	95

5. Commissioning 97

5.1. Procedure	98
5.1.1. Start control unit	98
5.1.2. Check sensor functions	99

6. Basic Setting 101

6.1. The "Installation" menu	102
6.1.1. Set up drives and drive groups	102
Tips on connecting windows	106
6.1.2. Assign external buttons	106
6.1.3. Assign internal buttons (group buttons)	108
6.1.4. Set up multifunctional outputs	109
6.1.5. Set up multifunctional inputs	110
6.1.6. Wireless connections	112
Learn wireless connection	112
Status	113
Delete wireless connection	116
6.1.7. Indoor sensor for weather display	117
6.1.8. Settings for communication with KNX (WS1000 only)	117
6.1.9. Setting Camera Inputs	118
6.1.10. Configuring internal thermometer/hygrometer of WS1	119
6.1.11. Define channel order	120
6.2. WS1 / WS1000 Settings 120	120
6.2.1. Settings	121
Enter time and date manually	121
Change language	121
Adjust screen	122
Select time zone	122
Enter location (only DCF weather stations)	123
Calibrate touch	124
6.2.2. Service settings	124
Reset (new start)	124
Factory settings	125
Internal area	125
6.2.3. Access code	125
6.2.4. Using an SD card (only WS1000 Color)	126
Show images on display	127
Saving and loading configuration data	128

7. Tables, diagrams, maintenance	129
7.1. Care and maintenance	130
Maintenance of the weather station	130
Maintenance of the control unit	130
7.2. Technical specifications	130
7.2.1. Technical specifications Control Unit WS1 Color	130
7.2.2. Technical specifications Control Unit WS1000 Color	131
7.2.3. Technical specifications P04i-GPS	131
7.2.4. Technical specifications WGTH-UP	132
7.2.5. Units for sun and wind	133
7.3. Alarm and error messages	134
7.3.1. Weather data display messages	134
7.3.2. "Manual" menu messages	135
7.4. Connection diagrams	136
7.4.1. Diagrams WS1	136
7.4.2. Diagrams WS1000	138
7.4.3. Connection of several drives to one 230 V drive output	140
7.4.4. Use drive outputs for centralised control	141
Centralised control with IMMSG 230 Motor Control Units (230 V drive output)	141
Centralised control with IMMSG-UC Motor Control Units	142
7.5. Personal automatic settings data	143



Installation, inspection, commissioning and troubleshooting of the device must only be carried out by a competent electrician.

This manual is amended periodically and will be brought into line with new software releases. The change status (software version and date) can be found in the contents footer. If you have a device with a later software version, please check **www.elsner-elektronik.de** in the menu area "Service" to find out whether a more up-to-date version of the manual is available.

Clarification of signs used in this manual



Safety advice.



Safety advice for working on electrical connections, components, etc.

DANGER!

... indicates an immediately hazardous situation which will lead to death or severe injuries if it is not avoided.

WARNING!

... indicates a potentially hazardous situation which may lead to death or severe injuries if it is not avoided.

CAUTION!

... indicates a potentially hazardous situation which may lead to trivial or minor injuries if it is not avoided.



ATTENTION! ... indicates a situation which may lead to damage to property if it is not avoided.



"Control unit"

The symbol is followed by a menu path. In this menu the settings just described can be changed.



"Manual"

The symbol is followed by chapter information with a page number. In this chapter you will find additional information about the setting just described.

1. Description

1.1. Field of application

The control system was developed so that the different technical equipment installed in conservatories and buildings could be centrally controlled. The control units offer the highest measure of flexibility with regard to connections, allowing settings to be optimally and individually adjusted to the circumstances on site. Please use this operational guide to adjust the automatic functions to your requirements and enable comfortable manual operation.

1.1.1. Delivery scope

- Central control and operations unit
 - WS1 Color:* With integrated indoor sensor. With 1, 2, 3 or 4 drive outputs for 230 V motors or without drive outputs, depending on model.
 - WS1000 Color:* With 4, 6, 8 or 10 drive outputs for 230 V motors, depending on model.
- Weather station
- Manual

Additionally with WS1000 Color:

- WGTH-UP indoor sensor with frame
(You need a socket \varnothing 60 mm, 42 mm deep *additionally*)
- Stylus

1.2. Connection and control options

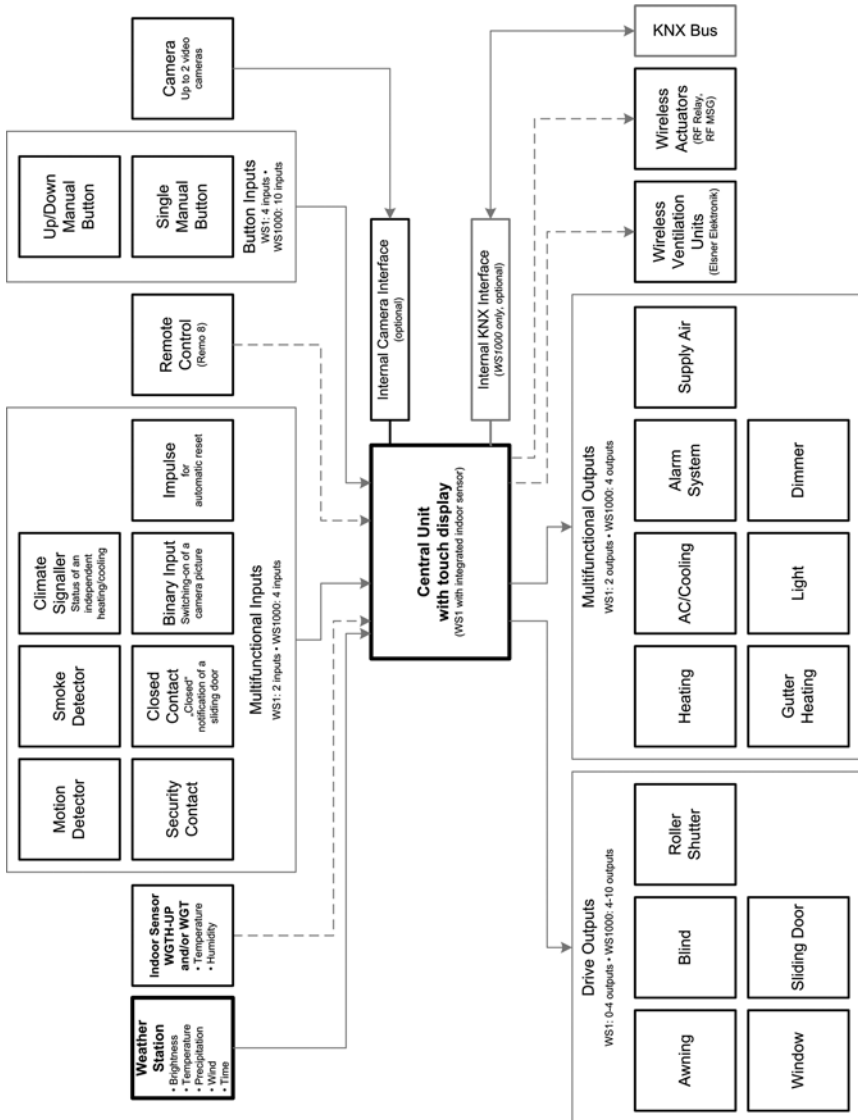

The following **environmental parameters** will be measured and displayed:

- Outdoor and indoor temperature
- Air humidity inside
- Lighting (intensity and direction, twilight recognition)
- Wind speed
- Precipitation
- Time/date

The following drives can be connected to the **drive outputs**:

(WS1 Color: 0-4 drive outputs, WS1000 Color: 4-10 drive outputs)

- Electrically-operated awnings
- Electrically-operated blinds
- Electrically-operated shutters
- Electrically-operated windows and sliding roofs
- Electrically-operated sliding doors

The following devices can be connected to the **multifunctional outputs**:

(WS1 Color: 2 MF outputs, WS1000 Color: 4 MF outputs)

- Heating
- Cooling
- Alarm equipment
- Lighting
- Roof gutter heating
- Ventilation units
- Dimmer (for a light)

The following can be connected to the **multifunctional inputs**:

(WS1 Color: 2 MF inputs, WS1000 Color: 4 MF inputs)

- Motion detector
- Smoke detector
- Climate sensor (A climate or heating unit which is independent of the control unit. Status query "active"/"not active", for cancelling ventilation)
- Safety contacts to keep drives in secured position
- Closed-contact for closing notification of a sliding door
- Impulse for automatic reset (e.g. button or impulse at alarm activation)
- Binary contact

The following devices can be connected via a **wireless connection**:

- WGTH-UP indoor sensors for temperature and humidity measurement at various places in the room. This allows various climate areas to be realised (e.g. living and plant areas in the conservatory)
- WGT temperature sensor for temperature measurement at various places in the room and, for example, in the ground for control of the floor heating
- Radio remote control Remo 8
- Elsner ventilation devices (WL610, WL305, WFL)

- Fan module RF-VM for connecting fans/circulating air heating units from other manufacturers
- RF relay (radio relay, On/Off)
- RF MSG (radio motor control device, Up/Down)

The following **additional options** are available:

- Connection of up to 10 external Up/Down wall buttons for manual operation of drives and devices on the spot
- Connection of up to 2 video cameras via an optional camera interface

The following functions are available with **WS1000 Color** only:

- Presentation of a slideshow on SD card, data storage on SD card
- Communication with the KNX bus system via an optional KNX interface

1.2.1. Automatic functions in overview

Devices connected via the **“Dimmer” output** (e.g. lighting) have no automatic functions. They can however be operated manually via the display.

Sliding doors also have no automatic functions. They can be fitted with a close-contact (to a multifunctional input) and be manually operated via the display.

Automatic functions for windows/sliding roofs:

- Opening above a selectable indoor temperature (can be switched off)
- Opening above a selectable air humidity level in the room (can be switched off)
- Close when the supply air temperature is higher than the room temperature (can be switched off)
- Night-time re-cooling (settable running times)
- Daily forced closure (settable running times)
- Outdoor temperature block: Block beneath a selectable outdoor temperature (can be switched off)
- Keep closed in a period which can be set
- Frost alarm: Close in case of precipitation beneath a selectable outdoor temperature (can be switched off)
- Wind alarm: Close when a selectable wind speed is exceeded (can be switched off)
- Rain alarm: Close when there is precipitation or move to a gap (can be switched off)
- Closing when cooling/air-conditioning unit is active

If a motion detector is connected, windows will be closed automatically when a break-in alarm is triggered. If a smoke detector is connected, windows will be opened automatically when a fire alarm is triggered.

Step windows will be opened step-by-step. An opening position can be set for sliding windows.

Automatic functions for awnings:

- Extend according to brightness and the position of the sun or retract regardless of brightness (extending only manually) or extend regardless of brightness (visual protection, automatically retraction only when there is a rain or wind alarm)
- Adjustable movement position
- Keep retracted until a selectable indoor temperature is reached (can be switched off)
- Outdoor temperature block: Block beneath a selectable outdoor temperature (can be switched off)
- Frost alarm: Retract in case of precipitation beneath a selectable outdoor temperature (can be switched off)
- Wind alarm: Retract when a selectable wind speed is exceeded (can be switched off)
- Rain alarm: Retract when there is precipitation (can be switched off)

If a smoke detector is connected, awnings will be automatically retracted when a fire alarm is triggered.

Automatic functions for blinds:

- Closing according to brightness or position of the sun or keep open regardless of brightness (only time-controlled or manual closing) or keep closed regardless of brightness (visual protection, automatically retract only when there is a rain or wind alarm) with light reversal
- Adjustable movement position and slat position (slat tracking of the sun height possible)
- Leave open until a selectable indoor temperature is reached (can be switched off)
- Close at night/twilight (can be switched off)
- Close daily (settable running times)
- Outdoor temperature block: Block beneath a selectable outdoor temperature (can be switched off)
- Frost alarm: Retract in case of precipitation beneath a selectable outdoor temperature (can be switched off)
- Wind alarm: Retract when a selectable wind speed is exceeded (can be switched off)
- Rain alarm: Retract when there is precipitation (can be switched off)

If a smoke detector is connected, blinds will be opened automatically when a fire alarm is triggered.

Automatic functions for shutters:

- Closing according to brightness or position of the sun or keep open regardless of brightness (only time-controlled or manual closing) or keep closed regardless of brightness (visual protection, automatic retraction only when there is a rain or wind alarm)
- Adjustable movement position

- Leave open until a selectable indoor temperature is reached (can be switched off)
- Close at night/twilight Leave open until
- Close daily (settable running times)
- Outdoor temperature block: Block beneath a selectable outdoor temperature (can be switched off)
- Frost alarm: Retract in case of precipitation beneath a selectable outdoor temperature (can be switched off)
- Wind alarm: Retract when a selectable wind speed is exceeded (can be switched off)
- Rain alarm: Retract when there is precipitation (can be switched off)

If a smoke detector is connected, shutters will be opened automatically when a fire alarm is triggered.

Automatic functions for heatings:

- Switch on daily below a selectable indoor temperature
- Night setback (with adjustment of time and temperature until the setback is made)

If a smoke detector is connected, the heating will be automatically switched off when a fire alarm is triggered.

Automatic functions for coolings and air-conditioning units:

- Switch on daily above a selectable indoor temperature
- Night mode (with adjustment of time and temperature until cooling takes place)
- Cancel ventilation when cooling/air-conditioning unit is active

If a smoke detector is connected, the cooling will be automatically switched off when a fire alarm is triggered.

Automatic ventilation functions:

- Ventilation above a selectable indoor temperature (can be switched off)
- Ventilation above a selectable air humidity level in the room (can be switched off)
- Winter operation: supply air will be closed below a selectable outdoor temperature (can be switched off)
- Summer operation: supply air will be shut off if outdoor temperature is higher than room temperature
- Adjustable minimum and maximum speeds for motorised fans
- Night-time re-cooling (settable running times)
- Daily forced ventilation (settable running times)
- Additionally with roof ventilators WL610 and WL305: recirculating air for heat recovery; recirculating air to avoid condensation
- Cancel ventilation when cooling/air-conditioning unit is active

If a smoke detector is connected, ventilation will be activated automatically when there is a fire alarm.

Automatic functions for light:

- Switch on daily (settable running times, with and without twilight recognition)
- Switch on at twilight
- Switch on when an alarm triggers (motion/smoke detector)

Automatic functions for roof gutter heatings:

- Switch on within an adjustable temperature range

Automatic alarm settings:

- Motion detector: The period of alarm readiness is adjustable. If the alarm is triggered within this period, all windows close. After 5 minutes without a new alarm signal, normal automatic operation will be resumed.
- Smoke detector: When the alarm triggers, shades retract (escape routes), windows open, ventilators open/switch on (getting rid of smoke) and heatings and air conditioners switch off. No manual operation is possible. An acoustic warning signal will sound at the control system.

2. Operation and use

2.1. Weather data display (starting image)

As a starting image, the control system shows the current weather data:

Sun data



Intensity: Light intensity (brightness) in Lux (Ix) or Kilolux (klx)

Direction: Direction (azimuth) in degrees

Height: Elevation over the horizon in degrees

Wind

The wind speed will be shown in metres per second (m/s) and the windsock changes:



Calm: up to 1.9 m/s



Slight wind: 2.0 to 9.9 m/s



Strong wind: 10.0 m/s and up



A caution flag appears besides the wind symbol if wind alarm has been triggered for a drive.

Outdoor temperature



Outdoor temperature at the weather station in degrees Celsius (°C)

Night-time Re-cooling, Frost Alarm and **Window Movement Limitation** are displayed in turn next to the outdoor temperature value as long as the relevant function is active.

📖 3.3. Set night_time re-cooling (ventilation)

📖 3.3. Adjust frost alarm

📖 3.3. Set movement limitations (windows)

Indoor information



Temperature in degrees Celsius (°C)

Air humidity in %RH

You may select which indoor information is displayed (e. g. if several sensors are connected).

System > Installation > Weather Display

 6.1. Indoor sensor for weather display

The general weather situation is shown graphically:

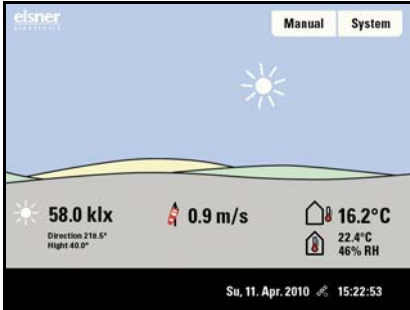

Sunny or cloudy:

The sun moves across the sky according to its current direction and height.

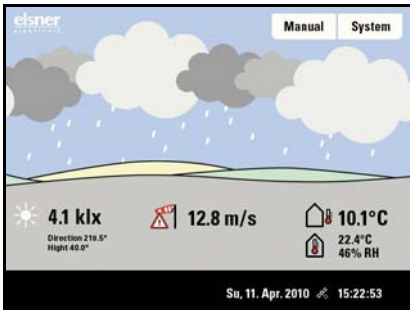

Rain:

When there is a precipitation report and temperatures above -3 °C, it is raining.

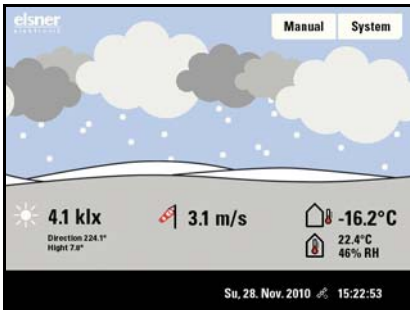

Snow:

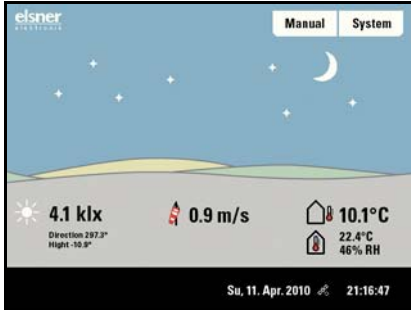

When there is a precipitation report and temperatures below -3 °C, it is snowing.



Night:

At night (twilight) the display will be darker; instead of the sun, the moon and stars will appear.

The date and time will be shown on the lower right on the display. The following symbols are displayed, depending on which source the time signal is from:

GPS reception (from weather station)		Satellite
Reception of time via KNX bus (WS1000 Color) Position must be entered manually for shading control: <input type="checkbox"/> System > WS1000 Settings > Settings > Position  6.2.1. Enter position		Clock

2.2. The touch display

Manual control, as well as setting the defaults for the automatic functions and the connected equipment, is via the control's stationary touch display. The button surfaces are operated in this area by touching the display. When a button is activated, there is visual feedback and a brief audio signal sounds. The sound can be switched off.

- System > WS1 / WS1000 Settings > Settings > Button tone
-  6.2.1. Settings > Button tone

If the push buttons shown do not match up with the touch-sensitive surfaces (you have to press "next to the button"), the touch display can be calibrated as follows.

- System > WS1 / WS1000 Settings > Settings > Calibrate touch
-  6.2.1. Calibrate touch

Operating the display with long fingernails will not damage the screen or the touch function. Touching the display with very hard or pointed objects (e.g. those made from glass, gems or metal) should be avoided as this can cause marks.

A stylus is enclosed with the WS1000 control system. It can be stored in the tray beneath the covering lid.

2.3. Manually operate drives and devices

2.3.1. The „Manual“ menu

You can reach the menu for manual control of drives and equipment by using the button **Manual**:

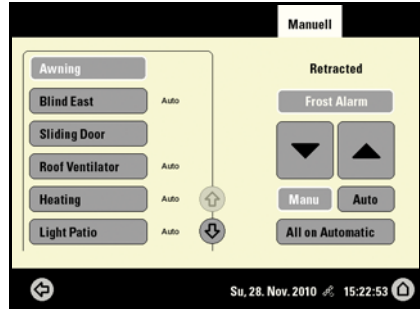
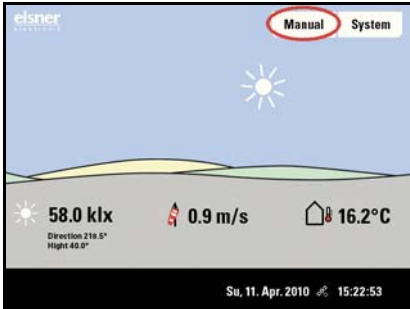

Here you can operate all connected drives and devices directly: Use the buttons to select the name of the drive or device you want to operate. You can change the order of the list in the **System** menu.

- System > Installation > Channel Order
- 6.1. Define channel order



Use the arrow keys to scroll through the list.



The selected device is marked in white. On the right-hand side you will receive status information (e.g. on/off, open/closed, exhaust air level, error messages) and various control options (up/down arrow keys or on/off buttons).

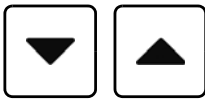

The **Down** and **Up** buttons are fitted with automatic time functions.

Drives:

The drive can be precisely positioned with brief button presses (less than 1 second, short audio signal). For shutters and roller blinds, only a short step-movement command is triggered. If the button is pressed for longer than 1 second (higher audio signal: locking signal), the drive moves independently to the end position. A brief press in the opposite direction stops the drive.

For shades and windows, the movement position is shown in percent above the Up-/Down buttons (for blinds, also the slat position). For radio motor control units, the position shown can deviate from the movement position set in the automatic mode by up to 2%.

Ventilation units WL400 and WL800:

Ventilation units WL400 and WL800 are operated in 10% steps by briefly pressing the button (less than 1 second, brief sound, 10 ventilation levels). By pressing the button longer, the fan speed is changed continuously. Release the button to stop speed change.

Note: In rare cases, radio disturbances can lead to continuing speed change after having released the button. Please briefly press the other direction then.

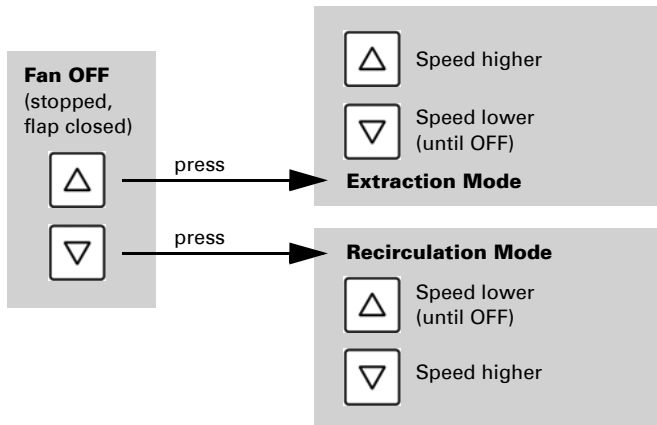

Block because of rain, wind or frost alarm:

If a drive group is momentarily blocked for manual operation by a **rain, wind or frost alarm**, the arrow keys will be greyed out and may not be used. The message "Rain alarm" and/or "Wind alarm" is shown.

The frost alarm can be deactivated by pressing the corresponding button (see diagram); manual operation is then possible again. The frost block will then be first active for this drive again when it is reactivated manually or the next time the frost alarm is triggered.



ATTENTION

Material damage due to movement of frozen shading elements!

The drive and hangings may be damaged if a firmly frozen outdoor shading is moved!

- Make sure the rails are no longer frozen before manually switching off the frost alarm.

Manu

Auto

Whether a drive or device is in automatic mode or manually operated can be recognised from the white marking on the buttons on the right and the text "Auto" next to the name button in the list on the left. By pressing the button you can switch from one to another.

After being operated manually the drive or device remains in manual mode. The automatic functions are thus switched off and only the rain and wind protection will be carried out. The equipment will only switch back into automatic mode when reset by hand ("Manu" button) or through the daily automatic reset. In the Automatic menu, the automatic reset can be activated separately for each drive group and each device.

Automatic Reset

This button allows you to perform the automatic reset manually. All systems for which an automatic reset has been set are then set to automatic mode.



Back to the weather data display (starting image)



External buttons

As well as operating the controls via the display, it is possible to connect external buttons (wall buttons) to the control unit. In the System menu the individual buttons can be assigned to any drives or devices.

System > Installation > Ext. Buttons

6.1. Assign external buttons

2.3.2. Internal buttons (group buttons)

It is possible to operate several drives or devices at the same time via a collective group button (internal software button). This makes it possible to close all windows with a single button press, for example. These group buttons can be set up in the System menu.

System > Installation > Int. Buttons

6.1. Assign internal buttons (group buttons)

2.3.3. Remote control

Drives and equipment can be controlled by using the remote controller Remo 8, which can be ordered among the accessories. The hand-held transmitter must be configured in the control as a participant to the radio network. Then follows the allocation of drives

and equipment to the eight remote control channels. In the control, several Remo 8 devices can be configured.

📖 6.1. Wireless connections

2.4. Navigation in the System menu

All settings for drives and devices, for the automation and the control system are changed in the System menu, which you reach via the **System** button:

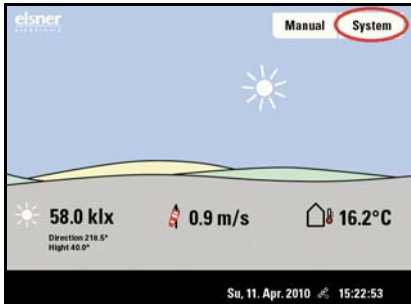

In three sub-menus you can carry out the following adjustments:

Installation:

- Specify fundamental characteristics of the drives at inputs/outputs
- Set up wireless connections to devices
- Define the order in which the drives and devices are shown (e.g. in the manual menu)

Automatic settings:

- Define automatic functions for the individual drives and devices
- Adjust general automatic settings: Twilight value, movement delays, forced closure, ventilation block and automatic reset

Control Settings:

- Change personal data such as Time/Date and location and adjust the screen display to your personal preferences
- Restart the control unit, reset to factory defaults and change internal settings
- Set an access code to protect the "Installation" and "Automatic Settings" menus from unauthorised changes.

The following buttons are needed constantly for navigation in the System menu:



Back to the previous menu level (only settings already saved with OK will be applied)



Back to the weather data display (starting image)



Confirms (saves) adjustments made



Info button: Appears in many menus next to the option settings. Press the button for an explanation of the function shown in the upper display area. Press again for the explanation to disappear.

On the top right, beneath the System field, is shown which menu you are currently in as well as the path by which you arrived there. For example, if you are in the Automation menu for the light intensity of the “South awning”, the path will be:

System > Automation > Awning > Awning South > Intensity

2.4.1. Input keyboard for names and codes

In some menus an input keyboard for names and codes appears. The words can be typed in completely normally.

Special keys:



Selects the input keyboard for letters and numbers.



Selects the input keyboard for symbols and umlauts.



Delete. Removes the preceding character.



Shift key. Switches between upper and lower case letters.

2.5. Slideshow

This function is not available with WS1 Color.

The WS1000 Color can play back digitally-stored image data as a slideshow. For this, the image data must be saved onto an SD card and fulfil the following requirements:

- Data format Bitmap (BMP)
- Size 640 x 480 pixels
- Color intensity 24 bit or 16 bit
- No compression (RLE)
- The data must be saved in the uppermost level of the card's directory (root directory)

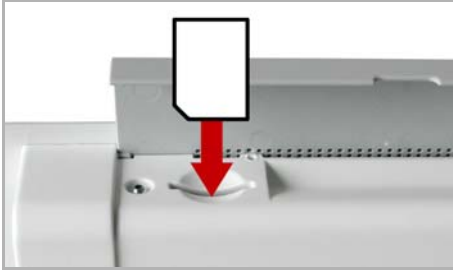

The SD card slot can be found beneath the covering flap. The SD card is pushed into the slot, until it clicks into place.

The card will automatically be recognised. If image data are stored on the card, the symbol for „play-back“ appears at the bottom right-hand side of the weather data display.



Press „play-back“ to start the slideshow.

The image changes approx. every 45 seconds (for images with 24-bit color intensity). To return to the weather data display, touch the screen or remove the SD card (briefly press down on the card so that it pops out).

Further information about the image display can be found in chapter

📖 6.2. Using an SD card

3. Automatic settings

3.1. Automatic settings

In the menu **System > Automatic Settings** you can make the following adjustments:

- Define automatic functions for the individual drives and devices
- Adjust general automatic settings: Twilight value, movement delays, timer, ventilation block, night time re-cooling, frost alarm and automatic reset

In order to set the automatic functions, the basic settings must already have been made.

 6. Basic setting

Please adjust the settings for drives and devices to your individual circumstances. Only in this way can alarm and blocking functions like rain or wind warnings help to protect external awnings or prevent rain from coming in through the window.

3.1.1. Safety notice for automatic and alarm functions



WARNING!

Risk of injury due to automatically moved components!

The automatic control may cause parts of the system to travel and pose a danger to humans.

- No persons may remain in the travelling range of parts driven by an electric motor.
- Adhere to the relevant building regulations (see guideline for power-operated windows, doors and gates BGR 232 et al).
- Always disconnect the system from the mains power before maintenance or cleaning (e.g. switch off/remove fuse).

Precipitation warning for automatically controlled windows:

Some time can pass before falling rain is recognised by the sensors in the system, depending on the rain amount and outdoor temperature. Furthermore, a closure time must be calculated for electrically-actuated windows or sliding roofs. Humidity-sensitive items should therefore not be placed in an area where they might be damaged by incoming precipitation. Please also bear in mind that in the event of a power failure and rainfall, a window will not be automatically closed if no emergency generator is installed.

Running rails of shades icing up:

Note that the rails of shutters, awnings and blind which are externally mounted can ice up. Operating the drive under such conditions can damage the shades and drives.

Power failure, maintenance works, etc. (restart of control)

If a power outage occurs, the control unit can no longer control the connected drives! If the functional scope must be guaranteed even during a power cut, an emergency power unit with a corresponding switch from network power to emergency operation should be installed by the customer.

Settings saved in the control unit programme will be maintained even during a power outage.

Note: After every re-start (e. g. return of voltage after mains failure or manual reset) all drives and devices with active automatic reset are in automatic mode.

If cleaning or maintenance work is to be carried out in the conservatory/building, the control unit should be de-energised and secure against restart by disconnection of the customer-installed fuse. This ensures that the connected drives cannot start.

3.1.2. Automatic settings for drive groups and devices

3.1.3. Drives and devices without automatic functions

Devices connected via the **“Dimmer” output** (e.g. lighting) have no automatic functions. They can however be operated manually via the display.

Sliding doors also have no automatic functions. They can also be operated manually via the display. In addition, sliding doors can be fitted with a close-contact (connection to a multifunctional input). In this way the control unit knows whether the door is open or closed.

3.1.4. Automatic awning settings

For connected awnings or awning groups the following automatic settings can be changed:

- Light intensity
- Direction of sun
- Height of sun
- Movement position
- Indoor sensor to be used for the awning
- Indoor temperature block
- Outdoor temperature block
- Frost alarm
- Wind alarm
- Rain alarm
- Enable/Disable automatic reset

Alarm functions

Alarm functions are used for awnings in manual and in automatic mode.

Fire alarm of a smoke detector has highest priority. All awnings are retracted and cannot be influenced either by automatic or manual.

During **frost, wind or rain alarm** the awnings are retracted and cannot be manually extended.

Shade settings

The settings are only executed if an awning is in automatic mode and none of the alarm functions named above is active.

Highest priority is assigned to the **outdoor temperature-block**, followed by the **indoor temperature-block** (retract).

Only when the direction and height of the sun agree and there is no active block is the **automatic shading by light intensity** engaged.

Setting of the automatic

The automatic awning functions can be accessed by pressing the buttons:



Now you can select individual awnings and adjust their settings. For each awning the following settings can be changed:



Press the button to set the brightness above which the awning will be deployed to offer shade.

Adjust value: Use the arrow buttons to change the value as you wish.

Default setting: 40 kLux.

 7.2. Units for sun and wind

Remain retracted: If the awning should not react to the brightness, select **Never**. The awning will then remain retracted unless it is manually operated.

Confirm your setting with the **OK** button.

For the automatic system to react, the set light intensity value must be exceeded or undercut for the duration of the delay times. This prevents constant extensions and re-

traction of the awning during rapid-changing light conditions. The movement delays can be adjusted.

System > Automatic Settings > General Settings > Movement Delays

 3.3. Adjust movement delays (shading elements)

Direction of sun

Press the button to set the range (sun direction) in which the sun shall be, so that the awning provides shade.

All directions: If the sun's orientation is not decisive for shading purposes, select **All sides** (default setting).

Direction: If the shade should only be deployed when the sun is in a specific orientation, select as appropriate: **West, South-West, South, South-East** or **East**. The thickened part of the circle in the centre shows the selected area.

Enter angle: To set the range in which shading shall be provided in exact numbers, press the "from **0°**" or "to **360°**" and adjust the numeric values with the arrows keys that appear.

Confirm your setting with the **OK** button.

For as long as no time signal has been received and the time has not been entered manually (the display on the control unit will show "Please set clock!"), the shades will only be controlled based on light intensity, temperature and alarm reports. The position of the sun will not be taken into account.

Height of sun

Press the button to set the range (sun height) in which the sun shall be, so that the awning provides shade.

Any angle: If the height of the sun is not decisive for shading purposes, select Any height (default setting).

Enter angle: To exactly specify the height numerically, change the number values "smaller **90°**" or "larger **0°**" with the adjacent arrow keys. The thickened part of the graphic shows you the selected area.

Confirm your setting with the **OK** button.

For as long as no time signal has been received and the time has not been entered manually (the display on the control unit will show "Please set clock!"), the shades will only be controlled based on light intensity, temperature and alarm reports. The position of the sun will not be taken into account.

Movem. Position

Press the button to set the movement position for the automatic mode. With the arrow keys, specify the movement position in % (0% = fully retracted, 100% = fully extended). Default setting: 75%.

Confirm your setting with the **OK** button.

Sensor Selection

Press the button to select the indoor sensor the control system will use for this awning (Pre-setting: Internal sensor at WS1, first sensor in the list at WS1000). As long as "**No Sensor**" is selected, the indoor temperature will not be taken into account by the control system for this shade.

Confirm your setting with the **OK** button.

Indoor Temp.

Press the button to set the indoor temperature block. Until an indoor sensor is selected, the indoor temperature block will not be active.

The interior blocking temperature enables the use of solar energy to warm the room. When the indoor temperature is below the set value, e.g. in the morning, the shading will remain retracted despite the sunshine.

As soon as the set indoor temperature is exceeded, the block is released and the shade is activated.

When the indoor temperature drops once again, the block is reactivated when the temperature drops below the pre-set value by more than 3.0°C (hysteresis). Note that the shade only retracts once the retraction delay time has elapsed.

- System > Automatic Settings > General Settings > Movement Delays
-  3.3. Adjust movement delays (shading)

Set temperature: With the arrow keys, adjust the value for the desired room temperature. Default setting: 25.0 °C.

Disable block: If the awning should be deployed to offer shade regardless of the indoor temperature, press the **Off** button.

Confirm your setting with the **OK** button.

Outdoor Temp.

Press the button to set the outdoor temperature block. The block only applies to automatic operation; no shading occurs based on light intensity or the position of the sun. Even when an outdoor blocking temperature is active, the drive will respond to wind and rain alarms, as well as manual movement commands.

Please note that the shade rails or other mechanical components can remain iced even when the outdoor temperature has already risen to a relatively high value.



The drive and hangings may be damaged if a firmly frozen outdoor shading is moved!

Set temperature: If the awning should be blocked when the outdoor temperature is low, set the value recommended by the manufacturer using the arrow keys. Default setting: 5.0 °C. The block is countermanded again when the temperature rises more than 2.0°C over the pre-set value (hysteresis).

Set the shade **behavior** in the next menu item.

Disable block: If the awning should be deployed to offer shade regardless of the outdoor temperature (for example with internal awnings), press the **Off** button.

Confirm your setting with the **OK** button.

Behavior

Set the way in which the shade should behave when the outdoor temperature block is triggered. The button is only active once an outdoor temperature has been set.

Retract: If the shade should retract when the outdoor temperature falls below the set value, select **Yes** (default setting). The shade is only retracted once the movement delay time has elapsed.

Remain in current position: If the shade should not move when the outdoor temperature falls below the set value, select **No**. When the rain or wind alarm is triggered, the shade will be retracted nonetheless (the alarm has priority over blocking temperature).

Confirm your setting with the **OK** button.

Frost Alarm

Press the button to active or deactivate the frost alarm for this shade. The frost alarm retracts the sun shade if the outdoor temperature is low and it is raining/snowing at the same time. This protects external shades from icing and from damage through movement when the rails are iced up.

The conditions for the triggering of the frost alarm (outdoor temperature, period) are defined in the menu „General Settings“.

System > Automatic Settings > General Settings > Frost Alarm

 Adjust frost alarm, page 62

When the frost alarm is triggered, manual operation of the shade is initially blocked. You can remove the block manually however. To do this select the appropriate shade in the Manual menu and press the frost alarm button. If the button is shown normally (black writing), the block has been removed. The block will then be first active for this drive again if it is reactivated manually or the next time the frost alarm is triggered. Please note that the shade rails or other mechanical components can remain iced even when the outdoor temperature has already risen to a relatively high value.



The drive and hangings may be damaged if a firmly frozen outdoor shading is moved!

Activate: If the sun shade is to be retracted when there is a frost alarm, select **Yes**.

Deactivate: If the sun shade should offer shade regardless of the frost risk (e.g. for internal awnings), select **No** (default setting).

Confirm your setting with the **OK** button.

Wind Alarm

Press the button to set the wind alarm. The wind alarm protects the sensitive awning cloth from damage by retracting the awning.

Adjust values: Use the arrow keys to adjust the value for wind speed and the length of time by which it must have been exceeded.

Disable: If the awning should not react to the wind (e.g. internal awnings), select **Never retract** (default setting).

Confirm your setting with the **OK** button.

A wind alarm triggered for the drive will remain active for 5 minutes. Additionally, a wind delay can be set for shades. Then the automatic functions remain switched off for the defined period of time after the end of the wind alarm. Manual operation is however possible again.

- System > Automatic Settings > General Settings > Wind Delay
-  3.3. Setting a wind delay (shades)

Rain Alarm

Press the button to enable or disable the rain alarm. The rain alarm protects the sensitive awning cloth from damage by retracting the awning.

Enable: For moisture-sensitive external awnings, select **Yes** (awning should be retracted when it rains).

Disable: For internal awnings, select **No** (awning should not be retracted when it rains, default setting).

Confirm your setting with the **OK** button.

Automatik Reset

Press the button to enable or disable the switchover to automatic mode at a set point in time, or following a manual intervention.

The general Automatic Reset occurs daily at the same time.

Switching on: To set the awning to Automatic at a set point in time, select **Yes** (this is the default setting).

Switching off: To switch off the awning's Reset function, select **No**.

Alternatively, the automatic function can be reactivated at a set time following a manual intervention.

Switching on: To perform an Automatic Reset after a manual intervention, select **Yes**.
Switching off: To switch off the awning's Reset function, select **No** (this is the default setting).

Confirm your setting with the **OK** button.

Automatic Reset time and/or period can be set.

System > Automatic Settings > General Settings > Automatic Reset

 3.3. Define automatic reset

3.1.5. Automatic blind and roller shutter settings

For connected blinds and roller shutters (or groups of blinds/roller shutters) the following automatic settings can be changed:

- Light intensity
- Direction of sun
- Height of sun
- Movement position
- Slat position (only for blinds)
- Indoor sensor to be used for the blind/roller shutter
- Indoor temperature block
- Night closure
- Timed closure
- Outdoor temperature block
- Frost alarm
- Wind alarm
- Rain alarm
- Enable/Disable automatic reset

Alarm Functions

Alarm functions are used for shades in manual and in automatic mode.

Fire alarm of a smoke detector has highest priority. All shades are retracted and cannot be influenced either by automatic or manual operation.

During **frost, wind or rain alarm** the shades are retracted and cannot be manually extended.

Shade settings

The settings are only executed if a shade is in automatic mode and none of the aforementioned alarm functions is active.

The highest priority is given to the **outdoor temperature block**, followed by **timed closure** (extend), **night closure** (extend) and **indoor temperature-block** (retract).

Only when the direction and height of the sun agree and there is no active block is the **automatic shading by light** intensity engaged.

Setting of the automatic

The automatic blind functions can be accessed by pressing the buttons:



The automatic roller shutter functions can be accessed by pressing the buttons:



Now you can select individual blinds respectively roller shutters and adjust their settings. For each shade the following settings can be changed:

Intensity

Press the button to set the brightness above which the blind respectively the roller shutter will be deployed to offer shade.

Adjust value: Use the arrow buttons to change the value according to your desire. Default setting: 40 kLux.

7.2. Units for sun and wind

Keep closed: If the blind respectively the roller shutter should remain closed when there is brightness, select **Always**. The shading will then remain closed and will only be retracted when the rain or wind alarms trigger, if these functions have been activated. The slat (for blinds) and movement position can be adjusted individually. Manual opening is possible.

Leave open: If the blind respectively the roller shutter should not react to the brightness, select **Never**. The shading will then only be closed in the night closing and time closing periods set by you. Manual closing is possible.

Confirm your setting with the **OK** button.

For the automatic system to react, the set light intensity value must be exceeded or undercut for the duration of the delay times. This prevents constant up and down movement of the shading during rapidly changing light conditions. The movement delays can be adjusted.

System > Automatic Settings > General Settings > Movement delays

3.3. Adjust movement delays (shading elements)

Direction of sun

Press the button to set the range (sun direction) in which the sun shall be, so that the blind/roller shutter provides shade.

All directions: If the sun's orientation is not decisive for shading purposes, select **All sides** (default setting).

Direction: If the shade should only be deployed when the sun is in a specific orientation, select as appropriate: **West**, **South-West**, **South**, **South-East** or **East**. The thickened part of the circle in the centre shows the selected area.

Enter angle: To set the range in which shading shall be provided in exact numbers, press the "from **0°**" or "to **360°**" and adjust the numeric values with the arrows keys that appear.

Confirm your setting with the **OK** button.

For as long as no time signal has been received and the time has not been entered manually (the display on the control unit will show "Please set clock!"), the shades will only be controlled based on light intensity, temperature and alarm reports. The position of the sun will not be taken into account.

Height of sun

Press the button to set the range (sun height) in which the sun shall be, so that the blind/roller shutter provides shade.

Any angle: If the height of the sun is not decisive for shading purposes, select Any height (default setting).

Enter angle: To exactly specify the height numerically, change the number values "smaller **90°**" or "larger **0°**" with the adjacent arrow keys. The thickened part of the graphic shows you the selected area.

Confirm your setting with the **OK** button.

For as long as no time signal has been received and the time has not been entered manually (the display on the control unit will show "Please set clock!"), the shades will only be controlled based on light intensity, temperature and alarm reports. The position of the sun will not be taken into account.

Movem. Position

Press the button to set the movement position for the automatic shading. With the arrow keys, specify the movement position in % (0% = fully retracted, 100% = fully extended). Default setting: 75%.

Confirm your setting with the **OK** button.

Slat position

Only for blinds!

Press the button to set the angular position of the slats.

Fixed angle: If the slats should be opened at a fixed angle after reaching the movement position, leave the button position at No (do not follow the sun's height). With the ar-

row keys, specify the slat position in % (0% = closed, 50% = horizontal, 100% = closed). Default setting: 75% (slightly open).

Tracking the position of the sun: If the slats should be opened in accordance with the position of the sun, press the button so it changes to Yes. You can adjust the slat opening for the various angles of the sun. For this use the arrow keys next to the % details. Default setting: 0° to 15°: 100% (closed), 15° to 30°: 80%, 30° to 45°: 65%, 45° to 90°: 50% (horizontal).

Confirm your setting with the **OK** button.

Sensor Selection

Press the button to select the indoor sensor the control system will use for these blinds respectively shutters (Pre-setting: Internal sensor at WS1, first sensor in the list at WS1000). As long as "**No Sensor**" is selected, the indoor temperature will not be taken into account by the control system for this shade.

Confirm your setting with the **OK** button.

Indoor Temp.

Press the button to set the indoor temperature block. Until an indoor sensor is selected, the indoor temperature block will not be active.

The interior blocking temperature enables the use of solar energy to warm the room. When the indoor temperature is below the set value, e.g. in the morning, the shading will remain retracted despite the sunshine.

As soon as the set indoor temperature is exceeded, the block is released and the shade is activated.

When the indoor temperature drops once again, the block is reactivated when the temperature drops below the pre-set value by more than 3.0°C (hysteresis). Note that the shade only retracts once the retraction delay time has elapsed.

- System > Automatic Settings > General Settings > Movement Delays
-  3.3. Adjust movement delays (shading)

Set temperature: With the arrow keys, adjust the value for the desired room temperature. Default setting: 25.0 °C.

Disable block: If the blinds respectively shutters should be deployed to offer shade regardless of the indoor temperature, press the **Off** button.

Confirm your setting with the **OK** button.

Night Closure

Press the button to enable or disable the closing of the blind respectively the roller shutter at night.

Enable: If the blind respectively the roller shutter should be closed at night, select **Yes**.
Disable: If the blind respectively the roller shutter should remain open at night, select **No** (default setting).

Confirm your setting with the **OK** button.

The threshold value, above which twilight/night will be recognised, can be adjusted.

System > Automatic Settings > General Settings > Twilight

 3.3. Adjust twilight value

Note to night closing function and outdoor temperature block:

If the outdoor temperature is below the blocking temperature (see "Outdoor Temperature" settings), the blinds and roller shutters will close, but will not open automatically. If the blind/shutter fails to move up in the morning, please check if the hangings are not frozen or the rails iced. When the shading is free, you can move the hangings up by hand.



The drive and hangings may be damaged if a firmly frozen outdoor shading is moved!

Timed closure

Press the button to set the closure time. Press Select to select the time during which the blind respectively the roller shutter will be closed. Activate one or more periods on the list. The periods can be individually customised (see below).

Confirm your setting with the **OK** button.

To change any of the time periods, press **Timer**.

 Set timer, page 59

Note to timer closing function and outdoor temperature block:

If the outdoor temperature is below the blocking temperature (see "Outdoor Temperature" settings), the blinds and roller shutters will close, but not open automatically. If the blind/shutter fails to move up after the preset period, please check if the hangings are not frozen or the rails iced. When the shading is free, you can move the hangings up by hand.



The drive and hangings may be damaged if a firmly frozen outdoor shading is moved!

Outdoor Temp.

Press the button to set the outdoor temperature block. The block only applies to automatic operation; no shading occurs based on light intensity or the position of the sun.

Even when an outdoor blocking temperature is active, the drive will respond to wind and rain alarms, as well as manual movement commands.

Please note that the shade rails or other mechanical components can remain iced even when the outdoor temperature has already risen to a relatively high value.



The drive and hangings may be damaged if a firmly frozen outdoor shading is moved!

Set temperature: If the blind respectively the roller shutter should be blocked when the outdoor temperature is low, set the value recommended by the manufacturer using the arrow keys. Default setting: 5.0 °C. The block is countermanded again when the temperature rises more than 2.0°C over the pre- set value (hysteresis).

Set the shade **behavior** in the next menu item.

Disable block: If the blind respectively the roller shutter should be deployed to offer shade regardless of the outdoor temperature, press the **Off** button.

Confirm your setting with the **OK** button.

Behavior

Set the way in which the shade should behave when the outdoor temperature block is triggered. The button is only active once an outdoor temperature has been set.

Retract: If the shade should retract when the outdoor temperature falls below the set value, select **Yes** (default setting). The shade is only retracted once the movement delay time has elapsed.

Remain in current position: If the shade should not move when the outdoor temperature falls below the set value, select **No**. When the rain or wind alarm is triggered, the shade will be retracted nonetheless (the alarm has priority over blocking temperature).

Confirm your setting with the **OK** button.

Frost Alarm

Press the button to active or deactivate the frost alarm for this shade. The frost alarm retracts the sun shade if the outdoor temperature is low and it is raining/snowing at the same time. This protects external shades from icing and from damage through movement when the rails are iced up.

The conditions for the triggering of the frost alarm (outdoor temperature, period) are defined in the menu „General Settings“.

System > Automatic Settings > General Settings > Frost Alarm

3.3. Adjust frost alarm

When the frost alarm is triggered, manual operation of the shade is initially blocked. You can remove the block manually however. To do this select the appropriate shade in the Manual menu and press the frost alarm button. If the button is shown normally

(black writing), the block has been removed. The block will then be first active for this drive again if it is reactivated manually or the next time the frost alarm is triggered. Please note that the shade rails or other mechanical components can remain iced even when the outdoor temperature has already risen to a relatively high value.



The drive and hangings may be damaged if a firmly frozen outdoor shading is moved!

Activate: If the sun shade is to be retracted when there is a frost alarm, select **Yes**.

Deactivate: If the sun shade should offer shade regardless of the frost risk, select **No** (default setting).

Confirm your setting with the **OK** button.

Wind Alarm

Press the button to set the wind alarm. The wind alarm protects the system from damage by retracting the blind respectively the roller shutter.

Adjust values: Use the arrow keys to adjust the value for wind speed and the length of time by which it must have been exceeded.

Disable: If the blind respectively the roller shutter should not react to the wind, select **Never retract** (default setting).

Confirm your setting with the **OK** button.

A wind alarm triggered for the drive will remain active for 5 minutes. Additionally, a wind delay can be set for shades. Then the automatic functions remain switched off for the defined period of time after the end of the wind alarm. Manual operation is however possible again.

System > Automatic Settings > General Settings > Wind Delay

 3.3. Setting a wind delay (shades)

Rain Alarm

Press the button to enable or disable the rain alarm. The rain alarm protects against moisture damage by retracting the blind respectively the roller shutter.

Enable: If the shading should be retracted when there is rain, select **Yes**.

Disable: If the shading respectively the roller shutter should remain closed when there is rain, select **No**. (default setting).

Confirm your setting with the **OK** button.

Automatic Reset

Press the button to enable or disable the switchover to automatic mode at a set point in time, or following a manual intervention.

The general Automatic Reset occurs daily at the same time.

Switching on: To set the blind respectively the roller shutter to Automatic at a set point in time, select **Yes** (this is the default setting).

Switching off: To switch off the blind's/shutter's Reset function, select **No**.

Alternatively, the automatic function can be reactivated at a set time following a manual intervention.

Switching on: To perform an Automatic Reset after a manual intervention, select **Yes**.

Switching off: To switch off the blinds's/ shutter's Reset function, select **No** (this is the default setting).

Confirm your setting with the **OK** button.

Automatic Reset time and/or period can be set.

System > Automatic Settings > General Settings > Automatic Reset

 3.3. Define automatic reset

3.1.6. Automatic window settings

For connected windows, sliding roofs, step windows or window groups, the following automatic settings can be changed:

- Indoor sensor to be used for the window
- Indoor temperature
- Air humidity
- Supply air temperature
- Night-time re-cooling (together with indoor temperature and movement position for night-time re-cooling)
- Movement position (only for sliding windows)
- Number of steps (only for step windows)
- Timed ventilation
- Outdoor temperature
- Timed closure
- Frost alarm
- Wind alarm
- Rain alarm
- Gap ventilation
- Gap position
- Enable/Disable automatic reset

Alarm Functions

Alarm functions are used for windows in manual and in automatic mode.

Fire alarm of a smoke detector has highest priority. All windows are opened and cannot be influenced either by automatic or manual operation.

In the case of a **break-in alarm** from a motion detector all windows are closed. The windows can be operated again immediately after the break-in alarm.

During **frost, wind or rain alarm** all windows are closed and cannot be manually opened. Gap ventilation during a rain alarm is an exception; it only restricts the window's range of motion in automatic mode.

As soon as a connected **air conditioner is activated**, all windows are closed. They are then in automatic mode but can be immediately operated again. The delay time for the ventilation block engaged by an air conditioner can be adjusted.

System > Automatic Settings > General Settings > Ventilation Block

 3.3. Adjust ventilation block

Ventilation settings

The settings are only executed if a window is in automatic mode and none of the alarm functions named above is active.

Highest priority is assigned to **time closure**, followed by the **outdoor temperature-block** (keep closed), **timed ventilation** (open), the incoming **air temperature-block** (keep closed) and **night-time re-cooling** (open).

This means that e.g. timed ventilation or night-time re-cooling will only occur, when the outdoor temperature lies over the pre-set value for the outdoor temperature block.

The **automatic ventilation according to temperature** or relative humidity is only performed if no block is active.

Setting of the automatic

The automatic window functions can be accessed by pressing the buttons:

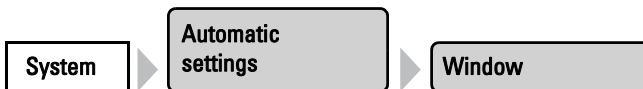

Now you can select individual windows and adjust their settings. For each window the following settings can be changed:

Sensor Selection

Press the button to select the indoor sensor the control system will use for this window (Pre-setting: Internal sensor at WS1, first sensor in the list at WS1000). As long as "**No Sensor**" is selected, the indoor temperature and air humidity will not be taken into account.

Confirm your setting with the **OK** button.

Indoor Temp.

Press the button to set the indoor temperature above which the window will be opened. Until an indoor sensor is selected, the indoor temperature will be disregarded.

Setting the temperature: Adjust the value for the desired room temperature using the arrow buttons. Pre-setting: 25.0 °C.

The window is opened as soon as the temperature lies above the pre set value. It is closed again once the temperature sinks more than 2.0°C under the pre-set value (hysteresis).

Shutting off ventilation: If ventilation shall be independent of indoor temperature, press the button labelled **OFF**.

Confirm your setting with the **OK** button.

Air Humidity

Press the button to set the air humidity above which the window will be opened. Until an indoor sensor with humidity measurement is selected, the air humidity will be disregarded.

Setting air humidity: Adjust the value for the desired humidity using the arrow buttons. Pre-setting: 80%.

The window is opened as soon as the humidity lies above the pre- set value. However, it is only closed again when the humidity sinks by more than 3.0% under the pre-set value (hysteresis).

Shutting off ventilation: If ventilation is to be independent of the air humidity, press the button labelled **OFF**.

Confirm your setting with the **OK** button.

Supply-Air Temp.

Press the button to set the supply air temperature block (heat protection).

Enable: If the window should be closed when the air supply temperature is higher than the room temperature, select **Yes**.

The supply air temperature-block becomes active as soon as the incoming air temperature lies above the room temperature. The block is however only deactivated again when the incoming air temperature sinks below the room temperature by more than 3.0°C (hysteresis).

Disable: If the window should also then be/remain open when the supply air temperature is higher than the room temperature, select **No** (default setting).

Confirm your setting with the **OK** button.

Movem. Position**Only for sliding windows.**

Press the button to set the movement position for a sliding window in automatic mode. The window can also be fully opened by hand.

With the arrow keys, specify the movement position in % (0% = closed, 100% = fully open). Default setting: 75%.

Confirm your setting with the **OK** button.

Number of steps**Only for step windows.**

Press the button to set the number of movement steps for a step window in automatic mode. With step windows the control unit checks every 3 minutes whether the set room temperature or air humidity has been exceeded and then moves up another step if necessary.

Specify the desired number of steps with the arrow keys. Default setting: 5.

Confirm your setting with the **OK** button.

Night-time cooling

Press the button to set the times for night-time re-cooling. The button is only activated once the general settings for night-time re-cooling have been configured.

- System > Automatic Settings > General Settings > Night-time Cooling
-  3.3. Set night-time re-cooling

Press **Select** to select the time during which the night-time re-cooling will operate. Activate one or more periods on the list.

Confirm your setting with the **OK** button.

To change any of the time periods, press **Timer**.

-  3.3. Set timer

Be careful that your settings for timed closure do not prevent night-time re-cooling operations!

NTC Indoor Temp.

Press the button to set the indoor temperature to the desired cooling level (for the night-time re-cooling). The button is only activated once a night-time re-cooling period has been set.

Use the arrow keys to change the value as required. Default setting: 16.0°C.

Confirm your setting by pressing **OK**.

NTC Movem. Pos.

Press the button to set the movement position for the night-time re-cooling. The button is only activated once a night-time re-cooling period has been set.

Input the movement position in % using the arrow keys (0% = closed, 100% = fully open). Default setting: 30%.

Confirm your setting by pressing **OK**.

Timed Ventilation

Press the button to set the ventilation running time. However the window will only open if the specified outdoor temperature is reached. At the end of a ventilation period, the normal automatic ventilation according to temperature and air humidity will be executed.

Press **Select** to select the time periods. Activate one or more periods on the list. The periods can be individually customised (see below).

Confirm your setting by pressing **OK**.

To change any of the time periods, press Timer.

 3.3. Set timer

Movement Limitation

Press the button to activate or deactivate the movement range limitation for this window at low outdoor temperatures.

The conditions for the triggering of the movement limitation (outdoor temperature, period) are defined in the "General Settings" menu.

System > Automatic Settings > General Settings > Movement Limitation

 3.3. Set movement limitations (windows)

Confirm your setting by pressing **OK**.

to Position

Press the button to set the movement position when movement limitation is active. The button will only be activated once the movement limitation has been activated.

Input the maximum movement position in % using the arrow buttons (0% = closed, 100% = fully open). Default: 50%.

The window can be reopened fully by hand.

Confirm your setting using the OK button.

Confirm your setting by pressing **OK**.

Outdoor Temp.

Press the button to set the outdoor temperature block. The effect of the block is that the window remains in the current position. The outdoor temperature block can, for example, be used if the window should not be used for ventilation in winter (cold protection for plants).

The outdoor temperature block only applies for automatic operation; no ventilation then takes place. When the rain or wind alarm is triggered, the window will be closed despite the outdoor temperature block (the alarm has priority over temperature block).

Manual operation continues to remain possible, even when the window is blocked because of low outdoor temperatures.

Set value: Use the arrow buttons to change the value according to your wish. Default setting: 5.0°C

The outdoor temperature-block becomes active as soon as the temperature sinks under the pre-set value. The block is however only deactivated again when the temperature rises over the pre-set value by more than 2.0°C (hysteresis).

Disable block: If the window should be controlled independently of the outdoor temperature, press the button **Off**.

Confirm your setting with the **OK** button.

Timed closure

Press the button to set the closure time. Closure periods prevent the windows, for example, from opening and closing at night, and thus causing noise. Note that no night-time re-cooling is possible during the set closure periods.

Press **Select** to select the time during which the window should be closed. Activate one or more periods on the list. The periods can be individually customised (see below).

Confirm your setting by pressing **OK**.

To change any of the time periods, press **Timer**.

 3.3. Set timer

Frost Alarm

Press the button to activate or deactivate the frost alarm for this window. The frost alarm closes the window if the outdoor temperature is low and it is raining/snowing at the same time. This prevents damage from ice (e.g. at the seal).

The conditions for the triggering of the frost alarm (outdoor temperature, period) are defined in the menu „General Settings“.

System > Automatic Settings > General Settings > Frost Alarm

 3.3. Adjust frost alarm

When the frost alarm is triggered, manual operation of the window is initially blocked. You can remove the block manually however. To do this select the appropriate window in the Manual menu and press the frost alarm button. If the button is shown normally (black writing), the block has been removed. The block will then be first active for this drive again when it is reactivated manually or the next time the frost alarm is triggered.

Activate: If the window is to be closed when there is a frost alarm, select **Yes**.

Deactivate: If ventilation is to take place via the window regardless of the frost risk, select **No** (default setting).

Confirm your setting with the **OK** button.

Wind Alarm

Press the button to set the wind alarm. The wind alarm protects the unit and equipment from damage by closing the window. The wind alarm will also close manually opened windows.

Adjust values: Use the arrow keys to adjust the value for wind speed and the length of time by which it must have been exceeded.

Disable: If the window should not react to the wind, select **Never close** (default setting).

Confirm your setting with the **OK** button.

A wind alarm triggered for the drive will be maintained for 5 minutes. If during these 5 minutes the saved value is exceeded again, the holding time begins again.

Rain Alarm

Press the button to enable or disable the rain alarm. The rain alarm protects against moisture damage by closing the window. The rain alarm will also close manually opened windows.

Enable: If the window should be closed when there is rain, select **Yes**.

Disable: If the window should remain open when there is rain, select **No** (default setting).

Confirm your setting with the **OK** button.



When precipitation begins, depending on the amount of rain and the temperature, some time may pass before the precipitation is recognised by the weather station. The operating time taken to close the window must also be included in this calculation. Moisture-sensitive objects should therefore not be placed within the area of the automatic window.

Gap Ventilation

Press the button to enable or disable gap opening when a rain alarm triggers. The function is only active if the rain alarm is switched on. With gap opening, the window can be opened a little despite a rain alarm.

Enable: If gap opening should be active when it rains, select **Yes**.

Disable: If the window should be completely closed when there is rain, select **No** (default setting).

Confirm your setting with the **OK** button.

Please note that gap ventilation is not possible if the MSG Control has been activated (signal duration set to permanent) in the basic settings of the window in the installation menu.

 6.1. Set up drives and drive groups

Gap Position

Press the button to set the movement position for the opening when a rain alarm triggers. The function is only active if the gap ventilation is switched on.

With the arrow keys, specify the movement position in % (0% = closed, 100% = fully open). Default setting: 5%.

Confirm your setting with the **OK** button.

Automatic Reset

Press the button to enable or disable the switchover to automatic mode at a set point in time, or following a manual intervention.

The general Automatic Reset occurs daily at the same time.

Switching on: To set the window to Automatic at a set point in time, select **Yes** (this is the default setting).

Switching off: To switch off the window's Reset function, select **No**.

Alternatively, the automatic function can be reactivated at a set time following a manual intervention.

Switching on: To perform an Automatic Reset after a manual intervention, select **Yes**.

Switching off: To switch off the window's Reset function, select **No** (this is the default setting).

Confirm your setting with the **OK** button.

Automatic Reset time and/or period can be set.

System > Automatic Settings > General Settings > Automatic Reset

 3.3. Define automatic reset

3.1.7. Automatic ventilation settings

For connected roof ventilation units and supply air units the following automatic settings can be changed:

- Indoor sensor to be used for the ventilation unit
- Indoor temperature
- Air humidity
- Air supply temperature (only for air supply devices)
- Exhaust air levels (only for roof ventilators WL610/WL305)
- Night-time re-cooling (together with indoor temperature for night-time re-cooling)
- Timed ventilation (and levels for timed ventilation)
- Outdoor temperature (only for air supply devices)
- Recirculating air for heat recovery (only roof ventilators WL610/WL305)
- Recirculating air for condensation reduction (only for roof ventilators WL610/WL305)
- Temperature for heating (only for fresh air/heating-combos on RF-VM)
- Enable/Disable automatic reset

In the event of a fire alarm from a smoke detector, ventilation is activated and cannot be influenced by either the automatic or the manual.

As soon as a connected air conditioner is activated, ventilation is disabled, including manually activated fans. The fans can be manually operated again immediately. The delay time for the ventilation block can be adjusted.

System > Automatic Settings > General Settings > Ventilation Block

 3.3. Adjust ventilation block

The automatic ventilation functions can be accessed by pressing the buttons:

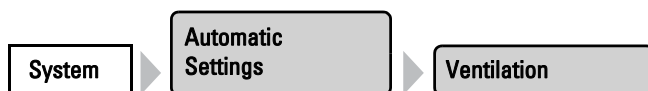

Now you can select individual ventilators and adjust their settings. For each ventilator the following settings can be changed:

Sensor Selection**For all ventilation units.**

Press the button to select the indoor sensor the control system will use for this ventilator (Pre-setting: Internal sensor at WS1, first sensor in the list at WS1000). As long as "**No Sensor**" is selected, the indoor temperature and air humidity will not be taken into account by the control system for this ventilator.

Confirm your setting with the **OK** button.

Indoor Temp**Temp. Ventilation****For all ventilation units.**

Press the button to set the indoor temperature above which the ventilation will be switched on at night. Until an indoor sensor is selected, the indoor temperature will be disregarded.

Setting the temperature: Adjust the value for the desired room temperature using the arrow buttons. Pre-setting: 21.0 °C.

Roof Ventilator WS305/610, ventilation units at RF-VM module: The ventilator is switched step by step, depending on the difference to the target temperature.

Air Supply Unit WFL, ventiaalto at multifunctional output or RF Relay: The ventilation unit is opened as soon as the temperature exceeds the set value. It is closed again as soon as the temperature drops more than 2.0°C below the set value (hysteresis).

Shutting off ventilation: If ventilation is to be independent of indoor temperature, press the button labelled **OFF**.

Confirm your setting with the **OK** button.

Air Humidity**Humidity Ventil.****For all ventilation units.**

Press the button to set the air humidity above which the ventilation will be switched on at night. Until an indoor sensor is selected, the air humidity will be disregarded.

Setting humidity: Adjust the value for the desired humidity using the arrow buttons. Pre-setting: 80%.

Shutting off ventilation: If ventilation is to be independent of air humidity, press the button labelled **OFF**.

Confirm your setting with the **OK** button.

Supply-Air Temp.**Only for WFL
and ventilation units at MF output/RF Relay.**

Press the button to set the supply air temperature block (summer operation). With WFL supply air units, the supply air temperature is recorded by a thermometer integrated into the WFL. With devices from other manufacturers the outdoor temperature at the weather station is used as the supply air temperature.

Enable: If the supply air unit should be closed when the supply air temperature is warmer than the room temperature, select **Yes**.

Disable: If the supply air unit should also then be/remain open when the supply air temperature is warmer than the room temperature, select **No** (default setting).

Confirm your setting with the **OK** button.

Exhaus Air Levels

Ventilation Levels

Only for WL610/WL305 and air supply on RF-VM.

Press the button to set the ventilation levels of the motorised roof ventilators. The further the indoor temperature and air humidity lie above the reference values, the higher the ventilator shifts.

Use the arrow buttons to change the start and maximum values according to your wishes. Default setting: Start with level 1, maximum level 8 (full level utilisation).

Confirm your setting with the **OK** button.

Night-time Cooling

Not on fresh air/heating-combos on RF-VM.

Press the button to set the times for night-time re-cooling. The button is only activated once the general settings for night-time re-cooling have been configured.

- System > Automatic Settings > General Settings > Night-time Cooling
-  3.3. Set night-time re-cooling (ventilation)

Press **Select** to select the time during which the night-time re-cooling will operate. Activate one or more periods on the list.

Confirm your setting with the **OK** button.

To change any of the time periods, press **Timer**.

-  3.3. Set timer

Be careful that your settings for timed closure do not prevent night-time re-cooling operations! A set supply air temperature block can also prevent night-time re-cooling.

NTC Indoor Temp.

Press the button to set the indoor temperature to the desired cooling level (for the night-time re-cooling). The button is only activated once a night-time re-cooling period has been set.

Use the arrow keys to change the value as required. Default setting: 16.0°C.

Confirm your setting by pressing **OK**.

NTC Exhaust Level**Only for exhaust air units.**

Press the button to set the ventilation levels of the motorised roof ventilators for the night-time re-cooling. The button is only activated once a night-time re-cooling period has been set.

Use the arrow buttons to change the level according to your desire. Default setting: Level 3.

Confirm your setting with the **OK** button.

Timed Ventilation**For all ventilation units.**

Press the button to set the timed ventilation. Press Select to select the time during which ventilation will occur. However supply air flaps are only opened if the set outdoor temperature is hit.

Activate one or more periods on the list. Confirm your setting by pressing **OK**.

To change any of the time periods, press **Timer**.

 Set timer, page 59

Ventilation Level**Only for supply air units.**

Press the button to set the ventilation levels of the motorised roof ventilators for the timed ventilation. The button is only active if a ventilation time has been set.

Use the arrow buttons to change the level according to your desire. Default setting: Level 3.

Confirm your setting with the **OK** button.

Outdoor Temp**Only for WFL
and ventilation units at MF output/RF Relay.**

Press the button to set the outdoor temperature above which the supply air unit should remain closed (winter operation). Use the arrow buttons to change the value according to your wish. Default setting: 1.0 °C.

Confirm your setting with the **OK** button.

Heat Recovery**Only for roof ventilators WL610 and WL305.**

Press the button to set the recirculating air function for heat recovery. Recirculation allows heated air from the first area to be distributed in the entire room and so be used for warming if required. In principle, the recirculation function only starts if the temperature at the ventilator is at least 3° warmer than the indoor temperature.

Select **Yes** to activate the heat recovery function (with **No**, the function is switched off). Use the arrow keys that appear to set the indoor temperature beneath which circulation should take place, and the level at which the ventilator should run.

Default setting: Indoor temperature 10.0°C lower; with level 3.

Confirm your setting with the **OK** button.

Condensation

Only for roof ventilators WL610 and WL305.

Press the button to set the recirculating air function for condensation reduction. Recirculation of the air can reduce condensation forming on the window panes.

Select **Yes** to activate the condensation reduction function (with **No**, the function is switched off). Using the arrow keys that appear, set the U-value of the glass used (ask your window manufacturer or conservatory supplier for the value) and the level at which the ventilator should run. Default setting: U-value 1.0; with Level 3.

Confirm your setting with the **OK** button.

Temp. Heating

Only for fresh air/heating-combos on RF-VM.

Press the button to set the indoor temperature above which the circulating air heating will be switched on during the day. Until an indoor sensor is selected, the automatic heating is deactivated. Use the arrow buttons to change the value according to your wish. Default setting: 16.0 °C.

Confirm your setting with the **OK** button.

Night mode

Only for fresh air/heating-combos on RF-VM.

Press the button to set the night-time operation for the circulating air heating. Press **Select** to select the time during which the night mode will operate. Activate one or more periods on the list. The periods can be individually customised (see below).

Confirm your setting with the **OK** button.

To change any of the time periods, press **Timer**.

📖 3.3. Set timer

Indoor Temp. Night

Press the button to set the indoor temperature above which the heating will be switched on at night. The button is only active if a night mode operation period has been set. Use the arrow buttons to change the value according to your wish. Default setting: 9.0°C

Confirm your setting with the **OK** button.

Automatic Reset

For all ventilation units.

Press the button to enable or disable the switchover to automatic mode at a set point in time, or following a manual intervention.

The general Automatic Reset occurs daily at the same time.

Switching on: To set the ventilation unit to Automatic at a set point in time, select **Yes** (this is the default setting).

Switching off: To switch off the ventilation unit's Reset function, select **No**.

Alternatively, the automatic function can be reactivated at a set time following a manual intervention.

Switching on: To perform an Automatic Reset after a manual intervention, select **Yes**.

Switching off: To switch off the ventilation unit's Reset function, select **No** (this is the default setting).

Confirm your setting with the **OK** button.

Automatic Reset time and/or period can be set.

System > Automatic Settings > General Settings > Automatic Reset

 3.3. Define automatic reset

3.1.8. Automatic heating settings

For connected heatings the following automatic settings can be changed:

- Indoor sensor to be used for the heating
- Indoor day temperature
- Night mode (period) and indoor night temperature
- Enable/Disable automatic reset

The automatic heating functions can be accessed by pressing the buttons:



Now you can select individual heatings and adjust their settings. For each heating the following settings can be changed:

Sensor Selection

Press the button to select the indoor sensor the control system will use for this heating (Pre-setting: Internal sensor at WS1, first sensor in the list at WS1000). For as long as "**No sensor**" is selected, the indoor sensor will not be taken into account for control of the heating, i.e. no automatic control will take place.

Confirm your setting with the **OK** button.

Indoor Temp. Day

Press the button to set the indoor temperature above which the heating will be switched on during the day. Until an indoor sensor is selected, the automatic heating is deactivated. Use the arrow buttons to change the value according to your wish. Default setting: 20.0 °C.

Confirm your setting with the **OK** button.

The heating will engage as soon as the temperature drops below the set value and is shut down again when the temperature is more than 0.5°C above the set value (hysteresis).

Night mode

Press the button to set the night-time operation. Press **Select** to select the time during which the night mode will operate. Activate one or more periods on the list. The periods can be individually customised (see below).

Confirm your setting with the **OK** button.

To change any of the time periods, press **Timer**.

 3.3 Set timer

Indoor Temp. Night

Press the button to set the indoor temperature above which the heating will be switched on at night. The button is only active if a night mode operation period has been set. Use the arrow buttons to change the value according to your wish. Default setting: 16.0°C

Confirm your setting with the **OK** button.

The heating will engage as soon as the temperature drops below the set value and is shut down again when the temperature is more than 0.5°C above the set value (hysteresis).

Automatic Reset

Press the button to enable or disable the switchover to automatic mode at a set point in time, or following a manual intervention.

The general Automatic Reset occurs daily at the same time.

Switching on: To set the heating to Automatic at a set point in time, select **Yes** (this is the default setting).

Switching off: To switch off the heating's Reset function, select **No**.

Alternatively, the automatic function can be reactivated at a set time following a manual intervention.

Switching on: To perform an Automatic Reset after a manual intervention, select **Yes**.
Switching off: To switch off the heating's Reset function, select **No** (this is the default setting).

Confirm your setting with the **OK** button.

Automatic Reset time and/or period can be set.

System > Automatic Settings > General Settings > Automatic Reset

 3.3. Define automatic reset

3.1.9. Automatic air-conditioner settings

For connected coolings/air conditioners the following automatic settings can be changed:

- Indoor sensor to be used for the air-conditioner
- Indoor day temperature
- Night mode (period) and indoor night temperature
- Enable/Disable automatic reset

As soon as a cooling/air-conditioning unit is activated, windows will be closed and ventilators switched off. The delay time applicable to this can be set.

System > Automatic Settings > General Settings > Ventilation Block

 3.3. Adjust ventilation block

The automatic climate control functions can be accessed by pressing the buttons:

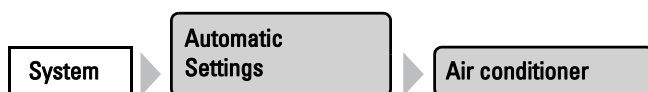

Now you can select individual air conditioners and adjust their settings. For each air conditioner the following settings can be changed:

Sensor Selection

Press the button to select the indoor sensor the control system will use for this cooling unit (Pre-setting: Internal sensor at WS1, first sensor in the list at WS1000). For as long as "**No sensor**" is selected, the indoor sensor will not be taken into account for control of the cooling unit, i.e. no automatic control will take place.

Confirm your setting with the **OK** button.

Indoor Temp. Day

Press the button to set the indoor temperature above which the cooling unit will be switched on during the day. Until an indoor sensor is selected, the automatic cooling is deactivated. Use the arrow buttons to change the value according to your wish. Default setting: 30.0°C

Confirm your setting with the **OK** button.

The cooling will engage as soon as the temperature exceeds the set value and is shut down again when the temperature is more than 2°C below the set value (hysteresis).

Night mode

Press the button to set the night-time operation. Press Select to select the time during which the night mode will operate. Activate one or more periods on the list. The periods can be individually customised (see below).

Confirm your setting with the **OK** button.

To change any of the time periods, press **Timer**.

 3.3. Set timer

Indoor Temp. Night

Press the button to set the indoor temperature above which the cooling will be switched on at night. The button is only active if a night mode operation period has been set. Use the arrow buttons to change the value according to your wish. Default setting: 34.0°C.

Confirm your setting with the **OK** button.

The cooling will engage as soon as the temperature exceeds the set value and is shut down again when the temperature is more than 2°C below the set value (hysteresis).

Automatic Reset

Press the button to enable or disable the switchover to automatic mode at a set point in time, or following a manual intervention.

The general Automatic Reset occurs daily at the same time.

Switching on: To set the air conditioner to Automatic at a set point in time, select **Yes** (this is the default setting).

Switching off: To switch off the air conditioner's Reset function, select **No**.

Alternatively, the automatic function can be reactivated at a set time following a manual intervention.

Switching on: To perform an Automatic Reset after a manual intervention, select **Yes**.
Switching off: To switch off the air conditioner's Reset function, select **No** (this is the default setting).

Confirm your setting with the **OK** button.

Automatic Reset time and/or period can be set.

System > Automatic Settings > General Settings > Automatic Reset

 3.3. Define automatic reset

3.1.10. Automatic light settings

For connected lights the following automatic settings can be changed:

- Time switches
- Twilight operation
- Alarm reaction
- Enable/Disable automatic reset

The automatic lighting functions can be accessed by pressing the buttons:



Now you can select individual lights and adjust their settings. For each light the following settings can be changed:

Time Switch

Press the button to set the time switch. Press **Select** to select the time during which the lights will be turned on. As soon as you activate the twilight setting (see below), the light will only be turned on at twilight in the selected time periods. Activate one or more periods on the list.

Confirm your setting with the **OK** button.

To change any of the time periods, press **Timer**.

 3.3. Set timer

Twilight

Press the button to enable or disable the twilight/night switch. If the twilight setting is active, the light is only turned on at twilight in the time periods selected above. Pre-setting: No (twilight switching off).

Confirm your setting with the **OK** button.

The threshold value, above which twilight/night will be recognised, can be adjusted.

System > Automatic Settings > Twilight

 3.3. Adjust twilight value

Alarm

Press the button to set the alarm response. When an alarm is triggered in a connected motion or smoke detector, the lighting can be switched on automatically.

Enable: If the lighting should be switched on automatically when an alarm is triggered, select **Yes**.

Disable: If the lighting should not be switched on automatically when an alarm is triggered, select **No** (default setting).

Confirm your setting with the **OK** button.

Automatic Reset

Press the button to enable or disable the switchover to automatic mode at a set point in time, or following a manual intervention.

The general Automatic Reset occurs daily at the same time.

Switching on: To set the light to Automatic at a set point in time, select **Yes** (this is the default setting).

Switching off: To switch off the light's Reset function, select **No**.

Alternatively, the automatic function can be reactivated at a set time following a manual intervention.

Switching on: To perform an Automatic Reset after a manual intervention, select **Yes**.

Switching off: To switch off the light's Reset function, select **No** (this is the default setting).

Confirm your setting with the **OK** button.

Automatic Reset time and/or period can be set.

System > Automatic Settings > General Settings > Automatic Reset

 3.3. Define automatic reset

3.1.11. Automatic roof gutter heating settings

For connected roof gutter heatings the following automatic settings can be changed:

- Temperature range within which the heating will be switched on
- Enable/Disable automatic reset

The automatic gutter heating functions can be accessed by pressing the buttons:



Now you can select individual roof gutter heatings and adjust their settings. For each heating the following settings can be changed:

Temperature Range

Use the arrow keys to set the temperature range within which the roof gutter heating will be switched on. If the temperatures are very cold, no condensate forms and the heating can remain switched off. Default setting: 5.0°C to -5.0°C.

Confirm your setting with the **OK** button.

Automatic Reset

Press the button to enable or disable the switchover to automatic mode at a set point in time, or following a manual intervention.

The general Automatic Reset occurs daily at the same time.

Switching on: To set the gutter heating to Automatic at a set point in time, select **Yes** (this is the default setting).

Switching off: To switch off the gutter heating's Reset function, select **No**.

Alternatively, the automatic function can be reactivated at a set time following a manual intervention.

Switching on: To perform an Automatic Reset after a manual intervention, select **Yes**.

Switching off: To switch off the gutter heating's Reset function, select **No** (this is the default setting).

Confirm your setting with the **OK** button.

Automatic Reset time and/or period can be set.

System > Automatic Settings > General Settings > Automatic Reset

3.3. Define automatic reset

3.1.12. Set up alarm

You can select the alarm source which should activate the alarm output relay here. The alarm settings can be accessed by pressing the buttons:



First select the alarm output that you want to set.

Select the alarm source which should activate the alarm output relay. More than one source can also be selected:

- Smoke detector (multifunctional output)
- Motion detector (multifunctional output)
- Rain alarm from weather station
- Wind alarm. Adjust the values for wind speed and duration of the exceedance. A triggered wind alarm will be maintained for 5 minutes. If during these 5 minutes the saved value is exceeded again, the holding time begins again
- Frost alarm of the control

Confirm your setting with the **OK** button.

3.1.13. Setting motion detectors

If a motion-detector is connected, a period of time during which the control system will react to the movements detected can be set (severe alarm). If an alarm is triggered within this time, all windows will close for around 5 minutes. The display (starting position with weather data display) reads "Motion-detector alarm." After 5 minutes without a new alarm signal, normal automatic operation will be resumed.



Even manually opened windows will be closed when there is a motion-detector alarm!

If a multifunctional output is configured as an alarm output, it closes for the duration of the alarm signal.

📖 3.2. Set up alarm

Lights can also be switched on when the alarm is active.

📖 3.2. Automatic light settings

The motion-detector settings can be accessed by pressing the buttons:



First select the motion detector that you want to set. Press **Select** to select the time during which the motion detector alarm should be active. Activate one or more periods on the list. The operating times can be individually customised (see below).

Confirm your setting with the **OK** button.

To change any of the time periods, press **Timer**.

📖 3.3. Set timer

3.2. Adjust general automatic settings

The settings applied here are used for all drives and devices, or are applicable to the drive types defined in the relevant chapter (e.g. for all shades).

3.2.1. Adjust twilight value

You can adjust the threshold value above which twilight/night will be recognised. Note that on moonlit nights, brightness values short below 10 lux can be achieved. If the twilight value is set below 10 lux, shades which are set to “close at night” will remain open because of the moonlight or retract during the night.

The twilight settings can be accessed by pressing the buttons:



Use the arrow keys to set the value above which twilight or night will be recognised by the control unit. Default setting: 10 Lux.

Confirm your setting with the **OK** button.

3.2.2. Adjust movement delays (shading elements)

You can adjust the delay time for shades. The movement delay prevents sun shades from being constantly extended and retracted when there are rapidly changing light conditions.

For the shade to extend, the brightness must lie above the set light intensity value uninterruptedly for the set extension delay time (e.g. 1 minute). For the shade to retract again, the light intensity for the set retraction delay time must lie below the value without interruption for the set retraction delay time (e.g. 12 minutes). Clever selection of the delay time “masks out” passing clouds and nonetheless permits the shade to react quickly to the sun.

The movement delay settings can be accessed by pressing the buttons:



Use the arrow keys to set the values for the extension and retraction delays.

Default setting: Extension 1 minute, retraction 12 minutes.

Confirm your setting with the **OK** button.

3.2.3. Set timer

Sixteen periods can be set in the week-long timer, which can be used for different automation functions. A start and end point, as well as a day of the week must be set for each time period.

The timer settings can be accessed by pressing the buttons:

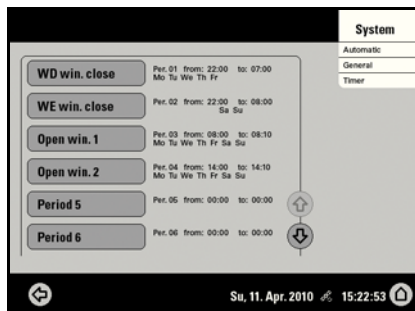

In the illustration, the times for mandatory closing and opening the windows on weekdays and weekends have already been set.

Select the time period that you want to change. The following settings of each time period can be changed:

Name of the time period:

Period 1

Press the button to change this name. Input the desired name on the on-screen keyboard which appears.

 2.4. Input keyboard for names and codes

Start / end:

Set the start and end of the time period by selecting each hour and minute field consecutively and setting the time using the arrow keys.

Weekdays:

Select the day of the week on which the time period should be activated. More than one day can also be selected.

Confirm your setting with the **OK** button.

3.2.4. Adjust ventilation block

As soon as a cooling/air-conditioning unit is activated, windows will be closed and ventilators switched off. If the cooling is switched off again, the ventilation will stay off

for a while, to prevent the cooled air to be discharged immediately through windows or ventilation units. You can adjust the delay time for this.

The ventilation block is also initiated by devices that are connected to the multifunction input as climate signallers.

The ventilation block settings can be accessed by pressing the buttons:

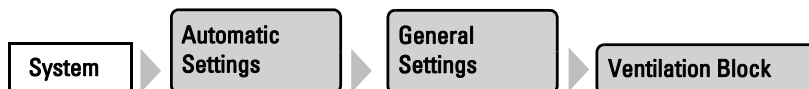

Use the arrow keys to set how many minutes ventilation via windows or ventilators should remain blocked after an air-conditioning device is switched off.

Default setting: 120 minutes.

Confirm your setting with the **OK** button.

3.2.5. Set night-time re-cooling (ventilation)

The night-time re-cooling function using the windows and ventilation equipment is activated once a set outdoor temperature is exceeded for an extended period of time.

The weather data display (Start screen) then shows “Night-time re-cooling” next to the outdoor temperature value. The display can also show “Frost alarm” and “Window movement limitation” in turn.

 2.1. Weather data display (start screen)

The window(s) and ventilator(s) which are used for night-time re-cooling as well as the time period over which these are activated can be set in the automatic operation functions for the individual windows and ventilators.

The night-time re-cooling settings can be accessed by pressing the buttons:

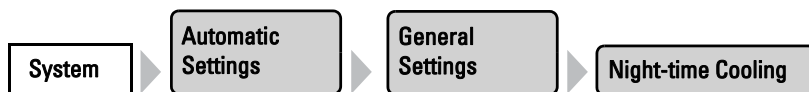

Using the arrow keys, set the outdoor temperature at which the night-time re-cooling shall be active (e. g. higher than 20°C). Remember that the night-time re-cooling only starts when the outdoor temperature is more than 2.0°C above the pre-set value. The night-time re-cooling is de-activated again as soon as the outdoor temperature drops below the pre-set value.

Also set the period for which the outdoor temperature must have been above the minimum temperature (e. g. longer than 48 hours).

Confirm your setting with the **OK** button.

Night-time re-cooling will stop when the set outdoor temperature is undercut by 2°C for a specified period of time. This period depends on the set trigger period and on how

long this temperature has been exceeded. It is a maximum of one third of the set trigger period (e.g. max. 12 hours for a 48-hour trigger period).

3.2.6. Adjust frost alarm

The frost alarm for shades and windows will be active when during or after precipitation the outdoor temperature falls below a defined level.

The weather data display (Start screen) then shows "Frost alarm" next to the outdoor temperature value. The display can also show "Night-time re-cooling" and "Window movement limitation" in turn.

📖 2.1. Weather data display (start screen)

You adjust which shades will be retracted and which windows will be closed in the automatic functions for the individual shades and windows.

The following situations trigger the frost alarm:

- The outdoor temperature is below the set frost alarm temperature and it starts to rain/snow.
- The outdoor temperature falls below the set frost alarm temperature while it is raining/snowing.
- Rain/snow has stopped. The outdoor temperature falls below the set frost alarm temperature within the set standby period after the end of precipitation.

The following situation stops the frost alarm:

- The outdoor temperature stays above the set unfreezing temperature for the set time period.

Setting of the frost alarm:

You can reach the frost alarm settings by pressing the buttons:

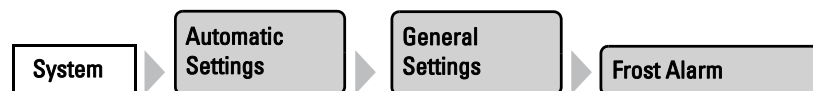

First set when the frost alarm should be triggered. Use the arrow keys to adjust the outdoor temperature that must be undercut to trigger the frost alarm (e.g. 2.0°C).

Then set how many hours after precipitation the standby for the frost alarm should be active (e.g. 5 hrs). Choose the standby period so that all humidity of the previous precipitation has dried.

Then set the conditions for the end of the frost alarm. Set the outdoor temperature to be exceeded (e.g. 5.0°C) and the duration for which it should be exceeded (e.g. 5 hrs). Choose the time period so that ice is completely melted thereafter.

The **Off** button lets you deactivate the frost alarm for all shades and windows.

Confirm your setting with the **OK** button.

3.2.7. Set movement limitations (window)

A movement limitation ensures that a window remains only open a portion at low outdoor temperatures. This prevents the room from cooling too rapidly.

The weather data display (Start screen) then shows “Window movement limitation” next to the outdoor temperature value. The display can also show “Night-time re-cooling” and “Frost alarm” in turn.

📖 2.1. Weather data display (start screen)

You can set the degree to which the opening is restricted for individual windows in the automatic functions.

You can reach the movement limitation settings by pressing the buttons:



First define the outdoor temperature below which the window movement range becomes limited (e.g. 2.0°C).

You can then set how long the outdoor temperature must remain above the set limit value, so that the movement limitation is cancelled again (e.g. 8 hours).

The **Off** button lets you deactivate the movement limitation for all windows.

Confirm your setting with the **OK** button.

3.2.8. Setting a wind delay (shades)

When the wind limitation value is exceeded for a drive, the wind alarm is then triggered for 5 minutes. If the wind value is once again exceeded within this period, the 5-minute stop time restarts from scratch.

For shades, a delay time can also be set following the wind alarm, during which the shade automation is blocked. This means that if the shade is in automatic mode before a wind alarm, the automatic setting remains switched off after the wind alarm. Further manual operation is however possible again.

You can reach the wind delay time settings by pressing the buttons:



Set the duration of the shade block after a wind alarm using the arrow keys (0-360 minutes, default setting: 0 minutes).

Confirm your setting with the **OK** button.

3.2.9. Define automatic reset

Following a manual intervention, the affected drive or unit remains in manual mode, and automatic operations are switched off. Once the general Automatic Function time point is reached, drives and units are once again set to Automatic. Alternatively, the automatic function can be set to reactivate following a manual intervention. The period for this can be set.

The Automatic Reset prevents drives from being manually operated and then stay in an unfavourable position (leaving windows accidentally open, or blinds retracted despite the sunlight).

The general Automatic Reset and reset following a manual intervention can be separately activated and de-activated in the Automatic functions menu for each drive group and each unit.

The Automatic Reset function settings can be accessed by pressing the buttons:



General Automatic Reset

Set the time point by selecting the hour and accordingly the minute fields and setting the time using the arrow buttons. Default setting: 3:00 AM.

Automatic reset following a manual intervention

Use the arrow keys to set the time interval after which Automatic functions should be once again activated. Default setting: 60 minutes.

Confirm your setting with the **OK** button.

4. Installation

4.1. Procedure



Installation, inspection, commissioning and troubleshooting must only be carried out by a competent electrician.

To install the control unit, proceed as follows:

1. Installation
2. Commissioning
3. Basic settings in the menu **System > Installation** (with selection of the time zone in the **System > WS1 / WS1000 Settings** menu).
4. Automatic settings in the menu **System > Automatic Settings**.

This chapter describes the installation. Read through the notes and instructions for the individual components carefully. First of all fit all components and connect the cables to the control unit, drives and devices. Then check all components and continue with the commissioning.

4.1.1. Installation notes



Installation, testing, operational start-up and troubleshooting should only be performed by an electrician.



DANGER!

Risk to life from live voltage (mains voltage)!

There are unprotected live components within the device.

- VDE regulations and national regulations are to be followed.
- Ensure that all lines to be assembled are free of voltage and take precautions against accidental switching on.
- Do not use the device if it is damaged.
- Take the device or system out of service and secure it against unintentional use, if it can be assumed, that risk-free operation is no longer guaranteed.

The device is only to be used for its intended purpose. Any improper modification or failure to follow the operating instructions voids any and all warranty and guarantee claims.

After unpacking the device, check it immediately for possible mechanical damage. If it has been damaged in transport, inform the supplier immediately.

The device may only be used as a fixed-site installation; that means only when assembled and after conclusion of all installation and operational start-up tasks and only in the surroundings designated for it.

Elsner Elektronik is not liable for any changes in norms and standards which may occur after publication of these operating instructions.

4.1.2. Notes on wireless equipment

When planning facilities with devices that communicate via radio, adequate radio reception must be guaranteed. The range of wireless control will be limited by legal regulation and structural circumstances. Avoid sources of interference and obstacles between receiver and transmitter, that could disturb the wireless communication. Those would be for example:

- Walls and ceilings (especially concrete and solar protection glazing).
- Metal surfaces next to the wireless participants (e. g. aluminium construction of a conservatory).
- Other wireless devices and powerful local transmitters (e.g. wireless headphones), which transmit on the same frequency (868,2 MHz). Please maintain a minimum distance of 30 cm between wireless transmitters for that reason.

The transmission performance and reception sensitivity can be improved by means of an external antenna. During installation, a conduit should be placed beneath the recessed housing, in which the external antenna can be mounted.

4.1.3. Safety notice for automatic and alarm functions



WARNING!

Risk of injury due to automatically moved components!

The automatic control may cause parts of the system to travel and pose a danger to humans.

- No persons may remain in the travelling range of parts driven by an electric motor.
- Adhere to the relevant building regulations (see guideline for power-operated windows, doors and gates BGR 232 et al).
- Always disconnect the system from the mains power before maintenance or cleaning (e.g. switch off/remove fuse).

Precipitation warning for automatically controlled windows:

Some time can pass before falling rain is recognised by the sensors in the system, depending on the rain amount and outdoor temperature. Furthermore, a closure time must be calculated for electrically-actuated windows or sliding roofs. Humidity-sensitive items should therefore not be placed in an area where they might be damaged by incoming precipitation. Please also bear in mind that in the event of a power failure and rainfall, a window will not be automatically closed if no emergency generator is installed.

Running rails of shades icing up:

Note that the rails of shutters, awnings and blind which are externally mounted can ice up. Operating the drive under such conditions can damage the shades and drives.

Power failure, maintenance works, etc. (restart of control)

If a power outage occurs, the control unit can no longer control the connected drives! If the functional scope must be guaranteed even during a power cut, an emergency power unit with a corresponding switch from network power to emergency operation should be installed by the customer.

Settings saved in the control unit programme will be maintained even during a power outage.

Note: After every re-start (e. g. return of voltage after mains failure or manual reset) all drives and devices with active automatic reset are in automatic mode.

If cleaning or maintenance work is to be carried out in the conservatory/building, the control unit should be de-energised and secure against restart by disconnection of the customer-installed fuse. This ensures that the connected drives cannot start.

4.2. Installation of the P04i-GPS Weather Station

The **P04i-GPS weather station** for WS1 and WS1000 Color/Style measures temperature, wind speed and brightness. It recognises precipitation and receives the GPS signal for time and location (international time signal and position).

4.2.1. Installing the weather station

Installation location

Select an installation position on the building where the sensors can measure wind, rain and sunshine without hindrance. No structural elements should be mounted above the weather station from which water could continue to drop on the precipitation sensor even after it has stopped raining or snowing. The weather station should not be shaded by structures or, for example, trees.

At least 60 cm of clearance must be left around the device. This facilitates correct wind speed measurement without eddies. At the same time, this prevents spray (raindrops hitting the device) or snow (snow penetration) from impairing the measurement. This also prevents birds from biting it.

Please ensure that the extended awning does not cast shade on the unit, protects it against the wind.

Temperature measurements can also be distorted by external influences such as warming or cooling of the building structure on which the sensor is mounted (sunlight, heating or cold water pipes).

Magnetic fields, transmitters and interference fields from electrical consumers (e.g. fluorescent lamps, neon signs, switch mode power supplies etc.) can block or interfere with the reception of the GPS signal.

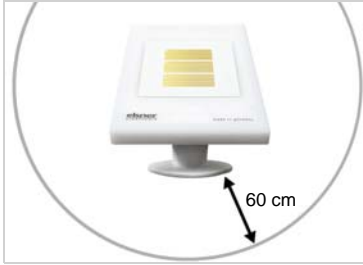

Fig. 1
There must be at least 60 cm clearance to other elements (structures, construction parts, etc.) below, to the sides and in front of the weather station.

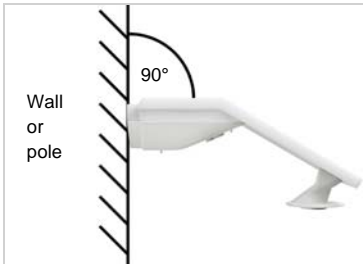

Fig. 2
The device must be attached to a vertical wall (or a pole).



Fig. 3
The device must be mounted in the cross direction, i.e. in horizontal (transverse) direction.

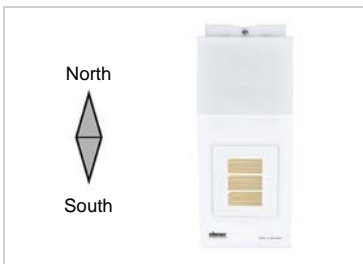

Fig. 4
For installation in the northern hemisphere, the device must be aligned to face south.

For installation in the southern hemisphere, the device must be aligned to face north.

Device design

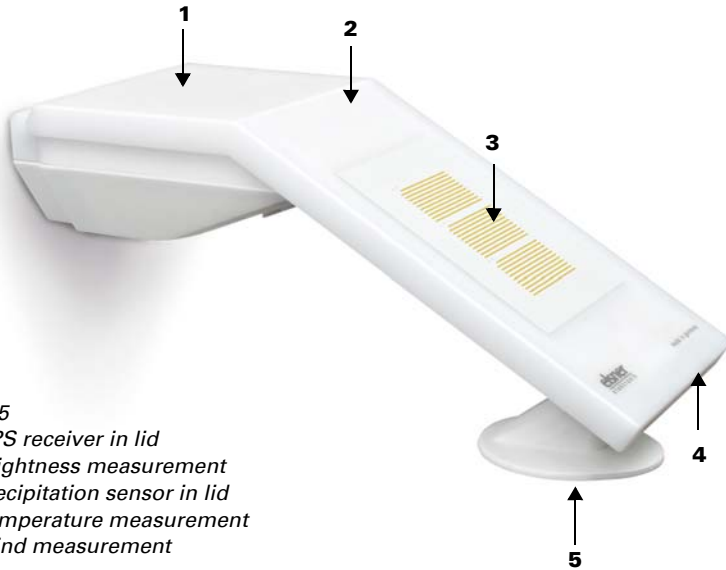

Fig. 5

- 1 GPS receiver in lid
- 2 Brightness measurement
- 3 Precipitation sensor in lid
- 4 Temperature measurement
- 5 Wind measurement



ATTENTION!

Sensitive wind sensor.

- Remove the protective transport sticker after installation.
- Do not touch the sensor on the wind measuring element (no. 5).



ATTENTION!

Even a few drops of water can damage the device electronics.

- Do not open the device if water (e.g. rain) can get into it.

Preparation for installation



Fig. 6

Slacken both screws on the lid (top) and lower part (bottom) with a Phillips screwdriver.



Fig. 7
 Pull the lid and lower part completely apart. This also releases the plug-in connection between the board in the lid and the socket in the lower part.

Fitting the lower part with mounting

Now, first of all, assemble the lower part of the housing with the integrated mounting for wall or pole installation.

Wall installation

Use fixing materials (dowels, screws) that are suitable for the base.

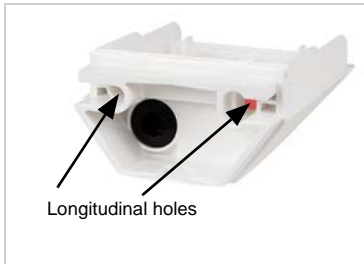

Fig. 8
 The device is installed with two screws. Break off the two longitudinal holes in the lower part of the housing.

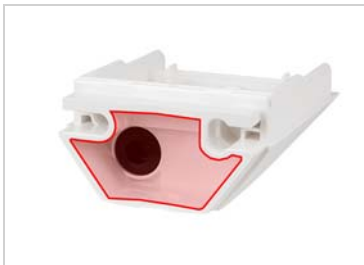
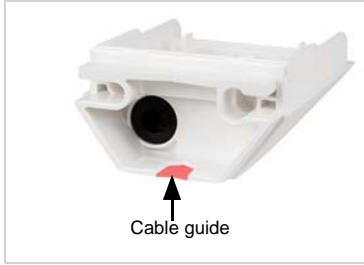

Fig. 9 a+b
 a) If the power lead is to be hidden when installed, it must emerge from the wall in the vicinity of the rear of the housing (marked area).



b) If the power lead is to be surface-mounted, the cable guide is broken off. The lead is then fed into the device at the underside of the housing.

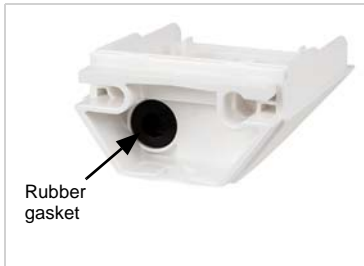

Fig. 10
Feed the power lead through the rubber gasket.

Drilling plan

ATTENTION! The printout of the data sheet does not have original size! A separate, dimensionally correct drilling plan is included ex works and this can be used as a template.

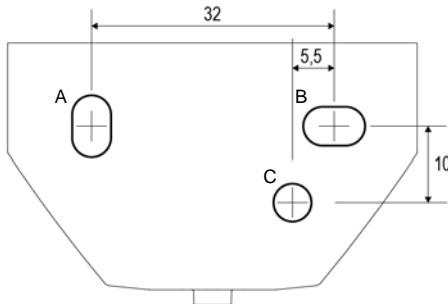

Fig. 11
Dimensions in mm. Variations are possible for technical reasons

A/B 2x longitudinal holes 8 mm x 5.5 mm

C Position of the cable outlet (rubber gasket) in the housing

Pole installation

The device is installed on the pole with the enclosed stainless steel mounting band.



Fig. 12

Feed the mounting band through the eyelets in the lower part of the housing.

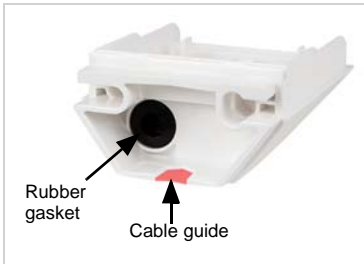

Fig. 13

Break the cable guide off.

Feed the power lead through the rubber gasket.

Connection

The connector is in the lower part of the housing.

The feed to the weather station must be a maximum of 100 m long. The connection is made with off-the-shelf UV-resistant telephone cable (A-2Y(L)2Y 2x2x0.6 or A-2Y(L)2Y 2x2x0.8).



Fig. 14
Connect the controller/voltage (+24 V DC/GND) to the terminals 1/2 P04i-GPS.

The terminal assignment is polarity-independent

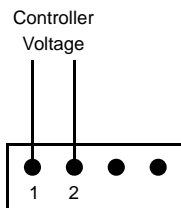

Closing the installation



Fig. 15
Push the lid on the lower part. This also makes the plug-in connection between the board in the lid and the socket in the lower part.



Fig. 16
Screw the lid (top) and lower part (bottom) together.

4.2.2. Notes on mounting and commissioning

Remove all existing protection labels after installation.

The correct wind value may only be supplied about 30 seconds after the supply voltage has been connected.

4.2.3. Maintenance of the weather station



WARNING!

Risk of injury caused by components moved automatically!

The automatic control can start system components and place people in danger (e.g. moving windows/awnings if a rain/wind alarm has been triggered while cleaning).

- Always isolate the device from the mains for servicing and cleaning.

The device must regularly be checked for dirt twice a year and cleaned if necessary. In case of severe dirt, the sensor may not work properly anymore.



ATTENTION

The device can be damaged if water penetrates the housing.

- Do not clean with high pressure cleaners or steam jets.

4.3. Installation of a WGTH-UP Indoor Sensor

The WS1 Color control system has an indoor sensor integrated into the central unit. Further external sensors can additionally be installed. The WS1000 Color control system comes with an indoor sensor WGTH-UP included in the delivery.

The WGTH-UP Indoor Sensor transfers temperature and humidity to the control system via radio. Several separate WGTH-UP can be taught to one control system. The teaching is described in the chapter "Learn wireless connections" (manual of the control system).

The WGTH-UP Indoor Sensor consists of the housing, the sensor PCB/base plate and a frame. As an alternative to the supplied frame, a frame of the switch series used in the building may be used. You will additionally require a junction box (Ø 60 mm, 42 mm deep, not included in scope of delivery).

For power supply (7...30 V DC), e. g. 12 V DC can be tapped from the connection board of the control unit (multifunctional input).

4.3.1. Installation of the indoor sensor

Installation location

The interior sensor is to be installed flush to the wall surface in a junction box (\varnothing 60 mm, 42 mm deep). The ideal installation height is approx. 1.40 m above the ground. When selecting an installation location, please ensure that the measurement results are affected as little as possible by external influences. Possible sources of interference include:

- Direct sunlight
- Drafts from windows and doors
- Draft from ducts which lead from other rooms to the junction box in which the sensor is mounted.
- Waste heat from the control unit (when mounted above the display)
- Warming or cooling of the building structure on which the sensor is mounted, e.g. due to sunlight, heating or cold water pipes
- Connection lines which lead from warmer or colder areas to the sensor

Temperature variations from such sources of interference must be corrected in the control unit menu in order to ensure the specified accuracy of the sensor (see manual chapter on Wireless connections > Status).



The indoor sensor must only be installed and used in dry, interior spaces. Avoid condensation.

Layout

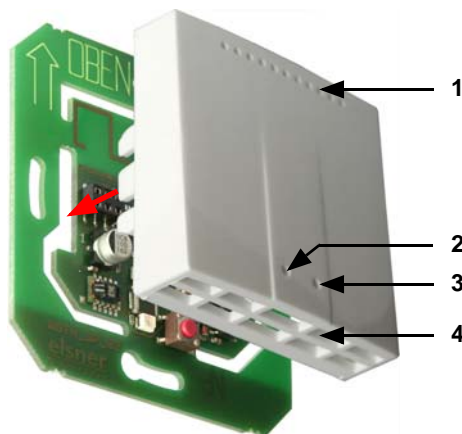

Fig. 17

- 1 Openings for air circulation
- 2 Opening programming LED
- 4 Opening programming button for configuring the device
- 5 Openings for air circulation (BOTTOM)

Rear view

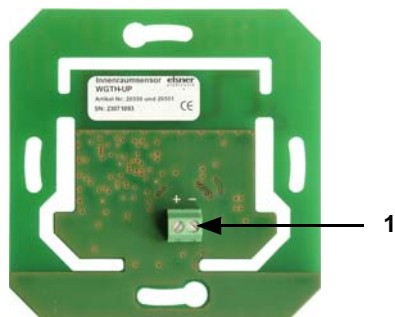

Fig. 18

- 1 Connection for power supply
7...30 V DC (+/-)

Installation

First install the junction box. Seal the inlet tubes in order to prevent drafts.

Connect the power supply +/- to the connector terminals provided for this purpose on the sensor board. Then screw the board/base plate onto the socket. Ensure that the front side with the writing „TOP“ is directing out of the wall and that the arrows point towards the top.

Position the frame of the switching programme. Insert the housing of the sensor firmly onto the base plate using the catches, so that the housing and frame are fixed together.

4.3.2. Notes on mounting and commissioning

Never expose the device to water (e.g. rain) or dust. This can damage the electronics. You must not exceed a relative humidity of 95%. Avoid condensation.

4.3.3. Establish radio connection with WGT14-UP

1. Bring the control unit into learning readiness mode (note chapter *Learn wireless connection* in the manual).
2. Press the programming button at the WGT14-UP sensor



The programming button is situated behind the right lower opening of the housing. Use e. g. a paper-clip or a wire to press the button.

3. Pay attention to the report of the control unit ("Device successfully learnt").

4.4. Installation of the control unit

4.4.1. Installation of the control unit WS1000 Color



Warning, mains voltage! National legal regulations are to be observed. Installation, inspection, commissioning and troubleshooting of the device must only be carried out by a competent electrician.

Preparing the installation location



The device must only be installed and used in dry, interior spaces. Avoid condensation.

Cut-out dimensions for concealed box (approx.): W=229 mm | H=163 mm | D=62 mm:

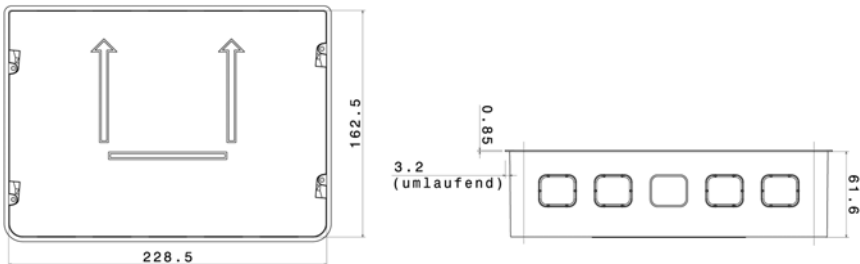

An external antenna can be connected in order to improve wireless communications. During installation, a **conduit 50 cm in length** should be placed beneath the recessed housing, in which the external antenna can be mounted (antenna dimensions approx. 565 x 8 x 5, L x W x H in mm):

*Conduit angled diagonally downwards
(for cable access from above or below)*

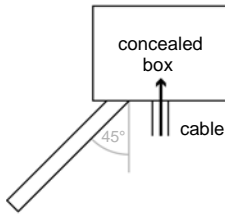

M16 conduit, 50 cm in length

*Conduit angled vertically downwards
(only for cable access from above!)*

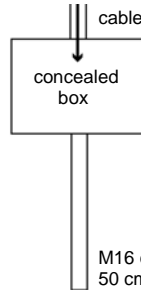

M16 conduit,
50 cm in length

Preparing for installation



To take off the front plate, remove the screws beneath the lid.

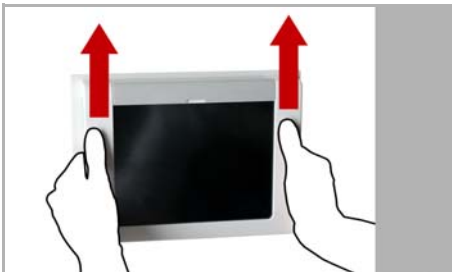

Push the upper section of the housing (frame with display) up a little and lift it off.

Caution: The display is connected with a flat-ribbon cable to the circuit board in the concealed box. Loosen the plug so that the upper section can be removed.

The lid cover is only attached by a hinge. Take care not to lose it.

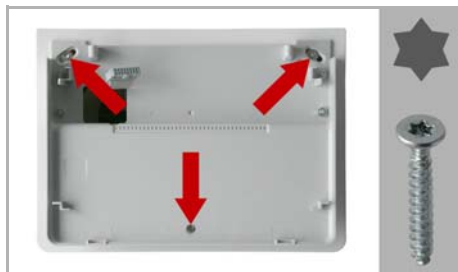

The lower section of the housing together with the wall-mounting plate is attached to the concealed box with 3 screws: Loosen the screws and take off the lower part.

Wall-fitting



Remove the circuit board from the concealed box to be installed keep it in a place where it is protected from dirt. **It may never be exposed to dust or moisture!**



For fitting, screw the cover (board) on to the concealed box with the enclosed screws.

Cavity wall fitting



Clamp the concealed box to the wall with the four enclosed screws.

Upon delivery, the pouch containing the assembly screws can be found in the control unit's flush-mounted casing.

Assembling the control unit with concealed box

During electrical installation, please introduce all connection cables into the concealed box through the lower or upper side wall. In the process, keep the individual connection wires short to prevent long reserve loops.

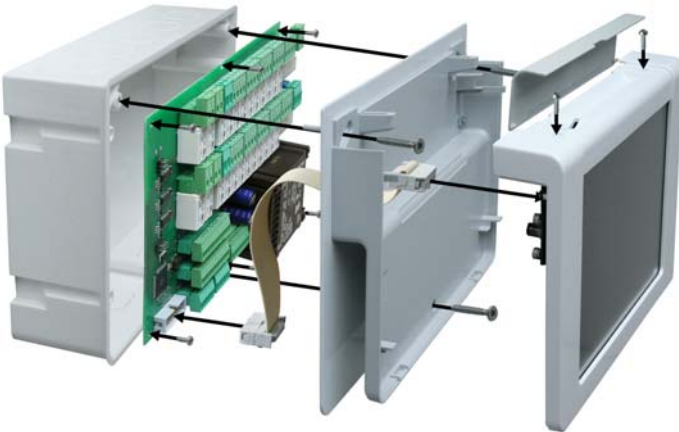

After connecting the cables screw the lower section of the housing (with the mounting plate) onto the concealed box. Connect the flat ribbon cable to the display.

Put the lid cover on the upper section of the housing (frame with display). Put the upper section of the housing onto the lower section of the housing from above and move it downwards until the bottom edges are aligned. Screw on the upper section.

Structure of the connector board WS1000 Color

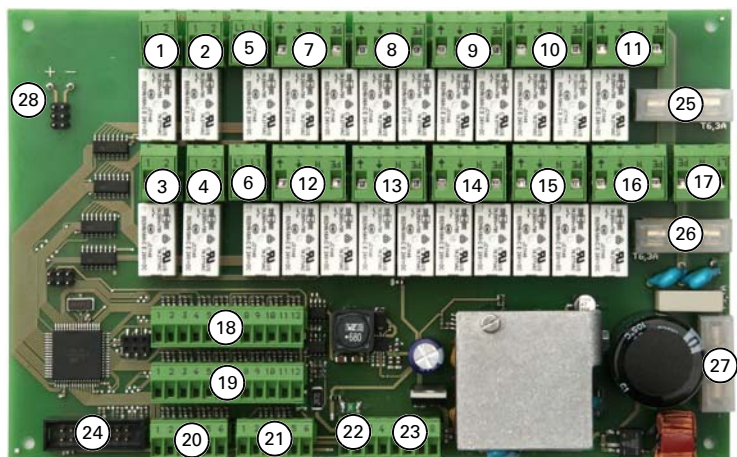

- | | |
|---|---|
| 1 Multifunctional output 1 (potential-free) | 19 Wall button 5 (terminals 1-3) |
| 2 Multifunctional output 2 (pot.-free) | Wall button 6 (terminals 4-6) |
| 3 Multifunctional output 3 (pot.-free) | Wall button 7 (terminals 7-9) |
| 4 Multifunctional output 4 (pot.-free) | Wall button 8 (terminals 10-12), |
| 5 Outer conductor L1 | 20 Wall button 9 (terminals 1-3) |
| 6 Outer conductor L1 | Wall button 10 (terminals 4-6), |
| 7 Drive group 1 | 21* Multifunctional input 1 (terminals 1-3) |
| 8 Drive group 2 | Multifunctional input 2 (terminals 4-6) |
| 9 Drive group 3 | 22 Weather station (terminals 1-2) |
| 10 Drive group 4 | 23* Multifunctional input 3 (terminals 3-5) |
| 11 Drive group 5 | Multifunctional input 4 (terminals 6-8) |
| 12 Drive group 6 | 24 Connector for flat-ribbon cable to front board |
| 13 Drive group 7 | 25 Microfuse T6.3 A (Drive 1-5) |
| 14 Drive group 8 | 26 Microfuse T6.3 A (Drive 6-10) |
| 15 Drive group 9 | 27 Microfuse T630 mA |
| 16 Drive group 10 | 28 Slot KNX interface |
| 17 Mains connection L/N/PE 230 V/50 Hz | * Supply voltage indoor sensor (or e. g. cameras) possible via MF inputs (No. 21, terminals 1(+), 2(-) 4(+), 5(-) and No. 23, term. 3(+), 4(-) 6(+), 7(-)), max. 400 mA altogether. |
| 18 Wall button 1 (terminals 1-3) | |
| Wall button 2 (terminals 4-6) | |
| Wall button 3 (terminals 7-9) | |
| Wall button 4 (terminals 10-12) | |

Connection diagram

Drive and MF outputs WS1000:

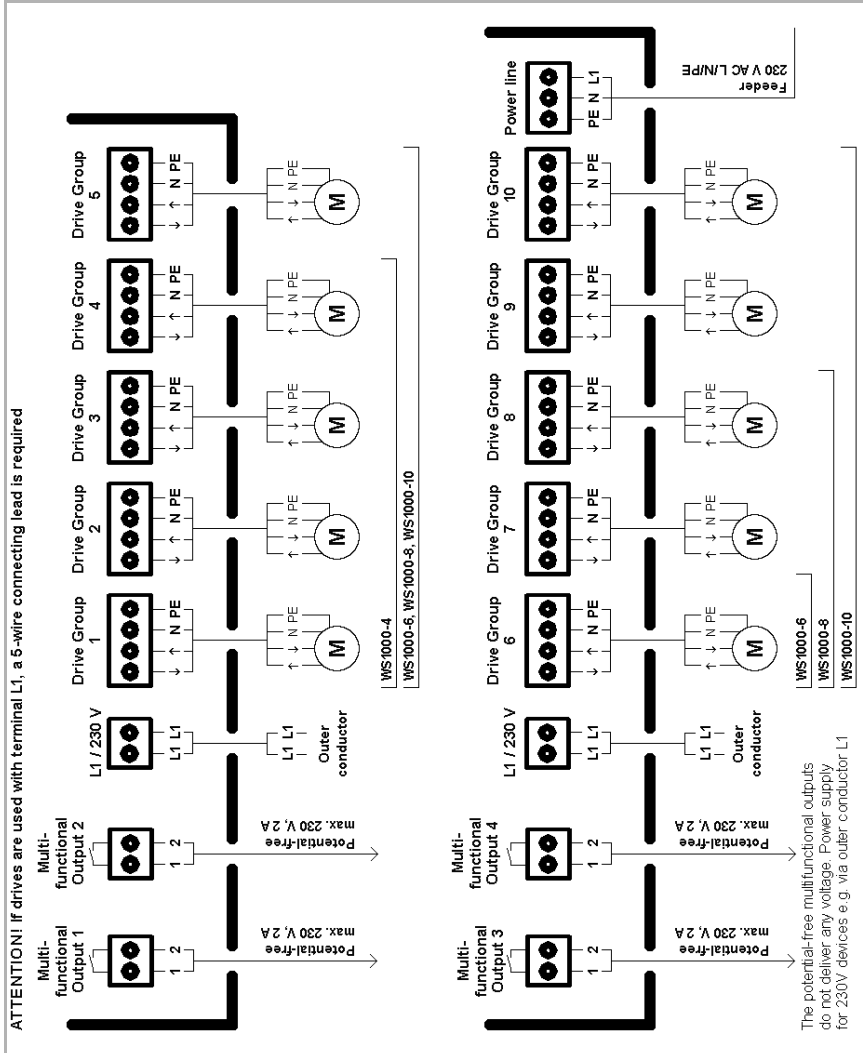

Inputs WS1000:

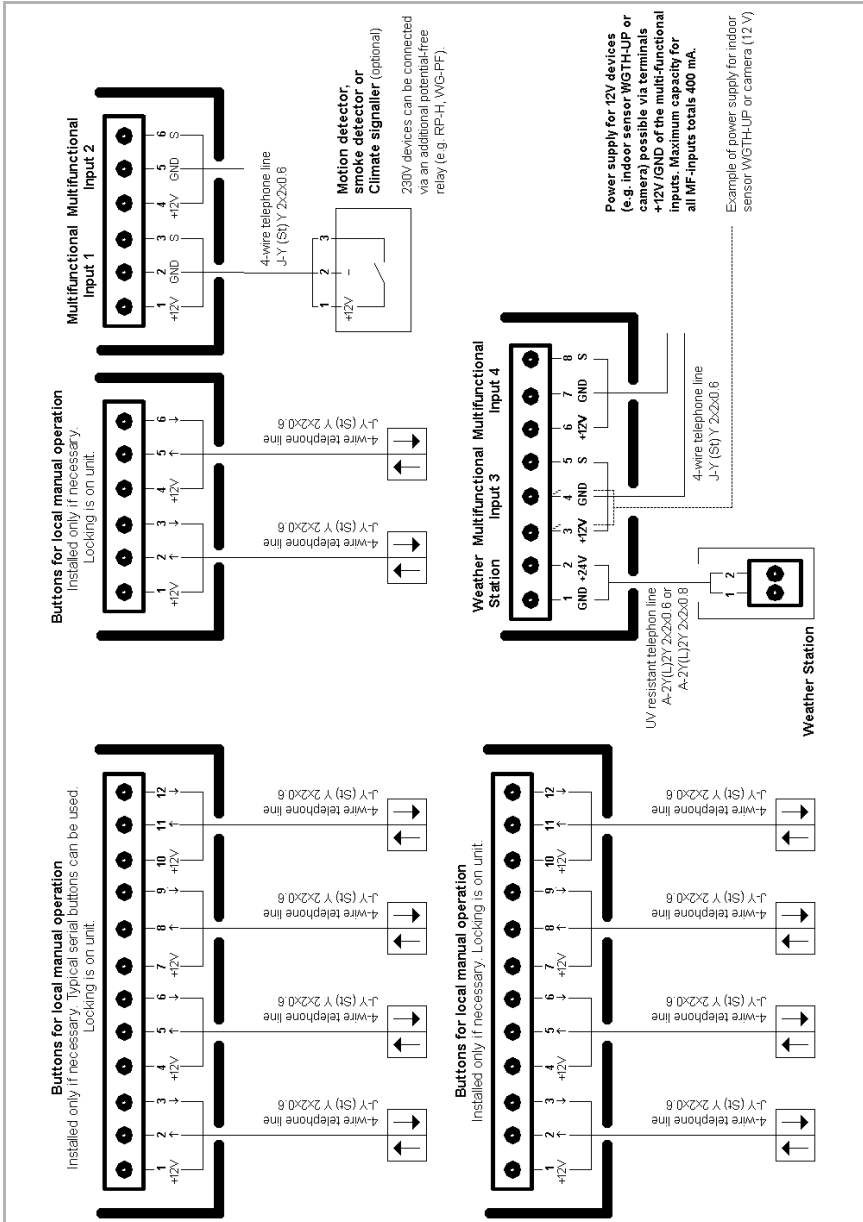

Installation of the control unit WS1 Color



Warning, mains voltage! National legal regulations are to be observed. Installation, inspection, commissioning and troubleshooting of the device must only be carried out by a competent electrician.

Preparing the installation location



The device must only be installed and used in dry, interior spaces. Avoid condensation.

The device is to be installed flush to the wall surface. When selecting an installation location, please ensure that the measurement results of the integrated temperature/humidity sensor are affected as little as possible by external influences. Possible sources of interference include:

- Direct sunlight
- Drafts from windows and doors
- Draft from ducts which lead from other rooms to the concealed box
- Warming or cooling of the building structure on which the device is mounted, e.g. due to sunlight, heating or cold water pipes
- Connection lines which lead from warmer or colder areas to the device

*External dimensions
of concealed box
in mm:*

(depth approx. 62 mm)

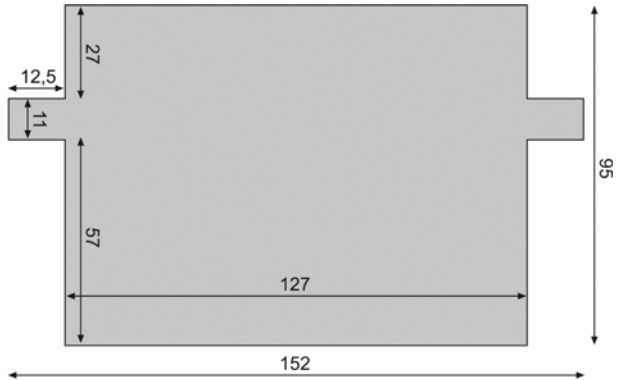

An external antenna can be connected in order to improve wireless communications. During installation, a **conduit 50 cm in length** should be placed beneath the recessed housing, in which the external antenna can be mounted (antenna dimensions approx. 565 x 8 x 5, L x W x H in mm):

*Conduit angled diagonally downwards
(for cable access from above or below)*

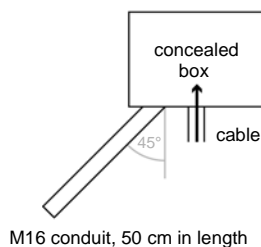

*Conduit angled vertically downwards
(only for cable access from above!)*

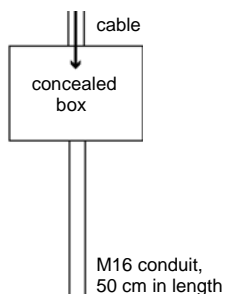

Preparing for installation

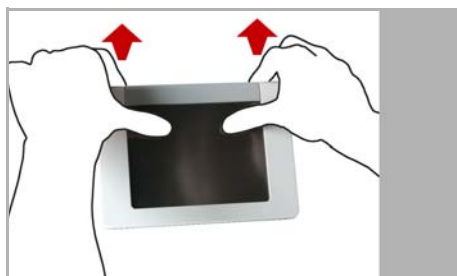

Loosen the frame on the upper corners by pulling it forward. You can press your thumbs on the screen while doing this.



Take the frame off at the top first, then at the bottom.

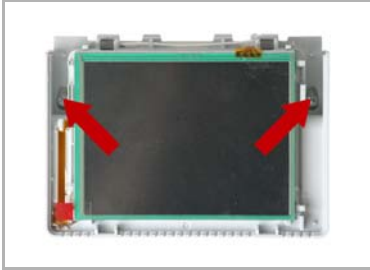

The lower portion of the housing is mounted on the flush mounting box with 2 screws: loosen the screws.

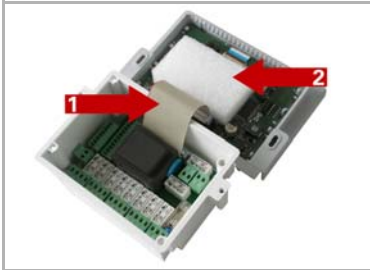

Take off the housing component with the screen board. The screen is connected via a ribbon cable (1) with the board in the flush mounting box. Loosen the plug in order to be able to remove the upper part.

Remove the transport lock (2).

Wall-fitting



Remove the circuit board from the concealed box to be installed a keep it in a place where it is protected from dirt. **It may never be exposed to dust or moisture!**



For fitting, screw the cover (board) on to the concealed box with the enclosed screws.

Cavity wall fitting



Clamp the concealed box to the wall with the four enclosed screws.

Upon delivery, the pouch containing the assembly screws can be found in the control unit's flush-mounted casing.

Assembling the control unit with concealed box

During electrical installation, please introduce all connection cables into the concealed box through the lower or upper side wall. In the process, keep the individual connection wires short to prevent long reserve loops.



After wiring, connect the ribbon cable to the screen board. Make sure that the transport lock (foam) is removed and also remove the foil protecting the screen (red flap). Screw the lower part of the housing onto the flush mounting box. Set the frame on the lower part of the housing. To this end, the frame is first suspended below and then clapped shut above and snapped in place.

Structure of the connector board WS1 Color

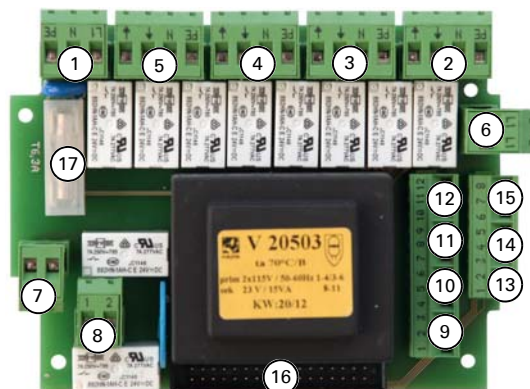

- | | |
|---|--|
| 1 Mains connection L/N/PE 230 V/50 Hz | 12 Wall button 4 (10:+12V 11:Up 12:Down) |
| 2 Drive group 1 | 13 Weather station (terminals 1-2) |
| 3 Drive group 2 | 14* Multifunctional input 1 |
| 4 Drive group 3 | (terminal 3: +12 V 4: GND 5: IN) |
| 5 Drive group 4 | 15* MF input 2 (6: +12 V 7: GND 8: IN) |
| 6 Outer conductor L1 | 16 Connector for flat-ribbon cable to front board |
| 7 Multifunctional output 1 (potential-free) | 17 Microfuse T6,3 A |
| 8 MF output 2 (potential-free) | * Supply voltage e. g. indoor sensor possible via MF inputs |
| 9 Wall button 1 (terminal 1: +12 V 2: Up 3: Down) | (No. 14, terminal 3(+), 4(-) and No. 15, terminal 6(+), 7(-), max. 50 mA altogether. |
| 10 Wall button 2 (4: +12 V 5: Up 6: Down) | |
| 11 Wall button 3 (7: +12 V 8: Up 9: Down) | |

Connection diagrams

Drive and MF outputs WS1:

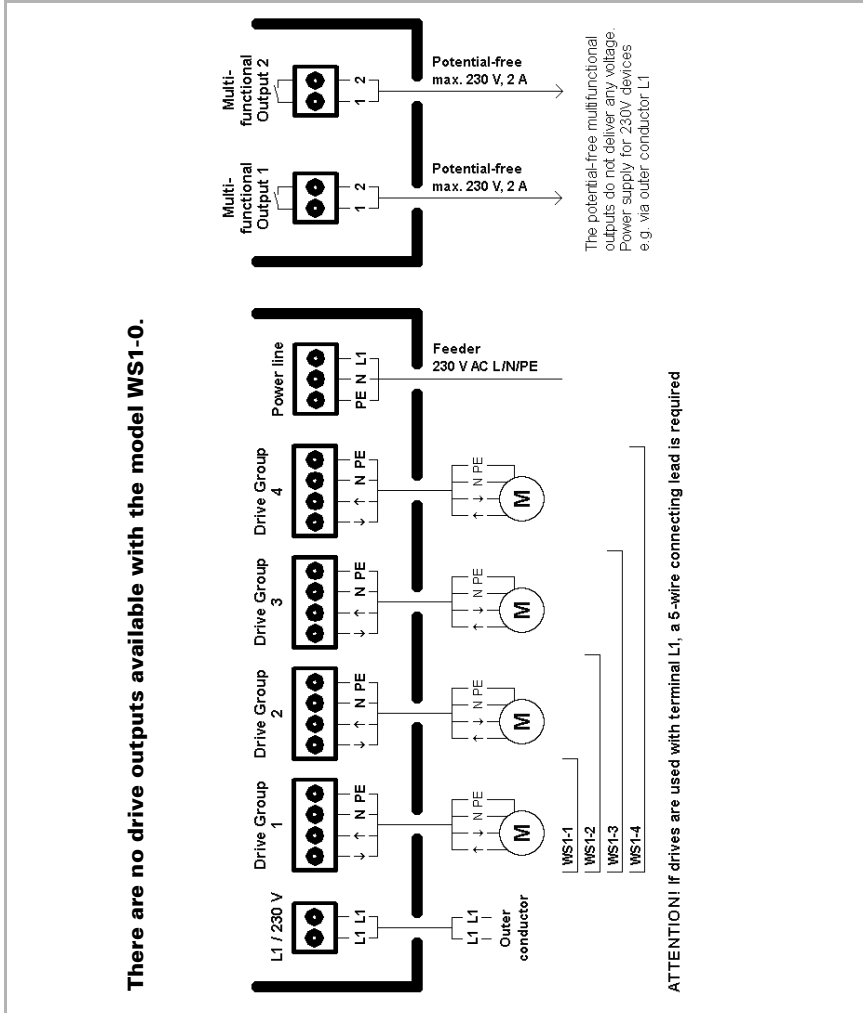

Inputs WS1:

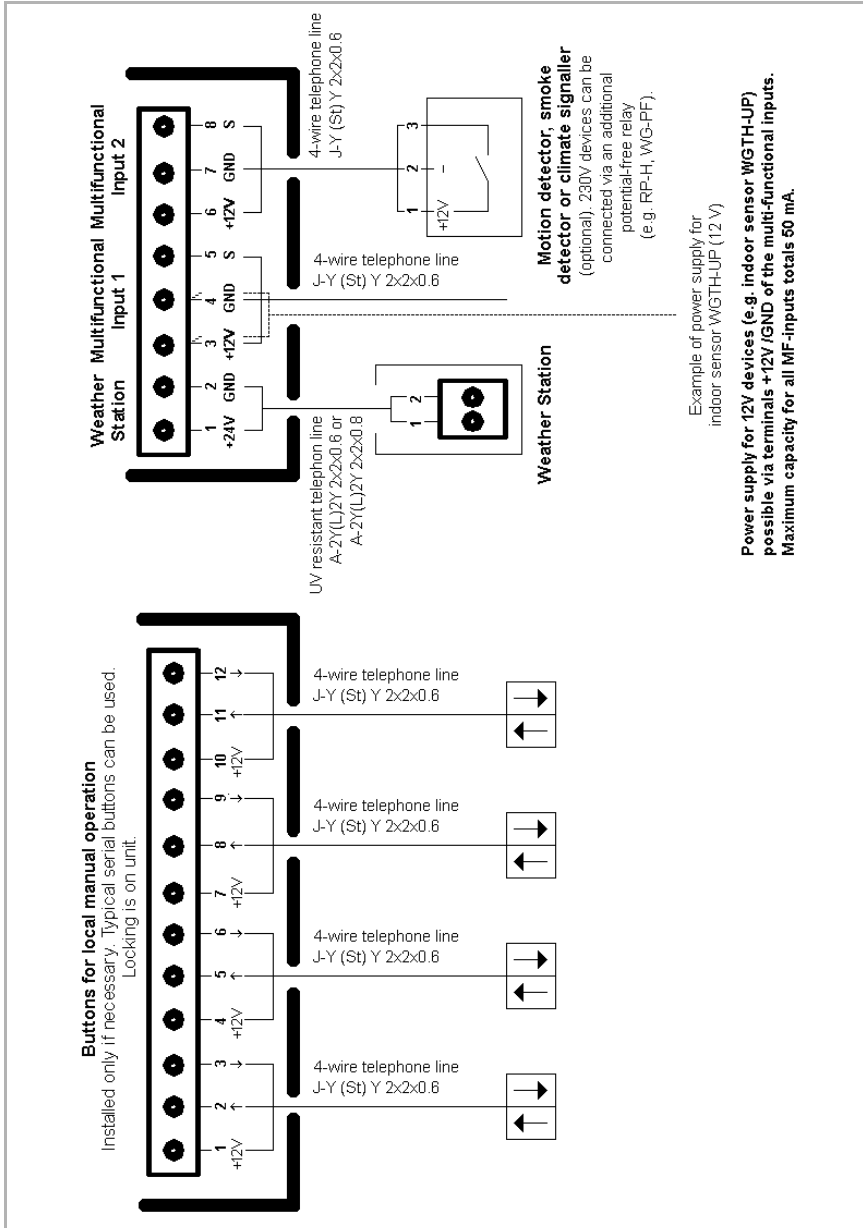

4.4.2. Connect drives and devices

Connect drive groups

Each drive that must be controlled individually requires a group of its own. It is not possible to individually control drives that are connected in a group. Only drives with the same function (only windows, only awnings, only blinds, only shutters) can be brought together in groups.

Shades with different orientations (east, south, west) should be placed in different groups. Only in this way can the shades be controlled appropriately according to the position of the sun.

Drives can be kept in secure position by using safety contacts (multifunctional inputs). Take note that a safety contact is *not* capable of preventing collisions (e.g. if an awning is installed over a window).

The device works with 230 V alternating voltage 50 Hz. The input power is dependent on the number and power of the connected motors.

Each drive outlet must have a maximum 400-watt load. The total installed input must not however exceed approx. 1.5 kW. The output voltage is 230 V AC.

When motors are connected in parallel, take note of whether a group control relay is prescribed by the manufacturer. Group control relays can be obtained from Elsner Elektronik or the motor manufacturer.

Various drives for blinds and awnings, in particular, can for the most part only be operated via a group control relay on an output channel.



If motors are connected in parallel which are unsuitable for this purpose, both they and the control unit will be damaged.

Motors with a higher power input than 400 Watt are to be operated via a relay or control gate with its own power cable.

For D.C. drives we offer appropriate power supply units. In case of need we ask for details of the motor type, the manufacturer and – if available – the technical data.

Connect devices to the multifunctional outputs

Heatings, air-conditioners, lights, ventilation devices, roof gutter heatings, dimmers or alarm devices (e.g. alarm equipment in combination with a motion detector in a multifunctional input) can be connected to the multifunctional outputs.

The multifunctional outputs have a potential-free make contact which can be loaded with 230 V AC/2 A.

Connect devices to the multifunctional inputs

Devices with potential-free contacts can be connected to the multifunctional inputs. These can be alarm-reporting devices, such as motion-detectors or smoke detectors (with relay output) or another device with a potential-free contact, which is then crucial for the alarm function.



A smoke alarm at the multi-functional input does not fulfil the requirements for a smoke alarm system.

A heating or cooling plant operated independently of the control system can be connected to a multifunction input using its potential-free contact. Through the closed relay, the device signals the control that it is currently heating or cooling and the control activates the ventilation block.

A closed contact on the multifunction input can be used to test if a sliding door is closed.

An impulse transmitter for the automatic reset can also be connected here, e.g. a sensor device or an alarm unit (impulse when activating).

4.4.3. Connecting drives and devices wirelessly

Connecting drives and devices wirelessly is achieved by means of an Elsner wireless modules (RF relay, RR-MSG). Elsner Elektronik ventilation devices can be learned into the control system without any additional equipment. Please observe the installation instructions relating to the wireless relays, motor control devices and ventilation devices.

6.1. Wireless connections

5. Commissioning

5.1. Procedure



Installation, testing, commissioning and fault repair should only be carried out by a qualified electrician.

To install the control unit, proceed as follows:

- Installation
- Commissioning
- Basic setting in the menu **System > Installation**
- Automatic settings in the menu System > Automatic Settings

This chapter describes the **commissioning** of the device. Prior to commissioning all components must be installed (fitted and with their cables connected). Read through the notes and instructions carefully.

5.1.1. Start control unit



Condensation water can occur if a device is taken from a cold into a warm room. Before the commissioning of the control take care that there is no humidity inside the device (let dry if necessary).

After installation, connecting cables to the unit and checking all connections, switch the power supply on.



The control unit starts and in the display the model and serial number appear initially. Then the following will be shown

- “Read drive parameter OK”
(or if there is an error: “Error initialising drive parameter with factory settings.”)
- “Wireless interface”
(or if there is an error: “Wireless interface error”)
- “Wireless channel initialised OK”
(or if there is an error: “Wireless channel initialisation error”)

After successfully running through the initial test sequence, the control unit will be in the starting position with a display of weather data. Weather data is displayed if the control system is receiving data (brightness, sun direction and height, precipitation, wind, temperature, and indoor room data). The weather animation is only shown when there no error messages are displayed.

The time is automatically displayed when the unit receives time /date information, otherwise, the time can be set manually. Also a time zone (if there is a GPS weather station

on the control system) and location (if there is a DCF77 weather station on the control system) must be set.

- System > WS1/1000 Settings > Settings > Time and Date
-  6.2. Enter time and date manually
- System > WS1/1000 Settings > Settings > Time Zone
-  6.2. Select time zone
- System > WS1/1000 Settings > Settings > Location
-  6.2. Enter location

5.1.2. Check sensor functions



On the display the current values for sun, wind and outdoor temperature are shown. First check the sensor functions.

Light intensity (sun sensor)

The sunlight sensor is beneath the weather station lid. If there is not enough brightness at the moment, light up the weather station with a powerful table lamp until a value is shown.

Direction and height (sun)

The direction and height of the sun is calculated by the control unit based on the date/ time and location. The time is set upon receipt of a time signal from the unit itself (can take up to 10 minutes). If no signal is available, the time can be set manually. If a weather station with GPS receiver is connected to the control system, the time zone must be selected from the menu. With a DCF77 receiver, the geographical location of the building must be input.

- System > WS1/1000 Settings > Settings > Time and Date
-  6.2. Enter time and date manually
- System > WS1/1000 Settings > Settings > Location
-  6.2. Enter location (only DCF weather stations)

Precipitation (Precipitation sensor)

Precipitation is shown with the “Rain” or “Snow” animation in the display. Moisten the golden sensor surface on the weather station lid (often the moisture from the surface of the skin when touching is enough). The “Precipitation” animation should then begin.

Please take note that after the sensors dry out, the precipitation warning remains for a further 5 minutes.

Wind speed (wind sensor)

If the sensor tube on the underside of the weather station is blown into, the corresponding wind speed in metres per second appears in the display alongside the animated windsock.

Temperature

The outdoor temperature is shown next to the symbol "thermometer next to house". If reasonable values are shown, correct functioning can be assumed.

If there is an indoor sensor (internal sensor of WS1 Color or external wireless sensor WGTH-UP), the values are shown next to the symbol "thermometer inside house". RH specifies the relative humidity. Normal values are approx. 25% RH to 65% RH in living rooms. After installation it may be a few hours before the hygrometer shows normal values.

6. Basic Setting

6.1. The “Installation” menu

In the menu area **System > Installation** you can adjust the following settings:

- Specify fundamental characteristics of the drives and devices at the inputs/ outputs
- Set up wireless connections to devices
- Configure internal thermo-/hygrometer (WS1 Color only)
- Define the order in which the drives and devices will be shown (e.g. in the manual menu)

For this the following sub-menus are used:

- Drive (with the option settings type, name, movement time, direction of rotation, manual direction, MSG control, canvas tightening, slat turning, close-contact)
- External button (with the option settings type, direction, name and drive group assignment)
- Internal button (with the option settings type, name and drive group assignment)
- Multifunctional output (with the option settings type and name)
- Multifunctional input (with the option settings type and name)
- Wireless connection
- Weather display (selection of indoor sensor for weather data display)
- KNX settings (only if a KNX interface is installed)
- Camera (only if a camera interface is installed)
- WS1 TH (settings for the internal temperature/humidity sensor of WS1 Color)
- Channel order

In order to be able to carry out the basic setting, the control unit must have been professionally installed and commissioned.

📖 4. Installation and 5. Commissioning

6.1.1. Set up drives and drive groups

The WS1 Color-0 model offers no drive outputs. The “Drive” key is grey. In this case, drives can still be controlled via radio motor control units (see 6.1. *Wireless connections*).

Windows, awnings and blinds are controlled in various ways. For example, windows are opened or closed according to the temperature or air humidity, but blinds are opened or closed according to the light or time. For this reason it is imperative that, when started up, the control unit be adjusted accordingly.

The basic settings for the drives can be accessed by pressing the buttons:



Now you can select individual drives (or drive groups) from the list and adjust their settings. So long as no settings were completed yet, the buttons show **(Drive 1)**, **(Drive 2)** etc. If an output was already configured, the name of the drive will be displayed instead.

Press the button of the drive to be set. For each drive the following settings can be changed:

Drive type

Reserve

Press the Reserve button. The possible drive types appear (awning, window, step window, sliding roof, blinds, shutters, sliding door). Select as appropriate. If the connection is not being used for the moment, leave **"Reserve"**.

Confirm your selection with the **OK** button.

With the buttons **A** and **B** you can test the motor function. Please also determine the **movement times** to complete opening/extension or closing/retraction (stop watch). Also determine the time for reversing of the slats for blinds, that means the time it takes to reverse completely from closed position to the other end point. You need these values for the setting "movement times" (see below).



ATTENTION

Rain and wind alarms are deactivated while this menu item is shown!

Name

Name 1

Press the button to change the name (by default its name is the selected drive type). Enter the desired name via the keypad that appears.

 2.4. Input keyboard for names and codes

Confirm your input with the **OK** button.

Movement times

Extension time:	240,00
Retraction time:	240,00
Reversal time:	2,70
Time zero position:	0,00
Dead time:	0,00

Press the buttons with the number values and enter the timed values (in seconds, see top “Drive type”). If applicable, the movement time to zero position and the dead time can be set. A keypad for setting appears. Confirm with the **OK** button.

The **movement time to zero position** defines how far the drive is extended after retraction (zero position). This helps e. g. to release the cable of blinds (value e. g. 0.1 s). The **dead time** defines how long it takes until an electronic drive starts moving after the control relay has been closed. The setting of the dead time allows for a precise positioning of the drive, e. g. for slat tracking according to the solar position. Please follow the advice of the drive manufacturer.

Settings

Different option settings appear here depending on the drive type:

Dir. of Rotation

Press the button to check the motor’s direction of rotation. A selection menu appears. Test the response of the drive when pressing the **A/B** buttons. Then select the applicable button **Retract with A** (or **Close with A**) or **Retract with B** (or **Close with B**).

Confirm your selection with the **OK** button.



ATTENTION

Rain and wind alarms are deactivated while this menu item is shown!

Manual Direction

Press the button to adjust the assignment of arrow keys (Up/Down, Open/Closed). A selection menu appears. Choose whether the drive should **retract** (or **open**) or **extend** (or **close**) when the button is pressed.

Confirm your selection with the **OK** button.

MSG Control

Press the button if the output shall be used as the central command for motor control devices.

Select **Yes** to drive motor control devices (e.g. IMSG 230) using the drive output. The relay stays closed permanently during a rain or wind alarm.

If a single drive or a group of drives is connected on the drive output, leave the default settings **No**.

Confirm your selection with the **OK** button.

Please note that for windows where MSG control is selected, the "Gap ventilation during rain" function is not possible.

📖 3.2. Automatic window settings

Canvas Tightening

Press the button to select the canvas tightening for awnings. Only select **Yes** (tighten canvas after reaching the movement position), if the installed awning is suitable. The drive time for canvas tightening is 1 second.

Confirm your selection with the **OK** button.

Slat Turning

Press the button to adjust the slat turning for blinds. Turning the slats is for example recommended with shutters which are installed between glass panes. Slats in this instance can get caught together when moving the curtains. Turning the slats sorts them and sets them to the neutral position.

Never turn: Setting for most indoor and outdoor shutters.

Turn when shading: The slats are only turned during automatic shading.

Turn after every movement: The slats are turned during automatic shading, during night-time and timed closure and during manual closure without stopping (end position).

The slats are normally only turned after extending the blind. They are *not* turned at a manually reached intermediate position (stop pressed).

Confirm your selection with the **OK** button.

Safety Contact

Press the button in order to assign a drive to a safety contact. The contacts are connected to the MF inputs. If the safety contact is opened, then the drive will advance to the safe position (window closes, shade retracts) and manual operation is blocked.

Select the button of the appropriate contact. Confirm your selection with the **OK** button.

Closed Detector

Press the button in the basic settings to assign an installed door contact to a sliding door. Select the button of the appropriate contact.

Confirm your selection with the **OK** button.

Manual Menu

Press the button to set whether the drive should be displayed in the manual menu or not.

Confirm your selection with the **OK** button.

Tips on connecting windows

With windows the supply of fresh air can be very well regulated using the Step window configuration. In this, the control unit checks the room temperature every 3 minutes. If the temperature is close to the reference value, the window will be opened or closed step by step. You can adjust the number of steps in the Automatic menu ("Number of steps" button).

For sliding roofs, during normal operation of ventilators, it is not necessary to use the full stroke. For that reason you can adjust the size of the opening in the Automatic menu ("Movement position" button). If the sliding roof should be opened fully, this can take place manually.



ATTENTION

Material damage due to use of step/sliding roof operation with inappropriate window motors!

Not all window motors are suitable for step/sliding mode.

- Use this functions only with motors that are qualified for step/sliding operation by the manufacturer.

6.1.2. Assign external buttons

If external buttons for operating drives and devices on the spot are installed, their settings and assignments can be made here.

Single buttons (toggle buttons) can be installed and allocated the function **Button**. Equipment such as heating, cooling, ventilation, lighting and/or gutter heating are thereby switched on and off alternately.

To be able to control a dimmer, the single button must be allocated the function of the **↕ Button**.

Double buttons (unlocked serial buttons) are allocated the function of the **↑↓ Button**. If, in these settings, the button is allocated the shading and/or window functions, then the button has its own internal timer, i.e. a short pressing of the button works according to the "dead man's principle": if pressed for longer (> 1 second), the drive travels up to the end position (self-stop mode).

If such a double button is allocated a switchable device (lighting, heating, etc.), then the Up button switches on and the Down button off.

The external button settings can be accessed by pressing the buttons:



You can now select individual buttons from the list and adjust their settings. So long as no settings have been completed yet, the buttons will show **(Ext. Button 1)**, **(Ext. Button 2)** etc. If a button was already configured, the name or function will appear instead. Press the key of the button to be set.

For each external button the following settings can be changed:

Input type

Reserve

Press the **Reserve** button. A selection menu appears. Select **↑↓ Button** (if a double push button is connected) or **Button** (if a single push button is connected) or leave **"Reserve"**, if the button input is not being used for the moment.

Confirm your selection with the **OK** button.

Button direction

Settings

Press Settings to adjust the direction of an up/down button. No button direction is needed for single buttons.

The directional test menu appears. Press the button's up and down keys. This activates the arrows in the display. If the direction of the button matches the display, leave the setting at **Normal**. Otherwise press the button **Invert**. Now button and display should match.

Confirm your setting with the **OK** button.

Name



Press the button to change the name. Enter the desired name via the keypad that appears.

2.4. Input keyboard for names and codes

Confirm your input with the **OK** button.

Drive groups



Press the button to assign the external buttons to drive groups or devices. All connected drives and devices appear. You can select several buttons.

Confirm your selection with the **OK** button.

6.1.3. Assign internal buttons (group buttons)

Several drives or devices can be operated at the same time in the Manual menu via a collective group button (internal software button). Ten internal buttons are available.

The internal group button settings can be accessed by pressing the buttons:



You can now select individual buttons from the list and adjust their settings. So long as no settings have been completed yet, the buttons will show **(Int. Button 1)**, **(Int. Button 2)** etc. If a button was already configured, the name or function will appear instead.

Press the key of the button to be set. For each internal button the following settings can be changed:

Button type

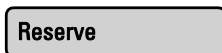

Press the **Reserve** button. A selection menu appears. Select **Int. Button** or leave "Reserve" if the button is not being used for the moment.

Confirm your selection with the **OK** button.

Name

Group Button 1

Press the button to change the name. Enter the desired name via the keypad that appears.

 2.4. Input keyboard for names and codes

Confirm your input with the **OK** button.

Drive groups

Assign

Press the button to assign the internal buttons to drive groups or devices. All connected drives and devices appear. You can select several buttons. Confirm your selection with the **OK** button.



Only drives/devices with the same functions should be operated together with a single button (e.g. only blinds or only windows).

6.1.4. Set up multifunctional outputs

To the multifunctional outputs you can connect:

- heatings
- air conditioners
- ventilation units
- lights
- roof gutter heatings
- alarm equipment
- dimmers

Specify here which devices are connected to the individual outputs. The settings for the multifunctional outputs can be accessed by pressing the buttons:



You can now select individual outputs from the list and adjust their settings. So long as no settings were completed yet, the buttons show (MF Output 1), (MF-Output 2) etc. If an output was already configured, the function and/or name will be displayed instead.

Press the button of the output to be set. For each multifunctional output the following settings can be changed:

Output type

Reserve

Press the **Reserve** button. The possible output types appear (heating, air-conditioner, ventilator, light, roof gutter heating, alarm, dimmer). Select as appropriate. You can test the relay function with the **Close** button. If a multifunctional output is not being used for the moment, leave "Reserve."

Confirm your selection with the **OK** button.

Name

Name 1

Press the button to change the name. Enter the desired name via the keypad that appears.

 2.4. Input keyboard for names and codes

Confirm your input with the **OK** button.

6.1.5. Set up multifunctionals inputs

To the multifunctional inputs you can connect:

- alarm signal (motion or smoke detectors)
- climate indicators (e.g. a climate/heating unit that is independent of the control)
- safty contacts
- close-contacts (for sliding doors)
- impulse for automatic reset
- signal for activation of the camera picture (binary input)

Specify here which devices are connected to the individual inputs.

When a **motion-detector alarm** is triggered and a sensor signal recognised, all windows connected to the control unit will be closed. After 5 minutes without a new sensor signal the control unit switches back to normal operation.

 7.3. Messages in the weather data display

The **fire alarm** activates various safety measures: awnings, blinds and shutters retract in order to clear an escape route, the light comes on, heatings and air-conditioning units switch off, windows and ventilators are opened or switched on. While the fire alarm is triggered an acoustic warning signal sounds at the control unit. The fire alarm can only be switched off by a Reset/Restart of the control system through the **System > WS1 / WS1000 Settings > Service > Reset menu** or by cutting off the power supply.

 7.3. Messages in the weather data display

A **heating or climate unit** (climate detector) that works independent of the control unit can be connected to a multifunctional input with its potential-free relay contact. The device signals the control via the closed relay contact that it is heating or cooling. The control then closes all windows and switches off the ventilators. If the device opens the relay contact again, the control will hold the windows closed for a variable time and leave the ventilators switched off.

📖 3.3. Adjust ventilation block

A **safety contact** can be connected to the multifunctional inputs which will then be assigned to a drive output. If the safety contact is opened, then the drive will advance to the safe position (window closes, shade retracts) and manual operation is blocked. This can ensure that the blind on a terrace door can't descend if the door is open. Take note that a safety contact is not capable of preventing collisions (e.g. if an awning is installed over a window).

A **closed contact** can be used on a multi-function input in order to determine if a sliding door is completely closed.

The multifunctional inputs may be used as the trigger for **automatic reset**. The input impulse may come e.g. following the pressing of a button or alarm activation.

If cameras are connected to the control system, the setting **Binary Input** can be used to activate the image display. For example, the signal can be connected to a bell on a multifunctional input and this can be configured as a binary input. Then the image of a camera can be shown in the screen as soon as the bell is rung.

The settings for the multifunctional inputs can be accessed by pressing the buttons:



You can now select individual inputs from the List and adjust their settings. So long as no settings were completed yet, the buttons show **(MF Input 1)**, **(MF Input 2)** etc. If an output was already configured, the function and/or name will be displayed instead.

Press the button of the input to be set. For each multifunctional input the following settings can be changed:

Input type



Press the **Reserve** button. The possible input types appear (motion detector, smoke detector, climate detector, closed detector, automatic reset, binary input). Select as appropriate. If a multifunctional input is not being used for the moment, leave "Reserve".

Confirm your selection with the **OK** button.

Name

Name 1

Press the button to change the name. Enter the desired name via the keypad that appears.

 2.4. Input keyboard for names and codes

Confirm your input with the **OK** button.

Status of input

It displays whether the relay is currently open or closed.

6.1.6. Wireless connections

Devices that communicate wirelessly with the control unit must first be learned by the control unit.

When learning wireless connections, always comply with the data sheet of the relevant wireless device. The instructions for learning WGTH-UP indoor sensors can be found in the Chapter *Setting up a wireless connection using WGTH-UP*.



WARNING! **Electric voltage!**

Some devices have programming keys for learning the radio connection inside their housings, and thus beneath unprotected live parts.

- This devices should only be learned by a trained electrician (according to VDE).

This menu allows you to learn, control and delete radio connections. Press the buttons:



Learn wireless connection

Learn

Press **Learn** to bring the control unit into learning readiness mode. Then follow the instructions for the respective wireless participant (press PROG key or switch power supply on).

For wireless components that are learned by switching on power, you can switch on the supply for all devices at the same time. The components learn themselves one after the other automatically. For wireless components that are learned by pressing the PRG button, please repeat the learning procedure with all of them.

As soon as the wireless connection has been established, the control unit reports "Device successfully learnt" and beeps. Press ← to go back to the menu.

Status

Status

Press **Status** to see which connections already exist.

WGTH

Remo 8

RF Relay

WL305/610

WFL

RF MSG

You can now select, monitor and adjust the settings for the individual wireless participants. If no adjustments have been made, the names of the wireless components are the same as the names of the devices. Later the names given are shown on the buttons.

Different operational data will be shown for the devices:



WGTH-UP an WG AQS/TH indoor sensor

Radio module type	"WGTH" display
Name	To change the name, press the button showing device identification. Enter the required name in the box which appears. Confirm your entry using the OK key.  2.4. Input keyboard for names and codes
Radio status	Radio status display
WGTH status	Display of serial number and version
Measured values	Display of current values. To adjust the sensor, press the Adjust button. Adjust the value for "Displayed temperature/humidity". A correction of measured values may be needed when the temperature/air humidity on the sensor does not correspond to the room average (e.g. when the sensor has been installed in a place with above-average temperatures) Confirm your entry using the OK key.
Settings	Press the Manual Menu button to set if the indoor sensor shall be displayed in the manual menu. Confirm your choice using the OK key.

WGT temperature sensor:

Radio module type	“WGT” display
Name	To change the name, press the button showing device identification. Enter the required name in the box which appears. Confirm your entry using the OK key.  2.4. Input keyboard for names and codes
Radio status	Radio status display
WGT status	Display of serial number and version
Measured values	Display of current value. To adjust the sensor, press the Adjust button. Adjust the value for “Displayed temperature”. Confirm your entry using the OK key.
Settings	Press the Manual Menu button to set if the indoor sensor shall be displayed in the manual menu. Confirm your choice using the OK key.

Remote control Remo 8

Radio module type	“Remo 8” display
Radio module name	To change the name, press the button showing device identification. Enter the required name in the box which appears. Confirm your entry using the OK key.  2.4. Input keyboard for names and codes
Serial number	Display of serial number
Drive groups	Press the Allocate button to allocate drives and devices to the manual sender channels. Select channel for the manual sender (channels 1 to 8). Select the drives and/or devices to be controlled by the channel. Confirm your entry using the OK key.
 ATTENTION! Only drives/units with the same function should be controlled together using a single transmitter channel (e. g. blinds or windows alone).	

WL400, WL800, WL610, WL305 roof vent

Radio module type	“WL305/610/400/800” display
Radio module name	To change the name, press the button showing device identification. Enter the required name in the box which appears. Confirm your entry using the OK key.  2.4. Input keyboard for names and codes
Radio status	Radio status display
WL305/610 status	Display of serial number, period, flap movements, version

Measured values	Display of current temperature change on vent. To adjust the sensor, press the Adjust button. Adjust the value for "Displayed temperature". Confirm your entry using the OK key.
Settings	Press the Manual Menu button to set if the vent shall be displayed in the manual menu. Confirm your choice using the OK key.

WFL air supply device

Radio module type	"WFL" display
Radio module name	To change the name, press the button showing device identification. Enter the required name in the box which appears. Confirm your entry using the OK key.  2.4. Input keyboard for names and codes
Radio status	Radio status display
WFL status	Display of Serial number, flap movements, version
Measured values	Display of current temperature change on vent. To adjust the sensor, press the Adjust button. Adjust the value for "Displayed temperature". Confirm your entry using the OK key.
Settings	Press the Manual Menu button to set if the vent shall be displayed in the manual menu. Confirm your choice using the OK key.



RF-VM ventilation module:

Radio module type	"RF-VM" display
Type of automatic	Press the button in order to set the function of the device attached to the ventilation module. Select Supply/Exh. Air or Fresh Air/Heating and confirm with the OK button. The automatic menus will be updated to match.
Name	To change the name, press the button showing device identification. Enter the required name in the box which appears. Confirm your entry using the OK key.  2.4. Input keyboard for names and codes
Radio status	Radio status display
RF-VM status	Display of Serial number and version
Settings	Press the Manual Menu button to set if the vent shall be displayed in the manual menu. Confirm your choice using the OK key.

RF relay

Radio module type	“RF-Relais” display
Type of automatic	To set what shall be connected to the RF relay, press the button. Select the type of automatic regime (heating, cooling, alarm, light, roof gutter heating, supply air, dimmer or none). If "Dimmer" or "None" is selected, the device can be switched on and off only by hand, there are no automatic regime menus. Confirm your entry using the OK key.
Radio module name	To change the name, press the button showing device identification. Enter the required name in the box which appears. Confirm your entry using the OK key.  2.4. Input keyboard for names and codes
Radio status	Radio status display
RF relay status	Display of Serial number and version
Settings	Press the Manual Menu button to set if the device shall be displayed in the manual menu. Confirm your choice using the OK key.

RF-MSG motor control devices

Radio module type	“RF-MSG” display
Type of automatic	To set what shall be connected to the RF-MSG relay, press the button. Select type of automatic regime (awning, window, sky roof, blinds). Confirm your entry using the OK key.
Radio module name	To change the name, press the button showing device identification. Enter the required name in the box which appears. Confirm your entry using the OK key.  2.4. Input keyboard for names and codes
Radio status	Radio status display
RF-MSG status	Display of Serial number, version and RF-Router if applicable
Other settings	Basic settings of drive, setting of movement times, MSG control.  6.1. Set up drives and drive groups, page 94 (MSG control and zero position movement time/dead time can be set as of RF-MSG version 3.4)

Delete wireless connection

Delete

Press **Delete** if you want to delete the connection to a wireless participant. All wireless participants available are shown:

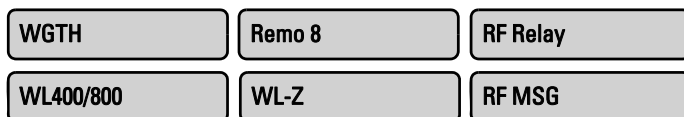

Select the wireless participant to be deleted. Confirm the question “Really delete wireless connection to member XX?” with **Yes**. The wireless connection is deleted.

6.1.7. Indoor sensor for weather display

In the weather data display, the values from a sensor (e.g. internal sensor of WS1 Color or wireless sensor WGTH-UP) can be displays. Wireless sensors have to be taught in to the control first.

Select the desired sensor here. Press the buttons:

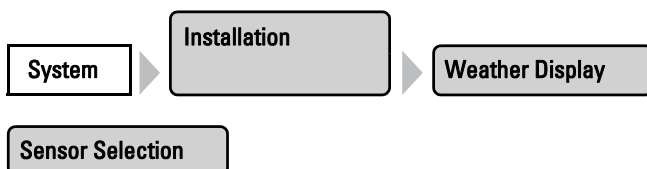

Press the button to reach the selection menu with the sensors. Then press the button of the desired sensor and confirm using the **OK** button.

6.1.8. Settings for communication with KNX (WS1000 only)

Communication with the building bus system KNX is possible with WS1000 only. The control must be equipped with KNX interface for this purpose (optional accessory).

To set up the data exchange with the KNX system, please use the ETS software and follow the KNX Interface Guide. The KNX actuators and sensors provided for communication with the WS1000 Color are displayed in the **KNX Settings** menu and can be adjusted. Pres the buttons:



A list of all KNX actuators and sensors set up for communication with the control system (ETS) will be displayed. Press the button of the actuator or sensor that you wish to set.

Different operational data and setting options will be displayed for the devices:

Function	Display of the block with number and type of input or output
Name	Press the button with the device's designation in order to change the name. Enter the desired name via the keypad that appears. Confirm your selection using OK . ☞ 2.4. Input keyboard for names and codes
Status of KNX Block (only for inputs)	Display of communication status
Correction factor (for 2/4 byte floating point inputs only)	Press the button in order to enter the correction factor for the value received by the bus. Enter the factor via the keypad that appears. Confirm your selection using OK .
Measuring unit (for 2/4 byte floating point inputs only)	Press the button in order to input the measuring unit. Enter the desired name via the keypad that appears. Confirm your selection using OK . ☞ 2.4. Input keyboard for names and code
Settings (varies depending on type of input/output)	Press Manual Direction in order to adjust the assignment of the arrow keys (up/down, on/off). A selection menu appears. Select whether the drive shall retract (or open) or extend (or close) when the button is pushed. Confirm your selection using OK . Press Manual Menu in order to set whether the drive/sensor shall be displayed in the manual menu or not. Confirm your selection using OK .

The KNX drives and devices appear in the menu for Automatic Setting. The setting options for automatic functions are the same as for directly connected drives and devices.

6.1.9. Setting Camera Inputs

This menu point only appears if the control is equipped with a camera interface!

In order to set up camera interface and inputs, press the buttons:



If you want to set both camera inputs, press the button with the name of the camera. In the pre-settings, the cameras are called "Camera 1" and "Camera 2". You can change the names in this menu.

You can perform the following settings on each camera:

Test pattern	Press Show Picture , in order to show the current camera picture. If no camera is connected, nothing will be displayed. Confirm your entry by pressing OK .
Using the camera	Press the button in order to activate or deactivate this camera. Select Yes or No . Confirm your entry by pressing OK .
Name	Press the button with the device's designation (pre setting: camera 1/2), in order to change the name. Enter the desired name using the key pad that appears. Confirm your selection using OK . 📄 2.4. Input keyboard for names and codes
Camera off after ... (sec.)	Press the button with the numeric value in order to set how long the camera's picture shall be displayed on the weather data screen. After the pre-set time has expired, the picture fades out. Enter the desired time (seconds) using the keypad that appears. Confirm your entry by pressing OK .
Multif. Input	Press the button Assign , in order to assign the camera to a multifunction-input. The camera then comes on automatically as soon as signal is picked up at this input (e. g. motion detector). Several inputs can also be selected. Confirm your entry by pressing OK .

Interface

Press the button if you want to de-activate the camera interface. This is only necessary if the interface fails or is removed when the control system is running and an error message is displayed ("Camera interface defect"). By de-activating the interface the error message is suppressed and the weather animation will be displayed normally again.

De-activating: If the camera interface is to be turned off, select **Yes**.

Confirm your setting by pressing **OK**.

6.1.10. Configuring internal thermometer/ hygrometer of WS1

To configure the internal sensor of WS1, press the buttons:



Sensor type	Display "WS1 TH"
Name	Press the button with the device's designation (pre setting: Thermo/hygro), in order to change the name. Enter the desired name using the key pad that appears. Confirm your selection using OK . 📖 2.4. Input keyboard for names and codes
Status	Display of status
Measured values	Display of the current values. Press the button Adjust to adjust the sensor. Adjust the value at "displayed temperature/humidity". A correction to the values measured may be necessary if the temperature/humidity on the sensor does not match the average for the room (e.g. if the WS1 Color is installed at a site that is warmer than average). Confirm your selection using OK .
Settings	Press the Manual Menu button in order to set whether the drive/sensor shall be displayed in the manual menu or not. Confirm your selection using OK .

6.1.11. Define channel order

This is where you define the order in which the drives and devices are shown in the menus. Press the buttons:



Here all configured drives and devices ("channels") are displayed. Note that the list also includes those channels that do not appear in the manual menu. The display in the manual menu can be activated or de-activated in the base settings for every single channel.

📖 6.1. Set up drives and drive groups

Press the button of the channels to be changed and shift them with the arrow keys that appear on the right.

Confirm the new sequence with the **OK** button.

6.2. WS1 / WS1000 Settings

In the menu area **System > WS1 / WS1000 Settings** you can adjust the following settings:

- Change personal data such as time/date and location and adjust the screen display to your personal preferences (Settings)
- Restart, reset to factory defaults and change internal settings of the control (Service)

- Set an access code to protect the “Installation” and “Automatic Settings” menus from unauthorised changes
- Storing the set-up data for the control system on the SD card or reading the data from the SD card (only WS1000 Color)

6.2.1. Settings

In the menu area **System > WS1 / WS1000 Settings > Settings** you can adjust the following settings:

- Time and date
- Language
- Display
- Calibrate touch
- Time zone
- Location

Enter time and date manually

Time and date are normally received by the weather station via the DCF77 respectively GPS signal. Reception is normally available within around 10 minutes of starting up the system. The date and time is then shown on the weather data display on the lower right.

If no time signal is available, “Please set clock!” will show permanently in the display. While this is being displayed, no weather animations can be shown. In this case, you should set the clock by hand.

The time settings can be accessed by pressing the buttons:



Set the time and date by pressing the hour, minute, second, day, month and year fields after one another and setting the current values.

Confirm your setting with the **OK** button.

Change language

The menus can be shown in German, English, French or Italian. Press the buttons:



Select the desired language for the menus by pressing the button. Confirm your setting with the **OK** button.

Adjust screen

The brightness and automatic shutdown of the display can be adjusted individually. Press the buttons:



In the menu that appears you can switch the automatic brightness adjustment on and off. For this press the **On** or **Off** button.

The **automatic brightness adjustment** adjusts the display screen to the light conditions in the room (the darker the room, the darker the display screen lighting). Touching the display screen increases the brightness by 30% in order to ensure excellent legibility. If no further operation is performed within one minute, the screen brightness is reduced once again. This automatic darkening saves energy.

If the automatic function is off, the screen brightness can be set in percent. For this press the **% value**. Using the arrow keys that appear you can adjust the value. Default setting: On.

Using the **automatic switch-off**, you can determine whether the display lighting should be switched off. Press the button **Off / When ambience dim / On** until the desired setting is visible. Pre-set: Off.

If the automatic switch-off is set to **On**, the display lighting will be turned off if no command is given for 5 minutes. If the screen is touched, it re-activates.

If the automatic switch-off is set to **When ambience dim**, then the display lighting will switch off if the room is dark. If the room is lit, the display lighting will automatically re-activate. If the screen is touched, it also re-activates. If no command is given for around 1 minute, the automatic switch-off darkens the screen again.

Confirm your setting with the **OK** button.

Select time zone

In order to display date and time correctly, the time zone (relating to GMT) must be specified here. In addition the automatic switch-over to summer time can be set.

You can reach the time zone settings by pressing the buttons:



The **time zone** can be set by pressing the arrow keys in the menu that appears.

Examples for UTC difference:

Country	UTC difference
Belgium	+01:00
Germany	+01:00
France	+01:00
United Kingdom	+01:00
Ireland	+01:00
Italy	+01:00
Croatia	+01:00
Luxembourg	+01:00
Netherlands	+01:00
Norway	+01:00
Austria	+01:00
Poland	+01:00
Portugal	+01:00
Sweden	+01:00
Switzerland	+01:00
Spain	+01:00

Press the button next to Summertime Rule to set the automatic switch-over. Depending on location, select **Europe**, **USA**, **None** (if no summertime switch-over shall take place) or **User-defined** (if the switching shall be set individually).

Confirm your setting with the **OK** button.

Enter location (only DCF weather stations)

The location must only be specified if the control unit is connected to a weather station with a DCF77 receiver!

The information about the building's location is required for correct details of the sun's position. If the location data is not correct, the shades will not be properly controlled.

The location settings can be accessed by pressing the buttons:



In the menu that appears, you can enter the location as a **city** or as **coordinates** (longitude and latitude).

City

Select **City** to make a selection under Country and City from a list using the buttons.

Coordinates

Select **Coordinates** to specify the location numerically. Press the minute and second fields after one another for eastern longitude and northern latitude and set the values with the arrow keys that appear.

Confirm your setting with the **OK** button.

Calibrate touch

If, when operating the touch display, you are forced to press “next to the button”, please perform a calibration here. Press the buttons:



Follow the instructions on the display and press with a pointed object (preferably the enclosed control stylus) on the centre of the cross. This will adjust the touch surface.

6.2.2. Service settings

In the menu area **System > WS1 / WS1000 Settings > Service** you can adjust the following settings:

- Reset (new start)
- Factory settings
- Internal area



ATTENTION

Material damage due to inappropriate use of the service functions!

In normal operation of the control unit, the service settings are not used.

Reset (new start)

Reset restarts the control system’s software. In the process, the automatic settings will be maintained. After starting up, all drives and devices with activated automatic reset will be in automatic mode.

The Reset function can be accessed by pressing the buttons:



Reset

Press **Reset** and the control system restarts.

Factory settings



ATTENTION

Material damage due to inappropriate use of the service functions!

In normal operation of the control unit, the service settings are not used.

By resetting to the factory defaults all basic and automatic settings will be deleted. The control unit will once again be in the condition it was when delivered.

The Factory settings can be accessed by pressing the buttons:

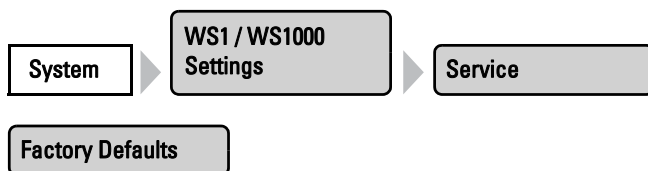

Select **Factory Defaults**. Enter the code "81" via the keypad which appears and confirm with the **OK** button. The factory settings will be loaded and the control system restarted.

Internal area

In the internal area, basic data of the device can be modified. You are not authorised to change this.

6.2.3. Access code

In the **System > WS1 / WS1000 Settings > Access code** menu area you can set an access code which locks the "Installation" and "Automatic Settings" menus against unauthorised changes. Manual operation of the control system remains possible at any time.

The access code settings can be accessed by pressing the buttons:



Here you can enter, change and delete a code.

Enter Code

Press the button to set a new code. Enter the desired access code via the keyboard that appears. The code will be shown in plain form.

📖 2.4. Input keyboard for names and codes

Confirm your setting with the **OK** button.

The control system will now ask for this code before the menus are shown.

Change Code

Press the button to change an existing code. First of all enter the existing access code via the keyboard that appears. The code will be shown in plain form.

📖 2.4. Input keyboard for names and codes

Confirm your input with the **OK** button.

Now enter the new access code via the keyboard.

Confirm your setting with the **OK** button.

The control system will now ask for this code before the menus are shown.

Delete Code

Press the button to delete an existing code, e.g. if you have forgotten the combination or do not want it to be locked any more. Enter the active code or the unlocking code "123" via the keyboard that appears.

Confirm with the OK button. The control system shows "Access code deleted". Press **←** to go back to the menu. The control system no longer has an access code.

6.2.4. Using an SD card (only WS1000 Color)

The **WS1000 Color control system** has an SD card slot, which can be used to show the images on the display and to store or transfer the set-up data to the control system.

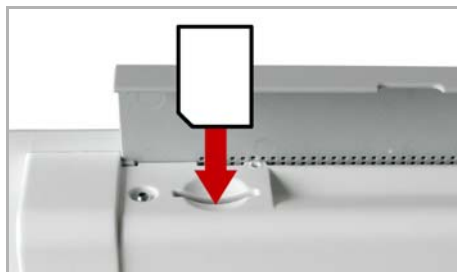

The SD card slot can be found under the covering flap. The SD card is pushed into the slot, until it clicks into place.

The card is automatically recognised and the symbol „SD card“ appears in the bottom right-hand corner of the display. Once the image data have been saved onto the card, the symbol for "play-back" immediately appears in the weather data display. From here you can start the slideshow directly.

To remove the card, briefly push down on the card. The card pops up slightly out of the slot and can then be removed.

The SD card menu can be accessed by pressing the buttons:



Show images on display

The WS1000 Color can display digitally-stored image data as a slideshow or as individual images. For this, the image data must be saved onto an SD card and fulfil the following requirements:

- Data format Bitmap (BMP)
- Size 640 x 480 pixels
- Color intensity 24 bit or 16 bit
- No compression (RLE)
- The data must be saved in the uppermost level of the card's directory (root directory)

Slideshow

Press the button to start the slideshow. The images are displayed in the same sequence as they were saved onto the card (see note below). The image changes approx. every 45 seconds (for images with 24-bit color intensity).

To return to the weather data display, touch the screen or remove the SD card (briefly press down on the card so that it pops out).

Image

Press the button if you wish to show an individual image on the display. All images saved on the card will be displayed. Select the desired picture.

To return to the weather data display, touch the screen or remove the SD card (briefly press down on the card so that it pops out).

Note: The sequence of the catalogue of individual images and of the slideshow corresponds to the sequence in which the images were saved onto the card. The images are not sorted according to name.

Saving and loading configuration data

The SD card can be used as a storage and transfer medium for set-up data to:

- Save personal settings
- Store summer and winter configurations on two SD cards

Load Config.

Press the button to transfer the settings data from the SD card to the control system. All configuration data stored in the card's root directory will be displayed. Select the desired file. The data will be uploaded and the control system restarted.

Save Config.

Press the button to save the control system settings data onto the SD card. Enter the desired file name using the keyboard that appears (max. 7 characters). Confirm by pressing the **OK** button to save the information.

 2.4. Input keyboard for names and codes



7. Tables, diagrams, maintenance

7.1. Care and maintenance

Maintenance of the weather station



WARNING!

Risk of injury caused by components moved automatically!

The automatic control can start system components and place people in danger (e.g. moving windows/awnings if a rain/wind alarm has been triggered while cleaning).

- Always isolate the device from the mains for servicing and cleaning.

The device must regularly be checked for dirt twice a year and cleaned if necessary. In case of severe dirt, the sensor may not work properly anymore.



ATTENTION

The device can be damaged if water penetrates the housing.

- Do not clean with high pressure cleaners or steam jets.

Maintenance of the control unit

Finger marks on the touch screen are best removed with a damp cloth or a microfiber cloth. You can wipe the buttons without activating them.

Do not use abrasives / detergents or aggressive cleaners for cleaning.

If there is a power outage, the data you have entered will be saved for around 10 years. No battery is required for this. Once power is restored, the clock must be set again. If there is time signal reception this takes place automatically.

7.2. Technical specifications

7.2.1. Technical specifications Control Unit WS1 Color

Housing	Plastic material (partially painted)
Colours	<ul style="list-style-type: none"> • White glossy (similar to RAL 9003 Signal White) / light grey (similar to RAL 7035 Light Grey) • Aluminium (similar to RAL 9006 White Aluminium) / graphite (similar to RAL 7024 Graphite grey)
Mounting	Flush/cavity wall
Dimensions	Central unit approx. 164 × 121 × 29 (W × H × D, mm), concealed box approx. 152 × 95 × 62 (W × H × D, mm)
Ambient temperature	Operation 0...+50°C, Storage -30...+70°C, avoid bedewing
Operating voltage	230 V AC, 50 Hz

Power consumption	Stand-by max. 10 W
Frequency wireless channels	868.2 MHz
Protection category	IP 30
Measurement range temperature	0...+50°C
Resolution (temperature)	0.1°C
Measurement range humidity	0...100% RH
Resolution (humidity)	0.1%

The product conforms with the provisions of EU directives.

7.2.2. Technical specifications Control Unit WS1000 Color

Housing	Plastic material (partially painted)
Colours	<ul style="list-style-type: none"> • White glossy (similar to RAL 9003 Signal White) / light grey (similar to RAL 7035 Light Grey) • Aluminium (similar to RAL 9006 White Aluminium) / graphite (similar to RAL 7024 Graphite grey)
Mounting	Flush/cavity wall
Dimensions	Central unit approx. 250 × 182 × 43 (W × H × D, mm), concealed box approx. 235 × 169 × 62 (W × H × D, mm)
Ambient temperature	Operation 0...+50°C, Storage -30...+70°C, avoid bedewing
Operating voltage	230 V AC, 50 Hz
Power consumption	Stand-by max. 16 W
Frequency wireless channels	868.2 MHz

The product conforms with the provisions of EU directives.

7.2.3. Technical specifications P04i-GPS

Housing	Plastic
Colour	White / Translucent
Assembly	Surface mount
Protection category	IP 44
Dimensions	approx. 62 × 71 × 145 (W × H × D, mm)
Weight	approx. 80 g
Ambient temperature	Operation -30...+50°C, Storage -30...+70°C
Voltage	24 V DC
Power	max. 105 mA

Temperature sensor:	
Measurement range	30°C ... +50°C
Resolution	0.1°C
Accuracy	±0.5°C at -30°C ... +25°C ±1.5°C at -30°C ... +45°C
Wind sensor:	
Measurement range	0 m/s ... 35 m/s
Resolution	0.1 m/s
Accuracy	±15% of the measurement value when incoming flow is 45°...315° (Frontal incoming flow corresponds to 180°)
Brightness sensor	
Measurement range	0 lux ... 99.000 lux
Resolution	1 lux at 0 ... 999 lux 1 klux at 1 ... 99 klux
Accuracy	±15% of the measurement value at 35 lux ... 99.000 lux

The product is compliant with the provisions of the EU guidelines.

7.2.4. Technical specifications WGTH-UP

Housing	Plastic (partially painted)
Colours	<ul style="list-style-type: none"> • White, glossy (similar to RAL 9016 Traffic White) • Matt aluminium
Installation	Flush-mounted (installed in wall within junction box Ø 60 mm, 42 mm deep)
Protection rating	IP 20
Dimensions	Housing approx. 55 × 55 (W × H, mm) Installation depth approx. 15 mm Backplate approx. 71 × 71 (W × H, mm)
Total weight	approx. 50 g
Ambient temperature	Operating -20...+70°C, Storage -55...+90°C
Ambient air humidity	max. 95% RH, avoid condensation
Operating voltage	7...30 V DC
Current	max. 35 mA
Data output	Wireless
Wireless frequency	868.2 MHz
Protocol	Proprietary protocol (Elsner RF)
Temperature measurement range	-20...+70°C
Resolution (temperature)	0.1°C

Accuracy (temperature)	±0,6°C at -20...-10°C ±0,5°C at -10...+65°C ±0,6°C at +65...+70°C
Humidity measurement range	0...100% RH
Resolution (humidity)	0,1%
Accuracy (humidity)	±7,5% RH at 0...10% RH ±4,5% RH at 10...90% RH ±7,5% RH at 90...100% RH
Drift (humidity)	±0.5% RH per year in normal atmosphere

The product conforms with the provisions of EU directives.

7.2.5. Units for sun and wind

The display of sun intensity is in lux or kilolux and is shortened in the display to lx or klx. The value 1 is reached even with overcast skies, 20 klx if the sun has just come out again and 100 klx is reached when there are cloudless skies at noon. Experience indicates that extending shades above 40 klx is to be recommended.

The display of wind speed is in meters per second and is shortened in the display to m/s. Depending on the position of the building and the installation position of the weather station, different values may be optimal in order to protect the shade or window. Observe the response of the awning or blinds or the window to wind and then correct the wind value accordingly.

The following table should make it easier to find the optimal values for your situation:

Description	m/s	km/h	Beaufort	Knots
Calm	< 0,3	< 1	0	< 1
Light air	0,3-1,5	1-5	1	1-3
Light breeze	1,6-3,3	6-11	2	4-6
Gentle breeze	3,4-5,4	12-19	3	7-10
Moderate breeze	5,5-7,9	20-28	4	11-16
Fresh breeze	8,0-10,7	29-38	5	17-21
Strong breeze	10,8-13,8	39-49	6	22-27
Moderate gale	13,9-17,1	50-61	7	28-33
Fresh gale	17,2-20,7	62-74	8	34-40
Strong gale	20,8-24,4	75-88	9	41-47
Whole gale	24,5-28,4	89-102	10	48-55
Storm	28,5-32,6	103-117	11	56-63
Hurricane	> 32,6	> 117	12	> 63

7.3. Alarm and error messages

7.3.1. Weather data display messages

Various alarm and error messages can appear in the weather data display. In this case no weather animation will be shown.

Alarm from motion detector

is shown when a connected motion sensor has been activated. When there is a motion-detector alarm, windows close automatically; if applicable, the light is switched on. After 5 minutes without another signal from the motion detector, the warning disappears and the control system returns the windows to normal automatic mode.

Fire alarm! By "XX" (sensor name)

is shown if the control system receives a signal from a smoke detector. At the same time awnings and blinds retract, the light comes on, heatings and air conditioners switch off, windows and ventilators open/switch on. Manual operation is blocked. A warning system sounds at the control system. The fire alarm can only be switched off by a Reset/Restart of the control system through the **System > WS1 / WS1000 Settings > Service > Reset** menu or by cutting off the power supply.

Please set clock!

is shown when the control system is first started or after a restart. As soon as a time signal is received, this message disappears. If no reception is available, please set the clock by hand.

- System > WS1 / WS1000 settings > Settings > Time and Date
- 6.2. Enter time and date manually

Connection to weather station failed!

means that the control system is receiving no data from the weather station. Check the connection lead to the weather station and examine it if necessary. **Manual** operation of drives and devices without rain or wind alarm is still possible. Drives with selected rain or wind alarm move to the safe position.

RF868 wireless module faulty!

means that the internal wireless module is not working properly. Contact customer service to have the control unit checked.

KNX interface faulty!

(only for WS1000 Color with KNX interface)

Indicates an error or defect in the KNX interface. There is no communication with the bus. If the ETS is set to allow weather data to be received from the bus, a wind or rain alarm is triggered on the control system. Get in touch with customer support to check the interface.

Camera interface faulty!

(only when a camera interface is installed)

Indicates an error or defect in the camera interface. Get in touch with customer support to check the interface.

Configuration memory faulty!

means that the memory for the automatic settings is not working properly. Contact customer service to have the control unit checked.

7.3.2. "Manual" menu messages

The manual menu displays the status of the drives, devices and sensors as well as any error messages (e. g. on/off, exhaust speed, slat position, etc.).

No response! Or Sensor fault

as a status message from a wireless device

(e. g. wireless fan, drive to RF-MSG or WGTG-UP wireless sensor)

The control system receives no further information from the wireless receiver. Check the status of the wireless connection under **System > Installation > Wireless connection > Status**. If the wireless system has a problem, this displays "Wireless status: Receiver timeout". Have the affected device checked.

Fault!

as a status message from a KNX bus device

Indicates an error or fault in the KNX interface. There is no communication with the bus. If the ETS is set to allow weather data to be received from the bus, a wind or rain alarm is triggered on the control system. Get in touch with customer support to check the interface.

No measurement value received or Position unknown

as a status message from a wireless/KNX sensor or a KNX actuator

The control system has not yet received any data from a configured sensor (wireless or KNX) or KNX actuator. Once data is received, the message disappears.

7.4. Connection diagrams

7.4.1. Diagrams WS1

Drive and MF outputs WS1:

max. 400 W per drive output
total max. 1.5 kW for all drive outputs

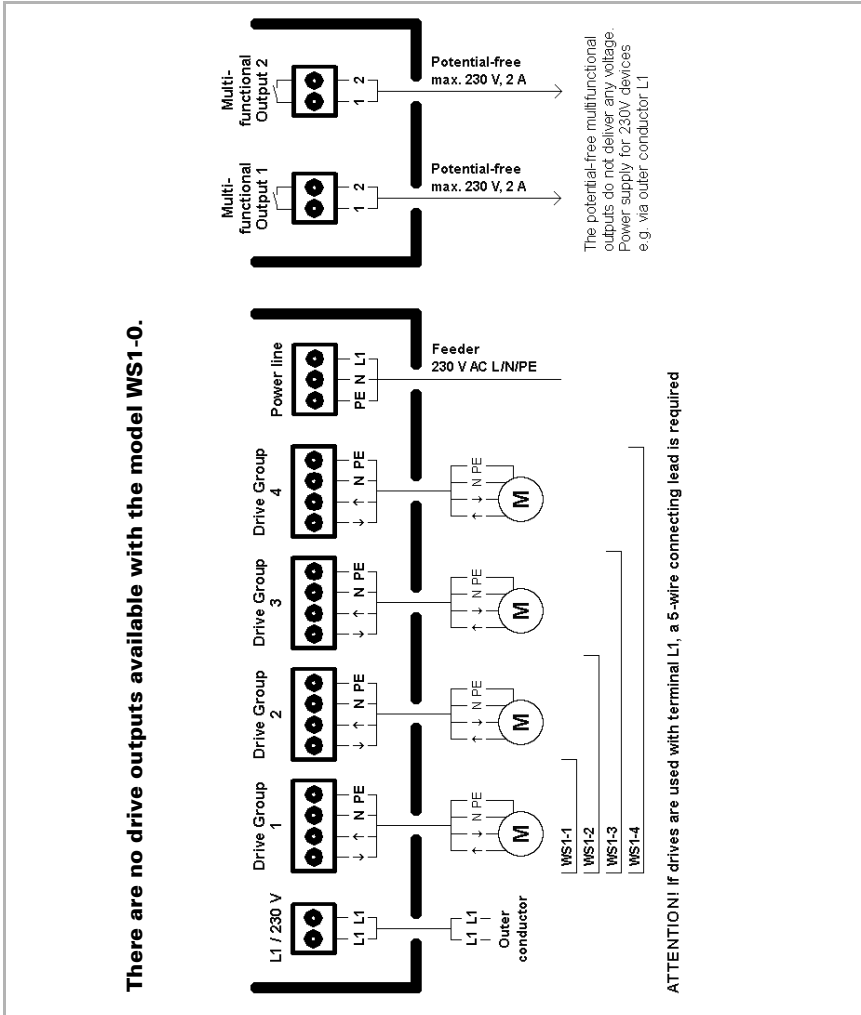

Inputs WS1:

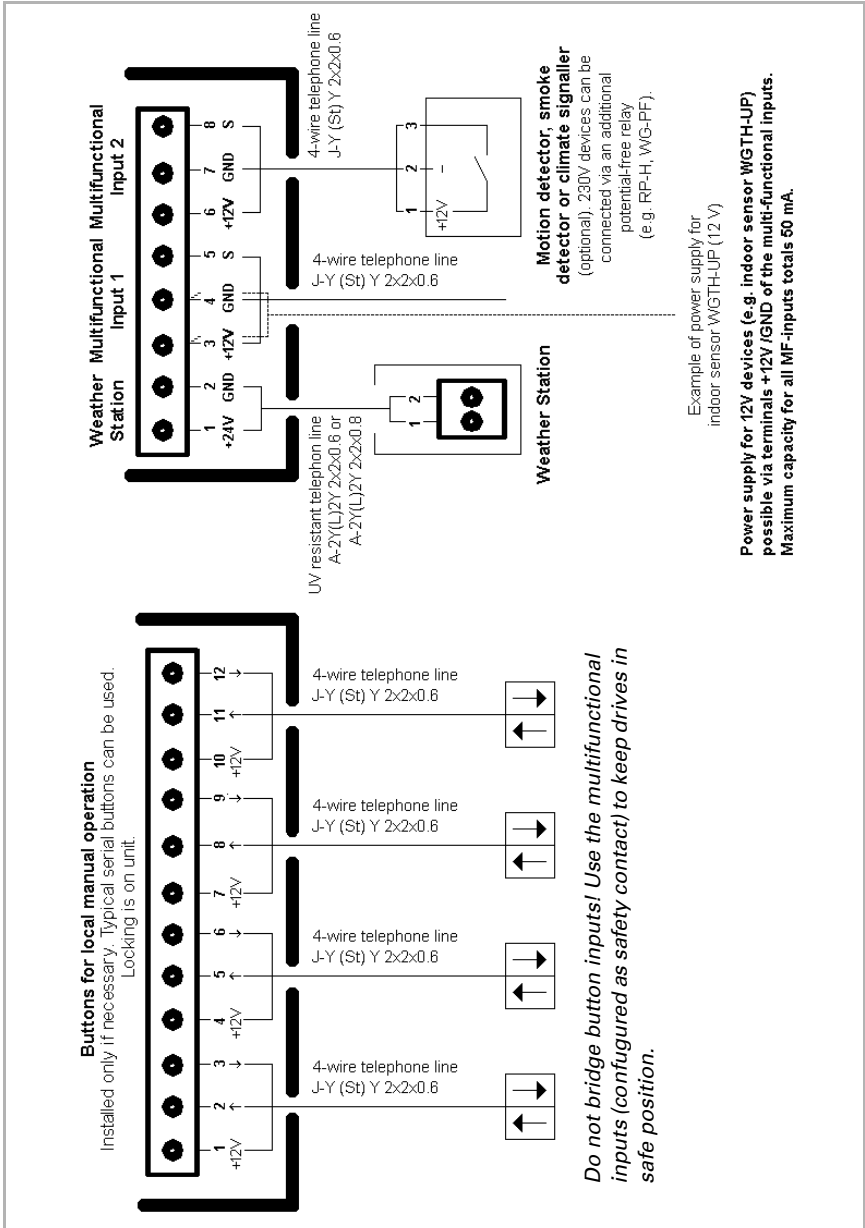

7.4.2. Diagrams WS1000

Drive and MF outputs WS1000:

max. 400 W per drive output
total max. 1.5 kW for all drive outputs

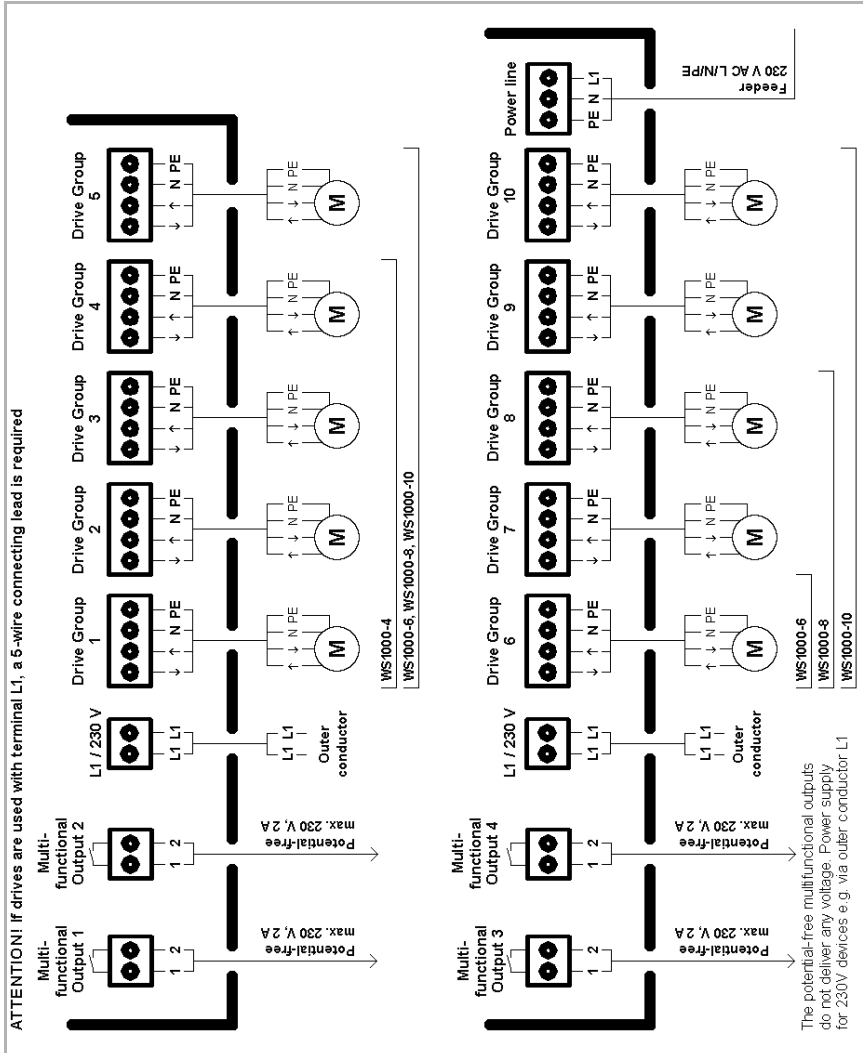

7.4.3. Connection of several drives to one 230 V drive output

Connection examples for several drives to one drive group

ATTENTION! If motors are used that require a constant phase L1 for operation the entire wiring must be 5-wire. Corresponding terminals are fitted in the group control relays. All group control relays are designed for a maximum of 4 motors.

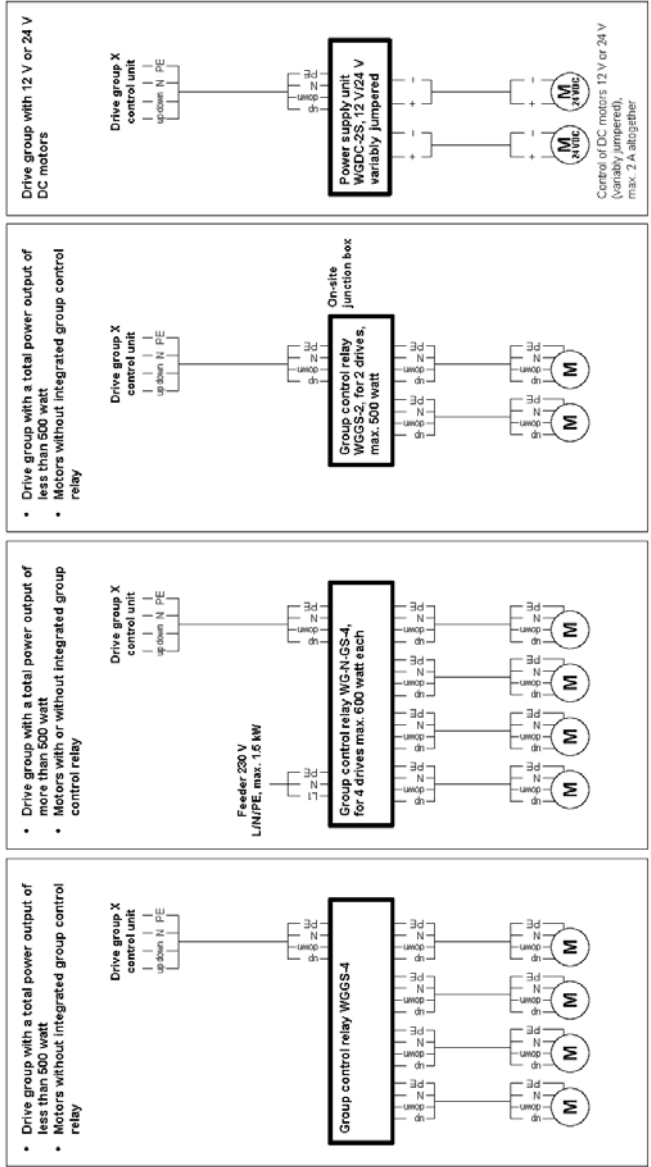

7.4.4. Use drive outputs for centralised control

Centralised control with IMSG 230 Motor Control Units (230 V drive output)

Simple centralised control

Example for simple central control with motor-control devices in one drive group of the control system: IMSG230 motor-control devices with Up/Down buttons for manual operation on the spot.

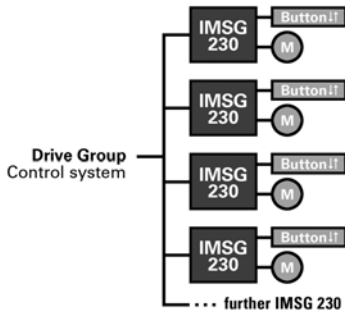

Central with group formation

Example of central control with group formation with motor-control devices in one drive group of the control system: IMSG230 motor-control devices with Up/Down buttons for manual operation on the spot

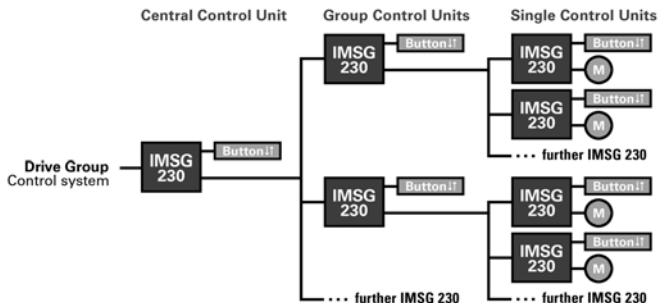

Centralised control with IMSG-UC Motor Control Units

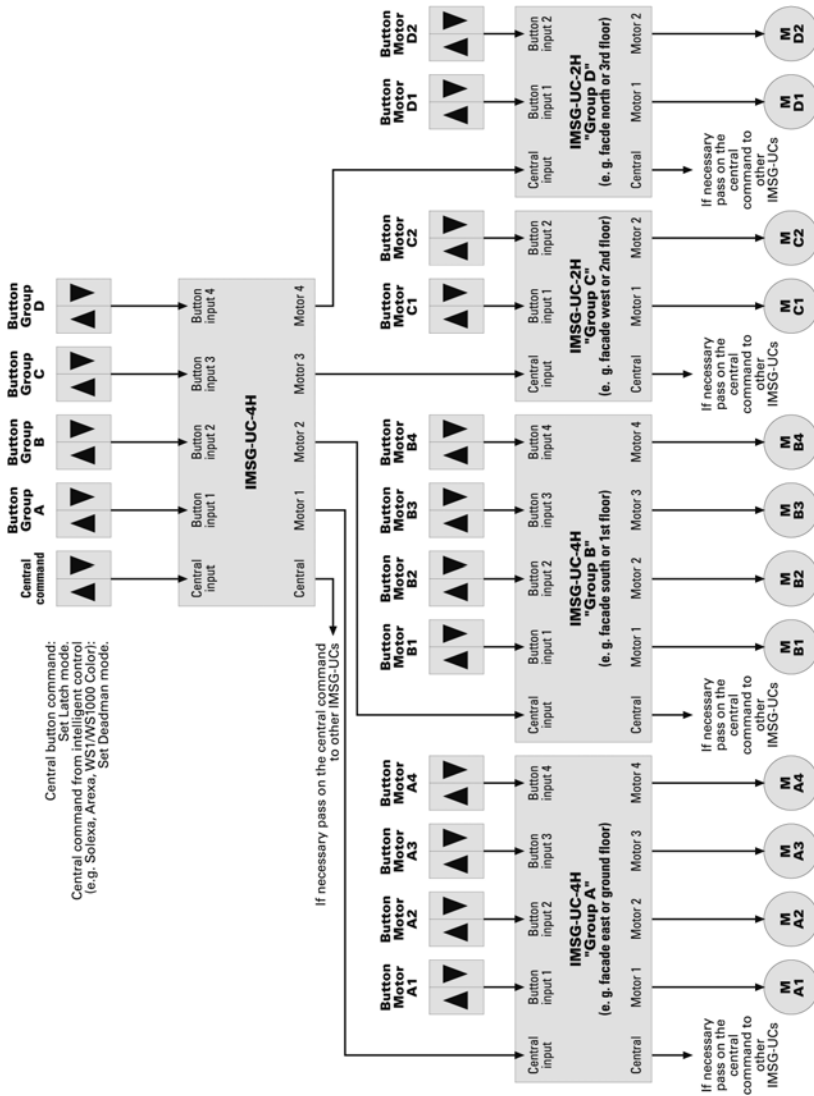

Instead of the drives, additional IMSG-UCs can be connected here for sub-groups.

7.5. Personal automatic settings data

Awnings, blinds, shutters

Drive no. (output)							
Name							
Function							
Light intensity (kLUx)							
Direction of sun							
Height of sun							
Movement position							
Slat position							
Slat position for height of the sun of	0°-15°						
	15°-30°						
	30°-45°						
	45°-90°						
Indoor sensor							
Indoor temperature (°C)							
Night closure?							
Timed closure (period)							
Outdoor temperature (°C)							
Wind alarm at (m/s), Time exceeded							
Rain alarm?							
Automatic reset?							
Reset following manual intervention?							

Extension delay (min)	
Retraction delay (min)	
Twilight value (lux)	



Window

Drive no. (output)						
Name						
Normal, sliding window or step window?						
Indoor sensor						
Indoor temperature (°C)						
Air humidity (%)						
Supply air temperature block						
Night-time re-cooling (period, temp., position)						
Movement position/number of steps						
Timed ventilation (period)						
Outdoor temperature (°C)						
Timed closure (period)						
Wind alarm at (m/s), Time exceeded						
Rain alarm?						
Gap opening during rain? Position						
Automatic reset?						
Reset following manual intervention?						

Ventilation, heating and cooling units

No. (output)						
Name						
Indoor sensor						
Air humidity (%)						
Indoor Temperature (°C)						
Outdoor Temperature (°C)						
Supply air temperature block						
Exhaust air levels						



No. (output)						
Name						
Night-time re-cooling ventil. (period, temperature)						
Timed ventil. /Night mode (period, temperature)						
Heat recovery recirculation (temperature, step)						
Condensation air recirculation (level)						
Automatic reset?						
Reset following manual intervention?						

Ventilation block via air-conditioning (min)	
--	--

Roof gutter heating

No. output						
Name						
Temperature range (°C) from						
Temperature range (°C) to						
Automatic reset?						
Reset following manual intervention?						

Light

No. (output)						
Name						
Twilight operation						
Time switch (period)						
On at alarm?						
Automatic reset?						
Reset following manual intervention?						



General settings

Time point for general automatic reset	
Reset following manual intervention (min)	

Timer time periods

	Name	from	to
1			
2			
3			
4			
5			
6			
7			
8			
9			
10			
11			
12			
13			
14			
15			
16			

