



# Cala KNX T 201 Sunblind, Cala KNX T 202 Sunblind Temperature Controller, Button for Shading

---



Cala KNX T 201 Sunblind  
Item numbers  
70990 (white),  
70992 (black)



Cala KNX T 202 Sunblind  
Item numbers  
71050 (white),  
71052 (black)



<b>1. Description .....</b>	<b>3</b>
1.0.1. Area function .....	4
1.1. Scope of delivery .....	4
1.2. Technical specifications .....	5
1.2.1. Accuracy of the measurement .....	5
<b>2. Installation and commissioning .....</b>	<b>6</b>
2.1. Installation notes .....	6
2.2. Installation position .....	6
2.3. Composition of the device .....	8
2.4. Installation of the sensor .....	8
2.5. Notes on mounting and commissioning .....	9
<b>3. Addressing of the device at the bus .....</b>	<b>9</b>
<b>4. Display and operation at the device .....</b>	<b>9</b>
4.1. Adjust room temperature (using the example Cala KNX T 201 Sunblind) .....	9
<b>5. Maintenance .....</b>	<b>11</b>
<b>6. Disposal .....</b>	<b>11</b>
<b>7. Transmission protocol .....</b>	<b>12</b>
7.1. List of all communication objects .....	12
<b>8. Setting the parameters .....</b>	<b>16</b>
8.1. Behaviour on power failure/ restoration of power .....	16
8.2. General settings .....	16
8.3. Temperature measured value .....	16
8.4. Temperature threshold values .....	17
8.4.1. Threshold value 1, 2 .....	17
8.5. Temperature PI controller .....	19
8.5.1. Heating control stage 1/2 .....	25
8.5.2. Cooling control stage 1/2 .....	27
8.6. LEDs .....	29
8.7. Buttons .....	30
8.7.1. Drive .....	31
8.7.2. Control modes for drive control .....	35
8.8. Logic .....	36
8.8.1. AND logic outputs 1/2 and OR logic outputs 1/2 .....	37



Installation, inspection, commissioning and troubleshooting of the device must only be carried out by a competent electrician.

This manual is amended periodically and will be brought into line with new software releases. The change status (software version and date) can be found in the contents footer. If you have a device with a later software version, please check **www.elsner-elektronik.de** in the menu area "Service" to find out whether a more up-to-date version of the manual is available.

## Clarification of signs used in this manual



Safety advice.



Safety advice for working on electrical connections, components, etc.

### **DANGER!**

... indicates an immediately hazardous situation which will lead to death or severe injuries if it is not avoided.

### **WARNING!**

... indicates a potentially hazardous situation which may lead to death or severe injuries if it is not avoided.

### **CAUTION!**

... indicates a potentially hazardous situation which may lead to trivial or minor injuries if it is not avoided.



**ATTENTION!** ... indicates a situation which may lead to damage to property if it is not avoided.

### ETS

In the ETS tables, the parameter default settings are marked by underlining.

# 1. Description

The **Cala KNX T 201/202 Sunblind push button** has touch-sensitive buttons with which functions can be called up in the KNX building bus system. The glass surface is printed with areas for setting the temperature and solar protection. White LEDs are integrated in these areas and their behaviour can be adjusted.

A temperature sensor is integrated into **Cala KNX T 201/202 Sunblind**. An external temperature reading can be received via the bus and processed with its own data to create a total temperature (mixed value).

The **Cala KNX T 201/202 Sunblind** has a PI controller for heating and cooling. The setpoint temperature can be changed using the "+" and "-" touch buttons.

Communication objects can be linked via AND and OR logic gates.

The device is supplemented with a frame of the switch series used in the building, and thus fits seamlessly into the interior fittings.

## **Functions:**

- **Operating zone for temperature control** with 2 areas (warmer, cooler)
- **LEDs** can be set. All LEDs Off, all LEDs as ambient lighting, all LEDs individually controllable
- **Area function** when touching two or more push buttons. Can be configured as switch, selector switch, as 8 or 16 bit encoder or for scenario recall
- **Temperature** measurements. **Mixed value** from own measured value and external values (proportion can be set by percentage), output of minimum and maximum values
- **PI-controller for heating** (one or two-level) and **cooling** (one or two-level) according to temperature. Regulation according to separate setpoints or basic setpoint temperature
- **2 AND and 2 OR logic gates** each with 4 inputs. 8 logic inputs (in the form of communications objects) can be used as inputs for the logic gates. The output from each gate can be configured optionally as 1-bit or 2 x 8-bit

## **Additional functions Cala KNX T 201 Sunblind:**

- **1 operating zone for blinds**, awnings, shutters or windows with 2 areas (up/down with short/long distinction)

## **Additional functions Cala KNX T 202 Sunblind:**

- **2 operating zones for blinds**, awnings, shutters or windows with 2 areas (up/down with short/long distinction)

Configuration is made using the KNX software ETS 5. The **product file** can be downloaded from the ETS online catalogue and the Elsner Elektronik website on [www.elsner-elektronik.de](http://www.elsner-elektronik.de) in the "Service" menu.

### 1.0.1. Area function

If the area function in ETS has been activated, another function is available alongside the regular key functions. This is triggered by touching multiple keys, e.g. if you touch the sensor with the palm of your hand.

#### Using the area function

If a key is pressed and another (different) key is touched within 0.2 seconds, the action set in the ETS is performed for the area operation (See Fig. 1 a) and b)). The keys are then blocked for 0.5 seconds.

#### Using the normal key function

If a key is pressed and no other key is touched within 0.2 seconds, the normal key function is enabled/provided for 5 seconds (See Fig. 1 c) and d)). This is extended for 5 seconds with each push of the button.

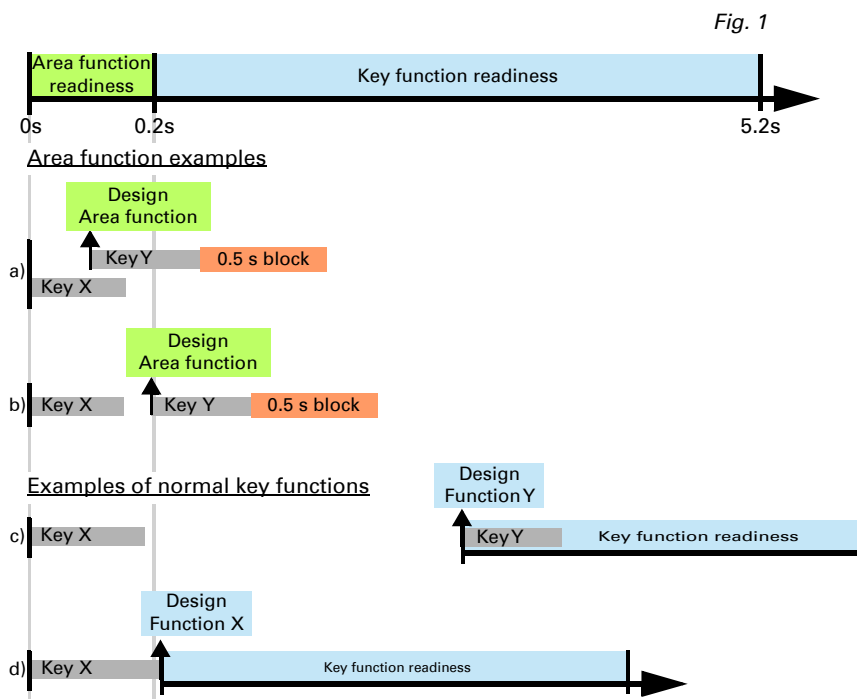

If the area function in the ETS is disabled, the keys can be used normally at any time.

## 1.1. Scope of delivery

- Push button in casing

- Base plate

*Additionally required (not included in the deliverables):*

- Junction box Ø 60 mm, 42 mm deep
- Frame (for insert 55 x 55 mm), compatible to the switch scheme used in the building

## 1.2. Technical specifications

Casing	Genuine glass, plastic
Colours	<ul style="list-style-type: none"> <li>• similar to RAL 9010 pure white</li> <li>• similar to RAL 9005 deep black</li> </ul>
Installation	Flush-mounted (wall installation in junction box Ø 60 mm, 42 mm deep or cavity wall socket for burr hole Ø 68 mm)
Degree of protection	IP 20
Dimensions	Housing approx. 55 x 55 (W x H, mm), Installation depth approx. 10 mm, Base plate approx. 71 x 71 (W x H, mm),
Total weight	approx. 50 g
Ambient temperature	Operating 0...+55°C, storage -30...+85°C
Ambient humidity	5...95% RH, avoid condensation
Operating voltage	KNX bus voltage
Bus current	max. 20 mA
Data output	KNX +/- Bus plug-in terminal
Group addresses	max. 167
Allocations	max. 167
Communication objects	Cala KNX T 201 Sunblind: 92 Cala KNX T 202 Sunblind: 98
Temperature measurement range	0...+55°C
Temperature resolution	0.1°C

The product conforms with the provisions of EU guidelines.

### 1.2.1. Accuracy of the measurement

Measurement variations from permanent sources of interference (see chapter *Installation position*) can be corrected in the ETS in order to ensure the specified accuracy of the sensor (offset).

When **measuring temperature**, the self-heating of the device is compensated.

---

## 2. Installation and commissioning

---

### 2.1. Installation notes

---



Installation, testing, operational start-up and troubleshooting should only be performed by an electrician.

---



#### **CAUTION!** **Live voltage!**

There are unprotected live components inside the device.

- National legal regulations are to be followed.
  - Ensure that all lines to be assembled are free of voltage and take precautions against accidental switching on.
  - Do not use the device if it is damaged.
  - Take the device or system out of service and secure it against unintentional use, if it can be assumed, that risk-free operation is no longer guaranteed.
- 

The device is only to be used for the intended purpose described in this manual. Any improper modification or failure to follow the operating instructions voids any and all warranty and guarantee claims.

After unpacking the device, check it immediately for possible mechanical damage. If it has been damaged in transport, inform the supplier immediately.

The device may only be used as a fixed-site installation; that means only when assembled and after conclusion of all installation and operational start-up tasks and only in the surroundings designated for it.

Elsner Elektronik is not liable for any changes in norms and standards which may occur after publication of these operating instructions.

### 2.2. Installation position

---

The **Cala KNX T 201/202 Sunblind push button** is designed for wall installation in a connector socket (Ø 60 mm, 42 mm deep).



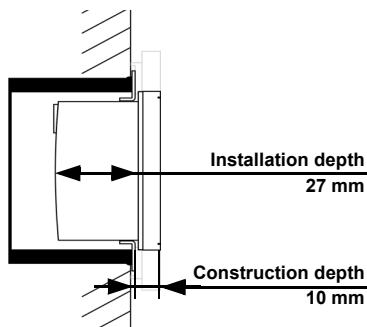

Fig. 2: Sectional drawing.

The **Cala KNX T 201/202 Sunblind push button** fits in a standard connector socket ( $\varnothing$  60 mm, depth 42 mm).

The frame is not included in the delivery!



**May be installed and operated in dry interior rooms only.  
Avoid condensation.**

When selecting an installation location, please ensure that the measurement results are affected as little as possible by external influences. Possible sources of interference include:

- Direct sunlight
- Drafts from windows and doors
- Draft from ducts which lead from other rooms or from the outside to the junction box in which the sensor is mounted
- Warming or cooling of the building structure on which the sensor is mounted, e.g. due to sunlight, heating or cold water pipes
- Connection lines and ducts which lead from warmer or colder areas to the sensor

Measurement variations from permanent sources of interference can be corrected in the ETS in order to ensure the specified accuracy of the sensor (offset).

## 2.3. Composition of the device

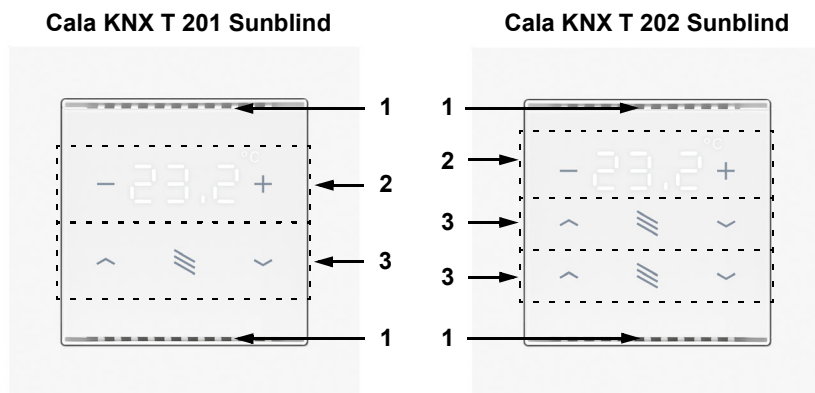

Fig. 3: Front

- 1 Ventilation slit (top and bottom)
- 2 „Temperature“ area with 2 touch surfaces and temperature display
- 3 „Sun protection/drive“ area with 2 touch surfaces per channel

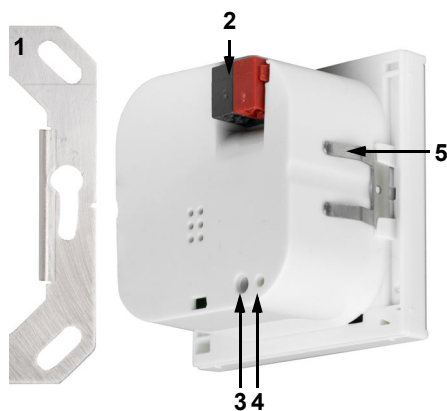

Fig. 4: Back

- 1 Base frame
- 2 KNX terminal BUS +/-
- 3 Programming button (recessed) for teaching the device
- 4 Programming LED (recessed)
- 5 Catches

## 2.4. Installation of the sensor

First install the windproof socket with feed line. Seal the inlet tubes as well, in order to prevent draughts.

Then screw the base plate to the socket and place the switch program frame. Connect the bus cable +/- to the plug (black-red).

Insert the device firmly onto the metal frame using the catches so that the device and the housing are fixed together.

## 2.5. Notes on mounting and commissioning

Never expose the device to water (e.g. rain) or dust. This can damage the electronics. You must not exceed a relative humidity of 95%. Avoid condensation.

After the bus voltage has been applied, the device will enter an initialisation phase lasting a few seconds. During this phase no information can be received or sent via the bus.

## 3. Addressing of the device at the bus

The device is supplied with the bus address 15.15.255. You can program another address into the ETS by overwriting the 15.15.255 address or by teaching via the programming button.

## 4. Display and operation at the device

### 4.1. Adjust room temperature (using the example Cala KNX T 201 Sunblind)

Depending on the setting of the "Display mode" parameter in the device application, the **Cala KNX T 201/202 Sunblind push button** displays the current room temperature value (or mixed value), the target value or the shift in relation to the basic setpoint. The display can be dimmed and switched off via the bus so that *no* value is displayed.

#### **Option A: Display of actual temperature (room temperature)**

The current room temperature is displayed. It is *not* possible to change the room temperature manually using the +/- buttons.

#### **Option B: Display of target temperature or basic setpoint shift**

Depending on the setting, the current target value or the shift relative to the base setpoint is displayed. The temperature can be changed by touching the +/- buttons.

**Target value** display (absolute value):

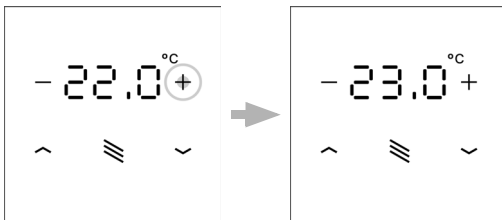

Tap +:  
Increase room temperature  
(target temperature is increased)

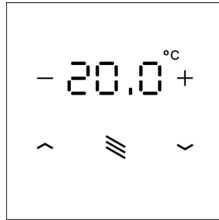
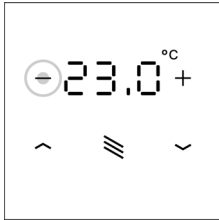

Tap -:  
Lower room temperature  
(target temperature is lowered)

Display of the **basic setpoint shift** (change compared to the basic setpoint of the control):

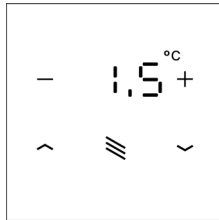
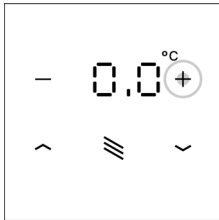

Tap +:  
Increase room temperature  
(Basic setpoint shift direction PLUS)

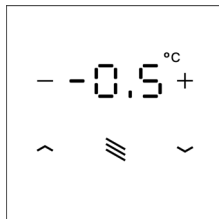
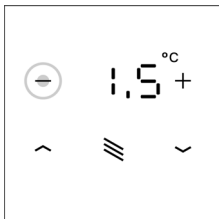

Tap -:  
Lower room temperature  
(Basic setpoint shift direction MINUS)

### **Option C: Display of actual temperature and target temperature/basic setpoint shift**

During normal operation, the current room temperature is displayed. By touching the buttons, the display jumps to the target temperature or to the basic setpoint shift, depending on the presetting. Changes with + or - are visible. The display returns to the room temperature if no button is touched for 7 seconds.

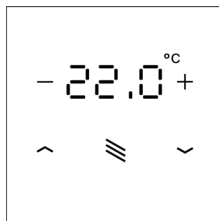

or

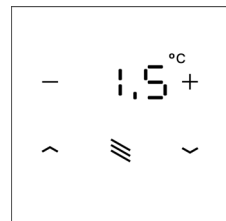

Touch the **+ or -** button briefly: The current **target temperature** (or the basic setpoint shift) is displayed.

Tap +: Increase room temperature  
(target temperature/basic setpoint shift is increased).

Tap -: Lower room temperature  
(target temperature/basic setpoint shift is lowered).

**General:**

The step size for the change and the possible setting range are defined in the device application (ETS). There you can also define whether the manually changed values are retained after a mode change (e.g. Eco mode overnight) or reset to the stored values.

The button functions can be locked due to operating mode with priority 1.

---

## 5. Maintenance

---

Ventilation slits must not be dirty or covered. As a rule, it is sufficient to wipe the device with a soft, dry cloth as required.

---

## 6. Disposal

---

After use, the device must be disposed of or recycled in accordance with the legal regulations. Do not dispose of it with the household waste!

## 7. Transmission protocol

### Units:

*Temperatures in degrees Celsius*

### 7.1. List of all communication objects

#### Abbreviations Flags:

*C* Communication

*R* Read

*W* Write

*T* Transmit

*U* Update

No	Text	Function	Flags	DPT type	Size
0	Software version	Output	R-CT	[217.1] DPT_Version	2 Bytes
20	Temperature sensor: malfunction	Output	R-CT	[1.1] DPT_Switch	1 Bit
21	Temperature sensor: measured value external	Input	-WCT	[9.1] DPT_Value_Temp	2 Bytes
22	Temperature sensor: measured value	Output	R-CT	[9.1] DPT_Value_Temp	2 Bytes
23	Temperature sensor: measured value total	Output	R-CT	[9.1] DPT_Value_Temp	2 Bytes
24	Temperature sensor: measured value min./max. query	Input	-WC-	[1.17] DPT_Trigger	1 Bit
25	Temperature sensor: measured value minimum	Output	R-CT	[9.1] DPT_Value_Temp	2 Bytes
26	Temperature sensor: measured value maximum	Output	R-CT	[9.1] DPT_Value_Temp	2 Bytes
27	Temperature sensor: measured value min./max. reset	Input	-WC-	[1.17] DPT_Trigger	1 Bit
30	Temp. thresholdV 1: Absolute value	Input / Output	RWCT	[9.1] DPT_Value_Temp	2 Bytes
31	Temp. thresholdV 1: (1:+   0:-)	Input	-WC-	[1.1] DPT_Switch	1 Bit
32	Temp. thresholdV 1: Switching delay from 0 to 1	Input	-WC-	[7.5] DPT_TimePeriod-Sec	2 Bytes
33	Temp. thresholdV 1: Switching delay from 1 to 0	Input	-WC-	[7.5] DPT_TimePeriod-Sec	2 Bytes
34	Temp. thresholdV 1: Switching output	Output	R-CT	[1.1] DPT_Switch	1 Bit
35	Temp. thresholdV 1: Switching output block	Input	-WC-	[1.1] DPT_Switch	1 Bit
36	Temp. thresholdV 2: Absolute value	Input / Output	RWCT	[9.1] DPT_Value_Temp	2 Bytes

No	Text	Function	Flags	DPT type	Size
37	Temp. thresholdV 2: (1:+   0:-)	Input	-WC-	[1.1] DPT_Switch	1 Bit
38	Temp. thresholdV 2: Switching delay from 0 to 1	Input	-WC-	[7.5] DPT_TimePeriod-Sec	2 Bytes
39	Temp. thresholdV 2: Switching delay from 1 to 0	Input	-WC-	[7.5] DPT_TimePeriod-Sec	2 Bytes
40	Temp. thresholdV 2: Switching output	Output	R-CT	[1.1] DPT_Switch	1 Bit
41	Temp. thresholdV 2: Switching output block	Input	-WC-	[1.1] DPT_Switch	1 Bit
50	Temp.control: HVAC mode (priority 1)	Input / Output	RWCT	depending on setting	1 Byte
51	Temp.control: HVAC mode (priority 2)	Input / Output	RWCT	depending on setting	1 Byte
52	Temp.control: Mode frost/heat protection activt.	Input	RWCT	[1.1] DPT_Switch	1 Bit
53	Temp.control: Block (1 = Blocking)	Input	-WC-	[1.1] DPT_Switch	1 Bit
54	Temp.control: Current setpoint	Output	R-CT	[9.1] DPT_Value_Temp	2 Bytes
55	Temp.control: Switch. (0: Heating   1: Cooling)	Input	-WC-	[1.1] DPT_Switch	1 Bit
56	Temp.control: Setpoint Comfort heating	Input / Output	RWCT	[9.1] DPT_Value_Temp	2 Bytes
57	Temp.control: Setpoint Comfort heat.(1:+   0:-)	Input	-WC-	[1.1] DPT_Switch	1 Bit
58	Temp.control: Setpoint Comfort cooling	Input / Output	RWCT	[9.1] DPT_Value_Temp	2 Bytes
59	Temp.control: Setpoint Comfort cool.(1:+   0:-)	Input	-WC-	[1.1] DPT_Switch	1 Bit
60	Temp.control: Basic 16-bit setpoint shift	Input	-WC-	[9.1] DPT_Value_Temp	2 Bytes
61	Temp.control: Setpoint Standby heating	Input / Output	RWCT	[9.1] DPT_Value_Temp	2 Bytes
62	Temp.control: Setpoint Standby heat.(1:+   0:-)	Input	-WC-	[1.1] DPT_Switch	1 Bit
63	Temp.control: Setpoint Standby cooling	Input / Output	RWCT	[9.1] DPT_Value_Temp	2 Bytes
64	Temp.control: Setpoint Standby cool. (1:+   0:-)	Input	-WC-	[1.1] DPT_Switch	1 Bit
65	Temp.control: Setpoint Eco heating	Input / Output	RWCT	[9.1] DPT_Value_Temp	2 Bytes
66	Temp.control: Setpoint Eco heating (1:+   0:-)	Input	-WC-	[1.1] DPT_Switch	1 Bit
67	Temp.control: Setpoint Eco cooling	Input / Output	RWCT	[9.1] DPT_Value_Temp	2 Bytes

No	Text	Function	Flags	DPT type	Size
68	Temp.control: Setpoint Eco cooling (1:+   0:-)	Input	-WC-	[1.1] DPT_Switch	1 Bit
69	Temp.control: Control variable heating (level 1)	Output	R-CT	[5.1] DPT_Scaling	1 Byte
70	Temp.control: Control variable heating (level 2)	Output	R-CT	[5.1] DPT_Scaling	1 Byte
71	Temp.control: Control variable cooling (level 1)	Output	R-CT	[5.1] DPT_Scaling	1 Byte
72	Temp.control: Control variable cooling (level 2)	Output	R-CT	[5.1] DPT_Scaling	1 Byte
73	Temperature control: Variable for 4/6-way valve	Output	R-CT	[5.1] DPT_Scaling	1 Byte
74	Temp.control: Status Heat. level 1 (1=ON 0=OFF)	Output	R-CT	[1.1] DPT_Switch	1 Bit
75	Temp.control: Status Heat. level 2 (1=ON 0=OFF)	Output	R-CT	[1.1] DPT_Switch	1 Bit
76	Temp.control: Status Cool. level 1 (1=ON 0=OFF)	Output	R-CT	[1.1] DPT_Switch	1 Bit
77	Temp.control: Status Cool. level 2 (1=ON 0=OFF)	Output	R-CT	[1.1] DPT_Switch	1 Bit
78	Temp.control: Comfort extension status	Input / Output	RWCT	[1.1] DPT_Switch	1 Bit
79	Temp.control: Comfort Extension time	Input	RWCT	[7.5] DPT_TimePeriod-Sec	2 Bytes
80	Temp. Controller: Fan coil levels 0 to 3	Output	R-CT	[5.1] DPT_Scaling	1 Byte
81	Temp. Controller: Fan coil level 1	Output	R-CT	[1.1] DPT_Switch	1 Bit
82	Temp. Controller: Fan coil level 2	Output	R-CT	[1.1] DPT_Switch	1 Bit
83	Temp. Controller: Fan coil level 3	Output	R-CT	[1.1] DPT_Switch	1 Bit
84	Temp. Controller: Fan coil auto=1 manual=0	Input / Output	RWCT	[1.1] DPT_Switch	1 Bit
86	All LEDs On/Off	Input	-WC-	[1.1] DPT_Switch	1 Bit
87	All LEDs Brightness	Input	-WC-	[5.1] DPT_Scaling	1 Byte
88	LEDs Temperature display On/Off	Input	-WC-	[1.1] DPT_Switch	1 Bit
89	LEDs Temperature display Block	Input	-WC-	[1.1] DPT_Switch	1 Bit
90	LED 1 on/off	Input	-WC-	[1.1] DPT_Switch	1 Bit
91	LED 1 Block	Input	-WC-	[1.1] DPT_Switch	1 Bit
92	LED 2 on/off	Input	-WC-	[1.1] DPT_Switch	1 Bit
93	LED 2 Block	Input	-WC-	[1.1] DPT_Switch	1 Bit



No	Text	Function	Flags	DPT type	Size
Only for Cala KNX T 202 Sunblind					
94	LED 3 on/off	Input	-WC-	[1.1] DPT_Switch	1 Bit
95	LED 3 Block	Input	-WC-	[1.1] DPT_Switch	1 Bit
96	LED 4 on/off	Input	-WC-	[1.1] DPT_Switch	1 Bit
97	LED 4 Block	Input	-WC-	[1.1] DPT_Switch	1 Bit
For all models					
99	Area operation on/off	Input	-WC-	[1.1] DPT_Switch	1 Bit
100	Area operation Output: Switch	Output	R-CT	depending on setting	2 Bytes
101	Drive 1 Long-term	Output	R-CT	[1.8] DPT_UpDown	1 Bit
102	Drive 1 Short-term	Output	R-CT	[1.10] DPT_Start	1 Bit
Only for Cala KNX T 202 Sunblind					
103	Drive 2 Long-term	Output	R-CT	[1.8] DPT_UpDown	1 Bit
104	Drive 2 Short-term	Output	R-CT	[1.10] DPT_Start	1 Bit
For all models					
107	Logic input 1	Input	-WC-	[1.2] DPT_Bool	1 Bit
108	Logic input 2	Input	-WC-	[1.2] DPT_Bool	1 Bit
109	Logic input 3	Input	-WC-	[1.2] DPT_Bool	1 Bit
110	Logic input 4	Input	-WC-	[1.2] DPT_Bool	1 Bit
111	Logic input 5	Input	-WC-	[1.2] DPT_Bool	1 Bit
112	Logic input 6	Input	-WC-	[1.2] DPT_Bool	1 Bit
113	Logic input 7	Input	-WC-	[1.2] DPT_Bool	1 Bit
114	Logic input 8	Input	-WC-	[1.2] DPT_Bool	1 Bit
117	AND logic 1: 1 bit switching output	Output	R-CT	[1.2] DPT_Bool	1 Bit
118	AND logic 1: 8 bit output A	Output	R-CT	depending on setting	1 Byte
119	AND logic 1: 8 bit output B	Output	R-CT	depending on setting	1 Byte
120	AND logic 1: Block	Input	-WC-	[1.1] DPT_Switch	1 Bit
121	AND logic 2: 1 bit switching output	Output	R-CT	[1.2] DPT_Bool	1 Bit
122	AND logic 2: 8 bit output A	Output	R-CT	depending on setting	1 Byte
123	AND logic 2: 8 bit output B	Output	R-CT	depending on setting	1 Byte
124	AND logic 2: Block	Input	-WC-	[1.1] DPT_Switch	1 Bit
125	OR logic 1: 1 bit switching output	Output	R-CT	[1.2] DPT_Bool	1 Bit
126	OR logic 1: 8 bit output A	Output	R-CT	depending on setting	1 Byte
127	OR logic 1: 8 bit output B	Output	R-CT	depending on setting	1 Byte
128	OR logic 1: Block	Input	-WC-	[1.1] DPT_Switch	1 Bit
129	OR logic 2: 1 bit switching output	Output	R-CT	[1.2] DPT_Bool	1 Bit

No	Text	Function	Flags	DPT type	Size
130	OR logic 2: 8 bit output A	Output	R-CT	depending on setting	1 Byte
131	OR logic 2: 8 bit output B	Output	R-CT	depending on setting	1 Byte
132	OR logic 2: Block	Input	-WC-	[1.1] DPT_Switch	1 Bit

## 8. Setting the parameters

### 8.1. Behaviour on power failure/ restoration of power

#### *Behaviour following a failure of the bus power supply:*

The device sends nothing.

#### *Behaviour on bus restoration of power and following programming or reset:*

The device sends all outputs according to their send behaviour set in the parameters with the delays established in the "General settings" parameter block.

### 8.2. General settings

Set the basic properties of the data transmission.

Transmission delay after reset/bus restoration	<u>5 s</u> • ... • 300 s
Maximum message rate	<ul style="list-style-type: none"> <li>• 1 message per second</li> <li>• ...</li> <li>• <u>10 messages per second</u></li> <li>• ...</li> <li>• 50 messages per second</li> </ul>

### 8.3. Temperature measured value

Select, whether a **malfunction object** is to be sent if the sensor is faulty.

Use malfunction object	<u>No</u> • Yes
------------------------	-----------------

Use **Offsets** to adjust the readings to be sent.

Offset in 0.1°C	-50...50; <u>0</u>
-----------------	--------------------

The unit can calculate a **mixed value** from its own reading and an external value. Set the mixed value calculation if desired. If an external portion is used, all of the following settings (threshold values, etc.) are related to the overall reading.

Use external measured value	<u>No</u> • Yes
Ext. Reading proportion of the total reading	5% • 10% • ... • <u>50%</u> • ... • 100%

Sending pattern for internal and total measured value	<ul style="list-style-type: none"> <li>• never</li> <li>• periodically</li> <li>• on change</li> <li>• on change and periodically</li> </ul>
At and above change of (if sent on change)	0.1°C • 0.2°C • <u>0.5°C</u> • ... • 5.0°C
Send cycle (if sent periodically)	5 s • <u>10 s</u> • ... • 2 h

The **minimum and maximum readings** can be saved and sent to the bus. Use the "Reset temperature min/max. value" objects to reset the values to the current readings. The values are not retained after a reset.

Use minimum and maximum value	<u>No</u> • Yes
-------------------------------	-----------------

## 8.4. Temperature threshold values

Activate the required temperature threshold values. The menus for the further setting of the threshold values are then displayed.

Use threshold value 1 / 2	Yes • <u>No</u>
---------------------------	-----------------

### 8.4.1. Threshold value 1, 2

#### Threshold value

Decide in which cases **threshold values and delay times** received are to be kept per object. The parameter is only taken into consideration if the setting by object is activated further down. Please note that the setting "After power restoration and programming" should not be used for the initial start-up, as the factory settings are always used until the first call (setting via objects is ignored).

Maintain the threshold values and delays received via communication objects	<ul style="list-style-type: none"> <li>• never</li> <li>• after power supply restoration</li> <li>• after power supply restoration and programming</li> </ul>
---	---

Set the threshold values directly in the application program using parameters, or define them via the bus using a communication object.

#### **Threshold value setpoint using parameter:**

Set the threshold values and hysteresis directly.

Threshold value setpoint using	<b>Parameter</b> • Communication objects
Threshold in 0.1°C	-300... 800; <u>200</u>

**Threshold value setpoint using a communication object:**

Beforehand, enter how the threshold value will be received from the bus. Basically, a new value can be received, or simply a command to increase or decrease.

During initial commissioning, a threshold value must be defined which will be valid until the first call with a new threshold value. For units which have already been taken into service, the last communicated threshold value can be used. Basically, a temperature range is given in which the threshold value can be changed (object value limit).

A set threshold value will be retained until a new value or a change is transferred. The current value is saved in so that it is retained in the event of a power supply failure and will be available again once the power supply is restored.

Threshold value setpoint using	Parameter • <b>Communication objects</b>
Start threshold value in 0.1°C valid until first Communication	-300 ... 800; <u>200</u>
Object value limit (min) in 0.1°C	<u>-300</u> ...800
Object value limit (max) in 0.1°C	-300... <u>800</u>
Type of threshold value change	<u>Absolute value</u> • Increase/decrease
Interval (upon increase/decrease change)	<u>0.1 °C</u> • ... • 5°C

Set the **hysteresis** independently of the type of threshold value setting.

Hysteresis setting	in % • <u>absolute</u>
Hysteresis in % of the threshold value	0 ... 50; <u>20</u>
Hysteresis in 0.1°C	0 ... 1100; <u>50</u>

**Switching output**

Set the behaviour of the switching output when a threshold value is exceeded/undercut. The output switching delay can be set using objects or directly as a parameter.

When the following conditions apply, the output is (TV = Threshold value)	<ul style="list-style-type: none"> <li>• <u>TV above = 1   TV - Hyst. below = 0</u></li> <li>• <u>LV above = 0   LV - hysteresis below = 1</u></li> <li>• <u>TV below = 1   TV + hysteresis above = 0</u></li> <li>• <u>TV below = 0   TV + hysteresis above = 1</u></li> </ul>
Delays can be set via objects (in seconds)	<u>No</u> • Yes
Switching delay from 0 to 1 (if delay is adjustable via objects: valid until 1st communication)	<u>None</u> • 1 s • 2 s • 5 s • 10 s • ... • 2 h
Switching delay from 1 to 0 (if delay is adjustable via objects: valid until 1st communication)	<u>None</u> • 1 s • 2 s • 5 s • 10 s • ... • 2 h

Switching output sends	<ul style="list-style-type: none"> <li>• <u>on change</u></li> <li>• on change to 1</li> <li>• on change to 0</li> <li>• on change and periodically</li> <li>• on change to 1 and periodically</li> <li>• on change to 0 and periodically</li> </ul>
Cycle <i>(is sent only if "periodically" is selected)</i>	<u>5 s</u> • 10 s • 30 s... • 2 h

## Block

The switching output can be blocked using an object.

Use switching output block	<u>No</u> • Yes
----------------------------	-----------------

Set the cases in which threshold values and delay times received per object are to be retained.

Assessment of the block object	<ul style="list-style-type: none"> <li>• <u>At value 1: block   At value 0: release</u></li> <li>• At value 0: block   At value 1: release</li> </ul>
Blocking object value before first Communication	<u>0</u> • 1
Switching output behaviour	
On blocking	<ul style="list-style-type: none"> <li>• <u>Do not send message</u></li> <li>• 0 Send</li> <li>• 1 Send</li> </ul>
On release (with 2 second release delay)	[Dependent on the "Switching output sends" setting]

The behaviour of the switching output on release is dependent on the value of the parameter "Switching output sends" (see "Switching output")

Switching output sends on change	<ul style="list-style-type: none"> <li>• Do not send message</li> <li>• Send switching output status</li> </ul>
Switching output sends on change to 1	<ul style="list-style-type: none"> <li>• Do not send message</li> <li>• if switching output = 1 → send 1</li> </ul>
Switching output sends on change to 0	<ul style="list-style-type: none"> <li>• Do not send message</li> <li>• if switching output = 0 → send 0</li> </ul>
Switching output sends on change and periodically	Send switching output status
Switching output sends on change to 1 and periodically	if switching output = 1 → send 1
Switching output sends on change to 0 and periodically	if switching output = 0 → send 0

## 8.5. Temperature PI controller

Activate the controller if you want to use it.

Use controller	<u>No</u> • Yes
----------------	-----------------

## General rules

Decide in which cases **nominal values and delay times** received per object are to be kept. The parameter is only taken into consideration if the setting by object is activated further down. Please note that the setting "After power restoration and programming" should not be used for the initial start-up, as the factory settings are always used until the first call (setting via objects is ignored).

For an adequate regulation of the indoor temperature, comfort, standby, eco and building protection modes may be used.

**Comfort** when present,

**Standby** when absent,

**Eco** as a night-time mode and

**Frost / heat protection** (building protection) e.g. when the window is open.

The settings for the temperature control include the setpoint temperatures for the individual modes. Objects are used to determine which mode is to be selected. A change of mode may be triggered manually or automatically (e.g. by a timer, window contact).

The **mode** may be switched with two 8 bit objects of different priority. Objects

„... HVAC mode (Prio 2)“ for switching in everyday operation and

„... HVAC mode (Prio 1)“ for central switching with higher priority.

The objects are coded as follows:

0 = Auto

1 = Comfort

2 = Standby

3 = Eco

4 = Building protection

Alternatively, you can use three objects, with one object switching between eco and standby mode and the two others are used to activate comfort mode or frost/heat protection mode. The comfort object then blocks the eco/standby object, and frost/heat protection objects have the highest priority. Objects

„... Mode (1: Eco, 0: Standby)“,

„... comfort activation mode" and

„... frost/heat protection activation mode"

Switch mode via	<ul style="list-style-type: none"> <li>• two 8-bit objects (HVAC modes)</li> <li>• three 1-bit objects</li> </ul>
-----------------	---

Select the **mode to be activated after reset** (e.g. power failure, reset of the line via the bus). (Default).

Then configure a temperature control **block** using the blocking object.

Mode after reset	<ul style="list-style-type: none"> <li>• <u>Comfort</u></li> <li>• Standby</li> <li>• Eco</li> <li>• Building protection</li> </ul>
Behaviour of the blocking object with value	<ul style="list-style-type: none"> <li>• <u>1 = Block   0 = release</u></li> <li>• 0 = block   1 = release</li> </ul>
Value of the blocking object after reset	<u>0</u> • 1

Specify when the current **control variables** are to be **sent** to the bus. Periodic transmission is safer if a message does not reach a recipient. You may also set up periodical monitoring by the actuator with this setting.

Send control variable	<ul style="list-style-type: none"> <li>• <u>on change</u></li> <li>• on change and periodically</li> </ul>
from change of (in % absolute)	1...10; <u>2</u>
Cycle (if sent periodically)	5 s • ... • <u>5 min</u> • ... • 2 h

The **status object** reports the current status of the output (0 = OFF, 0 = ON) and may for example be used for visualisation, or to switch off the heating pump as soon as the heating is switched off.

Send status objects	<ul style="list-style-type: none"> <li>• <u>on change</u></li> <li>• on change to 1</li> <li>• on change to 0</li> <li>• on change and periodically</li> <li>• on change to 1 and periodically</li> <li>• on change to 0 and periodically</li> </ul>
Cycle (if sent periodically)	5 s • ... • <u>5 min</u> • ... • 2 h

Then define the **type of setting**. Heating and/or cooling may be controlled in two stages.

Type of control	<ul style="list-style-type: none"> <li>• <u>Single stage heating</u></li> <li>• Dual-stage heating</li> <li>• Single-stage cooling</li> <li>• Single-stage heating + single-stage cooling</li> <li>• Dual-stage heating + single-stage cooling</li> <li>• Dual-stage heating + dual-stage cooling</li> </ul>
-----------------	--

## General setpoint values

You may enter separate setpoint values for each mode or use the comfort setpoint as a basic value.

If you are using the controls for both heating *and* cooling, you may also select the setting "separately with switching object". Systems used for cooling in the summer and for heating in the winter can thus be switched from one to the other.

If you are using the basic value, only the deviation from the comfort setpoint value is listed for the other modes (e. g., 2°C less for standby mode).

Keep modified setpoints after mode change	No • <u>Yes</u>
Setting the nominal values	<ul style="list-style-type: none"> <li>• <u>separate with switching object</u></li> <li>• separate without switching object</li> <li>• with comfort setpoint as a basis with switching object</li> <li>• with comfort setpoint as a basis without switching object</li> </ul>

Analysis of the status object / Behaviour of the switching object at value	<ul style="list-style-type: none"> <li>• <u>0</u> = Heating   1 = Cooling</li> <li>• 1 = Heating   0 = Cooling</li> </ul>
Switching object value before first Communication (only if switching object is used)	<u>0</u> • 1

The **grades** for the setpoint changes is predefined. Whether the change remains active only temporarily (do not store) or remains stored even after restoration of power (and programming) is determined in the first section of "General controller". This also applies to a comfort extension.

Grading for setpoint changes (in 0.1 °C)	1... 50; <u>10</u>
Storage of setpoint(s)	<ul style="list-style-type: none"> <li>• not be retained</li> <li>• <u>after power restoration</u></li> <li>• after restoration of power and programming</li> </ul>

The controller can be switched from eco mode, i.e. night mode, to comfort mode via the comfort extension. This means that the comfort setpoint can be maintained for longer, for example when having guests. The duration of this comfort extension period is set. After the comfort extension period is terminated, the system returns to eco mode.

Comfort extension time in seconds (can only be activated from eco mode)	1...36000; <u>3600</u>
--	------------------------

## Setpoint Comfort

Comfort mode is usually used for daytime mode when people are present. A starting value is defined for the comfort setpoint as well as a temperature range in which the nominal value may be modified.

Initial heating/cooling setpoint (in 0.1 °C) valid until first Communication (not upon saving the target value after programming)	-300...800; <u>210</u>
---	------------------------

### **If setpoint values are entered separately:**

Min. object value heating/cooling (in 0.1 °C)	-300...800; <u>160</u>
Max. object value heating/cooling (in 0.1 °C)	-300...800; <u>280</u>

### **If the comfort setpoint value is used as a basis:**

If the comfort setpoint is used as the basis, the increase/decrease of this value is indicated.

Minimum base setpoint (in 0.1°C)	-300...800; <u>160</u>
Maximum base setpoint (in 0.1°C)	-300...800; <u>280</u>



Reduction by up to (in 0.1°C)	1...100; <u>50</u>
Increase by up to (in 0.1°C)	1...100; <u>50</u>

If the comfort setpoint is used as the basis, a dead zone is determined for the control mode "heating *and* cooling" to avoid direct switching from heating to cooling.

Dead zone between heating and cooling (only if both heating AND cooling are used)	1...100; <u>50</u>
--	--------------------

## Setpoint for standby

Standby mode is usually used for daytime mode when people are absent.

### ***If setpoint values are entered separately:***

A starting setpoint value is defined as well as a temperature range in which the setpoint value may be changed.

Heating initial setpoint (in 0.1 °C) valid until first Communication	-300...800; <u>180</u>
Cooling initial setpoint (in 0.1 °C) valid until first Communication	-300...800; <u>240</u>
Min. object value heating/cooling (in 0.1 °C)	-300...800; <u>160</u>
Max. object value heating/cooling (in 0.1 °C)	-300...800; <u>280</u>

### ***If the comfort setpoint value is used as a basis:***

If the comfort setpoint is used as the basis, the increase/decrease of this value is indicated.

Reduce heating setpoint (in 0.1°C) (for heating)	0...200; <u>30</u>
Increase cooling setpoint (in 0.1°C) (for cooling)	0...200; <u>30</u>

## Eco setpoint

Eco mode is usually used for night mode.

### ***If setpoint values are entered separately:***

A starting setpoint value is defined as well as a temperature range in which the setpoint value may be changed.

Heating initial setpoint (in 0.1 °C) valid until first Communication	-300...800; <u>160</u>
Cooling initial setpoint (in 0.1 °C) valid until first Communication	-300...800; <u>280</u>
Min. object value heating/cooling (in 0.1 °C)	-300...800; <u>160</u>

Max. object value heating/cooling (in 0.1 °C)	-300...800; <u>280</u>
---	------------------------

**If the comfort setpoint value is used as a basis:**

If the comfort setpoint is used as the basis, the increase/decrease of this value is indicated.

Reduce heating setpoint (in 0.1°C) (for heating)	0...200; <u>50</u>
Increase cooling setpoint (in 0.1°C) (for cooling)	0...200; <u>60</u>

**Setpoint values for frost/heat protection (building protection)**

The building protection mode is used, for example, as long as windows are open for ventilation. Setpoints for frost protection (heating) and heat protection (cooling) are determined which may not be modified from outside (no access via operating devices etc.). The building protection mode may be activated with delay, which allows you to leave the building before the controls switch to frost/heat protection mode.

Nominal value frost protection (in 0,1°C)	-300...800; <u>70</u>
Activation delay	no • 5 s • ... • <u>5 min</u> • ... • 2 h
Nominal value heat protection (in 0,1°C)	-300...800; <u>350</u>
Activation delay	no • 5 s • ... • <u>5 min</u> • ... • 2 h

**General variables**

This setting appears for the control types "Heating and Cooling" only. This is where you can decide whether to use a common variable for heating and cooling. If the 2nd stage has a common variable, this is also where you determine the control mode of the 2nd stage.

For heating and cooling	<ul style="list-style-type: none"> <li>• <u>separate variables are used</u></li> <li>• common variables are used for Stage 1</li> <li>• common variables are used for Stage 2</li> <li>• common variables are used for Stage 1+2</li> </ul>
Use variable for 4/6-way valve (only with common variable at stage1)	<u>No</u> • Yes
Control type (for stage 2 only)	<ul style="list-style-type: none"> <li>• <u>2-point-control</u></li> <li>• PI control</li> </ul>
Regulating variable of the 2nd Stage is on (only for stage 2 with 2-point control)	<ul style="list-style-type: none"> <li>• 1-bit object</li> <li>• <u>8-bit object</u></li> </ul>

When using the variable for a 4/6 way valve:

0%...100% Heating = 66%...100% variable

OFF = 50% variable

0%...100% Cooling = 33%...0% variable

### 8.5.1. Heating control stage 1/2

If a heating control mode is configured, one or two setting sections for the heating stages are displayed.

In the first stage, heating is controlled by a PI controller which allows to either enter control parameters or select predetermined applications.

In the second stage (therefore only in case of 2-stage heating), heating is controlled via a PI or a 2-point-control.

In stage 2, the setpoint deviation between the two stages must also be specified, i.e. beyond which setpoint undershoot the second stage is then added.

Setpoint difference between stages 1 and 2 stages (in 0.1°C) ( <i>At stage 2</i> )	0...100; <u>40</u>
Control type ( <i>at stage 2, no common variables</i> )	<ul style="list-style-type: none"> <li>• 2-point-control</li> <li>• PI control</li> </ul>
Control variable is on ( <i>for stage 2 with 2-point control, no common variables</i> )	<ul style="list-style-type: none"> <li>• 1-bit object</li> <li>• 8-bit object</li> </ul>

#### **PI controller with control parameters:**

This setting allows individual input of the parameters for PI control.

Control type	• <b>PI control</b>
Setting of the controller by	<ul style="list-style-type: none"> <li>• <b>Controller parameter</b></li> <li>• specified applications</li> </ul>

Specify the deviation from the setpoint value at which the maximum control variable value is reached, i.e. the point at which maximum heating power is activated.

The reset time shows how quickly the controller responds to deviations from the setpoint. In case of a short reset time, the control responds with a fast increase of the control variable. In case of a long reset time, the control responds somewhat less urgently and needs longer until the necessary control variable for the setpoint deviation is reached.

You should set the time appropriate to the heating system at this point (observe manufacturer's instructions).

Maximum control variable is reached at setpoint/actual difference of (in °C)	1... <u>5</u>
Reset time (in min.)	1...255; <u>30</u>

Now specify what should be sent when the control is blocked. Set a value greater 0 (=OFF) to receive a basic heating stage, e.g. for floor heating.

On release, the control variable follows the rule again.

When blocked, the control variable should	<ul style="list-style-type: none"> <li>• <u>not be sent</u></li> <li>• send a specific value</li> </ul>
Value (in %) ( <i>only if a value is sent</i> )	<u>0</u> ...100

In case of a common control variable for heating and cooling, 0 is always transmitted as a fixed value.

### **PI control with predetermined application:**

This setting provides fixed parameters for frequent applications.

Control type	• <b>PI control</b>
Setting of the controller by	• Controller parameter • <b>specified applications</b>
Application	• Warm water heating • Floor heating • Convection unit • Electric heating
Maximum control variable is reached at setpoint/actual difference of (in °C)	Warm water heating: 5 Floor heating: 5 Convection unit: 4 Electric heating: 4
Reset time (in min.)	Warm water heating: 150 Floor heating: 240 Convection unit: 90 Electric heating: 100

Now specify what should be sent when the control is blocked. Set a value greater 0 (=OFF) to receive a basic heating stage, e.g. for floor heating.

On release, the control variable follows the rule again.

When blocked, the control variable should	• not be sent • send a specific value
Value (in %) (only if a value is sent)	<u>0</u> ...100

In case of a common control variable for heating and cooling, 0 is always transmitted as a fixed value.

### **2-point-control (only stage 2):**

2-point-control is used for systems which are only set to ON or OFF.

Control type (is determined at a higher stage for common variables)	• <b>2-point-control</b>
--	--------------------------

Enter the hysteresis that prevents frequent on/off switching of temperatures in the threshold range.

Hysteresis (in 0.1°C)	0...100; <u>20</u>
-----------------------	--------------------

If separate variables are used, select whether the variable of the 2nd stage is a 1-bit object (on/off) or an 8-bit object (on with percentage value/off).

Control variable is on	<ul style="list-style-type: none"> <li>• <u>1-bit object</u></li> <li>• 8-bit object</li> </ul>
Value (in %) <i>(for 8-bit object)</i>	0... <u>100</u>

Now specify what should be sent when the control is blocked. Set a value greater 0 (=OFF) to receive a basic heating stage, e.g. for floor heating. On release, the control variable follows the rule again.

When blocked, the control variable should	<ul style="list-style-type: none"> <li>• not be sent</li> <li>• send a specific value</li> </ul>
Value (in %) <i>only if a value is sent</i>	<u>0</u> ...100

## 8.5.2. Cooling control stage 1/2

If a cooling control mode is configured, one or two setting sections for the cooling levels are displayed.

In the first stage, cooling is controlled by a PI controller in which either control parameters or predetermined applications can be selected.

In the second stage (therefore only if for 2-stage cooling), cooling is controlled via a PI or a 2-point-control.

In stage 2, the setpoint deviation between the two stages must also be specified, i.e. beyond which setpoint value undershoot the second stage is then added.

Setpoint difference between stages 1 and 2 stages (in 0.1°C) <i>(At stage 2)</i>	0...100; <u>40</u>
Control type <i>(at stage 2, no common variables)</i>	<ul style="list-style-type: none"> <li>• 2-point-control</li> <li>• PI control</li> </ul>
Control variable is on <i>(for stage 2 with 2-point control, no common variables)</i>	<ul style="list-style-type: none"> <li>• <u>1-bit object</u></li> <li>• 8-bit object</li> </ul>

### **PI controller with control parameters:**

This setting allows individual input of the parameters for PI control.

Control type	<ul style="list-style-type: none"> <li>• <b>PI control</b></li> </ul>
Setting of the controller by	<ul style="list-style-type: none"> <li>• <b>Controller parameter</b></li> <li>• specified applications</li> </ul>

Specify the deviation from the setpoint value which reaches maximum variable value, i.e. the point at which maximum cooling power is activated.

The reset time shows how quickly the controller responds to deviations from the setpoint. In case of a short reset time, the control responds with a fast increase of the control variable. In case of a long reset time, the control responds somewhat less urgently and needs longer until the necessary control variable for the setpoint deviation is

reached. You should set the time appropriate to the cooling system at this point (observe manufacturer's instructions).

Maximum control variable is reached at setpoint/actual difference of (in °C)	1... <u>5</u>
Reset time (in min.)	1...255; <u>30</u>

Now specify what should be sent when the control is blocked.

On release, the control variable follows the rule again.

When blocked, the control variable should	<ul style="list-style-type: none"> <li>• <u>not be sent</u></li> <li>• send a specific value</li> </ul>
Value (in %) (only if a value is sent)	<u>0</u> ...100

In case of a common control variable for heating and cooling, 0 is always transmitted as a fixed value.

### **PI control with predetermined application:**

This setting provides fixed parameters for a cooling ceiling

Control type	• <b>PI control</b>
Setting of the controller by	<ul style="list-style-type: none"> <li>• Controller parameter</li> <li>• <b>specified applications</b></li> </ul>
Application	• Cooling ceiling
Maximum control variable is reached at setpoint/actual difference of (in °C)	Cooling ceiling: 5
Reset time (in min.)	Cooling ceiling: 30

Now specify what should be sent when the control is blocked.

On release, the control variable follows the rule again.

When blocked, the control variable should	<ul style="list-style-type: none"> <li>• not be sent</li> <li>• send a specific value</li> </ul>
Value (in %) (only if a value is sent)	<u>0</u> ...100

### **2-point-control (only stage 2):**

2-point-control is used for systems which are only set to ON or OFF.

Control type <i>is determined at a higher stage for common variables</i>	• <b>2-point-control</b>
---	--------------------------

Enter the hysteresis that prevents frequent on/off switching of temperatures in the threshold range.

Hysteresis (in 0.1°C)	0...100; <u>20</u>
-----------------------	--------------------

If separate variables are used, select whether the variable of the 2nd stage is a 1-bit object (on/off) or an 8-bit object (on with percentage value/off).

Control variable is on	<ul style="list-style-type: none"> <li>• <u>1-bit object</u></li> <li>• <u>8-bit object</u></li> </ul>
Value (in %) <i>(for 8-bit object)</i>	<u>0...100</u>

Now specify what should be sent when the control is blocked.  
On release, the control variable follows the rule again.

When blocked, the control variable should	<ul style="list-style-type: none"> <li>• <u>not be sent</u></li> <li>• <u>send a specific value</u></li> </ul>
Value (in %) <i>(only if a value is sent)</i>	<u>0...100</u>

In case of a common control variable for heating and cooling, 0 is always transmitted as a fixed value.

## 8.6. LEDs

Set the LED mode.

LED mode	<ul style="list-style-type: none"> <li>• All LEDs off</li> <li>• <u>All LEDs as ambient lighting</u></li> <li>• All LEDs individually controllable</li> </ul>
----------	---

### **All LEDs as ambient lighting**

If all LEDs are to be used as ambient lighting, illuminate all simultaneously. Set the brightness of the LEDs, whether objects are used and whether the LEDs switch off automatically after pushing the button.

LED mode	All LEDs as ambient lighting
Brightness	0 ... 100%; <u>30%</u>
Use objects	<u>No</u> • Yes
Object value on/off after reset <i>(if objects are used)</i>	0 • <u>1</u>
Use automatic switch-off after pressing a button	No • <u>Yes</u>
Switch off after <i>(is automatic switch off is used)</i>	1 ... 255; <u>30 secs. after pressing</u>
LEDs for temperature display	<ul style="list-style-type: none"> <li>• display actual value only</li> <li>• display only target value/base shift</li> <li>• <u>display actual value and target value/base shift</u></li> </ul>

### All LEDs individually controllable

This is where you set the brightness of the LEDs, whether objects are used, whether the LEDs switch off automatically after pushing the button and what the LEDs for temperature display should indicate.

LED mode	All LEDs individually controllable
Brightness	0 ... 100%; <u>30%</u>
Use objects	<u>No</u> • Yes
Object value on/off after reset (if objects are used)	0 • <u>1</u>
Function LEDs for temperature display	<ul style="list-style-type: none"> <li>• always OFF</li> <li>• <u>On after pressing button for settable time</u></li> <li>• On for object value = 1 / Off for object value = 0</li> </ul>
Lighting period after pressing (if "On after pressing button for a settable time")	1 ... 5 seconds ; <u>3 seconds</u>
Object value after reset (if "On for object value = 1 / Off for object value = 0)	0 • <u>1</u>
Use block object (if "On for object value = 1 / Off for object value = 0)	<u>No</u> • Yes
LEDs for temperature display	<ul style="list-style-type: none"> <li>• display actual value only</li> <li>• display only target value/base shift</li> <li>• <u>display actual value and target value/base shift</u></li> </ul>
Function LED 1 (top left) / 2 (top right) / 3 (bottom left) / 4 (bottom right) [LED 3 and 4 only for Cala KNX T 202 Sunblind]	<ul style="list-style-type: none"> <li>• always OFF</li> <li>• <u>On after pressing button for settable time</u></li> <li>• On for object value = 1 / Off for object value = 0</li> </ul>
Lighting period after pressing (if "On after pressing button for a settable time")	1 ... 5 seconds ; <u>3 seconds</u>
Object value after reset (if "On for object value = 1 / Off for object value = 0)	0 • <u>1</u>
Use block object (if "On for object value = 1 / Off for object value = 0)	<u>No</u> • Yes

## 8.7. Buttons

**Cala KNX T 201/202 Sunblind** has an area control, i.e. if you touch 2 or more buttons at the same time, you can activate another function. The value (0 or 1) can be set for the evaluation of the activation of the surface operation.

Set whether you want to use the screen control.

Use screen control	<u>No</u> • Yes
Use screen control	Yes
Activation object assessment	<ul style="list-style-type: none"> <li>• <u>Value 1 = active   Value 0 = inactive</u></li> <li>• Value 0 = active   Value 1 = inactive</li> </ul>



Object value after reset	0 • <u>1</u>
Function	<ul style="list-style-type: none"> <li>• <u>Switch</u></li> <li>• Selector switch</li> <li>• 8 bit value 0 ... 255</li> <li>• 8 bit value 0 ... 100%</li> <li>• 16-bit floating point value</li> <li>• Scenario recall</li> </ul>
Value (switch)	0 • <u>1</u>
Value (8 bit value 0 ... 255)	0 • ... • <u>255</u>
Value (8 bit value 0 ... 100%)	0 • ... • <u>100</u>
Value in 0.1 (16 bit value floating point)	-6707600 • ... • 6707600; <u>10</u>
Scenario number(Scenario recall)	<u>1</u> • ... • 64

Activate the required drive. The menus for further adjustment of the drive will then be displayed.

Use drive line	<u>No</u> • Yes
----------------	-----------------

---

**The Cala KNX T 202 Sunblind has 2 drives that can be activated.**

---

### 8.7.1. Drive

---

If the push-button is used to control a drive, select the "blind", "awning", "shutter" or "window" function and define the push-button function and control mode.

#### **Blind**

Function	<b>Shutter</b>
Swap Up/Down	<u>No</u> • Yes
Control mode	<ul style="list-style-type: none"> <li>• <u>Standard</u></li> <li>• <u>Standard inverted</u></li> <li>• Comfort mode</li> <li>• Dead man switch</li> </ul>

Standard:

Behaviour for button actuation (up): short = Stop/Step   long = Up	
Behaviour for button actuation (down): short = Stop/Step   long = Down	
Time between tap and hold (0.1 sec)	0 ... 50; <u>10</u>

Standard inverted:

Behaviour for button actuation (up): long = Stop/Step   short = Up	
Behaviour for button actuation (down): short = Stop/Step   long = Down	
Time between tap and hold (0.1 sec)	0 ... 50; <u>10</u>
Repetition of the step command upon extended button press	none • every 0.1 s • ... • <u>every 0.5 s</u> • ... • every 2 s

## Comfort mode:

Push-button is pressed and	
released before expiry of Time 1	Stop/Step
Maintained for longer than Time 1	Up   Down
Triggered between Times 1 and 1 + 2	Stop
Triggered after Times 1 + 2	No more stop
Time 1 (in 0.1 sec)	0 ... 50; <u>4</u>
Time 2 (in 0.1 sec)	0 ... 50; <u>20</u>

## Dead man switch:

Press button	Up   Down command
Release button	Stop command

**Shutter**

Function	<b>Shutters</b>
Swap Up/Down	<u>No</u> • Yes
Control mode	<ul style="list-style-type: none"> <li>• Standard</li> <li>• Standard inverted</li> <li>• Comfort mode</li> <li>• Dead man switch</li> </ul>

## Standard:

Behaviour for button actuation (up): short = Stop   long = Up	
Behaviour for button actuation (down): short = Stop   long = Down	
Behaviour for button actuation (up/down): short = Stop   long = Up/Down	
Time between tap and hold (0.1 sec)	0 ... 50; <u>10</u>

## Standard inverted:

Behaviour for button actuation (up): long = Stop   short = Up	
Behaviour for button actuation (down): short = Stop   long = Down	
Behaviour for button actuation (up/down): short = Stop/Step   long = Up/Down	
Time between tap and hold (0.1 sec)	0 ... 50; <u>10</u>
Repetition of the step command upon extended button press (only for up)	none • every 0.1 s • ... • <u>every 0.5 s</u> • ... • every 2 s

## Comfort mode:

Push-button is pressed	
released before expiry of Time 1	Stop
Maintained for longer than Time 1	Up   Down   Up/Down
Triggered between Times 1 and 1 + 2	Stop
Triggered after Times 1 + 2	No more stop
Time 1 (in 0.1 sec)	0 ... 50; <u>4</u>
Time 2 (in 0.1 sec)	0 ... 50; <u>20</u>

## Dead man switch:

Press button	Up   Down   Up/Down command
Release button	Stop command

### **Awning**

Function	<b>Awning</b>
Swap Retract/Extend	<u>No</u> • Yes
Control mode	<ul style="list-style-type: none"> <li>• <u>Standard</u></li> <li>• Standard inverted</li> <li>• Comfort mode</li> <li>• Dead man switch</li> </ul>

#### Standard:

Behaviour for button actuation (retract): short = Stop   long = Retract	
Behaviour for button actuation (extend): short = Stop   long = Extend	
Behaviour for button actuation (retract/extend): short = Stop   long = Extend/Retract	
Time between tap and hold (0.1 sec)	0 ... 50; <u>10</u>

#### Standard inverted:

Behaviour for button actuation (retract): long = Stop   short = Retract	
Behaviour for button actuation (extend): long = Stop   short = Extend	
Behaviour for button actuation (retract/extend): hold = long   stop = Extend/Retract	
Time between tap and hold (0.1 sec)	0 ... 50; <u>10</u>
Repetition of the step command upon extended button press (only for up)	none • every 0.1 s • ... • <u>every 0.5 s</u> • ... • every 2 s

#### Comfort mode:

Push-button is pressed and released before expiry of Time 1	
Maintained for longer than Time 1	Stop Retract • Extend • Retract/Extend
Triggered between Times 1 and 1 + 2	Stop
Triggered after Times 1 + 2	No more stop
Time 1 (in 0.1 sec)	0 ... 50; <u>4</u>
Time 2 (in 0.1 sec)	0 ... 50; <u>20</u>

#### Dead man switch:

Press button	Retract   Extend   Retract/Extend Command
Release button	Stop command

### **Window**

Function	<b>Window</b>
----------	---------------

Swap Open/Close	<u>No</u> • Yes
Control mode	<ul style="list-style-type: none"> <li>• <u>Standard</u></li> <li>• Standard inverted</li> <li>• Comfort mode</li> <li>• Dead man switch</li> </ul>

## Standard:

Behaviour for button actuation (close): short = Stop   long = Close	
Behaviour for button actuation (open): short = Stop   long = Open	
Behaviour for button actuation (open/close): short = Stop   long = Open/Close	
Time between tap and hold (0.1 sec)	0 ... 50; <u>10</u>

## Standard inverted:

Behaviour for button actuation (close): long = Stop   short = Close	
Behaviour for button actuation (open): long = Stop   short = Open	
Behaviour for button actuation (open/close): long = Stop   short = Open/Close	
Time between tap and hold (0.1 sec)	0 ... 50; <u>10</u>
Repetition of the step command upon extended button press (only for up)	none • every 0.1 s • ... • <u>every 0.5 s</u> • ... • every 2 s

## Comfort mode:

Push-button is pressed and	
released before expiry of Time 1	Stop
Maintained for longer than Time 1	Close   Open   Open/Close
Triggered between Times 1 and 1 + 2	Stop
Triggered after Times 1 + 2	No more stop
Time 1 (in 0.1 sec)	0 ... 50; <u>4</u>
Time 2 (in 0.1 sec)	0 ... 50; <u>20</u>

## Dead man switch:

Press button	Close   Open   Open/Close command
Release button	Stop command

## 8.7.2. Control modes for drive control

### **Behaviour on button actuation in standard control mode:**

	<b>short</b>	<b>hold</b>
Blind	Stop/Step	Up or down
Shutters	Stop	Up or down
Awning	Stop	Retract or extend
Windows	Stop	Closed or open

### **Standard:**

If briefly operated, the drive will move incrementally or stops. If operated longer, the drive will move up to the end position. The time difference between "short" and "long" is set individually.

Control mode	<b>Standard</b>
Behavior during button operation: short = stop/increment long = Up or Down	
Time between short and long in 0.1 seconds	1...50; <u>10</u>

### **Standard inverted:**

When pushed shortly, the drive moves up to the end position. When pushed for longer, the drive moves incrementally or stops. The time difference between "short" and "long" and the repeat interval is set individually.

Control mode	<b>Standard inverted</b>
Behavior during button operation: short = Up or Down long = Stop/Step	
Time between short and long in 0.1 seconds	1...50; <u>10</u>
Repeat the step command for a long button press	every 0.1 s • every 2 sec; <u>every 0.5 sec</u>

### **Comfort mode:**

In the **comfort mode** actuating the button briefly, a bit longer and long will trigger different responses of the drive. The time intervals are set individually.

**Short actuation** (shorter than Time 1): The drive is positioned step-wise and stopped.

**Holding it slightly longer** (longer than Time 1, but shorter than Time 1+2): Drive running. Drive stops when the button is released.

**Long holding** (release after Time 1+2 runs out): Drive moves independently to the end position. The movement can be interrupted by a short tap.

Fig. 5  
Time interval comfort mode diagram

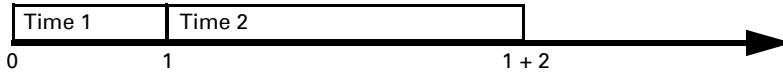

Point in time 0: Actuate of button, start of time 1  
 Release before time 1 expired: step (or stop if drive is moving)  
 Point in time 1: End of time 1, start of time 2  
 Moving command  
 Release after time 1 expired  
 but before time 2 expires: Stop  
 Release after time 1 + 2 expired: Move into end position

Control mode	Comfort mode
Behavior during button operation: Button is pushed and released before time 1 expired = stop/step held longer than time 1 = Up or Down released between time 1 and 1-2= stop released after time 1 +2 = no more stop	
Time 1	0.0s ... • 2 s; <u>0.4 s</u>
Time 2	0 s • 2 s; <u>2 s</u>

### Dead man's switch:

The drive moves as soon as the button is actuated and stops as soon as the button is released.

Control mode	Dead man's switch
Behavior during button operation: Push button = Up or Down command Release button = Stop command	

## 8.8. Logic

The device has 8 logic inputs, 2 AND and 2 OR logic gates.

Activate the logic inputs and assign object values up to 1st communication.

Use logic inputs	<u>No</u> • Yes
Object value prior to 1st communication for	
- Logic input 1 ... 8	<u>0</u> • 1

Activate the required logic outputs

### AND logic

AND logic 1/2	<u>not active</u> • active
---------------	----------------------------

## OR logic

OR logic 1/2	<u>not active</u> • active
--------------	----------------------------

### 8.8.1. AND logic outputs 1/2 and OR logic outputs 1/2

The same setting options are available for AND and OR logic.

Each logic output may transmit one 1-bit or two 8-bit objects. Determine what the output should send if logic = 1 and = 0.

1. / 2. / 3. / 4. Input	<ul style="list-style-type: none"> <li>• <u>Do not use</u></li> <li>• Logic inputs 1...8</li> <li>• Logic inputs 1...8 inverted</li> <li>• Temperature sensor malfunction = ON</li> <li>• Temperature sensor malfunction = OFF <i>only with OR logic:</i></li> <li>• Switching output AND logic 1/2</li> <li>• Switching output AND logic 1/2 inverted</li> </ul>
Output type	<ul style="list-style-type: none"> <li>• <u>a 1-bit-object</u></li> <li>• sends two 8-bit objects</li> </ul>

If the **output type is a 1-bit object**, set the output values for the various conditions.

Output value if logic = 1	<u>1</u> • 0
Output value if logic = 0	1 • <u>0</u>
Output value If block active	1 • <u>0</u>
Output value if monitoring time exceeded	1 • <u>0</u>

If the **output type is two 8-bit objects**, set the type of object and the output values for the various conditions.

Object type	<ul style="list-style-type: none"> <li>• <u>value (0...255)</u></li> <li>• Percent (0...100%)</li> <li>• Angle (0...360°)</li> <li>• Scene call-up (0...63)</li> </ul>
Output value object A if logic = 1	0 ... 255 / 100% / 360° / 63; <u>1</u>
Output value object B if logic = 1	0 ... 255 / 100% / 360° / 63; <u>1</u>
Output value object A if logic = 0	0 ... 255 / 100% / 360° / 63; <u>0</u>
Output value object B if logic = 0	0 ... 255 / 100% / 360° / 63; <u>0</u>

Output value object A If block active	0 ... 255 / 100% / 360° / 63; <u>0</u>
Output value object B If block active	0 ... 255 / 100% / 360° / 63; <u>0</u>
Output value object A if monitoring time exceeded	0 ... 255 / 100% / 360° / 63; <u>0</u>
Output value object B if monitoring time exceeded	0 ... 255 / 100% / 360° / 63; <u>0</u>

Set the output send pattern.

Transmission behaviour	<ul style="list-style-type: none"> <li>• <u>on change of logic</u></li> <li>• on change of logic to 1</li> <li>• on change of logic to 0</li> <li>• on change of logic and periodically</li> <li>• on change of logic to 1 and periodically</li> <li>• on change of logic to 0 and periodically</li> <li>• on change of logic + object receipt</li> <li>• on change of logic + object receipt and cyclically</li> </ul>
Send cycle (if sent periodically)	5 s • <u>10 s</u> • ... • 2 h

## Block

If necessary, activate the block for the logic output and set what a 1 or 0 at the block input means and what happens in the event of a block.

Use block	<u>No</u> • Yes
Assessment of the block object	<ul style="list-style-type: none"> <li>• <u>At value 1: block   At value 0: release</u></li> <li>• At value 0: block   At value 1: release</li> </ul>
Blocking object value before first Communication	<u>0</u> • 1
Output behaviour when blocking	<ul style="list-style-type: none"> <li>• <u>Do not send message</u></li> <li>• Send block value [see above, output value if block active]</li> </ul>
when released (with 2 second release delay)	<ul style="list-style-type: none"> <li>• <u>Do not send message</u></li> <li>• transmit value for current logic status</li> </ul>

## Monitoring

If necessary, activate the input monitoring. Set which inputs are to be monitored, at which intervals the inputs are to be monitored and what value the "monitoring status" should have, if the monitoring period is exceeded without a feedback being given.

Use input monitoring	<u>No</u> • Yes
Input monitoring	<ul style="list-style-type: none"> <li>• <u>1 • 2 • 3 • 4</u></li> <li>• 1 + 2 • 1 + 3 • 1 + 4 • 2 + 3 • 2 + 4 • 3 + 4</li> <li>• 1 + 2 + 3 • 1 + 2 + 4 • 1 + 3 + 4 • 2 + 3 + 4</li> <li>• <u>1 + 2 + 3 + 4</u></li> </ul>



Monitoring period	5 s • ... • 2 h; <u>1 min</u>
Output behaviour on exceeding the monitoring time	<ul style="list-style-type: none"><li>• <u>Do not send message</u></li><li>• Send value exceeding [= value of the parameter "Monitoring period"]</li></ul>



**Elsner Elektronik GmbH** Control and Automation Engineering

Sohlengrund 16  
75395 Ostelsheim  
Germany

Phone +49 (0) 70 33 / 30 945-0 [info@elsner-elektronik.de](mailto:info@elsner-elektronik.de)  
Fax +49 (0) 70 33 / 30 945-20 [www.elsner-elektronik.de](http://www.elsner-elektronik.de)

---

*Technical support: +49 (0) 70 33 / 30 945-250*