

# P03/3-Modbus & P03/3-Modbus-GPS Weather Stations for Modbus

## Technical specifications and installation instructions

Item numbers 30146 (P03/3-Modbus), 30147 (P03/3-Modbus-GPS)



## 1. Description

The **P03/3-Modbus** and **P03/3-Modbus-GPS Weather Stations** measure temperature, wind speed and brightness (eastern, southern and western sun) and recognize precipitation.

The **P03/3-Modbus-GPS** additionally receives the UTC signals (Universal Time Coordinated) as well as the site coordinates via an integrated GPS receiver. The direction of the sun (azimuth) as well as its height (elevation) are calculated and indicated, too.

The devices are Modbus slaves with a RS485 interface and a RTU protocol. The Modbus master, such as PC, SPS or MC can read the **P03/3-Modbus(-GPS) Weather Stations** measurement values with "Function 04h (Read Input Register)".

### Functions:

- **Brightness measurement** with three separate sensors for east, south and west. Recognition of twilight/dawn
- **Wind measurement:** The wind strength measurement takes place electronically and thus noiselessly and reliably, even during hail, snow and sub-zero temperatures. Even turbulent air and anabatic winds in the vicinity of the weather station are recorded
- **Temperature measurement**
- Heated precipitation sensor (1.2 watts): No false reports as a result of fog or dew. Dries quickly after precipitation has stopped
- **P03/3-Modbus-GPS only:** Integrated GPS receiver. Output of UTC (Universal Time Coordinated), position (degree of longitude and latitude) and position of the sun (azimuth, elevation)

### 1.0.1. Scope of delivery

- Weather station

## 1.1. Technical specifications

Housing	Plastic material
Colour	White / translucent
Mounting	On-wall
Protection category	IP 44
Dimensions	approx. 96 x 77 x 118 (W x H x D, mm)
Weight	approx. 160 g
Ambient temperature	Operation -30...+50°C, Storage -30...+70°C
Operating voltage	24 V DC ±10%. An appropriate power supply unit can be obtained from Elsner Elektronik
Cable cross-section	Massive conductors of up to 0.8 mm <sup>2</sup>
Current	max. 80 mA, residual ripple 10%
Interface	RS485
Protocol	RTU
RS485 bus load	1/8 unit load according to RS485 standard
RS485 driver performance	min. 2.4 V at 54 Ohm bus load (corresponds to 32 standard RS485 unit loads)
Heating rain sensor	approx. 1.2 W
Measurement range temperature	-40...+80°C
Resolution (temperature)	0.1°C
Accuracy (temperature)	±1.5°C at -25...+80°C
Measurement range wind	0...35 m/s
Resolution (wind)	0,1 m/s
Accuracy (wind)	at ambient temperature -20...+50°C: ±22% of the measurement value when incident flow is from 45...315° ±15% of the measurement value when incident flow is from 90...270° (Frontal incident flow corresponds to 180°)
Measurement range brightness	0...99 000 lux
Resolution (brightness)	1 lux up to 300 lux 2 lux up to 1000 lux 20 lux up to 99 000 lux
Accuracy (brightness)	±15% at 30 ... 30 000 lux

The product conforms with the provisions of EU directives.

## 2. Installation and commissioning

### 2.1. Installation notes

 Installation, testing, operational start-up and troubleshooting should only be performed by an electrician.

#### CAUTION! Live voltage!

- There are unprotected live components inside the device.
- National legal regulations are to be followed.
  - Ensure that all lines to be assembled are free of voltage and take precautions against accidental switching on.
  - Do not use the device if it is damaged.
  - Take the device or system out of service and secure it against unintentional use, if it can be assumed, that risk-free operation is no longer guaranteed.

The device is only to be used for the intended purpose described in this manual. Any improper modification or failure to follow the operating instructions voids any and all warranty and guarantee claims.

After unpacking the device, check it immediately for possible mechanical damage. If it has been damaged in transport, inform the supplier immediately.

The device may only be used as a fixed-site installation; that means only when assembled and after conclusion of all installation and operational start-up tasks and only in the surroundings designated for it.

Elsner Elektronik is not liable for any changes in norms and standards which may occur after publication of these operating instructions.

#### 2.1.1. Installation position

Choose an installation position in the building where wind, rain and sun can be measured unhindered by the sensors. The weather station must not be installed underneath any structural parts from which water can still drip onto the rain sensor after it has stopped raining or snowing. The weather station must not be shaded by anything, such as building structures or trees.

At least 60 cm of clearance must be left all round the weather station. This facilitates correct wind speed measurement without eddies. The distance concurrently prevents spray (raindrops hitting the device) or snow (snow penetration) from impairing the measurement. It also does not allow birds to bite it. Please take note that an extended awning does not shade the device from sun and wind.

Temperature measurements can also be affected by external influences such as by warming or cooling of the building structure on which the sensor is mounted, (sunlight, heating or cold water pipes).

Magnetic fields, transmitters and interfering fields from electricity consumers (e.g. fluorescent lamps, neon signs, switched-mode power supplies etc.) can interfere with or even cut out reception of the GPS signal.

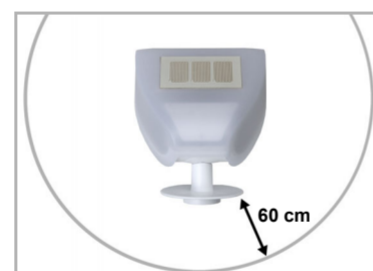

Fig. 1  
There must be at least 60 cm of space below, to the sides and in front of the weather station left from other elements (structures, construction parts, etc.).

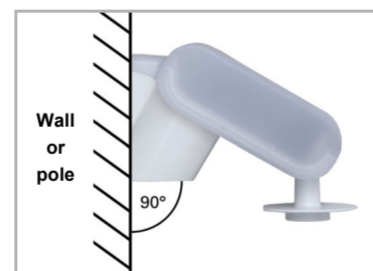

Fig. 2  
The weather station must be mounted on a vertical wall (or a pole).

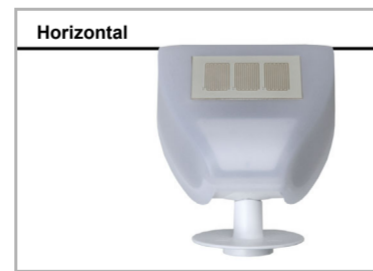

Fig. 3  
The weather station must be mounted in the horizontal transverse direction (horizontally).

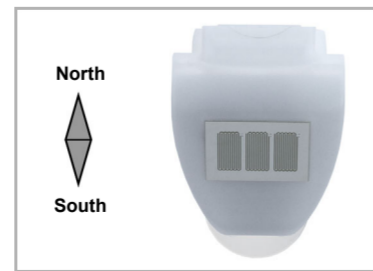

Fig. 4  
For installation in the northern hemisphere, the weather station must be aligned to face south.

For installation in the southern hemisphere, the weather station must be aligned to face north.

## 2.2. Mounting the sensor

### 2.2.1. Attaching the mount

The sensor comes with a combination wall/pole mount. The mount comes adhered by adhesive strips to the rear side of the housing. Fasten the mount vertically onto the wall or pole.

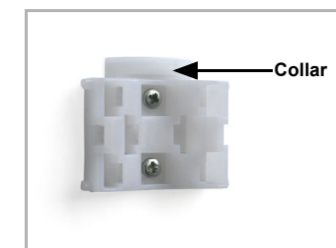

Fig. 5  
When wall mounting: flat side on wall, crescent-shaped collar upward.

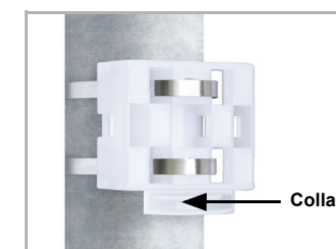

Fig. 6  
When pole mounting: curved side on pole, collar downward.



Fig. 7  
Different mounting arms are available from Elsner Elektronik as additional, optional accessories for flexible installation of the weather station on a wall, pole or beam. Example of the use of a mounting arm: Due to flexible ball joints, the sensor can be brought into ideal position.

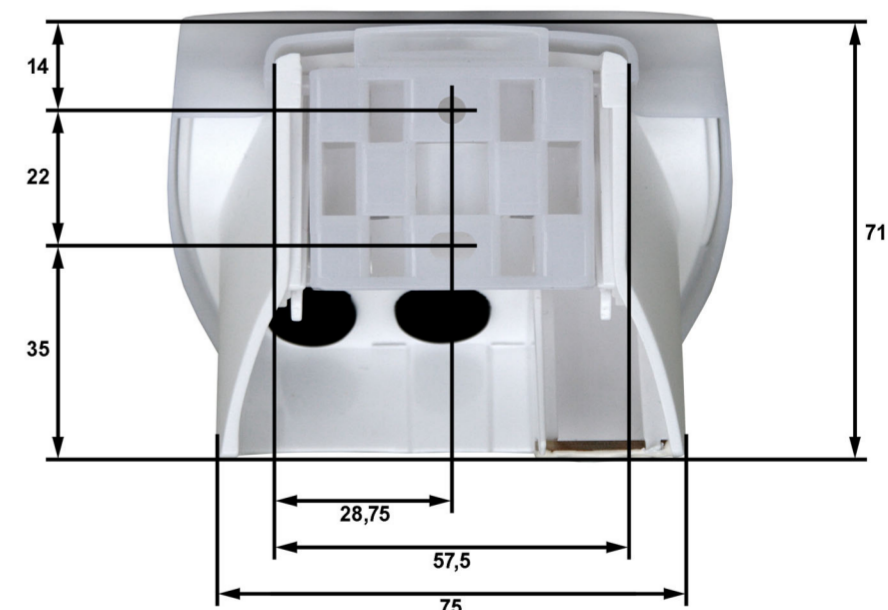
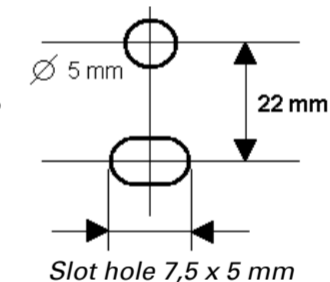

Fig. 8  
Example use of the hinge arm mounting: Fitting to a pole with worm drive hose clips

### 2.2.2. View of rear side and drill hole plan

Fig. 9 a+b  
Drill hole plan

Dimensions of rear side of housing with bracket. Subject to change for technical enhancement.



### 2.2.3. Preparing the sensor

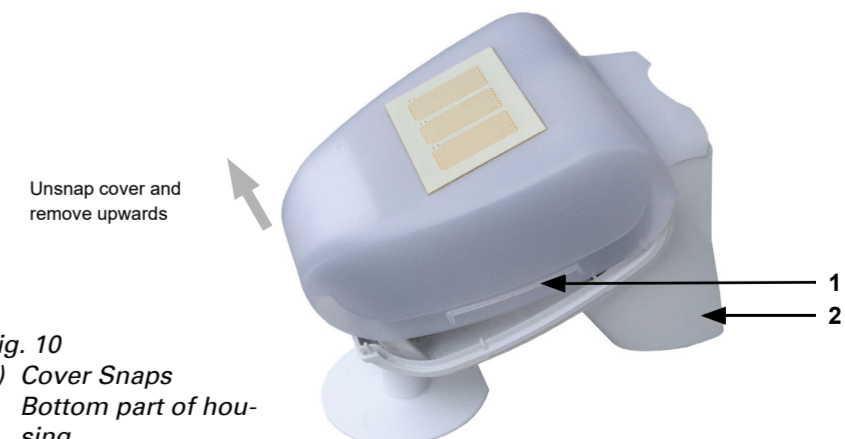

Fig. 10  
1) Cover Snaps  
2) Bottom part of housing

The weather station cover with the rain sensor snaps in on the left and right along the bottom edge (see figure). Remove the weather station cover. Proceed carefully, so as **not to pull off the wire** connecting the PCB in the bottom part with the rain sensor in the cover (wire with push-connector).



**ATTENTION!**

- Make sure the connection is correct!
- Connect the power supply to 1 and 2 only.
- Use the data connections A and B exclusively for Modbus.

Push the connecting cable through the rubber seal on the bottom of the weather station and connect the power and bus cables to the terminals provided for this purpose. The connection is by typical telephone cable (J-Y(ST)Y 2 x 2 x 0.8). The reference potential for data lines is GND (-) of the power supply.

The connection cable must be plugged in between the cover and circuit board.

**2.2.4. PCB Layout**



**ATTENTION!**

- Make sure the connection is correct!
- Connect the power supply to 1 and 2 only.
- Use the data connections A and B exclusively for Modbus.

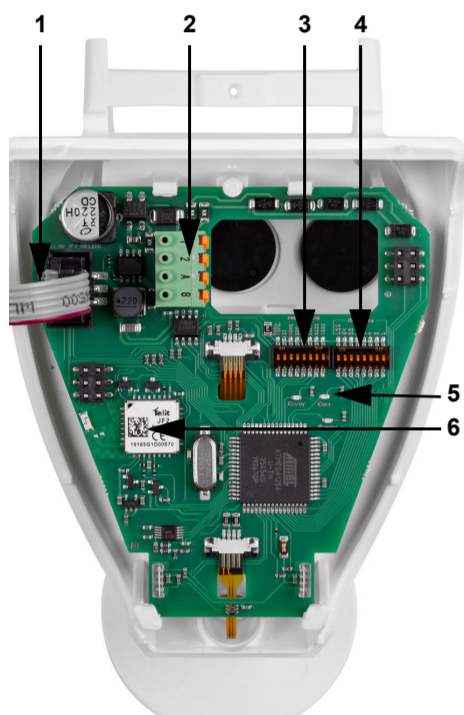

Fig. 11: Overview PCB

- 1 Connection to the rain sensor in the housing cover
- 2 Connecting plug, suitable for massive conductors of up to 0.8 mm<sup>2</sup>  
1: 24 V DC  
2: GND  
A: data (Modbus D0)  
B: data (Modbus D1)  
The reference potential for data lines is GND (-) of the power supply.
- 3 DIP switch for interface parameters (see detailed view)
- 4 DIP switch for slave address (see detailed view)
- 5 LED "Com", "Error" and "Power"  
„Power“: operating voltage  
„Error“: sensor error/erroneous data  
„Com“: bus communication
- 6 GPS module (only P03/3-Modbus-GPS)

**2.2.5. Bus load**

The RS485 transceiver used has 1/8 of a standard RS485 bus load (1/8 unit load) and can manage at least a 2.4 V at 54 Ohm bus load. It can, thus, operate a bus with 32 nodes at standard bus load. If nodes with a lower load than the standard bus load are connected to an RS485 bus, the bus can be operated with more nodes. If, for example, only nodes with 1/8 bus load are connected, up to 32 x 8 = 256 nodes can be connected to the bus.

**2.2.6. Setting up bus communication**

Fig. 12: detailed view DIP switches

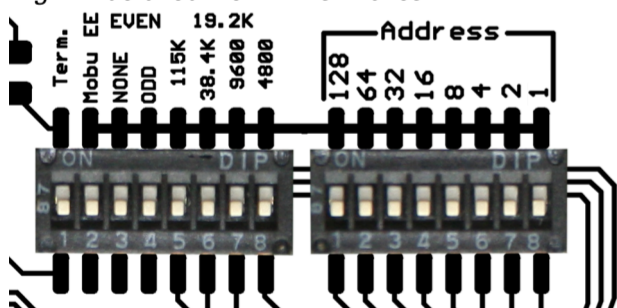

If all DIP switches are in the OFF position (default setting), the following parameters are active:

Address: 1  
Baud rate: 19,200  
Parity: Even  
Termination: Disabled

**Setting of the slave's address:**

The slave address is set with the help of the 8-bit DIP switch "Address". If all switches are in the OFF position, Address 1 is active. Address 0 is reserved for broadcast messages; addresses greater than 247 are not valid.

The coding of the address is binary. For the address 47, you must e.g. set the switches 3, 5, 6, 7 and 8 to ON.

**Interface parameters:**

The interface parameters are set with the help of the second 8-bit DIP switch. If the first 4 switches are in the OFF position, the transfer rate amounts to 19,200 bauds. If one of these switches is set to ON, the corresponding baud rate is applicable.

**Parity:** If the two switches "ODD" and "NONE" are set to OFF, the parity is EVEN. Only "ODD" or "NONE" can switch the corresponding parity check.

**Switch "Mobu EE":** no function.

**Switch "Term.":** bus termination 124 ohms

**2.2.7. Mounting the weather station**

Close the housing by putting the cover back over the bottom part. The cover must snap in on the left and right with a definite "click".

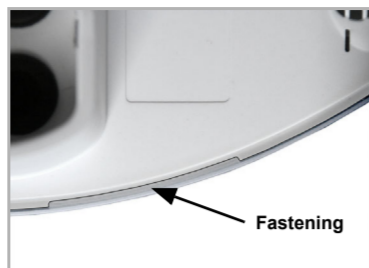

Fig. 13  
Make sure the cover and bottom part are properly snapped together! This picture is looking at the closed sensor from underneath.



Fig. 14  
Push the housing from above into the fastened mount. The bumps on the mount must snap into the rails in the housing.

To remove it, the weather station can be simply pulled upwards out of the mount, against the resistance of the fastening.

**2.3. Notes on mounting and commissioning**

Do not open weather station if water (rain) might ingress: even some drops might damage the electronic system.

Observe the correct connections. Incorrect connections may destroy the weather station or connected electronic devices.

Please take care not to damage the temperature sensor (small blank at the bottom part of the housing.) when mounting the weather station. Please also take care not to break away or bend the cable connection between the blank and the rain sensor when connecting the weather station.

Remove all existing protection labels after installation.

The correct wind value may only be supplied approximately 60 seconds after the supply voltage has been connected.

**2.4. Maintenance of the weather station**



**WARNING!**

**Risk of injury caused by components moved automatically!**

- The automatic control can start system components and place people in danger.
- Always isolate the device from the mains for servicing and cleaning.

The device must regularly be checked for dirt twice a year and cleaned if necessary. In case of severe dirt, the sensor may not work properly anymore.



**ATTENTION**

- The device can be damaged if water penetrates the housing.
- Do not clean with high pressure cleaners or steam jets.

**3. Transfer protocol**

**3.1. P03-Modbus request string from the master**

Byte No.	Variable		Meaning
0	Slave address	xx	
1	Command	04H	Read Input Registers
2	Start address High Byte	xx	Register start address
3	Start address Low Byte	xx	
4	Number of words High Byte	xx	Number of registers to be read
5	Number of words Low Byte	xx	
6	CRC Low Byte	xx	
7	CRC High Byte	xx	

Example query string for reading all data:  
0x01 0x04 0x00 0x00 0x00 0x11 0x30 0x06

**3.2. P03-Modbus output string to the master**

Byte No.	Register address	Variable		Meaning
0		Slave address	xx	
1		Command	04H	Read Input Registers
2		Number of bytes	xx	Master request * 2
3	0	Outdoor temperature	H	with sign, value/10 = temperature xx.x °C
4		Outdoor temperature	L	
5	1	Sun sensor, south	H	1...99 Kilolux
6		Sun sensor, south	L	
7	2	Sun sensor, west	H	1...99 Kilolux
8		Sun sensor, west	L	
9	3	Sun sensor, east	H	1...99 Kilolux
10		Sun sensor, east	L	

Byte No.	Register address	Variable		Meaning
11	4	Light	H	0...999 Lux
12		Light	L	
13	5	Wind	H	Value/10 gives wind speed in m/s (metres per second)
14		Wind	L	
15	6	GPS / RTC		1 = GPS; 0 = quartz clock 50 ppm (*)
16		Rain		1 = rain; 0 = no rain
17	7	Day	H	
18		Day	L	Date Day (*)
19	8	Month	H	
20		Month	L	Date Month (*)
21	9	Year	H	
22		Year	L	Date Year (*)
23	10	Hour	H	
24		Hour	L	Time Hour (*)
25	11	Minute	H	
26		Minute	L	Time Minute (*)
27	12	Second	H	
28		Second	L	Time Second (*)
29	13	Azimuth	H	Value/10 = sun position; angle 0.0 ... 359.9 degrees (*)
30		Azimuth	L	
31	14	Elevation	H	Value/10 = sun position; height range +/-90.0 degrees (*)
32		Elevation	L	
33	15	Degree of longitude	H	Value/100 +/- xxx.xx°; + = east / - = west (*)
34		Degree of longitude	L	
35	16	Degree of latitude	H	Value/100 +/- xxx.xx°; + = north / - = south (*)
36		Degree of latitude	L	
37	CRC		L	
38	CRC		H	

(\*) Only available with version P03/3-Modbus-GPS (with GPS module)

Negative values are represented in the two's complement notation.

Time indicated as: UTC (Coordinated Universal Time).

**4. Disposal**

After use, the device must be disposed of or recycled in accordance with the legal regulations. Do not dispose of it with the household waste!