

Product designation: **switching actuator 1fold 16A FM**

Design: FM (flush-mounted type)

Article no.: **1059 00**

ETS search path: Gira Giersiepen / Output / Binary output, 1fold / switching actuator 1fold 16A FM

Functional description:

The switching actuator receives telegrams from sensors via the Instabus and switches an electrical load with its relay-output.

The device is equipped with two extension inputs which - depending on parameterization - can act directly on the switching output (local control / only input 1, input 2 without function) or alternatively as binary inputs on the Instabus KNX / EIB. The connected potential-free switch or push-button contacts are sensed against a common reference potential at the switching actuator. As a binary input, the device can transmit telegrams for switching or dimming, for shutter/blind control or for value transmitter applications (dimming value transmitter, light-scene extension). Connecting 230 V signals or other external voltages to the extension inputs is not permitted.

The switching actuator is supplied from the Instabus and needs therefore no additional external power supply.

Illustration:

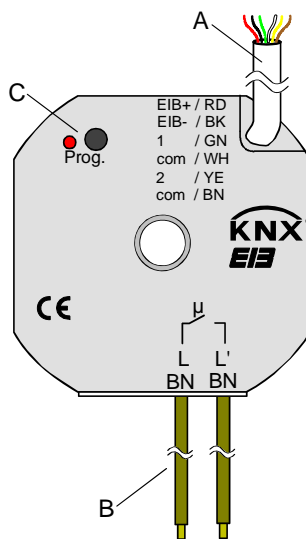

Dimensions:

Ø: 53 mm

Height (H): 28 mm

Opening for ceiling rose:

Ø: 7 mm

Controls:

A: Low-voltage connecting wires

red (RD): bus (+)

black (BK): bus (-)

green (GN): extension input 1

white (WH): reference potential (com)

yellow (YE): extension input 2

brown (BN): reference potential (com)

B: Load connection wires

2 x brown (BN): L and L' (switching output)

C: Programming button / LED (red)

Technical data:

Instabus EIB supply

Voltage:

YY 6 x 0.6 mm; red: bus (+) / black: bus (-)

Power consumption:

21 – 32 V DC SELV

Connection:

typically 150 mW

External supply

ca. 33 cm ready-made; connecting terminal (0.6 – 0.8 mm)

External supply

instabus EIB System

Actuator

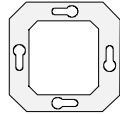

Input:		
Number:	2	(depending on parameterization either as extension inputs for push button local control of the actuator or as independent binary inputs acting on the bus)
Cable type:	YY 6 x 0.6 mm	
	green:	extension input 1
	white:	reference potential (com)
	yellow:	extension input 2
	brown:	reference potential (com)
Cable length:	approx. 33 cm ready-made, extendible to 5 m max.	
Scanning voltage:	approx. – 19 V DC referred to "com"; continuous signal	
Loop resistance:	max. 2 kOhm for safe "1" signal detection (rising edge)	

Output:		
Number:	1	
Cable type:	2 x H05 V-K 2.5 mm ² with ferrules	
Cable length:	approx. 20 cm ready-made	
Switch type:	make-contact, potential-free (μ-contact), bistable	
Switching voltage:	230 V AC; 50 / 60 Hz	
Max. switching current:	16 A	
Max. inrush current:	400 A, 20 ms	
Switching capacity:	Incandescent lamps:	2.500 W
	HV halogen lamps:	2.200 W
	LV halogen lamps	
	inductive transformers:	1.000 VA
	electronic transformers:	1.000 W
	capacitive loads:	230 V AC, 10A switching current, max. 105 μF

Response to voltage failure: Output: depending on parameterization (cf. "parameter description")
Inputs: no reaction

Response to bus voltage return: Output: depending on parameterization (cf. "parameter description")
Inputs: depending on parameterization (cf. "parameter description")

Type of protection:	IP 20
Safety class:	III
Mark of approval:	KNX / EIB
Ambient temperature:	-5 °C ...+45 °C
Storage / transport temperature:	-25 °C ...+70 °C (storage above +45 °C results in shorter lifetime)
Mounting position:	any
Minimum spacings:	none
Type of fastening:	e.g. placing into deep flush-mounting box (∅ 60 mm x 60 mm)

Connecting diagram:

Terminals:

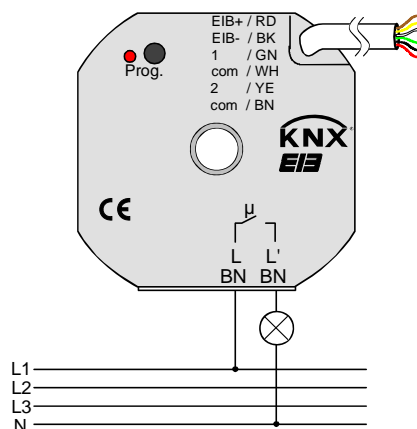

Load connection:

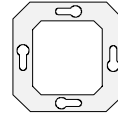
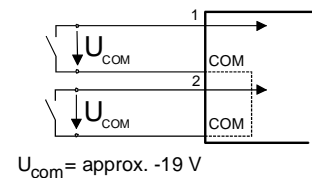
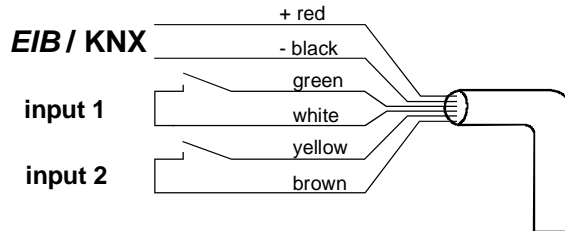
**Connecting diagram:****Terminals:****Bus connection and connection of extensions:**

A spacing of 4 mm minimum between extra low-voltage lines (bus and extension inputs) and the load lines (230 V) must be ensured (see fig. A).

It is recommended to install the switching actuator in two interconnected flush-mounting boxes (see fig. B). One of the boxes (A) can accommodate besides the bus and extension connections also a series switch (C), whereas the other box (B) accommodates the switching actuator and the 230 V terminals. The 6-wire connecting cable (D) is led through the box junction.

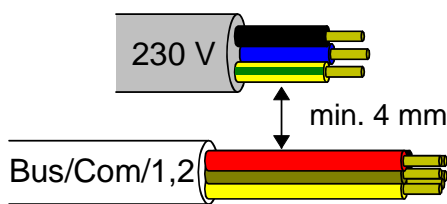

Fig A

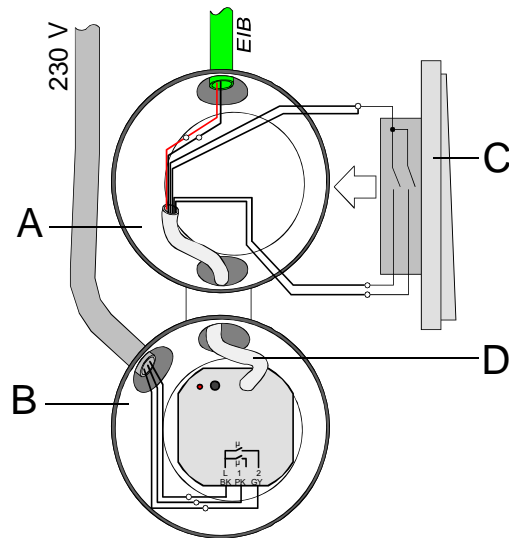

Fig B

Hardware information

- ⚠ Never connect the mains voltage (230 V) or other external voltages to the extension inputs. Connecting an external voltage endangers the electrical safety of the entire KNX/EIB system (SELV / no electrical insulation). Persons may be put at risk and devices and installations may suffer irreparable damage
- Make sure during the installation that there is always sufficient insulation between the mains voltage and the bus or the extensions. A minimum spacing of 4 mm must be ensured between the bus/extension wires and the mains wires.
- Non-used wires of the 6-wire connecting cable must be insulated with respect to one another and with respect to external voltages.
- To avoid EMC disturbances, the lines to the inputs should not be laid parallel to lines and cables carrying mains voltage.
- Connection of different phase conductors is not possible!

instabus EIB System

Actuator

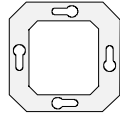

Software description:

ETS search path:

ETS symbol:

Output / Binary output, 1fold / switching actuator 1fold 16A FM

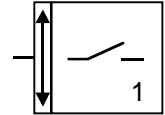

Applications:

Short description:

Name:

Date:

Page:

Data base

1-channel switching with time functions, feedback and additional functions. Two additional extension inputs.

Switching FM 207201

02.05

5

10599190

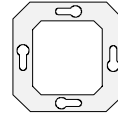

Application: **Switching FM 207201**

Scope of functions:

General

- Mode of functioning of the inputs parametrizable:
 - function as extension inputs acting directly on the switching output (input 1 → output / input 2 → without function) (state-of-delivery setting)
 - function as general binary inputs acting separately on the bus

Function as binary inputs to the bus:

- Switching, dimming, shutter/blind and value transmitter functions freely assignable to the max. 2 inputs
- Disable object for disabling of individual inputs (polarity of disable object presettable)
- Delay on return of bus voltage and debouncing time centrally adjustable
- Response to bus voltage return separately parameterizable for each input
- Telegram rate limitation generally parameterizable for all inputs

Switching function

- Two independent switching objects available for each input (switching commands individually parameterizable)
- Command for rising and falling edge individually adjustable (ON, OFF, TOGGLE, no reaction).
- Independent cyclical transmission of switching objects depending on edge or on object value selectable.

Dimming function

- Single-sided and double-sided actuation
- Time between dimming and switching and dimming step width presettable
- Telegram repetition and stop telegram transmission possible

Shutter/blind function

- Command for rising edge adjustable (no function, UP, DOWN, TOGGLE)
- Operation concept parameterizable ("step - move - step" resp. "move - step")
- Time between STEP and MOVE operation presettable (only with "step - move - step")
- Slat adjustment time presettable (time during which a "MOVE" command can be terminated by releasing a push-button on the input)

Value transmitter and light-scene extension functions

- Edge (push-button as n.o. contact, push-button as n.c. contact, switch) and value for edge parameterizable
- Value change in push-button mode possible with long press on the button for value transmitter
- In light-scene extension with storage function, a light-scene can be stored without preceding recall

Output:

- Output parameterizable as n.o. contact (ON: contact closes / OFF: contact opens) or as n.c. contact (ON: contact opens / OFF: contact closes)
- Preferred state on return of bus voltage presettable
- For the output additional feedback and additional function possible:
 - Presetable additional functions:
 - logic-operation function with 3 logic parameters
 - disabling function with presettable disabling behaviour of the relays
 - priority-position function to fix the priority of arriving switching telegrams
- Feedback object invertible
- Delay on return of bus voltage centrally presettable
- Turn-on delay and/or turn-off delay or timer function separately presettable for each output

Actuator

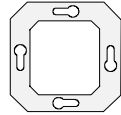

Object description

Objects for the binary inputs (extension inputs):

Object		Object description
☐ 2 – 3	Switching object X.1:	1-bit object for transmitting switching telegrams (ON, OFF) (1st switching object)
☐ 10 – 11	Switching object X.2:	1-bit object for transmitting switching telegrams (ON, OFF) (2nd switching object)
☐ 2 – 3	Switching:	1-bit object for transmitting switching telegrams (ON, OFF) for the dimming function
☐ 10 – 11	Dimming:	4-bit object for relative brightness variation between 0 and 100 %
☐ 2 – 3	Short operation (STEP):	1-bit object for STEP operation of a shutter or blind
☐ 10 – 11	Long operation (MOVE):	1-bit object for MOVE operation of a shutter or blind
☐ 2 – 3	Value:	1-byte object for transmitting value telegrams (0 - 255)
☐ 2 – 3	Light-scene extension:	1-byte object for recalling and storing light-scenes (1 - 64)
☐ 18 – 19	Disabling:	1-bit object for disabling individual binary inputs (polarity parameterizable)

Objects for the output:

Object		Object description
☐ 0	Switching:	1-bit object for controlling the output
☐ 8	Logic operation:	1-bit object for logic-operation control of the output (ON: Logic-operation input "1" / OFF: Logic-operation input "0")
☐ 8	Disabling:	1-bit object for disabling the output (polarity parameterizable)
☐ 8	Priority control:	2-bit object for priority-position control of the output
☐ 16	Feedback:	1-bit object for switching status feedback of the output (feedback invertible)

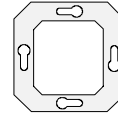

Number of addresses (max.):	26	dynamic table management:	Yes <input checked="" type="checkbox"/> No <input type="checkbox"/>
Number of assignments (max.):	27	maximum table length:	53
Communication objects:	9		

Objects for the binary inputs (extension inputs), if acting on the bus:

Function: no function (for all 2 inputs ²)

No further input objects!

Function: "Switching" (for all 2 inputs ²)

Object	Function	Name	Type	Flag
<input checked="" type="checkbox"/> 2 – 3	Switching object X.1 (X = 1 to 2)	Input 1 – Input 2	1 bit	C, W, T, (R) ¹
<input checked="" type="checkbox"/> 10 – 11	Switching object X.2 (X = 1 to 2)	Input 1 – Input 2	1 bit	C, W, T, (R) ¹

Function: "Dimming" (for all 2 inputs ²)

Object	Function	Name	Type	Flag
<input checked="" type="checkbox"/> 2 – 3	Switching	Input 1 – Input 2	1 bit	C, W, T, (R) ¹
<input type="checkbox"/> 10 – 11	Dimming	Input 1 – Input 2	4 bit	C, T, (R) ¹

Function: "Shutter/blind" (for all 2 inputs ²)

Object	Function	Name	Type	Flag
<input type="checkbox"/> 2 – 3	Short operation (STEP)	Input 1 – Input 2	1 bit	C, T, (R) ¹
<input type="checkbox"/> 10 – 11	Long operation (MOVE)	Input 1 – Input 2	1 bit	C, T, (R) ¹

Function: "Value transmitter" (Function: Dimming value transmitter for all 2 inputs ²)

Object	Function	Name	Type	Flag
<input type="checkbox"/> 2 – 3	Value	Input 1 – Input 2	1 byte	C, T, (R) ¹

Function: "Value transmitter" (Function: Light-scene extension with/without storage function for all 2 inputs ²)

Object	Function	Name	Type	Flag
<input type="checkbox"/> 2 – 3	Light-scene extension	Input 1 – Input 2	1 byte	C, T, (R) ¹

Function: "Disable" (for all 2 inputs ³)

Object	Function	Name	Type	Flag
<input checked="" type="checkbox"/> 18 – 19	Disabling	Input 1 – Input 2	1 bit	C, W, (R) ¹

1: Objects marked (R) permit read-out of the object status (set R flag).

2: The "No function", "Switching", "Dimming", "Shutter/blind" and "Value transmitter" functions can be selected per input. The names of the communication objects and the object table (dynamic object structure) will change accordingly.

3: A disable function is not available if the inputs are parameterized for "No function".

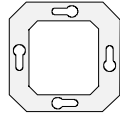

Objects for the output:

Function: "Output"

Object	Function	Name	Type	Flag
0	Switching	Output 1	1 Bit	C, W, (R) ¹

Function: Additional function for the output = "Logic-operation object"

Object	Function	Name	Type	Flag
8	Logic function	Output 1	1 bit	C, W, (R) ¹

Function: Additional function for the output = "Disabling object"

Object	Function	Name	Type	Flag
8	Disabling	Output 1	1 bit	C, W, (R) ¹

Function: Additional function for the output = "Priority-position object"

Object	Function	Name	Type	Flag
8	Priority operation	Output 1	2 bit	C, W, (R) ¹

Function: Feedback for the output

Object	Function	Name	Type	Flag
16	Feedback	Output 1	1 bit	C, T, (R) ¹

1: Objects marked (R) permit read-out of the object status (set R flag).

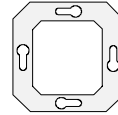

Functional description of the inputs

Mode of functioning of the inputs

The switching actuator is equipped with two extension inputs which - depending on parameterization - can act directly on the switching output (local control) or alternatively as binary inputs on the Instabus EIB/KNX. In the state as delivered (unprogrammed actuator), the extension inputs act directly on the switching output. This means that the actuator can be commissioned and operated already 'on site' simply by connecting the bus voltage and without further sensors.

- Inputs acting on the switching output

The extension inputs act like an external sensor only internally directly on the switching output. Input 1 controls the output. Input 2 has no function. In this case the parameter "Signal control" defines the signal evaluation, so that making-contacts or breaking-contacts can be attached to the first input. In acc. with the parameter "Mode" (n.o. or n.c. switching output), the relay output react as follows:

Signal (edge) control	Contact at input	Mode	Relay switching state
Push button (rising: TOGGLE / falling: ---)	closed (rising edge)	n.o. / n.c.	Contact toggles *
	opened (falling edge)	n.o. / n.c.	No reaction
Switch (rising: ON / falling: OFF)	closed (rising edge)	n.o.	Contact closes
	opened (falling edge)	n.o.	Contact opens
	closed (rising edge)	n.c.	Contact opens
	opened (falling edge)	n.c.	Contact closes
Switch (rising: TOGGLE / falling: TOGGLE)	closed (rising edge)	n.o. / n.c.	Contact toggles *
	opened (falling edge)	n.o. / n.c.	Contact toggles *

*: The object value of the switching object (object nummer "0") is toggled. A normally-opened contact (n.o.) is closed at "1" and opened at "0". A normally-closed contact (n.c.) is closed at "0" and opened at "1".

For direct action, the extension inputs do not have parameters of their own so that the parameter cards for the inputs are not available.

After return of bus voltage, the actuator responds to changes of the extension signal state only after the time parameterized for the "Delay on return of bus voltage" has elapsed.

During the delay, pulse edges or signals present at the inputs are not evaluated and disregarded. The time of delay is generally parameterized for all inputs and also for the output.

It is possible to parameterize a general telegram rate limitation. In this case, no switching-feedback telegram is transmitted within the first 17 s after bus voltage return when the output are controlled by the extension inputs during this time.

Actuator

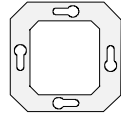

- Inputs acting separately on bus

The inputs of the switching actuator act independently of the switching output and separately on the Instabus KNX/EIB. Depending on parameterization, the functions "Switching", "Dimming", "Shutter/blind" or "Value transmitter" can be selected for each input (cf. "Parameter description"). When "No function" is selected, the corresponding input is deactivated.

When the "Switching" setting is selected, the extension objects can be combined via group addresses with the object of the switching output. The actuator can thus be controlled via its own inputs even if the extension signals are set for acting on the bus (e.g. group control of several actuators).

The functional description of the inputs on the following pages is valid only if the extensions are set for acting on the bus!

Dimming value transmitter: change by means of long key press

In the event of dimming value transmitter parameterization, the value to be transmitted can be changed by means of a long key-press (> 5 s) if the the value is to be transmitted on the rising or the falling edge. In this case, the programmed value is increased by the parameterized step width and transmitted. After releasing of the input contact, the value last transmitted remains stored. On the next long key-press, the direction of value change is reversed.

Example:

Value (0...255) 17
 Step width (1...10) 5

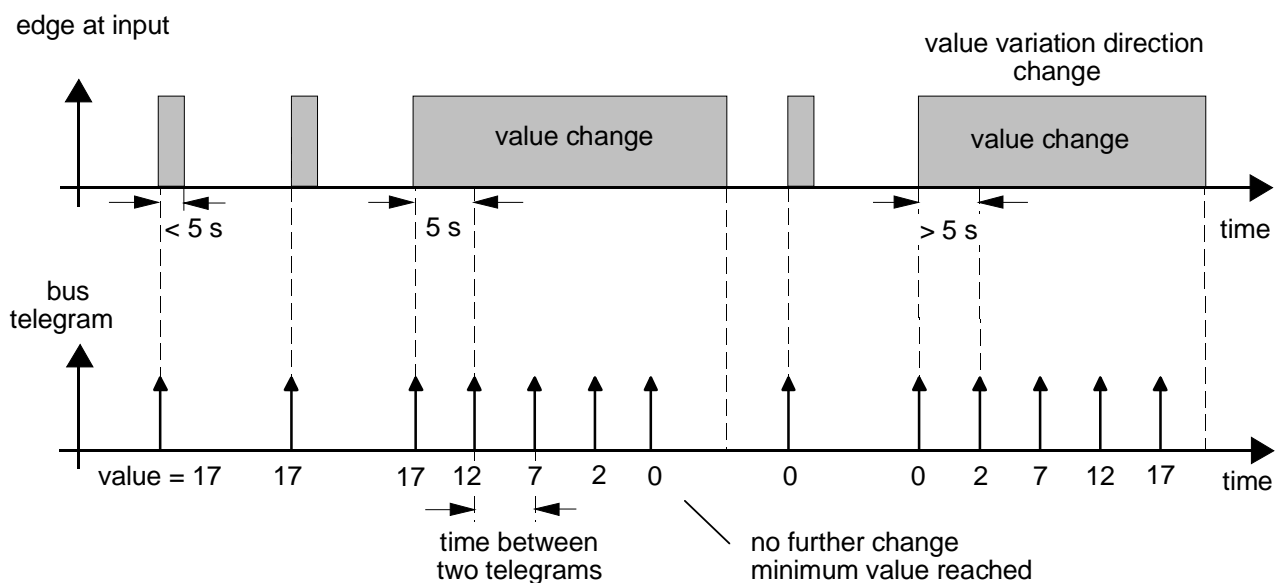

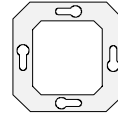
**Important:**

- During value variation there is no overrun and no underrun. When the maximum (255) resp. the minimum (0) value is reached, no more telegrams are transmitted.
- To ensure that the concerned lighting switches off or on with the max. value during value variation, the limit values (values "0" resp. "255") are always transmitted when the limits of the variation range are reached. This is also the case when the parameterized step width does not directly account for these values (cf. example above: step width = 5; value "2" is transmitted, thereafter value "0").
To ensure that the original starting value can be set again during a new change (change of variation direction), the first value jump will not correspond to the preset step width (cf. example above: step width = 5; value "0" is transmitted, thereafter values "2", "7" etc.).
- When values are changed, the newly set values are stored in the RAM.
- After a bus voltage failure or a bus reset, the changed values will be replaced by the values originally parameterized in the ETS.

Light-scene extension with / without storage function

In a parameterization as light-scene extension without storage function it is possible to recall a light-scene. In case of a rising edge, a falling edge or a rising and a falling edge, the parameterized light-scene number is transmitted immediately.

In a parameterization as light-scene extension with storage function it is possible to generate a storage telegram depending on the light-scene to be transmitted. A long actuation of the n.o. contact (rising edge) or of the n.c. contact (falling edge) causes the corresponding storage telegram to be transmitted. In this case, the time for a long press is parameterizable (however not below 5 s). After a short press < 1 s, the parameterized light-scene number (without storage telegram) is transmitted. If the actuation is longer than 1 s, but shorter than 5 s, no telegram will be transmitted at all. In addition, it is possible to transmit only a storage telegram without preceding light-scene recall. In this case, the "Storage function only" parameter must be set to "YES".

Examples for light-scene extension with storage function:

- 1.) storage function only = NO
- 2.) storage function only = YES

instabus EIB System

Actuator

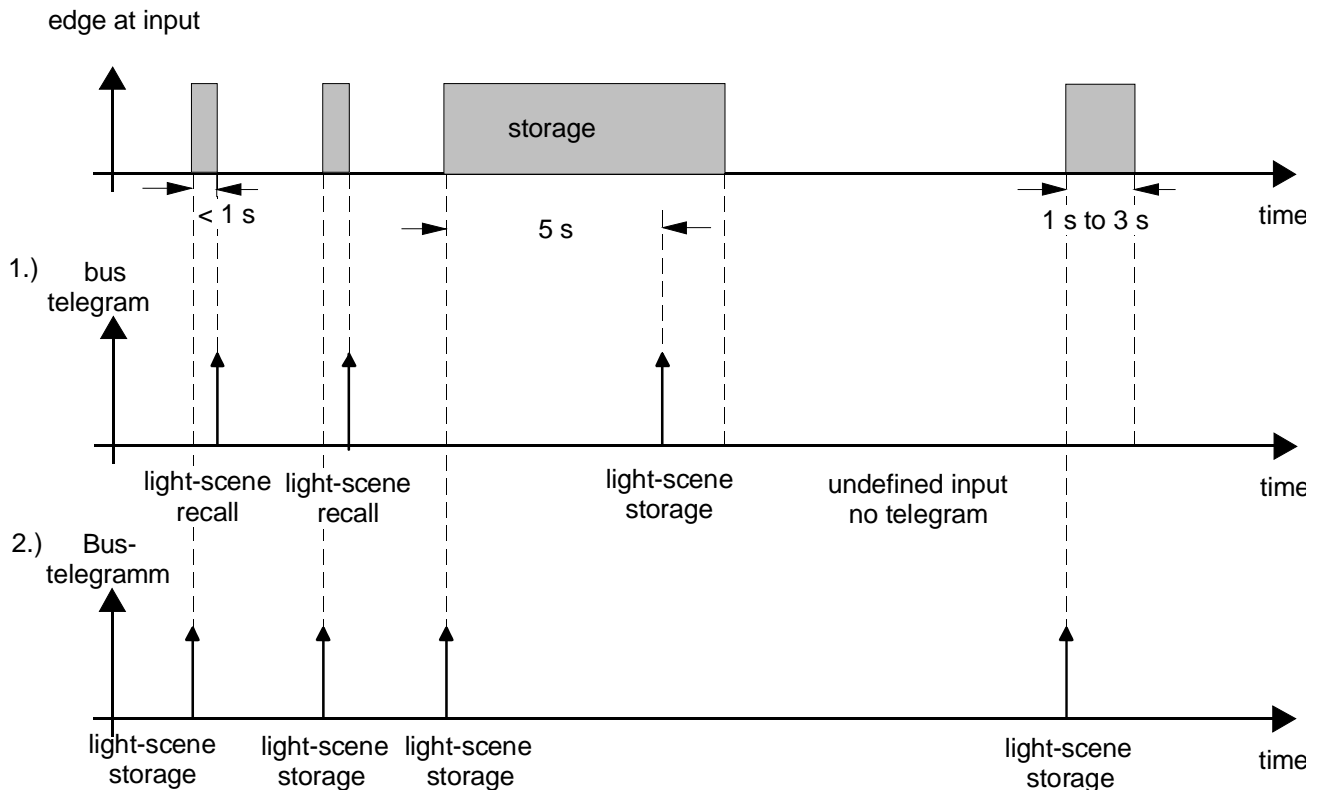
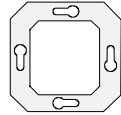

storage function only = NO:

If a rising or a falling edge is detected at the input (depending on parameterization), the timer is started. If the key is released within the first second, the corresponding light-scene is recalled immediately. If the key is pressed longer, the storage telegram is transmitted after 5 s.

storage function only = YES:

The storage telegram is transmitted immediately after detection of the corresponding edge.

Response to return of bus voltage

It is possible to define separately for each input whether a reaction or what kind of reaction is to take place on return of bus voltage so that a defined telegram can be transmitted to the bus depending on the input signal or by forced control.

The defined reaction takes place only after the parameterized "Delay on return of bus voltage" has elapsed. While the delay is active, any edges or signals present at the inputs are not evaluated and disregarded. The delay is generally parameterized for all inputs and also for the output.

It is possible to parameterize a general telegram rate limitation. In this case, no telegram is transmitted within the first 17 s after bus voltage return.

It should be noted that the parameterized "Delay on return of bus voltage" is active also during this time and that the parameterized reaction on bus voltage return is not executed if the delay elapses within the first 17 seconds.

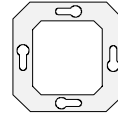

Disabling function

Each input can be independently configured for a certain reaction at the beginning or at the end of disabling. It is also possible to parameterize the input for "No reaction". Only in this case will dimming or shutter control procedures or value changes in progress before activation of the disable function continue to be executed until the end when disable is active. In all other cases, the parameterized command will be transmitted immediately at the beginning of disable. During an active disable, edges or signals at the corresponding inputs are not evaluated.

Updates on disable objects (disable or enable) will always lead to the transmission of the corresponding command parameterized for "the beginning resp. the end of disabling".

During an active disable, no cyclical transmission takes place via the disable input.

If cyclical transmission did take place before activation of the disable function, no cyclical transmission will take place anymore at the end of disable when "No reaction" is parameterized. In this case, the object value will again be transmitted cyclically only after an update on the switching object. In all other cases, the object value will again be transmitted cyclically after the end of disable.

Cyclical transmission

The object value transmitted is always the object value internally or externally followed up in the switching objects. For this reason, the object value is transmitted cyclically even if "No reaction" is assigned to a rising or a falling edge.

Cyclical transmission takes place also directly after the return of bus voltage, if the parameterized value of the telegram after bus voltage return corresponds to the object value parameterization for cyclical transmission. If telegram rate limitation is enabled, cyclical transmission will take place at the earliest after 17 seconds. During an active disable, no cyclical transmission takes place via the disabled input.

Functional description for the output

Response to return of bus voltage

The response to bus voltage failure can be defined. In this case, the contact can open or close (setting: "Close contact" or "Open contact"). The "Mode" parameter (normally open or normally closed) is irrelevant in this case.

In the "None" setting, the relay-status is not effected by the bus voltage failure

Additionally the preferred state of the switching output on return of bus voltage can be defined. In this way, the switching output closes or opens (setting: "Close contact" or "Open contact"). The "Mode" parameter (normally open or normally closed) is irrelevant in this case, too.

The switching state that was active before bus voltage failure (setting: "Value before bus voltage failure") can moreover be followed up. Timer or other activated logic-operation functions which may have been started before bus voltage failure will not be accounted for.

The switching state set after return of bus voltage will be followed up in the feedback object and in the switching object.

The defined response to bus voltage return will be triggered only after the parameterized "Delay on bus voltage return" has elapsed. Within the delay period, the output shows no reaction. Updates of the switching object via the bus during the delay period will be stored and executed only after the end of the delay.

It is possible to parameterize a general telegram rate limitation. In this case, no telegram will be transmitted via the feedback object within the first 17 s after bus voltage return.

The switching output can nevertheless be actuated via the switching object as soon as the "Delay on bus voltage return" has elapsed.

A Disabling function or a priority position activated before bus voltage failure is always deactivated after return of bus voltage.

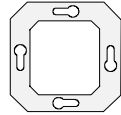

Feedback object

When the switching state of the output changes, the current switching state is transmitted to the bus via the corresponding feedback object.

The feedback object value is updated also after return of bus voltage when the parameterized delay period has elapsed and is actively transmitted to the bus. With telegram rate limitation being enabled, no telegram will be transmitted via the feedback object within the first 17 s. The feedback signal is stored and then executed after the 17 s delay has elapsed.

It may be possible to read out the object status by means of a display software (set R flag!).

Additional functions

Priority-position object:

The priority-position object can be used to force the switching output by means of 2-bit telegrams independently of the switching object separately into a switching position. The "Mode" parameter remains effective in this case, too. The value of the 2-bit telegram must have the following syntax:

Bit 1	Bit 0	Function
0	x	Priority not active, ⇔ 'switching' object
0	x	Priority not active, ⇔ 'switching' object
1	0	Priority active switching off
1	1	Priority active switching on

The first bit (bit 0) of the priority-position object determines the switching state to be forced on the output. The second bit (bit 1) of the priority-position object enables the priority-position mode.

When the priority-position mode is active (priority), any incoming switching telegrams will still be evaluated internally. When the priority-position mode is thereafter no longer active (priority), the current internal switching state will be set depending on the value of the switching object.

A priority-position mode that was active before bus voltage failure will always be inactive after return of bus voltage.

Logic-operation object:

If the logic-operation object has been parameterized, it is possible to implement a logic operation on the switching object of the corresponding output. In this case, the object values of the logic-operation object and of the switching object are combined by means of the "AND" / "OR" / "AND with feedback" operations. Depending on the result of these logic operations, the output will be activated or not.

AND with feedback:

With a logic-operation object = "0" the output is always "0" (logic AND). In this case, the feedback of the output to the switching object, resets the switching object when it is being set.

Only if the logic-operation object = "1", can the output pass to logic state "1" after a newly received "1" on the switching object.

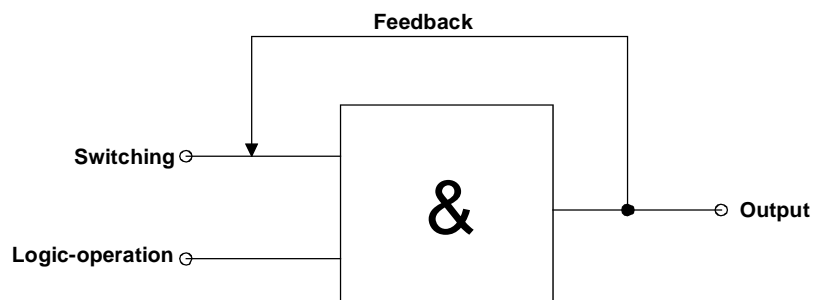

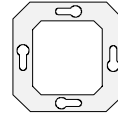

Disabling object:

If the disabling object has been parameterized, an assigned output can be locked in a parameterizable switching position after reception of a disable telegram. The polarity of the disabling object can be preselected.

When the disabling function is activated or deactivated, the response of the output can be predefined for both cases. The output can either switch on or switch off. The "Mode" parameter must be taken into account in this case.

Examples:

Mode = "n.o. contact", command "Switch off" → contact opens,

Mode = "n.o. contact", command "Switch on" → contact closes,

Mode = "n.c. contact", command "Switch off" → contact closes,

Mode = "n.c. contact", command "Switch on" → contact opens.

In the "No change" setting, the switching status before the disabling function or the switching status set by the disabling function is retained. During an active disabling function, telegrams received via the switching object will be discarded. A disabling function that was active before bus voltage failure will always be inactive after return of bus voltage.

Delivery state

In the state of the actuator as delivered (actuator not programmed), the extension input 1 act directly on the switching output. Input 2 has no function. For this reason, the actuator can be commissioned and operated already 'on site' only by connecting the bus voltage and without needing sensors.

On connection of the bus voltage, the relay contact ist opened (OFF). After return of bus voltage, the actuator responds to state changes of the extension signal only after 390 ms (delay after bus voltage return). Within the delay, any signals or edges present on the first input are not evaluated and disregarded.

When the bus voltage is applied, the extension input 1 control the switching output as follows:

Input	Contact at input	Relay switching state
1	Closed (rising edge)	Output: TOGGLE *
	Opened (falling edge)	Output: no reaction
2	No function!	

*: Switch-over of the relay-status and signal control as for push button (ON → OFF → ON → ...)

In the event of bus voltage failure, the actuator shows no reaction. There is no time function active. No group addresses are preprogrammed at factory default.

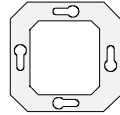

Parameters		
Description:	Values:	Comment:
General		
Mode of functioning of inputs	inputs acting on switching output (E1 -> A1 / E2 -> ---) inputs acting separately on bus	Defines whether the extension inputs of the actuator act directly on the switching output (local operation) or, as an alternative, separately from each other as binary inputs on the Instabus KNX/EIB. Only if "Mode of functioning of inputs = inputs acting separately on bus " are the input parameter cards active. The setting " Mode of functioning of inputs = inputs acting on switching output" corresponds to the delivery state.
Signal control of the inputs	Push button (rising = TOGGLE; falling = ---) Switch (rising = ON; falling = OFF) Switch (rising = TOGGLE; falling = TOGGLE)	Defines the signal evaluation of the extension input 1 when directly acting on the switching output. A push button ist attached. The object value of the switching-object will be toggled by a rising edge. A normally-open contact closes at "1" and opens at "0". A normally-closed contact closes at "0" and opens at "1". A switch is attached. Normally-open contacs close and normally-close contacs open at "1" by a rising edge. Normally-open contacs open and normally-close contacs close at "0" by a falling edge. A switch is attached. The object values of the switching-object will be toggled by a rising and a falling edge. A normally-open contact closes at "1" and opens at "0". A normally-closed contact closes at "0" and opens at "1". Only if " Mode of functioning of inputs = inputs acting on switching output"! The setting " Push button" corresponds to the delivery state.

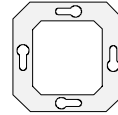

Actuator

General			
Delay on return of bus voltage Base	130 ms 260 ms 520 ms 1 s 2,1 s 4,2 s 8,4 s 17 s	34 s 1,1 min 2,2 min 4,5 min 9 min 18 min 35 min 1,2 h	After return of bus voltage, the application program of the switching actuator can be disabled for a defined period of time before the corresponding reactions take place. During this time, no signals present on the inputs will be evaluated and the switching output will not change the status either. Even a checkback signal will arrive at the earliest after the end of the delay. Defines the time base of the delay period. $\text{Time} = \text{Base} \cdot \text{Factor}$
Delay on return of bus voltage Factor (3...127)	3 bis 127, 17		Defines the time factor of the delay period. $\text{Time} = \text{Base} \cdot \text{Factor}$ Presetting: $1 \text{ s} \cdot 17 = 17 \text{ s}$
Debouncing time for binary inputs Factor (10...255) * 0.5 ms	0 to 255, 60		Defines the software debouncing time in common for all binary inputs. A signal edge at the input will be evaluated with a delay corresponding to the time defined. $\text{Time} = 0.5 \text{ ms} \cdot \text{Factor}$ Presetting: $0.5 \text{ ms} \cdot 20 = 10 \text{ ms}$
Telegram rate limitation	enabled disabled		The telegram rate limitation can be enabled or disabled. When the telegram rate limitation is enabled, no telegrams will be retransmitted in the first 17 s after bus voltage return.
Telegrams per 17 s	30 60 100 127		When the telegram rate limitation is enabled, the maximum number of telegrams in 17 s can be preset here.
Output 1			
Mode	n.o. contact n.c. contact		Defines the mode of operation. The output works as an n.o. contact: ON → contact closed OFF → contact opened The output works as an n.c. contact: ON → contact closed OFF → contact opened

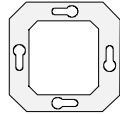

Output 1		
Response to bus voltage failure	none close contact open contact	Defines the reaction of the switching output after bus voltage failure.
Response to bus voltage return	value before bus voltage failure close contact open contact	Defines the reaction of the switching output after bus voltage return.
Time function	none turn-on delay turn-off delay turn-on and turn-off delay timer function (without turn-on delay) timer function (with turn-on delay)	Selects the desired timer function.
Turn-on delay Factor (0..127)	0 to 127, 10	Defines the time factor for the turn-on delay. Time = Base · Factor
Turn-on delay Base	130 ; 260; 520 ms 1,0; 2,1; 4,2; 8,4; 17; 34 s 1,1; 2,2; 4,5; 9; 18; 36 min 1,2 h	Defines the time factor for the turn-on delay. Time = Base · Factor
Turn-off delay Factor (0..127)	0 to 127, 10	Defines the time base for the turn-on delay. Time = Base · Factor Presetting: 10 · 130 ms = 1.3 s
Turn-off delay Base	130 ; 260; 520 ms 1,0; 2,1; 4,2; 8,4; 17; 34 s 1,1; 2,2; 4,5; 9; 18; 36 min 1,2 h	Defines the time factor for the turn-off delay. Time = Base · Factor
Turn-on and turn-off delay Base	130 ; 260; 520 ms 1,0; 2,1; 4,2; 8,4; 17; 34 s 1,1; 2,2; 4,5; 9; 18; 36 min 1,2 h	Defines the time base for the turn-off delay. Time = Base · Factor Presetting: 10 · 130 ms = 1.3 s
Reaction to OFF telegram	switch off ignore OFF telegram	Defines the reaction of the switching actuator on reception of an OFF telegram with active timer function.
Feedback	none non-inverted inverted	Defines whether and how feedbacking is effected via the feedback object.
Additional function (HA)	none logic-operation object disabling object priority-position object	Defines whether additional function is on or off.

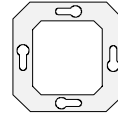

Output 1, Logic operation (only with "Additional function = Logic-operation object") (HA)		
Logic operation (HA)	none OR AND AND with feedback	Defines the logic operation.
Output 1, Disabling (only with "Additional function = Disabling object") (HA)		
Disabling object polarity (HA)	enabled = 0, disabled = 1 enabled = 1, disabled = 0	Defines whether disabling is effected on reception of an ON or an OFF telegram.
Function at the beginning of disabling (HA)	no change switch off switch on	Defines the reaction of the switching output at the beginning of disabling via the disabling object.
Function at the end of disabling (HA)	no change switch off switch on	Defines the reaction of the switching output at the end of disabling via the disabling object.
Input 1 (only if " Mode of functioning of inputs = inputs acting separately on bus")		
Function channel 1	no function switching dimming shutter/blind value transmitter	Defines the function of input 1.
Function of input 1 = "No function"		
		No further parameters!
Function of input 1 = "Switching"		
Command on rising edge Switching object 1.1	no reaction ON OFF TOGGLE	Defines the command transmitted via switching object 1.1 on the rising edge. "TOGGLE" toggles the object value.
Command on falling edge Switching object 1.1	no reaction ON OFF TOGGLE	Defines the command transmitted via switching object 1.1 on the falling edge. "TOGGLE" toggles the object value.
Command on rising edge Switching object 1.2	no reaction ON OFF TOGGLE	Defines the command transmitted via switching object 1.2 on the rising edge. "TOGGLE" toggles the object value.
Command on falling edge Switching object 1.2	no reaction ON OFF TOGGLE	Defines the command transmitted via switching object 1.2 on the falling edge. "TOGGLE" toggles the object value.

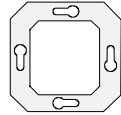

Function of input 1 = "Switching"																		
Response to bus voltage return	<p>no reaction</p> transmit current input status	Permits defining the reaction that is to take place after return of bus voltage. The parameterized delay after return of bus voltage must have elapsed before the reaction defined will be executed.																
	transmit ON telegram	No reaction.																
	transmit OFF telegram	The current input state corresponding to the parameterization for rising and falling edge is transmitted.																
		Transmits an ON signal.																
		Transmits an OFF signal.																
Cyclical transmission?	<p>no cyclical transmission</p> repeat when ON	Cyclical transmission can be realized via the switching objects depending on the object value.																
	repeat when OFF	No cyclical transmission.																
	repeat when ON and OFF	Cyclical transmission active when the object value is "ON".																
		Cyclical transmission active when the object value is "OFF".																
		Cyclical transmission always active independent of object value.																
Time base for cyclical transmission Switching object 1.1	<table border="0"> <tr><td>1 s</td><td>1,1 min</td></tr> <tr><td>2,1 s</td><td>2,2 min</td></tr> <tr><td>4,2 s</td><td>4,5 min</td></tr> <tr><td>8,4 s</td><td>9 min</td></tr> <tr><td>17 s</td><td>18 min</td></tr> <tr><td>34 s</td><td>35 min</td></tr> <tr><td>1,1 min</td><td>1,2 h</td></tr> <tr><td>34 s</td><td></td></tr> </table>	1 s	1,1 min	2,1 s	2,2 min	4,2 s	4,5 min	8,4 s	9 min	17 s	18 min	34 s	35 min	1,1 min	1,2 h	34 s		Defines the time base for cyclical transmission via switching object 1.1.
1 s	1,1 min																	
2,1 s	2,2 min																	
4,2 s	4,5 min																	
8,4 s	9 min																	
17 s	18 min																	
34 s	35 min																	
1,1 min	1,2 h																	
34 s																		
		Time = Base · Factor																

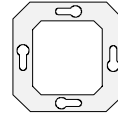

Funktion des Eingangs 1 = "Schalten"		
Time base for cyclical transmission Switching object 1.2	1 s 2,1 s 4,2 s 8,4 s 17 s 34 s 1,1 min 34 s 1,1 min 2,2 min 4,5 min 9 min 18 min 35 min 1,2 h no cyclical transmission via switching object X.2	Defines the time base for cyclical transmission via switching object 1.2. Cyclical transmission via switching object 1.2 can be disabled when "No cyclical transmission via switching object X.2" is selected. Time = Base · Factor
Time base for cyclical transmission Switching object 1.1 and 1.2 Factor (3...127)	3 to 127, 60	Defines the time base for cyclical transmission via both switching objects. Time = Base · Factor Presetting: 1 s · 60 = 60 s
Input 1, Disabling (HA)		
Disabling function (HA)	enabled disabled	The Disabling function can be enabled or disabled.
Disabling object polarity (HA)	disable = 1 (enable = 0) disable = 0 (enable = 1)	This parameter defines the polarity of the disabling object.
Response at the beginning of disabling Switching objects 1.1 and 1.2 (HA)	no reaction ON OFF TOGGLE	When disabling is active, both switching objects are disabled. This parameter defines the command transmitted at the beginning of disabling via both switching objects. "TOGGLE" toggles the object values.
Response at the end of disabling Switching objects 1.1 and 1.2 (HA)	no reaction ON OFF transmit current input status	When disabling is active, both switching object are disabled. This parameter defines the command transmitted at the end of disabling via both switching objects. When the value is "Transmit current input status", the current input status will be transmitted corresponding to the parameterization for the rising and the falling edge.

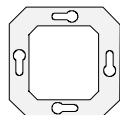

Function of input 1 = "Dimming"		
Operation	<p>single-button operation: brighter / darker (TOGGLE)</p> <p>double-button operation: brighter (ON)</p> <p>double-button operation: darker (OFF)</p> <p>double-button operation: brighter (TOGGLE)</p> <p>double-button operation: darker (TOGGLE)</p>	<p>Defines the response to a rising edge on the input.</p> <p>After a brief press of the button at the input, the object value of the switching object is toggled and a corresponding telegram transmitted. A long press triggers a dimming telegram (brighter / darker). The dimming direction is stored only internally and toggled for successive dimming cycles.</p> <p>A short press of the button on the input sends an ON telegram, whereas a long press triggers a dimming telegram (brighter).</p> <p>A short press of the button on the input sends an OFF telegram, whereas a long press triggers a dimming telegram (brighter).</p> <p>A short press of the button on the input toggles the object value of the switching object and sends a corresponding telegram, whereas a long press triggers a dimming telegram (brighter).</p> <p>A short press of the button on the input toggles the object value of the switching object and sends a corresponding telegram, whereas a long press triggers a dimming telegram (darker).</p>
Time between switching and dimming Base	<p>130 ms</p> <p>260 ms</p> <p>520 ms</p> <p>1 s</p>	<p>Time after which the dimming function is executed ("long press").</p> <p>Time = Base · Factor</p>
Time between switching and dimming Factor (4...127)	<p>4 to 127, 4</p>	<p>Time after which the dimming function is executed ("long press").</p> <p>Time = Base · Factor</p> <p>Presetting: 130 ms · 4 = 520 ms</p>

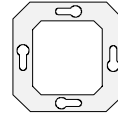

 Function of input 1 = "Dimming"		
Response to bus voltage return	<p>no reaction</p> <p>transmit ON telegram</p> <p>transmit OFF telegram</p>	<p>The reaction taking place after bus voltage return can be defined.</p> <p>If a delay after bus voltage return is parameterized, this delay must have elapsed before the defined reaction will take place.</p> <p>No reaction.</p> <p>Transmits an ON signal.</p> <p>Transmits an OFF signal.</p>
Increase brightness by	<p>100 % 6 %</p> <p>50 % 3 %</p> <p>25 % 1,5 %</p> <p>12,5 %</p>	<p>A dimming telegram permits increasing the brightness by a max. value of X %. This parameter defines the max. dimming step width of a dimming telegram.</p> <p>The parameter is independent of the operation preset.</p>
Reduce brightness by	<p>100 % 6 %</p> <p>50 % 3 %</p> <p>25 % 1,5 %</p> <p>12,5 %</p>	<p>A dimming telegram permits reducing the brightness by a max. value of X %. This parameter defines the max. dimming step width of a dimming telegram.</p> <p>This parameter is independent of the operation preset.</p>
Transmit stop telegram?	<p>YES</p> <p>NO</p>	<p>When a button on the input is released (falling edge), a stop telegram is transmitted or not.</p>
Repeat telegram ?	<p>YES</p> <p>NO</p>	<p>Cyclical repetition of dimming telegrams during a long press.</p>
Time between two telegrams Base	<p>130 ms</p> <p>260 ms</p> <p>520 ms</p> <p>1 s</p>	<p>Time between two telegrams when telegram repetition is selected.</p> <p>After this time, a new telegram will be sent. Only if "Repeat telegram ?" = "YES".</p> <p>Time = Base · Factor</p>
Time between two telegrams Factor (3...127)	<p>3 to 127, 10</p>	<p>Time between two telegrams when telegram repetition is selected.</p> <p>After this time, a new dimming telegram will be sent. Only if "Repeat telegram ?" = "YES".</p> <p>Time = Base · Factor</p> <p>Presetting: 130 ms · 10 = 1.3 s</p>

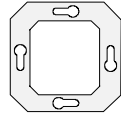

Input 1, Disabling (HA)		
Disabling function (HA)	enabled disabled	The Disabling function can be enabled or disabled.
Disabling object polarity (HA)	disable = 1 (enable = 0) disable = 0 (enable = 1)	This parameter defines the polarity of the disabling object.
Response at the beginning of disabling (HA)	no reaction ON OFF TOGGLE	This parameter defines the command transmitted at the beginning of disabling via the switching object. "TOGGLE" toggles the object values.
Response at the end of disabling (HA)	no reaction OFF	This parameter defines the command transmitted at the end of disabling via the switching object.
Function of input 1 = "Shutter/blind"		
Command on rising edge	no function UP DOWN TOGGLE	Defines the response to a rising edge at the input. Input deactivated. A brief press triggers a STEP telegram (UP), a long press triggers a MOVE telegram (up). A brief press triggers a STEP telegram (DOWN), a long press triggers a MOVE telegram (down). This setting toggles the travel direction internally for each long press (MOVE). When a STEP telegram is transmitted by a brief press, this STEP always occurs in opposite direction to the last MOVE. Several successive STEP telegrams occur in the same direction.
Response to bus voltage return	no reaction UP DOWN	The reaction taking place after bus voltage return can be defined. If a delay after bus voltage return is parameterized, this delay must have elapsed before the defined reaction will take place. No reaction. Transmits a MOVE (UP) command. Transmits a MOVE (DOWN) command.

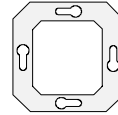

 Function of input 1 = "Shutter/blind"

Operating concept

step – move - step

Defines the telegram sequence after a key-press (rising edge).

Step - move - step:

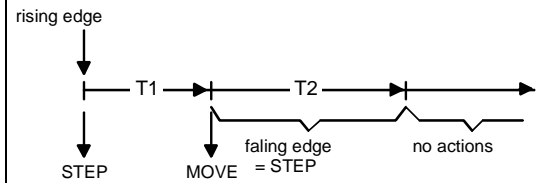

A rising edge sends a STEP and time T1 (time between short- and MOVE operation) is started. This STEP serves the purpose of stopping a continuous run. If a falling edge is detected within T 1, the binary input sends no further telegram.

If no falling edge has been detected during T 1, the binary input automatically sends a MOVE after T1 and time T 2 is started (slat adjusting time). If a falling edge is then detected within T 2, the binary input sends a STEP. This function is used for the adjustment of the slats. T2 should correspond to the time required for a slat rotation through 180°.

move - step

Move - step:

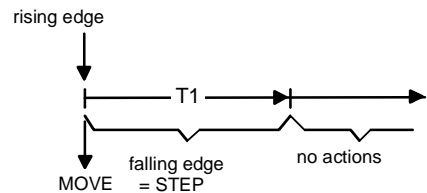

A rising edge at the input sends a MOVE and time T1 (slat adjusting time) is started. If a falling edge is detected within T 1, the binary input sends a STEP. This function is used for the adjustment of the slats. T1 should correspond to the time needed for a slat rotation through 180°.

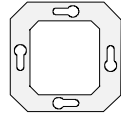

Function of input 1 = "Shutter/blind"		
Time between STEP and MOVE operation Base	130 ms 260 ms 520 ms 1 s 2,1 s 4,2 s	8,4 s 17 s 34 s 1,1 min 34 s Time = base · factor
Time between STEP and MOVE operation Factor (4...127)	4 to 127, 4	Time after which the MOVE operation function is executed Only with operating concept = "Step - move - step" Time = base · factor Presetting: 130 ms · 4 = 520 ms
Slat adjustment time Base	130 ms 260 ms 520 ms 1 s 2,1 s 4,2 s	8,4 s 17 s 34 s 1,1 min 34 s Time = base · factor
Slat adjustment time Factor (3...127)	3 to 127, 20	Time during which a MOVE telegram for slat adjustment can be terminated by releasing the push button at the input Time = base · factor Presetting: 130 ms · 20 = 2.6 s
Input 1, Disabling (HA)		
Disabling function (HA)	enabled disabled	The Disabling function can be enabled or disabled.
Disabling object polarity (HA)	disable = 1 (enable = 0) disable = 0 (enable = 1)	This parameter defines the polarity of the disabling object.
Response at the beginning of disabling (HA)	no reaction ON OFF TOGGLE	This parameter defines the command transmitted at the beginning of disabling via the MOVE object. "TOGGLE" toggles the running direction last executed (stored internally).
Response at the end of disabling (HA)	no reaction ON OFF TOGGLE	This parameter defines the command transmitted at the end of disabling via the MOVE object. "TOGGLE" toggles the running direction last executed (stored internally).

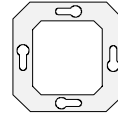

 Function of input 1 = "Value transmitter"		
Function as	dimming value transmitter light-scene recall without storage function light-scene recall with storage function	Defines the function to be executed.
Value transmitter function = "Dimming value transmitter"		
Transmit value	on rising edge (push button as n.o. contact) on falling edge (push button as n.c. contact) on rising and falling edge (switch)	Defines the edge triggered by a press.
Value on rising edge (0...255)	0 to 255, 100	Defines the value transmitted on a rising edge. Only if "Transmit value = on rising edge (push button as n.o. contact)" and "Transmit value = on rising and falling edge (switch)".
Value on falling edge (0...255)	0 to 255, 0	Defines the value transmitted on a falling edge. Only if "Transmit value = on falling edge (push button as n.c. contact)" and "Transmit value = on rising and falling edge (switch)".

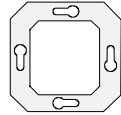

Value transmitter function = "Dimming value transmitter"		
Response to bus voltage return	<p>no reaction</p> <p>reaction as with rising edge</p> <p>reaction as with falling edge</p> <p>transmit current input state</p>	<p>Permits defining the reaction that is to take place after return of bus voltage. If a delay after return of bus voltage has been parameterized, this delay must have elapsed before the reaction defined will be executed.</p> <p>No reaction</p> <p>The value parameterized for the rising edge will be transmitted. Only if "Transmit value = on rising edge (push button as n.o. contact)" and "Transmit value = on rising and falling edge (switch)".</p> <p>The value parameterized for the falling edge will be transmitted. Only if "Transmit value = on falling edge (push button as n.c. contact)" and "Transmit value = on rising and falling edge (switch)".</p> <p>The current state of the inputs corresponding to the parameterization for rising and falling edge will be transmitted. Only if "Transmit value = on rising and falling edge (switch)".</p>
Value change by long press?	<p>YES</p> <p>NO</p>	<p>With a long press (< 5 s), the current value can be cyclically reduced or increased by the parameterized step width (see below) and transmitted. After this value variation, the value last transmitted remains stored. The parameter defines whether a value change is possible. Only if "Transmit value = on rising edge (push button as n.o. contact)" and "Transmit value = on falling edge (push button as n.c. contact)"</p>
Time between two telegrams Base	<p>130 ms</p> <p>260 ms</p> <p>520 ms</p> <p>1 s</p>	<p>Time base for the time between two cyclical telegrams for value change. Only if "Value change by long press ?= YES"</p>

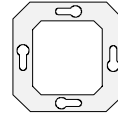

Value transmitter function = "Dimming value transmitter"		
Time between two telegrams Factor (3...127)	3 to 127, 3	Time factor for the time between two cyclical telegrams for value variation. Only if "Value change by long press ?= YES" Time = Base · Factor Presetting: 520 ms · 3 = 1.56 s
Step width (1...10)	1 to 10, 10	Width of the step by which the set value will be reduced or increased by a long press. Only if "Change value by long press ?= YES"
 Input 1, Disabling (HA)		
Disabling function (HA)	enabled disabled	The Disabling function can be enabled or disabled.
Disabling object polarity (HA)	disable = 1 (enable = 0) disable = 0 (enable = 1)	This parameter defines the polarity of the disabling object.
Response at the beginning of disabling (HA)	no reaction reaction as with rising edge reaction as with falling edge transmit current input state	This parameter defines the reaction taking place at the beginning of disabling. No reaction The value parameterized for the rising edge will be transmitted. Only if "Transmit value = on rising edge (push button as n.o. contact)" and "Transmit value = on rising and falling edge (switch)". The value parameterized for the falling edge will be transmitted. Only if "Transmit value = on falling edge (push button as n.c. contact)" and "Transmit value = on rising and falling edge (switch)" The current state of the inputs corresponding to the parameterization for rising and falling edge will be transmitted. Only if "Transmit value = on rising and falling edge (switch)".

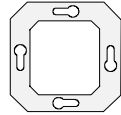

<p> Input 1, Disabling (HA)</p>		
<p>Response at the end of disabling (HA)</p>	<p>no reaction</p> <p>reaction as with rising edge</p> <p>reaction as with falling edge</p> <p>transmit current input state</p>	<p>This parameter defines the reaction taking place at the end of disabling.</p> <p>No reaction</p> <p>The value parameterized for the rising edge will be transmitted.</p> <p>Only if "Transmit value = on rising edge (push button as n.o. contact)" and "Transmit value = on rising and falling edge (switch)"</p> <p>The value parameterized for the falling edge will be transmitted.</p> <p>Only if "Transmit value = on falling edge (push button as n.c. contact)" and "Transmit value = on rising and falling edge (switch)".</p> <p>The current state of the inputs corresponding to the parameterization for rising and falling edge will be transmitted.</p> <p>Only if "Transmit value = on rising and falling edge (switch)".</p>
<p>Value transmitter function = "Light-scene extension without storage function"</p>		
<p>Transmit light-scene number</p>	<p>on rising edge (push button as n.o. contact)</p> <p>on falling edge (push button as n.c. contact)</p> <p>on rising and falling edge (switch)</p>	<p>Defines the edge triggered by a press.</p>
<p>Light-scene on rising edge (1...64)</p>	<p>1 to 64, 1</p>	<p>Defines the light-scene transmitted on a rising edge.</p> <p>Only if "Transmit light-scene number = on rising edge (push button as n.o. contact)" and "Transmit value = on rising and falling edge (switch)"</p>
<p>Light-scene on falling edge (1...64)</p>	<p>1 to 64, 1</p>	<p>Defines the light-scene transmitted on a falling edge.</p> <p>Only if "Transmit light-scene number = on falling edge (push button as n.c. contact)" and "Transmit value = on rising and falling edge (switch)"</p>

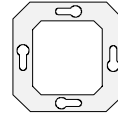

Value transmitter function = "Light-scene extension without storage function"		
Response to bus voltage return	<p>no reaction</p> <p>Reaction as with rising edge</p> <p>Reaction as with falling edge</p> <p>Transmit current input state</p>	<p>Permits defining the reaction that is to take place after return of bus voltage. If a delay after return of bus voltage has been parameterized, this delay must have elapsed before the reaction defined will be executed.</p> <p>No reaction</p> <p>The value parameterized for the rising edge will be transmitted.</p> <p>Only if "Transmit light-scene number = on rising edge (push button as n.o. contact)" and "Transmit light-scene number = on rising and falling edge (switch)"</p> <p>The light-scene parameterized for the falling edge will be transmitted.</p> <p>Only if "Transmit light-scene number = on falling edge (push button as n.c. contact)" and "Transmit light-scene number = on rising and falling edge (switch)"</p> <p>The current state of the inputs corresponding to the parameterization for rising and falling edge will be transmitted.</p> <p>Only if "Transmit light-scene number = on rising and falling edge (switch)"</p>
 Input 1, Disabling (HA)		
Disabling function (HA)	<p>enabled</p> <p>disabled</p>	The Disabling function can be enabled or disabled.
Disabling object polarity (HA)	<p>disable = 1 (enable = 0)</p> <p>disable = 0 (enable = 1)</p>	This parameter defines the polarity of the disabling object.

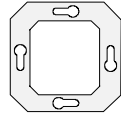

<p> Input 1, Disabling (HA)</p>		
<p>Response at the beginning of disabling (HA)</p>	<p>no reaction</p> <p>reaction as with rising edge</p> <p>reaction as with falling edge</p> <p>transmit current input state</p>	<p>This parameter defines the reaction taking place at the beginning of disabling.</p> <p>No reaction</p> <p>The value parameterized for the rising edge will be transmitted.</p> <p>Only if "Transmit value = on rising edge (push button as n.o. contact)" and "Transmit value = on rising and falling edge (switch)"</p> <p>The value parameterized for the falling edge will be transmitted.</p> <p>Only if "Transmit value = on falling edge (push button as n.c. contact)" and "Transmit value = on rising and falling edge (switch)"!</p> <p>The current state of the inputs corresponding to the parameterization for rising and falling edge will be transmitted.</p> <p>Only if "Transmit value = on rising and falling edge (switch)".</p>
<p>Response at the end of disabling (HA)</p>	<p>no reaction</p> <p>reaction as with rising edge</p> <p>reaction as with falling edge</p> <p>transmit current input state</p>	<p>This parameter defines the reaction taking place at the end of disabling.</p> <p>No reaction</p> <p>The value parameterized for the rising edge will be transmitted.</p> <p>Only if "Transmit value = on rising edge (push button as n.o. contact)" and "Transmit value = on rising and falling edge (switch)"</p> <p>The value parameterized for the falling edge will be transmitted.</p> <p>Only if "Transmit value = on falling edge (push button as n.c. contact)" and "Transmit value = on rising and falling edge (switch)".</p> <p>The current state of the inputs corresponding to the parameterization for rising and falling edge will be transmitted.</p> <p>Only if "Transmit value = on rising and falling edge (switch)".</p>

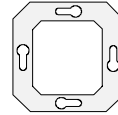

Value transmitter function = "Light-scene extension with storage function"		
Transmit light-scene number	on rising edge (push button as n.o. contact) on falling edge (push button as n.c. contact)	Defines the edge triggered by a press.
Light-scene on rising edge (1...64)	1 to 64, 1	Defines the light-scene transmitted on a rising edge. Only if "Transmit light-scene number = on rising edge (push button as n.o. contact)"
Light-scene on falling edge (1...64)	1 to 64, 1	Defines the light-scene transmitted on a falling edge. Only if "Transmit light-scene number = on falling edge (push button as n.c. contact)"
Response to bus voltage return	no reaction Reaction as with rising edge reaction as with falling edge	Permits defining the reaction that is to take place after return of bus voltage. If a delay after return of bus voltage has been parametrized, this delay must have elapsed before the reaction defined will be executed. No reaction The light-scene parameterized for the rising edge will be transmitted. Only if "Transmit light-scene number = on rising edge (push button as n.o. contact)" Defines the light-scene transmitted on a falling edge. Only if "Transmit light-scene number = on falling edge (push button as n.c. contact)"
Storage function only ?	YES NO	It is possible to send only a storage telegram without preceding light-scene recall.
Time of a long press for storage Base	130 ms ¹⁾ 260 ms ²⁾ 520 ms ³⁾ 1 s ⁴⁾	Time base for the time of a long press to transmit a storage telegram. Only if "Storage function only? = NO" Time = Base · Factor

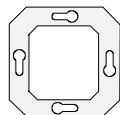

Value transmitter function = "Light-scene extension with storage function"		
Time of a long press for storage Factor (24...127) ¹⁾ Factor (13...127) ²⁾ Factor (9...127) ³⁾ Factor (4...127) ⁴⁾	24 to 127, 38 ¹⁾ 13 to 127, 19 ²⁾ 9 to 127, 10 ³⁾ 4 to 127, 5 ⁴⁾	Time factor for the time of a long press to transmit a storage telegram Only if "Storage function only? = NO" Time = Base · Factor Presetting: 520 ms · 10 = 5.2 s Important: The factor range depends on the selected base. Therefore, only times > 3 s can be parameterized.
Input 1, Disabling (HA)		
Disabling function (HA)	enabled disabled	The Disabling function can be enabled or disabled.
Disabling object polarity (HA)	disable = 1 (enable = 0) disable = 0 (enable = 1)	This parameter defines the polarity of the disabling object.
Response at the beginning of disabling (HA)	no reaction reaction as with rising edge reaction as with falling edge	This parameter defines the reaction taking place at the beginning of disabling. No reaction The value parameterized for the rising edge will be transmitted. Only if "Transmit value = on rising edge (push button as n.o. contact)" The value parameterized for the falling edge will be transmitted. Only if "Transmit value = on falling edge (push button as n.c. contact)"
Response at the end of disabling (HA)	no reaction reaction as with rising edge reaction as with falling edge	This parameter defines the reaction taking place at the end of disabling. No reaction The value parameterized for the rising edge will be transmitted. Only if "Transmit value = on rising edge (push button as n.o. contact)" The value parameterized for the falling edge will be transmitted Only if "Transmit value = on falling edge (push button as n.c. contact)"
Input 2 see input 1!		