

KNX module for smoke alarm devices Dual/VdS and Q-Label
(Order no 2343 00)



Table of contents

1	Product definition	3
1.1	Product catalogue	3
1.2	Accessories	3
1.3	Application	3
2	Installation, electrical connection and operation	4
2.1	Safety notes	4
2.2	Device design	5
2.3	Mounting and electrical connection	6
2.4	Start-up	7
3	Technical data	8
4	Software description	9
4.1	Software specification	9
4.2	Software KNX module for smoke alarm device Dual/VdS	10
4.2.1	Range of functions	10
4.2.2	Information on the software	11
4.2.3	Object table	12
4.2.4	Functional description	18
4.2.5	State of delivery	19
4.2.6	Parameters	20

1 Product definition

1.1 Product catalogue

Product name: Gira KNX smoke alarm device module
Application: KNX connection of smoke alarm device Dual/VdS
Design: Installation
Order No.: 2343 00

1.2 Accessories

Smoke alarm device Dual/VdS
Order No.: 2330 02

1.3 Application

The Gira KNX smoke alarm device module connects a smoke alarm device Dual/VdS to Instabus KNX lines.

It allows several smoke detectors Dual/VdS which are equipped with the Gira KNX smoke alarm device module to be networked.

The module enables local alarms to be sent to the KNX bus and alarms to be received via the KNX bus.

Alarms which the smoke alarm device receives via the 2-wire bus can be forwarded to the KNX bus via the module and received again and processed by alarm devices networked via KNX.

Differentiating between local and remote alarms is possible but not necessarily required, a joint message is performed depending on the parameterisation. Configuring the alarm transmission interval is possible.

The Gira KNX smoke alarm device module also enables monitoring the connected smoke alarm device. For this purpose, various pieces of state information from the smoke alarm device are made available via the KNX bus, for example the state of the battery. In addition, a general fault object is provided which can send to the KNX bus in configurable intervals and/or in case of a fault.

The Gira KNX smoke alarm device module can also query the values recorded by the smoke alarm device as a temperature sensor and make them available on the KNX bus. For this, the ambient temperature is sent cyclically per day.

Using the module, the connected smoke alarm device can be used as a signal transmitter. A signal tone can be triggered by a received KNX telegram. It can then be deactivated again after a defined period of time or by another KNX telegram.

2 Installation, electrical connection and operation

2.1 Safety notes

Electrical devices may only be installed and mounted by a qualified electrician. In doing so, the applicable accident prevention regulations must be observed. Failure to observe the installation instructions can result in damage to the device, fire or other dangers.

The Gira smoke alarm device should only be planned, mounted and serviced by a "Certified expert for smoke alarm devices in accordance with DIN EN 14676".

Smoke alarm devices which are planned, mounted or serviced improperly represent a risk because ideal smoke detection may not be able to be guaranteed.

For this purpose, Gira offers the "Certified expert for smoke alarm devices in accordance with DIN 14676" online course, complete with certificate.

It can be viewed online by clicking on the following link: <http://akademie.gira.de>

Please see the operating instructions enclosed with the device for more information.

2.2 Device design

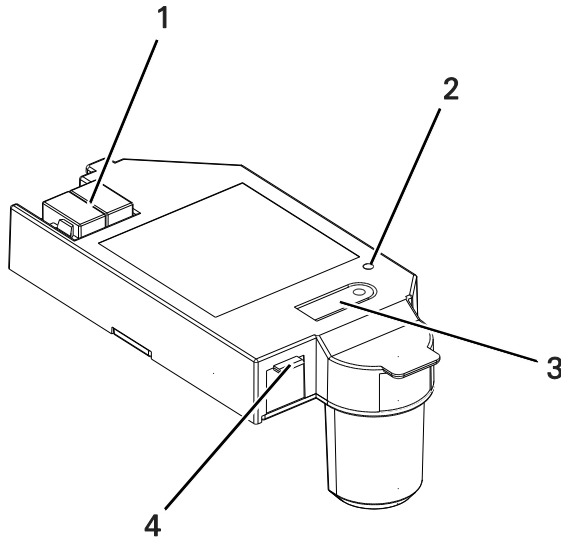

1 KNX connection

2 Programming LED (red)

3 Programming button

4 Latch

2.3 Mounting and electrical connection

Module

1. Connect the KNX bus to the KNX connection of the Gira KNX smoke alarm device module via the connection terminal (1).
2. Connect the 9 V monoblock battery to the battery connection and insert the battery into the battery compartment. The smoke alarm device cannot be latched into the mounting plate or 230 V base when no battery is inserted.
3. Insert the Gira KNX module into the module interface of the smoke alarm device. The insert pins must lock.
4. Fasten the smoke alarm device to the mounting plate or the 230 V base for smoke alarm devices.
5. Perform a function test.

2.4 Start-up

The device can be started up after mounting the device and connecting the bus line. (The module can also be started up when not inserted).

The following physical address is factory preset
15.15.255

This address has to be reprogrammed in order to be able to use the device.

Programming the physical address of the module

Programming is done in the programming environment of the ETS (3.0f, 4.0 or higher). An additional KNX data interface is required for programming.

- Make sure that the bus voltage is switched on.
- Press the programming button (3).
Programming LED (2) lights up red
- Program the physical address using the ETS.
Programming LED goes out after a successful programming process.
- Make note of the physical address on the device

Programming the application programme and configuration data

After programming the physical addresses, the application program must be imported to the device.

- Make sure that the bus voltage is switched on.
- Parameterise the device accordingly in the ETS
- Import the software to the device
- Start-up is complete

3 Technical data

KNX medium	TP
Start-up mode	S mode (ETS)
KNX connection	Bus connection terminal
Power consumption	typ. 0.5 W
Ambient temperature	-10 °C to +65 °C
Storage temperature	-20 °C to +65 °C
Installation width	38 mm
Installation height	82 mm
Installation depth	30 mm
Protection type	IP20 (compliant with EN60529)
protection class	III (compliant with IEC 61140)
Test marks	KNX, CE

4 Software description

4.1 Software specification

ETS search paths: Security / smoke alarm devices

Configuration: S-mode standard

Applications:

No	Brief description	Name	Version
1	Gira KNX smoke alarm device	KNX module for smoke alarm device Dual/VdS	1.0

4.2 Software KNX module for smoke alarm device Dual/VdS

4.2.1 Range of functions

- Networking smoke alarm devices
- Monitoring the state of smoke alarm devices

4.2.2 Information on the software

- The Gira KNX smoke alarm device module can be parameterised for ETS 3.0f or higher.
- The Gira KNX smoke alarm device module is protected against importing an invalid application version.

4.2.3 Object table

Number of communication objects: 19
 Number of addresses (max): 36
 Number of assignments (max): 36
 Dynamic table management: no
 Maximum table length: 36

Function: Alarm function
 Combine local and wired alarm = yes
 Send message cyclically
 Send alarm

Object	Function	Name	Type	DP type	Flag*
 0	Send	Alarm	1-bit	ETS4 1,005	C, R, T

Description: 1-bit object for signalling an alarm. Only visible when the "Combine local and wired alarm" parameter is set to "yes". This is triggered by a local heat alarm, a local smoke alarm, a local test alarm and an alarm received via the networking terminal. A "1" is sent when the alarm has been triggered. Sent cyclically when "Alarm repetition" is activated.

Function: Alarm function
 Parameter: Combine local and wired alarm = no

Object	Function	Name	Type	DP type	Flag*
 0	Send	Local alarm	1-bit	ETS4 1,005	C, R, T

Description: 1-bit object for signalling a local alarm. Only visible when the "Combine local and wired alarm" parameter is set to "no". This is triggered by a local heat alarm, a local smoke alarm, and a local test alarm. A "1" is sent when the alarm has been triggered. Sent cyclically when "Alarm repetition" is activated.

Function: Alarm function

Parameter: Send message cyclically

Send alarm

Combine local and wired alarm = no

Object	Function	Name	Type	DP type	Flag*
 1	Send	Wired alarm	1-bit	ETS4 1,005	C, R, T

Description: 1-bit object for signalling an alarm which was signalled via a 2-wire line. A "1" is sent when the alarm has been triggered. Sent cyclically when "Alarm repetition" is activated.

Function: Alarm function status output

Object	Function	Name	Type	DP type	Flag*
 2	Send	Smoke alarm status	1-bit	1,002	C, R, T

Description: 1-bit object for signalling a local smoke alarm. A "true" is sent when the alarm has been triggered.

Function: Alarm function status output

Object	Function	Name	Type	DP type	Flag*
 3	Send	Heat alarm status	1-bit	1,002	C, R, T

Description: 1-bit object for signalling a local heat alarm. A "1" is sent when the alarm has been triggered.

Function: Alarm function status output

Object	Function	Name	Type	DP type	Flag*
 4	Send	Status alarm via wire	1-bit	1,002	C, R, W

Description: 1-bit object for signalling an alarm which was signalled via a 2-wire line. A "1" is sent when the alarm has been triggered.

Function: Alarm function input

Object	Function	Name	Type	DP type	Flag*
 5	Receive	Auxiliary unit alarm	1-bit	1,003	C, R, W, A

Description: 1-bit object for activating an alarm. When a "1" is assigned to the object, the smoke detector emits an alarm. Simultaneously the state is transferred to the communication object 5 "Status alarm via KNX". This only works when the smoke detector is inserted.

Smoke alarm devices are networked with one another via KNX using this communication object. Depending on the object value, the alarm is also activated via the 2-wire bus.

Function: Alarm function status output

Object	Function	Name	Type	DP type	Flag*
 6	Send	Status of alarm via KNX	1-bit	1,002	C, R, T

Description: 1-bit object for signalling an alarm which was signalled via the auxiliary units communication object. A "1" is sent when the alarm has been triggered.

Function: Alarm function input

Object	Function	Name	Type	DP type	Flag*
 7	Receive	Test alarm	1-bit	1,003	C, R, W, A

Description: 1-bit object for activating a test alarm. When a "1" is assigned to the object, the smoke detector emits a test alarm. Simultaneously the state is transferred to the communication object 7 "Status test alarm". This only works when the smoke detector is inserted.

Function: Alarm function status output

Object	Function	Name	Type	DP type	Flag*
 8	Send	Status test alarm	1-bit	1,002	C, R, T

Description: 1-bit object for signalling a test alarm which was signalled via the test alarm communication object. A "1" is sent when the test alarm has been triggered.

Function: Signal transmitter function input / output

Parameter: Switch-on duration signal tone

Object	Function	Name	Type	DP type	Flag*
 9	Receive	Signal transmitters	1-bit	1,001	C, R, W, T

Description: 1-bit object to activate the signal transmitter. When a "1" is assigned to the object, the signal transmitter is activated. An assigned "0" deactivates the signal transmitter. It is automatically deactivated after the duration set in the "Switch-on duration signal tone" parameter and sends a "0" in this case. If the switch-on time is parameterised to "unlimited", the signal can only be deactivated by a telegram. The alarm signal (test alarm) of the smoke alarm device is used as the signalling tone.

Function: Temperature function

Parameter: Send temperature cyclically

Object	Function	Name	Type	DP type	Flag*
□← 11	Send	Temperature	2-byte	9,001	C, R, T

Description: 2-byte object which provides the temperature measured by the smoke alarm device. The "Send temperature cyclically" parameter can be used to define a transmission interval or transmission condition. If the condition "per day" is set, the temperature is send once a day. The function is deactivated when "Send temperature cyclically" is parameterised to "no".

Function: Error monitoring

Parameter: Send message cyclically

Send fault

Object	Function	Name	Type	DP type	Flag*
□← 12	Send	Fault	1-bit	1,002	C, R, T

Description: 1-bit object for signalling a fault. If a "true" is sent, there is a fault on the smoke alarm device. This object is activated in case of the following faults:

- Defective smoke chamber
- Defective temperature sensor
- Weak battery
- 230 V error (if parameterised accordingly)
- Dirty smoke chamber
- Smoke chamber difference signal too low
- Smoke chamber electricity too high
- Smoke chamber has too many compensation pulses
- Smoke chamber loading time too high
- Temperature sensor 1 too warm
- Temperature sensor 1 too cold
- Temperature sensor 2 too warm
- Temperature sensor 2 too cold

The value can be sent cyclically. The "Send message cyclically" and "Send fault" parameters are used to set this. Sending the message is deactivated when the fault is eliminated and "Fault acknowledgement" has been received. A "0" is sent in this case.

Function: Error monitoring

Object	Function	Name	Type	DP type	Flag*
 13	Receive	Fault acknowledgement	1-bit	ETS4 1,016	C, A

Description: 1-bit object for acknowledging a fault. Communication objects 11 and 14 to 17 maintain their "1" value as long as the error is cleared and in addition this communication object is assigned a "1".

Function: Error monitoring

Object	Function	Name	Type	DP type	Flag*
 14	Send	Battery fault	1-bit	1,002	C, R, T

Description: 1-bit object for signalling a battery fault. The message is triggered when the smoke alarm device signals "Weak battery". A "1" is sent if there is a fault. When the fault has been eliminated and a "1" is received on the "Fault acknowledgement" communication object, the object is set to "0".

Function: Error monitoring

Parameter: Report 230 V fault = Yes

Object	Function	Name	Type	DP type	Flag*
 15	Send	230 V fault	1-bit	1,002	C, R, T

Description: 1-bit object for signalling a fault on the 230 V connection. The object is only visible when the "Report 230 V fault" parameter is parameterised to "yes". The message is triggered when the smoke alarm device signals a 230 V error (failure). A "1" is sent if there is a fault. When the fault has been eliminated and a "1" is received on the "Fault acknowledgement" communication object, the object is set to "0".

Function: Error monitoring

Object	Function	Name	Type	DP type	Flag*
 16	Send	Smoke chamber fault	1-bit	1,002	C, R, T

Description: 1-bit object for signalling a smoke chamber fault. The message is triggered when the smoke alarm device signals a smoke chamber defect. A "1" is sent if there is a fault. When the fault has been eliminated and a "1" is received on the "Fault acknowledgement" communication object, the object is set to "0".

Function: Error monitoring

Object	Function	Name	Type	DP type	Flag*
<input type="checkbox"/> 17	Send	Temperature sensor fault	1-bit	1,002	C, R, T

Description: 1-bit object for signalling a fault of the temperature sensor. The message is triggered when the smoke alarm device signals a temperature sensor defect. A "1" is sent if there is a fault. When the fault has been eliminated and a "1" is received on the "Fault acknowledgement" communication object, the object is set to "0".

Function: Error monitoring

Object	Function	Name	Type	DP type	Flag*
<input type="checkbox"/> 19	Send	Alarm device fault	1-bit	1,002	C, R, T

Description: 1-bit object for signalling a communication fault between the KNX module and the smoke alarm device. A "1" is sent when there is a communication fault (even if the module is not inserted in a smoke alarm device). When the fault has been eliminated and a "1" is received on the "Fault acknowledgement" communication object, the object is set to "0".

*The default values are specified.

4.2.4 Functional description

Alarms

The module enables alarms to be sent and received using a KNX-TP connection. In this context, it is possible to differentiate between local and remote alarms or report them via a joint communication object. Settings are made using the "Merge local and wired alarm" parameter. Alarms can be sent in cyclical, configurable intervals. The corresponding settings can be made using the "Send report cyclically" and "Send alarm" parameters.

State monitoring

The state of the smoke alarm device can be monitored via the module. A general fault communication object is available for this purpose, as well as various communication objects for individual faults such as "Weak battery". The general "Fault" communication object for faults can be set to cyclical transmission. The "Send message cyclically" and "Send fault" parameters are used for this purpose.

Temperature measurement

The module can query the temperatures measured by the smoke alarm device and make them available on the KNX bus. Via the "Send temperature cyclically" parameter the condition "per day" can be set (temperature is send once a day). The specific send time depends to the initialization of the KNX module.

Signal tone

The module enables a smoke alarm device to be used as a signal transmitter. A signal tone on the smoke alarm device can be activated and deactivated using a communication object. In addition, it is possible to have the signal tone deactivated automatically after the time period defined via the "Switch-on duration signal tone" parameter.

Important: Due to the external triggering (e. g. test alarm) of the signal tone the battery lifetime of the smoke alarm device is drained faster.

4.2.5 State of delivery

Physical address	15.15.255
Device name	Gira KNX smoke alarm device

4.2.6 Parameters

Description:	Values:	Comments:
 Gira KNX smoke alarm device		
Merge local and wired alarm	Yes	<p>This parameter determines whether there is a joint communication object for the signalling of alarms triggered locally and via wire, or whether there are two individual objects.</p> <p>Local and wired alarms are combined via the "Alarm" communication object. The "Local alarm" and "Wired alarm" communication objects become invisible.</p>
	No	<p>The "Local alarm" and "Wired alarm" communication objects become visible. The "Alarm" communication object becomes invisible.</p>
Send message cyclically	No	<p>This parameter defines the transmission cycle for faults and alarms. For both types of messages, a separate parameter can be used to set whether cyclical transmission or event-controlled transmission should be used.</p> <p>Messages are sent only in case of change. In this case, the "Send alarm" and "Sent fault" parameters cannot be changed.</p>
	Per minute	<p>The messages are sent at a preset interval as long as the "cyclical" setting has been selected in the "Send alarm" or "Send fault" parameter. In addition, the messages are sent immediately in case of change.</p>
	Per hour	<p>The messages are sent at a preset interval as long as the "cyclical" setting has been selected in the "Send alarm" or "Send fault" parameter. In addition, the messages are sent immediately in case of change.</p>
	Per day	<p>The messages are sent at a preset interval as long as the "cyclical" setting has been selected in the "Send alarm" or "Send fault" parameter. In addition, the messages are sent immediately in case of change.</p>

Send alarm	<p data-bbox="501 383 820 409">Only in case of change</p> <p data-bbox="501 450 608 477">Cyclical</p>	<p data-bbox="920 282 1474 376">This parameter determines whether alarm messages should only be sent in case of change or cyclically.</p> <p data-bbox="920 383 1474 443">Alarm messages are sent only in case of change.</p> <p data-bbox="920 450 1474 611">Alarm messages are sent at the interval set with the "Send message cyclically" parameter and in case of change. Only available when the "Send message cyclically" parameter is not set to "no".</p>
Send fault	<p data-bbox="501 752 820 779">Only in case of change</p> <p data-bbox="501 819 608 846">Cyclical</p>	<p data-bbox="920 651 1474 745">This parameter determines whether fault messages should only be sent in case of change or cyclically.</p> <p data-bbox="920 752 1474 813">Fault messages are sent only in case of change.</p> <p data-bbox="920 819 1474 981">Fault messages are sent at the interval set with the "Send message cyclically" parameter and in case of change. Only available when the "Send message cyclically" parameter is not set to "no".</p>
Report 230 V fault	<p data-bbox="501 1155 544 1182">No</p> <p data-bbox="501 1256 544 1283">Yes</p>	<p data-bbox="920 1021 1490 1149">The message of a 230 V fault can be activated or deactivated using this parameter. Activation is only advisable when a 230 V base is used.</p> <p data-bbox="920 1155 1490 1249">A 230 V fault is not sent and the 230 V fault is not evaluated by the "Fault" communication object.</p> <p data-bbox="920 1256 1490 1314">A 230 V fault is sent and evaluated by the "Fault" communication object.</p>

Send temperature
cyclically

No

Per day

This parameter determines whether the temperature is sent to the KNX bus and when transmission should occur.

The temperature is not sent to the KNX bus.

The temperature is sent at the set interval. The specific send time depends to the initialization of the KNX module.

Compare internal
temperature sensors

+0.0 °C

-10.0 °C to +10 °C

(In steps of 0.5)

If the temperature measured by the module consistently deviates from the actual value, it is possible to compensate this deviation using this parameter.

The measured temperature is corrected by the configured value.

Switch-on duration
signal tone

Unlimited

1 s to 24 s

This parameter defines the maximum switch-on duration of the signal tone.

The signal tone can only be deactivated by a telegram.

The maximum switch-on duration of the signal tone corresponds to the configured value.