

# Modbus RTU (EIA-485) Interface for Fujitsu air conditioners

## USER MANUAL

Issue date: 04/2019 r2.1 ENGLISH



## Important User Information

### Disclaimer

The information in this document is for informational purposes only. Please inform HMS Industrial Networks of any inaccuracies or omissions found in this document. HMS Industrial Networks disclaims any responsibility or liability for any errors that may appear in this document.

HMS Industrial Networks reserves the right to modify its products in line with its policy of continuous product development. The information in this document shall therefore not be construed as a commitment on the part of HMS Industrial Networks and is subject to change without notice. HMS Industrial Networks makes no commitment to update or keep current the information in this document.

The data, examples and illustrations found in this document are included for illustrative purposes and are only intended to help improve understanding of the functionality and handling of the product. In view of the wide range of possible applications of the product, and because of the many variables and requirements associated with any particular implementation, HMS Industrial Networks cannot assume responsibility or liability for actual use based on the data, examples or illustrations included in this document nor for any damages incurred during installation of the product. Those responsible for the use of the product must acquire sufficient knowledge in order to ensure that the product is used correctly in their specific application and that the application meets all performance and safety requirements including any applicable laws, regulations, codes and standards. Further, HMS Industrial Networks will under no circumstances assume liability or responsibility for any problems that may arise as a result from the use of undocumented features or functional side effects found outside the documented scope of the product. The effects caused by any direct or indirect use of such aspects of the product are undefined and may include e.g. compatibility issues and stability issues.

## Modbus RTU (EIA-485) Interface for Fujitsu air conditioners

<b>ORDER CODE</b>	<b>LEGACY ORDER CODE</b>
INMBSFGL001R000	FJ-RC-MBS-1

**INDEX**

- 1. Presentation ..... 5
- 2. Connection ..... 6
  - 2.1 Connect to the AC indoor unit ..... 6
  - 2.2 Connection to the EIA-485 bus ..... 7
- 3. Quick Start Guide..... 7
- 4. Modbus Interface Specification ..... 8
  - 4.1 Modbus physical layer..... 8
  - 4.2 Modbus Registers..... 8
    - 4.2.1 Control and status registers ..... 8
    - 4.2.2 Configuration Registers..... 11
    - 4.2.3 Considerations on Temperature Registers ..... 12
  - 4.3 DIP-switch Configuration Interface ..... 13
  - 4.4 Implemented Functions ..... 16
  - 4.5 Device LED indicator ..... 16
  - 4.6 EIA-485 bus. Termination resistors and Fail-Safe Biasing mechanism ..... 17
- 5. Mechanical and electrical features ..... 18
- 6. List of supported AC Unit Types. .... 19
- 7. Error Codes ..... 20
  - 7.1 Intesis Codes..... 20
  - 7.2 RAC and VRF J-II / V-II / VR-II series..... 20
  - 7.3 VRF V / S / J Series ..... 23

# 1. Presentation



The INMBSFGL001R000 interfaces allow a complete and natural integration of **Fujitsu** air conditioners into Modbus RTU (EIA-485) networks.

Reduced dimensions. 93 x 53 x 58 mm  
3.7" x 2.1" x 2.3"

Quick and easy installation.  
*Mountable on DIN rail, wall, or even inside the indoor unit of AC.*

- External power not required.
- Direct connection to Modbus RTU (EIA-485) networks. Up to 63 INMBSFGL001R000 devices can be connected in the same network.  
*INMBSFGL001R000 is a Modbus slave device.*
- Direct connection to the AC indoor unit. Up to 16 AC indoor units can be connected to INMBSFGL001R000, controlling them as one (not individually).
- Configuration from both on-board DIP-switches and Modbus RTU.
- Total Control and Supervision.
- Real states of the AC unit's internal variables.
- Allows simultaneous use of the AC's remote controls and Modbus RTU.

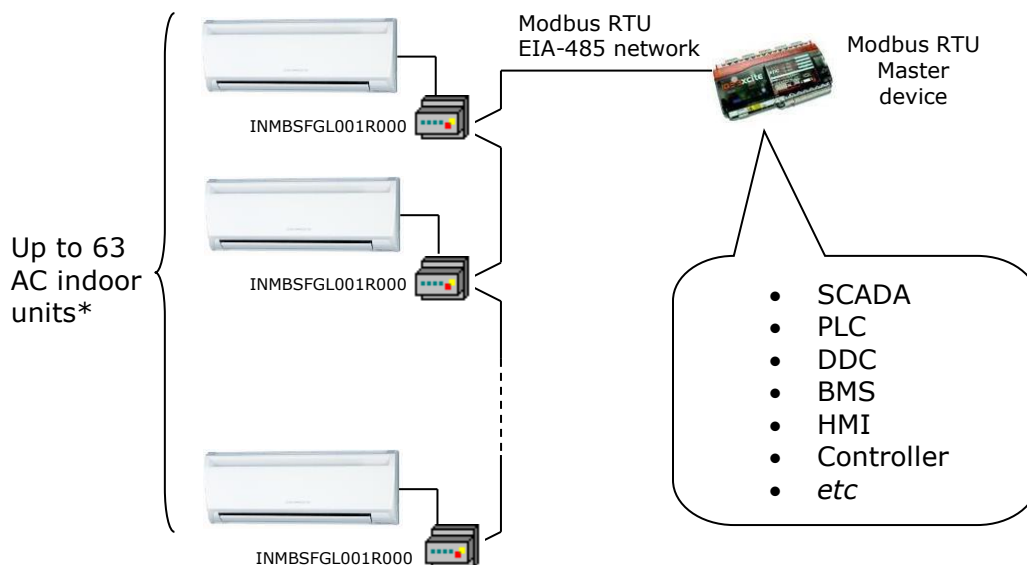

\* Up to 63 Intesis devices can be installed in the same Modbus RTU bus. However, depending on the configured speed, the installation of Modbus Repeaters may be required

## 2. Connection

The interface comes with a plug-in terminal block of 3 poles to establish direct connection with the AC indoor unit. It comes as well with a plug-in terminal block of 2 poles to establish direct connection with the Modbus RTU EIA-485 network.

### 2.1 Connect to the AC indoor unit

The INMBSFGL001R000 connects directly to the Fujitsu BWR Bus, which is not provided within the interface. Depending on which controllers are available, the recommended connection methods are the following ones (details in Figure 2. 1):

- **Wired remote control available.** Connect the gateway as Slave in parallel with the wired Remote Controllers (Controller acts as Master).
- **No remote control available** Connect the gateway directly to the BWR bus of the indoor unit as Master when there is no Fujitsu Remote Controller.

Maximum BWR bus length is 500 meters / 1,640.42 ft. The bus has no polarity sensitivity.

**Important:** If a wired remote controller of the AC manufacturer is connected in the same bus, communication may shut down.

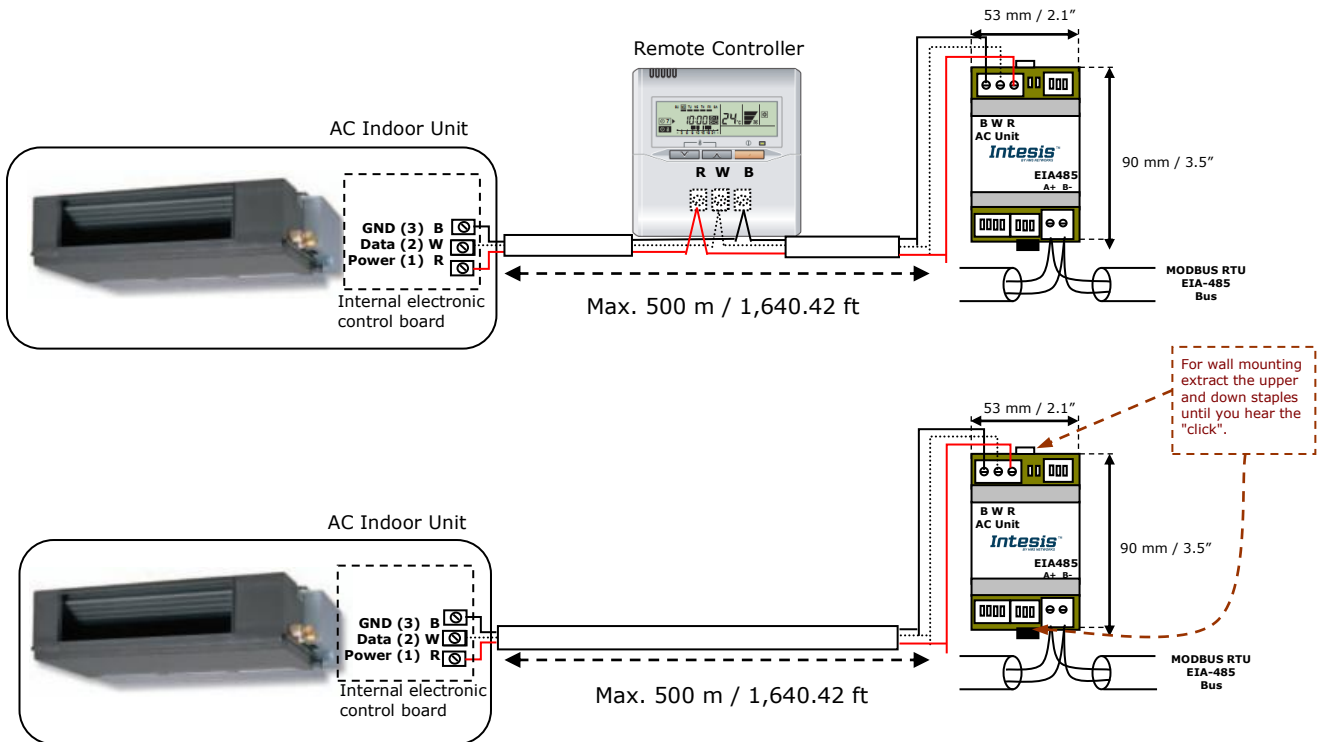

Figure 2. 1 INMBSFGL001R000 connection diagram

## 2.2 Connection to the EIA-485 bus

Connect the EIA-485 bus wires to the plug-in terminal block (the one of two poles) of INMBSFGL001R000 and keep the polarity on this connection (A+ and B-). Make sure that the maximum distance to the bus is 1,200 meters (3,937 ft). Loop or star typologies are not allowed in the case of the EIA-485 bus. A terminator resistor of 120Ω must be present at each end of the bus to avoid signal reflections. The bus needs a fail-safe biasing mechanism (see section 4.6 for more details).

## 3. Quick Start Guide

1. Disconnect the air conditioning from the Mains Power.
2. Attach the interface next to the AC indoor unit (wall mounting) following the instructions of the diagram below or install it inside the AC indoor unit (respect the safety instructions given).
3. Connect the BWR bus between the interface and the AC indoor unit following the instructions of the diagram. Screw each bare cable end in the corresponding BWR terminals of each device.
4. Connect the EIA-485 bus to the connector *EIA485* of the interface.
5. Close the AC indoor unit.
6. Check the DIP-Switch configuration of the Intesis interface and make sure it matches the current installation's parameters (see section 4.3).

By default, the interface is set to:

- Modbus Slave Address → 1
- Modbus baud rate → 9600 bps



These parameters can be modified from SW4 and SW3 DIP-Switches.

All other switch positions are set at low level (Off position ) by default.

**NOTE:** All changes on the DIP-Switch configuration require a system power cycle to be applied.

7. Connect the AC system to Mains Power.

**IMPORTANT:** The Intesis interface requires to be connected to the AC unit (powered) to start communicating.

## 4. Modbus Interface Specification

### 4.1 Modbus physical layer

INMBSFGL001R000 implements a Modbus RTU (Slave) interface, to be connected to an EIA-485 line. It performs 8N2 communication (8 data bits, no parity and 2 stop bit) with several available baud rates (2400 bps, 4800 bps, 9600 bps -default-, 19200 bps, 38400 bps, 57600 bps, 76800 bps and 115200 bps). It also supports 8N1 communication (8 data bits, no parity and 1 stop bit).

### 4.2 Modbus Registers

All registers are type "16-bit unsigned Holding Register" and they use the *Modbus big endian* notation.

#### 4.2.1 Control and status registers

Register Address (protocol address)	Register Address (PLC address)	R/W	Description
0	1	R/W	AC unit On/Off <ul style="list-style-type: none"> <li>▪ 0: Off</li> <li>▪ 1: On</li> </ul>
1	2	R/W	AC unit Mode <sup>1</sup> <ul style="list-style-type: none"> <li>▪ 0: Auto</li> <li>▪ 1: Heat</li> <li>▪ 2: Dry</li> <li>▪ 3: Fan</li> <li>▪ 4: Cool</li> </ul>
2	3	R/W	AC unit Fan Speed <sup>1</sup> <ul style="list-style-type: none"> <li>▪ 1: Low</li> <li>▪ 2: Mid</li> <li>▪ 3: High</li> </ul>
3	4	R/W	AC unit Vane Position <sup>1</sup> <ul style="list-style-type: none"> <li>▪ 1: Position-1 (Horizontal)</li> <li>▪ 2: Position-2 (Horizontal)</li> <li>▪ 3: Position-3 (Medium)</li> <li>▪ 4: Position-4 (Vertical)</li> <li>▪ 5: Position-5 (Vertical)</li> <li>▪ 10: Swing</li> </ul>
4	5	R/W	AC unit Temperature Setpoint <sup>1,2,3</sup> <ul style="list-style-type: none"> <li>▪ -32768 (Initialization value)</li> <li>▪ 16..30 (°C) (0 = undetermined)</li> <li>▪ 61..86 (°F) (0 = undetermined)</li> </ul>

<sup>1</sup> Available values will depend on the AC unit mode. Check the AC unit model functions in its user manual to know the possible values for this register.

<sup>2</sup> Magnitude for this register can be adjusted to Celsius x 1°C, Celsius x 10°C (default) or Fahrenheit. See section 4.2.3 for more information.

<sup>3</sup> It is not possible turn to x10 the value shown in Fahrenheit.



Register Address (protocol address)	Register Address (PLC address)	R/W	Description
5	6	R	AC unit Temperature reference <sup>1,2,3,6</sup> <ul style="list-style-type: none"> <li>16..30 (°C) (0 = undetermined)</li> <li>61..86 (°F) (0 = undetermined)</li> <li>0x8000 There is no temperature sent from the Remote controller</li> </ul>
6	7	R/W	Window Contact <ul style="list-style-type: none"> <li>0: Closed (Default)</li> <li>1: Open</li> </ul>
7	8	R/W	INMBSFGL001R000 Disablement <sup>4</sup> <ul style="list-style-type: none"> <li>0: INMBSFGL001R000 enabled (Default value)</li> <li>1: INMBSFGL001R000 disabled</li> </ul>
8	9	R/W	AC Remote Control Disablement <sup>4</sup> <ul style="list-style-type: none"> <li>0: Remote Control enabled (Default value)</li> <li>1: Remote Control disabled</li> </ul>
9	10	R/W	AC unit Operation Time <sup>4</sup> <ul style="list-style-type: none"> <li>0..65535 (hours). Counts the time the AC unit is in "On" state.</li> </ul>
10	11	R	AC unit Alarm Status <ul style="list-style-type: none"> <li>0: No alarm condition</li> <li>1: Alarm condition</li> </ul>
11	12	R	Error Code <sup>5</sup> <ul style="list-style-type: none"> <li>0: No error present</li> <li>65535(-1 if it is read as signed value): Error in the communication of INMBSFGL001R000 or Remote Controller with the AC unit.</li> <li>For any other error, see the table at the end of this document.</li> </ul>
22	23	R/W	Indoor unit's ambient temperature from external sensor (at Modbus side) <sup>1,2,3,6</sup> <ul style="list-style-type: none"> <li>-32768: (Initialization value). No temperature is being provided from an external sensor.</li> <li>Any other: (°C/x10°C/°F)</li> </ul>
23	24	R	AC Real temperature setpoint <sup>1,2,3,6</sup> <ul style="list-style-type: none"> <li>When no external temperature is provided, this read-only register will have the same value as register 5 (PLC addressing). In all cases, it will show the current setpoint in the indoor unit.</li> <li>16..31°C (°C/x10°C)</li> <li>60..92°F</li> </ul>
24	25	R	Current AC max setpoint <sup>1,2,3</sup> <ul style="list-style-type: none"> <li>-32768 (Initialization value)</li> <li>Ranges are specific from Manufacturer</li> </ul>
25	26	R	Current AC min setpoint <sup>1,2,3</sup> <ul style="list-style-type: none"> <li>-32768 (Initialization value)</li> <li>Ranges are specific from Manufacturer</li> </ul>
26	27	R/W	AC unit Horizontal Vane Position <sup>1</sup> <ul style="list-style-type: none"> <li>0: Auto (Default)</li> <li>10: Swing</li> </ul>

<sup>4</sup> This value is stored in non-volatile memory

<sup>5</sup> See section 7 for possible error codes and their explanation

<sup>6</sup> See section 4.2.3 for more information

---

27	28	W	Up/Down Vane Pulse <ul style="list-style-type: none"><li>▪ 1: Pulse</li></ul>
----	----	---	---

Register Address (protocol address)	Register Address (PLC address)	R/W	Description
31	32	R	Status (feedback) <ul style="list-style-type: none"> <li>0: Not active (Default value)</li> <li>1: Active (A window is open)</li> </ul>
34	35	W	Left/Right Vane pulse <ul style="list-style-type: none"> <li>1: Pulse</li> </ul>
64	65	R/W	Economy <ul style="list-style-type: none"> <li>0: Disabled</li> <li>1: Enabled</li> </ul>
65	66	R	Input reference temperature <sup>1,2,3</sup> <ul style="list-style-type: none"> <li>0x8000: No temperature's value is being provided from an external sensor. No virtual temperature is being applied.</li> <li>Any other: (°C/x10°C/°F)</li> </ul>
81	82	R	Error address <ul style="list-style-type: none"> <li>Provides the indoor unit number which is providing error</li> </ul>
97	98	R/W	Block Periodic Sendings <sup>4,7,8</sup> <ul style="list-style-type: none"> <li>0: Non-blocked (Default value)</li> <li>1: Blocked</li> </ul>
98	99	R	Master/Slave (gateway's role) <ul style="list-style-type: none"> <li>0: Slave</li> <li>1: Master</li> </ul>

#### 4.2.2 Configuration Registers

Register Address (protocol address)	Register Address (PLC address)	R/W	Description
13	14	R/W	"Open Window" switch-off timeout <sup>9</sup> <ul style="list-style-type: none"> <li>0..30 (minutes)</li> <li>Factory setting: 30 (minutes)</li> </ul>
14	15	R	Modbus RTU baud-rate <ul style="list-style-type: none"> <li>2400bps</li> <li>4800bps</li> <li>9600bps (Default)</li> <li>19200bps</li> <li>38400bps</li> <li>57600bps</li> <li>76800bps</li> <li>115200bps</li> </ul>
15	16	R	Modbus Slave Address <ul style="list-style-type: none"> <li>1..63</li> </ul>
21	22	R	Max number of fan speeds
48	49	R	Switch value
49	50	R	Device ID: 0x0D00
50	51	R	Software version

<sup>7</sup> If the register is configured as "0:Non-blocked", all commands received from Modbus will be sent to the AC system. If "1: Blocked", commands from Modbus will only be sent to the AC system if they differ from the previous value.

<sup>8</sup> This register applies to firmware version 2.5 onwards

<sup>9</sup> Once window contact is open, a count-down to switch off the AC Unit will start from this configured value.

### 4.2.3 Considerations on Temperature Registers

- **AC unit Temperature Setpoint (R/W)** (register 5 – in PLC addressing): This is the adjustable temperature setpoint meant to be required by the user. This register can be read (Modbus function 3 or 4) or written (modbus functions 6 or 16). A remote controller connected to the 3-wire bus of the Fujitsu indoor unit will report the same temperature setpoint value as this register.
- **AC unit external reference temperature (R/W)** (register 23 – in PLC addressing): This register allows providing an external temperature reference from Modbus side. If an external temperature is provided through this register, indoor unit will use it as reference for its temperature control loop.
  - This register will have no effect in those Fujitsu RAC / domestic line splits Air-Conditioning units – this is, those models requiring an additional communication accessory enabling communication with INMBSFGL001R000.
  - For this temperature to take effect it is required that the Fujitsu AC indoor unit is configured in such a way that it uses the "thermostat sensor in the remote controller" (this is, INMBSFGL001R000 will act as thermostat sensor providing a temperature sensor reading).
  - This configuration is done via a Fujitsu remote controller connected to the indoor unit (Function number "42" – setting value "1" / operation of Thermosensor button) and must be done by Fujitsu authorized installers at the time of the installation of the AC.
  - Register value after INMBSFGL001R000 startup is -32768, which means that no temperature reference is provided to the AC indoor unit. In that case, AC indoor unit will use its own return path temperature sensor as reference for its control loop.

Moreover, notice that temperature's values of all these four registers are expressed according to the temperature's format configured through its onboard DIP-Switches (See 4.3 "DIP-switch Configuration Interface"). These following formats are possible:

- **Celsius value:** Value in Modbus register is the temperature value in Celsius (i.e. a value "22" in the Modbus register must be interpreted as 22°C).
- **Decicelsius value:** Value in Modbus register is the temperature value in decicelsius (i.e. a value "220" in the Modbus register must be interpreted as 22.0°C).
- **Fahrenheit value:** Value in Modbus register is the temperature value in Fahrenheit (i.e. a value "72" in the Modbus register must be interpreted as 72°F (~22°C)).

### 4.3 DIP-switch Configuration Interface

All the configuration values on INMBSFGL001R000 can be written and read from Modbus interface. Otherwise, some of them can also be setup from its on-board DIP-switch interface. The device has DIP-switches SW1, SW3 and SW4 on the following locations:

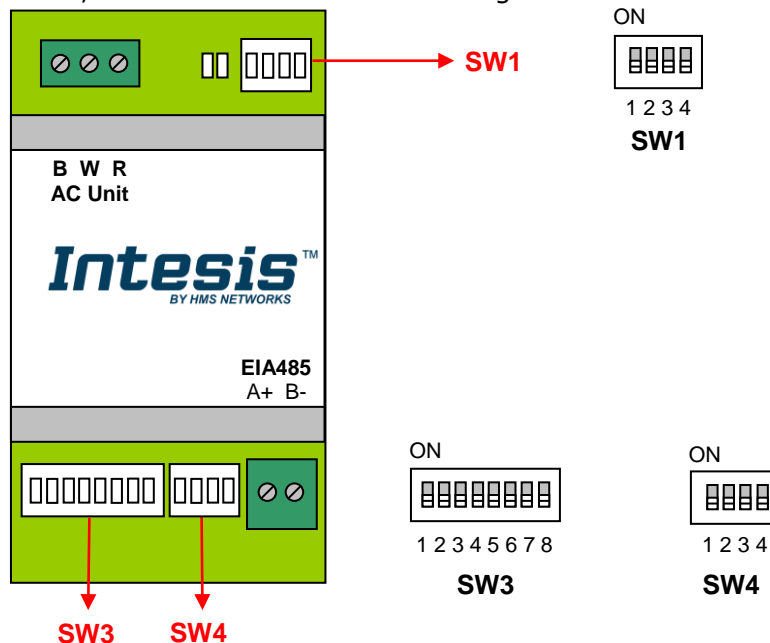

The following tables apply to the interface's configuration through DIP-switches:













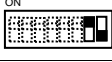

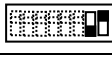

#### SW1 – AC indoor unit's features

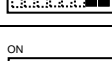
SW1-P1..4	Description
	Slave - A Fujitsu Controller must be present in BWR bus, configured as Master (Default value)
	Master – Fujitsu Controller not needed in BWR bus. If it exists, it must be configured as Slave
	Keep the switch into this position (Default value)
	Do not turn the switch into this position (not applicable)
	Machine type: RAC inverter model G series, VRF J-II, VRF V-II or VRF VR-II <sup>10</sup> (Default value)
	Machine type: RAC inverter, RAC non-inverter, VRF V, VRF S or VRF J
	Keep the switch into this position (Default value)
	Do not turn the switch into this position (not applicable)

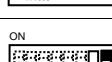
**Table 4.1** SW1: AC indoor unit's features

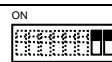





<sup>10</sup> \* G series stands for units that include a 'G' just before the power number in its reference. E.g.: ASYG09LTCA

**SW3/SW4** – Baud rate configuration

SW3-P7..8	SW4-P3	Description
		2400bps
		4800bps
		9600bps (Default value)
		19200bps
		38400bps
		57600bps
		76800bps
		115200bps

**Table 4.2** SW3-SW4: Modbus baud rate

**SW4** – Degrees/Decidegrees (x10), temperature magnitude (°C/°F) and EIA-485 termination resistor.

SW4-P1..2-4	Description
	Temperature values in Modbus register are represented in degrees (x1) (Default value)
	Temperature values in Modbus register are represented in decidegrees (x10)
	Temperature values in Modbus register are represented in Celsius degrees (Default value)
	Temperature values in Modbus register are represented in Fahrenheit degrees
	EIA-485 bus without termination resistor (Default value)
	Internal termination resistor of 120Ω connected to EIA-485 bus

**Table 4.3** SW4: Temperature and termination resistor configuration

SW3 – Modbus Slave address

Add	SW3-P1..6	Add	SW3-P1..6	Add	SW3-P1..6	Add	SW3-P1..6	Add	SW3-P1..6
0		13		26		39		52	
1		14		27		40		53	
2		15		28		41		54	
3		16		29		42		55	
4		17		30		43		56	
5		18		31		44		57	
6		19		32		45		58	
7		20		33		46		59	
8		21		34		47		60	
9		22		35		48		61	
10		23		36		49		62	
11		24		37		50		63	
12		25		38		51			

Table 4.4 SW3: Modbus slave address

## 4.4 Implemented Functions

INMBSFGL001R000 implements the following standard Modbus functions:

- 3: Read Holding Registers
- 4: Read Input Registers
- 6: Write Single Register
- 16: Write Multiple Registers (Despite this function is allowed, the interface does not allow to write operations on more than 1 register with the same request, this means that length field should be always be 1 when this function is being used in case of writing)

The maximum number of registers that can be read in a single request is 100.

## 4.5 Device LED indicator

The device includes two LED indicators to show all the possible operational states. In the following table there are written the indicators which can be performed and their meaning.

### L1 (green LED)

Device status	LED indication	ON / OFF Period	Description
During not normal operation	LED blinking	500ms ON / 500ms OFF	Communication error
During normal operation	LED flashing	100ms ON / 1900ms OFF	Normal operation (configured and working properly)

### L2 (red LED)

Device status	LED indication	ON / OFF Period	Description
During not normal operation	LED Pulse	3sec ON / --- OFF	Under voltage

### L1 (green LED) & L2 (red LED)

Device status	LED indication	ON / OFF Period	Description
During normal operation	LED Pulse	5sec ON / --- OFF	Device Start-up
During not normal operation	LED alternatively blinking	500ms ON / 500ms OFF	Flash checksum not OK



## 4.6 EIA-485 bus. Termination resistors and Fail-Safe Biasing mechanism

EIA-485 bus requires a 120Ω terminator resistor at each end of the bus to avoid signal reflections.

In order to prevent fail status detected by the receivers, which are "*listening*" the bus, when all the transmitters' outputs are in three-state (high impedance), it is also required a fail-safe biasing mechanism. This mechanism provides a safe status (a correct voltage level) in the bus when all the transmitters' outputs are in three-state. This mechanism must be supplied by the Modbus Master.

The INMBSFGL001R000 device includes an on-board terminator resistor of 120Ω that can be connected to the EIA-485 bus by using DIP-switch SW4.

Some Modbus RTU EIA-485 Master devices can provide also internal 120Ω terminator resistor and/or fail-safe biasing mechanism (Check the technical documentation of the Master device connected to the EIA-485 network in each case).

### 5. Mechanical and electrical features

Enclosure	Plastic, type PC (UL 94 V-0) Net dimensions (dxwxh): 93 x 53 x 58 mm / 3.7" x 2.1" x 2.3" Color: Light Grey. RAL 7035	Operation Temperature	0°C to +60°C
Weight	85 g.	Stock Temperature	-20°C to +85°C
Mounting	Wall DIN rail EN60715 TH35.	Operational Humidity	<95% RH, non-condensing
Terminal Wiring (for low-voltage signals)	For terminal: solid wires or stranded wires (twisted or with ferrule) 1 core: 0.5mm <sup>2</sup> ... 2.5mm <sup>2</sup> 2 cores: 0.5mm <sup>2</sup> ... 1.5mm <sup>2</sup> 3 cores: not permitted	Stock Humidity	<95% RH, non-condensing
Modbus RTU port	1 x Serial EIA485 Plug-in screw terminal block (2 poles): A, B Compatible with Modbus RTU EIA-485 networks	Isolation voltage	1500 VDC
AC unit port	1 x BWR bus Plug-in screw terminal block (3 poles): B, W, R Compatible with Fujitsu networks	Isolation resistance	1000 MΩ
Switch 1 (SW1)	1 x DIP-Switch for AC features	Protection	IP20 (IEC60529)
Switch 3 (SW3)	1 x DIP-Switch for Modbus RTU settings	LED indicators	2 x Onboard LED - Operational status
Switch 4 (SW4)	1 x DIP-Switch for extra functions		

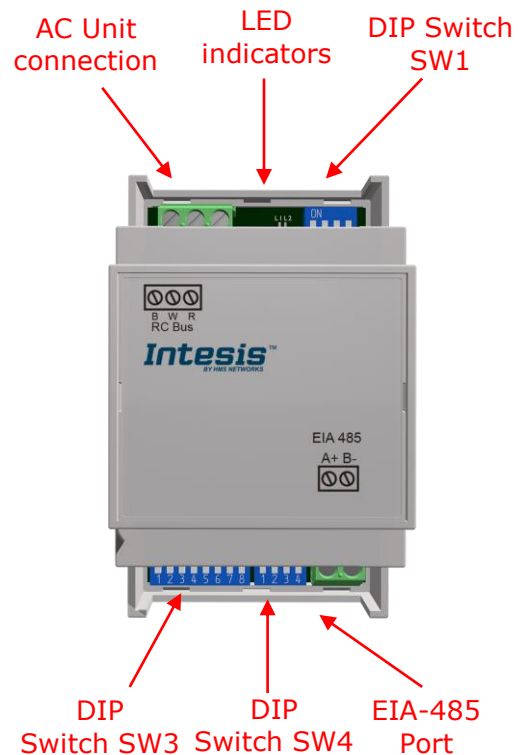
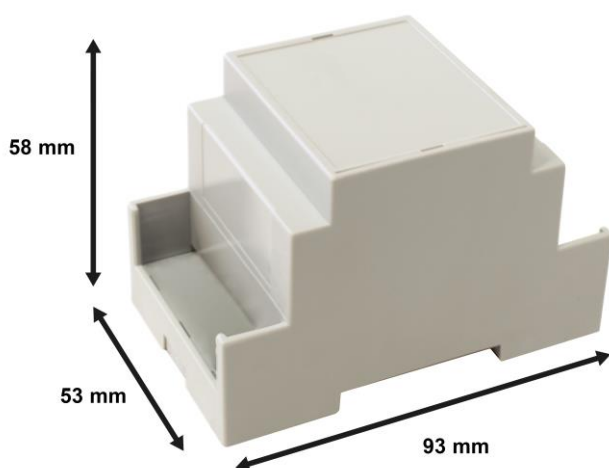

## ***6. List of supported AC Unit Types.***

A list of Fujitsu indoor unit model's references compatible with INMBSFGL001R000 and its available features can be found on this link:

[https://www.intesis.com/docs/compatibilities/inxxfgl001r000\\_compatibility](https://www.intesis.com/docs/compatibilities/inxxfgl001r000_compatibility)

## 7. Error Codes

To obtain the error which belongs to the Error Codes list, remember that it must be selected the right position of the DIP-switch SW1 (See Section 4.3). Here there are two lists. It must be chosen only one list depending on the system installed.

### 7.1 Intesis Codes

Error Code Modbus	Error in Remote Controller	Error Description
0	N/A	No active error
65535 (-1)	N/A	Error in the communication of INMBSFGL001R000 or Remote Controller with the AC unit

### 7.2 RAC and VRF J-II / V-II / VR-II series

Error Code Modbus	Error in Remote Controller	System	Error Description
0	00	RAC Inverter and Non Inverter	Wired remote controller error
1	01		Indoor signal error
2	02		Indoor room temperature sensor error
3	03		Indoor room temperature sensor error
4	04		Indoor heat exchanger temperature sensor (middle) error
5	05		Indoor heat exchanger temperature sensor (middle) error
6	06		Outdoor heat exchanger temperature sensor (outlet) error
7	07		Outdoor heat exchanger temperature sensor (outlet) error
8	08		Power voltage error
9	09		Float switch operated
10	0A		Outdoor temperature sensor error
11	0b		Outdoor temperature sensor error
12	0C		Outdoor discharge pipe temperature sensor error
13	0d		Outdoor discharge pipe temperature sensor error
14	0E		Heat sink thermistor (Inverter) error
15	0F		Discharge temperature error
17	11		Indoor unit EEPROM error
18	12		Indoor fan error
19	13		Indoor signal error
20	14		Outdoor EEPROM error
21	15		Compressor temperature sensor error
22	16		Pressure switch abnormal, Pressure sensor error
23	17		IPM protection
24	18		CT error
25	19		Active filter error
26	1A		INV voltage protection
27	1b		Compressor location error
28	1C		Outdoor fan error
29	1d		Outdoor unit computer communication error
		2-way valve temperature sensor error	

30	1E		3-way valve temperature sensor error	
31	1F		Connected indoor unit error	
32	20		Indoor MANUAL AUTO switch error	
33	21		reverse VDD permanent stop protection	
34	22		VDD permanent stop protection	
36	24		Excessive high pressure protection on cooling	
37	25		P.F.C. circuit error	
38	26		Indoor signal error	
39	27		Indoor signal error	
40	28		Indoor heat exchanger temperature sensor (inlet) error	
41	29		Outdoor heat exchanger temperature sensor (middle) error	
42	2A		Power supply frequency detection error	
43	2b		Compressor temperature error	
44	2C		4-way valve error	
45	2d		Heat sink thermistor P.F.C. error	
46	2E	<b>RAC</b> Inverter and Non Inverter	Indoor unit damper error	
47	2F		Inverter error	
48	30		Low pressure error	
49	31		Refrigerant circuit address set-up error	
50	32		Master unit, Slave unit set-up error	
51	33		Connected the indoor number set-up error	
52	34		P.F.C. printed circuit board error	
53	35		Indoor fan 2 error	
54	36		Control box thermistor error	
55	37		<b>RAC</b> Inverter and Non Inverter	Indoor unit CT error
56	38			Indoor fan motor 1 driving circuit error
117	11		<b>RAC</b> Inverter Models G series  <b>VRF</b> J-II/V-II/VR-II Series	Indoor fan motor 2 driving circuit error
118	12			Serial communication error between indoor/outdoor units
119	13	Remote controller communication error		
120	14	Communication error between outdoor units		
121	15	Network communication error		
122	16	Scan error		
123	17	Peripheral unit communication error		
133	21	Electricity charge apportionment error		
134	22	Indoor unit initial setting error		
135	23	Indoor unit capacity abnormal		
136	24	Incompatible series connection error		
137	25	Connection unit number error		
138	26	Connection pipe length error		
139	27	Indoor unit address setting error		
140	28	Master/slave unit setting error		
141	29	Other setting error		
149	31	Connection unit number error in wired remote controller system		
150	32	Indoor unit power supply abnormal		
151	33	Indoor unit main PCB error		
152	34	Indoor unit display PCB error		
153	35	Power relay error		
154	36	Indoor unit manual auto switch error		
155	37	Heater relay error		
156	38	Indoor unit transmission PCB error		
			Network convertor PCB error	

157	39		Indoor unit power supply circuit error
158	3A		Indoor unit communication circuit (wired remote controller) error
165	41		Indoor unit room temp. thermistor error
166	42		Indoor unit heat ex. temp. thermistor error
167	43		Humidity sensor error
168	44		Light sensor error
169	45		Gas sensor error
170	46		Float sensor error
171	47		Water temperature sensor error
172	48		Warm water flow rate sensor error
173	49		Heater sensor error
181	51		Indoor unit fan motor 1 error
182	52		Indoor unit coil (expansion valve) error
183	53		Indoor unit water drain abnormal
184	54		Air cleaning function error
185	55		Filter cleaning function error
186	56		Water circulation pump error
187	57		Indoor unit damper error
188	58		Indoor unit intake grille position error
189	59		Indoor unit fan motor 2 error
195	5U	<b>RAC</b> Inverter Models G series	Indoor unit miscellaneous error
197	61		Outdoor unit power supply abnormal
198	62		Outdoor unit main PCB error
199	63		Outdoor unit inverter PCB error
200	64		Outdoor unit active filter/PFC circuit error
201	65		Outdoor unit IPM error
202	66		Convertor distinction error
203	67		Outdoor unit power short interruption error (protective operation)
204	68		Outdoor unit magnetic relay error
205	69		Outdoor unit transmission PCB error
206	6A	Outdoor unit display PCB error	
213	71	Outdoor unit discharge temp. thermistor error	
214	72	Outdoor unit compressor temp. thermistor error	
215	73	<b>RAC</b> Inverter Models G series	Outdoor unit heat ex. temp. thermistor error
216	74		Outside air temp. thermistor error
217	75		Outdoor unit suction gas temp. thermistor error
218	76		Outdoor unit operating valve thermistor error
219	77		Outdoor unit heat sink temp. thermistor error
220	78		Expansion valve temperature sensor error
229	81		Receiver liquid level detection sensor error
230	82		Outdoor unit sub-cool heat ex. gas temp. thermistor error
231	83		Outdoor unit liquid pipe temp. thermistor error
232	84		Outdoor unit current sensor error
233	85	Fan motor current sensor error	
234	86	Outdoor unit pressure sensor error	
235	87	Oil sensor error	
245	91	Outdoor unit compressor 1 error	
246	92	Outdoor unit compressor 2 error	
247	93	Outdoor unit compressor start up error	
248	94	Outdoor unit trip detection	
249	95	<b>VRF</b> J-II/V- II/VR-II Series	Outdoor unit compressor motor control error
250	96		Open loop error(Field-weakening relevant)
251	97		Outdoor unit fan motor 1 error

252	98		Outdoor unit fan motor 2 error
253	99		Outdoor unit 4-way valve error
254	9A		Outdoor unit coil (expansion valve) error
259	9U		Outdoor unit miscellaneous error
261	A1		Outdoor unit discharge temperature 1 error
262	A2		Outdoor unit discharge temperature 2 error
263	A3		Outdoor unit compressor temperature error
264	A4		Outdoor unit pressure error 1
265	A5		Outdoor unit pressure error 2
266	A6		Outdoor unit heat exchanger temperature error
267	A7		Suction temperature abnormal
268	A8		Poor refrigerant circulation
269	A9		Current overload error
270	AA		Outdoor unit special operation error
271	AC		Ambient temperature error
272	AF		Out of the possible operation range
273	AJ		Freeze protection operated
277	C1		Peripheral unit main PCB error
278	C2		Peripheral unit transmission PCB error
279	C3		Peripheral unit PCB 1 error
280	C4	<b>RAC</b>	PCB 2 error
281	C5	Inverter	PCB 3 error
282	C6	Models G	PCB 4 error
283	C7	series	PCB 5 error
284	C8		Peripheral unit input device error
285	C9	<b>VRF</b>	Display device error
286	CA	J-II/V-	EEPROM error
287	CC	II/VR-II	Peripheral unit sensor error
288	CF	Series	Peripheral unit external connector error (USB memory)
289	CJ		Other parts error
293	F1		System tool software error
294	F2		System tool adaptor error
295	F3		System tool interface error
296	F4		System tool environment error
309	J1		RB unit error
310	J2		Branch boxes error
311	J3		Total heat exchanging, ventilation unit error
312	J4		Domestic hot water unit error
313	J5		Zone control interface error

### 7.3 VRF V / S / J Series

Error Code Modbus	Error in Remote Controller	System	Error Description
0	00		No Error
2	02		Model information Error
4	04		Power frequency Error
6	06	<b>VRF</b>	EEPROM access Error
7	07	V / S / J	EEPROM deletion Error
9	09	Series	Room sensor Error
10	0A		Heat Ex. Middle Sensor Error
11	0b		Heat Ex. Inlet sensor Error
12	0C		Heat Ex. Outlet sensor Error

13	0d	<b>VRF</b> V / S / J Series	Blower temperature thermistor Error
17	11		Drain Error
18	12		Room temperature Error
19	13		Indoor fan motor Error
20	18		Standard wired remote Error
31	1F		Standard wired token Error
32	20		Network communication Error
33	21		Node setting error
34	32		Communication Error between Main PCB & Transmission PCB
			Outdoor unit Error

The devices with Software Version 2.1 (See Register Address PLC 51) and all previous versions backwards, which are connected to a model RAC of the G series, VRF J-II, VRF V-II or VRF VR-II, require adding 100 to the error code that has been shown. For example, if the error shown is 17, the error which belongs to the list is 17+100=**117**.

In case to detect an error code not listed, contact your closest Fujitsu technical support service.