

# HITACHI VRF Air Conditioning

Gateway for the integration of Hitachi VRF systems into KNX home automation systems

## USER MANUAL

Issue date: 01/2019 r1.1 ENGLISH



## Important User Information

### Disclaimer

The information in this document is for informational purposes only. Please inform HMS Industrial Networks of any inaccuracies or omissions found in this document. HMS Industrial Networks disclaims any responsibility or liability for any errors that may appear in this document.

HMS Industrial Networks reserves the right to modify its products in line with its policy of continuous product development. The information in this document shall therefore not be construed as a commitment on the part of HMS Industrial Networks and is subject to change without notice. HMS Industrial Networks makes no commitment to update or keep current the information in this document.

The data, examples and illustrations found in this document are included for illustrative purposes and are only intended to help improve understanding of the functionality and handling of the product. In view of the wide range of possible applications of the product, and because of the many variables and requirements associated with any particular implementation, HMS Industrial Networks cannot assume responsibility or liability for actual use based on the data, examples or illustrations included in this document nor for any damages incurred during installation of the product. Those responsible for the use of the product must acquire sufficient knowledge in order to ensure that the product is used correctly in their specific application and that the application meets all performance and safety requirements including any applicable laws, regulations, codes and standards. Further, HMS Industrial Networks will under no circumstances assume liability or responsibility for any problems that may arise as a result from the use of undocumented features or functional side effects found outside the documented scope of the product. The effects caused by any direct or indirect use of such aspects of the product are undefined and may include e.g. compatibility issues and stability issues.

Gateway for the integration of Hitachi VRF systems into KNX home automation systems.

| <b>ORDER CODE</b> | <b>LEGACY ORDER CODE</b> |
|-------------------|--------------------------|
| INKNXHIT016O000   | HI-AC-KNX-16             |
| INKNXHIT064O000   | HI-AC-KNX-64             |

**INDEX**

1 Description ..... 5

    1.1 Introduction ..... 5

    1.1 Functionality ..... 6

    1.2 Capacity of Intesis ..... 7

2 KNX System ..... 8

    2.1 Description ..... 8

    2.2 Points definition ..... 8

3 Connections ..... 9

    3.1 Power device ..... 10

    3.2 Connect to Hitachi installation ..... 10

    3.3 Connection to KNX ..... 10

    3.4 Connection to the configuration tool ..... 10

4 Set-up process and troubleshooting ..... 11

    4.1 Pre-requisites ..... 11

    4.2 Intesis MAPS. Configuration & monitoring tool for Intesis KNX series ..... 11

        4.2.1 Introduction ..... 11

        4.2.2 Connection ..... 11

        4.2.3 Configuration tab ..... 12

        4.2.4 KNX configuration ..... 12

        4.2.5 Hitachi configuration ..... 15

        4.2.6 Signals ..... 17

        4.2.7 Sending the configuration to Intesis ..... 18

        4.2.8 Diagnostic ..... 18

        4.2.9 Set-up procedure ..... 20

5 Electrical & Mechanical Features ..... 20

6 Dimensions ..... 22

7 AC Unit Types compatibility ..... 23

8 Error codes for Indoor and Outdoor Units ..... 24

9 Appendix A – Communication Objects Table ..... 27

## 1 Description

### 1.1 Introduction

This document describes the integration of Hitachi VRF air conditioning systems into KNX home automation systems using gateway *Intesis KNX – Hitachi VRF*.

The aim of this integration is to monitor and control your Hitachi air conditioning system, from your KNX TP-1 installation. To do it so, Intesis performs as a one more KNX device, sending and receiving telegrams to group addresses in the KNX network.

Intesis makes available the Hitachi air conditioning system indoor units' datapoints through independent KNX objects.

Up to 64 indoor units supported, depending on product version.

This document assumes that the user is familiar with KNX and Hitachi technologies and their technical terms.

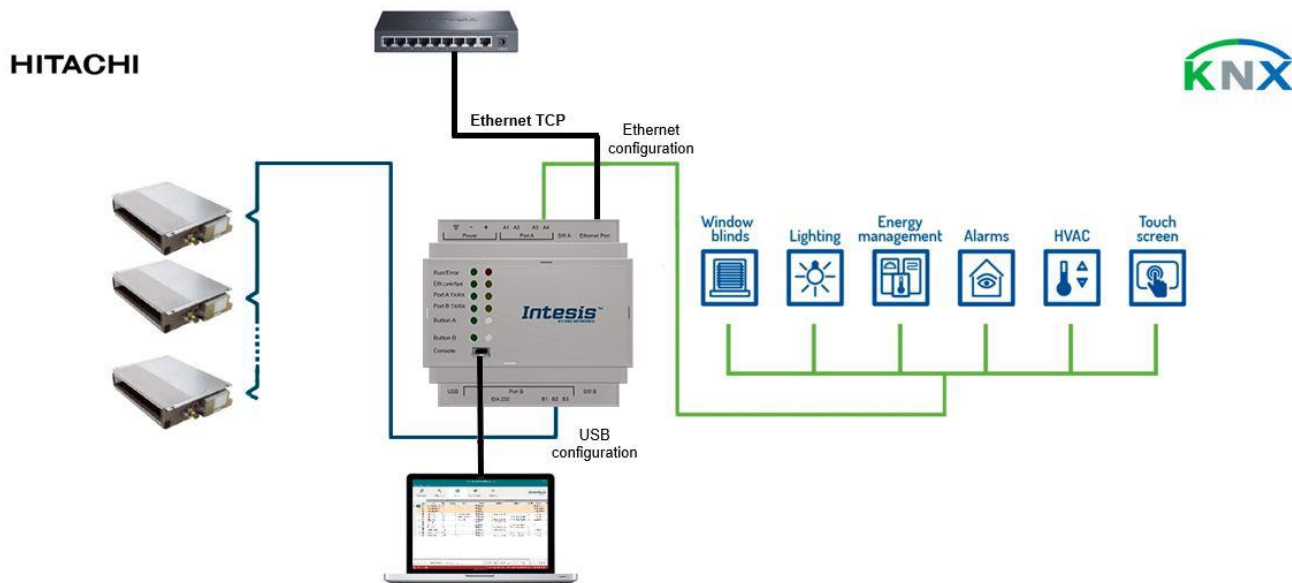

**Integration of Hitachi VRF systems into KNX control systems**

## 1.1 Functionality

Intesis™ continuously monitors Hitachi VRF network for all configured signals and keeps the updated status of all of them in its memory. It triggers updates on configured group addresses to KNX network on value change.

Commands toward the indoor unit communication adaptor are permitted.

Each indoor unit is offered as a set of KNX objects.

| Element                     | Object supported  |
|-----------------------------|---|
| Outdoor Unit                | <ul style="list-style-type: none"><li>• Communication status</li><li>• Status</li></ul>                   |
| Indoor Unit                 | <ul style="list-style-type: none"><li>• Status</li><li>• Command</li><li>• Communication status</li></ul> |
| General signals (all units) | <ul style="list-style-type: none"><li>• Command</li></ul>   |

## 1.2 Capacity of Intesis

| Element                | Max. | Notes   |
|------------------------|------|---|
| Number of indoor units | 64*  | Number of indoor units that can be controlled through Intesis |

\* There are different models of *Intesis KNX – Hitachi VRF* each one with different capacity. The table above shows the capacity for the top model (with maximum capacity).

Their order codes are:

- INKNXHIT016O000: Model supporting up to 16 indoor units
- INKNXHIT064O000: Model supporting up to 64 indoor units

## 2 KNX System

In this section, a common description for all Intesis KNX series gateways is given, from the point of view of KNX system which is called from now on *internal system*. Connection with the Hitachi system is also called from now on *external system*.

### 2.1 Description

Intesis KNX connects directly to the KNX TP-1 bus and performs as one more device into the KNX system, with the same configuration and operational characteristics as other KNX devices.

Internally, the circuit part connected to the KNX bus is opto-isolated from the rest of the electronics.

*Intesis KNX* receives, manages and sends all the telegrams related to its configuration to the KNX bus.

On receiving WRITE telegrams of KNX group addresses associated to communication objects, the corresponding messages are sent to the external system (Hitachi installation).

When a change in a signal of the external system is detected, a WRITE telegram is sent to the KNX bus (addressed with the group address associated to the corresponding group object), in order to maintain both systems synchronized in every moment.

The status of the KNX bus is checked continuously and, if a bus drop-down is detected, for example due to failure in the bus power supply, after the KNX bus is restored again, Intesis will send READ telegrams to group addresses of all communication objects marked with flag 'Ri'. The behavior of each individual point into Intesis is determined by the flags configured for the communication object. See details below.

### 2.2 Points definition

Every group object in configuration has following KNX properties:

| Property                   | Description  |
|----------------------------|--|
| <b>Description</b>         | Descriptive information about the communication object or signal.  |
| <b>Object function</b>     | Information on range of values for the group object.   |
| <b>DPT</b>                 | Datapoint type. It is the KNX data type used to encode the signal's value. It will depend on the type of signal associated in the external system in every case.   |
| <b>Group</b>               | It is the KNX group to which the point is associated. It is also the group to which the read (R), write (W), transmit (T), update (U) and read on init (Ri) flags are applied. It is the sending group.  |
| <b>Listening addresses</b> | They are the addresses that can write on the group object, a part of the main group address.   |
| <b>R</b>                   | Read. If this flag is activated, READ telegrams of this group address will be accepted.  |
| <b>Ri</b>                  | Read on Init. If this flag is activated, the object will trigger corresponding READ request (on associated group address) on initialization.   |
| <b>W</b>                   | Write. If this flag is activated, WRITE telegrams on this group object will be accepted.   |
| <b>T</b>                   | Transmit. If this flag is activated, when the group object value changes, due to a change in the external system, a WRITE telegram of the associated group address will be sent to the KNX bus.          |
| <b>U</b>                   | Update. If this flag is activated, UPDATE telegrams (response to READ telegrams) on this group object will be accepted.  |
| <b>Active</b>              | If activated, the point will be active in Intesis, if not, the behavior will be as if the point is not defined. This allows deactivating points without the need of delete them for possible future use. |

These properties are common for all Intesis KNX series gateways. Although each integration may have specific properties according to the type of signals of the external system.

See list of communication objects in section [9 APPENDIX A – COMMUNICATION OBJECTS TABLE](#).



### 3 Connections

Find below information regarding the Intesis connections available.

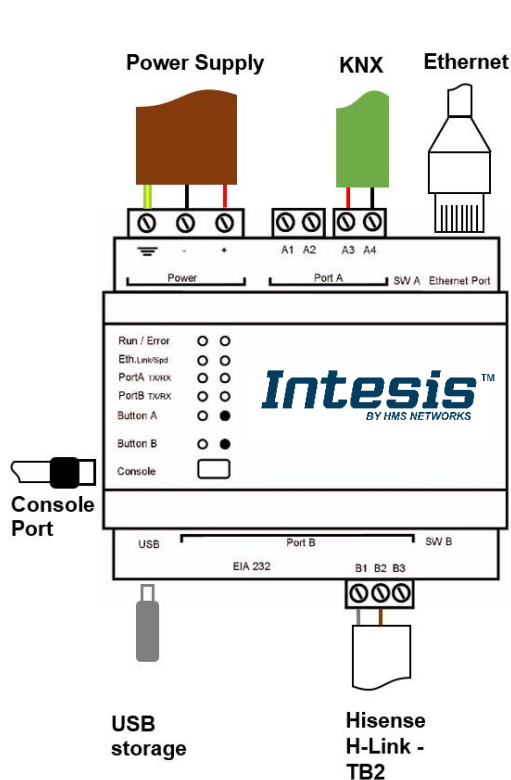

#### Power Supply

Must use NEC Class 2 or Limited Power Source (LPS) and SELV rated power supply.

#### If using DC power supply:

Respect polarity applied of terminals (+) and (-). Be sure the voltage applied is within the range admitted (check table below). The power supply can be connected to earth but only through the negative terminal, never through the positive terminal.

#### If using AC power supply:

Make sure the voltage applied is of the value admitted (24 Vac). Do not connect any of the terminals of the AC power supply to earth, and make sure the same power supply is not supplying any other device.

#### Ethernet

Connect the cable coming from the IP network to the connector ETH of the gateway. Use an Ethernet CAT5 cable. If communicating through the LAN of the building, contact the network administrator and make sure traffic on the port used is allowed through all the LAN path (check the gateway user manual for more information). Default IP is 192.168.100.246. DHCP is enabled by default.

#### PortA / KNX

Connect the KNX TP1 bus to connectors A3 (+) and A4 (-) of gateway's PortA. Respect the polarity.

#### PortB / H-Link Hitachi

Connect the H-Link terminals (TB2) of Hitachi Outdoor Unit to the connectors B1 and B2 of gateway's PortB. There is no polarity to be respected.

#### Console Port

Connect a mini-type B USB cable from your computer to the gateway to allow communication between the Configuration Software and the gateway. Remember that Ethernet connection is also allowed. Check the user manual for more information.

#### USB

Connect a USB storage device (not a HDD) if required. Check the user manual for more information.

Ensure proper space for all connectors when mounted (see section 6)

### 3.1 Power device

The first step to perform is to power up the device. To do so, a power supply working with any of the voltage range allowed is needed (check section 5). Once connected the ON led will turn on.

**WARNING!** In order to avoid earth loops that can damage the gateway, and/or any other equipment connected to it, we strongly recommend:

- The use of DC power supplies, floating or with the negative terminal connected to earth. **Never use a DC power supply with the positive terminal connected to earth.**
- The use of AC power supplies only if they are floating and not powering any other device.

### 3.2 Connect to Hitachi installation

Use the Port B connector of the Intesis device to connect Hitachi H-Link bus to the Intesis. Remember to follow all safety precautions indicated by Hitachi.

Connect the Hitachi H-Link bus to connectors B1 and B2 of gateway's PortB. Bus is not sensitive to polarity.

### 3.3 Connection to KNX

Connect the KNX TP1 bus to connectors A3 (+) and A4 (-) of gateway's PortA. Respect the polarity.

### 3.4 Connection to the configuration tool

This action allows the user to have access to configuration and monitoring of the device (more information can be found in the configuration tool User Manual). Two methods to connect to the PC can be used:

- **Ethernet:** Using the Ethernet port of Intesis.
- **USB:** Using the console port of Intesis, connect a USB cable from the console port to the PC.

## 4 Set-up process and troubleshooting

### 4.1 Pre-requisites

It is necessary to have a KNX installation, device or interface operative and well connected to the corresponding KNX port of Intesis. It is also required to have a Hitachi Air Conditioner installation, with accessible H-Link/TB2 port for connection of Intesis.

Connectors, connection cables, PC to use the configuration tool and other auxiliary material, if needed, are not supplied by HMS Industrial Networks S.L.U for this standard integration.

Items supplied by HMS Networks for this integration are:

- Intesis gateway.
- Link to download the configuration tool.
- USB Console cable to communicate with Intesis.
- Product documentation.

### 4.2 Intesis MAPS. Configuration & monitoring tool for Intesis KNX series

#### 4.2.1 Introduction

Intesis MAPS is a Windows® compatible software developed specifically to monitor and configure Intesis new generation gateways.

The installation procedure and main functions are explained in the *Intesis MAPS KNX User Manual*. This document can be downloaded from the link indicated in the installation sheet supplied with the Intesis device or in the product website at [www.intesis.com](http://www.intesis.com)

In this section, only the specific case of Hitachi to KNX systems will be covered.

Please check the Intesis MAPS KNX User Manual for specific information about the different parameters and how to configure them.

#### 4.2.2 Connection

To configure the Intesis connection parameters press on the **Connection** button in the *menu bar*.

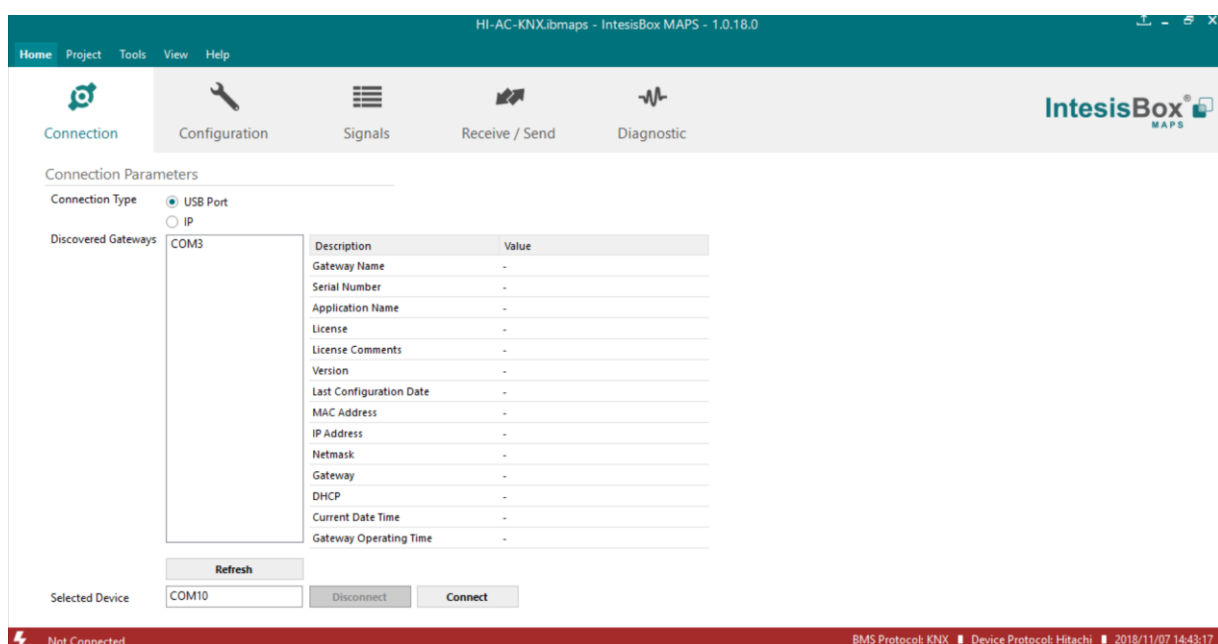

Figure 4.1 MAPS connection

### 4.2.3 Configuration tab

Select the **Configuration** tab to configure the connection parameters. Three subsets of information are shown in this window: General (Gateway general parameters), KNX (KNX interface configuration) and Hitachi (Hitachi interface parameters).

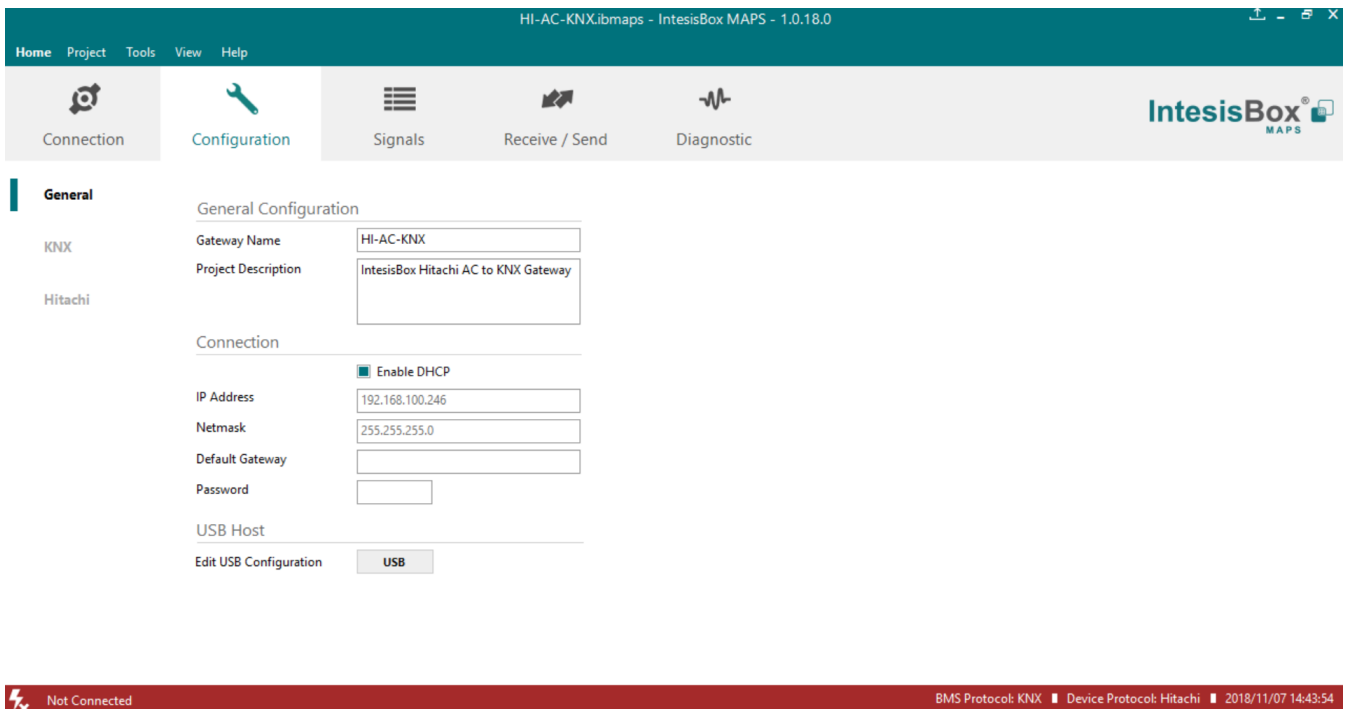

Figure 4.2 Intesis MAPS configuration tab

### 4.2.4 KNX configuration

Set parameters of KNX interface of Intesis.

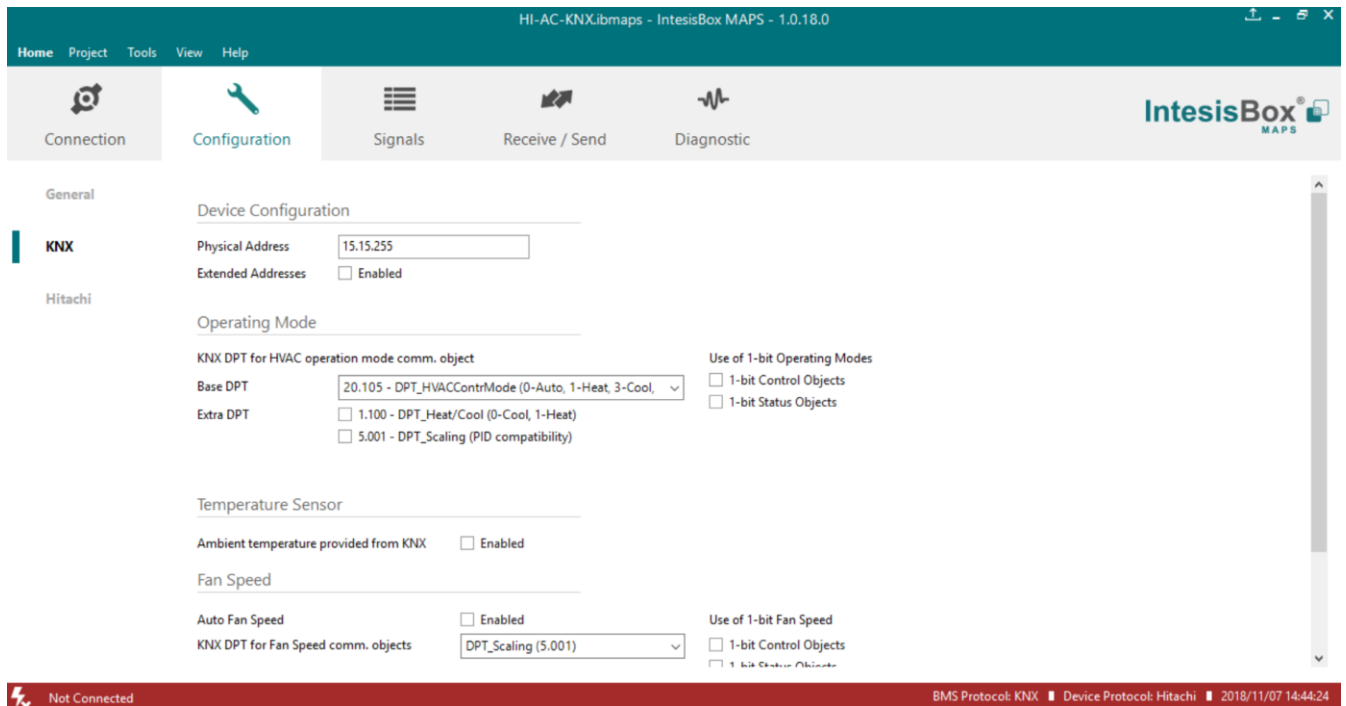

Figure 4.3 Intesis MAPS KNX configuration tab

## 1. Device configuration

**1.1. Physical Address.** KNX physical address of the device in the network

**1.2. Extended Addresses.** Enables usage of KNX Extended addresses (range from 16/0/0 to 32/7/255).

**2. Operating Mode.** Settings related to KNX interface for control and feedback of AC unit's operating mode.

**2.1. KNX DPT for HVAC operation mode comm object. Base DPT.** Base DPT to use for control/monitor the operating mode. Following DPT types are offered:

- DPT\_20.105. DPT\_HVACContrMode: 0-Auto, 1-Heat, 3-Cool, 9-Fan, 14-Dry
- DPT\_5.x (non-standarized): 0-Auto, 1-Heat, 2-Dry, 3-Fan, 4-Cool

**2.2. KNX DPT for HVAC operation mode comm object. Extra DPT.** Additional DPT to use for control/monitor the operating mode.

- DPT\_1.100. DPT\_Heat/Cool: 0-Cool, 1-Heat.
- DPT\_5.001. DPT\_Scaling: Enables objects "Control\_Heat Mode & On" and "Control\_Cool Mode & On". Their type is DPT\_Scaling (0..100%), and their ending is to be able to control parameters On/Off, Cool/Heat of indoor unit from a single percentage object. They are meant to provide compatibility with certain thermostats oriented to the operation of valves for Heating/Cooling. Whenever a value > 0% is received at each of these two objects, the corresponding operating mode and ON operation is sent to the indoor unit. Whenever both values are 0%, indoor unit is set to OFF

**2.3. Use of 1-bit Operating Modes. 1-bit Control Objects.** Enables a bit-type object for the control of each operating mode.

**2.4. Use of 1-bit Operating Modes. 1-bit Status Objects.** Enables a bit-type object for monitoring each operating mode.

**3. Temperature Sensor.**

**3.1. Ambient temperature provided from KNX.** Enables object Control\_KNX ambient temperature.



**NOTE:** Indoor unit does not accept, by itself, that an ambient temperature for control of operation of the indoor unit is provided. To allow regulation of indoor unit according to a temperature reference from KNX, what Intesis does is passing a different temperature setpoint to the indoor unit than the one required by the user. The passed setpoint is such that the difference 'Ambient temperature reported by Hitachi IU – AC setpoint' is equal to 'Ambient temperature reported by KNX – AC setpoint required by KNX', using the following formula:

$$\text{"AC Setp. Temp"} = \text{"AC Ret. Temp"} - (\text{"KNX Amb. Temp."} - \text{"KNX Setp. Temp"})$$

Where:

- AC Setp. Temp: AC indoor unit setpoint temperature
- AC Ret. Temp: AC indoor unit return temperature
- KNX Amb. Temp.: Ambient temperature provided from KNX
- KNX Setp. Temp: Setpoint temperature provided from KNX

Consequently, when using this feature (Ambient temp provided from KNX), setpoint at AC and setpoint in KNX will not necessarily be the same (actually, user will not be able to operate setpoint from AC System controllers as the remote controller).

4. **Fan Speed.** Settings related to KNX interface for control and feedback of AC unit's fan speed.
  - 4.1. **Auto Fan Speed.** Configures availability of Auto Fan Speed control/monitoring objects. Necessary if your indoor unit has auto fan speed.
  - 4.2. **KNX DPT for Fan Speed comm objects. DPT\_5.001, DPT\_Scaling.** Control/monitoring of Fan Speed is performed by means of scaling (percentage) objects. Thresholds for control object and values for status object will vary according to number of fanspeeds of the unit.
  - 4.2. **KNX DPT for Fan Speed comm objects. DPT\_5.010, DPT\_Value\_1\_Ucount.** Control/monitoring of Fan Speed is performed by means of enumerated values.
  - 4.4. **Use of 1-bit Fan Speed. 1-bit Control Objects.** Enables a bit-type object for control of fan speed.
  - 4.5. **Use of 1-bit Fan Speed. 1-bit Status Objects.** Enables a bit-type object for monitoring of each fan speed.
  
5. **Vanes Position.** Settings related to KNX interface for control and feedback of AC unit's vanes position.
  - 4.1. **Auto&Swing Vanes.** Configures availability of Auto and Swing control/monitoring objects.
  - 4.2. **KNX DPT for Vane Position comm objects. DPT\_5.001, DPT\_Scaling.** Control/monitoring of Vanes Positions is performed by means of scaling (percentage) objects. Thresholds for control object and values for status object will vary according to number of vanes positions of the unit.
  - 4.2. **KNX DPT for Vane Position comm objects. DPT\_5.010, DPT\_Value\_1\_Ucount.** Control/monitoring of Vanes Positions is performed by means of enumerated values.
  - 4.4. **Use of 1-bit Fan Speed. 1-bit Control Objects.** Enables a bit-type object for control of Vanes Positions.
  - 4.5. **Use of 1-bit Fan Speed. 1-bit Status Objects.** Enables a bit-type object for monitoring of each Vanes Position.

## 4.2.5 Hitachi configuration

Set parameters for connection with Hitachi's installation.

Units Configuration

Autodiscover

| Unit ID                                    | Unit Type   | IU | OU | Description    |
|--|-------------|----|----|----------------|
| <input checked="" type="checkbox"/> Unit 1 | Not Defined | 1  | 1  | Indoor Unit 1  |
| <input type="checkbox"/> Unit 2            | Not Defined | 2  | 1  | Indoor Unit 2  |
| <input type="checkbox"/> Unit 3            | Not Defined | 3  | 1  | Indoor Unit 3  |
| <input type="checkbox"/> Unit 4            | Not Defined | 4  | 1  | Indoor Unit 4  |
| <input type="checkbox"/> Unit 5            | Not Defined | 5  | 1  | Indoor Unit 5  |
| <input type="checkbox"/> Unit 6            | Not Defined | 6  | 1  | Indoor Unit 6  |
| <input type="checkbox"/> Unit 7            | Not Defined | 7  | 1  | Indoor Unit 7  |
| <input type="checkbox"/> Unit 8            | Not Defined | 8  | 1  | Indoor Unit 8  |
| <input type="checkbox"/> Unit 9            | Not Defined | 9  | 1  | Indoor Unit 9  |
| <input type="checkbox"/> Unit 10           | Not Defined | 10 | 1  | Indoor Unit 10 |
| <input type="checkbox"/> Unit 11           | Not Defined | 11 | 1  | Indoor Unit 11 |
| <input type="checkbox"/> Unit 12           | Not Defined | 12 | 1  | Indoor Unit 12 |
| <input type="checkbox"/> Unit 13           | Not Defined | 13 | 1  | Indoor Unit 13 |
| <input type="checkbox"/> Unit 14           | Not Defined | 14 | 1  | Indoor Unit 14 |
| <input type="checkbox"/> Unit 15           | Not Defined | 15 | 1  | Indoor Unit 15 |
| <input type="checkbox"/> Unit 16           | Not Defined | 16 | 1  | Indoor Unit 16 |
| <input type="checkbox"/> Unit 17           | Not Defined | 17 | 1  | Indoor Unit 17 |
| <input type="checkbox"/> Unit 18           | Not Defined | 18 | 1  | Indoor Unit 18 |
| <input type="checkbox"/> Unit 19           | Not Defined | 19 | 1  | Indoor Unit 19 |
| <input type="checkbox"/> Unit 20           | Not Defined | 20 | 1  | Indoor Unit 20 |
| <input type="checkbox"/> Unit 21           | Not Defined | 21 | 1  | Indoor Unit 21 |

Supported Active Units: -

**Figure 4.4** Intesis MAPS Hitachi configuration tab

In Units Configuration section you need to enter, for each unit:

- **Active.** If it's active (checkbox at Unit xx), ranging from 1 to 64 indoor units that will be integrated (maximum number of units will depend on Intesis model)
- **IU address.** Address 1..64 of Unit in Hitachi H-Link bus.
- **OU address.** Address 1..64 of Outdoor Unit in Hitachi H-Link bus.
- **Description.** Descriptive name to easy identification of the unit (for example, 'living room floor 1 unit', etc).

Additional to manual entry of each unit, Autodiscover of present units in an H-Link installation is possible. To do so, click button **Scan**. Following window will appear:

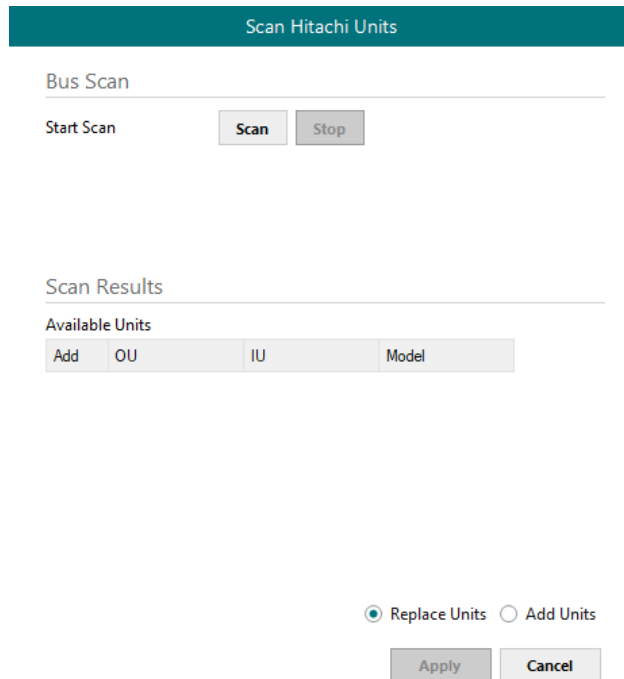

Figure 4.5 Intesis MAPS Scan Hitachi Units window

By pressing **Scan** button, connected Hitachi H-Link bus will be scanned for available units. Error window will appear if there is a problem in the connection with H-Link bus (units not powered, bus not connected, ...).

A progress bar will appear during the scan, which will take up to a few minutes. After scan is completed, detected units will be shown in available units as follows:

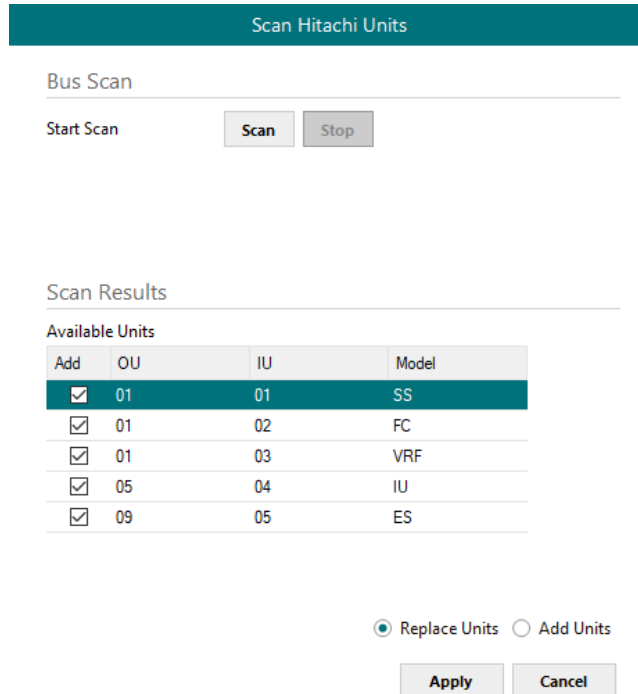

Figure 4.6 Intesis MAPS Scan Hitachi Units window with scan results

Select with its checkbox units to add (or replace) in installation, according to selection **Replace Units / Add Units**. After units to be integrated are selected, click button **Apply**, and changes will appear in previous **Units Configuration** window.



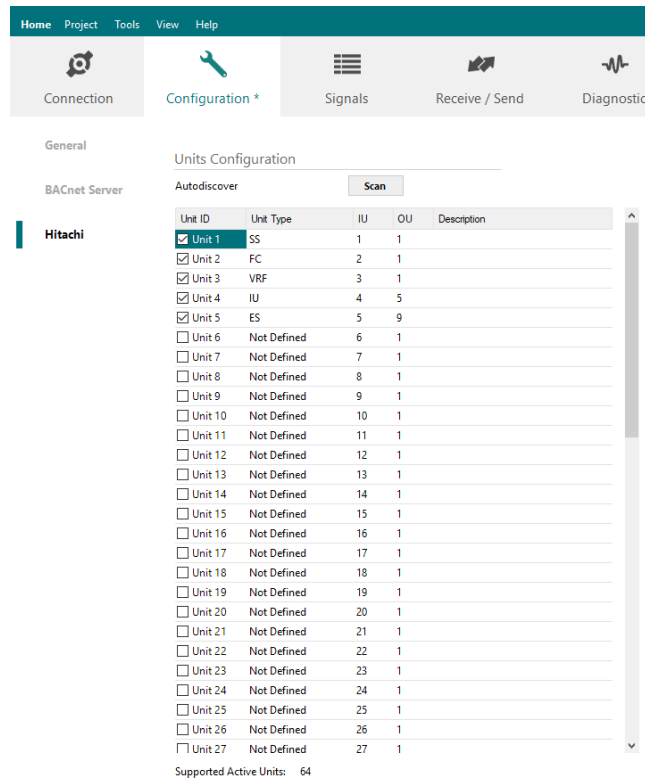

Figure 4.7 Intesis MAPS Hitachi configuration tab after importing scan results

### 4.2.6 Signals

All available KNX objects, its corresponding description and other main parameters are listed in the signals tab.

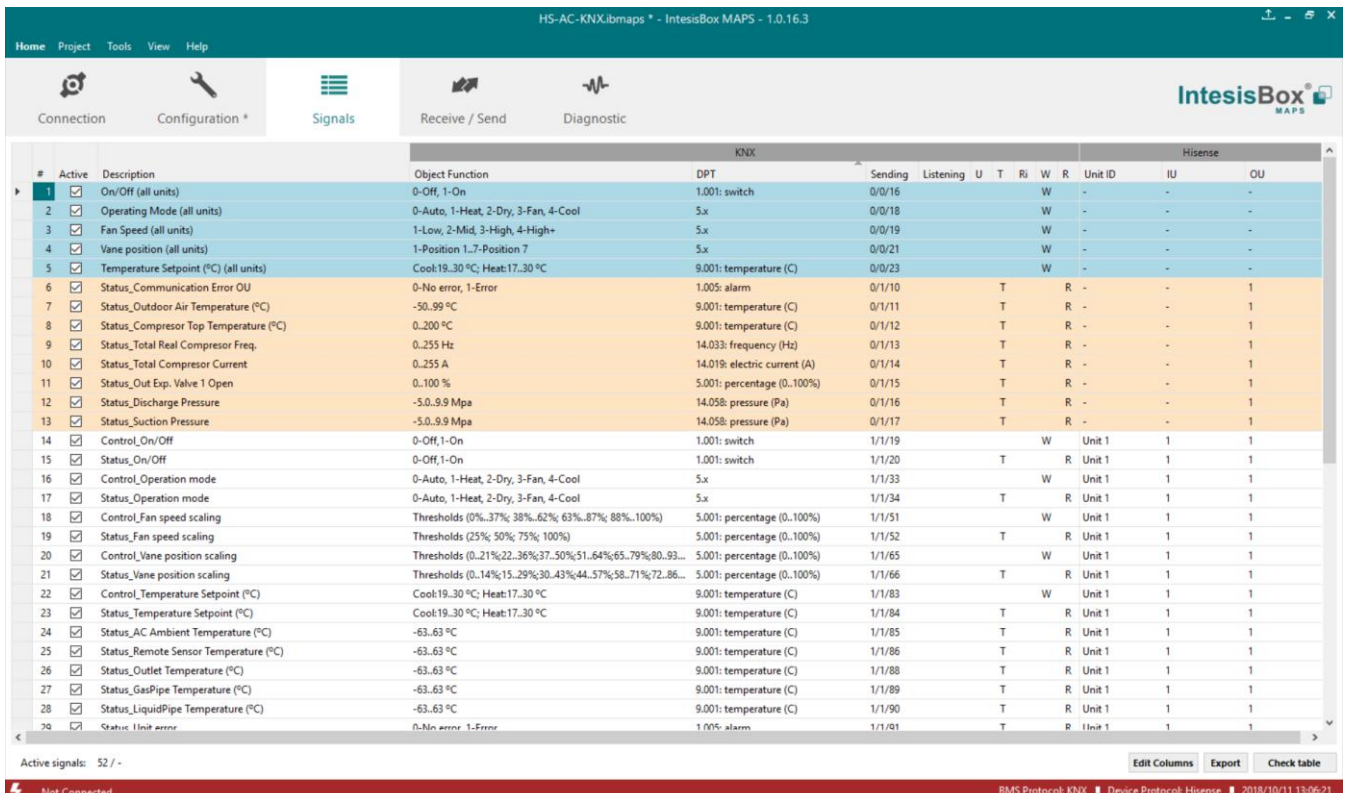

Figure 4.8 Intesis MAPS Signals tab

## 4.2.7 Sending the configuration to Intesis

When the configuration is finished, follow the next steps.

1.- Save the project (Menu option **Project->Save**) on your hard disk (more information in Intesis MAPS User Manual).

2.- Go to tab '**Receive / Send**' of MAPS, and in **Send** section, press **Send** button. Intesis will reboot automatically once the new configuration is loaded.

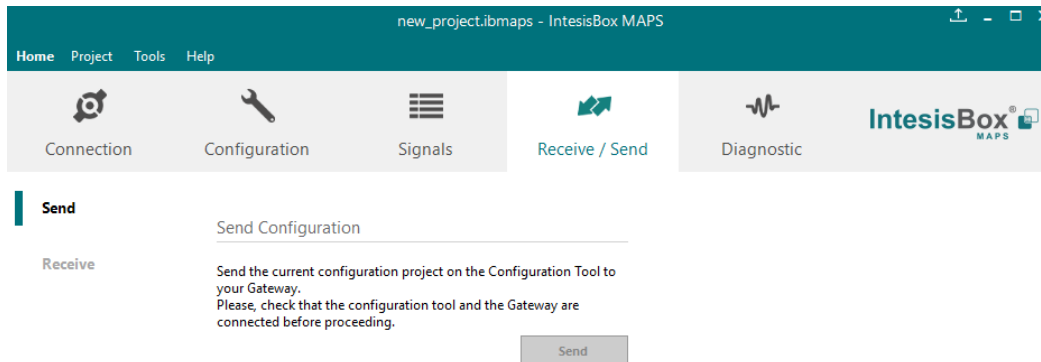

Figure 4.9 Intesis MAPS Receive/Send tab

**After any configuration change, do not forget to send the configuration file to the Intesis using the Send button in the Receive / Send section.**

## 4.2.8 Diagnostic

To help integrators in the commissioning tasks and troubleshooting, the Configuration Tool offers some specific tools and viewers.

In order to start using the diagnostic tools, connection with the Gateway is required.

The Diagnostic section is composed by two main parts: Tools and Viewers.

- **Tools**  
Use the tools section to check the current hardware status of the box, log communications into compressed files to be sent to the support, change the Diagnostic panels' view or send commands to the gateway.
- **Viewers**  
In order to check the current status, viewer for the Internal and External protocols are available. It is also available a generic Console viewer for general information about communications and the gateway status and finally a Signals Viewer to simulate the BMS behavior or to check the current values in the system.

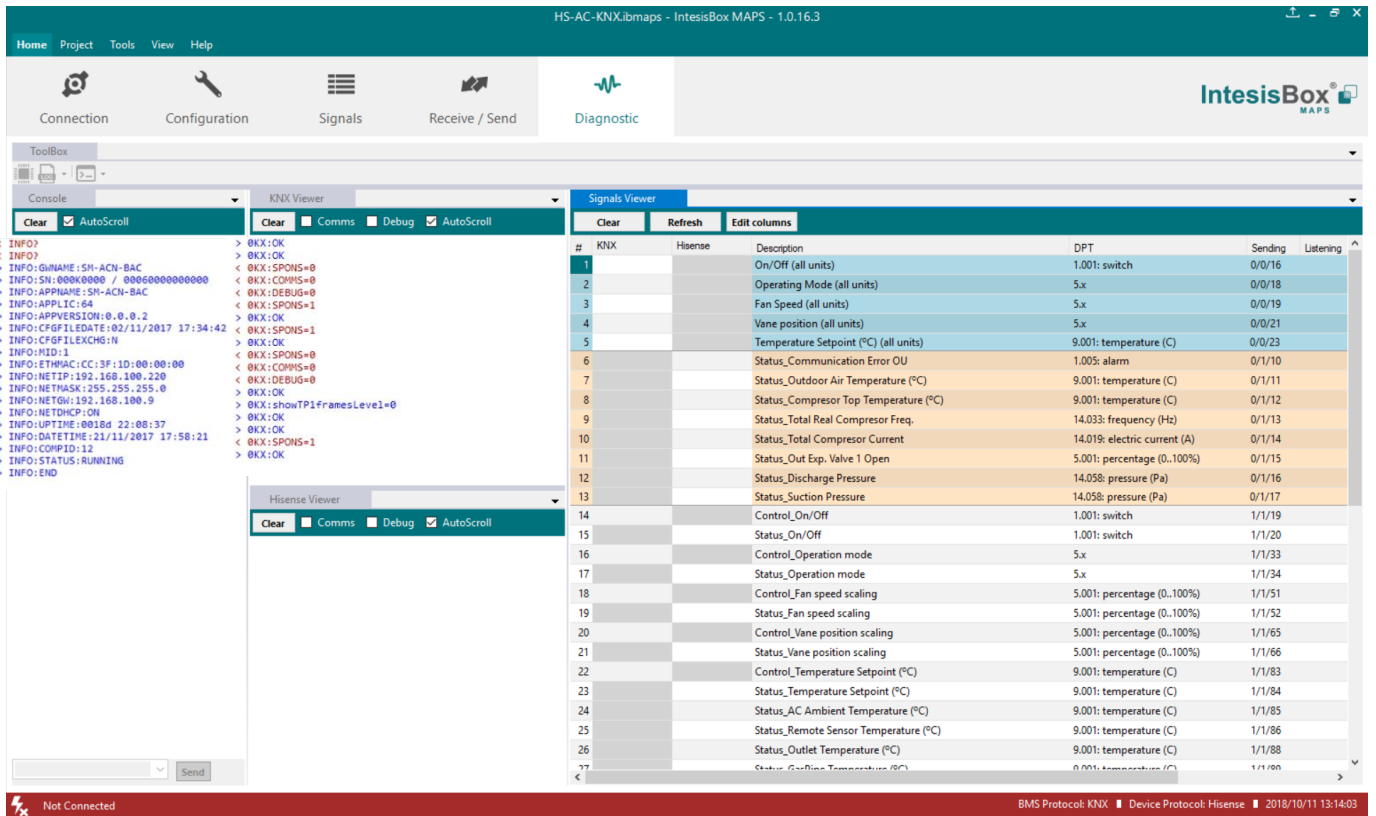

Figure 4.10 Diagnostic

More information about the Diagnostic section can be found in the Configuration Tool manual.

## 4.2.9 Set-up procedure

1. Install Intesis MAPS on your laptop, use the setup program supplied for this and follow the instructions given by the Installation wizard.
2. Install Intesis in the desired installation site. Installation can be on DIN rail or on a stable not vibrating surface (DIN rail mounted inside a metallic industrial cabinet connected to ground is recommended).
3. Connect the KNX communication cable coming from the KNX network to the port marked as Port A on Intesis (More details in section 3).
4. Connect the communication cable coming from the Hitachi H-Link installation to the port marked as Port B of Intesis (More details in section 3).
5. Power up Intesis. The supply voltage can be 9 to 36 Vdc or just 24 Vac. Take care of the polarity of the supply voltage applied.

**WARNING!** In order to avoid earth loops that can damage Intesis and/or any other equipment connected to it, we strongly recommend:

- The use of DC power supplies, floating or with the negative terminal connected to earth. **Never use a DC power supply with the positive terminal connected to earth.**
  - The use of AC power supplies only if they are floating and not powering any other device.
6. If you want to connect using IP, connect the Ethernet cable from the laptop PC to the port marked as Ethernet of Intesis (More details in section 3).

If you want to connect using USB, connect the USB cable from the laptop PC to the port marked as Console of Intesis (More details in section 3).

7. Open Intesis MAPS, create a new project selecting a copy of the one named **INKNXHIT---0000**.
8. Modify the configuration as desired, save it and download the configuration file to Intesis as explained in the Intesis MAPS user manual.
9. Visit the Diagnostic section and check that there is communication activity, some TX frames and some other RX frames. This means that the communication with the KNX installation and Hitachi installation is OK. In case there is no communication activity between Intesis and the KNX side and/or Hitachi units, check that those are operative: check communication cable used to connect all devices and any other communication parameter.

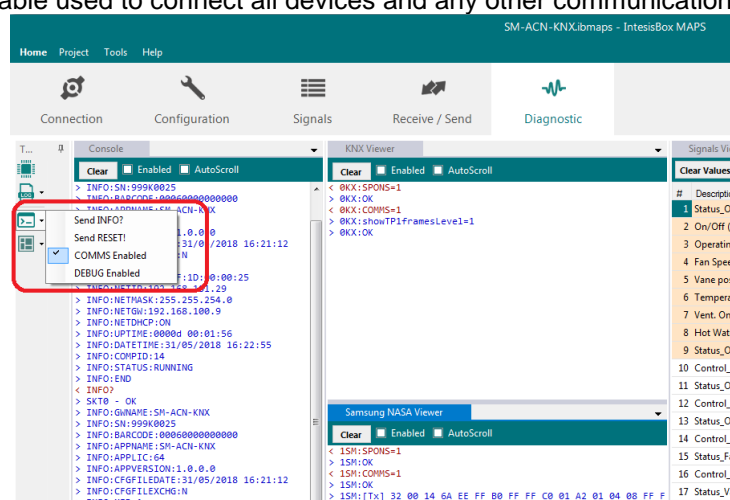

Figure 4.11 Enable COMMS

## 5 Electrical & Mechanical Features



|  |  |                              |   |
|--|--|------------------------------|---|
| <b>Enclosure</b>   | Plastic, type PC (UL 94 V-0)<br>Net dimensions (d×w×h): 90x88x56 mm<br>Recommended space for installation (d×w×h): 130x100x100mm<br>Color: Light Grey. RAL 7035  | <b>Battery</b>               | Size: Coin 20mm x 3.2mm<br>Capacity: 3V / 225mAh<br>Type: Manganese Dioxide Lithium   |
| <b>Mounting</b>  | Wall.<br>DIN rail EN60715 TH35.  | <b>Console Port</b>          | Mini Type-B USB 2.0 compliant<br>1500VDC isolation  |
| <b>Terminal Wiring</b><br>(for power supply and low-voltage signals) | Per terminal: solid wires or stranded wires (twisted or with ferrule)<br>1 core: 0.5mm <sup>2</sup> ... 2.5mm <sup>2</sup><br>2 cores: 0.5mm <sup>2</sup> ... 1.5mm <sup>2</sup><br>3 cores: not permitted                             | <b>USB port</b>              | Type-A USB 2.0 compliant<br>Only for USB flash storage device<br>(USB pen drive)<br>Power consumption limited to 150mA<br>(HDD connection not allowed)                      |
| <b>Power</b>   | 1 x Plug-in screw terminal block (3 poles)<br>9 to 36VDC +/-10%, Max.: 140mA.<br>24VAC +/-10% 50-60Hz, Max.: 127mA<br>Recommended: 24VDC   | <b>Push Button</b>           | Button A: Check the user manual<br>Button B: Check the user manual  |
| <b>Ethernet</b>  | 1 x Ethernet 10/100 Mbps RJ45<br>2 x Ethernet LED: port link and activity  | <b>Operation Temperature</b> | 0°C to +60°C  |
| <b>Port A</b>  | 1 x KNX TP-1 Plug-in screw terminal block orange (2 poles)<br>2500VDC isolation from other ports<br>KNX power consumption: 5mA<br>Voltage rating: 29VDC<br>1 x Plug-in screw terminal block green (2 poles)<br>Reserved for future use | <b>Operational Humidity</b>  | 5 to 95%, no condensation   |
| <b>Switch A (SWA)</b>  | 1 x DIP-Switch for PORT A configuration:<br>Reserved for future use  | <b>Protection</b>            | IP20 (IEC60529)   |
| <b>PORT B</b>  | 1 x Serial EIA232 (SUB-D9 male connector)<br>Reserved for future use<br>1 x H-Link Plug-in screw terminal block (3 poles)<br>1500VDC isolation from other ports  | <b>LED Indicators</b>        | 10 x Onboard LED indicators<br>2 x Run (Power)/Error<br>2 x Ethernet Link/Speed<br>2 x Port A TX/RX<br>2 x Port B TX/RX<br>1 x Button A indicator<br>1 x Button B indicator |
| <b>Switch B (SWB)</b>  | 1 x DIP-Switch for PORT B configuration:<br>Reserved for future use (leave OFF, default)   |                              |   |

## 6 Dimensions

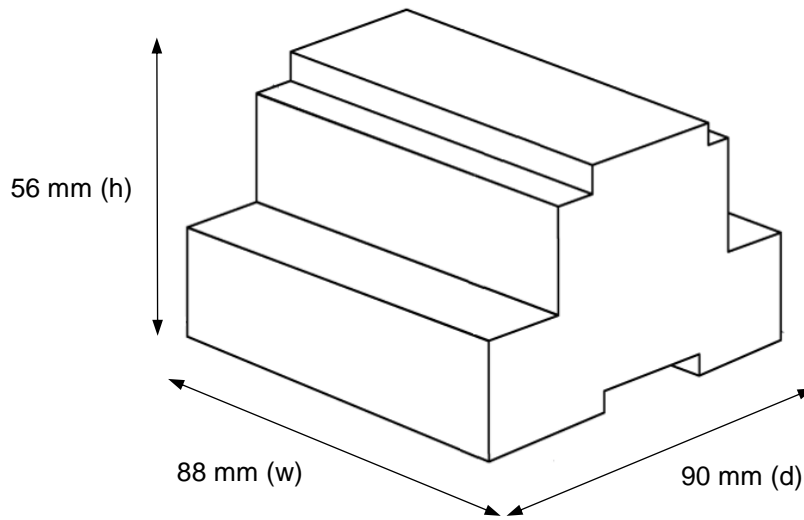

Recommended available space for its installation into a cabinet (wall or DIN rail mounting), with space enough for external connections

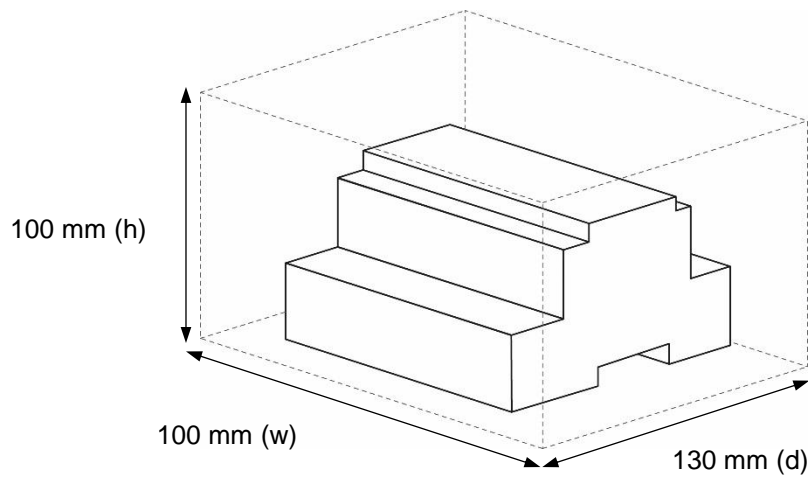

## 7 AC Unit Types compatibility

A list of Hitachi unit model references compatible with INKNXHIT016O000 / INKNXHIT064O000 and their available features can be found in:

[https://www.intesis.com/docs/compatibilities/inxxxhit001r000\\_compatibility](https://www.intesis.com/docs/compatibilities/inxxxhit001r000_compatibility)

## 8 Error codes for Indoor and Outdoor Units

This list contains all possible values shown in KNX Object for “Error Code” for each indoor unit and outdoor unit.

It must be taken into account that Outdoor Units are only able to reflect a single error for each indoor / outdoor unit in the system. Thus, a unit having two or more active errors from that list will only report a single error code – the one of the first error that has been detected.

| Error Code | Category     | Content of Abnormality                              | Leading Cause  |
|------------|--------------|---|--|
| 01         | Indoor Unit  | Activation of Protection Device (Float Switch)      | Activation of Float Switch<br>(High Water Level in Drain Pan, Abnormality of Drain Pipe, Float Switch or Drain Pan)  |
| 02         | Outdoor Unit | Activation of Protection Device (High Pressure Cut) | Activation of PSH (Pipe Clogging, Excessive Refrigerant! Inert Gas Mixing)   |
| 03         | Transmission | Abnormality between Indoor and Outdoor              | incorrect Wiring, Loose Terminals, Disconnect Wire, Blowout of Fuse, Outdoor Unit Power OFF  |
| 04         |              | Abnormality between Inverter PCB and Outdoor PCB    | Inverter PCB - Outdoor PCB Transmission Failure (Loose Connector, Wire Breaking, Blowout of Fuse)  |
| 04.        |              | Abnormality between Fan Controller and Outdoor PCB  | Fan Controller - Outdoor PCB Transmission Failure (Loose Connector, Wire Breaking, Blowout of Fuse)  |
| 05         | Supply Phase | Abnormality Power Source Phases                     | Incorrect Power Source, Connection to Reversed Phase, Open-Phase   |
| 06         | Voltage      | Abnormal Inverter Voltage                           | Outdoor Voltage Drop, insufficient Power Capacity  |
| 06.        |              | Abnormal Fan Controller Voltage                     | Outdoor Voltage Drop, Insufficient Power Capacity  |
| 07         | Cycle        | Decrease in Discharge Gas Superheat                 | Excessive Refrigerant! Charge, Failure of Thermistor, Incorrect Wiring, Incorrect Piping Connection, Expansion Valve Locking at Opened Position (Disconnect Connector)                   |
| 08         |              | Increase in Discharge Gas Temperature               | Insufficient Refrigerant! Charge, Pipe Clogging, Failure of Thermistor, Incorrect Wiring, Incorrect Piping Connection, Expansion Valve Locking at Closed Position (Disconnect Connector) |
| 0A         | Transmission | Abnormality between Outdoor and Outdoor             | Incorrect Wiring, Breaking Wire, Loose Terminals   |
| 0b         | Outdoor Unit | Incorrect Outdoor Unit Address Setting              | Duplication of Address Setting for Outdoor Units (Sub Units) in Same Refrigerant! Cycle System   |
| 0c         |              | Incorrect Outdoor Unit Main Unit                    | Two (or more) Outdoor Units Set  |



|    |                        | Setting   | as "Main Unit" Exist in Same Refrigerant! Cycle System   |
|----|------------------------|---|--|
| 11 | Sensor on Indoor Unit  | Inlet Air Thermistor  | Incorrect Wiring, Disconnecting Wiring Breaking Wire, Short Circuit  |
| 12 |                        | Outlet Air Thermistor   |  |
| 13 |                        | Freeze Protection Thermistor  |  |
| 14 |                        | Gas Piping Thermistor   |  |
| 19 | Fan Motor              | Activation of Protection Device for Indoor Fan                                      | Fan Motor Overheat, Locking  |
| 21 | Sensor on Outdoor Unit | High Pressure Sensor  | Incorrect Wiring, Disconnecting Wiring Breaking Wire, Short Circuit  |
| 22 |                        | Outdoor Air Thermistor  |  |
| 23 |                        | Discharge Gas Thermistor on Top of Compressor                                       |  |
| 24 |                        | Heat Exchanger Liquid Pipe Thermistor   |  |
| 25 |                        | Heat Exchanger Gas Pipe Thermistor  |  |
| 29 |                        | Low Pressure Sensor   |  |
| 31 | System                 | Incorrect Capacity Setting of Outdoor Unit and Indoor Unit                          | Incorrect Capacity Code Setting of Combination Excessive or Insufficient Indoor Unit Total Capacity Code             |
| 35 |                        | Incorrect Setting of Indoor Unit No.  | Duplication of Indoor Unit No. in same Ref. Gr.  |
| 36 |                        | Incorrect of Indoor Unit Combination  | Indoor Unit is Designed for R22  |
| 38 |                        | Abnormality of Picking up Circuit for Protection in Outdoor Unit                    | Failure of Protection Detecting Device (Incorrect Wiring of Outdoor PCB)   |
| 39 | Compressor             | Abnormality Running Current at Constant! Speed Compressor                           | Overcurrent, Blowout Fuse, Current Sensor Failure, instantaneous Power Failure, Voltage Drop, Abnormal Power Supply  |
| 3A | Outdoor Unit           | Abnormality of Outdoor Unit Capacity  | Outdoor Unit Capacity > 510kBtu/h  |
| 3b |                        | Incorrect Setting of Outdoor Unit Models Combination or Voltage                     | Incorrect Setting of Main and Sub Unit(s) Combination or Voltage   |
| 3d |                        | Abnormality Transmission between Main Unit and Sub Unit(s)                          | Incorrect Wiring, Disconnect Wire, Breaking Wire, PCB Failure  |
| 43 | Protection Device      | Activation of Low Compression Ratio Protection Device                               | Defective Compression (Failure of Compressor of Inverter, Loose Power Supply Connection)                             |
| 44 |                        | Activation of Low Pressure Increase Protection Device                               | Overload at Cooling, High Temperature at Heating, Expansion Valve Locking (Loose Connector)                          |
| 45 |                        | Activation of High Pressure Increase Protection Device                              | Overload Operation (Clogging, Short-Pass), Pipe Clogging, Excessive Refrigerant!, Inert Gas Mixing                   |
| 47 |                        | Activation of Low Pressure Decrease Protection Device (Vacuum Operation Protection) | Insufficient Refrigerant!, Refrigerant! Piping, Clogging, Expansion Valve Locking at Open Position (Loose Connector) |

|    |                          |   |  |
|----|--------------------------|---|--|
| 48 |                          | Activation of Inverter Overcurrent Protection Device                          | Overload Operation, Compressor Failure   |
| 51 | Sensor                   | Abnormal Inverter Current! Sensor   | Current! Sensor Failure  |
| 53 | Inverter                 | Inverter Error Signal Detection   | Driver IC Error Signal Detection (Protection for Overcurrent, Low Voltage, Short Circuit)                                  |
| 54 |                          | Abnormality of Inverter Fin Temperature                                       | Abnormal Inverter Fin Thermistor, Heat Exchanger Clogging, Fan Motor Failure   |
| 55 |                          |   |  |
| 57 | Fan Controller           | Activation of Fan Controller Protection                                       | Driver IC Error Signal Detection (Protection for Overcurrent, Low Voltage, Short Circuit), Instantaneous Overcurrent       |
| 5A |                          | Abnormality of Fan Controller Fin Temperature                                 | Fin Thermistor Failure, Heat Exchanger Clogging, Fan Motor Failure   |
| 5b |                          | Activation of Overcurrent Protection  | Fan Motor Failure  |
| 5C |                          | Abnormality of Fan Controller Sensor  | Failure of Current! Sensor (Instantaneous Overcurrent, Increase of Fin Temperature, Low Voltage, Earth Fault, Step-Out)    |
| EE | Compressor               | Compressor Protection Alarm<br>(It is cannot be reset from remote Controller) | This alarm code appears when the following alarms• occurs three times within 6 hours.<br><br>*02, 07, 08, 39, 43 to 45, 47 |
| b1 | Outdoor Unit No. Setting | Incorrect Setting of Unit and Refrigerant! Cycle No.                          | Over 64 Number is Set for Address or Refrigerant! Cycle.   |
| b5 | Indoor Unit No. Setting  | Incorrect Indoor Unit Connection Number Setting                               | More than 17 Non-Corresponding to Hi-NET Units are Connected to One System.  |
| C1 | Switch Box Unit          | Incorrect Indoor Unit Connection  | 2 or more Switch Box Units are connected between outdoor unit and indoor unit.   |
| C2 |                          | Incorrect Indoor Unit Connection No. Setting                                  | 9 or More Indoor Units Connected to Switch Box Unit  |
| C3 |                          | Incorrect Indoor Unit Connection  | The indoor units of different refrigerant! cycle is connected to Switch Box unit.  |

9 Appendix A – Communication Objects Table

| TOPIC                          | NAME                                  | LEN                                   | DATAPOINT TYPE     |                            | FLAGS  |   |                         |                                   | FUNCTION                              |
|--------------------------------|---------------------------------------|---------------------------------------|--------------------|----------------------------|--------|---|-------------------------|-----------------------------------|---------------------------------------|
|                                |                                       |                                       | DPT_NAME           | DPT_ID                     | R      | W | T                       | U                                 |                                       |
| GLOBAL SIGNALS                 | ON/OFF                                | On/Off (all units)                    | 1 bit              | DPT_Switch                 | 1.001  |   | W                       |                                   | 0-Off, 1-On                           |
|                                | OP MODE                               | Operating Mode (all units)            | 1 byte             | DPT_HVACContrMode          | 20.105 |   | W                       |                                   | 0-Auto, 1-Heat, 3-Cool, 9-Fan, 14-Dry |
|                                |                                       | Operating Mode (all units)            | 1 byte             | Non-standarized            | 5.x    |   | W                       |                                   | 0-Auto, 1-Heat, 2-Dry, 3-Fan, 4-Cool  |
|                                | FAN SPEED                             | Fan Speed (all units)                 | 1 byte             | Non-standarized            | 5.x    |   | W                       |                                   | 1-Low, 2-Mid, 3-High, 4-High+         |
|                                |                                       | Fan Speed AUTO (all units)            | 1 bit              | DPT_Switch                 | 1.001  |   | W                       |                                   | 1-Set auto fan; 0-Stop auto fan       |
|                                | VANE POSITION                         | Vane position (all units)             | 1 byte             | Non-standarized            | 5.x    |   | W                       |                                   | 1-Position 1...7-Position 7           |
| Vane position AUTO (all units) |                                       | 1 bit                                 | DPT_Switch         | 1.001                      |        | W |                         | 1-Set auto vane; 0-Stop auto vane |                                       |
| SETP TEMP                      | Temperature Setpoint (°C) (all units) | 2 byte                                | DPT_Value_Temp     | 9.001                      |        | W |                         | Cool:19..30 °C; Heat:17..30 °C    |                                       |
| OUTDOOR UNIT SIGNALS           | COMM ERROR                            | Status_Communication Error OU         | 1 bit              | DPT_Alarm                  | 1.005  | R |                         | T                                 | 0-No error, 1-Error                   |
|                                | TEMPERATURES                          | Status_Outdoor Air Temperature (°C)   | 2 byte             | DPT_Value_Temp             | 9.001  | R |                         | T                                 | -50..99 °C                            |
|                                |                                       | Status_Compresor Top Temperature (°C) | 2 byte             | DPT_Value_Temp             | 9.001  | R |                         | T                                 | 0..200 °C                             |
|                                | COMPRESOR                             | Status_Total Real Compresor Freq.     | 4 byte             | DPT_Value_Frequency        | 14.033 | R |                         | T                                 | 0..255 Hz                             |
|                                |                                       | Status_Total Compresor Current        | 4 byte             | DPT_Value_Electric_Current | 14.019 | R |                         | T                                 | 0..255 A                              |
|                                | VALVE                                 | Status_Out Exp. Valve 1 Open          | 1 byte             | DPT_Scaling                | 5.001  | R |                         | T                                 | 0..100 %                              |
|                                | PRESSURE                              | Status_Discharge Pressure             | 4 byte             | DPT_Value_Pressure         | 14.058 | R |                         | T                                 | -5.0..9.9 Mpa                         |
| Status_Suction Pressure        |                                       | 4 byte                                | DPT_Value_Pressure | 14.058                     | R      |   | T                       | -5.0..9.9 Mpa                     |                                       |
| ON / OFF                       | ON / OFF                              | Control_On/Off                        | 1 bit              | DPT_Switch                 | 1.001  |   | W                       |                                   | 0-Off,1-On                            |
|                                |                                       | Status_On/Off                         | 1 bit              | DPT_Switch                 | 1.001  | R |                         | T                                 | 0-Off,1-On                            |
|                                | OP MODE                               | Control_Operation mode                | 1 byte             | DPT_HVACContrMode          | 20.105 |   | W                       |                                   | 0-Auto, 1-Heat, 3-Cool, 9-Fan, 14-Dry |
|                                |                                       | Status_Operation mode                 | 1 byte             | DPT_HVACContrMode          | 20.105 | R |                         | T                                 | 0-Auto, 1-Heat, 3-Cool, 9-Fan, 14-Dry |
|                                |                                       | Control_Operation mode                | 1 byte             | Non-standarized            | 5.x    |   | W                       |                                   | 0-Auto, 1-Heat, 2-Dry, 3-Fan, 4-Cool  |
|                                |                                       | Status_Operation mode                 | 1 byte             | Non-standarized            | 5.x    | R |                         | T                                 | 0-Auto, 1-Heat, 2-Dry, 3-Fan, 4-Cool  |
|                                |                                       | Control_Mode Cool/Heat                | 1 bit              | DPT_Heat/Cool              | 1.100  |   | W                       |                                   | 0-Cool, 1-Heat                        |
|                                |                                       | Status_Mode Cool/Heat                 | 1 bit              | DPT_Heat/Cool              | 1.100  | R |                         | T                                 | 0-Cool, 1-Heat                        |
| Control_Heat mode&ON           | 1 byte                                | DPT_Scaling                           | 5.001              |                            | W      |   | 0%-Off, 1%-100%-On+Heat |                                   |                                       |

|                     |                              |                                  |                 |                 |       |   |   |   |  |
|---------------------|------------------------------|----------------------------------|-----------------|-----------------|-------|---|---|---|--|
| INDOOR UNIT SIGNALS | FAN SPEED                    | Control_Cool mode&ON             | 1 byte          | DPT_Scaling     | 5.001 |   | W |   | 0%-Off, 1%-100%-On+Cool  |
|                     |                              | Control_Auto mode                | 1 bit           | DPT_Switch      | 1.001 |   | W |   | 1-Set auto mode  |
|                     |                              | Status_Auto mode                 | 1 bit           | DPT_Switch      | 1.001 | R |   | T   | 1-Auto mode active, 0-Auto mode not active                           |
|                     |                              | Control_Heat mode                | 1 bit           | DPT_Switch      | 1.001 |   | W |   | 1-Set heat mode  |
|                     |                              | Status_Heat mode                 | 1 bit           | DPT_Switch      | 1.001 | R |   | T   | 1-Heat mode active, 0-Heat mode not active                           |
|                     |                              | Control_Cool mode                | 1 bit           | DPT_Switch      | 1.001 |   | W |   | 1-Set cool mode  |
|                     |                              | Status_Cool mode                 | 1 bit           | DPT_Switch      | 1.001 | R |   | T   | 1-Cool mode active, 0-Cool mode not active                           |
|                     |                              | Control_Fan mode                 | 1 bit           | DPT_Switch      | 1.001 |   | W |   | 1-Set fan mode   |
|                     |                              | Status_Fan mode                  | 1 bit           | DPT_Switch      | 1.001 | R |   | T   | 1-Fan mode active, 0-Fan mode not active                             |
|                     |                              | Control_Dry mode                 | 1 bit           | DPT_Switch      | 1.001 |   | W |   | 1-Set dry mode   |
|                     |                              | Status_Dry mode                  | 1 bit           | DPT_Switch      | 1.001 | R |   | T   | 1-Dry mode active, 0-Dry mode not active                             |
|                     | Control_Fan speed enumerated | 1 byte                           | Non-standarized | 5.x             |       | W |   | 1-Low, 2-Mid, 3-High, 4-High+                       |  |
|                     | Status_Fan speed enumerated  | 1 byte                           | Non-standarized | 5.x             | R     |   | T | 1-Low, 2-Mid, 3-High, 4-High+                       |  |
|                     | Control_Fan speed scaling    | 1 byte                           | DPT_Scaling     | 5.001           |       | W |   | Thersholds (0%..37%; 38%..62%; 63%..87%; 88%..100%) |  |
|                     | Status_Fan speed scaling     | 1 byte                           | DPT_Scaling     | 5.001           | R     |   | T | Thersholds (25%; 50%; 75%; 100%)                    |  |
|                     | Control_Fan speed low        | 1 bit                            | DPT_Switch      | 1.001           |       | W |   | 1-Set fan speed low                                 |  |
|                     | Status_Fan speed low         | 1 bit                            | DPT_Switch      | 1.001           | R     |   | T | 1-Speed low active, 0-Speed low not active          |  |
|                     | Control_Fan speed mid        | 1 bit                            | DPT_Switch      | 1.001           |       | W |   | 1-Set fan speed mid                                 |  |
|                     | Status_Fan speed mid         | 1 bit                            | DPT_Switch      | 1.001           | R     |   | T | 1-Speed mid active, 0-Speed mid not active          |  |
|                     | Control_Fan speed high       | 1 bit                            | DPT_Switch      | 1.001           |       | W |   | 1-Set fan speed high                                |  |
|                     | Status_Fan speed high        | 1 bit                            | DPT_Switch      | 1.001           | R     |   | T | 1-Speed high active, 0-Speed high not active        |  |
|                     | Control_Fan speed high+      | 1 bit                            | DPT_Switch      | 1.001           |       | W |   | 1-Set fan speed high+                               |  |
|                     | Status_Fan speed high+       | 1 bit                            | DPT_Switch      | 1.001           | R     |   | T | 1-Speed high+ active, 0-Speed high+ not active      |  |
|                     | Control_Fan speed Man/Auto   | 1 bit                            | DPT_Switch      | 1.001           |       | W |   | 0-Manual; 1-Auto                                    |  |
|                     | Status_Fan speed Man/Auto    | 1 bit                            | DPT_Switch      | 1.001           | R     |   | T | 0-Manual; 1-Auto                                    |  |
|                     | VANE POS                     | Control_Vane position enumerated | 1 byte          | Non-standarized | 5.x   |   | W |   | 1-Position 1..7-Position 7   |
|                     |                              | Status_Vane position enumerated  | 1 byte          | Non-standarized | 5.x   | R |   | T   | 1-Position 1..7-Position 7   |
|                     |                              | Control_Vane position scaling    | 1 byte          | DPT_Scaling     | 5.001 |   | W |   | Thersholds(0..21%;22..36%;37..50%;51..64%;65..79%;80..93%; 94..100%) |
|                     |                              | Status_Vane position scaling     | 1 byte          | DPT_Scaling     | 5.001 | R |   | T   | Thersholds(0..14%;15..29%;30..43%;44..57%;58..71%;72..86%; 87..100%) |

|                                       |                                  |                                    |                  |                |       |   |   |  |                                |
|---------------------------------------|----------------------------------|------------------------------------|------------------|----------------|-------|---|---|--|--------------------------------|
| INDOOR UNIT SIGNALS                   | Control_Vane position auto       | 1 bit                              | DPT_Switch       | 1.001          | R     |   | T | 1-Set auto vane, 0-Stop auto vane                      |                                |
|                                       | Status_Vane position auto        | 1 bit                              | DPT_Switch       | 1.001          |       | W |   | 1-Vane auto active, 0-Vane auto not active             |                                |
|                                       | Control_Vane position position-1 | 1 bit                              | DPT_Switch       | 1.001          | R     |   | T | 1-Set position-1 vane                                  |                                |
|                                       | Status_Vane position position-1  | 1 bit                              | DPT_Switch       | 1.001          |       | W |   | 1-Vane position-1 active, 0-Vane position-1 not active |                                |
|                                       | Control_Vane position position-2 | 1 bit                              | DPT_Switch       | 1.001          | R     |   | T | 1-Set position-2 vane                                  |                                |
|                                       | Status_Vane position position-2  | 1 bit                              | DPT_Switch       | 1.001          |       | W |   | 1-Vane position-2 active, 0-Vane position-2 not active |                                |
|                                       | Control_Vane position position-3 | 1 bit                              | DPT_Switch       | 1.001          | R     |   | T | 1-Set position-3 vane                                  |                                |
|                                       | Status_Vane position position-3  | 1 bit                              | DPT_Switch       | 1.001          |       | W |   | 1-Vane position-3 active, 0-Vane position-3 not active |                                |
|                                       | Control_Vane position position-4 | 1 bit                              | DPT_Switch       | 1.001          | R     |   | T | 1-Set position-4 vane                                  |                                |
|                                       | Status_Vane position position-4  | 1 bit                              | DPT_Switch       | 1.001          |       | W |   | 1-Vane position-4 active, 0-Vane position-4 not active |                                |
|                                       | Control_Vane position position-5 | 1 bit                              | DPT_Switch       | 1.001          | R     |   | T | 1-Set position-5 vane                                  |                                |
|                                       | Status_Vane position position-5  | 1 bit                              | DPT_Switch       | 1.001          |       | W |   | 1-Vane position-5 active, 0-Vane position-5 not active |                                |
|                                       | Control_Vane position position-6 | 1 bit                              | DPT_Switch       | 1.001          | R     |   | T | 1-Set position-6 vane                                  |                                |
|                                       | Status_Vane position position-6  | 1 bit                              | DPT_Switch       | 1.001          |       | W |   | 1-Vane position-6 active, 0-Vane position-6 not active |                                |
|                                       | Control_Vane position position-7 | 1 bit                              | DPT_Switch       | 1.001          | R     |   | T | 1-Set position-7 vane                                  |                                |
|                                       | Status_Vane position position-7  | 1 bit                              | DPT_Switch       | 1.001          |       | W |   | 1-Vane position-7 active, 0-Vane position-7 not active |                                |
|                                       | TEMPERATURES                     | Control_Temperature Setpoint (°C)  | 2 byte           | DPT_Value_Temp | 9.001 |   | W |  | Cool:19..30 °C; Heat:17..30 °C |
|                                       |                                  | Status_Temperature Setpoint (°C)   | 2 byte           | DPT_Value_Temp | 9.001 | R |   | T  | Cool:19..30 °C; Heat:17..30 °C |
|                                       |                                  | Status_AC Ambient Temperature (°C) | 2 byte           | DPT_Value_Temp | 9.001 | R |   | T  | -63..63 °C                     |
| Status_Remote Sensor Temperature (°C) |                                  | 2 byte                             | DPT_Value_Temp   | 9.001          | R     |   | T | -63..63 °C   |                                |
| Control_KNX ambient Temperature (°C)  |                                  | 2 byte                             | DPT_Value_Temp   | 9.001          |       | W |   | °C   |                                |
| Status_Outlet Temperature (°C)        |                                  | 2 byte                             | DPT_Value_Temp   | 9.001          |       | W |   | -63..63 °C   |                                |
| Status_GasPipe Temperature (°C)       |                                  | 2 byte                             | DPT_Value_Temp   | 9.001          | R     |   | T | -63..63 °C   |                                |
| Status_LiquidPipe Temperature (°C)    |                                  | 2 byte                             | DPT_Value_Temp   | 9.001          |       | W |   | -63..63 °C   |                                |
| ERROR CODE                            | Status_Unit error                | 1 bit                              | 1.005-DPT_Alarm  | 1.005          | R     |   | T | 0-No error, 1-Error                                    |                                |
|                                       | Status_Unit error code           | 2 byte                             | Non-standardized | 8.x            | R     |   | T | 0-No Error, X-Error (100..999)                         |                                |
| FILTER                                | Status_FilterSign                | 1 bit                              | DPT_Alarm        | 1.005          | R     |   | T | 0-Normal, 1-Alarm                                      |                                |
|                                       | Control_FilterReset              | 1 bit                              | DPT_Reset        | 1.015          |       | W |   | 0-No reset, 1-Reset                                    |                                |
| COMM STATUS                           | Status_Communication status      | 1 bit                              | DPT_Switch       | 1.001          | R     |   | T | 0-Not exist, 1-Exist                                   |                                |

|                     |                  |  |        |                    |       |   |   |   |   |
|---------------------|------------------|--|--------|--------------------|-------|---|---|---|---|
| INDOOR UNIT SIGNALS | REMOC.           | Control_On/Off Remote controll disablement   | 1 bit  | DPT_Bool           | 1.002 |   | W |   | 0-No disabled, 1-Disabled                     |
|                     |                  | Status_On/Off Remote controll disablement    | 1 bit  | DPT_Bool           | 1.002 | R |   | T | 0-No disabled, 1-Disabled                     |
|                     |                  | Control_Mode Remote controll disablement     | 1 bit  | DPT_Bool           | 1.002 |   | W |   | 0-No disabled, 1-Disabled                     |
|                     |                  | Status_Mode Remote controll disablement      | 1 bit  | DPT_Bool           | 1.002 | R |   | T | 0-No disabled, 1-Disabled                     |
|                     |                  | Control_Setpoint Remote controll disablement | 1 bit  | DPT_Bool           | 1.002 |   | W |   | 0-No disabled, 1-Disabled                     |
|                     |                  | Status_Setpoint Remote controll disablement  | 1 bit  | DPT_Bool           | 1.002 | R |   | T | 0-No disabled, 1-Disabled                     |
|                     |                  | Control_Fan Remote controll disablement      | 1 bit  | DPT_Bool           | 1.002 |   | W |   | 0-No disabled, 1-Disabled                     |
|                     |                  | Status_Fan Remote controll disablement       | 1 bit  | DPT_Bool           | 1.002 | R |   | T | 0-No disabled, 1-Disabled                     |
|                     | SYSTEM INFO      | Status_Unit type                             | 1 byte | DPT_Value_1_Ucount | 5.010 | R |   | T | 1-SS, 2-FC, 3-VRF, 4-IU, 5-ES, 13-Not Defined |
|                     |                  | Status_Unit adress                           | 1 byte | DPT_Value_1_Ucount | 5.010 | R |   | T | 1..64   |
|                     |                  | Status_System adress                         | 1 byte | DPT_Value_1_Ucount | 5.010 | R |   | T | 1..64   |
|                     | DEHUMIDIFICATION | Status_Dehumidification                      | 1 bit  | DPT_Switch         | 1.001 | R |   | T | 0-Off, 1-On                                   |
|                     |                  | Control_Dehumidification correction          | 1 byte | DPT_Value_1_Ucount | 5.010 |   | W |   | 0..2  |
|                     |                  | Status_Dehumidification correction           | 1 byte | DPT_Value_1_Ucount | 5.010 | R |   | T | 0..2  |
|                     | OTHERS           | Status_Compresor stop cause                  | 2 byte | Non-standarized    | 8.x   | R |   | T | X-Cause (0-254), 255-Operation Off            |
|                     |                  | Status_Expansion valve open                  | 1 byte | DPT_Scaling        | 5.001 | R |   | T | 0..100 %                                      |
|                     |                  | Status_Operation condition                   | 1 byte | Non-standarized    | 5.x   | R |   | T | 0-Off, 1-Thermo Off, 2-Thermo On, 3-Alarm     |
|                     |                  | Status_RC SW Temperature (°C)                | 2 byte | DPT_Value_Temp     | 9.001 | R |   | T | -63..63 °C                                    |
|                     |                  | Status_RC SW Configuration                   | 1 bit  | DPT_Switch         | 1.001 | R |   | T | 0-Without RCS, 1-With RCS                     |