



Product documentation

Presende detector Universal
Art. No. 3361-1WW

Presende detector Universal
Art. No. 3361-1AL



ALBRECHT JUNG GMBH & CO. KG
Volmestraße 1
58579 Schalksmühle
GERMANY

Telefon: +49 2355 806-0
Telefax: +49 2355 806-204
kundencenter@jung.de
www.jung.de

Issue: 31.07.2019
6270132x V3

Table of Contents

1	Product definition	4
1.1	Product catalogue	4
1.2	Function	4
1.3	Accessories	7
2	Mounting, electrical connection and operation	8
2.1	Safety instructions	8
2.2	Battery safety instructions	9
2.2.1	Disposal of batteries	9
2.3	Device components	10
2.4	Fitting and electrical connection	11
2.5	Commissioning	16
2.6	Operation	18
3	Technical data	24
4	Software description	25
4.1	Software specification	25
4.2	Software "Presence detector A0111x"	26
4.2.1	Scope of functions	26
4.2.2	Notes on software	28
4.2.3	Object table	29
4.2.3.1	Objects for the sensor	29
4.2.3.2	Objects for function blocks 1...5	30
4.2.3.3	Objects for the light control	40
4.2.3.4	Objects for the brightness limiting values	47
4.2.3.5	Object for IR remote control	51
4.2.3.6	Objects for the function block switch-over	52
4.2.4	Functional description	53
4.2.4.1	Global block diagram	53
4.2.4.2	Motion and light sensor	55
4.2.4.2.1	PIR sensor	55
4.2.4.2.2	Brightness sensor	57
4.2.4.2.3	Walking test and display of motion impulses	61
4.2.4.3	Function blocks 1-5 for motion detection	63
4.2.4.3.1	Applications	63
4.2.4.3.2	Application types	69
4.2.4.3.3	Operating mode	74
4.2.4.3.4	Output functions	76
4.2.4.3.5	Sensor assignment	77
4.2.4.3.6	Brightness evaluation	78
4.2.4.3.7	Manual operation	81
4.2.4.3.8	Application examples	83
4.2.4.3.9	Behaviour at the beginning of a detection	90
4.2.4.3.10	Behaviour at the end of a detection	95
4.2.4.3.11	Disabling function	100
4.2.4.3.12	Reset behaviour	102
4.2.4.4	Function block switch-over	105

4.2.4.5	Light control	107
4.2.4.5.1	Application basics	107
4.2.4.5.2	Operation of the light control	109
4.2.4.5.3	Brightness setpoint	111
4.2.4.5.4	Channel configuration	115
4.2.4.5.5	Control behaviour	119
4.2.4.5.6	Disabling function	128
4.2.4.5.7	Superimposed operation	130
4.2.4.5.8	Manual operation	131
4.2.4.5.9	Application examples	132
4.2.4.5.10	Behaviour after a device reset	134
4.2.4.6	Brightness limiting values	135
4.2.4.6.1	Limiting value definition	135
4.2.4.6.2	Limiting value presetting	137
4.2.4.6.3	Disabling function	139
4.2.4.7	IR remote control (accessory)	140
4.2.4.8	General reset behaviour	142
4.2.4.9	Delivery state	143
4.2.5	Parameters	144
5	Appendix	200
5.1	Index	200

1 Product definition

1.1 Product catalogue

Product name:	Presende detector Universal /
Use:	Physical sensor
Design:	FM (flush-mounted) Surface-mounted with surface-mounted housing (accessories)
Art. No.	3361-1WW / 3361-1AL

1.2 Function

Application

The presence detector Universal is installed on a ceiling and monitors an area below it. The device is used for the requirement-oriented control of lighting systems, room thermostats and other electrical consumers in interior rooms. Depending on the configuration, the device is operated for detecting motion (as a ceiling detector), evaluating presence (as a presence detector) and room surveillance (alert operation).

When used as a "ceiling detector", the device is normally installed in passageways of buildings for switching on the lighting automatically, as required. Lighting switched on by a ceiling detector is only switched off if there are no persons in the monitored area.

The application "presence detector" is normally used in areas where people spend longer periods of time (e.g. workplace as well as bathroom/toilet...) for controlling the lighting or heating/ventilation. The device can evaluate slightest motions in this application. Unlike the ceiling detector functionality, in brightness-dependent operation, the brightness is evaluated continuously if the lighting is switched on even during active motion detection. Thus, for example, lighting can be switched off when a defined brightness threshold is exceeded, e.g. by incoming daylight.

When being used in "alert operation", the device always works brightness-independently. Message telegrams signal whether or not people are present in the monitored area. Here, the number of motion impulses can be specified within a monitoring time whereby it is possible to adapt the motion evaluation to individual requirements. A motion is only identified, when the device has detected the set number of motion impulses. This application is appropriate when the device is to be used as a detector for KNX signalling systems.

Motion detection and brightness sensor

The device detects motions digitally via 3 PIR sectors with a total detection area of 360°, in which each PIR sector covers a subarea of 120°. The sensitivity of the motion detection, which is a gauge for the range of the PIR evaluation, can be configured separately in the ETS for the PIR sectors and can also be adjusted directly on the device using a potentiometer as well as with the IR remote control (accessories) after commissioning.

The device has a brightness sensor, which is guided laterally from the housing by a light guide on the lens surface of the device for determining workplace brightness or ambient brightness. The sensor detects the reflected mixed light composed of artificial light and daylight from the area or objects below the device via the light guide. A reflection coefficient programmed at the factory enables the device to determine the effective brightness of the workplace surface or floor surface. The reflection coefficient of the device can be adapted to other workplace or floor surfaces by using the calibration function if required.

The brightness value determined by the device can be made available to other bus subscribers via an object for the purpose of display or evaluation. In addition, the presence detector Universal has up to three mutually independent brightness limiting values that are continuously compared with the brightness value detected. If a limiting value configured in the ETS or predefined externally is exceeded or fallen below, the device can transmit switching, brightness value or scene recall telegrams to the bus and thus trigger appropriate reactions in other bus subscribers.

Function blocks

The presence detector Universal has 5 function blocks. Each function block can be regarded as a virtual device that operates independently and can be assigned individually to the PIR sectors numbering up to 3. Each function block is fully configurable to the application "ceiling detector", "presence detector" or "alert operation" so that different switching and control tasks affecting various areas of a room can be executed with just one device. Up to two output communication objects are available per function block, which transmit the switching and control commands to the bus. Depending on the configured function (switching, staircase function, dimming value transmitter, scene extension, temperature value transmitter, brightness value transmitter, operating mode switchover, switching with forced position), the data format of these objects is defined separately and adapted to the controllable function units of the KNX system.

The function block switch-over can be used if required. The function block switch-over makes it possible to toggle between two function block groups, in which assigned function blocks, for example, can be switched over depending on the time of day or depending on the state of the KNX system. This makes it possible to continuously change over during operation of the device and thus change its function (e.g. during the day presence detector for light control, during the night ceiling detector for service light / presence detector if present, detector for KNX signalling systems if absent).

Extensive parameters allow each function block to be adapted to a wide range of control tasks. Thus, in the ETS, for example, settings are possible for the twilight level (incl. external presetting and Teach), for time delays (evaluation delay at the beginning and transmission delay at the end of a detection) and for the sensor assignment (PIR and brightness sensor). A disabling function allows demand-oriented disabling of individual function blocks. In addition, manual operation of the controlled KNX actuator and thus, deactivation of the PIR automatic is possible any time.

In brightness-independent operation, a function block can - depending on the configured operating mode - determine the time period after a last motion and transmit it to the bus via a communication object. The transmission of the determined time takes place in the data format "minutes". This function, for example, allows simple monitoring of people's movements in assisted living or in a senior citizens' residence.

Operating mode

In the case of function blocks with the application "ceiling detector" or "presence detector", the operating mode can be configured in the ETS. The operating mode specifies the function of the motion detection and defines whether or not the beginning and the end of a motion detection is identified automatically. Thus, the operating mode can be configured to "Fully automatic" (Automatic ON, Automatic OFF), to "Semi-automatic I" (Manual ON, Automatic OFF) or "Semi-automatic II" (Automatic ON, Manual OFF). This makes it possible to adjust the motion detection to many applications in private and public areas (e.g. toilet lighting, service lighting, control of ventilation systems).

Application type

The presence detector Universal can be used in the applications "ceiling detector" or "presence detector" as single device, main unit or extension. It is possible to use several devices in a room to extend the detection area by combining a device configured as a main unit with several devices configured as an extension.

Light control

A complete and multi-functional light control can be implemented in the presence detector Universal. The light control makes it possible to keep the brightness level of an assigned lighting device constantly at a preset brightness setpoint even under changing external light influences (daylight and/or artificial light). The light control is activated and deactivated by means of presence information. This presence information can be transmitted from the internal function block 1 of the device or from another bus subscriber (e.g. another presence detector or motion detector) to the light control.

The light control makes it possible to control up to three separate dimming channels and allows extensive adjustment of the brightness setpoint even during ongoing operation of the device (setpoint shift, external presetting, Teach). Startup control phase, control phase and step down

control phase can be adjusted individually to the control requirement.

Walking test and status LED

The presence detector Universal has a walking test function. The walking test function serves as a guide during the project design and setting of the PIR detection area. The walking test indicates the reaction of the device when detecting motions by means of a blue status LED that is clearly visible behind the sensor window. The walking test can be active immediately after the ETS commissioning, or alternatively, can be activated or deactivated using the IR remote control (accessory) during ongoing operation of the device. Optionally, the status LED can signal any detected motions even during normal operation.

IR remote control

Certain settings for the device (only relating to function block 1) can also be made optionally with an IR remote control. This is recommended, for instance, if the user should carry out settings on the twilight level, sensitivity of the motion detection or on the run-on-time after commissioning using the ETS. With the remote control it is also possible to influence the motion evaluation manually and thus the switching on and off of the automatic mode and walking test function.

When a signal of the IR remote control is received, the status LED in the sensor window lights up briefly as acknowledgement of receipt. The IR remote control is obtainable as an optional accessory.

Installation

The device is supplied via the bus voltage. An additional power supply is not necessary. The device is intended for ceiling mounting on hard ceilings in appliance boxes or surface-mounted housings (accessory) in dry interior rooms.

1.3 Accessories

IR remote control
Surface-mounted housing, white
Surface-mounted housing, aluminium
Protection cage

Art. No. KNXPMFBIR
Art. No. PM-KAPPE-1
Art. No. PM-KAPPE AL-1
Art. No. SK 180-90 WW

2 Mounting, electrical connection and operation

2.1 Safety instructions

Electrical equipment may only be installed and fitted by electrically skilled persons.

Failure to observe the instructions may cause damage to the device and result in fire and other hazards.

Do not open device or operate it beyond the technical specification.

Do not press on the sensor window. Device can be damaged.

The device is not suitable for use as a burglar alarm or other alarm.

Caution. Damage to sensors may result due to high thermal radiation. Avoid direct sunlight penetration in the sensor window.

2.2 Battery safety instructions

This device or its accessories are supplied with batteries in the form of button cells.

DANGER! Batteries can be swallowed. This can lead directly to death by suffocation. Dangerous substances may cause severe internal burns leading to death within 2 hours. Keep new and used batteries away from children.

Do not use devices if the battery compartment does not close securely and keep away from children.

If you suspect that a battery has been swallowed or is in any orifice of the body, seek immediate medical attention.

WARNING! Improper handling of batteries can result in explosion, fire or chemical burn due to leakage.

Do not heat or throw batteries into fire.

Do not reverse polarity, short-circuit or recharge batteries.

Do not deform or disassemble batteries.

Replace batteries only with an identical or equivalent type.

Remove empty batteries immediately and dispose of in an environmentally friendly manner.

2.2.1 Disposal of batteries



Remove empty batteries immediately and dispose of in an environmentally friendly manner. Do not throw batteries into household waste. Consult your local authorities about environmentally friendly disposal. According to statutory provisions, the end consumer is obligated to return used batteries.

2.3 Device components

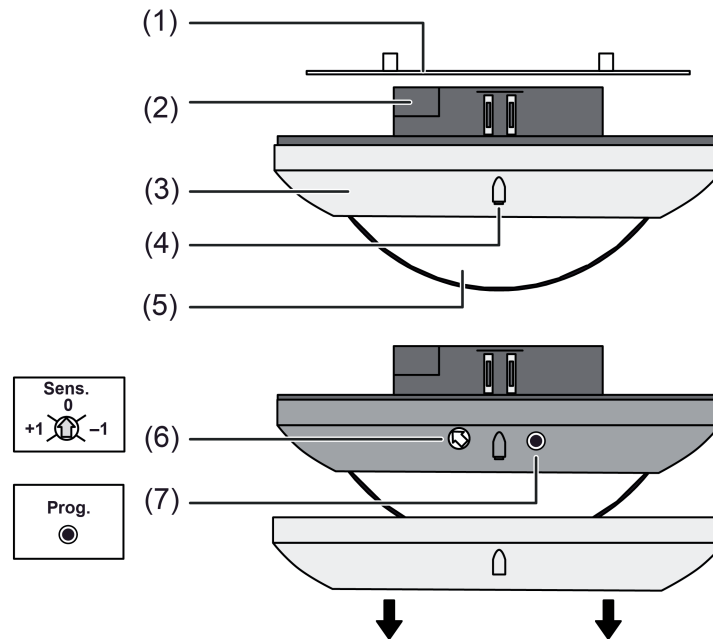

Figure 1: Device components

- (1) Supporting frame
- (2) Housing with integrated bus coupling unit
- (3) Decor ring
- (4) Light guide for brightness sensor
- (5) Sensor window with PIR sensor, programming LED (red) and status LED (blue)
- (6) Adjuster **Sens.** for manual sensitivity adjustment
- (7) Programming button

2.4 Fitting and electrical connection

Detection field and range

The device detects extremely sensitive motions via 3 digital PIR sectors with a total detection area of 360°, in which each PIR sector covers a subarea of 120°. The diameter of the detection area depends on the installation height and the direction of motions of persons in the detection area.

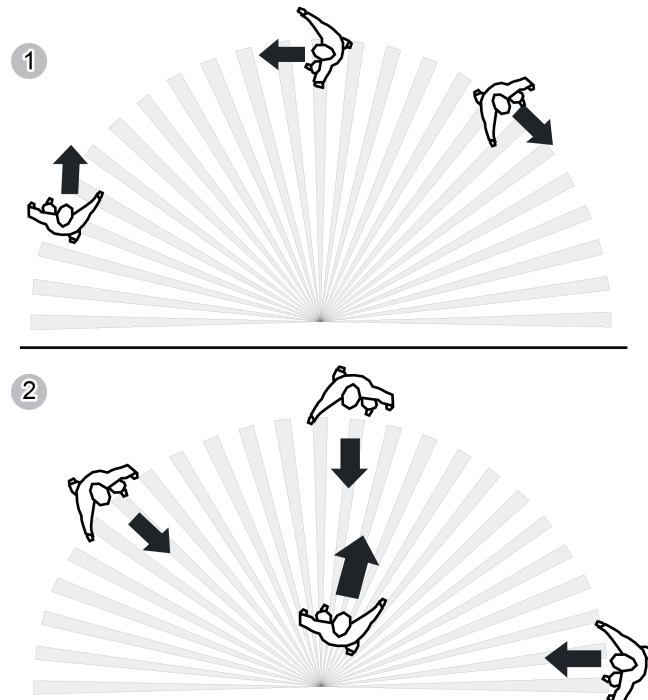

Figure 2: Tangential and radial direction of motion

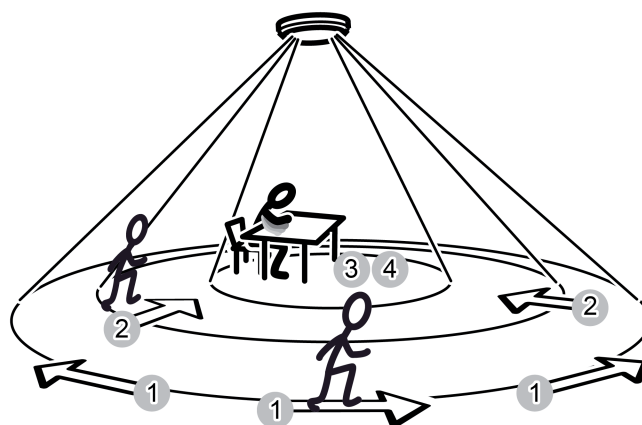

Figure 3: Detection range depending on the direction of movement

- 1: Range for tangential movement on the ground
- 2: Range for radial movement on the ground
- 3: Range for typical movements at desks, e.g. torso movement
- 4: Range of fine detection at desks, e.g. mouse movements

The detection area becomes larger the greater the installation height, while the detection density and sensitivity are reduced at the same time.

Installation height	1:	2:	3:	4:
2.20 m	14.5 m	11.5 m	8 m	6 m
2.50 m	16.5 m	13 m	10 m	7 m
3.00 m	20 m	16 m	12 m	8 m
3.50 m	23 m	18.5 m	14 m	9 m
4.00 m	26 m	17 m	14.5 m*	– *
5.00 m	28 m	18 m	15 m *	– *

Diameter of detection area for direction of movement

*: When used as a presence detector, installation height should not be more than 3.5 m, otherwise fine detection is not possible.

- i** The sensitivity of the motion detection can be configured separately in the ETS for the PIR sectors and can also be adjusted directly on the device using an adjuster as well as with the IR remote control (accessories) after commissioning. With application program of version 1.2, it is possible, in conjunction with devices from release version "V01" (printed on the device label), to influence the digital evaluation of all PIR sensors in terms of sensitivity. It is possible here to optionally reduce the basic sensitivity in order to reduce or even fully suppress undesirable motion detections in the long-distance range within extensive installation environments (large detection radius). An exact function description of the sensitivity setting can be referred to in the chapter Software Description (see page 55-56).

Selecting installation location

When used as a presence detector, the device is installed ideally on the ceiling above a workplace. The device then monitors the surface below it. When used as a ceiling detector, the device is installed e.g. in passageways on the ceiling.

- Select a vibration-free installation location. Vibrations can lead to unwanted switching operations.
- Avoid interference sources in the detection area. Interference sources, e.g. heaters, ventilation, air conditioners, and cooling light bulbs can lead to unwanted detections.
- i** If necessary, the detection field can be limited using the push-on cover in order to minimize the influence of interference sources (see page 13).
- i** To avoid unfavourably influencing the brightness measurement, care must already be taken when mounting the device to ensure that no direct light (sunlight, artificial light) falls onto the light conductor rod. Strong reflections can also influence the brightness measurement if they fall directly onto the light conductor rod.

Limiting the detection area

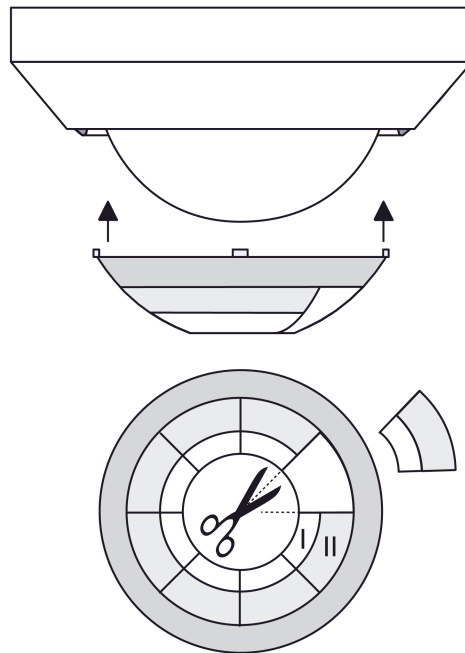

Figure 4: Limiting the detection area by means of push-on cover

The push-on cover can be used to limit the detection field, e.g. in order to mask out interference sources.

Cover size	Range on the ground (height 3 m)
Complete push-on cover	Ø approx. 4.5 m
Area I cut out	Ø approx. 7.5 m
Areas I + II cut out	Ø approx. 12 m
without push-on cover	Ø approx. 20 m

Detection range on the floor depending on the cover size

- Pull off push-on cover.
- Using scissors or a suitable knife, carefully cut out push-on cover along the marked lines as required.
- Push on push-on cover.

Aligning the device

The device has three independent sensors for motion detection. The arrangement of the resulting PIR sectors A, B and C is clearly evident under the decor ring (figure 6).

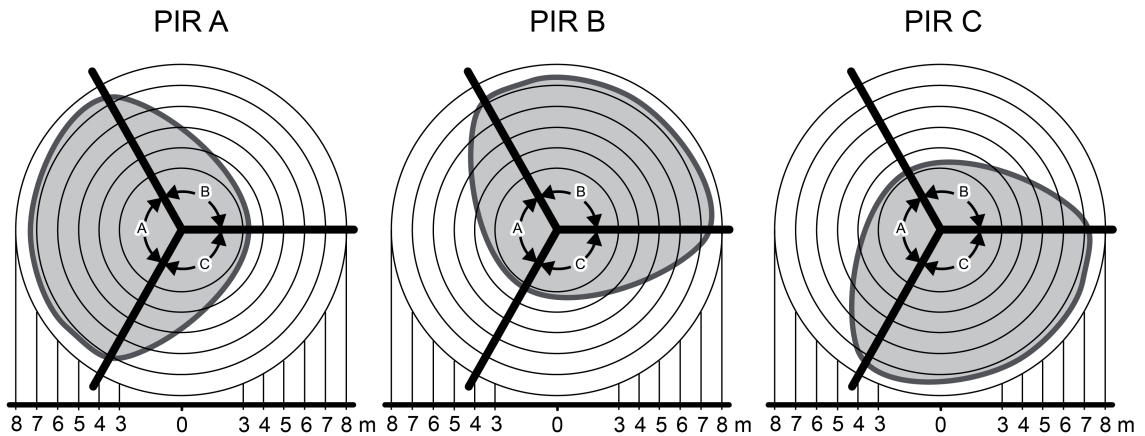

Figure 5: Detection field with PIR sectors A, B and C at an installation height of 2.50 m

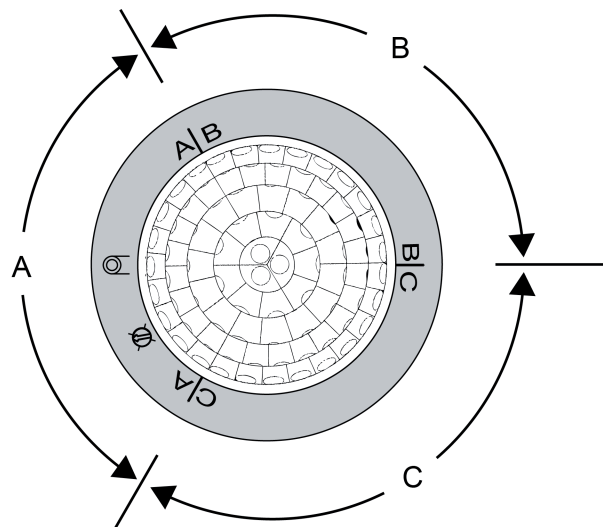

Figure 6: Arrangement of the PIR sectors A, B and C

- When mounting the device, align it so that the alignment of the PIR sectors A, B and C match the project design.
- ❗ Already pay attention to correct alignment when mounting the appliance box and supporting frame.
- ❗ To avoid unfavourably influencing the brightness measurement, care must already be taken when mounting the device to ensure that no direct light (sunlight, artificial light) falls onto the light conductor rod. Strong reflections can also influence the brightness measurement if they fall directly onto the light conductor rod.

Connecting and fitting the device in a flush-mounted box

A flush-mounted appliance box must be mounted on the ceiling at the designated installation location.

- ❗ In suspended ceilings, we recommend using air-tight, cavity wall appliance boxes.
 - Pull off decor ring (3).

- When mounting the supporting frame (1), make sure that the PIR sectors A, B and C are aligned correctly.
- Run the bus cable through the supporting frame.
- Use connecting KNX device connection terminal to connect bus line to the bus connection on the rear side of the device.
- Press the device into the supporting frame correctly aligned until it locks in place.
- Attach decor ring (3).

Connecting and fitting device in a surface-mounted housing

Using a surface-mounted housing (see accessories).

- Pull off decor ring (3).
- Guide the bus cable through the eyelet of the surface-mounted housing provided.
- Make sure that the PIR sectors A, B and C are aligned correctly when mounting the surface-mounted housing on the ceiling.
- Use connecting KNX device connection terminal to connect bus line to the bus connection on the rear side of the device.
- Mount the device correctly in the housing and screw down tightly.
- Attach decor ring (3).

2.5 Commissioning

Programming the physical address and application program

Project design and commissioning of the device using the ETS3.0d with Patch A or newer versions.

The device must have been connected and ready for use.

An appropriate device must be created and configured in the ETS project.

- Switch on the bus voltage.
- Press the programming button (7).
The red programming LED in the sensor window (5) lights up. The device displays the programming status in this way.
- Program the physical address with the help of the ETS.
The programming LED goes out.
- Write the physical address on the device label.
- Load the application program into the device using the ETS.

Testing the detection area

The device must be mounted and connected and the physical address and application program must be loaded.

- i** In the case of main unit and extension arrangements, check the detection areas of the devices individually one after the other.

The detection area can be checked with the help of the walking test. The walking test can be activated in 2 ways...

1. Activating walking test by means of ETS configuration...

- Set the parameter "Walking test after ETS programming" to "activated". Afterwards, load the application program into the device with the aid of the ETS.
After programming, the walking test is activated immediately. The device then works independently of the brightness and signals detected motions via the blue status LED. All PIR sectors are active according to their preset sensitivity.
- Pace off the detection area, paying attention to reliable detection and interference sources.
- Limit detection area if necessary using the push-on cover. Adjust sensitivity with adjuster or IR remote control, or change the ETS parameter setting.
- After a successful test, set the parameter "Walking test after ETS programming" to "deactivated". Afterwards, reload the application program into the device with the aid of the ETS.

The walking test is deactivated. The device works according to the configuration.

- i** Optionally, a walking test activated by the ETS configuration can be deactivated using the IR remote control (if enabled in the ETS).

2. Activating walking test with the IR remote control (accessory) ...

- Press the **Test** button on the IR remote control.
The device signals that the IR command has been correctly received by briefly flashing the blue status LED. Afterwards, the device works independently of the brightness and signals detected motions via the status LED. All PIR sectors are active according to their preset sensitivity.
- Pace off the detection area, paying attention to reliable detection and interference sources.

- Limit detection area if necessary using the push-on cover. Adjust sensitivity with adjuster or IR remote control, or change the ETS parameter setting (new programming necessary).
 - After a successful test, press the **Test** button again on the IR remote control.
The walking test is deactivated. The device works according to the configuration.
- i** It is only possible to activate and deactivate the walking test using the IR remote control in devices that have been commissioned if the remote control has been enabled in the ETS. In the as-delivered state of the devices, the IR remote control is enabled so that the walking test function can be carried out.

2.6 Operation

Operating elements on the device

After removing the decor ring (3) from the presence detector housing, the local operating elements can be accessed (figure 7).

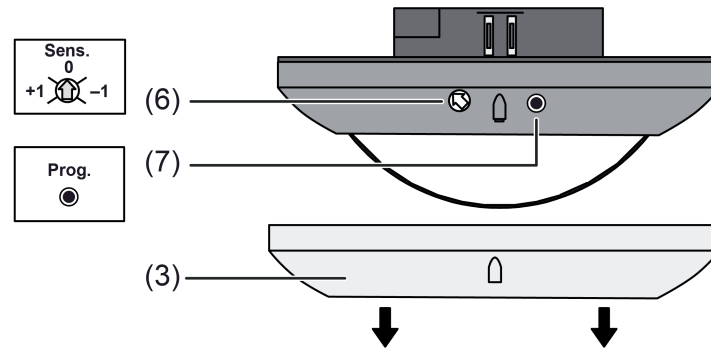

Figure 7: Operating elements on the device

- (3) Decor ring
- (6) Adjuster **Sens.** for manual sensitivity adjustment
- (7) Programming button

The sensitivity of the motion detection, which is a gauge for the range of the PIR evaluation, can be configured separately in the ETS for the PIR sectors A, B and C and can also be adjusted directly on the device after commissioning. For this purpose, the device has the adjuster (6) that makes it possible to change the configured sensitivity setting of all PIR sectors. The sensitivity can thereby be reduced or increased by a maximum of one level. The adjustment range divided into three sections (figure 8).

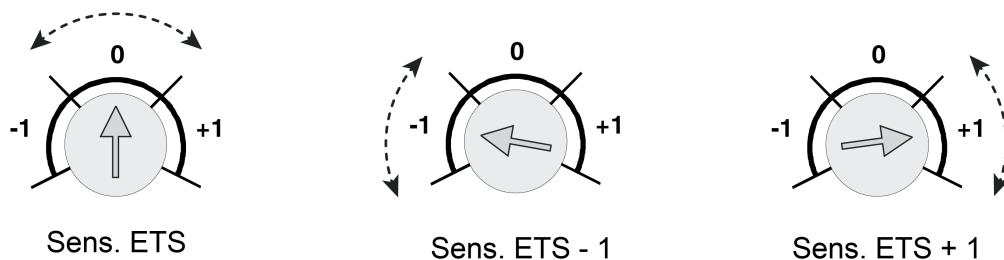

Figure 8: Adjustment ranges of the sensitivity adjuster on the device (-1 <-> 0 <-> +1)

The adjuster can be rotated continuously up to the limit stops. A small flat head screwdriver must be used for this purpose.

It is only possible to adjust the configured sensitivity setting on the device within a range of 25 % to 100 % using the adjuster. If the sensitivity of a PIR sector in the ETS has already been adjusted to a limiting value (25 % or 100 %), this setting can no longer be adjusted beyond the limiting values. A PIR sector that has been deactivated in the ETS cannot be activated by increasing the sensitivity using the adjuster. Likewise, a deactivation (25 % -> 0 %) using the adjuster is not possible.

The sensitivity adjustment of the PIR sectors is applied immediately when the position of the adjuster is changed to another area.

i The adjuster can be deactivated in the ETS. In this case, an adjustment has no effect.

- i** The set sensitivity on the device can be changed at any time by new ETS programming or via the IR remote control. In the course of this, the device no longer takes the position of the adjuster into account until a new adjustment is made. As a result, the position of the adjuster gives no indication of the actual effective sensitivity. When presetting the sensitivity, the last action carried out (ETS programming, adjuster on the device or IR remote control) is always relevant.

IR remote control (accessory)

Certain settings for the device can also be carried out optionally with an IR remote control. This is recommended, for instance, if the user should carry out settings on the twilight level, sensitivity of the motion detection or on the run-on-time after commissioning using the ETS. With the remote control it is also possible to influence the motion evaluation manually and thus the switching on and off of the automatic mode and walking test function. The IR remote control can only be used if the ETS configuration of a device provides for this.

- i** The IR remote control only influences the function block 1! Other function blocks - if in use - cannot be influenced by the IR remote control.
- i** When the device successfully receives commands of the IR remote control, it confirms this by briefly flashing the blue status LED.

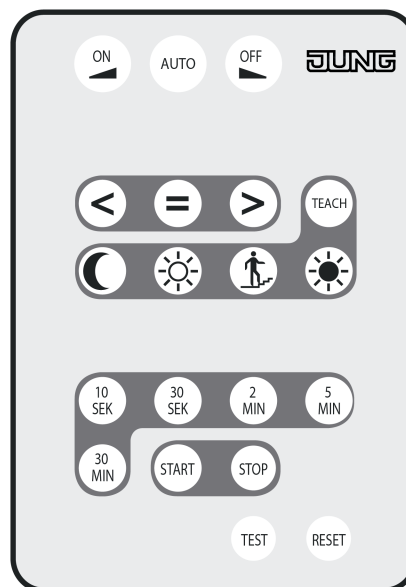













Figure 9: Buttons on the IR remote control

The functions of the individual buttons are explained below. First of all, the buttons for the user-guided operation of the detection state (operating mode) of the first function block...

- **ON**  - switch on user-guided
By pressing this button, the automatic operation is finished and function block 1 locked. Appropriate telegrams are sent to the bus depending on the function involved. The function is dependent on the application....
Ceiling detector/presence detector: At the beginning of the detection, the configured telegrams are sent via the outputs and the device is switched over to brightness-independent operation.
Presence detector with light control: If no presence detection is active (control status OFF or step down control phase active), the behaviour of the startup control phase is first executed and then changed to the control phase. A brightness of 0 Lux is taken as a basis so that the controller controls at max. brightness. During an active presence detection (control phase active), the max. brightness is controlled by specifying a brightness value of 0 Lux without executing the startup control behaviour.
 - **AUTO** - Activate automatic operation
If this button is pressed, the interlock is cancelled and the automatic operation activated without sending a telegram to the bus. The device then waits for motions.
Note: If the status ON was active previously, the telegrams at the end of the detection are only transmitted after a new motion detection has been terminated. If no motion is subsequently detected after activation of the automatic operation, the actuator status of the operating mode ON (e.g. lighting = ON) is preserved until a new motion is detected.
 - **OFF**  - switch off user-guided
By pressing this button, the automatic operation is finished and function block 1 locked. Appropriate telegrams are sent to the bus depending on the function involved. The function is dependent on the application....
Ceiling detector/presence detector: At the end of the detection, the configured telegrams are sent via the outputs and the device is switched over to brightness-dependent operation if the twilight level evaluation is configured to brightness-dependent.
Presence detector with light control: If a presence detection is active, the behaviour of the step down control phase (transmission of the telegrams) including a configured switch-off time is executed. Depending on the configuration, the brightness might also only be dimmed down to minimum brightness.
- i** The **ON** , **AUTO** or **OFF**  buttons are influenced by the ETS-parameter "operating mode presetting". Depending on the parameter setting, the buttons can be deactivated individually.
 - i** The presettings of the detection status by the **ON**  or **OFF**  buttons are lost if the disabling function of function block 1 is activated or if the function block 1 is deactivated by the function block switch-over. After re-enabling or activating using the function block, the function block 1 is always in the operating mode **AUTO**.
 - i** After bus voltage return, the active operating mode is dependent on the parameter "Behaviour on bus voltage return" of the function block 1. In configuration "state as before bus voltage failure", the operating mode that existed before bus voltage failure is adopted. In all other configurations, the operating mode **AUTO** is always active after bus voltage return.
 - i** The presettings of the detection status by the **ON**  or **OFF**  buttons are preserved during activation of the disabling function of the IR remote control.
 - i** When presetting the detection status using the **ON**  or **OFF**  buttons, the buttons for the twilight level setting, sensitivity setting and for presetting the additional transmission delay continues to be evaluated. The presetting of the detection status is preserved. The only buttons not evaluated anymore by the device are those for the learning function of the additional transmission delay (**START** / **STOP**).
 - i** If the walking test is activated, the manual presetting of the detection status remains unchanged, at first. If the walking test is deactivated, the function block 1 always adopts the operating mode **AUTO**.

- i** If the manual setting of the additional transmission delay by the IR remote control is active (time measurement running), this is cancelled and discarded when presetting a manual detection status using the **ON**  or **OFF**  buttons.
- i** A manual presetting of the detection status remains unchanged if the **RESET** button is pressed.

Functions of the buttons for setting the sensitivity of all PIR sectors...



- **<** - Decrease the sensitivity
The sensitivity of all PIR sectors is individually decreased by a max. of one level by pressing this button. The sensitivity value configured in the ETS is always decreased.
- **=** - Reset the sensitivity
The sensitivity settings of all PIR sectors are reset to the sensitivity value configured in the ETS by pressing this button.
- **>** - Increase the sensitivity
The sensitivity of all PIR sectors is individually increased by a max. of one level by pressing this button. The sensitivity value configured in the ETS is always increased.
- i** It is only possible to adjust the configured sensitivity setting within a range of 25 % to 100 % using the IR remote control. If the sensitivity of a PIR sector in the ETS has already been adjusted to a limiting value (25 % or 100 %), this setting can no longer be adjusted beyond the limiting values. A PIR sector that has been deactivated in the ETS cannot be activated by increasing the sensitivity using the IR remote control. Likewise, a deactivation (25 % -> 0 %) using the IR remote control is not possible.
- i** The sensitivity predefined by the IR remote control can be changed on the device at any time by a new ETS programming operation using the sensitivity adjuster. When presetting the sensitivity, the last action carried out (ETS programming, adjuster on the device or IR remote control) is always relevant.

Functions of the buttons for setting the twilight level...

- **☾** - Twilight level night operation (10 Lux)
The twilight level is set to 10 Lux by pressing this button.
- **☼** - Twilight level reduced brightness (50 Lux)
The twilight level is set to 50 Lux by pressing this button.
- **⤴** - Twilight level for regular staircase lighting (150 Lux)
The twilight level is set to 150 Lux by pressing this button.
- **☀** - Twilight level for day operation (brightness-dependent)
The twilight level is set to brightness-dependent by pressing this button.
- **TEACH** - Teach function for twilight level
The currently measured brightness value is saved as twilight level by pressing this button.
- i** The buttons of the IR remote control for the twilight level setting are only active if the evaluation of the twilight level for the function block 1 is configured to "brightness-dependent" in the ETS.
- i** All settings for the twilight level are treated equally. A predefined twilight level value remains unchanged until a new presetting (twilight level value received via bus, bus-controlled teach function or presetting via the IR remote control). Even a bus voltage failure will not reset the new predefined twilight level value.

- i** The Teach function triggered by the **TEACH** button of the IR remote control does not correspond to the bus-controlled Teach function. Two separate functions are involved here, which can preset a twilight level independently of each other. The last executed function defines the active twilight level value.

Functions of the buttons for setting the additional transmission delay...

- **10 SEC** - additional transmission delay 10 seconds
The additional transmission delay is set to 10 seconds by pressing this button (total transmission delay = 20 seconds).
- **30 SEC** - additional transmission delay 30 seconds
The additional transmission delay is set to 30 seconds by pressing this button (total transmission delay = 40 seconds).
- **2 MIN** - additional transmission delay 2 minutes
The additional transmission delay is set to 2 minutes by pressing this button (total transmission delay = 2 minutes, 10 seconds).
- **5 MIN** - additional transmission delay 5 minutes
The additional transmission delay is set to 5 minutes by pressing this button (total transmission delay = 5 minutes, 10 seconds).
- **30 MIN** - additional transmission delay 30 minutes
The additional transmission delay is set to 30 minutes by pressing this button (total transmission delay = 30 minutes, 10 seconds).
- **START** - Start the learning function for the additional transmission delay
The time measurement of the learning function for the additional transmission delay is started by pressing this button.
Ceiling detector/presence detector: At the beginning of the detection, the configured telegrams are transmitted via the outputs 1 and 2. The function of the function block 1 is disabled.
Presence detector with light control: The behaviour of the startup control phase (transmission of the telegrams) is executed. A brightness evaluation does not take place. A brightness of 0 Lux is taken as a basis. All other functions of the function block 1 and light control are disabled.
- **STOP** - Stops the learning function for the additional transmission delay
After the desired time for the additional transmission delay has elapsed, the **STOP** button must be pressed. The time determined is then accepted by the device as the new additional transmission delay.
Ceiling detector/presence detector: At the end of the detection, the configured telegrams are transmitted via the outputs 1 and 2 by pressing the **STOP** button. The function of the function block 1 is enabled.
Presence detector with light control: The behaviour of the step down control phase (transmission of the telegrams) including a configured switch-off time is executed by pressing the **STOP** button. The function of the function block 1 is enabled.
- i** All settings of the additional transmission delay made using the IR remote control can only be overwritten by the IR remote control itself, the communication object "Factor additional transmission delay" or by ETS programming (acceptance of the configuration). A bus voltage failure does not affect the value set via IR remote control for the additional transmission delay.
- i** The time measurement is limited to 255 hours. Once this time elapses without pressing the **STOP** button, the time measurement is cancelled and the determined time discarded.
- i** The time measurement will be cancelled when one of the following events occurs...
 - Pressing a button with predefined times for the transmission delay,
 - Activating the disabling function of the first function block,
 - Deactivating the first function block by the function block switch-over,
 - Activating the walking test function by the IR remote control,
 - Activation of the disabling function of the IR remote control,
 - When pressing the **ON**  or **OFF**  buttons.
 If the time measurement is cancelled, the value of the additional transmission delay set previously will be preserved.

- i** If a telegram is received via the object "Factor additional transmission delay" during an active time measurement, the received object value will not be accepted! If the **STOP** button is pressed, the value of the time measurement will be set as the new additional transmission delay.
- i** A twilight level setting using the IR remote control is also executed during an active time measurement.

Function of the button for the walking test...

- **TEST** - Activate / deactivate walking test
The walking test function of the device can be activated and deactivated by pressing this button. After activation of the walking test function, only the buttons for the sensitivity setting of the PIR sectors (< / = / >) and **TEST** button for deactivation of the walking test function will still be active on the IR remote control.
- i** The **TEST** button can be deactivated in the ETS.

Function of the reset button...

- **RESET** - Reset the settings of the IR remote control
The settings for the sensitivity of the PIR sectors, additional transmission delays and twilight level are reset to the ETS parameter values by pressing this button. The reset function is only triggered if the **RESET** button is pressed for at least 3 seconds. Even the visual acknowledgement by the blue status LED in the sensor window only takes place after this time period.

Disabling function of the IR remote control

All buttons of the IR remote control can be disabled via the bus using the disabling function. The disabling function is activated and deactivated via the communication object "Disable IR input" in which the telegram polarity is configurable. During an active disable, no settings can be made via the IR remote control.

The state of the disabling function after bus voltage return can be configured in the ETS. The following settings are possible...

- "deactivated": After bus voltage return, the IR remote control is ready for operation immediately.
- "activated": After bus voltage return, the IR remote control is completely disabled.
- "State as before bus voltage failure": In case of bus voltage failure, the current state of the disabling function is saved. After bus voltage return, the device tracks the saved disabling state (active or inactive).

The state of the disabling function after ETS programming can also be configured in the ETS. The following settings are possible here...

- "deactivated": After ETS programming, the IR remote control is ready for operation immediately.
- "activated": After ETS programming, the IR remote control is completely disabled.

3 Technical data

General

Protection class	III
Test mark	KNX/EIB
Ambient temperature	-5 ... +45 °C
Storage/transport temperature	-25 ... +70 °C
Relative humidity	5 ... 93 % (No moisture condensation)

KNX supply

KNX medium	TP
Commissioning mode	S-mode
Rated voltage KNX	DC 21 ... 32 V SELV
Current consumption KNX	max. 12.5 mA
Connection, Bus	device connection terminal

Motion detection

Detection angle	360 °
Range	approx. 16 m

Brightness sensor

Measuring range	0 ... 2000 lx
Detection area	Ø 2 m

IR remote control

Battery type	1×lithium CR 2025
--------------	-------------------

4 Software description

4.1 Software specification

ETS search paths:	Phys. sensors / Movement detector / Presende detector Universal /
Configuration:	S-mode standard
AST type:	"00" _{Hex} / "0" _{Dec}
PEI connector:	no connector

Applications for presence detector Universal:

No.	Short description	Name	Version	from mask version
1	Multifunctional presence detector application: Up to 5 function blocks for motion evaluations, light control, brightness limiting values and IR remote control	Presence detector Universal A01111	1.1 for ETS3.0 Version d onwards, ETS4 and ETS5	705
2	Multifunctional presence detector application: Up to 5 function blocks for motion evaluations, light control, brightness limiting values and IR remote control. With adjustable PIR basic sensitivity. This application replaces the application with version 1.1.	Presence detector Universal A01112	1.2 for ETS3.0 Version d onwards, ETS4 and ETS5	705

4.2 Software "Presence detector A0111x"

4.2.1 Scope of functions

- Depending on the configuration, the device is operated for detecting motion (as a ceiling detector), evaluating presence (as a presence detector) and room surveillance (alert operation).
- Evaluation of the smallest motions in presence detection operation.
- Continuous evaluation of the brightness during active motion detection in presence detection operation. As a result, lighting can be switched off when a defined brightness threshold is exceeded e.g. by incoming daylight.
- Configurable number of motion impulses within a monitoring time in alert operation. A motion is only identified, when the device has detected the set number of motion impulses. This application is appropriate when the device is to be used as a detector for KNX signalling systems.
- The motion detection takes place digitally via 3 PIR sectors with a total detection area of 360°. Each PIR sector covers a subarea of 120° ab.
- Sensitivity of the motion detection can be configured separately for the three PIR sectors in levels. User-guided adjustment of the sensitivity using an adjuster directly on the device or by means of the IR remote control (accessory).
With application program of version 1.2: Optional reduction of basic sensitivity for reducing unwanted motion detections in extensive installation environments (large detection radius).
- Brightness sensor for determining the workplace brightness or ambient brightness. Determination of the effective brightness of the workplace or floor surface by means of a reflection coefficient programmed at the factory. Adjustment of the reflection coefficient to other workplace or floor surfaces by calibration function if required.
- Evaluation of the measured brightness by up to three mutually independent brightness limiting values. If a limiting value configured in the ETS or predefined externally is exceeded or fallen below, the device can transmit switching, brightness value or scene recall telegrams to the bus.
- Up to 5 function blocks that work independently are available and up to 3 PIR sectors can be assigned individually. Each function block is fully configurable to the application "ceiling detector", "presence detector" or "alert operation" so that different switching and control tasks affecting various areas of a room can be executed with just one device.
- Up to two output communication objects are available per function block, which transmit the switching and control commands to the bus. Depending on the configured function (switching, staircase function, dimming value transmitter, scene extension, temperature value transmitter, brightness value transmitter, operating mode switchover, switching with forced position), the data format of these objects is defined separately and adapted to the controllable function units of the KNX system.
- Function block switch-over to the bus-controlled toggle between two function block groups in which assigned function blocks, for example, can be switched over depending on the time of day or depending on the state of the KNX system. This makes it possible to continuously change over during operation of the device and thus change its function (e.g. during the day presence detector for light control, during the night ceiling detector for service light / presence detector if present, detector for KNX signalling systems if absent).
- Adaptation of a function block to a wide range of control tasks by means of extensive parameters. Thus, in the ETS, for example, settings are possible for the twilight level (incl. external presetting and Teach), for time delays (evaluation delay at the beginning and transmission delay at the end of a detection) and for the sensor assignment (PIR and brightness sensor).
- Demand-oriented disabling of individual function blocks.
- Manual operation of the controlled KNX actuator and thus deactivation of the PIR automatic is possible.
- A function block in brightness-independent operation can determine the time period after a last motion and transmit to the bus via a communication object. This function, for example, allows simple monitoring of people's movements in assisted living or in a senior citizens' residence.

- Operating mode can be set for function blocks of the application "ceiling detector" or "presence detector". The operating mode specifies the function of the motion detection and defines whether the start or the end of a motion detection is identified automatically. Thus, the operating mode can be configured to "Fully automatic" (Automatic ON, Automatic OFF), to "Semi-automatic I" (Manual ON, Automatic OFF) or "Semi-automatic II" (Automatic ON, Manual OFF).
- The device can be used as single device, main unit or extension in the applications "ceiling detector" or "presence detector". It is possible to use several devices in a room to extend the detection area by combining a device configured as a main unit with several devices configured as an extension.
- A complete and multi-functional light control can be implemented in the device. The light control makes it possible to keep the brightness level of an assigned lighting device constantly at a preset brightness setpoint even under changing external light influences (daylight and/or artificial light). Activation and deactivation of the light control by means of presence information. This presence information can be transmitted from the internal function block 1 of the device or from another bus subscriber (e.g. another presence detector or motion detector) to the light control.
- The light control makes it possible to control up to three separate dimming channels and allows extensive adjustment of the brightness setpoint even during ongoing operation of the device (setpoint shift, external presetting, Teach). Startup control phase, control phase and step down control phase can be adjusted individually to the control requirement.
- Walking test function serves as a guide during the project design and setting of the detection area. The walking test indicates the reaction of the device when detecting motions by means of a blue status LED that is clearly visible behind the sensor window. Optionally, the status LED can signal any detected motions even during normal operation.
- IR remote control (accessory) for setting functions of the first function block (twilight level, sensitivity of the motion detection, motion evaluation and run-on-time). With the remote control it is also possible to influence the switching on and off of the walking test function. The IR remote control is obtainable as an optional accessory.

4.2.2 Notes on software

Application programs

Two application programs are available for the device. With application program of version 1.2, it is possible, in conjunction with devices from release version "V01" (printed on the device label), to influence the digital evaluation of all PIR sensors in terms of sensitivity. It is possible here to optionally reduce the basic sensitivity in order to reduce or even fully suppress undesirable motion detections in the long-distance range within extensive installation environments (large detection radius).

The application program of version 1.2 can also be programmed in older devices (no release version "V01" or higher). In this case, the parameter for basic sensitivity will not be evaluated. With the application program of version 1.1, it is generally not possible to configure the basic sensitivity even if this application program is programmed in devices from release version "V01". In the cases last mentioned above, the devices always work with high basic sensitivity.

ETS project design and commissioning

For project design and commissioning of the device, ETS3.0d or more recent ETS version is required. We recommend using ETS4 from version 4.1.8 or ETS5. No product database is available for ETS2 and older versions of ETS3.

Unloading the application program and non-executable application

After the application program has been unloaded by the ETS, the blue status flashes slowly (approx. 0.75 Hz). In this case, the device does not react anymore to motions, bus telegrams or commands of the IR remote control. The delivery state (see page 143) described cannot be restored by unloading with the ETS.

The device also indicates by slow flashing of the status LED that a wrong application has been programmed into its memory using the ETS. Applications are non-executable even if they are intended for use in the ETS product database but must not be combined with the selected device hardware. In this case, too, the device is without function.

It should generally be ensured that the device hardware used matches the ETS configured device.

4.2.3 Object table

Number of communication objects: 114
 (max. object number 124 - gaps in between)

Number of addresses (max): 254

Number of assignments (max): 255

4.2.3.1 Objects for the sensor

Function:	Motion detection				
Object	Function	Name	Type	DPT	Flag
 ⁰	Interlock PIR sensor	Motion detection - Input	1-bit	1.001	C, W, -, -
Description	1-bit object with which the PIR sensor can be locked after an active motion detection operation (lighting OFF) so that the device does not identify any motion due to the cooling light bulb. The telegram polarity and lockout time are configurable. An ongoing lockout time is restarted upon receiving a new telegram for the lockout.				

Function:	Brightness sensor				
Object	Function	Name	Type	DPT	Flag
 ¹	Measured brightness value	Brightness sensor - Output	2 bytes	9.004	C, -, T, R
Description	2-byte object that can transmit the brightness value of the room determined by the internal brightness sensor of the device to the bus. The device can transmit the brightness value actively and/or cyclically for a configured brightness change. It is also possible to only provide the brightness value passively and to transmit this on request (parameter-dependent).				

Function:	Brightness sensor				
Object	Function	Name	Type	DPT	Flag
 ²	Sensor calibration	Brightness sensor - Input	2 bytes	9.004	C, W, -, -
Description	2-byte object that can supply an external brightness reference value to the device during the sensor calibration. During calibration, the device assigns the measured value specified via this object to the current, measured brightness value (brightness on the light guide) whereby the measured value curve is adapted in the device.				

4.2.3.2 Objects for function blocks 1...5

Objects for output functions

Function:	Function block				
Object	Function	Name	Type	DPT	Flag
 3, 18, 33, 48, 63	Switching	FBx - Output 1 (x = 1...5)	1-bit	1.xxx	C, -, T, -
Description	1-bit object via which the first output of a function block outputs the switching commands to the KNX actuator (e.g. switch actuator) at the start or end of a detection. The telegram polarity can be configured. This object is only visible if the function of the output is configured to "switching".				

Function:	Function block				
Object	Function	Name	Type	DPT	Flag
 3, 18, 33, 48, 63	Switching staircase	FBx - Output 1 (x = 1...5)	1-bit	1.010	C, -, T, -
Description	1-bit object via which the first output of a function block outputs the switching commands to the KNX actuator (e.g. switch actuator) at the start or end of a detection. The run-on-time elapses in the actuator. The telegram polarity is thus defined ("1" at the beginning of a detection, "0" at the end of a detection). This object is only visible if the function of the output is configured to "Staircase function".				

Function:	Function block				
Object	Function	Name	Type	DPT	Flag
 3, 18, 33, 48, 63	Forced position	FBx - Output 1 (x = 1...5)	2-bit	2.001	C, -, T, -
Description	2-bit object via which the first output of a function block outputs the priority control commands with high priority to the KNX actuator (e.g. switch actuator) at the start or end of a detection. The telegram polarity can be configured. This object is only visible if the function of the output is configured to "switching with priority control".				

Function:	Function block				
Object	Function	Name	Type	DPT	Flag
 3, 18, 33, 48, 63	Dimming value	FBx - Output 1 (x = 1...5)	1 bytes	5.001	C, -, T, -
Description	1-byte object via which the first output of a function block outputs the dimming commands to the KNX actuator (e.g. dimming actuator) at the start or end of a detection. The dimming values are configurable. This object is only visible if the function of the output is configured to "dimming value transmitter".				

Function: Function block

Object	Function	Name	Type	DPT	Flag
 3, 18, 33, 48, 63	Scene extension	FBx - Output 1 (x = 1...5)	1 bytes	18.001	C, -, T, -

Description 1-byte object via which the first output of a function block outputs a scene number to the KNX actuator (e.g. dimming actuator) at the start or end of a detection for the purpose of a scene recall. The scene number can be configured.
This object is only visible if the function of the output is configured to "light scene extension".

Function: Function block

Object	Function	Name	Type	DPT	Flag
 3, 18, 33, 48, 63	Temperature value	FBx - Output 1 (x = 1...5)	2 bytes	9.001	C, -, T, -

Description 2-byte object via which the first output of a function block outputs preconfigured temperature values to a KNX actuator or sensor (e.g. room temperature controller) at the start or end of a detection. The temperature values can be configured.
This object is only visible if the function of the output is configured to "temperature value transmitter".

Function: Function block

Object	Function	Name	Type	DPT	Flag
 3, 18, 33, 48, 63	Brightness value	FBx - Output 1 (x = 1...5)	2 bytes	9.004	C, -, T, -

Description 2-byte object via which the first output of a function block outputs preconfigured brightness values to a KNX actuator or sensor (e.g. external constant light controller) at the start or end of a detection. The brightness values can be configured.
This object is only visible if the function of the output is configured to "brightness value transmitter".

Function: Function block

Object	Function	Name	Type	DPT	Flag
 3, 18, 33, 48, 63	Operating mode	FBx - Output 1 (x = 1...5)	1 bytes	20.102	C, -, T, -

Description 1-byte object via which the first output of a function block outputs a command for the operating mode switchover to the KNX actuator or sensor (e.g. room temperature controller) at the start or end of a detection. The operating mode can be configured.
This object is only visible if the function of the output is configured to "operating mode room temperature controller".

Function: Function block

Object	Function	Name	Type	DPT	Flag
 4, 19, 34, 49, 64	Switching	FBx - Output 2 (x = 1...5)	1-bit	1.xxx	C, -, T, -

Description 1-bit object via which the second output of a function block outputs the switching commands to the KNX actuator (e.g. switch actuator) at the start or end of a detection. The telegram polarity can be configured. This object is only visible if the function of the output is configured to "switching".

Function: Function block

Object	Function	Name	Type	DPT	Flag
 4, 19, 34, 49, 64	Switching staircase	FBx - Output 2 (x = 1...5)	1-bit	1.010	C, -, T, -

Description 1-bit object via which the second output of a function block outputs the switching commands to the KNX actuator (e.g. switch actuator) at the start or end of a detection. The run-on-time elapses in the actuator. The telegram polarity is thus defined ("1" at the beginning of a detection, "0" at the end of a detection). This object is only visible if the function of the output is configured to "Staircase function".

Function: Function block

Object	Function	Name	Type	DPT	Flag
 4, 19, 34, 49, 64	Forced position	FBx - Output 1 (x = 1...5)	2-bit	2.001	C, -, T, -

Description 2-bit object via which the second output of a function block outputs the priority control commands with high priority to the KNX actuator (e.g. switch actuator) at the start or end of a detection. The telegram polarity can be configured. This object is only visible if the function of the output is configured to "switching with priority control".

Function: Function block

Object	Function	Name	Type	DPT	Flag
 4, 19, 34, 49, 64	Dimming value	FBx - Output 2 (x = 1...5)	1 bytes	5.001	C, -, T, -

Description 1-byte object via which the first output of a function block outputs the dimming commands to the KNX actuator (e.g. dimming actuator) at the start or end of a detection. The dimming values are configurable. This object is only visible if the function of the output is configured to "dimming value transmitter".

Function: Function block

Object	Function	Name	Type	DPT	Flag
 4, 19, 34, 49, 64	Scene extension	FBx - Output 2 (x = 1...5)	1 bytes	18.001	C, -, T, -

Description: 1-byte object via which the second output of a function block outputs a scene number to the KNX actuator (e.g. dimming actuator) at the start or end of a detection for the purpose of a scene recall. The scene number can be configured.
This object is only visible if the function of the output is configured to "light scene extension".

Function: Function block

Object	Function	Name	Type	DPT	Flag
 4, 19, 34, 49, 64	Temperature value	FBx - Output 2 (x = 1...5)	2 bytes	9.001	C, -, T, -

Description: 2-byte object via which the second output of a function block outputs preconfigured temperature values to a KNX actuator or sensor (e.g. room temperature controller) at the start or end of a detection. The temperature values can be configured.
This object is only visible if the function of the output is configured to "temperature value transmitter".

Function: Function block

Object	Function	Name	Type	DPT	Flag
 4, 19, 34, 49, 64	Brightness value	FBx - Output 2 (x = 1...5)	2 bytes	9.004	C, -, T, -

Description: 2-byte object via which the second output of a function block outputs preconfigured brightness values to a KNX actuator or sensor (e.g. external constant light controller) at the start or end of a detection. The brightness values can be configured.
This object is only visible if the function of the output is configured to "brightness value transmitter".

Function: Function block

Object	Function	Name	Type	DPT	Flag
 4, 19, 34, 49, 64	Operating mode	FBx - Output 2 (x = 1...5)	1 bytes	20.102	C, -, T, -

Description: 1-byte object via which the second output of a function block outputs a command for the operating mode switchover to the KNX actuator or sensor (e.g. room temperature controller) at the start or end of a detection. The operating mode can be configured.
This object is only visible if the function of the output is configured to "operating mode room temperature controller".

Objects for twilight level control

Function: Twilight level

Object	Function	Name	Type	DPT	Flag
 5, 20, 35, 50, 65	Presetting twilight level	FBx - Input (x = 1...5)	2 bytes	9.004	C, W, -, -

Description: 2-byte object for presetting an external twilight level value (10...2,000 Lux). The twilight level value received via the object remains unchanged until a new presetting (external twilight level, teach function or IR remote control). Even a bus voltage failure will not reset the twilight level value received via the bus. This object is only visible if the twilight level evaluation is brightness-dependent and the external twilight level presetting is enabled.

Function: Twilight level

Object	Function	Name	Type	DPT	Flag
 6, 21, 36, 51, 66	Teach twilight level	FBx - Input (x = 1...5)	1-bit	1.017	C, W, -, -

Description: 1-bit object for triggering a Teach operation for learning a twilight level value. With the Teach function, the effective brightness value is applied instantly by transmitting a corresponding telegram to this object as a new twilight level value. The telegram polarity can be configured. This object is only visible if the twilight level evaluation is brightness-dependent and the Teach function for the twilight level presetting is enabled.

Function: Twilight level

Object	Function	Name	Type	DPT	Flag
 7, 22, 37, 52, 67	Active twilight level	FBx - Feedback output (x = 1...5)	2 bytes	9.004	C, -, (T), (R)

Description: 2-byte object for the feedback of the active twilight level value of a function block. This object can optionally act as an active signalling object or passive status object (read out object). As an active signalling object, the current twilight level brightness value is transmitted once to the bus on each change of the twilight level, after ETS programming or after bus voltage return (optionally delayed). This object is only visible if the twilight level evaluation is brightness-dependent.

Function: Twilight level

Object	Function	Name	Type	DPT	Flag
 8, 23, 38, 53, 68	Deactivation of twilight level	FBx - Input / Output (x = 1...5)	1-bit	1.003	C, W, T, -

Description 1-bit object for activating and deactivating the twilight level in single devices, main units and extensions. It is possible to switch the twilight level evaluation off and on again during ongoing operation of the device via this object. When using main units and extensions, the use of this object is fundamental in order to be able to switch the main units to brightness-independent operation for output functions that are unlike the 1-bit data format. Thus, a distinction must be made between the application types when projecting the object.

Application type "single device": The object is an input. A "1" telegram deactivates the twilight level. A "0" telegram re-enables the twilight function evaluation.

Application type "Main unit": The object is an input and output.
Use as input: A "1" telegram deactivates the twilight level. A "0" telegram re-enables the twilight function evaluation.

Use as output: The main unit controls the switch-over of the twilight level evaluation of the extension(s) via this output depending on its own twilight level evaluation.

Combined use of the object as input and output: If the main unit is switched over to brightness-independent operation (use as input), the object does not control the twilight level evaluation of the extension(s) anymore (output function deactivated). No telegrams are then transmitted automatically anymore from the main unit until it is switched back to brightness-dependent operation! To ensure that the main unit and extension(s) function correctly during switch-over of the main unit to brightness-independent operation, the extension(s) must also be switched over simultaneously to brightness-independent operation via this object.

Application type "extension": The object is an input. A "1" telegram deactivates the twilight level. A "0" telegram re-enables the twilight function evaluation.

Object for the switch-off brightness (only for presence detector)

Function: Switch-off brightness

Object	Function	Name	Type	DPT	Flag
 9, 24, 39, 54, 69	Switch-off brightness Teach	FBx - Input (x = 1...5)	1-bit	1.017	C, W, -, -

Description 1-bit object for triggering a Teach operation for learning the switch-off brightness (only for presence detector). With the Teach function, the effective brightness value is applied instantly by transmitting a corresponding telegram to this object as new switch-off brightness. The telegram polarity can be configured.
This object is only visible if the application is configured to "presence detector" and the Teach function is enabled for the switch-off brightness.

Objects for the brightness value

Function: Brightness value

Object	Function	Name	Type	DPT	Flag
 10, 25, 40, 55, 70	External brightness sensor	FBx - Input (x = 1...5)	2 bytes	9.004	C, W, -, -

Description 2-byte object for receiving an external brightness value. This makes it possible to carry out the twilight level evaluation independently of the installation location of the device (e.g. provision of an external brightness value via a more favourably installed extension).
This object is only visible if the brightness value of a function block is to be detected externally.

Function: Brightness value

Object	Function	Name	Type	DPT	Flag
 11, 26, 41, 56, 71	Active brightness value	FBx - Feedback output (x = 1...5)	2 bytes	9.004	C, -, -, R

Description 2-byte object for the passive feedback of the active brightness value of a function block.

Objects for the motion evaluation

Function: Motion evaluation

Object	Function	Name	Type	DPT	Flag
 12, 27, 42, 57, 72	External motion	FBx - Input (x = 1...5)	1-bit	1.010	C, W, -, -

Description

1-bit object for receiving an external motion signal for single devices and main units ("1" = motion present, "0" irrelevant). An external 1-bit motion detection can be supplied to the device via this object, which originates from a pushbutton in the room, for example. This allows the user to control the connected KNX actuator by means of a simulated motion signal even without a motion detection in the detection area of the device. The evaluation of the external motion signal is possible brightness-dependent or brightness-independent (configurable).

In the case of main unit and extension arrangements, the main units receive the cyclical motion telegrams of the extensions via this object (it must be linked with the objects "motion" of the extensions).

In the application type "extension", it is not possible to supply external motion detections to the device for implementing a manual operation (e.g. by means of a pushbutton). This is only possible on a main unit. In the case of extensions, the object "External motion" performs another task. In this case, the twilight level is deactivated and activated in the extensions via this object. The cyclical ON telegrams of the main unit are received. These telegrams are not evaluated as motion, however, but are used for the switch-over of the twilight level evaluation. During the receipt of the cyclical ON telegram, the twilight level evaluation is deactivated. If the ON telegrams of the main unit are absent during the run-on-time, the extensions reactivate the twilight level evaluation. The receipt of an "OFF telegram" results in the direct activation of the twilight level evaluation (brightness dependent operation) in the extensions.

Function: Motion evaluation

Object	Function	Name	Type	DPT	Flag
 13, 28, 43, 58, 73	Movement	FBx - Output (x = 1...5)	1-bit	1.010	C, -, T, -

Description

1-bit object for transmitting a motion detection to the main unit (cyclical "1" = motion present, "0" = not transmitted). This object is only available for extensions.

Object for the additional transmission delay

Function: Additional transmission delay

Object	Function	Name	Type	DPT	Flag
 14, 29, 44, 59, 74	Factor add. transmission delay	FBx - Input (x = 1...5)	1 bytes	5.010	C, W, -, -

Description 1-byte object, the value of which extends the configured additional transmission delay (effective additional transmission delay = received factor x configured time).
This object is only visible if the additional transmission delay is configured discreetly according to a parameter in the ETS and the time extension is enabled.

Object for manual operation

Function: Manual operation

Object	Function	Name	Type	DPT	Flag
 15, 30, 45, 60, 75	Lighting manual ON/OFF	FBx - Input (x = 1...5)	1-bit	1.001	C, W, -, -

Description 1-bit object for manual control (switch on / switch off) of the activated KNX actuator (e.g. lighting). A manual operation is detected by the device via this object and processed according to the configuration of the operating mode. During manual control, the automatic is deactivated ("1" = ON / reaction as at the beginning of a detection, "0" = OFF / as at the end of a detection).

Object for the disabling function

Function: Disabling function

Object	Function	Name	Type	DPT	Flag
 16, 31, 46, 61, 76	Disabling	FBx - Input (x = 1...5)	1-bit	1.003	C, W, -, R

Description 1-bit object for activation and deactivation of the disabling function (telegram polarity configurable).

Object for transmitting the time after the last motion

Function: Time after last motion

Object	Function	Name	Type	DPT	Flag
 17, 32, 47, 62, 77	Time after last motion	FBx - Input (x = 1...5)	2 bytes	7.006	C, -, T, -

Description 2-byte object containing the current counter status of the measurement of the time period after the last identified motion in the data format "minutes". This object can act as an active signalling object, or alternatively, as a passive status object. As an active signalling object, the device transmits the current counter status cyclically to the bus. The cycle time can be configured in the ETS. During an active motion or ongoing standard delay, the counter value is always "0". If the current counter status has reached the maximum value "65,535", the device keeps this value until reset by a new motion detection of the counter.
This object is only visible in brightness-independent operation and only if the function is enabled in the ETS.

4.2.3.3 Objects for the light control

Objects of the output channels

Function: Output channels - activation of the KNX actuator					
Object	Function	Name	Type	DPT	Flag
 78	Switching	LC - Output channel 1	1-bit	1.001	C, -, T, -
Description: 1-bit object for switching activation of the KNX actuator of lighting channel 1. Its use depends on the configuration of the data formats of the control phases. This also makes combined activations possible by means of switching and dimming commands (objects 79, 80). It is recommended to link this object to the objects of the dimmable KNX actuator of channel 1 with the same function via a separate group address regardless of the control phase configuration. The application examples in this documentation show the necessary links of all communication objects.					

Function: Output channels - activation of the KNX actuator					
Object	Function	Name	Type	DPT	Flag
 79	Dimming	LC - Output channel 1	4-bit	3.007	C, -, T, -
Description: 4-bit object for activating the KNX actuator of lighting channel 1 via relative dimming commands. Its use depends on the configuration of the data formats of the control phases. This also makes combined activations possible by means of switching and dimming commands (objects 78, 80). It is recommended to link this object to the objects of the dimmable KNX actuator of channel 1 with the same function via a separate group address regardless of the control phase configuration. The application examples in this documentation show the necessary links of all communication objects.					

Function: Output channels - activation of the KNX actuator					
Object	Function	Name	Type	DPT	Flag
 80	Brightness value	LC - Output channel 1	1 bytes	5.001	C, -, T, -
Description: 1-bit object for activating the KNX actuator of lighting channel 1 via absolute dimming values. Its use depends on the configuration of the data formats of the control phases. This also makes combined activations possible by means of switching and dimming commands (objects 78, 79). It is recommended to link this object to the objects of the dimmable KNX actuator of channel 1 with the same function via a separate group address regardless of the control phase configuration. The application examples in this documentation show the necessary links of all communication objects.					

Function: Output channels - activation of the KNX actuator

Object	Function	Name	Type	DPT	Flag
 81	Switching	LC - Output channel 2	1-bit	1.001	C, -, T, -

Description 1-bit object for switching activation of the KNX actuator of lighting channel 2. Its use depends on the configuration of the data formats of the control phases. This also makes combined activations possible by means of switching and dimming commands (object 82). It is recommended to link this object to the objects of the dimmable KNX actuator of channel 2 with the same function via a separate group address regardless of the control phase configuration. The application examples in this documentation show the necessary links of all communication objects.
This object is only visible if channel 2 is used.

Function: Output channels - activation of the KNX actuator

Object	Function	Name	Type	DPT	Flag
 82	Brightness value	LC - Output channel 2	1 bytes	5.001	C, -, T, -

Description 1-bit object for activating the KNX actuator of lighting channel 2 via absolute dimming values. Its use depends on the configuration of the data formats of the control phases. This also makes combined activations possible by means of switching and dimming commands (object 81). It is recommended to link this object to the objects of the dimmable KNX actuator of channel 2 with the same function via a separate group address regardless of the control phase configuration. The application examples in this documentation show the necessary links of all communication objects.
To ensure that the superimposed operation works correctly in multichannel operation, the brightness value-feedback of an actuator must lead from channel 2 to this object whereby it is always essential to additionally set the "write" flag!
This object is only visible if channel 2 is used.

Function: Output channels - activation of the KNX actuator

Object	Function	Name	Type	DPT	Flag
 83	Switching	LC - Output channel 3	1-bit	1.001	C, -, T, -

Description 1-bit object for switching activation of the KNX actuator of lighting channel 3. Its use depends on the configuration of the data formats of the control phases. This also makes combined activations possible by means of switching and dimming commands (object 84). It is recommended to link this object to the objects of the dimmable KNX actuator of channel 3 with the same function via a separate group address regardless of the control phase configuration. The application examples in this documentation show the necessary links of all communication objects.
This object is only visible if channel 3 is used.

Function: Output channels - activation of the KNX actuator

Object	Function	Name	Type	DPT	Flag
 ⁸⁴	Brightness value	LC - Output channel 3	1 bytes	5.001	C, -, T, -

Description: 1-bit object for activating the KNX actuator of lighting channel 3 via absolute dimming values. Its use depends on the configuration of the data formats of the control phases. This also makes combined activations possible by means of switching and dimming commands (object 83). It is recommended to link this object to the objects of the dimmable KNX actuator of channel 3 with the same function via a separate group address regardless of the control phase configuration. The application examples in this documentation show the necessary links of all communication objects.
 To ensure that the superimposed operation works correctly in multichannel operation, the brightness value-feedback of an actuator must lead from channel 3 to this object whereby it is always essential to additionally set the "write" flag!
 This object is only visible if channel 3 is used.

Function: Output channel - Feedback of the KNX actuator

Object	Function	Name	Type	DPT	Flag
 ⁸⁵	Feedback brightness value	LC - Input channel 1	1 bytes	5.001	C, W, T, A

Description: 1-byte object via which the light control receives the current brightness value of the KNX actuator from channel 1. This information is important for some control processes. In the configuration, the light control must be informed as to how the actuator performs the feedback. This can take place by active, or alternatively, passive transmission (is then requested by this object). This object must always be linked to the brightness value feedback object of an activated KNX actuator from channel 1!
 The basic regulation (control output calculation) always relates to channel 1. The control outputs of channels 2 and 3 are always calculated in relation to the control output of the first channel via corresponding offset settings. For this reason, only this one feedback object from channel 1 is necessary.

Objects for the setpoint

Function: Setpoint

Object	Function	Name	Type	DPT	Flag
 ⁸⁶	Setpoint preset	LC - Input	2 bytes	9.004	C, W, -, -

Description: 2-byte object for setting a basic setpoint. The setpoint received via this object remains unchanged until a new setpoint presetting (by means of external setpoint presetting, setpoint shift or Teach) or until a new reset command to the object "Setpoint Reset". Even a bus voltage failure will not reset the brightness setpoint received via the bus.
 This object is only visible if the external setpoint presetting is enabled.

Function: Setpoint

Object	Function	Name	Type	DPT	Flag
 87	Setpoint Shift	LC - Input	4-bit	3.007	C, W, -, -

Description 4-bit object for relative shift of the active setpoint. With the setpoint shift the setpoint can be changed within the configured limits during the control phase by direct control of the assigned lighting.
 The setpoint shift is started by transmitting relative 4-bit dimming telegrams to the object "setpoint shift" during the control phase. At the same time, the light control controls the lighting via the relative dimming object of the first channel and thereby sets another brightness value. When the desired brightness is reached, a stop telegram must be received via the object "setpoint shift" which is then transmitted to channel 1 and output to the lighting.
 This object is only visible if the setpoint shift is enabled.

Function: Setpoint

Object	Function	Name	Type	DPT	Flag
 88	Reset setpoint	LC - Input	1-bit	1.015	C, W, -, -

Description 1-bit object for resetting the setpoint to the ETS presetting ("1" = reset setpoint, "0" = no reaction). It makes no difference which function changed the setpoint.

Function: Setpoint

Object	Function	Name	Type	DPT	Flag
 89	Setpoint Teach	LC - Input	1-bit	1.017	C, W, -, -

Description 1-bit object for triggering a Teach operation for learning a setpoint. With the Teach function, the effective brightness value is applied instantly by transmitting a corresponding telegram to this object as a new setpoint. The telegram polarity can be configured.
 This object is only visible if the Teach function for the setpoint presetting is enabled.

Function: Setpoint

Object	Function	Name	Type	DPT	Flag
 90	Setpoint effective	LC - Feedback - Output	2 bytes	9.004	C, -, (T), (R)

Description 2-byte object for the feedback of the active setpoint of the light control. This object can optionally act as an active signalling object or passive status object (read out object). As an active signalling object, the current setpoint is transmitted once to the bus on each change of the setpoint, after ETS programming or after bus voltage return (optionally delayed).
 This object is only visible if the setpoint presetting is enabled.

Objects for disabling function and for superimposed operation

Function: Disabling function

Object	Function	Name	Type	DPT	Flag
 ⁹¹	Disabling	LC - Input	1-bit	1.003	C, W, -, -

Description: 1-bit object for activation and deactivation of the disabling function (telegram polarity configurable).
This object is only visible if the light control works autonomously (not in combination with FB1).

Function: Superimposed operation

Object	Function	Name	Type	DPT	Flag
 ⁹²	Switching	LC - Input / superimposed operation	1-bit	1.001	C, W, -, -

Description: 1-bit object for transmitting a superimposed operation in the data format "switching" to the light control. With the superimposed operation, the assigned lighting device can be activated directly, for example, via a pushbutton or operating panel. The manually triggered switching commands to the lighting also have to be transmitted to the lighting control via this object. By "listening in" to the telegrams, the light control is disabled during the superimposed operation, whereby the lighting is no longer influenced by the control but only by the user.
To make it possible to exit an application, the presence object (in autonomous operation) or disabling object must be configured (parameter-dependent)!
This object is only visible if superimposed operation is enabled.

Function: Superimposed operation

Object	Function	Name	Type	DPT	Flag
 ⁹³	Dimming	LC - Input / superimposed operation	4-bit	3.007	C, W, -, -

Description: 4-bit object for transmitting a superimposed operation in the data format "dimming" to the light control. With the superimposed operation, the assigned lighting device can be activated directly, for example, via a pushbutton or operating panel. The manually triggered dimming commands to the lighting also have to be transmitted to the lighting control via this object. By "listening in" to the telegrams, the light control is disabled during the superimposed operation, whereby the lighting is no longer influenced by the control but only by the user.
To make it possible to exit an application, the presence object (in autonomous operation) or disabling object must be configured (parameter-dependent)!
This object is only visible if superimposed operation is enabled.

Function: Superimposed operation

Object	Function	Name	Type	DPT	Flag
 ⁹⁴	Brightness value	LC - Input / superimposed operation	1 bytes	5.001	C, W, -, -

Description 1-byte object for transmitting a superimposed operation in the data format "brightness value" to the light control. With the superimposed operation, the assigned lighting device can be activated directly, for example, via a pushbutton or operating panel. The manually triggered brightness value commands to the lighting also have to be transmitted to the light control via this object. By "listening in" to the telegrams, the light control is disabled during the superimposed operation, whereby the lighting is no longer influenced by the control but only by the user.
To make it possible to exit an application, the presence object (in autonomous operation) or disabling object must be configured (parameter-dependent)!
This object is only visible if superimposed operation is enabled.

Function: Superimposed operation

Object	Function	Name	Type	DPT	Flag
 ⁹⁵	Scene extension	LC - Input / superimposed operation	1 bytes	18.001	C, W, -, -

Description 1-byte object for transmitting a superimposed operation in the data format "scene recall" to the light control. With the superimposed operation, the assigned lighting device can be activated directly, for example, via a pushbutton or operating panel. The manually triggered scene recall commands to the lighting also have to be transmitted to the light control via this object. By "listening in" to the telegrams, the light control is disabled during the superimposed operation, whereby the lighting is no longer influenced by the control but only by the user.
To make it possible to exit an application, the presence object (in autonomous operation) or disabling object must be configured (parameter-dependent)!
This object is only visible if superimposed operation is enabled.

Function: Disabling status

Object	Function	Name	Type	DPT	Flag
 ⁹⁶	Status disabling fct light ctr	LC - Feedback - Output	1-bit	1.003	C, -, (T), (R)

Description 1-bit object for the feedback of the current disabling status of the light control. This object takes into account disabling operations of the light control by the disabling function or by a superimposed operation ("1" = light control disabled, "0" = light control in operation).
This object can optionally act as an active signalling object or passive status object (read out object). As an active signalling object, the current state is transmitted once to the bus on each change of the disabling state, after ETS programming or after bus voltage return (optionally delayed).
This object is only visible if the status function is enabled.

Object for the presence signal

Function: Presence control

Object	Function	Name	Type	DPT	Flag
 ⁹⁷	Presence	LC - Input	1-bit	1.010	C, W, -, -

Description 1-bit object for transmitting the presence information to the light control ("1" = presence exists, "0" = presence does not exist). The light control is activated (startup control phase) and deactivated (step down control phase) by means of the presence information.
This object is only visible if the light control works autonomously (not in combination with FB1). The presence information is transmitted from the function block in combination with FB1.

4.2.3.4 Objects for the brightness limiting values

Objects for the output limiting values

Function:	Limiting value				
Object	Function	Name	Type	DPT	Flag
 ¹⁰²	Limiting value 1 switching	BLV - Output	1-bit	1.001	C, -, T, -
Description	1-bit object via which the first limiting value transmits the switching command if the limiting value thresholds are exceeded or not reached. This object is only visible if the function of the first limiting value is configured to "switching".				

Function:	Limiting value				
Object	Function	Name	Type	DPT	Flag
 ¹⁰²	Limiting value 1 brightness value	BLV - Output	1 bytes	5.001	C, -, T, -
Description	1-byte object via which the first limiting value transmits the brightness value command if the limiting value thresholds are exceeded or not reached. This object is only visible if the function of the first limiting value is configured to "brightness value".				

Function:	Limiting value				
Object	Function	Name	Type	DPT	Flag
 ¹⁰²	Limiting value 1 scene extension	BLV - Output	1 bytes	18.001	C, -, T, -
Description	1-byte object via which the first limiting value transmits the scene recall command if the limiting value thresholds are exceeded or not reached. This object is only visible if the function of the first limiting value is configured to "scene extension".				

Function:	Limiting value				
Object	Function	Name	Type	DPT	Flag
 ¹⁰³	Limiting value 2 switching	BLV - Output	1-bit	1.001	C, -, T, -
Description	1-bit object via which the second limiting value transmits the switching command if the limiting value thresholds are exceeded or not reached. This object is only visible if the function of the second limiting value is configured to "switching". This object is only visible if the second limiting value is enabled.				

Function: Limiting value

Object	Function	Name	Type	DPT	Flag
 ¹⁰³	Limiting value 2 brightness value	BLV - Output	1 bytes	5.001	C, -, T, -

Description 1-byte object via which the second limiting value transmits the brightness value command if the limiting value thresholds are exceeded or not reached. This object is only visible if the function of the second limiting value is configured to "brightness value".
This object is only visible if the second limiting value is enabled.

Function: Limiting value

Object	Function	Name	Type	DPT	Flag
 ¹⁰³	Limiting value 2 scene extension	BLV - Output	1 bytes	18.001	C, -, T, -

Description 1-byte object via which the second limiting value transmits the scene recall command if the limiting value thresholds are exceeded or not reached. This object is only visible if the function of the second limiting value is configured to "scene extension".
This object is only visible if the second limiting value is enabled.

Function: Limiting value

Object	Function	Name	Type	DPT	Flag
 ¹⁰⁴	Limiting value 3 switching	BLV - Output	1-bit	1.001	C, -, T, -

Description 1-bit object via which the third limiting value transmits the switching command if the limiting value thresholds are exceeded or not reached. This object is only visible if the function of the third limiting value is configured to "switching".
This object is only visible if the third limiting value is enabled.

Function: Limiting value

Object	Function	Name	Type	DPT	Flag
 ¹⁰⁴	Limiting value 3 brightness value	BLV - Output	1 bytes	5.001	C, -, T, -

Description 1-byte object via which the third limiting value transmits the brightness value command if the limiting value thresholds are exceeded or not reached. This object is only visible if the function of the third limiting value is configured to "brightness value".
This object is only visible if the third limiting value is enabled.

Function: Limiting value

Object	Function	Name	Type	DPT	Flag
 104	Limiting value 3 scene extension	BLV - Output	1 bytes	18.001	C, -, T, -

Description: 1-byte object via which the third limiting value transmits the scene recall command if the limiting value thresholds are exceeded or not reached. This object is only visible if the function of the third limiting value is configured to "scene extension". This object is only visible if the third limiting value is enabled.

Objects for supplementary functions of the limiting values

Function: Limiting value external presetting

Object	Function	Name	Type	DPT	Flag
 105, 108, 111	Limiting value x external presetting (x = 1, 2, 3)	BLV - Input	2 bytes	9.004	C, W, -, -

Description: 2-byte object for presetting an external limiting value (10...2,000 Lux). The relative hysteresis value configured in the ETS results in a new value for both brightness thresholds depending on the type of limiting value definition. The new limiting value remains unchanged until a new presetting (externally via object or via Teach function). This object is only visible if the limiting value presetting is enabled.

Function: Limiting value Teach

Object	Function	Name	Type	DPT	Flag
 106, 109, 112	Limiting value x Teach (x = 1, 2, 3)	BLV - Input	1-bit	1.017	C, W, -, -

Description: 1-bit object for triggering a Teach operation for learning a limiting value. With the Teach function, the effective brightness value is applied instantly by transmitting a corresponding telegram to this object as a new limiting value. The telegram polarity can be configured. This object is only visible if the Teach function is enabled.

Function: Limiting value feedback

Object	Function	Name	Type	DPT	Flag
 107, 110, 113	Limiting value x effective (x = 1, 2, 3)	BLV - Feedback - Output	2 bytes	9.004	C, -, (T), (R)

Description: 2-byte object for the feedback of an active limiting value. This object can optionally act as an active signalling object or passive status object (read out object). As an active signalling object, the current limiting value is transmitted once to the bus on each change of the limiting value, after ETS programming or after bus voltage return (optionally delayed). This object is only visible if the feedback is enabled.

Objects for the disabling function

Function: Disabling function

Object	Function	Name	Type	DPT	Flag
 ¹¹⁴	Disabling	BLV - Input	1-bit	1.003	C, W, -, -

Description 1-bit object for activation and deactivation of the disabling function (telegram polarity configurable).
This object is only visible if the disabling function is enabled.

4.2.3.5 Object for IR remote control

Function: Disable IR remote control

Object	Function	Name	Type	DPT	Flag
 ¹²²	Disabling	IR Input	1-bit	1.003	C, W, -, -

Description 1-bit object for activation and deactivation of the disabling function (telegram polarity configurable).
This object is only visible if the IR remote control and disabling function are enabled.

4.2.3.6 Objects for the function block switch-over

Function:	Function block switch-over				
Object	Function	Name	Type	DPT	Flag
 ¹²³	Change-over	FB groups - Input	1-bit	1.001	C, W, -, -
Description	1-bit object for the switch-over of the function block groups (telegram polarity configurable). The read out of this object merely returns the telegram value last written in the object via the bus (after reset "0"). The active group (depending on the configuration) after bus voltage return or ETS programming is not tracked automatically in this object (see object "Status switch-over").				

Function:	Function block switch-over				
Object	Function	Name	Type	DPT	Flag
 ¹²⁴	Status switch-over	FB groups - Output	1-bit	1.001	C, -, T, R
Description	1-bit object for status indication of the actual active function block group (telegram polarity is determined by the configuration of the polarity of the object "switch-over").				

4.2.4 Functional description

4.2.4.1 Global block diagram

The device contains various functional units that perform a variety of tasks and have various integrated and external interfaces in the form of sensors and KNX communication objects. Various control or regulation tasks can be performed in the KNX system by activation of a KNX actuator and sensor on the objects (e.g. ceiling detector evaluation FB2-5) or by combination of the functional units among each other (e.g. light control with FB1 for motion detection).

The block diagram shown below (figure 10) illustrates the functional units of the device and the linking of these units internally. It also shows the external communication interfaces in summarized form.

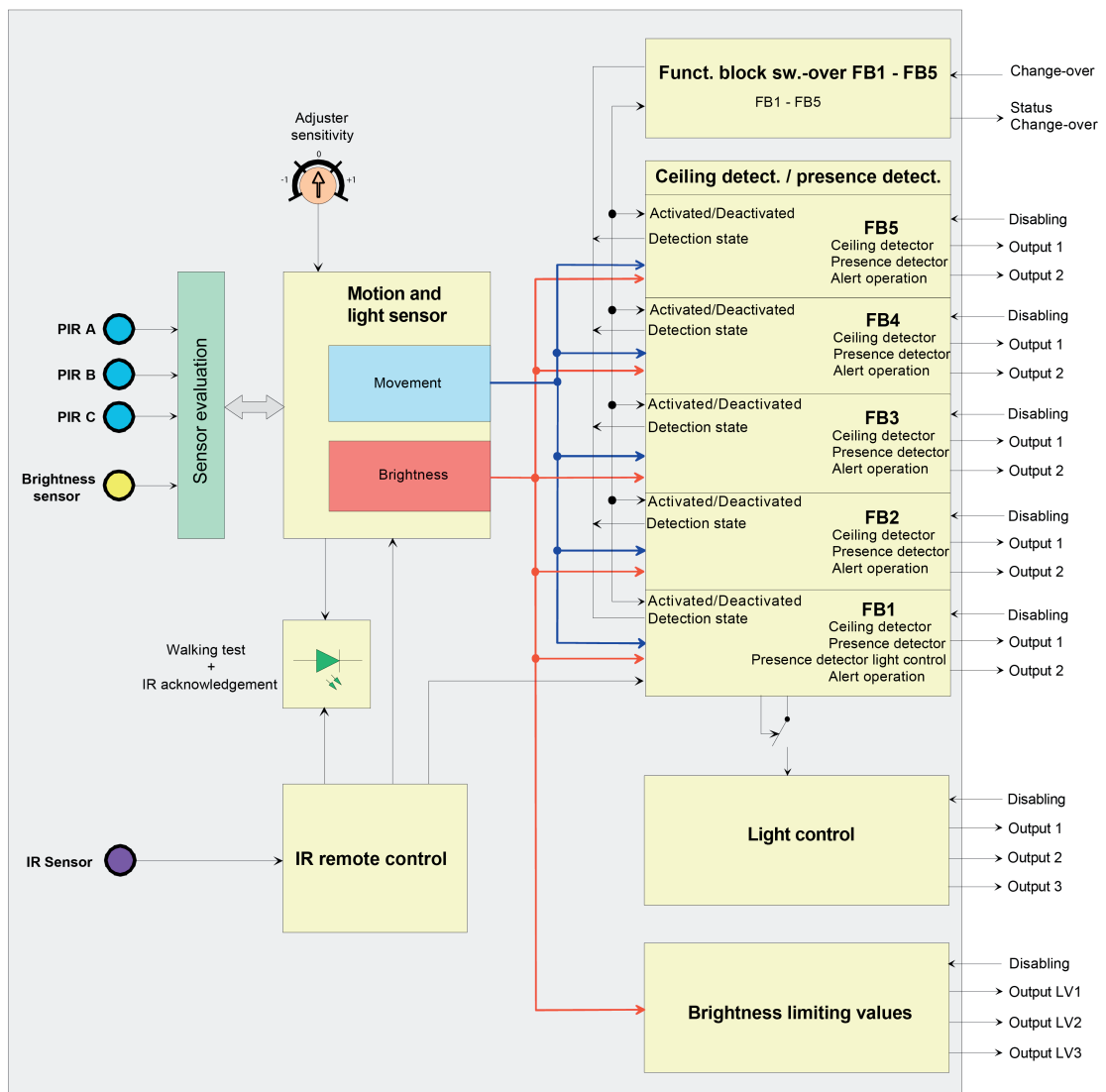

Figure 10: Block diagram of all device functions

The device combines the functions of up to 5 ceiling detectors / presence detectors, a light control and brightness sensor with limiting value evaluation in just one bus subscriber. The following functional units implement this variety of functions...

- Functional unit "ceiling detector / presence detector"
Contains up to 5 function blocks (FB) that operate logically independent of each other and can each be configured separately to the application "ceiling detector", "presence detector" or "detector". The first function block can be combined with the light control within the device so that motion evaluation (presence signal), brightness evaluation and light control can be executed conveniently with just one bus device.
- Functional unit "Light control"
Contains powerful functions of a constant light control. This functional unit can be linked internally to the motion and brightness sensors (provided via FB1), or alternatively, externally to other bus devices via different communication objects.
- Functional unit "Brightness limiting values"
This functional unit evaluates the determined brightness. It can compare this brightness value continuously with limiting values and transmit preconfigured telegrams of different data formats to the bus if the brightness value exceeds or does not reach the limiting values.
- Functional unit "Motion and light sensor"
This unit evaluates and processes the signals of the motion and brightness sensors of the device. The prepared signals are made available to various other functional units and can additionally be made available to other bus devices via objects as well.
- Functional unit "Function block switch-over"
This functional unit enables the switch-over of the function blocks 1-5. For this purpose, the function blocks can each be assigned to one of two function block groups. Only one function block group is ever active during operation. When switching over the function block group, the assigned function blocks of the group to be switched off are deactivated and then the function blocks of the other function block groups are activated. Function blocks that are not assigned to any function block groups are not influenced.
- Functional unit "IR remote control"
This functional unit evaluates the signals of the IR remote control (accessory). This allows the user to influence functions and parameters during the running time of the device.

The individual functional units are described in detail in the following chapters of the software description.

4.2.4.2 Motion and light sensor

4.2.4.2.1 PIR sensor

Motion detection

The device detects extremely sensitive motions via 3 digital PIR sectors with a total detection area of 360°, in which each PIR sector covers a subarea of 120°. The sensitivity of the motion detection, which is a gauge for the range of the PIR evaluation, can be configured separately in the ETS for the PIR sectors and can also be adjusted directly on the device using an adjuster as well as with the IR remote control (accessories) after commissioning. The PIR sectors can be assigned individually to the function blocks of the device numbering up to 5.

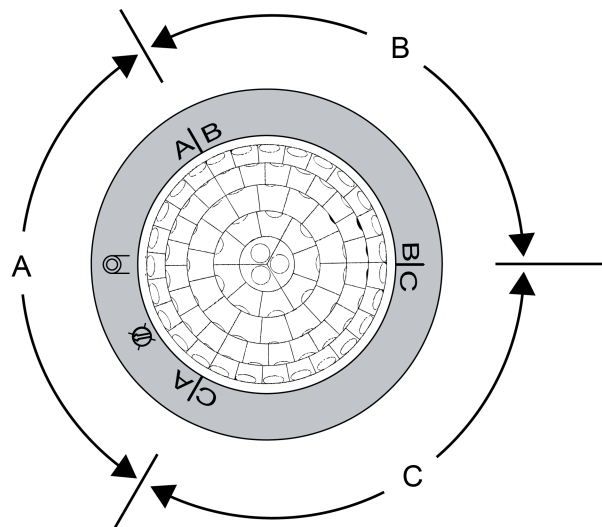

Figure 11: Arrangement of the PIR sectors A, B and C

An adjuster on the device makes it possible to change the configured sensitivity setting of all PIR sectors. The sensitivity can thereby be reduced or increased by a maximum of one level. The adjustment range divided into three sections.

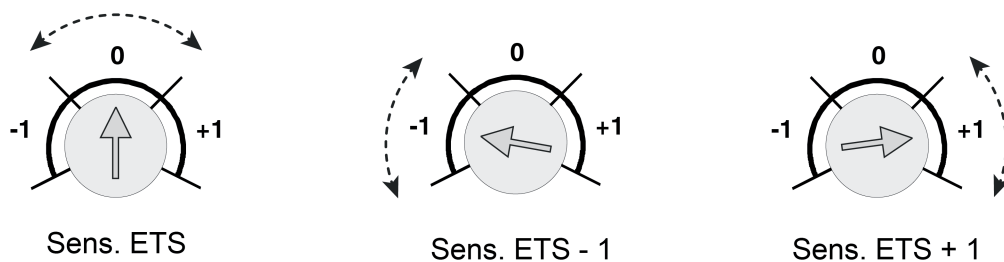

Figure 12: Adjustment ranges of the sensitivity adjuster on the device (-1 <-> 0 <-> +1)

- i** The set sensitivity on the device can be changed at any time by new ETS programming or via the IR remote control. In the course of this, the device no longer takes the position of the adjuster into account until a new adjustment is made. As a result, the position of the adjuster gives no indication of the actual effective sensitivity. When presetting the sensitivity, the last action carried out (ETS programming, adjuster on the device or IR remote control) is always relevant.

With application program of version 1.2, it is possible, in conjunction with devices from release version "V01" (printed on the device label), to influence the digital evaluation of all PIR sensors in terms of sensitivity. It is possible here to optionally reduce the basic sensitivity in order to reduce or even fully suppress unwanted motion detections in extensive installation environments (large detection radius) in parts. The signal evaluation of interfering signals in the outer detection area (e.g. air movements) can be influenced in particular - depending on their intensity - so that they no longer result in a motion detection. The detection of body heat motions or other motions in the immediate proximity of the device is not significantly affected, however, owing to a reduced basic sensitivity.

The "low" setting of the parameter "basic sensitivity of all PIR sectors" on the parameter page "Motion and light sensor" reduces the basic sensitivity globally to a dimension defined by the manufacturer. This takes place quite independently of the individual default sensitivity of the individual PIR sectors or user setting on the device or by the IR remote control. Even at low basic sensitivity, the sensitivity of individual PIR sectors can still be configured and influenced as described.

We generally recommend setting the basic sensitivity to "high". It should only be reduced if undesirable false triggers frequently occur in the long-distance range, particularly in the case of ceiling detector applications for large detection areas.

- i The application program of version 1.2 can also be programmed in older devices (no release version "V01" or higher). In this case, the parameter for basic sensitivity will not be evaluated. With the application program of version 1.1, it is generally not possible to configure the basic sensitivity even if this application program is programmed in devices from release version "V01". In the cases last mentioned above, the devices always work with high basic sensitivity.

Interlock of the motion detection

When the luminaires activated by the device are in the detection field, the switching on and off of the luminaires can result in motion detection due to changing thermal radiation. To prevent this inaccuracy, the switching status of the luminaires must be guided to the 1-bit object "Interlock PIR sensor". When a corresponding status telegram is received, the motion detection is disabled for a configurable lockout time, so that no motion is detected due to the changing thermal radiation. An ongoing lockout time is restarted upon receiving a new corresponding status telegram.

4.2.4.2.2 Brightness sensor

Brightness measurement

The device has a brightness sensor, which is guided laterally from the housing by a light guide on the lens surface of the device for determining workplace brightness or ambient brightness. The sensor detects the reflected mixed light composed of artificial light and daylight from the area or objects below the device via the light guide. A reflection coefficient programmed at the factory enables the device to determine the effective brightness of the workplace surface or floor surface. The reflection coefficient of the device can be adapted to other workplace or floor surfaces by using the calibration function if required.

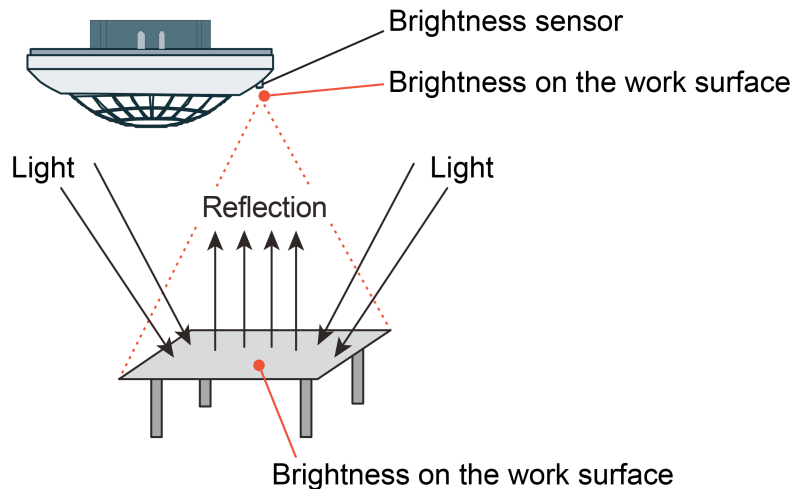

Figure 13: Brightness determination by measuring reflected mixed light composed of artificial light and daylight

The brightness value determined by the device can be made available to the KNX system via the 2 byte-communication object "Measured brightness value". The device can transmit the brightness value actively and/or cyclically for a configured brightness change. It is also possible to only provide the brightness value passively and to transmit this on request.

Calibration function

The value for the brightness to be determined on the work surface or floor surface by the device depends on the measured brightness on the light guide. The brightness on the light guide is derived from the reflected brightness on the underlying surface. To determine the brightness on the measuring surface from the measured brightness on the light guide, the reflection coefficient of the surface must be known. In the factory calibration, the reflection coefficient for the measuring surface is set to 0.3. This already makes an adjustment to many surfaces possible.

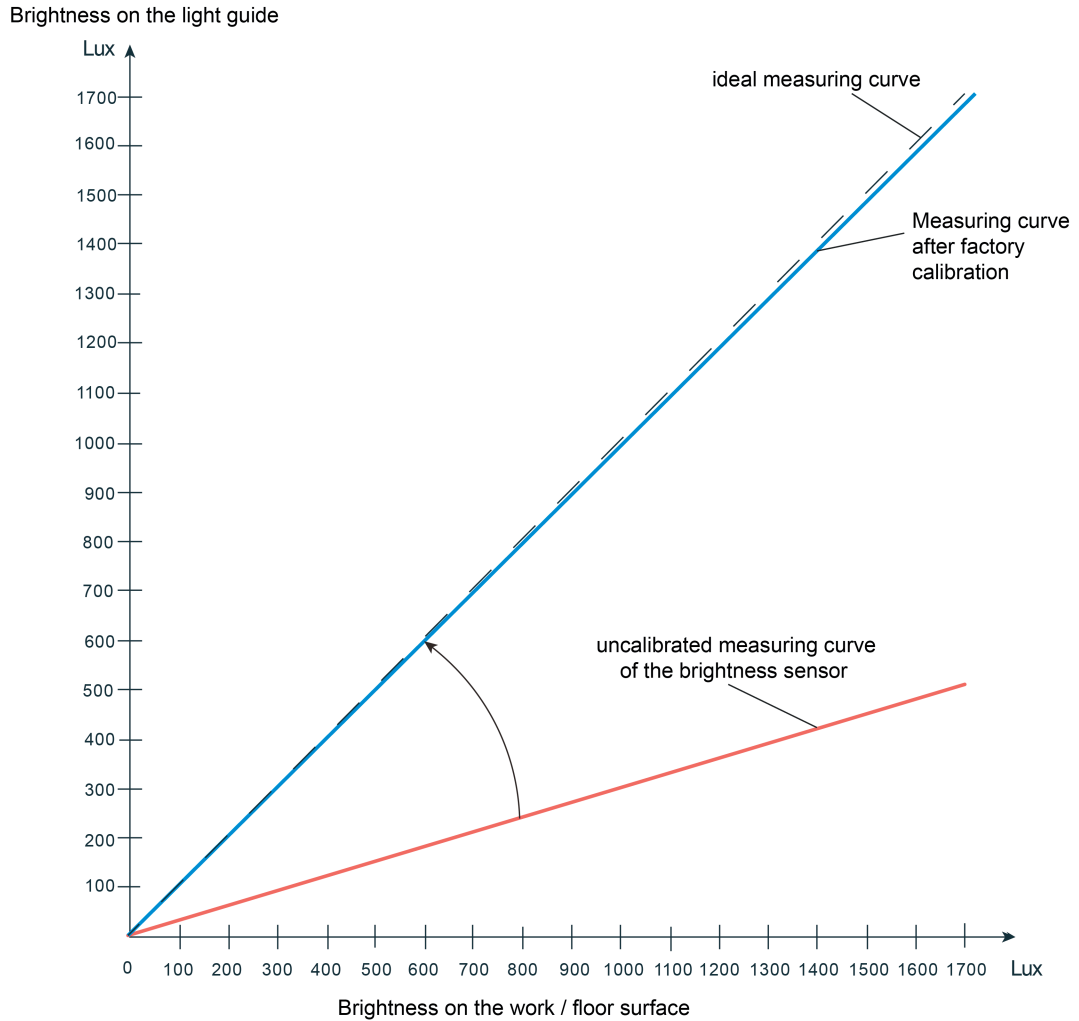

Figure 14: Determining the brightness on the work / floor surface during factory calibration
Reflection coefficient 0.3 corresponds to surface finish (grey desktop)

To compensate for any deviations between the brightness determined during factory calibration and the real brightness on the work surface, the brightness measurement can be calibrated using a calibration function (adjustment of the reflection coefficient) and thus adapted to special surface finishes. During calibration, an externally preset brightness value at the workplace is assigned to the currently measured brightness on the light guide. This presetting is made via the 2-byte communication object "sensor calibration". The sensor calibration in the ETS must be activated on the parameter page "Motion and light sensor" by the parameter of the same name so that this object can be visible and subsequent calibration possible. For this purpose, this parameter must be set from "factory calibration" to "calibration by telegram".

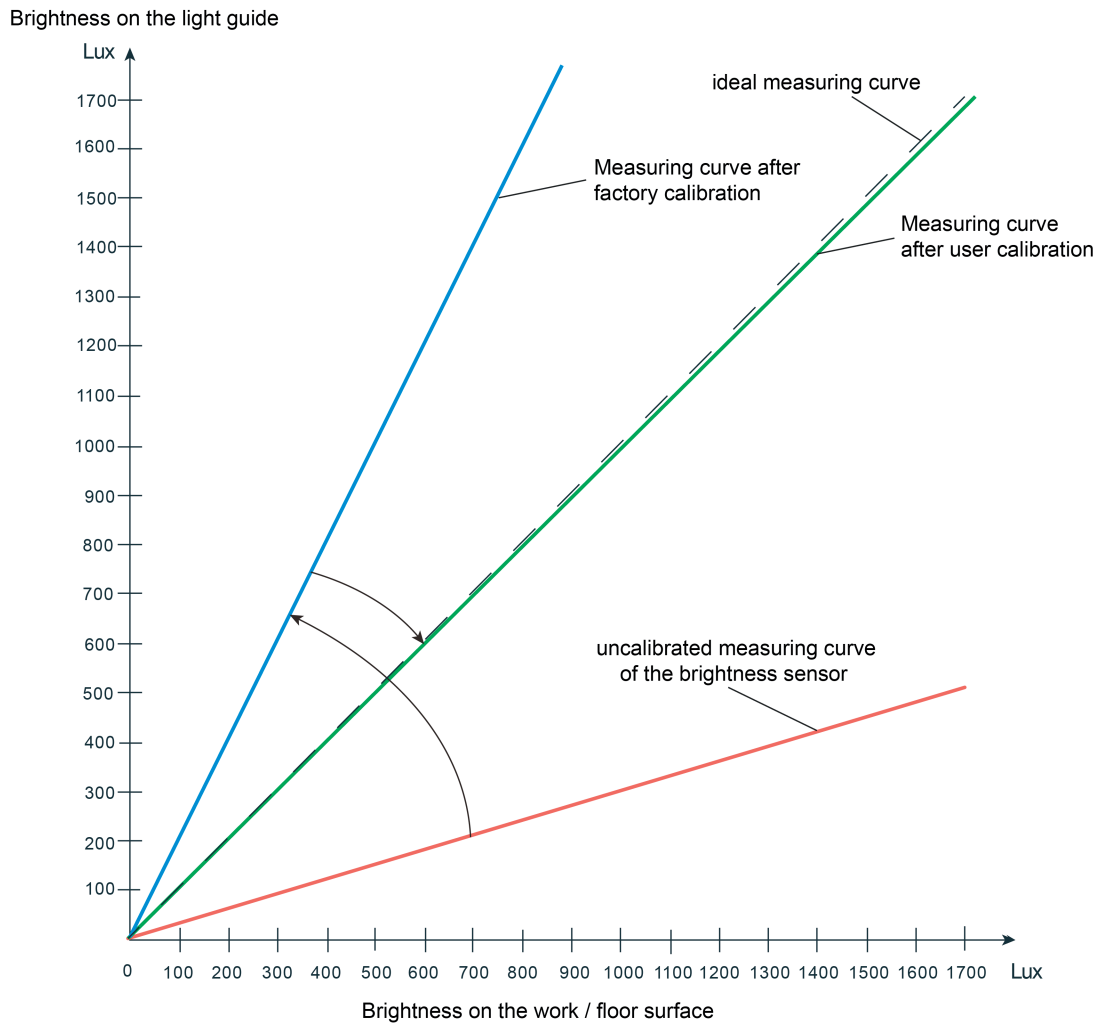

Figure 15: Correction of the determined brightness on the work / floor surface by means of user calibration
e.g. reflection coefficient 0.5 corresponds to surface finish (light floor covering)

Whether or not a subsequent user calibration is necessary can be determined purely subjectively or by reference measurement. A user calibration should be performed if the twilight level evaluation or light control can be evaluated subjectively as "not adequate" by persons present. Alternatively, it is possible to determine whether subsequent calibration is necessary immediately after commissioning by reading out the brightness value determined by the device during factory calibration via the object "Measured brightness value". Here, the read out brightness value must be compared with the measured value of a suitable brightness meter (calibrated luxmeter) located on the work surface or floor surface. If the deviation between the brightness values is too great, a user calibration should be performed. During the comparison measurement on the surface, several measurements should be made at various points. The individual measurement results must then be averaged and compared with the measured value of the device.

Since the reflection coefficient set by the factory calibration is correct in most cases, a user calibration is not necessary.

- i** A user calibration is necessary if an unfavourable installation location has been chosen for the device (installed directly above a desktop in an office in the application as presence detector) or the device - for example, in the application as ceiling detector - measures the reflected light of a dark floor surface.

The following steps must be carried out for a user calibration...

- Set the brightness level in the room as desired.
- Then transmit the brightness on the work / floor surface (measuring surface) that was measured several times and averaged - with the aid of the ETS, for example - to the object "sensor calibration". As a result, the device assigns the predefined measured value to the currently measured brightness value (brightness on the light guide) whereby the measured value curve is adapted in the device.

If the parameter "sensor calibration" in the ETS is set to "calibration by telegram", the device will not evaluate any brightness until a user calibration has been carried out! In this case, all function blocks and the light control will therefore have no function until a calibration has been carried out properly. The brightness value tracked via the object "Measured brightness value" can be influenced by the parameter "Behaviour in case calibration not carried out" in the event of a calibration not yet carried out. Depending on the setting, the device will either transmit no brightness value (value "0" in the object) or the value "7FFF" (hexadecimal) to indicate an invalid brightness measured value.

- i** An old user calibration is replaced permanently by a new calibration (is preserved even after bus voltage failure). The sensor calibration can be reset to factory calibration at any time by the parameter in the ETS.

4.2.4.2.3 Walking test and display of motion impulses

The device has a walking test function. The walking test function serves as a guide during the project design and setting of the PIR detection area. The walking test indicates the reaction of the device when detecting motions by means of a blue status LED that is clearly visible behind the sensor window. The walking test can be active immediately after the ETS commissioning, or alternatively, can be activated or deactivated using the IR remote control (accessory) during ongoing operation of the device. Optionally, the status LED can signal any detected motions even during normal operation.

Characteristics of the device in the walking test

The device has the following characteristics during an active walking test...

- The motion detection always takes place brightness-independent.
 - All PIR sectors are active (according to the set sensitivities).
 - When a motion is detected, a blue status LED in the sensor window is activated for the duration of the motion impulse. At the same time, the motion signals of the three sectors are combined.
 - No transmission delay is started at the end of a detected motion.
 - The function blocks 1-5 and the function block switch-over are not processed (no telegrams are transmitted).
 - There is no main unit and extension arrangement. The device works autonomously.
 - The parameters "Behaviour after bus voltage return" and "Behaviour after ETS programming" and the disabling function of a function block are not evaluated.
 - Only the buttons "Test" (for deactivation of the walking test) and "sensitivity" (for adjustment of the sensitivity setting) are allowed on the IR remote control.
- i** An ongoing transmission delay after bus voltage return is deactivated during activation of the walking test function. This is then no longer active, even during deactivation of the walking test function.

Activation and deactivation via ETS parameter

To activate the walking test via the ETS configuration, the parameter "Walking test after ETS programming" must be set to "activated" on the parameter page "Motion and light sensor". After subsequently programming the application program in the ETS, the walking test is then activated automatically.

It is possible to deactivate a walking test with the aid of the ETS by resetting the aforementioned parameter to "deactivated" and reprogramming the application program.

- i** The walking test can also be deactivated by the IR remote control (see below) or by a bus voltage failure (device reset).

Activation and deactivation by IR remote control

The walking test can also be activated and deactivated via the IR remote control (accessory). To make this possible, the IR remote control must be enabled in the ETS on the parameter page of the same name and the parameter "button 'Test' for walking test function" must be set to "activated". With this parameter setting, the walking test function can then be activated and deactivated during ongoing operation using the "Test" button of the IR remote control. In this way, it is also possible to deactivate a walking test that was activated by ETS programming.

- i** If the walking test is deactivated via the IR remote control, the function blocks that were active before the walking test are set to the basic state, i.e. all time delays are reset and the configured telegrams are transmitted at the end of the detection.

- i** The walking test can also be deactivated by a bus voltage failure (device reset).

Display of motion impulses

The blue status LED is activated by the walking test. Optionally, the status LED can signal any detected motions even during normal operation. The parameter "Display of motion impulses via walking test LED" enables this function with the setting "with active walking test and in normal operation". The signalling enables the start and duration of the motion detection to be visualized by the device at any time.

Example application: Used outdoors to detect the failure of a light bulb.

- i** The status LED displays detected motions of all PIR sectors brightness-independent. It should be noted that not all PIR sectors always have to be assigned to a function block. Consequently, a signalled motion cannot necessarily be assigned to a function block and thus explicitly to a lighting system.

4.2.4.3 Function blocks 1-5 for motion detection

4.2.4.3.1 Applications

The device contains up to 5 function blocks (FB) that operate logically independent of each other and can each be configured separately to the application "ceiling detector", "presence detector" or "detector". The first function block can be combined with the light control within the device so that motion evaluation (presence signal), brightness evaluation and light control can be executed conveniently with just one bus device.

Up to two output communication objects are available per function block, which transmit the switching and control commands to the bus. Depending on the configured function (switching, staircase function, dimming value transmitter, scene extension, temperature value transmitter, brightness value transmitter, operating mode switchover, switching with forced position), the data format of these objects is defined separately and adapted to the controllable function units of the KNX system.

If a function block is to be used, this must be enabled in the ETS on the parameter page "Function blocks (FB)". The first function block is always intended for application and is thus enabled. Optionally, a function block can also be assigned to a function block group in order to use the function block switch-over. If a function block was enabled, parameters and objects will appear in the ETS function block-dependent.

On the parameter page "FBx - General", the application of a function block (ceiling detector, presence detector, alert operation) can be configured by the parameter of the same name. This parameter - just like the parameter "application type" and "operating mode" - should be configured to the necessary setting at the very start of the device configuration, since all other function block parameters and objects depend on the above parameters.

The different applications of the function blocks 1-5 are described in detail in the following chapters.

Application Ceiling detector

In the application as ceiling detector, the device is normally used in passageways of buildings for switching on the lighting there automatically. Lighting switched on by a ceiling detector is only switched off if there are no persons in the monitored area. In the case of brightness-independent detection, the function is identical to that of a presence detector.

In the ceiling detector function, the function block detects motions and transmits the telegram configured at the beginning of a detection to the bus whenever the measured brightness value is below the set twilight level. At the beginning of a detection, the telegram can be transmitted after a delay (evaluation delay).

If the telegram was transmitted at the beginning of a detection, the device works independently of the brightness. If no more motions are detected, the device transmits the configured telegram to the bus at the end of the detection once the total transmission delay (standard delay 10 s + additional transmission delay) has elapsed.

- i** The light can be switched on and off regardless of a motion detection even if the ceiling detector is disabled, during a manual operation (external motion) and on bus voltage return.

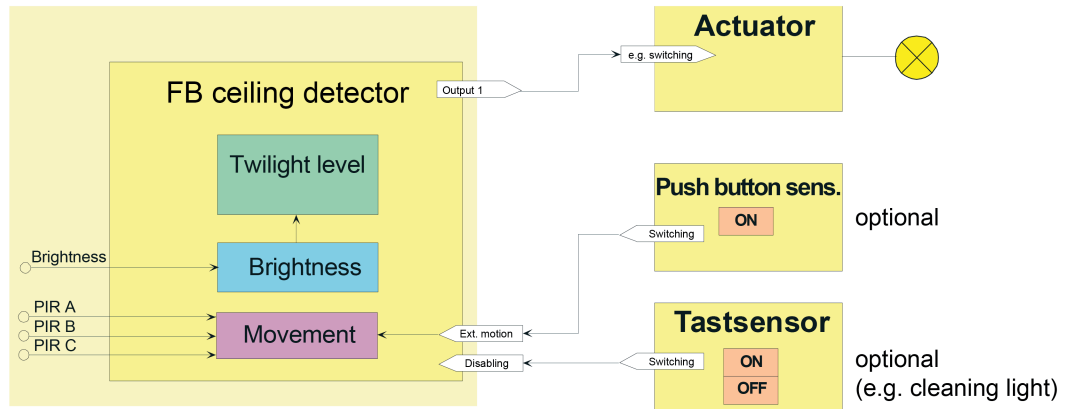

Figure 16: Application example of the application ceiling detector

The brightness level, whereupon motion impulses are transmitted by the ceiling detector if this level is fallen below, is defined by the twilight level. The twilight level is configured in the ETS and can be changed optionally by a Teach function or by external bus presetting. If the determined brightness falls below the twilight value, the ceiling detector switches on the artificial light via the KNX actuator when a motion is detected. The brightness range above the twilight level characterizes the brightness of a room in which the illumination is sufficiently bright and thus no more artificial light has to be switched on. If the ambient brightness is within this range and the device detects a motion, no additional artificial light is then switched on. If the twilight level is configured to "brightness-independent", the artificial light is always switched on when a motion is detected without monitoring the ambient brightness.

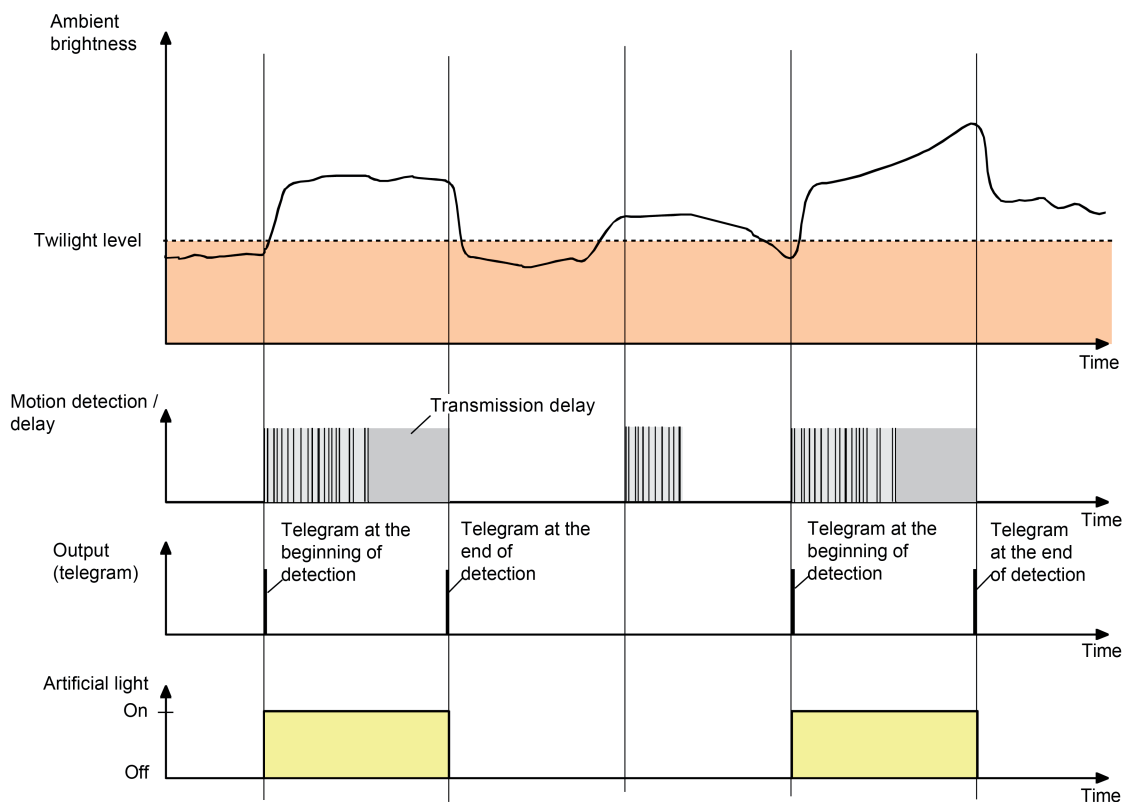

Figure 17: Brightness and motion evaluation with the ceiling detector

Application Presence detector

The application "presence detector" is normally used in areas where people spend longer periods of time (e.g. workplace as well as bathroom/toilet...) for controlling the lighting or heating/ventilation. The device can evaluate slightest motions in this application. Unlike the ceiling detector functionality, in brightness-dependent operation, the brightness is evaluated continuously if the lighting is switched on even during active motion detection. Thus, for example, lighting can be switched off when a defined brightness threshold is exceeded, e.g. by incoming daylight.

Unlike the ceiling detector application, in brightness-dependent motion detection the brightness continues to be evaluated when the lighting is switched on even during active motion detection. If the measured brightness exceeds a defined switch-off threshold (switch-off brightness), no further motions are evaluated and the lighting is switched off after a configured transmission delay has elapsed even during an active motion detection operation.

- i** Regardless of a motion detection, the light can be switched on and off even if the presence detector is disabled, during a manual operation (external motion) and on bus voltage return.

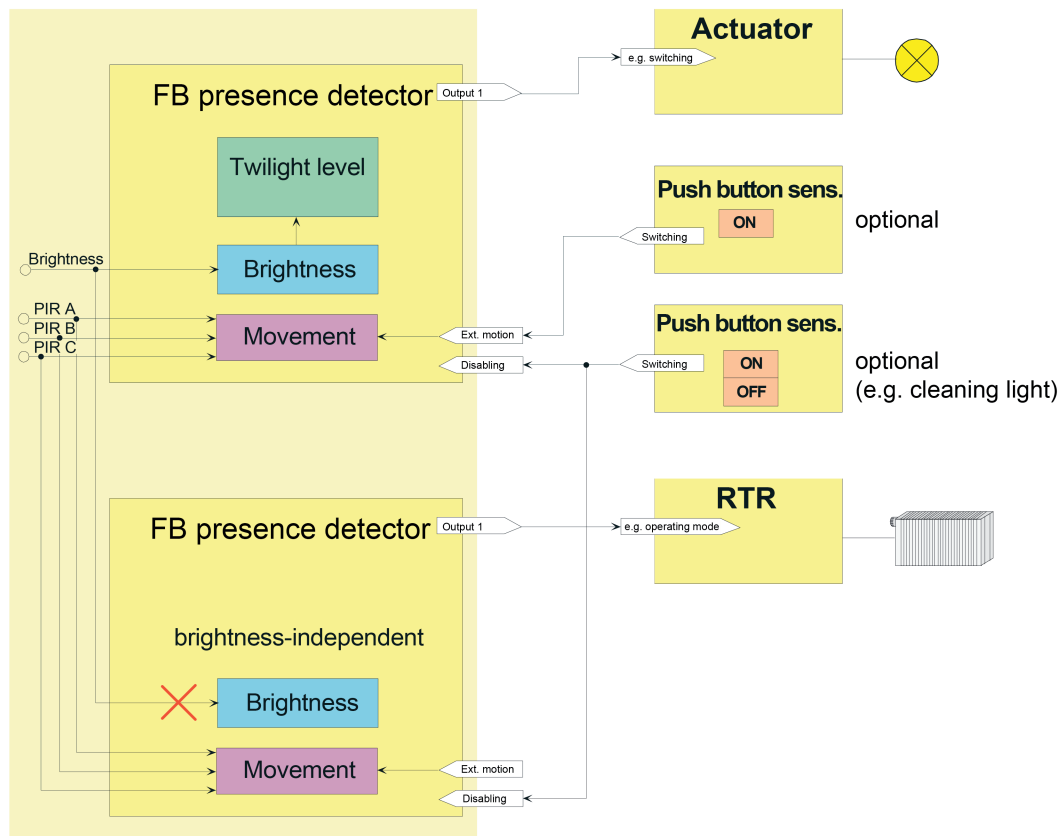

Figure 18: Application example of the application presence detector

A presence detector detects the presence of a person and transmits the configured telegram at the beginning of a detection whenever the determined brightness value is below the set twilight level. The twilight level is configured in the ETS and can be changed optionally by a Teach function or by external bus presetting. The telegram can also be transmitted after a delay (evaluation delay) at the beginning of a detection. If no presence is detected anymore during the further course of the motion detection, the device transmits the configured telegram to the bus once the set total transmission delay (standard delay 10 s + additional transmission delay) has elapsed.

If the measured brightness exceeds the set switch-off brightness during an active presence detection, no further motions are evaluated and the configured telegram is transmitted at the end of the detection after the transmission delay or a separately configurable switch-off delay

has elapsed. The switch-off delay is used for the debouncing of brief light reflexes and prevents faulty switching of the lighting.

The range between twilight level and switch-off brightness characterizes the brightness in the room that the presence detector should adjust. If the ambient brightness is within this range and the device detects a new motion, no additional artificial light is activated. If the twilight level is configured to "brightness-independent", the artificial light is always activated without monitoring the ambient brightness when a presence is detected.

- i** If the presence detection is controlling a heating or cooling system, the brightness signal should not be evaluated (twilight level brightness-independent).

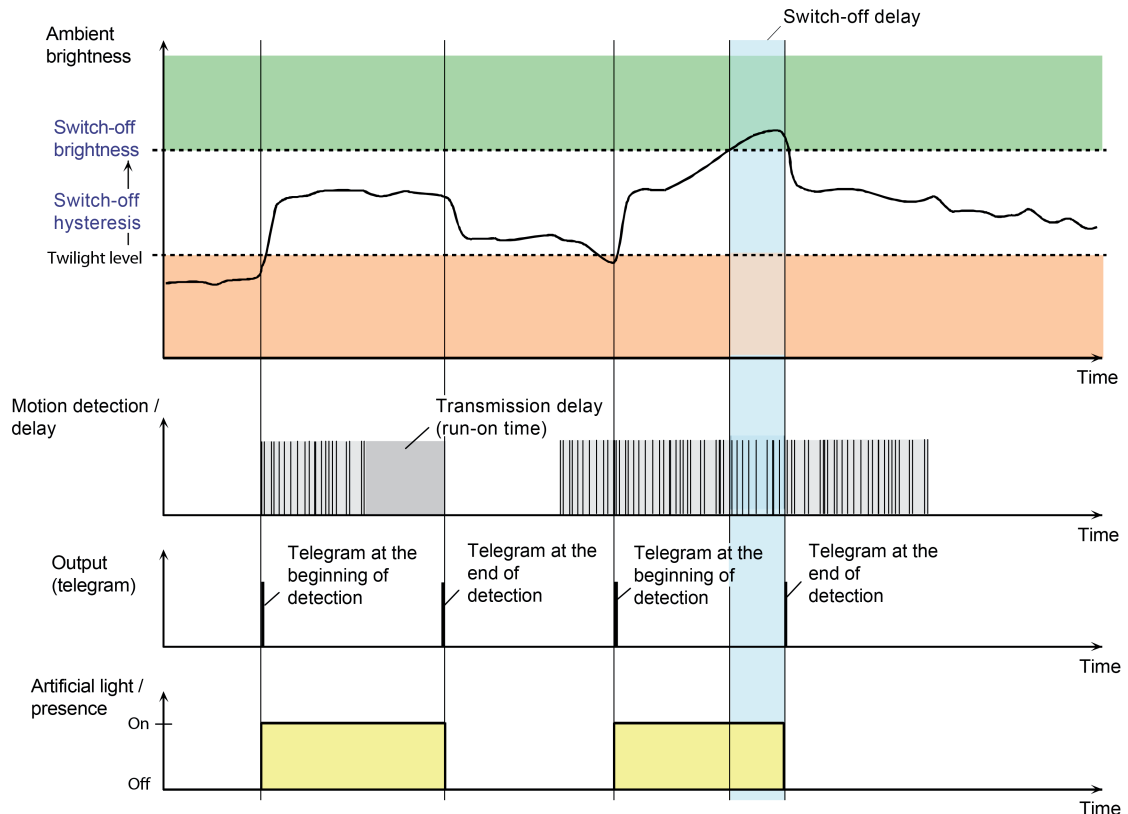

Figure 19: Brightness and motion evaluation with the presence detector

Application Detector

When being used in alert operation, the device always works brightness-independently. Message telegrams signal whether or not people are present in the monitored area. Here, the number of motion impulses can be specified within a monitoring time whereby it is possible to adapt the motion evaluation to individual requirements. A motion is only identified, when the device has detected the set number of motion impulses. This application is appropriate when the device is to be used as a detector for KNX signalling systems.

In alert operation, the device reacts less sensitively to detected motions since a message telegram is only transmitted via the output object after repeatedly polling the motion signal. The configurable number of motion impulses that can occur within a selectable monitoring period is the criterion for triggering a message telegram. A message telegram can be output at the beginning or end of an identified motion.

- i** The alert operation only works as a single device and if necessary transmits a telegram to a central via the output object after detecting and evaluating the motion. The extension inputs or outputs are deactivated in alert operation.

The diagram illustrated below shows the behaviour of the function block in the application Detector. In the example, the number of motion impulses was set to "4".

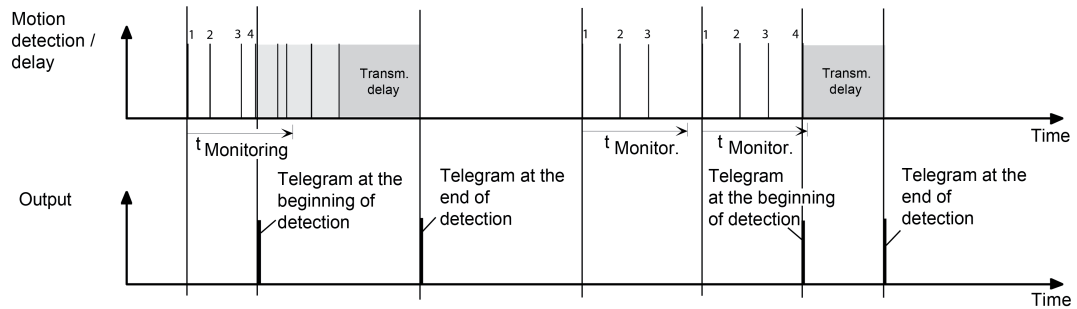

Figure 20: Motion evaluation with the detector

After detection of the fourth motion impulse in the monitoring period ($t_{\text{monitoring}}$), the message telegram "at the beginning of the detection" is transmitted and the transmission delay is started. Further motion impulses within the transmission delay induce the retriggering of the transmission delay. In the absence of motion signals and after the transmission delay has elapsed, the message telegram "at the end of the detection" is transmitted. If less than 4 motion impulses are detected within the monitoring period, no message telegram is triggered. After the monitoring period has elapsed, the next motion impulse is the first of a new monitoring period. When a detection begins (start of the transmission delay), the monitoring period is stopped and reset. The monitoring is restarted again with the first motion impulse after the transmission delay has elapsed.

The following functions are preset on the detector...

- Twilight level: brightness-independent
- Outputs: only output 1
- Teach function: disabled
- Evaluation delay at the beginning of the detection: no
- Cyclical transmission during a detection: possible
- Triggering of a telegram when retriggering: possible
- Additional transmission delay at the end of a detection: possible
- Time extension for additional transmission delay at the end of a detection: not possible
- Disabling function: possible (disabling behaviour preset)
- Extensions inputs and outputs: deactivated

Application Presence detector for light control

In the application Presence detector with light control, the function block "presence detector" is interconnected with the light control in the device. At the same time, the outputs and twilight level evaluation of the function block are deactivated. The brightness evaluation and light control (control of the outputs) are applied exclusively by the light control.

- i The application "presence detector for light control" can only be configured on the first function block!

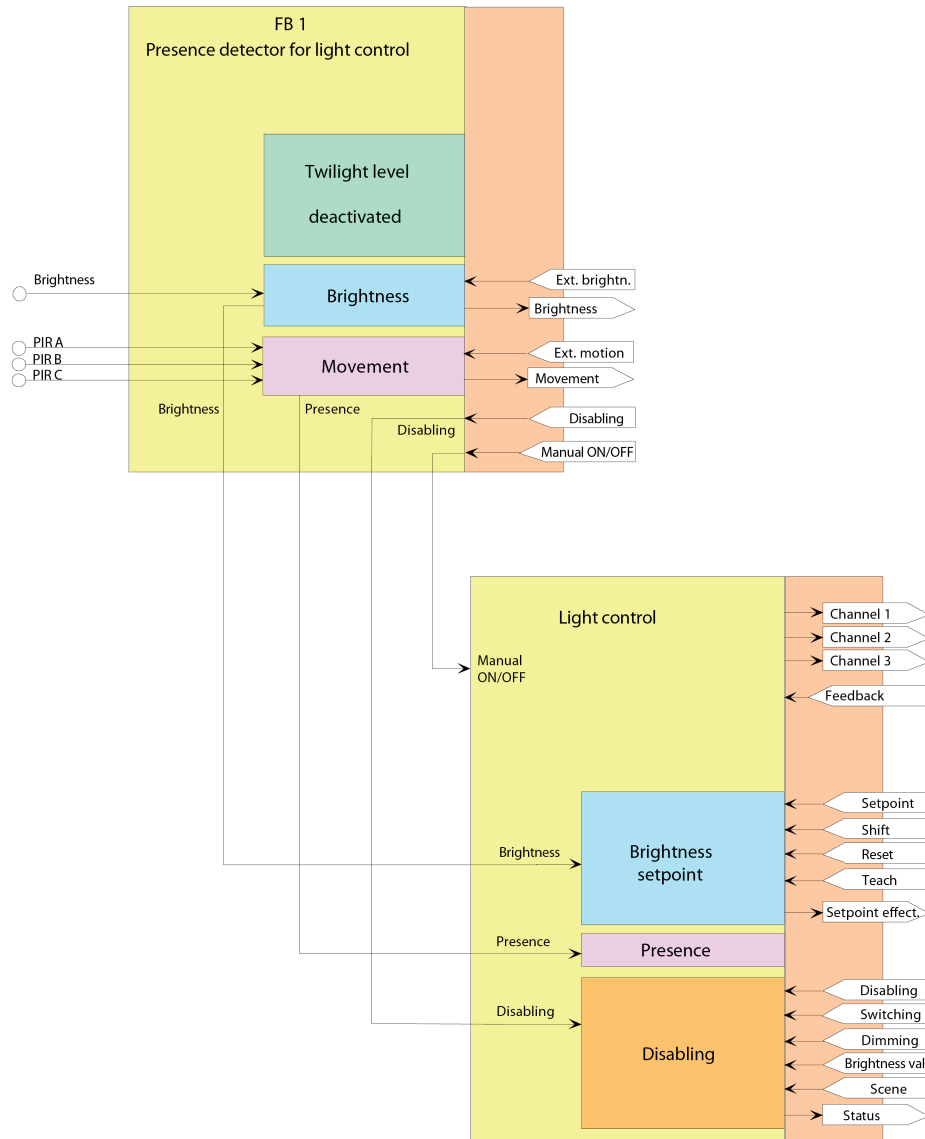

Figure 21: Function elements of the application presence detector with light control

In the case of brightness-independent motion detection, the function block presence detector activates an internal presence signal and starts the transmission delay. The light control is switched on by the active presence signal, which then activates the control channels accordingly with the brightness information of the function block. If no motion is detected by the function block anymore, the presence signal is then cancelled after the transmission delay has elapsed whereby the light control is deactivated and corresponding telegrams are transmitted via the output channels.

The disabling function can be used if required. The disabling function is activated via the function block, which forwards this information internally to the light control.

4.2.4.3.2 Application types

The device can be used as single device, main unit or extension in the applications "ceiling detector" or "presence detector". It is possible to use several devices in a room to extend the detection area by combining a device configured as a main unit with several devices configured as an extension.

The application type of a function block is configured in the ETS by the parameter of the same name on the parameter page "FBx - General". This parameter - just like the parameter "application" and "operating mode" - should be configured to the necessary setting at the very start of the device configuration, since all other function block parameters and objects depend on the above parameters.

A combination of main units and extensions is possible solely with type-identical devices (Jung ceiling detector / presence detector Universal 3361-1) and with the standard device variants (Jung presence detector Standard 3361)! If other devices are used in main unit and extension operation, functional restrictions or malfunctions can be expected!

The different application types are described below.

- i** In the application "presence detector for light control", the device can only be operated in the application type "single device" or "main unit".
- i** In the application "detector", the device only works as a single device.

Application type "single device"

This application type can be set with a ceiling detector or presence detector. The device then works autonomously. A main unit and extension arrangement with other motion detectors or presence detectors is not possible.

Optionally, an external 1-bit motion detection can be supplied to the device, which originates from a pushbutton in the room, for example. This allows the user to control the connected KNX actuator even without a motion detection in the detection area of the device. The evaluation of the external motion signal is possible brightness-dependent or brightness-independent. The 1-bit object input "Lighting manual ON/OFF" is available (see page 81-82) as a further option. The activated KNX actuator can be switched on and also switched off again independent of motion via this input.

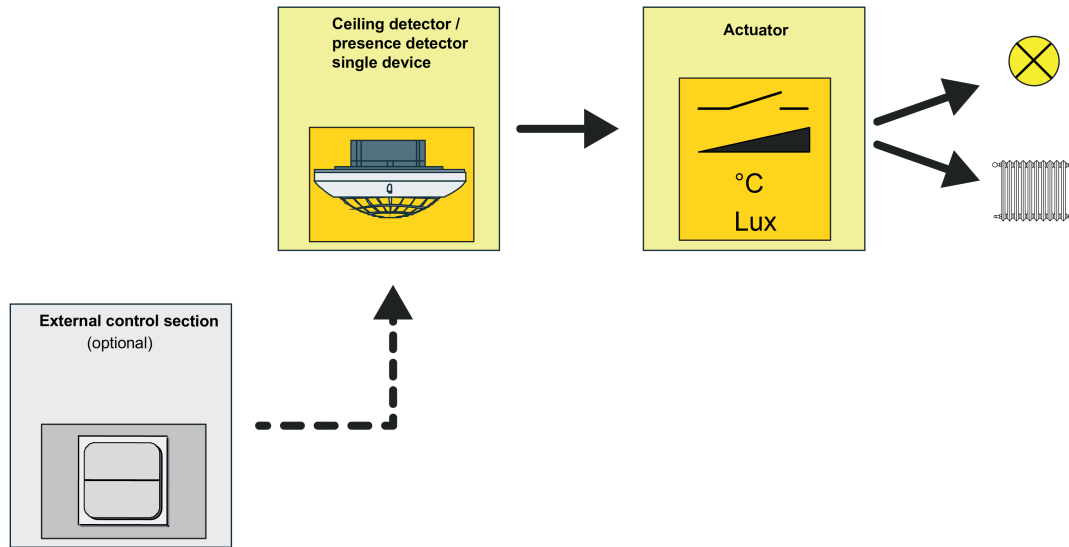

Figure 22: Application type "single device"

Application type "Main unit"

A main unit is used as a central unit in combination with one or more ceiling detectors or presence detectors configured as extensions. The combined main unit and extension(s) execute the motion and presence detection coherently and thus allow any desired extension of the detection area. The extensions combined with the main unit transmit their motion signal to the object "External motion" of the main unit via the same group address (see chapter 4.2.4.3.8. Application examples).

The twilight level evaluation can be made separately in main unit and extension(s) or centrally in the main unit. The twilight level evaluation can be deactivated in the main unit and extension(s) for brightness-independent controls such as temperature value transmitter applications, room temperature controller operating mode switch-overs or ventilation controls. The evaluation of the switch-off brightness for the presence detector always takes place centrally in the main unit. The actuator is controlled exclusively by the main unit. A combination of several main units (affecting the same KNX actuator) is not possible.

With this application type, too, it is possible again to optionally supply the device - parallel to the extensions via the same group address to the object "External motion" - with an external 1-bit motion detection that can be evaluated - depending on the configuration of the twilight level evaluation - in a brightness-dependent or brightness-independent fashion. If user-guided and motion-independent control is required, the manual operating function of the device ("Lighting manual ON/OFF") should be used (see page 81-82).

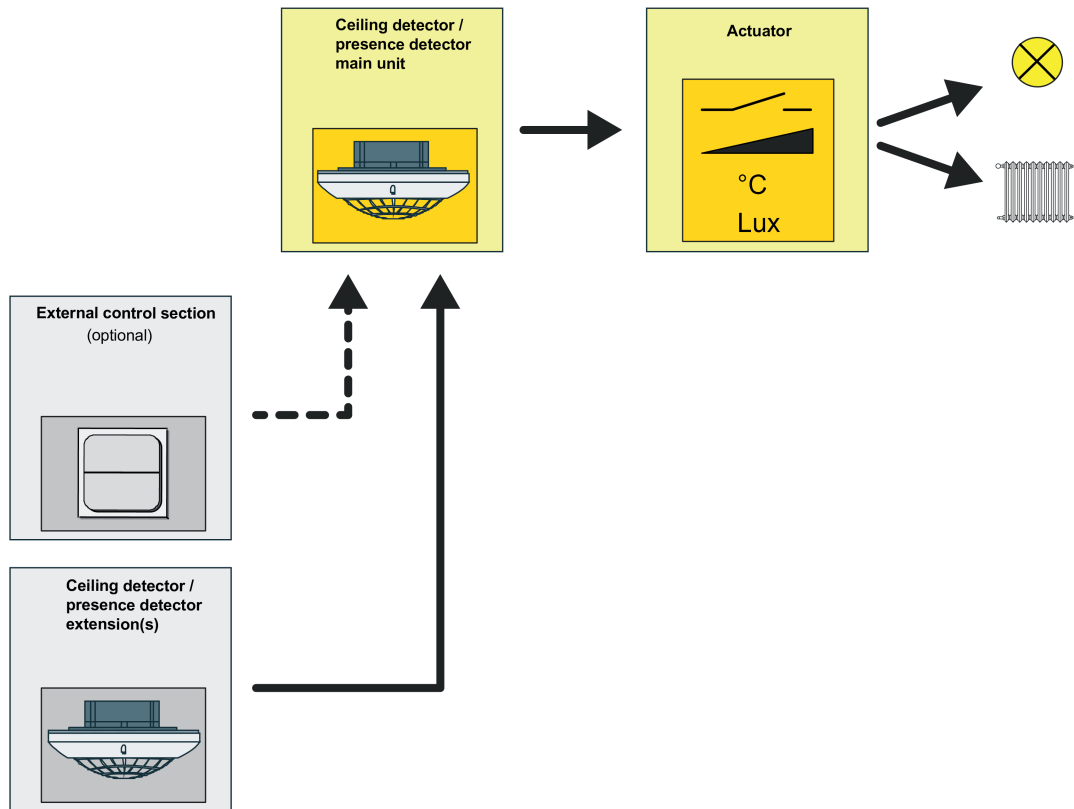

Figure 23: Application type "Main unit"

Application type "Extension unit"

An extension is a subscriber of a combination of several ceiling detectors or presence detectors that coherently execute the motion / presence detection as well as optionally the twilight level evaluation. The extension transmits only one motion detection to one main unit. An extension therefore does not directly control an actuator.

An extension can subject the motion detection to the evaluation of its own twilight level, or alternatively, can work brightness-independently. If the brightness evaluation is activated in the extension, the twilight level must be deactivated by the main unit when switching on the lighting (brightness-independent operation if the lighting is switched on). This takes place - regardless of the data format of the actuator output objects of the main unit - via the object "Deactivation of twilight level" which must be linked to the object of the main unit of the same name (see chapter 4.2.4.3.8. Application examples).

The twilight level evaluation can be deactivated in the main unit and extension(s) for brightness-independent controls such as temperature value transmitter applications, room temperature controller operating mode switch-overs or ventilation controls.

- i The evaluation of the switch-off brightness for the presence detector always takes place centrally in the main unit.

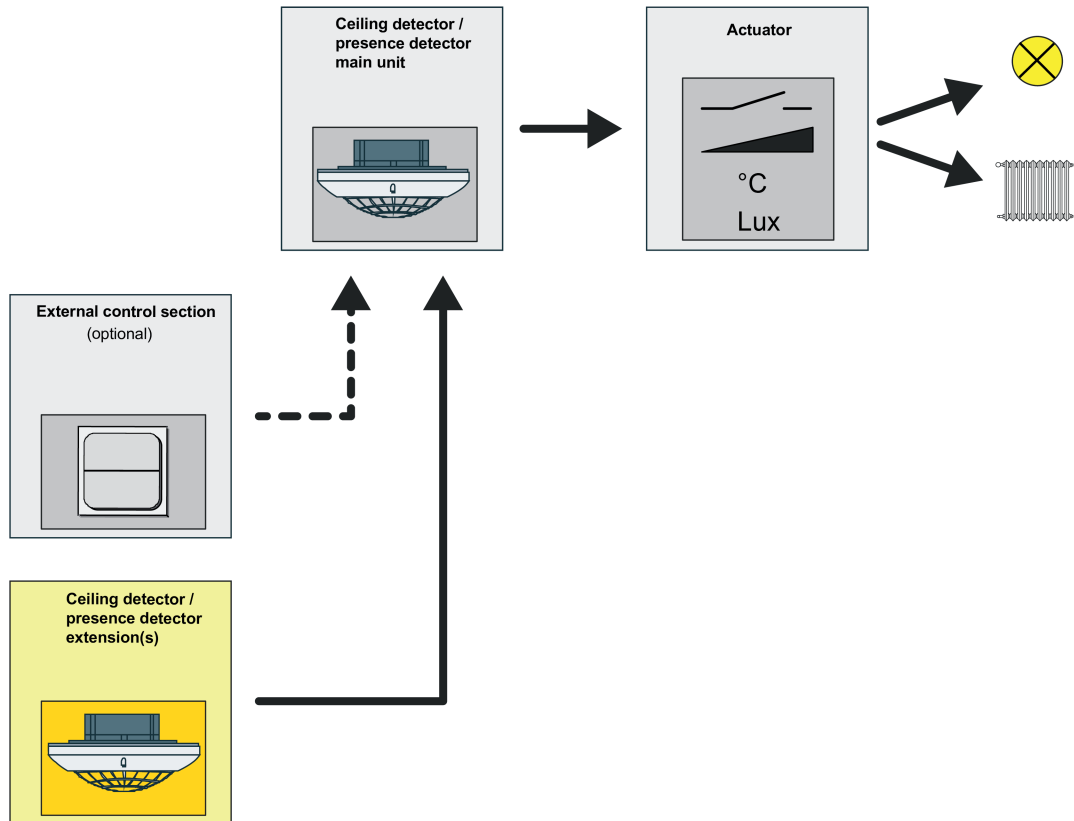

Figure 24: Application type "Extension"

During an active motion detection, the extension transmits motion telegrams cyclically to the main unit via the object "Motion" (figure 25). The cycle time t_1 is configurable in the extension on the parameter page "FBx - Beginning of detection". All extensions must be configured to the same time. The cycle time must be adjusted to the transmission delay (standard delay 10 seconds + additional transmission delay) of the main unit. Within the transmission delay, there must be at least one motion telegram during a continuous motion. To ensure reliable motion evaluation, the cycle time should be slightly less than half of the transmission delay. In the standard configuration, the cycle time is set to 9 seconds. This ensures reliable motion evaluation by the extensions even without additional transmission delay in the main unit. In the case of long transmission delays, it is recommendable to also adapt the cycle time as described in order to reduce the bus load due to the extension motion telegrams. The transmission delay t_2 (active time of the motion evaluation) is preset to 6 seconds in extension operation.

- i When retriggering (new motion within the transmission delay), no motion telegram is transmitted.

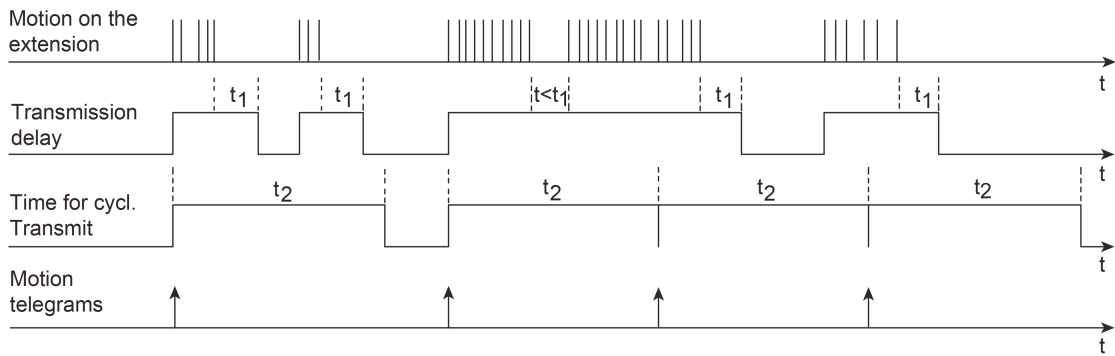

Figure 25: Motion signals of an extension

In this application type, it is not possible to supply external motion detections to the device for implementing a manual operation (e.g. by means of a pushbutton). This is only possible on a main unit.

4.2.4.3.3 Operating mode

In the case of function blocks with the application "ceiling detector" or "presence detector", the operating mode can be configured in the ETS. The operating mode specifies the function of the motion detection and defines whether or not the beginning and the end of a motion detection is identified automatically. Thus, the operating mode can be configured to "Fully automatic" (Automatic ON, Automatic OFF), to "Semi-automatic I" (Manual ON, Automatic OFF) or "Semi-automatic II" (Automatic ON, Manual OFF). This makes it possible to adjust the motion detection to many applications in private and public areas (e.g. toilet lighting, service lighting, control of ventilation systems).

Fully automatic (Auto ON, Auto OFF)

In this operating mode, the outputs of a function block are activated automatically by the motion detection and brightness evaluation. Manual activation of the device is not necessary.

An additional manual operation can take place via the following KNX objects if required...

- "External motion":
This object makes it possible to generate a motion impulse via an external KNX sensor (e.g. pushbutton) with the application types "single device" or "main unit". An extension transmits motion signals in a main unit / extension combination to this input. Similarly, however, it is possible to transmit a 1-bit motion impulse to this object via another KNX sensor in order to trigger the motion detection of a function block. The subsequent evaluation of "real" PIR motion signals and the processing of the delay times then takes place according to the normal pattern.
In the application type "extension", it is not possible to transmit extension signals to the object "external motion". Here, the object for the twilight level switch-over in staircase functions is used. Further information can be found in application examples (see page 83).
- "Lighting manual ON/OFF":
This object can be used directly for the manual operation e.g. via a pushbutton. An ON telegram is evaluated as a brightness-dependent motion detection, whereby the telegrams are always transmitted to the outputs at the beginning of the detection and the transmission delay is started. An OFF telegram transmitted to this object during a current motion detection results in the cancellation of the motion evaluation and termination of the transmission delay, including transmission of the telegrams at the end of the motion. The function block is then in the basic state and ready for a new motion detection. Further information can be found in the chapter entitled "Manual operation" (see page 81-82).
- "Disabling":
This object is used for activating and deactivating the disabling function. This makes it possible to disable the function block and initiate a corresponding action by force (e.g. lighting permanently ON due to cleaning lighting). The normal operation of the function block is only possible again after enabling the disabling function.

Semi-automatic I (manual ON, Auto OFF)

In this operating mode, an ON telegram must first be transmitted to the object "Lighting manual ON/OFF" before a motion (including ext. motion) is detected and evaluated. At the same time, the ON telegram starts the first motion detection including the transmission delay. The end of the detection is identified automatically or initiated by an OFF telegram to the object Lighting manual ON/OFF". Afterwards, a manual ON telegram is required again, in order to evaluate a new motion.

Semi-automatic II (Auto ON, Manual OFF)

In this operating mode, a detection is identified automatically as in the operating mode "Fully automatic". After detection of a motion and output of the telegrams for "beginning of a detection", no transmission delay is started. Thus, the end of the detection can only be achieved by an OFF telegram to the object Lighting manual ON/OFF". The function block is then ready again for a new motion evaluation.

This operating mode is not configurable in the application "presence detector for light control".

4.2.4.3.4 Output functions

Up to two output communication objects are available per function block via which the switching and control commands are transmitted on the bus to the KNX actuator, e.g. lighting system, room temperature control. Depending on the configured function (switching, staircase function, dimming value transmitter, scene extension, temperature value transmitter, brightness value transmitter, operating mode switchover, switching with forced position), the data format of these objects is defined separately and adapted to the controllable function units of the KNX system.

The functions of the outputs are defined separately on the parameter page "FBx - General". Depending on the configuration, the available communication objects and output parameters adapt to the parameter pages "FBx - output 1" and "FBx - output 2". The following functions can be configured...

- "no function":
The output is deactivated. There is no separate output communication object available.
- "Switching":
1-bit switching telegrams (ON / OFF) can be output. Example application: Switching lighting.
- "Staircase function":
1-bit switching telegrams (ON, OFF) are output cyclically in order to trigger the run-on-time in the activated KNX actuator. Example application: Switching staircase lighting
- "Switching with forced position":
2-bit switching telegrams can be output for the forced position of an actuator channel in accordance with DPT 2.001. This makes it possible to set switching states with a higher priority (ON, OFF). Example application: Switching lighting by forced control (cleaning lighting, service light).
- "Dimming value transmitter":
1-byte brightness value telegrams in accordance with DPT 5.001 (0...100 %) can be output. Example application: Dimming lighting.
- "Light scene extension":
1-byte telegrams in accordance with DPT 18.001 (1...64) can be output for the scene recall. Example application: Recall actuator scenes (e.g. TV lighting).
- "Temperature value transmitter":
2-byte temperature value telegrams in accordance with DPT 9.001 (0...+40 °C configurable in 1 °C-increments) can be output. Example application: Preset temperature setpoints.
- "Brightness value transmitter":
2-byte brightness value telegrams in accordance with DPT 9.004 (0...2,000 Lux configurable in 50-Lux increments) can be output. Example application: Preset lighting setpoints.
- "Operating mode room temperature controller":
1-byte telegrams for switching over the operating mode of a KNX room temperature controller in accordance with DPT 20.102 (comfort, standby, night, frost/heat protection, automatic operation) can be output. Example application: Influence room temperature control.

- i** In the application type "extension", no output functions are available. Therefore, these are then only configurable in the main unit.
- i** In the application "detector", only output 1 is active and preset to the detector function (1-bit switching telegrams).

4.2.4.3.5 Sensor assignment

Assignment of the motion sensor

The device detects motions digitally via 3 PIR sectors with a total detection area of 360°, in which each PIR sector covers a subarea of 120°. The function blocks of the device can be assigned as required to the PIR sectors for coordinating the detection area. This is carried out via the parameter "Assignment PIR sector A", "Assignment PIR sector B" and "Assignment PIR sector C" on the parameter page "FBx - Sensor assignment".

The motion signals of all assigned PIR sectors of a function block are logical OR linked and combined to a motion signal.

- i** The sensor sensitivity can be configured collectively for all PIR sectors in the ETS on the parameter page "Motion and light sensor" or adjusted user-defined by the sensitivity adjuster directly on the device.

Assignment of the brightness sensor

The device has a brightness sensor, which is guided laterally from the housing by a light guide on the lens surface of the device for determining workplace brightness or ambient brightness. The brightness value determined by this internal sensor can be supplied to a function block internally for the twilight level evaluation. Optionally, an external 2-byte brightness value in accordance with DPT 9.004 can also be made available to the function block via the bus. This makes it possible to carry out the twilight level evaluation independently of the installation location of the device (e.g. provision of an external brightness value via a more favourably installed extension). In special cases, it is possible to link the determined brightness value of the internal sensor to an external brightness value. In this way, the light measurement of a function block can take place at 2 locations. At the same time, both sensor values are weighted for determining the effective brightness value. The "weighting of the brightness values internal to external" can be configured statically in the ETS.

The parameter "detection of the brightness value by" on the parameter page "FBx - Sensor assignment" defines which sensors are used for the brightness evaluation of a function block.

- i** The brightness value determined by the internal sensor can be supplied to other KNX bus subscribers via the object "Measured brightness value".
- i** In "external" or "internal and external" brightness value detection: In brightness-dependent motion evaluation, a current brightness value must first be present after a device reset before the corresponding function block can work properly. The function block works brightness-independently until a valid brightness value has been received externally! During a weighted brightness value evaluation from an internal and external brightness value, at least one value (internal or external) must be present. No weighting is made as long as only the brightness value of one source is present, but instead the brightness value available is perceived as the effective brightness. If a user calibration of the internal brightness sensor is configured, this must first be executed correctly beforehand so that the internal sensor provides valid brightness values.

4.2.4.3.6 Brightness evaluation

Twilight level evaluation

During the motion detection in the applications "ceiling detector" and "presence detector", the evaluation of the twilight level can take place brightness-independently or brightness-dependently. In the brightness-independent evaluation, no brightness value is taken into account during the processing of a motion. Each motion then triggers a new detection process in the idle state. This configuration, for instance, is interesting for lighting-independent applications (e.g. presence detection for room temperature controls).

In the brightness-dependent evaluation, the measured brightness value in relation to the effective twilight level is taken into account for processing a motion detection. The function block then only detects motions when the measured brightness value is below the set twilight level. This configuration is normally used to control lighting systems in corridors or rooms with some levels of daylight.

The twilight level is preset in the ETS by the parameter of the same name and can be changed by an external twilight level value (via object) or with the Text function in state of operation and thus adapted to the user's needs. An additional setting is possible for the function block 1 via the IR remote control (accessory).

- i** In the application "detector", the motion detection always works brightness-independently.
- i** In the application "presence detector for light control" (only FB1), the brightness detection takes place in the functional unit of the light control. The twilight level evaluation is then deactivated for the first function block.
- i** In the application "presence detector", the brightness in brightness-dependent motion detection continues to be evaluated when the lighting is switched on even during active motion detection. If the measured brightness exceeds a defined switch-off threshold derived from the effective twilight level, no further motions are evaluated and the lighting is switched off after a configured transmission delay has elapsed even during an active motion detection operation. In brightness-independent motion detection (twilight level deactivated), the switch-off brightness is therefore not effective either.

Feedback of active twilight level

The feedback of the twilight level effectively set in the function block is possible via the 2-byte object "Active twilight level" in accordance with DPT 9.004. This object can optionally act as an active signalling object or passive status object. As an active signalling object, the current twilight level brightness value is transmitted once to the bus on each change of the twilight level, after ETS programming or after bus voltage return (optionally delayed).

External twilight level presetting

The currently set twilight level can be reset in accordance with DPT 9.004 by transmitting a 2-byte brightness value to the object "presetting twilight level". This object is configurable if the parameter "object 'presetting twilight level'" is set to "enabled" on the parameter page "FBx - brightness evaluation". The twilight level value received via the object remains unchanged until a new presetting (external twilight level, teach function or IR remote control). Even a bus voltage failure will not reset the twilight level value received via the bus. ETS programming resets the twilight level automatically to the ETS presettings if this is intended in the configuration (see below).

- i** The disabling function has no effect on the external twilight level presetting.

Teach function

Another option for the user-guided twilight level adjustment is the Teach function. With the Teach function, the effective brightness value is applied instantly by transmitting a corresponding telegram to the 1-bit object "Teach twilight level" as a new twilight level value. This object is configurable if the parameter "Use Teach function?" on the parameter page "FBx - brightness evaluation" is set to "yes".

The polarity of a Teach telegram is configurable by the parameter "Polarity for object 'Teach twilight level'". Depending on the configuration, it is possible to reset to the configured twilight level upon receiving the opposite object value (Teach inactive). The twilight level previously learned will be lost in the process. If, however, the Teach polarity is configured to "1"- and "0"-active, it is no longer possible to reset to the configured twilight level via this object during ongoing operation of the device! The new twilight level set with the Teach function remains unchanged until a new presetting (external twilight level, teach function or IR remote control). Even a bus voltage failure will not reset the new twilight level value. ETS programming resets the twilight level automatically to the ETS presettings if this is intended in the configuration (see below).

 The disabling function has no effect on the Teach function.

Twilight level presetting via IR remote control (accessory)

It is also possible optionally to set the twilight level of the first function block via the IR remote control. The procedure for setting the twilight level is described in detail in the chapter entitled "Operation".

Twilight level with external motion detector

With the application types "single device" and "main unit" an external motion signal can be transmitted to the device (with "single device" e.g. from a pushbutton as trigger of a motion detector / with "main unit" from the extensions). If the twilight level evaluation is configured to "brightness-dependent", the evaluation of the external motion detections can be influenced. The parameter "Evaluation of the twilight level with external motion telegram" (with a single device) or "Evaluation of the twilight level" (with a main unit) on the parameter page "FBx - brightness evaluation" defines the behaviour on receipt of a motion telegram.

Setting options with a main unit...

- "only in the main unit":
External motion signals are ignored by the main unit if the brightness is above the twilight level.
- "in main unit and extension":
External motion signals are always evaluated by the main unit even if the brightness is above the twilight level.

Setting options with a single device.

- yes (brightness dependent operation)
External motion signals are ignored if the brightness is above the twilight level.
- no (brightness independent operation)
External motion signals are always evaluated even if the brightness is above the twilight level.

 During a brightness-independent twilight level evaluation, the external motion detections in a single device or main unit are always evaluated.

- i** In the application type "extension", it is not possible to supply external motion detections to the device for implementing a manual operation (e.g. by means of a pushbutton). This is then only possible on the main unit.

Twilight level with ETS programming

The parameter "Overwrite twilight level in device for ETS-download?" determines whether an actively set and active twilight level value by previous external object presetting or by Teach is overwritten automatically by the twilight level configured in the ETS during ETS programming. If the setting is "yes", the last value preset externally or by Teach and still active is replaced by the ETS presetting. If the setting is "no", the last twilight level preset externally or by Teach still remains active even after ETS programming.

- i** If the parameter "Overwrite twilight level in device for ETS-download?" is set to "no" and no external presetting has been made yet - if provided for in the configuration - via the 2-byte object or by Teach after the first ETS commissioning, the device always works with the value configured in the ETS. The ETS parameter only becomes invalid within the above configuration after an external presetting or after a Teach.

Switch-over of the twilight level evaluation in brightness-independent operation

It is possible to switch the twilight level evaluation off and on again via the 1-bit object "Deactivation of twilight level" during ongoing operation of the device. When using main units and extensions, the use of this object is fundamental in order to be able to switch the main units to brightness-independent operation for output functions that are unlike the 1-bit data format. Thus, a distinction must be made between the application types when projecting the object.

- Application type "single device":
The object "Deactivation of twilight level" is an input. A "1" telegram deactivates the twilight level. A "0" telegram re-enables the twilight function evaluation.
After switching over to brightness-independent operation via the object, the application does not switch over again automatically to brightness-dependent operation at the end of a motion detection as would be the case in brightness-independent operation.
- Application type "Main unit":
The object "Deactivation of twilight level" is an input and output.
Use as input: A "1" telegram deactivates the twilight level. A "0" telegram re-enables the twilight function evaluation. After switching over to brightness-independent operation via the object, the application does not switch over again automatically to brightness-dependent operation at the end of a motion detection as would be the case in brightness-independent operation.
Use as output: The main unit controls the switch-over of the twilight level evaluation of the extension(s) via this output depending on its own twilight level evaluation. The application examples in this documentation show this more precisely (see page 83).
Combined use of the object as input and output: If the main unit is switched over to brightness-independent operation (use as input), the object "Deactivation of twilight level" does not control the twilight level evaluation of the extension(s) anymore (output function deactivated). No telegrams are then transmitted automatically anymore from the main unit until it is switched back to brightness-dependent operation! To ensure that the main unit and extension(s) function correctly during switch-over of the main unit to brightness-independent operation, the extension(s) must also be switched over simultaneously to brightness-independent operation via the object "Deactivation of twilight level".
- Application type "Extension":
The object "Deactivation of twilight level" is an input. A "1" telegram deactivates the twilight level. A "0" telegram re-enables the twilight function evaluation.

4.2.4.3.7 Manual operation

The actuator activated by the device can always be operated manually via a KNX pushbutton as well. Since these manual operations cannot be detected by the device, undesirable effects may result in brightness-dependent detection operation.

Example: No motion is detected by manually switched-on lighting because the twilight level is permanently exceeded. As a result, no automatic switch-off by the device takes place either. To prevent this problem, the function blocks FB1...FB5 in the application types "single device" or "main unit" for manual, external operation provide the 1-bit object "Lighting manual ON/OFF". A manual operation via this object is detected by the device and processed accordingly.

Manual operation with application "ceiling detector" and "presence detector" (without affecting light control)

The function of the manual operation is dependent on the configured operating mode...

- Operating mode "Fully automatic (Auto ON, Auto OFF)":
ON telegram to the object "Lighting manual ON/OFF" -> Output 1 and 2 - if configured - transmit the configured telegrams brightness-independent for "beginning of detection" (transmission is forced, an evaluation delay is not taken into account). Additionally, a current motion / presence is simulated thus starting the configured transmission delay. The function block now works like after a detected motion / presence.
Special behaviour of ceiling detector: If no further motion / presence is detected, the device transmits the configured telegrams at the "end of the detection" via outputs 1 and 2 after the transmission delay has elapsed (automatic switch-off). New motion detections retrigger the transmission delay.
Special behaviour of presence detector: If no further motion / presence is detected, the device transmits the configured telegrams at the "end of the detection" via outputs 1 and 2 after the transmission delay has elapsed. New motion detections retrigger the transmission delay. If the switch-off brightness is permanently exceeded when a motion is present, the device transmits the configured telegrams at the "end of the detection" via the outputs 1 and 2 after the configured switch-off delay.

ON telegram to the object "Lighting manual ON/OFF" -> Output 1 and 2 - if configured - always transmit the configured telegrams brightness-independent at the "end of the detection". An active motion / presence detection is deleted. After the configured lockout time, the function block is then ready for a new motion detection.

- Operating mode "semi-automatic I (manual ON, Auto OFF)":
ON telegram to the object "Lighting manual ON/OFF" -> Output 1 and 2 - if configured - transmit the configured telegrams brightness-independent for "beginning of detection" (transmission is forced, an evaluation delay is not taken into account). Additionally, a current motion / presence is simulated thus starting the configured transmission delay. The motion/presence detection is enabled. The function block now works like after a detected motion / presence. If no further motion / presence is detected, the device transmits the configured telegrams at the "end of the detection" via outputs 1 and 2 after the transmission delay has elapsed (automatic switch-off). New motion detections retrigger the transmission delay.
Special behaviour of presence detector: If the switch-off brightness is permanently exceeded when a motion is present, the device transmits the configured telegrams at the "end of the detection" via the outputs 1 and 2 after the configured switch-off delay. After the end of the motion detection (telegrams were transmitted at the end of the detection), the motion/presence detection is disabled.

ON telegram to the object "Lighting manual ON/OFF" -> Output 1 and 2 - if configured - always transmit the configured telegrams brightness-independent at the "end of the detection". An active motion / presence detection is deleted and disabled. The function block must first be activated via an ON telegram to the object "Lighting manual ON/OFF" for a new motion/presence detection.

- Operating mode "semi-automatic II (Auto ON, manual OFF)":
ON telegram to the object "Lighting manual ON/OFF" -> Output 1 and 2 - if configured - transmit the configured telegrams brightness-independent for "beginning of detection" (transmission is forced, an evaluation delay is not taken into account). Additionally, a current motion / presence is simulated, but the transmission delay is not started in this operating mode! To complete the current motion / presence detection and transmit the telegrams at the "end of the detection" via the outputs 1 and 2, an OFF telegram must be transmitted to the object "Lighting manual ON/OFF".

ON telegram to the object "Lighting manual ON/OFF" -> Output 1 and 2 - if configured - always transmit the configured telegrams brightness-independent at the "end of the detection". An active motion / presence detection is deleted. After the configured lockout time, the function block is then ready for a new motion detection.

Manual operation with application "presence detector for light control".

With the presence detector for light control the value of the object "Lighting manual ON/OFF" is transmitted internally to the light control so that corresponding processing can be made. At the same time, an active presence detection is also started.

The behaviour of the light control during a manual operation is described in more detail in the chapter entitled "Light control" (see page 131).

4.2.4.3.8 Application examples

Single device for lighting control with external motion detection

Application example:

Pushbutton on the entrance door of a storage room outside the detection field of the device. When entering the room, the lighting should be switched on user-guided even before the PIR detection area is entered.

Alternative application:

Central switch-on of the lighting devices in an office building in the case of service or cleaning. Automatic switch-off if there are no more motion detections.

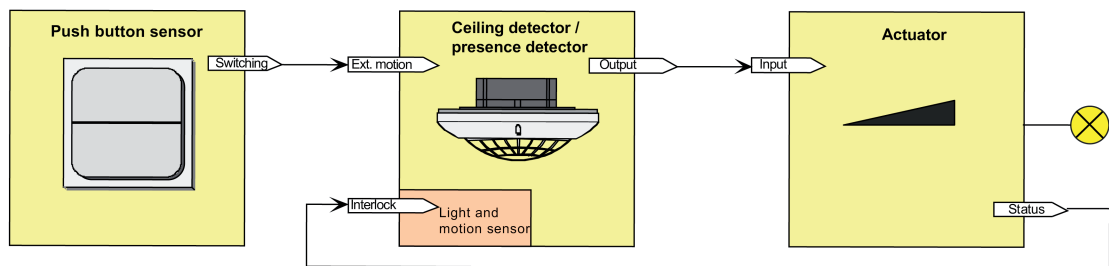

Figure 26: Application example of single device with external motion detection

Depending on the parameter setting "Evaluation of the twilight level with external motion telegram", the signal of the pushbutton is evaluated brightness-dependently (evaluation of the configured twilight level) or brightness-independently. In both cases, the switched-on lighting is switched off again automatically at the end of the motion detection (with appropriate configuration).

Main unit and extension arrangement for lighting control without twilight level evaluation

Application example:

Lighting is to be activated in a room without daylight.

Configuration Main unit:

Evaluation of twilight level = brightness-independent

Configuration Extension:

Evaluation of twilight level = brightness-independent

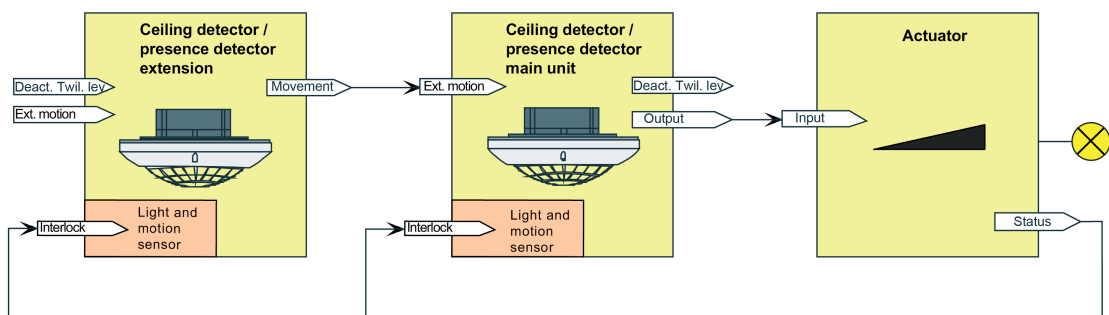

Figure 27: Application example of main unit and extension without twilight level evaluation

The system is configured so that no twilight level evaluation takes place. Consequently, each motion detection of the main unit and extension always results in a telegram output or

retriggering of the transmission delay in the main unit.

Main unit and extension arrangement for lighting control with twilight level evaluation in the main unit

Application example:

Ceiling detector main unit with one or more ceiling detector extensions in a passageway area with daylight. The main unit is mounted optimally so that the daylight can be detected reliably via the brightness sensor of the device. The main unit is mounted optimally so that the daylight can be detected reliably via the brightness sensor of the device. A brightness evaluation on the extensions is not necessary.

Configuration Main unit:

Evaluation of twilight level = brightness-dependent
 Evaluation of the twilight level only in the main unit

Configuration Extension:

Evaluation of twilight level = brightness-independent

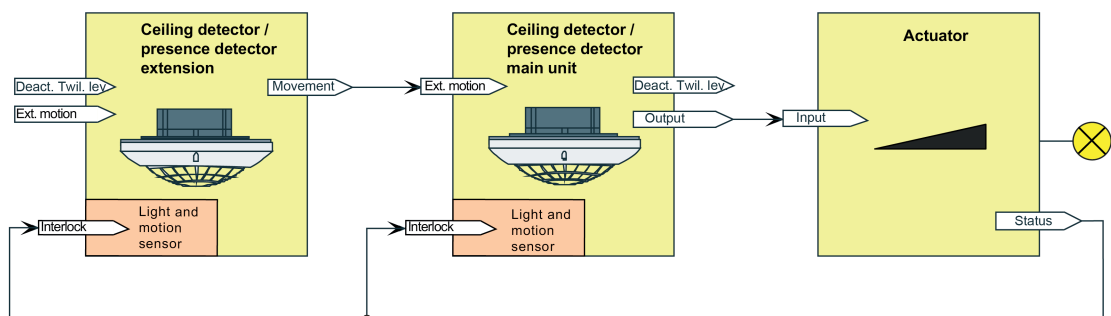

Figure 28: Application example of main unit and extension with twilight level evaluation in the main unit

The system is configured so that the brightness in the room is only detected at the location of the main unit and compared with the twilight level set there. The brightness conditions on the extensions are irrelevant for the control of the lighting conditions. The external motion detection is subject to the twilight level evaluation of the main unit. If it is bright enough on the main unit, motion telegrams of the extensions are discarded. Ideally, the extensions work brightness-independently.

Main unit and extension arrangement for lighting control with twilight level evaluation in the main unit and in all extensions.

Application example:

Ceiling detector main unit with one or more ceiling detector extensions in a staircase or large storage room with various daylight conditions. The devices are mounted on different floors or in different room areas and detect the daylight condition independently of each other.

Configuration Main unit:

Evaluation of twilight level = brightness-dependent
 Evaluation of the twilight level in main unit and extension

Configuration Extension:

Evaluation of twilight level = brightness-dependent

The system is configured so that motion as well as brightness are detected and evaluated at every location (main unit and extensions). The distributed brightness measurement and brightness evaluation is used for controlling the lighting conditions. The motion detectors of the extensions are not subject explicitly to the twilight level evaluation of the main unit only. Thus, each motion telegram results in the triggering of a telegram at the beginning of the detection or in the retriggering of the transmission delay.

In this application example, the twilight level must be controlled between the main unit and extensions. After detection of a motion (regardless of the position) and the resultant switching on of the lighting, the twilight level evaluation must take place brightness-independently until the additional transmission delay has elapsed in the main unit and in all extensions. This ensures that longer-lasting motion processes can still be detected further on by all extensions whereby the retriggering of the transmission delay can take place in the main unit. For this purpose, the main unit must set the twilight levels to "brightness-independent" in the extensions at the beginning of a detection and reset them to "brightness-dependent" after the additional transmission delay has elapsed.

The control of the twilight levels in the extensions must take place differently depending on the configured output function. This is shown by the following application examples...

Example of Output Function "Switching" (KNX Master Slave Solution 1)

In this example, the twilight level evaluation of the extensions is deactivated and activated by the switching output telegram of the main unit. The objects "Deactivation of twilight level" of the extensions can be linked to the same group address as the object "Output x - switching" of the main unit.

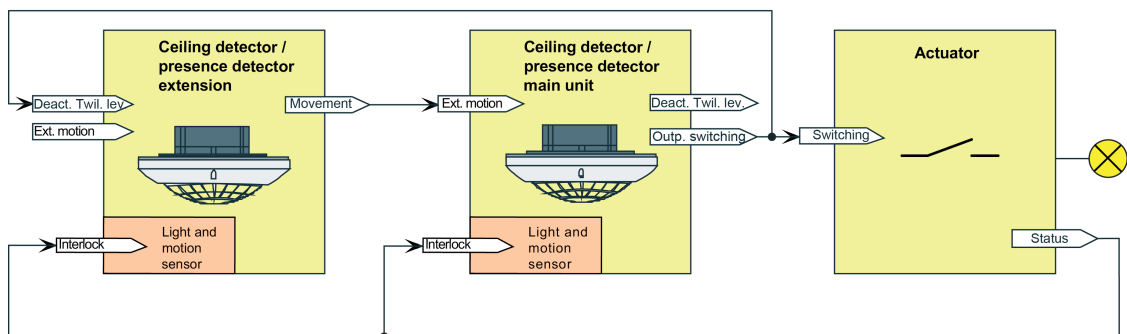

Figure 29: Application example with twilight level evaluation in the main unit and extensions for the data format "Switching"

Case A - Motion is detected by the main unit:

Beginning of the detection: After a motion is detected by the main unit, it transmits an ON telegram to the switch actuator if the twilight level is fallen below so that the lighting is switched on. All extensions receive this ON telegram on their input "Deactivation of twilight level" whereby the extensions switch over to the brightness-independent motion detection and are thus able to detect artificial light if it is now switched on in their own detection area.

End of the detection: After the additional transmission delay has elapsed in the main unit, it transmits an OFF telegram to the switch actuator so that the lighting is switched off. All extensions receive this OFF telegram on the input "Deactivation of twilight level" whereby they switch over again to brightness-dependent motion detection.

Case B - Motion is detected by an extension:

Beginning of the detection: After a motion is detected by an extension, it transmits motion telegrams cyclically to the main unit via the object "Motion" if the twilight level is fallen below. The main unit evaluates the external motion and transmits an ON telegram to the switch actuator so that the lighting is switched on. All extensions receive this ON telegram on their input "Deactivation of twilight level" whereby all extensions switch over to the brightness-independent motion detection and are thus able to detect artificial light if it is now switched on in their own detection area.

End of the detection: If no motion is detected anymore by an extension within its own detection area, the device concerned no longer transmits any motion telegrams to the main unit. As soon as each of the extensions no longer detect motion, motion telegrams are completely absent. The main unit detects the absence of the external motion telegrams and starts the additional transmission delay. After the additional transmission delay has elapsed, the main unit transmits an OFF telegram to the switch actuator, whereby the lighting is switched off. All extensions receive this OFF telegram on the input "Deactivation of twilight level" whereby they switch over again to brightness-dependent motion detection.

Case C - Interlock of the motion evaluation:

When switching off the lighting, it is necessary to interlock the PIR sensor for a certain period of time. It is necessary to prevent incorrect motion detection as a result of thermal change from switching the lamps on and off. The connection of the 1-bit switching status feedback object of the switch actuator (in the case of several activated actuators, only one actuator should ever transmit the status) with the objects "Interlock PIR sensor" of the main unit and extensions serves to activate the lockout time when switching the lighting on or off. The connected actuator must transmit its status actively on change.

Option: If no switching status feedback object is present on the switch actuator, the output object "Switching" of the main unit must be connected with the interlock objects.

Example of output functions "Switching", "Switching with forced position", "Dimming value transmitter", "Light scene extension" and "Brightness value transmitter" (general solution for the lighting control)

In this example, the twilight level evaluation of the extensions is deactivated and activated by the main unit via the object "Deactivation of twilight level". This data format-independent universal solution is not only restricted to the output function Switching. A separate group address must be used for the twilight level control.

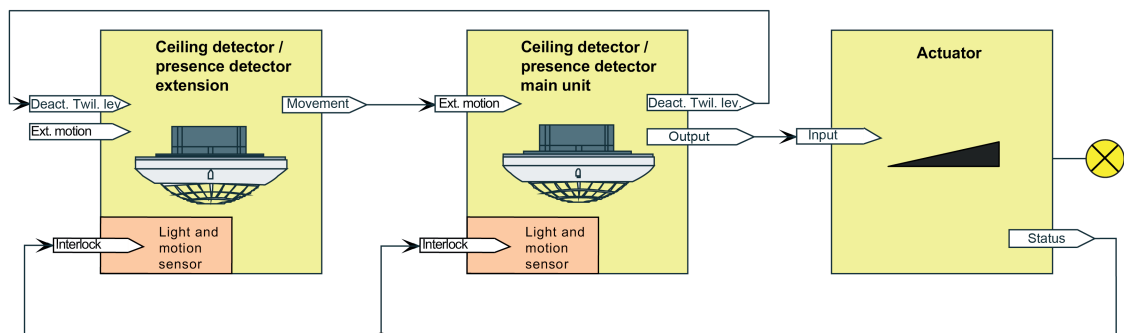

Figure 30: Application example with twilight level evaluation in the main unit and extensions
Universal solution for all data formats

Case A - Motion is detected by the main unit:

Beginning of the detection: After a motion is detected by the main unit, it transmits an ON telegram to the switch actuator via the output object if the twilight level is fallen below so that the lighting is switched on. Additionally, the main unit transmits an ON telegram to all extensions via the object "Deactivation of twilight level" whereby these switch over to the brightness-independent motion detection and are thus able to detect artificial light if it is now switched on in their own detection area.

End of the detection: After the additional transmission delay has elapsed in the main unit, it transmits an OFF telegram to the switch actuator via the output object so that the lighting is switched off. Additionally, it transmits an OFF telegram to all extensions via the object "Deactivation of twilight level", whereby they switch over again to brightness-dependent motion detection.

Case B - Motion is detected by an extension:

Beginning of the detection: After a motion is detected by an extension, it transmits motion telegrams cyclically to the main unit via the object "Motion" if the twilight level is fallen below.

The main unit evaluates the external motion and transmits an ON telegram to the switch actuator via the output object so that the lighting is switched on. Additionally, the main unit transmits an ON telegram to all extensions via the object "Deactivation of twilight level" whereby these switch over to the brightness-independent motion detection and are thus able to detect artificial light if it is now switched on in their own detection area.

End of the detection: If no motion is detected anymore by an extension within its own detection area, the device concerned no longer transmits any motion telegrams to the main unit. As soon as each of the extensions no longer detect motion, motion telegrams are completely absent.

The main unit detects the absence of the external motion telegrams and starts the additional transmission delay. After the additional transmission delay has elapsed, the main unit transmits an OFF telegram to the switch actuator via the output object, whereby the lighting is switched off. Additionally, the main unit transmits an OFF telegram to all extensions via the object "Deactivation of twilight level", whereby they switch over again to brightness-dependent motion detection.

Case C - Interlock of the motion evaluation:

When switching off the lighting, it is necessary to interlock the PIR sensor for a certain period of time. It is necessary to prevent incorrect motion detection as a result of thermal change from switching the lamps on and off. For this purpose, the activated actuators must have a 1-bit switching status feedback object. The connection of the switching status feedback object of the actuator (in the case of several activated actuators, only one actuator should ever transmit the status) with the objects "Interlock PIR sensor" of the main unit and extensions serves to activate the lockout time when switching the lighting on or off. The connected actuator must transmit its status actively on change.

- i** The main unit transmits the telegrams via the object "Deactivation of twilight level" even if the twilight level evaluation is set to brightness-independent.

Example of Output Function "Staircase function" (KNX Master Slave Solution 2)

In the Staircase function, the run-on time (staircase time) of the lighting is configured in the KNX actuator. In this case, the main unit transmits ON telegrams cyclically to the actuator to switch on the lighting for the duration of the motion. If no motion is detected anymore, the main unit transmits no more telegrams to the actuator. In the absence of the ON telegrams, the run-on-time in the actuator is no longer retriggered. After the run-on time has elapsed, the actuator switches off the lighting again.

Even with the output function "staircase function", the twilight level must be controlled between main unit and extension(s). This takes place differently to the previous application examples of other output functions. The twilight level is deactivated and activated in the extension(s) via the object "External motion" whereby the cyclical ON telegrams of the main unit are received. These telegrams are not evaluated as motion, however, but are used for the switch-over of the twilight level evaluation. During the receipt of the cyclical ON telegram, the twilight level evaluation is deactivated. If the ON telegrams of the main unit are absent during the run-on-time, the extensions reactivate the twilight level evaluation. Thus, it is necessary for the extensions to be informed about the actuator run-on time.

For this purpose, the extensions must be configured to the same run-on-time as the actuator. This is possible in each extension, firstly by setting the parameter "Main unit 'staircase function' with run-on time in the actuator?" on the parameter page - "FBx - End of detection" to "yes" and then configuring the parameter "Additional transmission delay" to the necessary run-on-time". Each ON telegram of the main unit retriggers the run-on-time in the extensions.

- i** The configured "additional transmission delay" in the main unit and extensions must be identical and match the run-on time in the actuator so that the twilight level control functions error-free. No "Adaptive additional transmission delay" and no time extension should be configured in the main unit.
- i** The receipt of an "OFF telegram" via the object "External motion" results in the direct activation of the twilight level evaluation (brightness dependent operation) in the extensions.

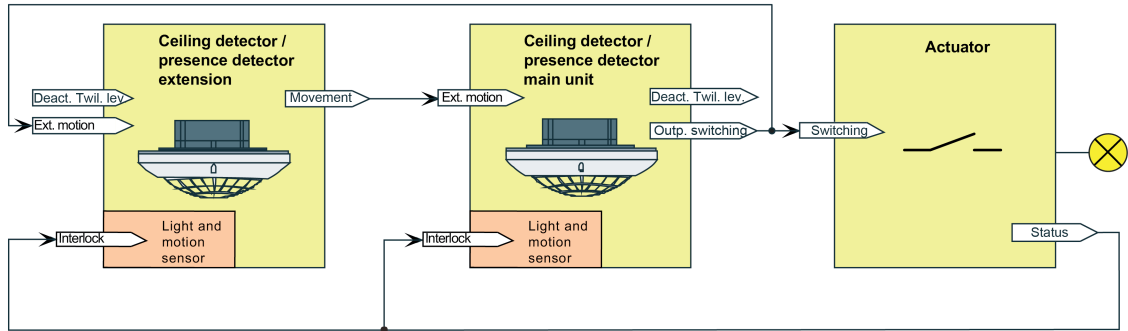

Figure 31: Application example with twilight level evaluation in the main unit and extensions for output function "Staircase function"

Case A - Motion is detected by the main unit:

Beginning of the detection: After a motion is detected by the main unit, it transmits ON telegrams cyclically (cycle time = parameter "Time for cyclical transmission") to the switch actuator via the output object if the twilight level is fallen below so that the lighting is switched on. All extensions also receive these ON telegrams on their input "External motion" whereby these switch over to the brightness-independent motion detection and are thus able to detect artificial light if it is now switched on in their own detection area.

End of the detection: Once the transmission delay has elapsed after the last detected motion, the main unit transmits no ON telegram to the switch actuator anymore so that the lighting is switched off (transmission delay = run-on time of the actuator). In the absence of motion detections in the form of ON telegrams, the extensions change back to brightness-dependent motion detection again.

Case B - Motion is detected by an extension:

Beginning of the detection: After a motion is detected by an extension, it transmits motion telegrams cyclically to the main unit via the object "Motion" if the twilight level is fallen below. The main unit evaluates the external motion and transmits ON telegrams cyclically to the switch actuator via the output object so that the lighting is switched on. All extensions also receive these ON telegrams on their input "External motion" whereby these switch over to the brightness-independent motion detection and are thus able to detect artificial light if it is now switched on in their own detection area.

End of the detection: If no motion is detected anymore by an extension within its own detection area, the device concerned no longer transmits any motion telegrams to the main unit. As soon as each of the extensions no longer detect motion, motion telegrams are completely absent. The main unit detects the absence of the external evaluation telegrams once the configured transmission delay has elapsed after the last detected motion detection and transmits no ON telegram to the switch actuator anymore so that the lighting is switched off after the staircase time in the actuator has elapsed (transmission delay = run-on time of the actuator). In the absence of motion detections in the form of ON telegrams, the extensions change back to brightness-dependent motion detection again.

Case C - Interlock of the motion evaluation:

When switching off the lighting, it is necessary to interlock the PIR sensor for a certain period of time. It is necessary to prevent incorrect motion detection as a result of thermal change from switching the lamps on and off. For this purpose, the activated actuators must have a 1-bit switching status feedback object. The connection of the switching status feedback object of the actuator (in the case of several activated actuators, only one actuator should ever transmit the status) with the objects "Interlock PIR sensor" of the main unit and extensions serves to activate the lockout time when switching the lighting on or off. The connected actuator must transmit its status actively on change.

Main unit and extension arrangement for controlling lighting-independent systems without twilight level evaluation

Application example:

In the lighting-independent output functions, the motion detection in the main units and extensions is normally brightness-independent. Presence detector main unit with one or more

presence detector extensions in an office with various daylight conditions. The devices detect the daylight condition independently of each another.

Configuration Main unit:

Evaluation of twilight level = brightness-independent

Evaluation of the twilight level in main unit and extension

Configuration Extension:

Evaluation of twilight level = brightness-independent

The system is configured so that motion as well as brightness are detected and evaluated at every location (main unit and extensions). The distributed brightness measurement and brightness evaluation is used for controlling lighting-independent systems (e.g. room temperature control -> operating mode switchover, setpoint presetting, presence signal). The motion detectors of the extensions are not subject explicitly to the twilight level evaluation of the main unit only. Thus, each motion telegram results in the triggering of a telegram at the beginning of the detection or in the retriggering of the transmission delay.

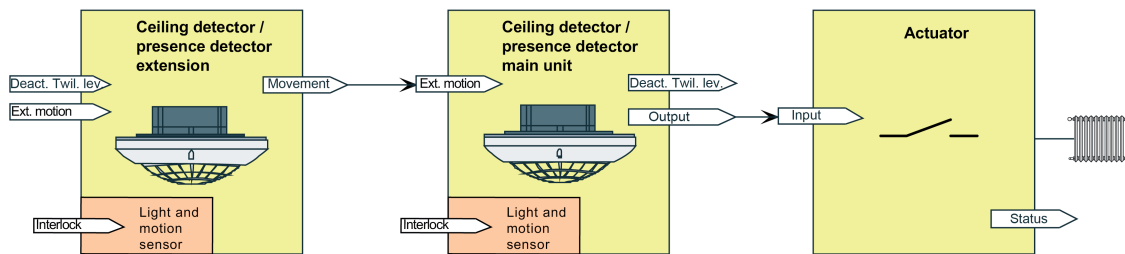

Figure 32: Application example without twilight level evaluation in the main unit and extensions

for output functions "temperature value transmitter" and "operating mode room temperature controller"

Case A - Motion is detected by the main unit:

Beginning of the detection: After the main unit detects a motion, it transmits the telegram to the controller or actuator at the beginning of the detection and triggers actions accordingly (e.g. comfort mode, raised setpoint).

End of the detection: After the additional transmission delay has elapsed in the main unit, it transmits the telegram to the controller or actuator at the end of the detection and retriggers actions (e.g. standby mode, lowered setpoint).

Case B - Motion is detected by an extension:

Beginning of the detection: After a motion is detected by the extension, it transmits motion telegrams cyclically to the main unit via the object "Motion". This detects the external motion and transmits the telegram to the controller or actuator at the beginning of the detection and triggers actions accordingly (e.g. comfort mode, raised setpoint).

End of the detection: If no motion is detected anymore by an extension within its own detection area, the device concerned no longer transmits any motion telegrams to the main unit. As soon as each of the extensions no longer detect motion, motion telegrams are completely absent. The main unit detects the absence of the external motion telegrams and starts the additional transmission delay. After the additional transmission delay has elapsed, the main unit transmits the telegram to the controller or actuator at the end of the detection and triggers actions (e.g. standby mode, lowered setpoint).

4.2.4.3.9 Behaviour at the beginning of a detection

Total motion

A total motion is defined as the time period from the start of the first detection impulse of the PIR sensor (Beginning of the detection) plus the total delay, which is also frequently called run-on-time. The total delay consists of the standard delay (10 seconds) that is always present, which starts immediately after the last active motion signal, and the additional transmission delay that is configurable in the ETS and can optionally be extended via bus telegram. If configured in the ETS, an evaluation delay at the beginning of the detection can be set in order to ignore brief motions.

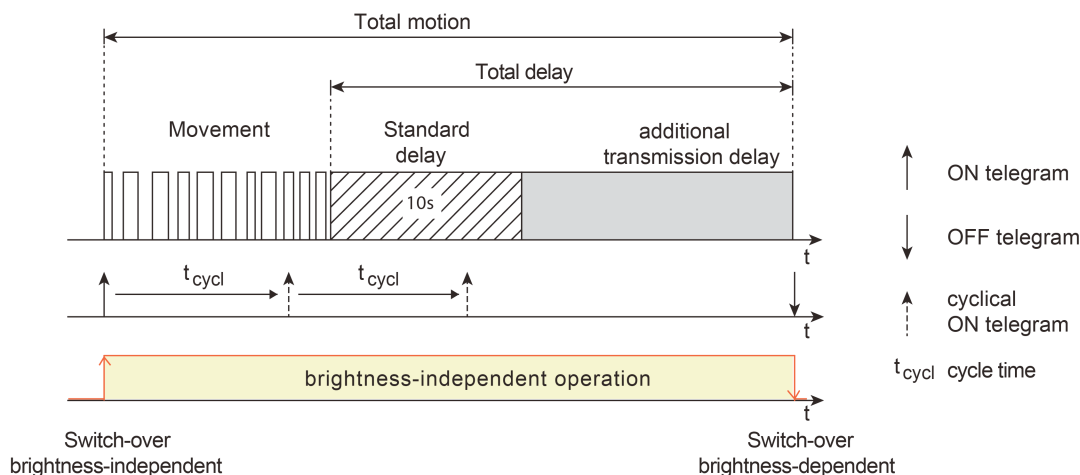

Figure 33: Total motion with motion detection, standard delay and additional transmission delay

Telegrams can be transmitted at the beginning, during and at the end of a motion detection. During a motion detection, the function block concerned is always in brightness-dependent operation in relation to the twilight level. Thus, regardless of the ambient brightness and provided that the switch-off brightness (only in presence detector operation) was not exceeded, the total delay is retriggered for each new motion detection.

It should be noted that the function block is always switched over to brightness-dependent operation at the end of a detection if the twilight level is not set to brightness-independent. Thus, special care should be taken since no motion detections will take place anymore if the ambient brightness is constantly above the twilight level at the end of the detection due to a switched-on light.

Telegram output during a motion detection

The behaviour of outputs 1 and 2 during detection of a motion, depending on the configured output function (see page 76), can be configured separately. In the ETS on the parameter pages of the outputs, it is possible to define for each output whether a new telegram should be transmitted to the bus at the beginning of a new motion detection. The corresponding commands (e.g. switching commands or brightness values) are then configurable depending on the set function. If a telegram should be transmitted at the beginning of a detection, the cyclical transmission during the ongoing motion detection or triggering of a telegram can be configured optionally when retriggering (see below).

The evaluation delay can be configured to prevent the transmission of telegrams for brief motion detections. This makes it possible to transmit the telegrams from output 1 and 2 only during a long longer-lasting motion.

During a motion detection, the cyclical transmission or triggering of a telegram when retriggering can be configured alternatively together...

- **Cyclical transmission:**
 Setting the parameter "Cyclical transmission during the detection?" to "yes", activates the cyclical telegram output during a motion detection. The cyclical output only occurs during detected heat motions and within the standard delay. During an active additional transmission delay, no cyclical transmission takes place.
 If the device detects a new motion again (retriggering) during an ongoing additional transmission delay, the standard delay is restarted and the cyclical telegram output is either resumed (if the last cycle time has not yet elapsed after the previous telegram), or restarted by immediate transmission (if the last cycle time has already elapsed).
 The parameter "time for cyclical transmission" defines the time interval of the telegrams.

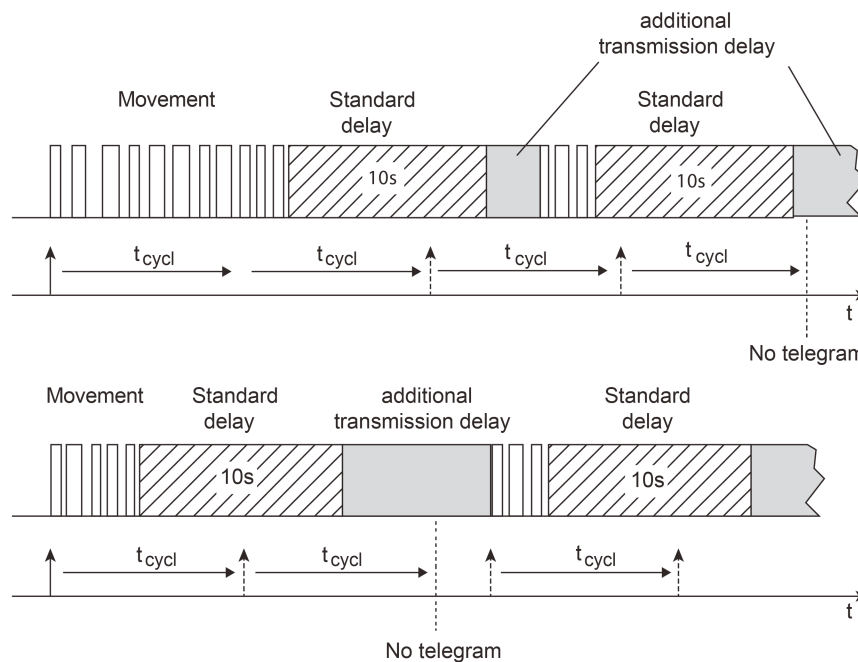

Figure 34: Cyclical transmission during a motion detection

- **Triggering of a telegram when retriggering:**
 If the cyclical transmission is not activated, an output can repeat the telegram at the beginning of the transmission when retriggering. Retriggering takes place when the device detects a new motion during an ongoing additional transmission delay. No telegram is transmitted when retriggering during the standard delay!
 The triggering of a telegram when retriggering is activated in the ETS by the parameter of the same name.

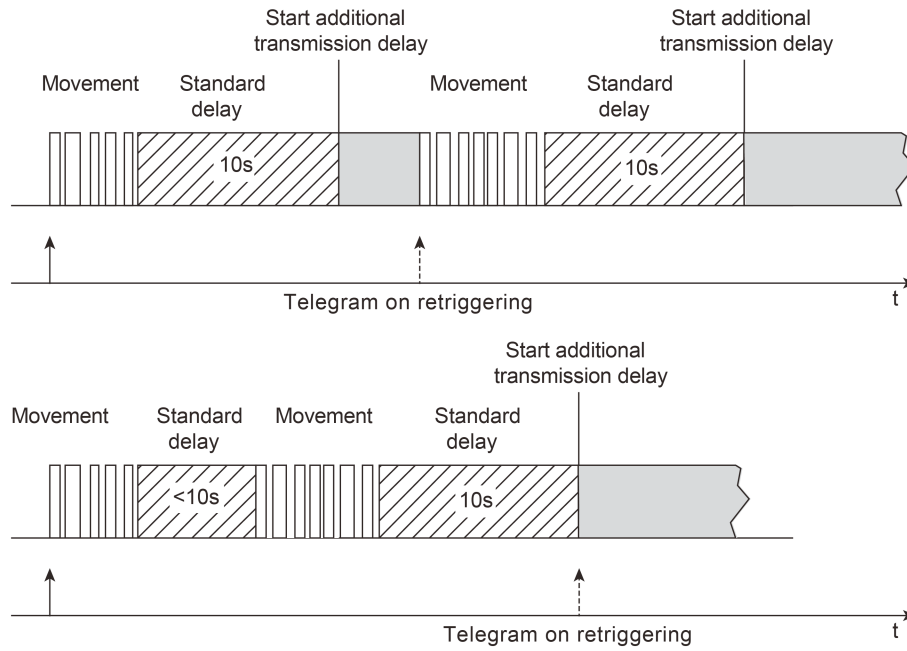

Figure 35: Triggering of a telegram when retriggering

Evaluation delay

The evaluation delay at the beginning of a motion detection ensures that no reaction to just a brief motion (e.g. when quickly striding through a room) takes place. The motion is only processed during a longer-lasting detection and - if configured - the telegram is transmitted at the beginning of the detection. During the detection of the first motion impulse of a new motion, the configured delay time of the transmission delay is initially started. After the delay time has elapsed, a check takes place within a time frame of 30 seconds to determine whether a motion is still present. If an ongoing motion is detected within this monitoring time, the telegram is then transmitted at the beginning of the detection and the transmission delay (possibly retriggering + standard delay 10 s + additional transmission delay) is started (figure 36).

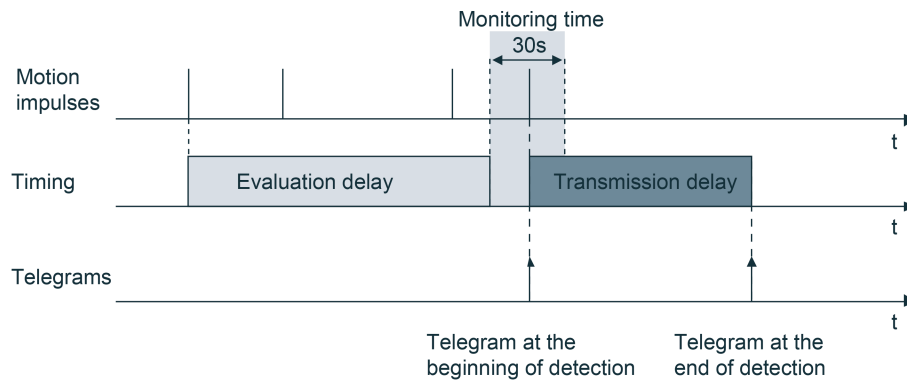

Figure 36: Evaluation delay with ongoing motion

If no motion is detected anymore within the monitoring time, the device transmits no telegram and does not start the standard delay and additional transmission delay either. A newly detected motion after that restarts the evaluation delay (figure 37).

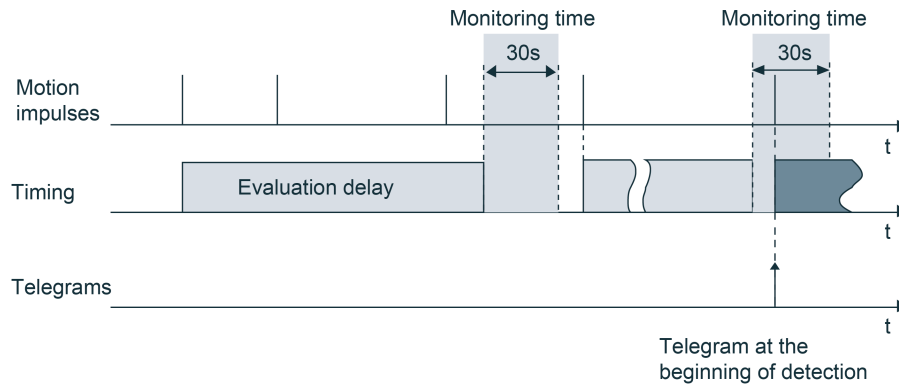

Figure 37: Evaluation delay with only brief motion

- i** The evaluation delay always affects both outputs together as well as external motion detectors.
- i** An evaluation delay is not possible in the operating mode "semi-automatic I (manual ON, Auto OFF)" and in alert operation.

Motion evaluation in alert operation

In the application "detector" the number of motion impulses can be specified within a monitoring time, whereby it is possible to adapt the motion evaluation to individual requirements. In alert operation, the device reacts less sensitively to detected motions since a message telegram is only transmitted via the output object after repeatedly polling the motion signal. The configurable number of motion impulses that can occur within a selectable monitoring period is the criterion for triggering a message telegram. A message telegram can be output at the beginning or end of an identified motion.

The diagram below shows the behaviour of a function block in the application detector. In the example, the number of motion impulses was set to "4".

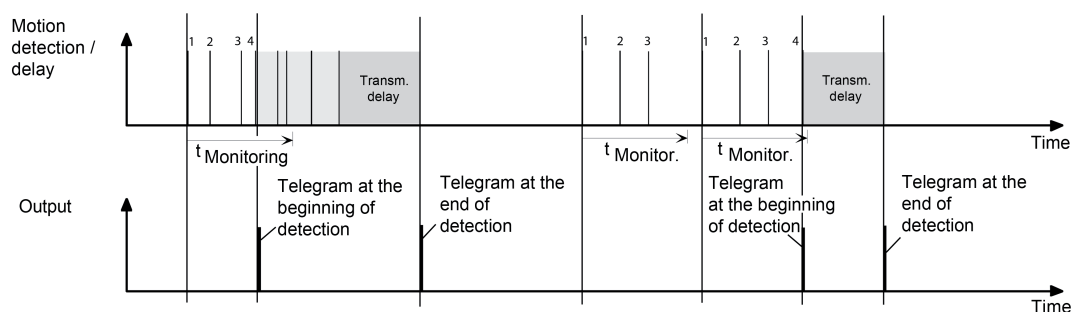

Figure 38: Motion evaluation with the detector

After detection of the fourth motion impulse in the monitoring period ($t_{\text{monitoring}}$), the message telegram "at the beginning of the detection" is transmitted and the transmission delay is started. Further motion impulses within the transmission delay induce the retriggering of the transmission delay. In the absence of motion signals and after the transmission delay has

elapsed, the message telegram "at the end of the detection" is transmitted.

If less than 4 motion impulses are detected within the monitoring period, no message telegram is triggered. After the monitoring period has elapsed, the next motion impulse is the first of a new monitoring period. When a detection begins (start of the transmission delay), the monitoring period is stopped and reset. The monitoring is restarted again with the first motion impulse after the transmission delay has elapsed.

- i A cyclical telegram repetition or the triggering of a telegram when retriggering during an active motion detection is also possible in alert operation.

4.2.4.3.10 Behaviour at the end of a detection

Telegram output at the end of the detection

Just like at the beginning of a detection, a telegram output can be configured for the end of a detection according to the output functions for the outputs 1 and 2. The end of a detection is identified when motion signals are absent and after the total transmission delay elapses (standard delay 10 seconds + additional transmission delay) or when a configured switch-off brightness is exceeded permanently (only in presence detector operation).

Additional transmission delay

A total motion always ends after the standard delay and additional transmission delay elapses. The standard delay time is preset to 10 seconds. The additional transmission delay is added to this time (figure 33).

The additional transmission delay can either be set discretely by parameter in the ETS, or alternatively, calculated by the device by means of self-learning. The parameter "Type of additional transmission delay" on the parameter page "FBx - End of detection" defines how the additional transmission delay is determined...

- Setting "by parameter":

The additional transmission delay is configured in the ETS. Optionally, the time defined there can be extended by a 1-byte factor received via the bus. This makes it possible to dynamically adapt the additional transmission delay user-defined via the bus.

The time extension is possible when the parameter "Time extension for additional transmission delay" is set to "Factor via object". In this case, the device evaluates the value of the object "Factor additional transmission delay" (DPT 5.010) and calculates the additional transmission delay (received factor x configured time).

A newly received factor is first applied actively after a restart or when retriggering the transmission delay. Thus, the time of an ongoing transmission delay is not influenced immediately by a newly received factor. If the function block is inactive when a new factor is received (e.g. disabling function active, deactivated by the function block switch-over, walking test active), the value received is evaluated later during activation of the function block. After ETS programming or after bus voltage return, the device always works with the factor "1" (-> additional transmission delay = parameter value) until an object value is received.

- Setting "adaptive":
With this setting, the device determines the additional transmission delay independently, depending on the frequency of the motion impulses within a range defined by the user. The adaptive adjustment should be selected if the objectives and tasks listed below are to be fulfilled using the device (optimization strategies)...

- Increased user comfort & lamp protection: A high level of user comfort can be achieved especially when used as a presence detector if constant switching off and on again is avoided. The maximum transmission delay possible guarantees the best comfort here. An adaptive additional transmission delay makes it possible for the device to incorporate recurring motion signals into the calculation of the transmission delay during a motion evaluation and thus prevent the lighting from being switched off too early. If light bulbs are frequently switched off and on again, this often additionally reduces their service life. The maximum transmission delay possible guarantees long service life of the light bulbs.

- Energy efficiency: It is always possible to control the lighting or load in an energy-efficient manner when the switch-on time, which is directly is proportional to the consumed energy, can be minimized adequately. The device is able to identify recurring brief presence or motion detections, while keeping the delay-time to a minimum without any loss in comfort.

The device always calculates the additional transmission delay dynamically during an adaptive adjustment. In this case, no constant value can be derived by the user. In reality, the additional transmission delay is adjusted constantly and attuned to the frequency of the motion signals. While doing so, the device only extends the time during a motion evaluation. The delay is only reduced internally if no motion evaluation takes place.

The limits of the dynamic time adjustment can be configured in the ETS. In the case of adaptive adjustment, the parameters "minimum additional transmission delay" and "maximum additional transmission delay" are provided for this purpose. The self-learning behaviour can either be forced more in the direction of user-comfort / lamp protection or energy efficiency by means of a specific parameter setting of the minimum and maximum value. The dynamic range selected for these optimization strategies should be as narrow as possible. If the user or installation engineer does not want to or cannot do this, the dynamic range should alternatively be defined as wide as possible. In the optimization that is then fully automatic, the device can adapt optimally to the current motion pattern.

Applicable for the total delay: $T_{min.} \leq T_{dyn.} \leq T_{max.}$
 $T_{min.}$ = Standard delay (10 s) + "Minimum additional transmission delay"
 $T_{max.}$ = Standard delay (10 s) + "Maximum additional transmission delay"
 $T_{dyn.}$ = dynamically determined additional transmission delay

The table below shows how the limits of the minimum and maximum values should be selected depending on the desired optimization strategy...

Optimization strategy	Minimum additional transmission delay	Maximum additional transmission delay	Dynamic range
User comfort / Lamp protection	high	high	narrow
Energy efficiency	low	low	narrow
none (fully automatic adjustment)	low	high	wide

Parameter setting for the different optimization strategies

The device has an early switch-off detector during the adaptive adjustment of the additional transmission delay. In this process, the device evaluates the time interval between the end of a previous detection (OFF) and the beginning of a new motion evaluation (ON). If the time between switch OFF and switch ON again is shorter than 10 seconds, the transmission delay

last calculated is evaluated as "too short to calculate". In this case, the device extends the transmission delay immediately to prevent a repeated early switch-off.

Optionally, the device can evaluate a brief presence during adaptive adjustment of the additional transmission delay. Brief presence detection is an interesting option in presence detector operation, for example, for preventing immediate activation of a long run-on-time when the motion area is entered briefly (e.g. just quickly taking the office key from the desk). The device identifies whether or not a detected motion is brief by means of the defined time in the ETS parameter "time window recognition of a brief presence". This parameter is only visible if the parameter "Evaluation of brief presence" is set to "yes" on the parameter page - "FBx - End of detection". The brief presence evaluation is then activated as well.

Upon the first motion signal of the new motion, the device starts the configured time window. Motions within the time window are evaluated as brief presence. If additional motions also continue to occur after the time window has elapsed, the device discards the brief presence and works normally with the determined additional transmission delay. If, however, no motions occur anymore beyond the configured time window, the device assumes a brief presence and merely starts the "minimum additional transmission delay".

- i** The "minimum additional transmission delay" configured in the ETS should be at least three times as long as the configured time window for the brief presence so that a brief presence can be evaluated reliably.
- i** The brief presence detection, if activated in the ETS, is processed in parallel to the self-learning of the additional transmission delay and does not influence the process and value of the adaptive time calculation. If a brief presence is detected, this is given one-time priority over the self-learning, i.e. the device processes the brief presence and ends the motion detection early.
- i** The brief presence detection will not take effect in the event of a new motion after an early switch-off has been identified.

Switch-off brightness presence detector operation

The switch-off brightness in presence detector operation (only with the application types single device and main unit) is defined for brightness-dependent operation via the parameter "Hysteresis for switch-off brightness of presence detector" on the parameter page - "FBx - End of detection". The switch-off brightness is calculated as follows (figure 19):
Switch-off brightness = effective twilight level + switch-off hysteresis (in Lux).

If the measured brightness exceeds the set switch-off brightness during an active presence detection, no further motions are evaluated. The device then transmits the configured telegram at the end of the detection after the effective transmission delay, or alternatively, after a separately configurable switch-off delay has elapsed. The parameter "Transmission delay upon reaching the switch-off brightness" determines the type of delay time in this case.

The delay upon reaching or exceeding the switch-off brightness is used for the debouncing of brief light reflexes and prevents faulty switching of the lighting.

If the switch-off brightness is fallen below again before the delay has elapsed, the device then cancels the switch-off process. Detected motions then retrigger the transmission delay.

- i** In brightness-independent detection, no "switch-off brightness" can be configured.

Teach function for switch-off brightness

The teach function makes it possible to preset the switch-off brightness externally. This function can be used by the ETS in parallel to the presetting of the switch-off brightness and allows for user-guided adjustment of the switch-off brightness to the light bulb used. With the Teach function, the currently measured brightness value is applied instantly by transmitting a corresponding telegram to the 1-bit object "Teach switch-off brightness" as a new switch-off brightness. This object is configurable if the parameter "Teach function for switch-off brightness" is set to "enabled" on the parameter page "FBx - End of detection". The polarity of a Teach telegram is configurable by the parameter "Teach operating mode". Depending on the configuration, it is possible to reset to the configured switch-off brightness upon receiving the opposite object value (Teach inactive). The switch-off brightness previously learned will be lost

in the process. If, however, the Teach operating mode is configured to "1"- and "0"-active, it is not possible anymore to reset to the configured switch-off brightness via this object during ongoing operation of the device! The new switch-off brightness set with the Teach function remains unchanged until a new Teach process. Even a bus voltage failure will not reset the new switch-off brightness.

- i** The Teach function sets an absolute brightness as switch-off brightness. When the twilight level changes, the switch-off brightness set via the Teach function remains unchanged in contrast with the configured switch-off hysteresis. If the configured switch-off hysteresis is active, the resulting switch-off brightness (twilight level + switch-off hysteresis) changes according to the twilight level set.
- i** If the Teach function learns a switch-off brightness that is too low, this will cause a light swing during operation (the lighting is switched on and off permanently). This will also happen if the switch-off brightness is below the twilight level. The same applies if after setting the switch-off brightness, the twilight level is adjusted in such a way that the interval between the twilight level and switch-off brightness is too low.
- i** The disabling function has no effect on the Teach function.

The parameter "Overwrite switch-off brightness in device for ETS-Download?" determines whether a switch-off brightness preset by Teach is overwritten automatically by the switch-off brightness configured in the ETS during ETS programming. If the setting is "yes", the last switch-off brightness preset by Teach and still active is replaced by the ETS presetting. If the setting is "no", the last switch-off value preset by Teach still remains active even after ETS programming.

- i** If the parameter "Overwrite switch-off brightness in device for ETS-Download?" is set to "no" and no Teach has taken place yet - if provided for in the configuration - , the device always works with the ETS configured value. The ETS parameter in the above configuration only becomes invalid after a Teach.

Measurement time period after last motion

In brightness-independent operation, a function block can - depending on the configured operating mode - determine the time period after a last motion and transmit it to the bus via a communication object. This function, for example, allows simple monitoring of people's movements in assisted living or in a senior citizens' residence.

The function is activated if the parameter "Measurement of time interval after the end of the last motion" is set to "activated" on the parameter page "FBx - End of detection".

If the function is enabled, the device starts the timer immediately after a motion detection (motion signal + standard delay). The current counter value is tracked in the 2-byte communication object "Time after last motion" in the data format "minutes" in accordance with DPT 7.006. This object can act as an active signalling object, or alternatively, as a passive status object. As an active signalling object, the device transmits the current counter status cyclically to the bus. The cycle time can be configured in the ETS.

During an active motion or ongoing standard delay, the counter value is always "0".

When the device detects a new motion, it resets the current counter status immediately to "0". In the case of an actively transmitting signalling object, it should be noted that the current counter status will only be transmitted again after the cycle time has elapsed. If the current counter status has reached the maximum value "65,535", the device keeps this value until reset by a new motion detection of the counter.

During the new startup of the function block (e.g. after ETS programming, after bus voltage return, after a function block switch-over. during the deactivation of the disabling function, after a walking test), the counter is always reset. Additionally, the value "0" is transmitted and the time restarted for the cyclical transmission during active transmission of the signalling object.

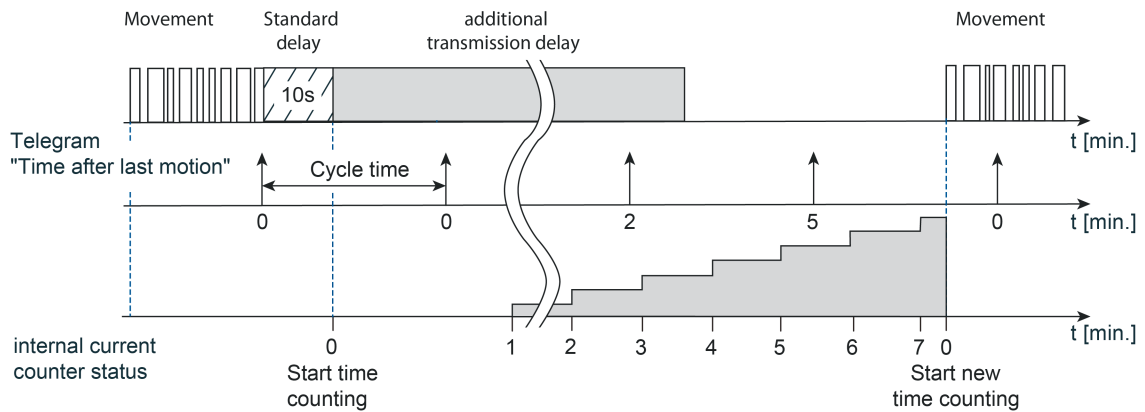

Figure 39: Measurement of the time period after last motion

- i** Only for the first function block: During an operating mode presetting "ON" or "OFF" via the IR remote control (accessory), the counter is always reset and the telegram output stopped. After activation of the operating mode "Auto", the telegram output is restarted again.
- i** If the twilight level evaluation is configured to "brightness-dependent" or the operating mode is configured to "Semi-automatic II (manual ON, Auto OFF)", the device cannot evaluate the time interval after the last motion. In these cases, the function is not configurable.

4.2.4.3.11 Disabling function

Disabling function for the autonomous operation of a function block

A function block can be disabled and enabled via a disabling function. A disabled function block has no function. The disabling function is activated and deactivated via the object "FBx - Disable input" in which the telegram polarity is configurable. It is also possible to activate the disabling function after bus voltage return or after ETS programming.

As soon as the device receives a disabling telegram, the disabling function is activated immediately. As a result of this, an active motion detection is stopped without transmitting the telegram at the end of the detection,

Behaviour at the beginning of the disabling function

A telegram can be transmitted separately at the beginning of the disabling function via each output (according to the configured function) for the application types "single device" and "main unit". The parameter "Behaviour at the beginning of the disabling function" on the parameter page "FBx - Disable" defines whether a telegram is transmitted.

In the application "Alert operation" or in the application type "Extension", a telegram output is not provided for at the beginning of the disabling function. Here, the function block is merely interlocked.

On activation of the disabling function, ongoing transmission delays and switch-off delays are stopped and reset. The current state (motion active/inactive) of the motion detection is frozen and saved (see "Behaviour at the end of the disabling function").

Behaviour during the disabling function

During an active disable, no motion detection and telegram output takes place via the outputs. External motion telegrams from extensions and telegrams for the manual operation are ignored.

The following functions are not influenced by the disabling function and continue to be active...

- Teach function for changing the twilight level,
- Presetting of the twilight level via the object "Pressing twilight level",
- Presetting of a factor for the additional transmission delay via the object "Factor additional transmission delay".

Repeated disabling telegrams (disabling function active after disabling function active) received during an active disable cause the device to execute the disabling reaction again (repeat of the configured behaviour at the beginning of the disabling function).

Behaviour at the end of the disabling function

The "Behaviour at the end of the disabling function" is configurable by the parameter of the same name as follows...

- Setting "enable and send no telegram":
The motion state is set to "no motion" (transmission delay not active). No telegrams are transmitted.
This setting is unalterably active in the application type "extension" or in the application "detector".
- Setting "enable and reaction as at end of a detection":
At the end of the disabling function, the behaviour at the "end of a detection" configured in the ETS is executed for each output (including telegram output) in order to restore the basic state of the actuator. The motion state is set to "no motion" (transmission delay active). After the configured lockout time has elapsed, the function block is then ready again - if the actuator activates the lockout - for a new motion detection.

- Setting "enable and reaction as at beginning of a detection":
At the end of the disabling function, the behaviour for "beginning of a detection" configured in the ETS, is executed for each output. For this purpose, a motion detection is simulated (including beginning of the transmission delay) whereby the telegrams are transmitted at the beginning of a detection. If no further motion is detected, the device processes the end of the detection after the transmission delay has elapsed (automatic switch-over to the basic state).
 - Setting "enable and state as before the disabling function":
To restore the state to how it was before the disabling function, the stored state of the motion detection is evaluated (see "Behaviour at the beginning of the disabling function"). The output then reacts as follows...
Motion state was "no motion" -> Behaviour as "enable and reaction as at end of a detection".
Motion state was "Motion/presence present" -> Behaviour as "enable and reaction as at beginning of a detection".
- i** If a disabling function is not activated, the receipt of an enabling telegram is discarded and does not trigger the behaviour at the end of the disabling function.
- i** In brightness-dependent motion detection, attention must be paid to the state of the lighting at the end of the disabling function. If the lighting is on, a motion detection might not be possible again anymore (the function block no longer responds). The lighting can then still only be switched off manually.

Disabling function for the operation of a function block in combination with the light control (only for FB1)

As in autonomous operation, the first function block can also be disabled in the application "Presence detector for light control". Here too, the disabling function is activated and deactivated via the object "FBx - Disable input" in which the telegram polarity is configurable. As soon as the device receives a disabling telegram, the disabling function is activated immediately. As a result of this, an active motion detection is stopped.

Behaviour at the beginning of the disabling function

If the disabling function is activated, the transmission delay is stopped and reset. The current state of the motion detection is frozen and saved. The activation of the disabling function is transferred to the function block light control. The reaction of the light control is defined by its parameters (see page 128-129).

Behaviour during the disabling function

During an active disable, no motion detection takes place. External motion telegrams from extensions and telegrams for the manual operation are ignored.

The following function is not influenced by the disabling function and continues to be active...

- Presetting of a factor for the additional transmission delay via the object "Factor additional transmission delay".

Behaviour at the end of the disabling function

During deactivation of the disabling function, the motion state is set to "no motion" (transmission delay not active, presence information for light control active). The deactivation of the disabling function is transferred to the light control. The behaviour of the "presence detector with light control" at the end of the disabling function is defined by the parameter of the light control (see page 128-129).

4.2.4.3.12 Reset behaviour

Behaviour after bus voltage return

After bus voltage return, various states of operation (possibly with telegram output) can be adopted for the application types "single device" and "main unit". The behaviour of a function block is defined by the parameter "Behaviour after bus voltage return" on the parameter page "FBx - General". A distinction should be made as to whether the function block works autonomously or in combination with the light control (only for FB1). The following settings are possible...

- Setting "no reaction":
 - Autonomous operation: The function block switches to basic state (no motion, transmission delay inactive, disabling function inactive). No telegram output takes place.
 - Combination with light control: The function block switches to basic state (no motion, transmission delay inactive, disabling function inactive). The presence information for the light control is inactive.
- i** In brightness-dependent motion detection, attention must be paid to the state of the lighting after bus voltage return. If the lighting is on, a motion detection might not be possible (the function block does not respond). Here, the lighting must first be switched off manually.
- i** A lighting system that is switched on after bus voltage return will not be influenced by the presence detector with light control until the next presence detection.
- Setting "Disabling function active":
 - Autonomous operation: With this setting the function block is set to the disabling state after bus voltage return. If a telegram output is configured at the beginning of the disabling function, these telegrams are then transmitted. The basic state (no motion, transmission delay inactive, disabling function inactive) is set as previous state for the disabling function.
 - Combination with light control: After bus voltage return, the function block is set to the disabling state. The disabling information is transferred to the light control whereby the behaviour at the beginning of the disabling function is executed. If a telegram output is configured on the light control at the beginning of the disabling function, these telegrams are then transmitted.
- Setting "State as at the beginning of a detection":
 - Autonomous operation: With this setting, the state changes to that of an active motion detection after bus voltage return (an evaluation delay is not processed). The processing of the motion detection is only subject to the configured twilight level evaluation. In brightness-independent detection, the configured telegrams are transmitted at the beginning of the detection and the transmission delay started. In brightness-dependent detection, the configured telegrams are transmitted at the beginning of the detection, the transmission delay started and brightness-independent motion detection switched-over to only if the brightness values are below the twilight level. If no further motion is then detected, the device processes the end of the detection after the transmission delay has elapsed.
 - Combination with light control: After bus voltage return, the motion state is set to "Motion detected" (presence information for light control active) and the transmission delay started. Depending on the brightness in the room, the light control is started up by the light control, and if no further motion is detected, stepped down again after the transmission delay has elapsed. If the brightness is sufficient, no telegrams are output by the light control.

- Setting "state as before bus voltage failure":
Autonomous operation: With this setting, the state of the function block is adopted again as it was before bus voltage failure. At the same time, a function block in case of bus voltage failure might have had the following states whereby the reactions described are executed...
 - State before bus voltage failure = no motion, transmission delay inactive -> behaviour as with "no reaction"
 - State before bus voltage failure = disabling function active -> behaviour as with "disabling function active"
 - State before bus voltage failure = active motion detection (transmission delay active) -> To restore the state of an active motion detection, the configured telegrams are transmitted at the beginning of the detection, the transmission delay restarted and brightness-independent motion detection switched-over to. If no motion is then detected, the device processes the end of the detection after the transmission delay has elapsed. An active switch-off delay (in presence detector operation) before bus voltage failure is not restarted automatically, but only when the switch-off threshold is exceeded again.Combination with light control: The state of the function block can be adopted again as it was before bus voltage failure. At the same time, a function block in case of bus voltage failure might have had the following states whereby the reactions described are executed...
 - State before bus voltage failure = no motion, transmission delay inactive -> behaviour as with "no reaction"
 - State before bus voltage failure = disabling function active -> behaviour as with "disabling function active"
 - State before bus voltage failure = active motion detection (transmission delay inactive) -> behaviour as "state as at the beginning of a detection"

The "behaviour after bus voltage return" configured in the ETS is not executed if the function block is not active (e.g. by function block switch-over, walking test) or the "Behaviour after ETS programming operation" is executed.

Behaviour after ETS programming

In the application types "single device" and "main unit", various states of operation (possibly with telegram output) can be adopted after ETS programming. The behaviour of a function block is defined by the parameter "Behaviour after ETS programming operation" on the parameter page "FBx - General". A distinction should be made as to whether the function block works autonomously or in combination with the light control (only for FB1). The following settings are possible...

- Setting "no reaction":
Autonomous operation: The function block switches to basic state (no motion, transmission delay inactive, disabling function inactive). No telegram output takes place.
Combination with light control: The function block switches to basic state (no motion, transmission delay inactive, disabling function inactive). The presence information for the light control is inactive.
 - i In brightness-dependent motion detection, attention must be paid to the state of the lighting after bus voltage return. If the lighting is on, a motion detection might not be possible (the function block does not respond). Here, the lighting must first be switched off manually.
 - i A lighting system that is switched on after bus voltage return will not be influenced by the presence detector with light control until the next presence detection.

- Setting "Disabling function active":
Autonomous operation: With this setting the function block is set to the disabling state after ETS programming. If a telegram output is configured at the beginning of the disabling function, these telegrams are then transmitted. The basic state (no motion, transmission delay inactive, disabling function inactive) is set as previous state for the disabling function.
Combination with light control: After ETS programming, the function block is set to the disabling state. The disabling information is transferred to the light control whereby the behaviour at the beginning of the disabling function is executed. If a telegram output is configured on the light control at the beginning of the disabling function, these telegrams are then transmitted.
- Setting "State as at the beginning of a detection":
Autonomous operation: With this setting, the state changes to that of an active motion detection after ETS programming (an evaluation delay is not processed). The processing of the motion detection is only subject to the configured twilight level evaluation. In brightness-independent detection, the configured telegrams are transmitted at the beginning of the detection and the transmission delay started. In brightness-dependent detection, the configured telegrams are transmitted at the beginning of the detection, the transmission delay started and brightness-independent motion detection switched-over to only if the brightness values are below the twilight level. If no further motion is then detected, the device processes the end of the detection after the transmission delay has elapsed.
Combination with light control: After ETS programming, the motion state is set to "Motion detected" (presence information for light control active) and the transmission delay started. Depending on the brightness in the room, the light control is started up by the light control, and if no further motion is detected, stepped down again after the transmission delay has elapsed. If the brightness is sufficient, no telegrams are output by the light control.

The "behaviour after ETS programming operation" configured in the ETS is not executed if the function block is not active (e.g. by function block switch-over, walking test).

4.2.4.4 Function block switch-over

The function block switch-over can be used if required. The function block switch-over makes it possible to toggle between two function block groups, in which assigned function blocks, for example, can be switched over depending on the time of day or depending on the state of the KNX system. This makes it possible to continuously change over during operation of the device and thus change its function (e.g. during the day presence detector for light control, during the night ceiling detector for service light / presence detector if present, detector for KNX signalling systems if absent).

By the assignment of a function block to a function block group by the parameter "group assignment..." on the parameter page "Function blocks (FB)" this is only active if the corresponding function block group is also active. Function blocks of deactivated groups are then also deactivated and do not react. Function blocks that are not assigned to any function block groups are not influenced by the function block switch-over and thus always work autonomously.

During the switch-over from one function block group to the other, all assigned function blocks of the current group are first deactivated and then the assigned function blocks of the switched-over function block group are activated.

The function block switch-over can be used if the parameter "Switch-over of the function block groups" on the parameter page "Function blocks (FB)" is set to "yes". The 1-bit object "FB groups input switch-over" is visible and the group assignment of the function blocks in the ETS relevant in this case only.

The function block switch-over has a 1-bit status object that can feed back the active group to the bus.

Switch-over behaviour

The function block switch-over is executed via the 1-bit communication object "FB groups input switch-over". The telegram polarity can be configured. The switch-over of a function block group on receipt of a switch-over telegram can optionally take place directly or only at the end of a current motion detection. The change-over behaviour is defined by the parameter of the same name as follows...

- Setting "immediate":
In the immediate switch-over of the function block groups, the current motion detections of the assigned function blocks of the current group are ended immediately and the "behaviour at the end of a detection" is executed. After activation of the new function block group, the value for the new function block group is then transmitted to the bus via the object "FB groups output status switch-over" as positive acknowledgement. The polarity of the status telegram corresponds to the telegram polarity for the switch-over.
- Setting "after ending a detection":
To identify the end of a current motion detection, no assigned function blocks must be in an active motion detection anymore. If a motion detection of one or more assigned function blocks is still active at the desired switch-over time (receipt of telegram), the function block group is not switched over. The group active until now continues to remain active. The value for the current function block group is first transmitted via the object "FB groups output status switch-over" as negative acknowledgement. Here too, the polarity of the status telegram corresponds to the telegram polarity for the switch-over. At the end of the motion detection, the function block group as last requested - if the switch-over was not cancelled again by a new switch-over telegram - is then switched over and the value of the new function block group is transmitted via the status object.

Before switching over the function block groups, all active disabling functions of the function blocks assigned to the active group are also deactivated. The function blocks activated after the switch-over are not disabled and work according to their configuration. If a function block should be disabled after the switch-over, the disabling object of this function block must be described actively with a disabling function.

- i** After bus voltage return and after programming with the ETS, the value of the object "FB groups output status switch-over" is updated according to the active group (see "Behaviour on bus voltage return" below) and transmitted to the bus.

Response to bus voltage return

After bus voltage return and after programming with the ETS, the active function block group can be preset. This is carried out via the parameter "Active group after bus voltage return". The assigned function blocks of the activated group then process their configured behaviour after bus voltage return or after ETS programming (according to the configuration of the function block). The assigned function blocks of the deactivated function block group are inactive and do not react.

After bus voltage return and after programming with the ETS, the value of the object "FB groups output status switch-over" is updated to the active function block group.

4.2.4.5 Light control

4.2.4.5.1 Application basics

A complete and multi-functional light control can be implemented in the device. The light control makes it possible to keep the brightness level of an assigned lighting device constantly at a preset brightness setpoint even under changing external light influences (daylight and/or artificial light). The light control is activated and deactivated by means of presence information. This presence information can be transmitted from the internal function block 1 of the device or from another bus subscriber (e.g. another presence detector, motion detector or push-button sensor) to the light control.

The light control makes it possible to control up to three separate dimming channels and allows extensive adjustment of the brightness setpoint even during ongoing operation of the device (setpoint shift, external presetting, Teach). Startup control phase, control phase and step down control phase can be adjusted individually to the control requirement.

- i** The lighting control assumes that a dimmable lighting system is activated (KNX actuator comprising e.g. dimmer actuators, DALI-Gateways, 1-10V control units). The light control cannot be used for only switchable lighting systems. In these cases, the device function "Brightness limit values" is a sensible alternative. This allows the implementation of switching light control.

Control operation

The entire control operation of the controller is always divided into four states/phases executed in succession...

- Phase 1: State OFF (basic state)
In the OFF state, no presence signal is present (presence = 0, no motion detected) and the controlled artificial light is switched off.
- Phase 2: Start up control state
As soon as a presence signal (presence = 1, motion detected) is received in the OFF state, the controller changes to the startup control state. The presence information can be received from the internal function block 1 (presence detector for light control), or alternatively, externally via the object "presence". In the startup control state, the currently measured brightness is first compared with the preset setpoint, and depending on this, the following steps are then taken:
Brightness value < setpoint: The configured behaviour (telegram output) for switching on the lighting is executed. After a configured waiting time, the state changes to control.
Brightness value >= setpoint: The state changes immediately to control without switching on the lighting.
- Phase 3: Control state
In the Control state, the controller tries to compensate light fluctuations (due to daylight and/or extraneous light) by dimming the connected lighting up and down so that the measured brightness value is within the hysteresis range of the setpoint as constantly as possible. In the course of this, it is also possible to switch off the lighting completely within the control phase if there is sufficient basic brightness. The lighting can be dimmed up and down with relative (4-bit) or absolute (1-byte) dimming commands (control outputs) depending on configuration. Once a presence signal is no longer present (presence = 0), the controller changes to the step down state.
- Phase 4: Step down control state
In the step down control state, the controller can optionally switch off the lighting directly or first dim it down to minimum brightness and then switch it off after a configurable additional waiting time. Once the lighting has been switched off or the waiting time has elapsed, the controller changes to the OFF state.

The process of a possible control operation is shown in the figure below.

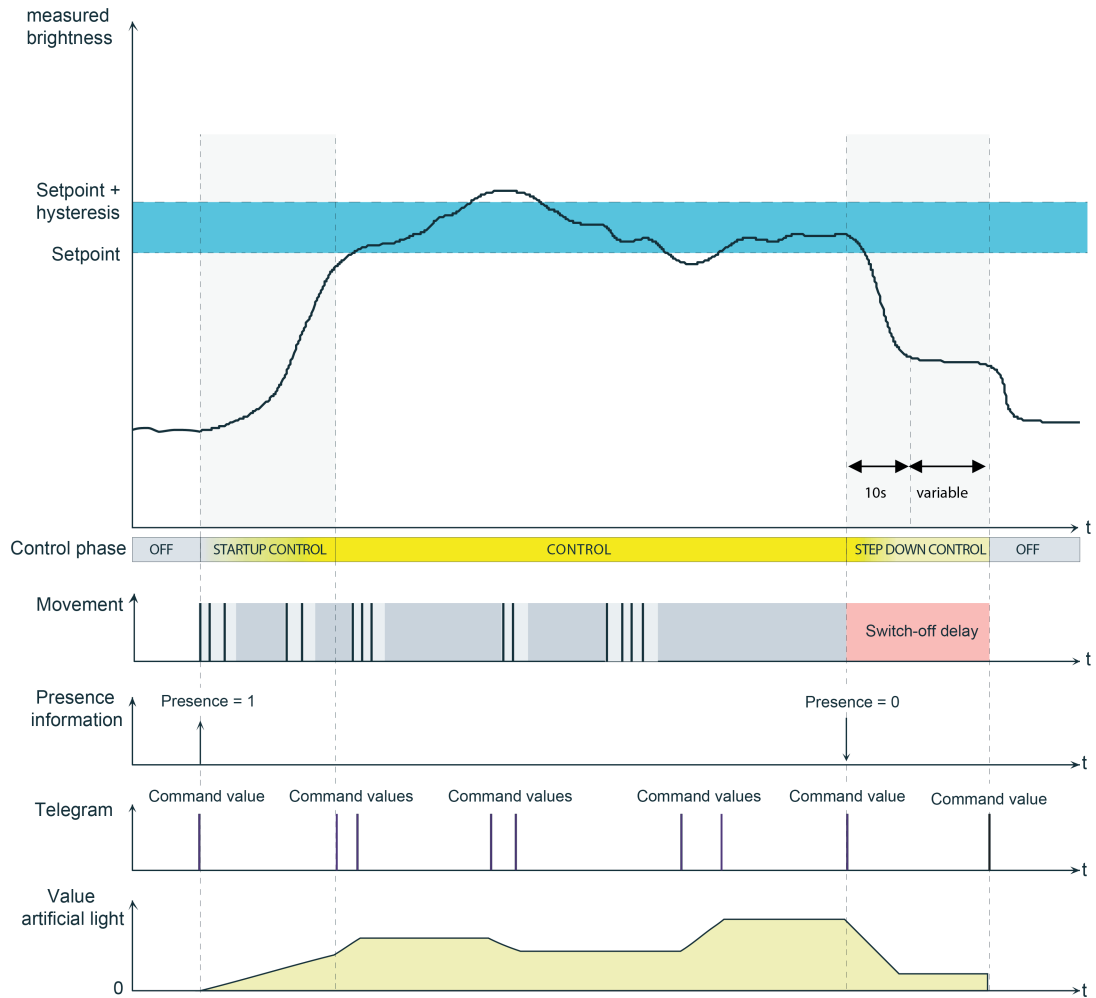

Figure 40: Example of a control process with all control phases

- i The exact behaviour of the individual control phases can be adapted by an appropriate configuration (setpoint presetting and control strategy).

4.2.4.5.2 Operation of the light control

The light control can be operated autonomously and independently of other functional units of the device (information exchange with other bus subscribers via communication objects) or alternatively by interconnection with the function block 1 (presence detector with light control).

Autonomous operation

To operate the light control independently of the first function block, the function block must not be configured to "presence detector with light control". When the function "light control" is then enabled on the parameter page of the same name, it can be used autonomously. In this operating mode, the light control must be activated and deactivated by an external presence detection via the object "presence" (e.g. from an external presence detector, pushbutton or similar device) (figure 41).

This operating mode is appropriate if the device is installed far from the location of the light control due to other detection tasks. At the location of the light control there are normally other KNX sensors that communicate the presence information via the bus to the light control.

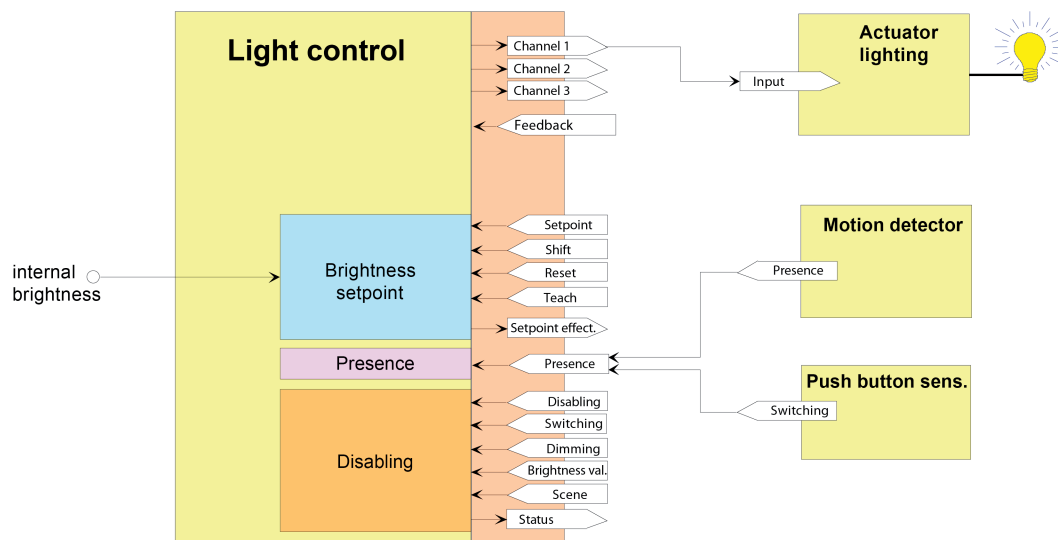

Figure 41: Application example for light control in autonomous operation

Operation with function block 1

The light control can also be operated in the function as "presence sensor with light control" in combination with function block 1. In this operating mode, control of the light control is possible exclusively via function block 1. All control information such as brightness value, presence information or the triggering of the disabling function is then communicated internally from the function block of the light control.

This operating mode is appropriate if the device is installed at the location where the light control is to be operated.

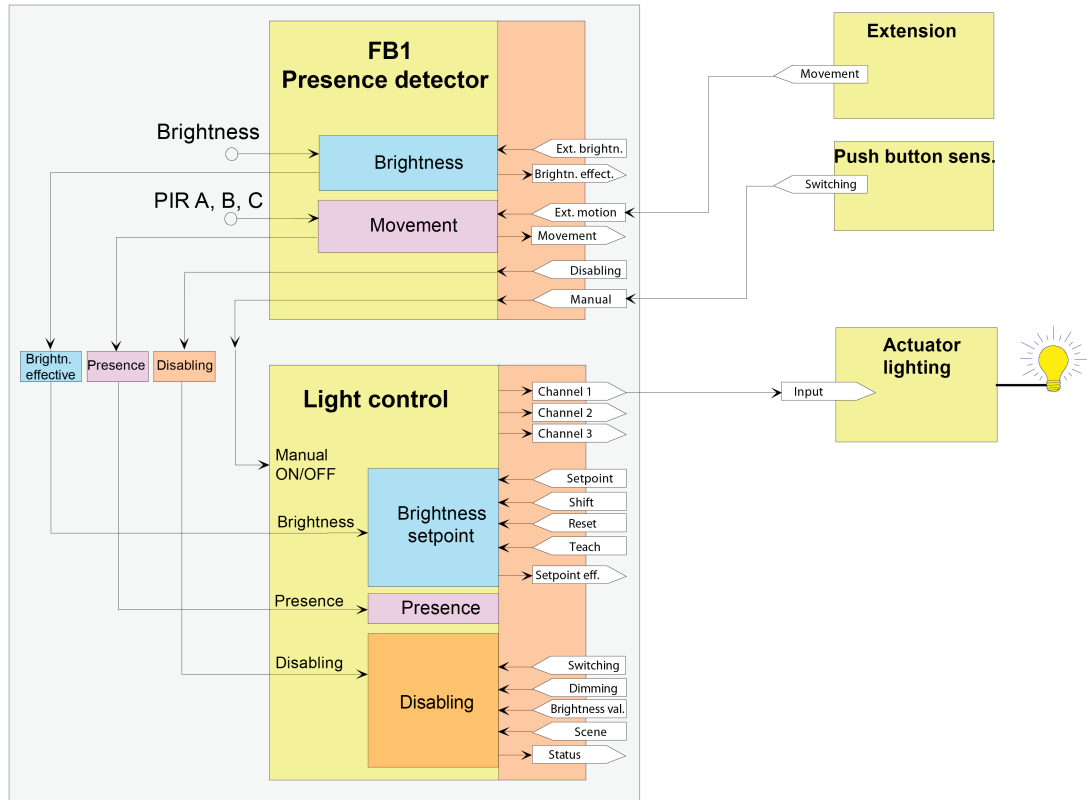

Figure 42: Application example for light control in combination with function block 1

4.2.4.5.3 Brightness setpoint

Introduction

The brightness setpoint corresponds to the value of the desired brightness that the light control is to set and keep as constant as possible with the aid of an assigned lighting device while taking changing external light influences into account. In order to avoid permanent readjustment of the connected lighting device due to slight brightness and measurement value fluctuations, a setpoint range with a lower and upper limiting value is defined for the setpoint presetting (figure 43).

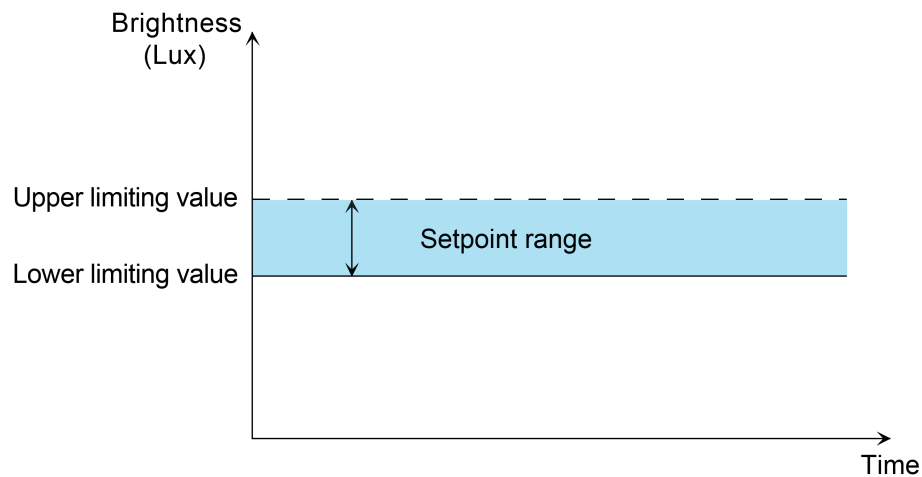

Figure 43: Setpoint range of the light control

During the control phase, the lighting is only readjusted if the measured brightness value is not within the preset setpoint range. The lower limiting value of the setpoint range is preset directly by the "setpoint". The "setpoint" thus represents the minimum brightness to be maintained. The upper limiting value is determined by the presetting of a relative hysteresis value (percentage) in relation to the setpoint.

Example:

Setpoint = 400 Lux, hysteresis value = 20 %

-> Setpoint range: lower limiting value = 400 Lux, upper limiting value = 480 Lux

In addition to the basic presetting of the setpoint by the parameter "setpoint" in the ETS, this can also be changed by an external setpoint presetting or by the Teach function and thus adapted to user requirements. If the setpoint is changed, the value of the upper limit of the setpoint range is also recalculated automatically by the device. The size of the setpoint range changes accordingly as a result of the relative hysteresis value (figure 44).

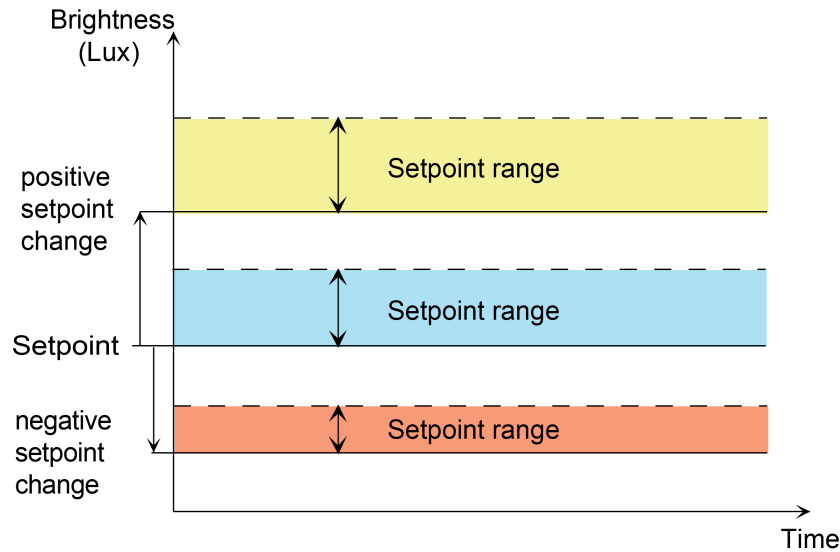

Figure 44: Shift of the setpoint range by means of setpoint adjustment

The object "setpoint effective" can be used for the feedback of the setpoint set effectively in the light control (lower limit of setpoint range). This object contains the active setpoint of the light control and can either transmit the value actively on change, or make it available passively. As an active signalling object, the current value is transmitted once automatically to the bus on each change of the setpoint, after ETS programming or after bus voltage return (optionally delayed).

- i** The possible adjustment range of the parameter "setpoint" depends on the configuration of the control dynamic in the ETS. In a standard control dynamic, the setpoint can be configured within the range from 20 Lux to 1,000 Lux (from 50 Lux in 50-Lux increments). As a result, virtually all standard applications are covered. In user-defined control dynamic, the setpoint in the ETS is continuously configurable within a range from 10 Lux to 2,000 Lux. This allows extended setpoint presettings for special applications.

External setpoint presetting

The currently set brightness setpoint can be reset in accordance with DPT 9.004 by transmitting a 2-byte brightness value to the object "Preset setpoint". This object is configurable if the parameter "object 'Setpoint presetting'" is set to "enabled" on the parameter page "LC - General". The setpoint received via the object remains unchanged until a new setpoint presetting (by means of external setpoint presetting, setpoint shift or Teach) or until a new reset command to the object "Setpoint Reset". Even a bus voltage failure will not reset the brightness setpoint received via the bus. ETS programming resets the setpoint automatically to the ETS presettings if this is provided for in the configuration (see below).

- i** The disabling function, the superimposed operation or current control status have no effect on the external setpoint presetting.

Setpoint shift

With the setpoint shift the setpoint can be changed within the configured limits during the control phase by direct control of the assigned lighting. The setpoint shift is started by transmitting relative 4-bit dimming telegrams to the object "setpoint shift" during the control phase. At the same time, the light control controls the lighting via the relative dimming object of the first channel and thereby sets another brightness value. When the desired brightness is reached, a stop telegram must be received via the object "setpoint shift" which is then transmitted to

channel 1 and output to the lighting.

The new brightness set in this way is measured by the brightness sensor of the device after a delay time of approx. 2 seconds has elapsed and applied as a new setpoint. If no stop telegram is received after the last dimming telegram of the setpoint shift, the device transmits a stop telegram automatically to the lighting via channel 1 after 30 seconds. After a further 2 seconds, the determined brightness value is then saved as a new setpoint.

In the ETS, limiting values of the setpoint shift can be configured. If a configured limiting value is exceeded during the setpoint shift, the setpoint shift stops automatically after detecting that the limiting value has been exceeded. The device then transmits a stop telegram to the bus via channel 1. The corresponding limiting value is then applied as new setpoint value instead of the set brightness value.

With the parameter "Validity of the setpoint shift" it is possible to define in the ETS whether a setpoint shift should only apply temporarily for the control phase currently active, or alternatively, should be applied permanently. If the setpoint shift is applied permanently, the set setpoint remains unchanged until a new setpoint presetting (by means of external setpoint presetting, setpoint shift or Teach) or until a new reset command via the object "Setpoint Reset". Even a bus voltage failure will not reset the brightness setpoint value. ETS programming resets the setpoint automatically to the ETS presettings if this is provided for in the configuration (see below).

- i** If the lighting channels 2 or 3 are also in use (figure 45) during the light control, the 4-bit dimming objects of the dimmer actuators activated via these channels must be connected to the object "Output channel 1 dimming" of the light control (same group address as dimmer actuator in channel 1).

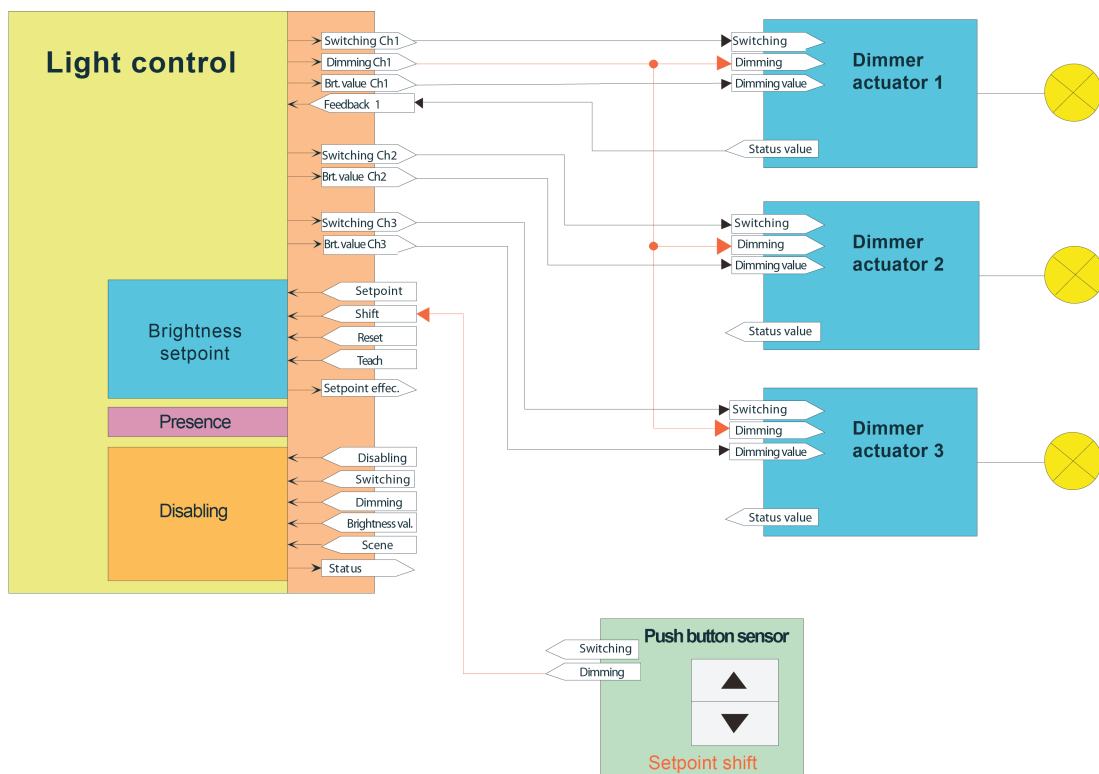

Figure 45: Application example for the setpoint shift with 3 lighting channels

Teach function

The Teach function is another possibility for the external presetting of the brightness setpoint. With the Teach function, the currently measured brightness value is applied instantly by transmitting a corresponding telegram to the 1-bit object "Setpoint Teach" as a new brightness setpoint. This object is configurable if the parameter "Teach function" is set to "enabled" on the parameter page "LC - General".

The polarity of a Teach telegram is configurable by the parameter "Teach operating mode". Depending on the configuration, it is possible to reset to the configured setpoint upon receiving the opposite object value (Teach inactive). The setpoint previously learned will be lost in the process. If, however, the Teach operating mode is configured to "1"- and "0"-active, it is not possible anymore to reset to the configured setpoint via this object during ongoing operation of the device! The new setpoint set with the teach function remains unchanged until a new setpoint presetting (by means of external setpoint presetting, setpoint shift or a by a new Teach) or by a new reset command to the object "Setpoint Reset". Even a bus voltage failure will not reset the new brightness setpoint value. ETS programming resets the setpoint automatically to the ETS presettings if this is provided for in the configuration (see below).

- i** The disabling function, the superimposed operation or current control status have no effect on the Teach function.

Setpoint Reset

The currently set brightness setpoint can always be reset to the value configured in the ETS via the 1-bit object "Setpoint Reset". It makes no difference which function changed the setpoint.

- i** The disabling function, the superimposed operation or current control status have no effect on the setpoint reset.

Setpoint presetting with ETS programming

The parameter "Overwrite setpoint in device for ETS-download?" determines whether an actively set and active setpoint by previous external object presetting or by Teach is overwritten automatically by the setpoint configured in the ETS during ETS programming. If the setting is "yes", the last value preset externally or by Teach and still active is replaced by the ETS presetting. If the setting is "no", the last setpoint preset externally or by Teach still remains active even after ETS programming.

- i** If the parameter "Overwrite setpoint in device for ETS-download?" is set to "no" and no external presetting has been made yet - if provided for in the configuration - via the 2-byte object or by Teach after the first ETS commissioning, the device always works with the value configured in the ETS. The ETS parameter only becomes invalid within the above configuration after an external presetting or after a Teach.

4.2.4.5.4 Channel configuration

The light control can control up to three lighting groups. Up to 3 output channels are available for this purpose. It is possible to adapt control outputs for various installation locations of the lighting groups in the room by using several channels, for example. Thus, a lighting group near the window, for example, can be controlled by small control outputs as lighting in the centre of the room. These with less control outputs, used in turn as lighting in a remote recess.

The number of channels can be defined via the parameter "Number of lighting channels to be controlled" on the parameter page "LC - General". If several channels are used, the control output of the feedback control in the startup and main control phase only takes place with absolute 1-byte dimming values. The basic regulation (control output calculation) always relates to channel 1. The control outputs of channels 2 and 3 are always calculated in relation to the control output of the first channel via corresponding offset settings. Three methods are available for calculating the control outputs of channel 2 and 3. The parameter "Offset behaviour" defines which method is used.

Method 1: Fixed offset with increasing control output

If this method is chosen, a fixed offset value is selected for channels 2 and 3 for the output control of the first channel. The offset remain constant across the entire control output range.

The offset calculation always starts from the control output "1" of channel 1. For the control output "0" (OFF), the control outputs of channel 2 and 3 are also set to "0".

To prevent channels 2 and 3 from being switched too frequently in the case of negative offset in the threshold range, an ON-OFF hysteresis can be configured in relation to the control outputs of channel 1. The ON-OFF hysteresis should be less than the offset value for channel 1.

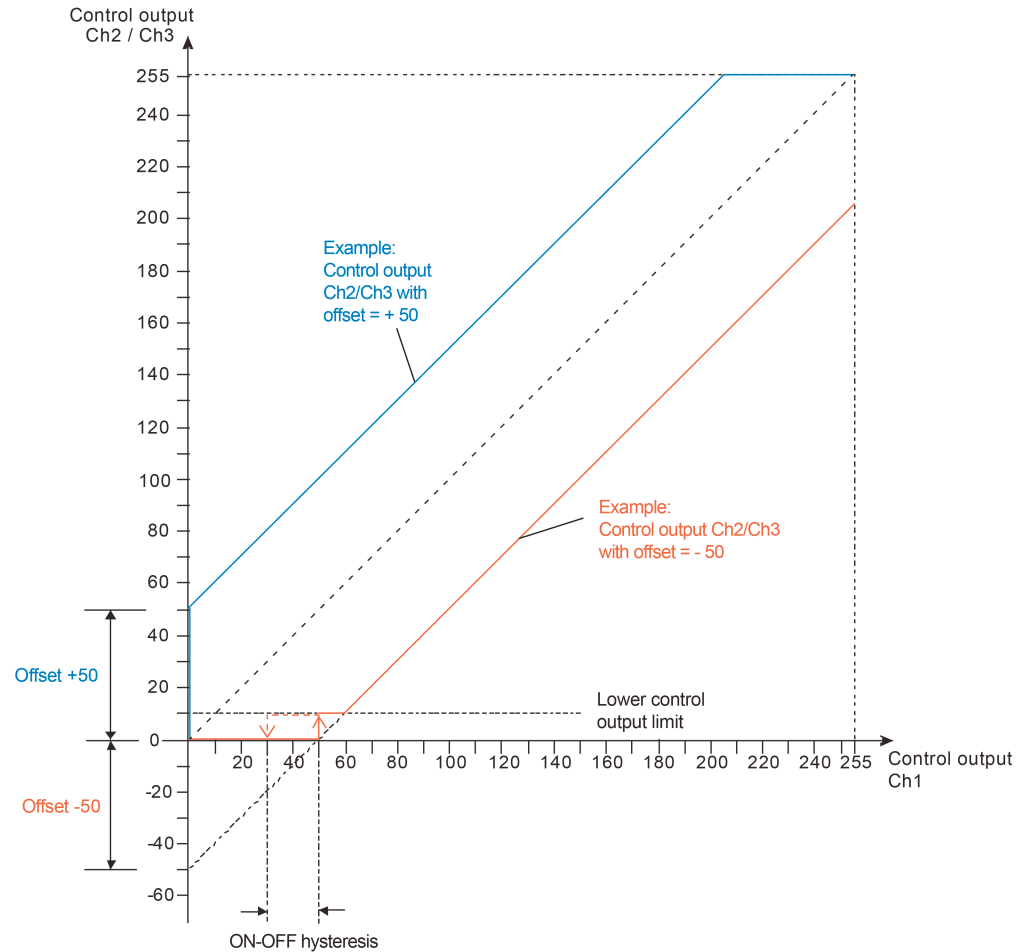

Figure 46: Control outputs of channels 2 or 3 dependent on the control output of channel 1
Method 1: Fixed offset with increasing control output

Example:

Channel configuration: Channel 1 and 2
 Offset behaviour: Offset fixed with increasing control output
 Offset channel 2 to channel 1: -50
 Lower control output limit: 10 (see main control phase)
 ON-OFF hysteresis: 20

Command value channel 1: 128 (50%) -> Command value channel 2: 78 (30%)
 Command value channel 1: 20 (8%) -> Command value channel 2: 0 (0%)

Method 2: Offset increasing with increasing control output

With this method, the offset value is increased for channel 2 or 3 with increasing control outputs of channel 1. This takes place until channel 2 or 3 has reached the limiting value 255. The offset settings for the control outputs of channel 2 and 3 are specified in percentage relative to the control output of channel 1. Offset settings less than 100 % result in a negative offset value and offset settings greater than 100 % result in a positive offset value for the control output of the first channel.

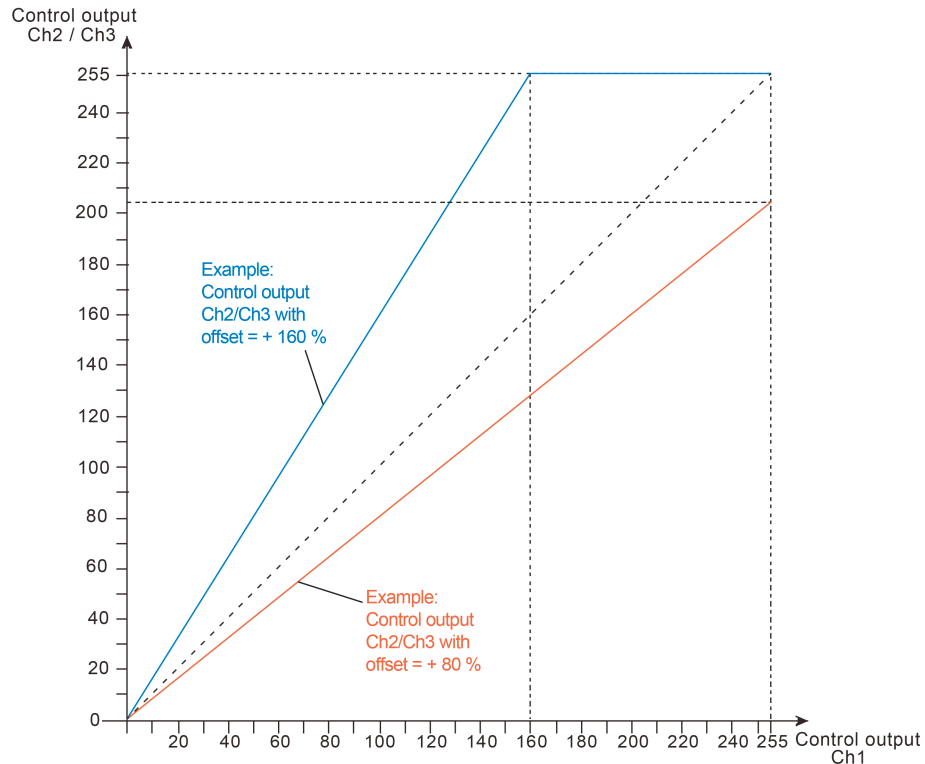

Figure 47: Control outputs of channels 2 or 3 dependent on the control output of channel 1
Method 2: Offset increasing with increasing control output

Example:

Channel configuration: Channel 1, 2 and 3

Offset behaviour: Offset increasing with increasing control output

Offset channel 2 to channel 1: 160 %

Offset channel 3 to channel 1: 80 %

Command value channel 1: 128 (50%) -> Command value channel 2: 204 (80%), Command value channel 3: 102 (40%)

Command value channel 1: 20 (8%) -> Command value channel 2: 32 (12%), Command value channel 3: 16 (6%)

Method 3: Offset decreasing with increasing control output

With this setting, the offset value for channel 2 or 3 is reduced continuously from the start offset with increasing control outputs of the first channel until a limiting control output of channel 1.

The offset for channels 2 and 3 is always "0" from the limiting control output of channel 1 which results in a synchronisation of the output channels. The offset calculation always starts from the control output "1" of channel 1. For the control output "0" (OFF), the control outputs of channel 2 and 3 are also set to "0". To configure this offset setting, a start offset for channels 2 and 3 and the control output from channel 1 for the synchronization must be preset.

To prevent channels 2 and 3 from being switched too frequently in the case of negative offset in the threshold range, an ON-OFF hysteresis can be configured in relation to the control outputs of channel 1. The ON-OFF hysteresis must be adjusted appropriately to the start offset.

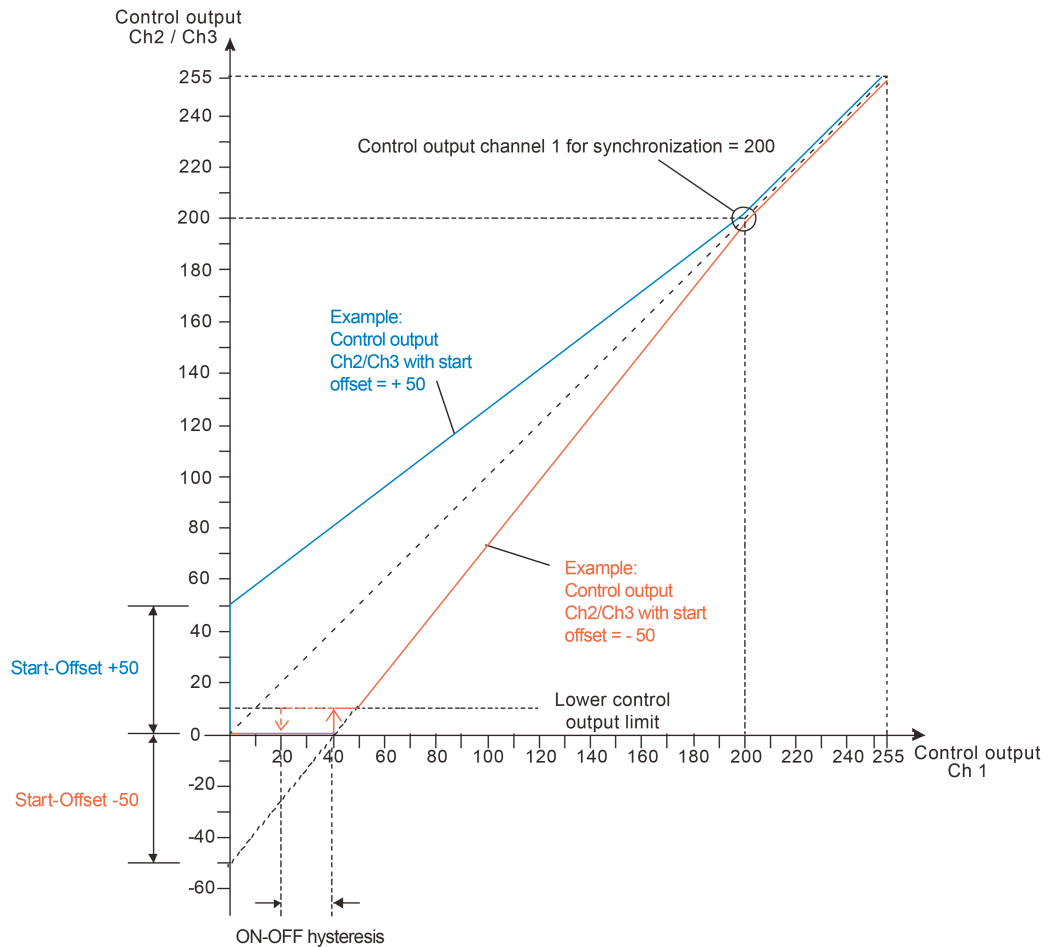

Figure 48: Control outputs of channels 2 or 3 dependent on the control output of channel 1
Method 3: Offset decreasing with increasing control output

Example:

Channel configuration: Channel 1, 2 and 3

Offset behaviour: Offset decreasing with increasing control output

Start offset channel 2 to channel 1: +50

Start offset channel 3 to channel 1: -50

Control output from channel 1 for synchronization to channel 2: 200

Control output from channel 1 for synchronization to channel 3: 200

Lower control output limit: 10 (see main control phase)

ON-OFF hysteresis: 20

Command value channel 1: 180 (70%) -> Command value channel 2: 185 (72%), Command value channel 3: 175 (68%)

Command value channel 1: 60 (23%) -> Command value channel 2: 95 (12%), Command value channel 3: 25 (6%)

4.2.4.5.5 Control behaviour

Startup control phase

The start up control phase represents the start behaviour of the light control and should quickly ensure sufficient brightness in the room. For this purpose, the brightness value setpoint is compared with the measured brightness value at the beginning of the startup control phase. If the measured value is greater or equal to the setpoint, the main control state is changed to immediately. If the measured value is below the setpoint, the configured startup control behaviour is executed. At the same time, there are the following settings in the ETS...

- Startup control behaviour = "Switching on"
If the currently determined brightness value is less than the preset setpoint, the light control switches on the assigned lighting via a switching telegram (1-bit).
The lighting is activated by the channel object "Switching".

i This setting is only available if just one output channel is configured.

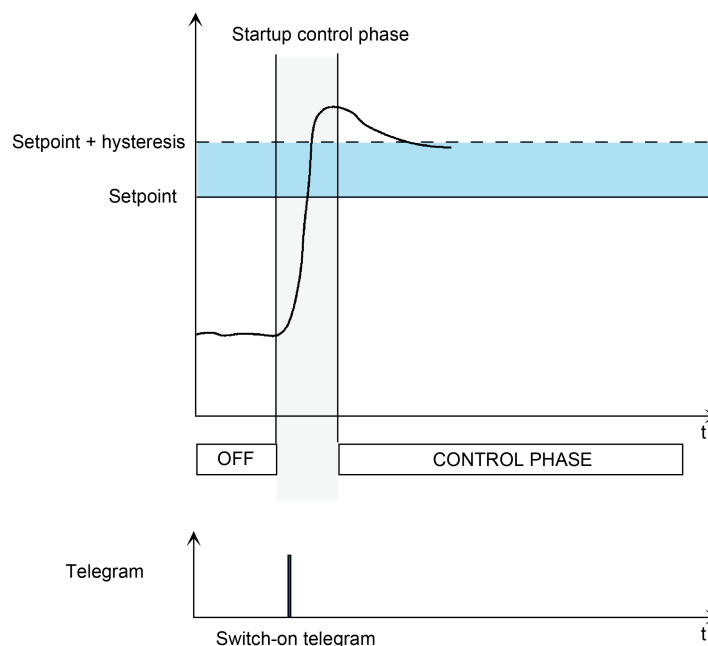

Figure 49: Startup control behaviour with switching telegram (1-bit)

- Startup control behaviour = "control output presetting (relative dimming)"
If the currently determined brightness value is less than the preset setpoint, the light control dims up the lighting via cyclically output dimming step telegrams until the brightness value has reached or even exceeded the setpoint. The increment of the dimming telegrams and the time for the telegram repetition are configurable (optional). After reaching or exceeding the setpoint limit, a stop telegram is transmitted. In the case of dimmer actuators with steep dimming curves, slight overshooting may occur that is then offset again by the main control phase.

The lighting is activated by the channel object "Switching".

i This setting is only available if just one output channel is configured.

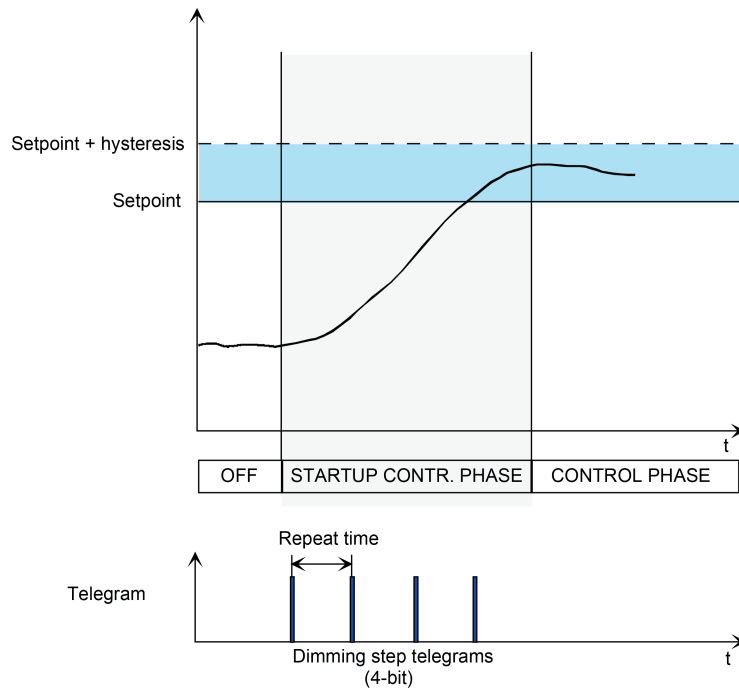

Figure 50: Startup control behaviour with relative dimming step telegrams (4-bit)

- Startup control behaviour = "control output presetting (brightness value)"
 If the light control detects a lower brightness value than the preset setpoint, the lighting is then switched on by transmission of a configured dimming value. If a higher brightness value is preset (e.g. 100 %), this results in a brightness jump (like when switching on), which is then offset again by the main control phase if the higher brightness value is not required.
 The lighting is activated by the channel object "brightness value".

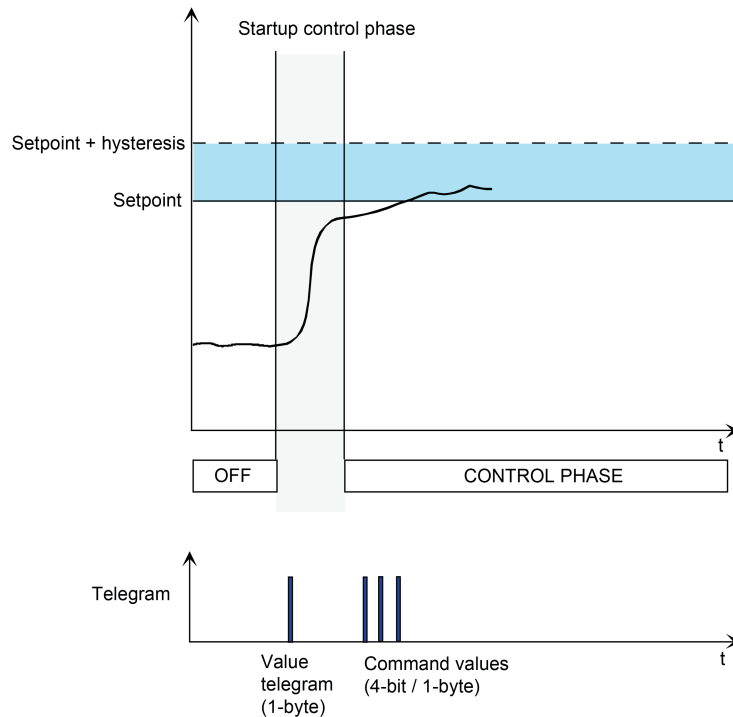

Figure 51: Startup control behaviour with absolute value telegrams (1-byte)

- Startup control behaviour = "control output adaptive (brightness value)"
 With this startup control behaviour, depending on the currently measured brightness by the light control, a control output (1-byte) is calculated and transmitted automatically by means of the setpoint presetting and defined brightness range in order to approximately reach the exact setpoint range.
 The lighting is activated by the channel object "brightness value".

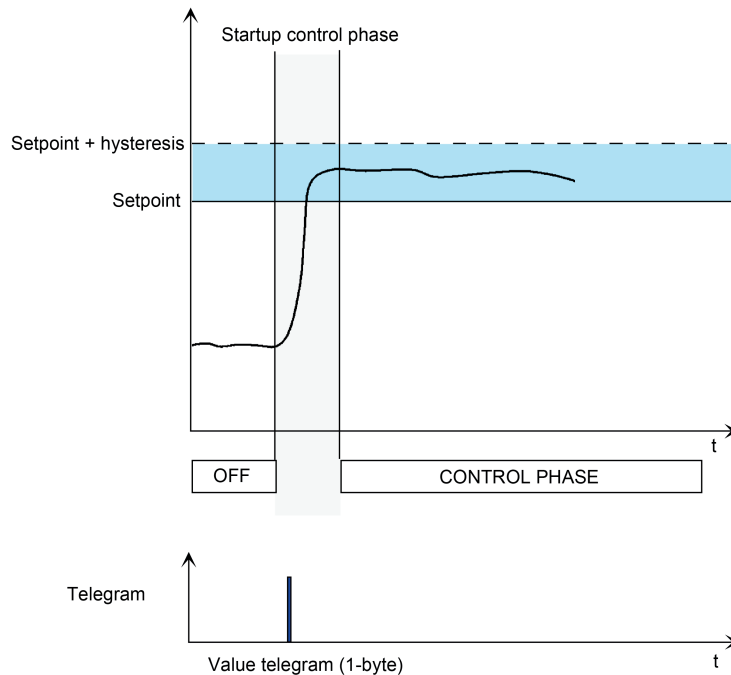

Figure 52: Startup control behaviour with adaptive control output presetting (1-byte)

Waiting time after start up control

Before changing from the start up control phase to the main control phase, the activated actuator should have reached its final value so that the feedback control can control with stable actuator states. For this purpose, a configurable waiting time is started after the startup control phase. The main control phase is only changed to after this waiting time has elapsed. The length of the waiting time should be adapted to the startup control method used (e.g. longer waiting time with relative startup control behaviour) and the characteristics of the connected actuator (fast or slow dimming speed).

Main control phase

In the main control phase, the light control adjusts the brightness of the lighting continuously to the active setpoint. At the same time, the data format used of the control outputs is configurable by the ETS parameter "control behaviour". Alternatively, the lighting can be activated by absolute brightness value telegrams (channel object "brightness value") or by relative dimming step telegrams (channel object "dimming"). The parameters "minimum dimming step width" (in the case of relative control output presetting) and "minimum control output change per dimming step" (in the case of absolute control output presetting) define in which steps the light control can dim the lighting by one telegram each. The parameter "minimum repeat time for control outputs" specifies for the light control how long the minimum waiting time must be between two control output telegrams.

Small dimming steps (relative 1...3% / absolute 2...10) with short repeat times (2...10 seconds) should normally be specified so that the light control is executed interruption-free and is subjectively pleasant. Since the dimming speed is primarily defined by the configuration of the actuator, the parameter of the light control should therefore be adapted to the dimming times of the actuators.

Lower control output limit and switch-off brightness

When switching off the lighting in the room using the light control, it should be ensured that the

lighting is not switched on again immediately by falling below the setpoint due to the light jump. For this purpose, the lower control output limit can be evaluated and a switch-off brightness can be configured.

After reaching the lower control output limit, the switch-off brightness in the room must also be reached or exceeded so that the lighting is switched off automatically during the main control phase. The switch-off brightness is above the setpoint + hysteresis. The switch-off brightness is derived from an additional relative hysteresis value that is added to the hysteresis value of the setpoint: Switch-off brightness = setpoint + (setpoint x (hysteresis setpoint + additional hysteresis switch-off brightness))

The additional hysteresis for the switch-off brightness is configured separately in the ETS.

Example:

Setpoint = 300 Lux, hysteresis setpoint = 10 %,

Additional hysteresis switch-off brightness = 10 %

-> Upper setpoint limit = 330 Lux, switch-off brightness = 360 Lux

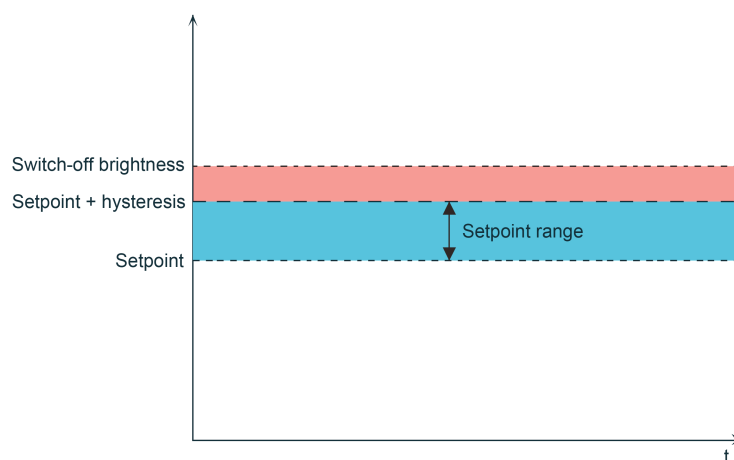

Figure 53: The switch-off brightness results relatively from the setpoint and hysteresis value of the setpoint

The light control only evaluates the lower control output limit if the parameter "influence behaviour in case of lower control output limit?" is set to "Yes". In this case, the "behaviour if lower control output limit is fallen below" is configurable as follows...

- Setting "Switch off at switch-off brightness"
As soon as the lower control output limit is reached and the switch-off brightness in the room has also been reached or exceeded, the light control switches off the lighting. The additional hysteresis for the switch-off brightness can only be configured in this setting.
- Setting "no reaction"
Once the lower control output limit is reached, the light control no longer reacts. A switch-off does not take place. The control output remains unchanged until the control has to dim up the lighting again or until the step down control phase is started due to the presence signal.

i In the case of an absolute control output presetting, the lower control output limit is defined by the parameter of the same name within the range of 1...128 (0.4%...50%). In the case of relative control output presetting, the lower control output limit cannot be configured. In this configuration, the device calculates rather the lower control output limit itself by means of the configured minimum dimming step width. The relative dimming step telegrams transmitted to the actuator then enable the light control to detect during the ongoing control process whether or not the lower control output limit has been reached. It is important that the activated KNX dimmer actuators can be dimmed to the lowest brightness level (basic brightness). The dimmable brightness range must not be limited by a minimum brightness on the actuators!

If the parameter "influence behaviour in case of lower control output limit?" is configured to "No", the light control never responds once the lower control output limit is reached. Here too, the control output remains unchanged until the control has to dim up the lighting again or until the step down control phase is started due to the presence signal.

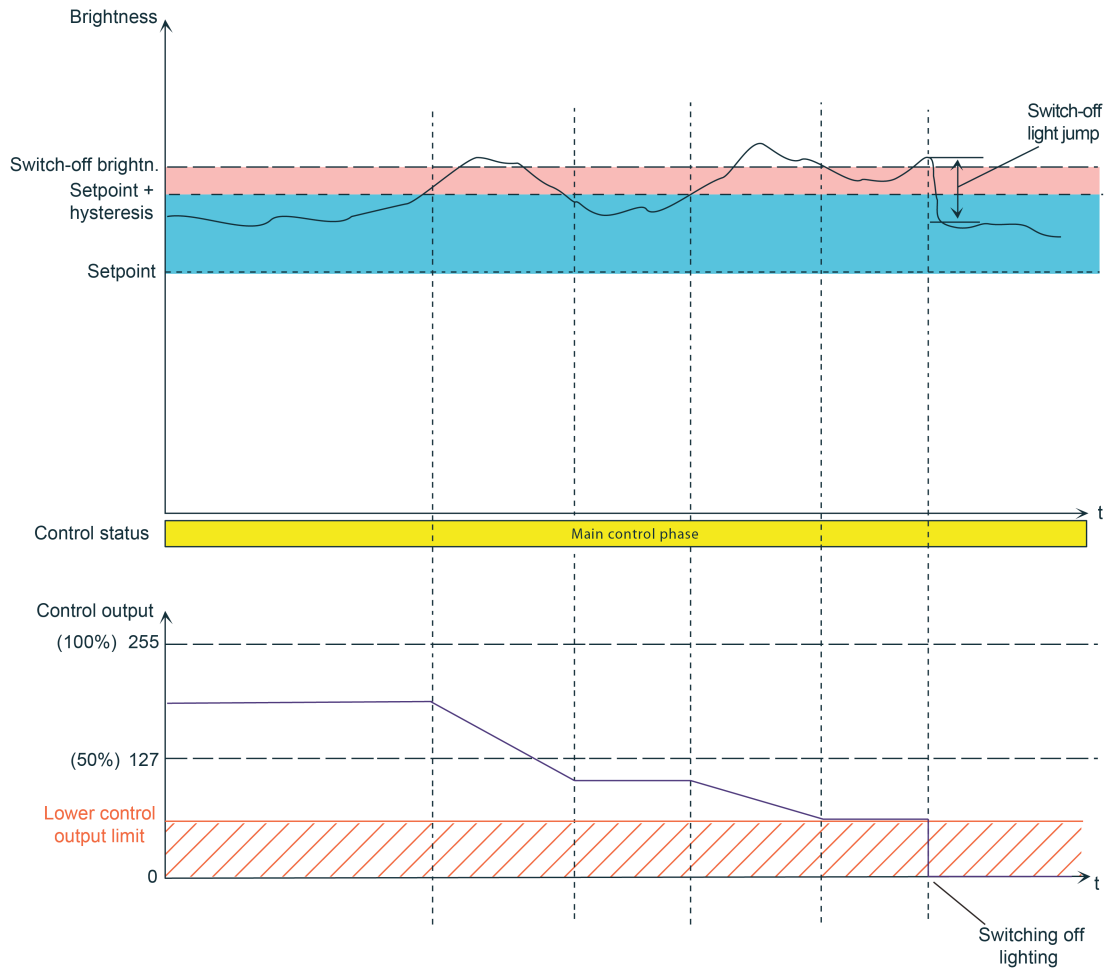

Figure 54: Example of a control output presetting with evaluation of the lower control output limit

The relative setting of the additional hysteresis for the switch-off brightness also influences the interval of the switch-off brightness for the upper setpoint limit during a setpoint shift (figure 55).

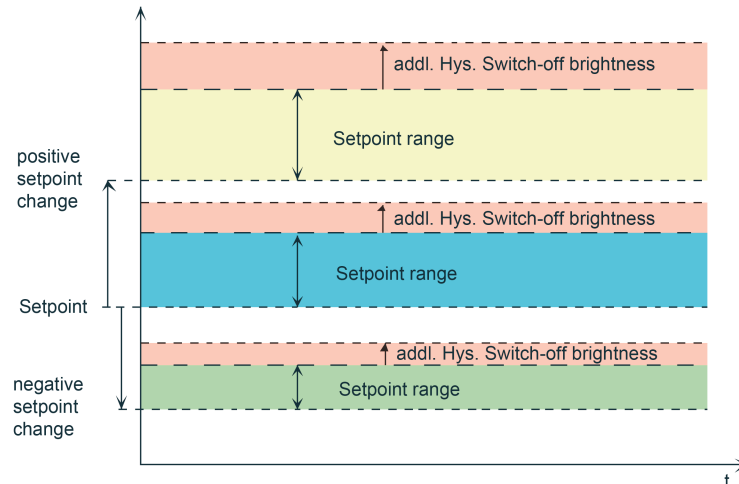

Figure 55: Dependency of the additional hysteresis for the switch-off brightness during a setpoint shift

Step down control phase

The behaviour at the end of the control is determined in the step down control phase. Here, - defined by the parameter "Behaviour at the beginning of the step down control phase - the assigned lighting device can optionally be switched off immediately, or first dimmed down to minimum brightness by transmitting the minimum control output. As a further alternative, it is possible for the device to transmit a configured control output (1...100 %). When transmitting the minimum control output, it is necessary to define with which data format this takes place. This defines the parameter "step down control behaviour" (value telegram "1" or dimming step telegram 100%).

When dimming down to minimum brightness or when dimming to the configured control output, a delay time is started at the beginning of the dimming process. The duration of the waiting time is derived from a standard waiting time (10 seconds) plus an additional waiting time that can be configured in the ETS. The standard waiting time ensures that the minimum or preset brightness also can actually be set by the activated dimmer actuators before the end of the step down process.

After the waiting time has elapsed, the parameter "Behaviour after waiting time has elapsed" decides which state the lighting adopts at the end of the control process. With the setting "switch off", the light control finally switches off the lighting. The parameter "switch off by" defines with which data format this takes place. As an alternative to switching off, the control output can also be kept constant. This setting is appropriate, for example, if a permanent basic brightness is to be set in the room (e.g. in long corridors or passageways).

During an ongoing waiting time in the step down control phase, a new presence can be transferred to the light control if, for example, people are present again in the room. In this case, the parameter "Behaviour on new presence detection during waiting time" defines how the light control should behave. The presence detection can either be ignored. The light control then executes the step down control phase interruption-free until the end as preset. If the presence signal is still present at the end of the step down control phase, the light control restarts the startup control phase.

Alternatively, the step down control phase can be cancelled immediately during the detection of a new presence and the startup control phase started at once interruption-free.

- i** The setting "Transmit configured control output" for the parameter "Behaviour at the beginning of the step down control phase" is only available with the application program of version 1.2. This setting only displays the described response if the application program was programmed in devices with release version "V01" or higher (printed on the device label). If the application program of version 1.2 was loaded to older devices with the aforementioned parameter setting, the behaviour will be executed according to the "minimum control output" setting.

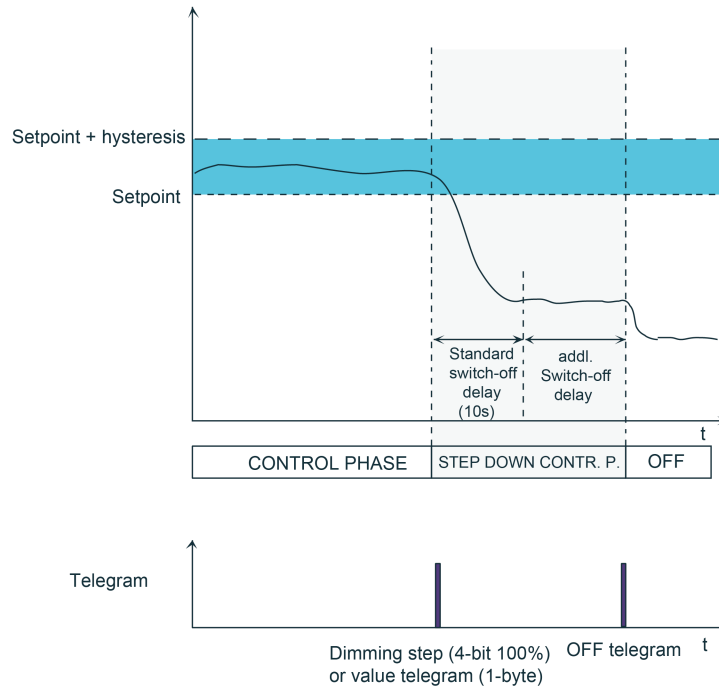

Figure 56: Step down control behaviour with waiting time

Definition of the brightness range

The light control needs certain parameters that define the brightness range in the room. These parameters are important for calculating certain control characteristics from which, among other things, the control dynamic and thus the subjective perceived comfort of the feedback control are derived. The required control parameters include, firstly, the information regarding which maximum illuminance can be set by the lighting in the room (artificial light). In the case of a large difference between the brightness in the room and the setpoint, this maximum value defines larger control output changes or increments and thus increases the control dynamic (fast adjustment to the setpoint by larger control output commands). The maximum illuminance is also used for calculating the control output for the adaptive start up control. This control parameter must be configured to the maximum brightness value adjustable by the lighting (P-component of the light control). The maximum value of the lighting is typically a factor of 1.2 higher than the setpoint configured in the ETS.

Secondly, the darkness value of the room lighting (lower brightness threshold) is decisive for the light control. If the lower brightness threshold is fallen below, the time between the control output telegrams is shortened thereby resulting in a higher control dynamic here as well.

The parameter "Adaptation of the control dynamic in the brightness range" defines whether the light control works with standard control parameters that Jung has predefined and generally adapted to many applications, or whether the control parameters can be customized...

- Setting "Standard":
The light control works with a standard configuration preset by Jung. The control dynamic is thus adapted effectively to very many applications. The maximum illuminance is then not configurable in the ETS. This is calculated automatically depending on the setpoint configured in the ETS (factor x 1.2) and entered in the light control. When dimensioning the lighting system on-site, it must be ensured that the installed lighting can always supply brightness levels that correspond to the value "configured setpoint x 1.2".
The lower brightness threshold is preconfigured to 0 Lux with this setting (no special control dynamic in the lower brightness range).
- Setting "user-defined":
With user-defined control dynamic the maximum illuminance (10...2,000 Lux) and lower brightness threshold (0...2,000 Lux) can be configured in the ETS. In this way, it is possible to customize the control parameters to special applications.
When configuring the control parameters, the following dependency should be noted:
Lower brightness threshold < Setpoint < Maximum illuminance.

i The possible adjustment range of the parameter "setpoint" depends on the configuration of the control dynamic in the ETS. In a standard control dynamic, the setpoint can be configured within the range from 20 Lux to 1,000 Lux (from 50 Lux in 50-Lux increments). As a result, virtually all standard applications are covered. In user-defined control dynamic, the setpoint in the ETS is continuously configurable within a range from 10 Lux to 2,000 Lux. This allows extended setpoint presettings for special applications.

4.2.4.5.6 Disabling function

The light control can be disabled independently of the other functional units via the disabling function. A disabled light control is deactivated. It can be brought to a defined state at the beginning or end of the disabling function.

Depending on the configuration of the first function block, the disabling function is either activated via its own disabling object (autonomous operation) or via the disabling object of FB1 (application FB1 "presence detector for light control"). The disabling function can be activated by force after bus voltage return or after ETS programming.

Behaviour at the beginning of the disabling function

The parameter "Behaviour at the beginning of the disabling function" defines the behaviour of the light control if the disabling function is activated. The following settings are possible...

- "disable and send no telegram":
At the start of disabling the function block, no telegrams are transmitted via the outputs. The assigned lighting is not influenced by the function block.
- "Disable and transmit telegram":
At the start of the disabling function, freely configurable switching or brightness value telegrams can be output via the output channels in order to set the assigned lighting to the desired state. The telegrams are configured in the ETS separately for each channel.
- "Execute disable and step down control behaviour":
With this setting, the configured step down control behaviour is executed on activation of the disabling function. Presence signals are ignored during execution of the step down control behaviour.

Behaviour at the end of the disabling function

On ending the disabling function, the light control is reset and the basic state (state OFF, no presence) set. The device then stops ongoing disabling reactions (e.g. step down control behaviour) immediately. The parameter "Behaviour at the end of the disabling function" defines the behaviour of the light control at the end of the disabling function. The following settings are possible here...

- "enable and send no telegram":
With this setting, the light control after enabling is internally in the state OFF and reacts to the newly received presence according to the configuration. The lighting state, which might have been changed externally during an active disabling function depending on the application, must be taken into account when enabling! At the end of the disabling function, the current existing lighting state will not be changed until new presence information by the light control. If control output presettings are made via absolute brightness values, the 1-byte object "Feedback brightness value" of the light control must be connected to an actuator feedback object of channel 1 so that the light control knows the output state of the lighting. Otherwise, the light control may be adversely affected thereby resulting in erratic control behaviour.
- "enable and switch off":
At the end of the disabling function, the assigned lighting is switched off via the switching outputs in order to restore a defined basic state of the lighting. If a presence exists or a new presence is received, the control is restarted according to the measured brightness.
- "execute enable and startup control behaviour":
With this setting, a presence signal is activated artificially at the end of the disabling function. As a result, the startup control behaviour is executed automatically at the appropriate brightness value (determined brightness < value setpoint). The main control phase is then changed to. The further behaviour of the control process is dependent on the actual presence information.

Optionally, the disabling status of the light control can be made available via the 1-bit object "Status disabling function light control". For this purpose, the parameter "Feedback 'Status disabling function light control'?" must be configured to "Yes" on the parameter page "LC - Disable / Superimposed operation". The light control - if the object was enabled - transmits its own disabling status depending on the parameter "Effect of the feedback" either actively to the bus on each change, or it only provides the object value passively (object is readable). The disabling status is influenced by the disabling function and by the superimposed operation. A "1" indicates an active disabling function of the light control.

4.2.4.5.7 Superimposed operation

Superimposed operation

With the superimposed operation, the assigned lighting device can be activated directly, for example, via a pushbutton or operating panel. In addition, the manually triggered switching or dimming commands to the lighting also have to be transmitted to the lighting control. For this purpose, the light control has 4 objects each with different data formats ("Input superimposed operation" - 1-bit switching, 4-bit relative dimming, 1-byte brightness value, 1-byte scene extension). By "listening in" to the telegrams via the named objects, the light control is disabled during the superimposed operation, whereby the lighting is no longer influenced by the control but only by the user.

If the device detects a superimposed operation, the presence signal of the light control is then internally activated automatically (an active motion detection is simulated). Additionally, the evaluation of the presence information remains functional via the object of the light control or via the first function block so that the presence signal can be tracked (optional for enabling after superimposed operation).

The behaviour of the light control at the end of the superimposed operation is defined by the parameter "enabling after superimposed operation". The following settings are possible...

- "automatic at the end of the presence":
With this setting, the control is enabled automatically at the end of the tracked presence detection and the step down control behaviour is executed. A distinction must be made here between the following cases...
 - Light control in combination with function block 1: The automatic setting of the presence at the beginning of the superimposed operation ensures that the superimposed operation is always ended automatically in this application at the end of the presence detection once the transmission delay has elapsed and the step down control behaviour is executed. Additional (manual) intervention in the presence signal is not necessary here.
 - Autonomous operation of the light control: With this application, the end of the presence (deactivation of the presence information) must be received actively via the object "Presence" in order to end the superimposed operation and execute the step down control behaviour. In this case, the superimposed operation can be ended alternatively via the disabling object (see setting "only via disabling object").
- "only via disabling object":
With this setting, the disabling of the control after a superimposed operation can only be cancelled with an enabling telegram via the disabling object. With the enabling telegram the configured behaviour is executed at the end of the disabling function (see page 128-129). It should be noted that in the combination of the light control with the first function block the enabling must take place via the disabling object of the function block (disabling object of the light control is then not present).

- i** To ensure that the superimposed operation works correctly in multichannel operation, the brightness value-feedbacks of the actuators must lead from channel 2 and 3 to the channel value objects of the light control (objects 82 and 84), whereby it is always essential to additionally set the "write" flags of these objects!
- i** Optionally, the disabling status of the light control can be made available via the 1-bit object "Status disabling function light control". For this purpose, the parameter "Feedback 'Status disabling function light control?'" must be configured to "Yes" on the parameter page "LC - Disable / Superimposed operation". The light control - if the object was enabled - transmits its own disabling status depending on the parameter "Effect of the feedback" either actively to the bus on each change, or it only provides the object value passively (object is readable).
The disabling status is influenced by the disabling function and by the superimposed operation. A "1" indicates an active disabling function of the light control.

4.2.4.5.8 Manual operation

The manual operation of the light control is only possible in combination with the first function block (Application "presence sensor for light control"). With the manual operation (ON / OFF) the light control can be started and stopped by the user regardless of the control process e.g. using a pushbutton, whereby no brightness is evaluated when starting. Thus, activation of the lighting is forced when switching on manually.

After manual activation of the light control, this works presence and brightness-dependently as usual thereby ensuring automatic switch-off if there is no presence or adequate basic brightness.

The exact function of the manual operation in relation to the different operating modes of the first function block in combination with the light control is described below...

- Operating mode "Fully automatic (Auto ON, Auto OFF)":
ON telegram to the 1-bit object "FB1 - input lighting manual ON/OFF" -> If the light control is in the status OFF, a presence is simulated and the startup control phase is started brightness-independently (telegram output is forced). Additionally, the configured transmission delay is started. If the control is disabled by the superimposed operation, only one presence is simulated and the transmission delay is started (no telegram output). The light control now works like after a presence detected by the PIR sensor and starts the main control phase. If the presence signal is subsequently cancelled, the device starts the step down control phase after the transmission delay has elapsed.
OFF telegram to the 1-bit object "FB1 - input lighting manual ON/OFF" -> With the OFF telegram the light control is set to the state OFF, the presence signal is reset and the lighting is switched off. A control disabled by the superimposed operation is enabled. Afterwards, the light control is ready immediately or - configured immediately - for a new motion detection after the lockout time.
- Operating mode "semi-automatic I (manual ON, Auto OFF)":
ON telegram to the 1-bit object "FB1 - input lighting manual ON/OFF" -> Function as in the case of the operating mode "Fully automatic" (see above).
OFF telegram to the 1-bit object "FB1 - input lighting manual ON/OFF" -> With the OFF telegram the light control is set to the state OFF, the presence signal is reset and the lighting is switched off. A control disabled by the superimposed operation is enabled. The presence detection is disabled. The function block must first be activated via an ON telegram to the object "FB1 - input lighting manual ON/OFF" for a new motion detection.
- Operating mode "semi-automatic II (Auto ON, manual OFF)":
This operating mode of the first function block is not configurable in combination with the light control in the ETS. Nevertheless, the behaviour of a semiautomatic II can be implemented by a special configuration of the operating mode "Fully automatic". The configuration of the lighting control must then be selected in such a way that the lighting after reaching a minimum control output during the control and at the end of the switch-off delay is not switched off in the step down control phase. In this case, it is only possible to switch off the lighting by an OFF telegram to the object "FB1 - Input lighting manual ON/OFF".

4.2.4.5.9 Application examples

Two application examples are shown below, which illustrate the linking of all necessary communication objects between sensors, the device incl. light control and actuators.

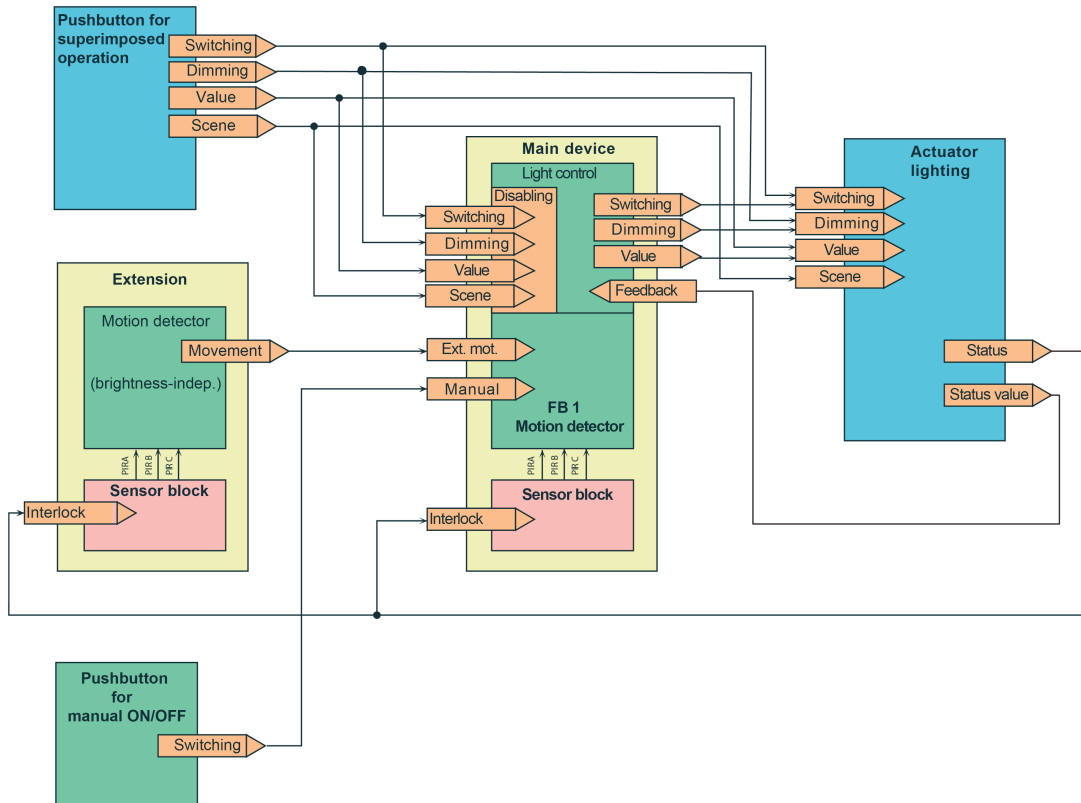

Figure 57: Application example 1

Function block 1 as presence detector for internal light control with presence detector as extension and push-button sensors for superimposed operation and manual switch ON/OFF

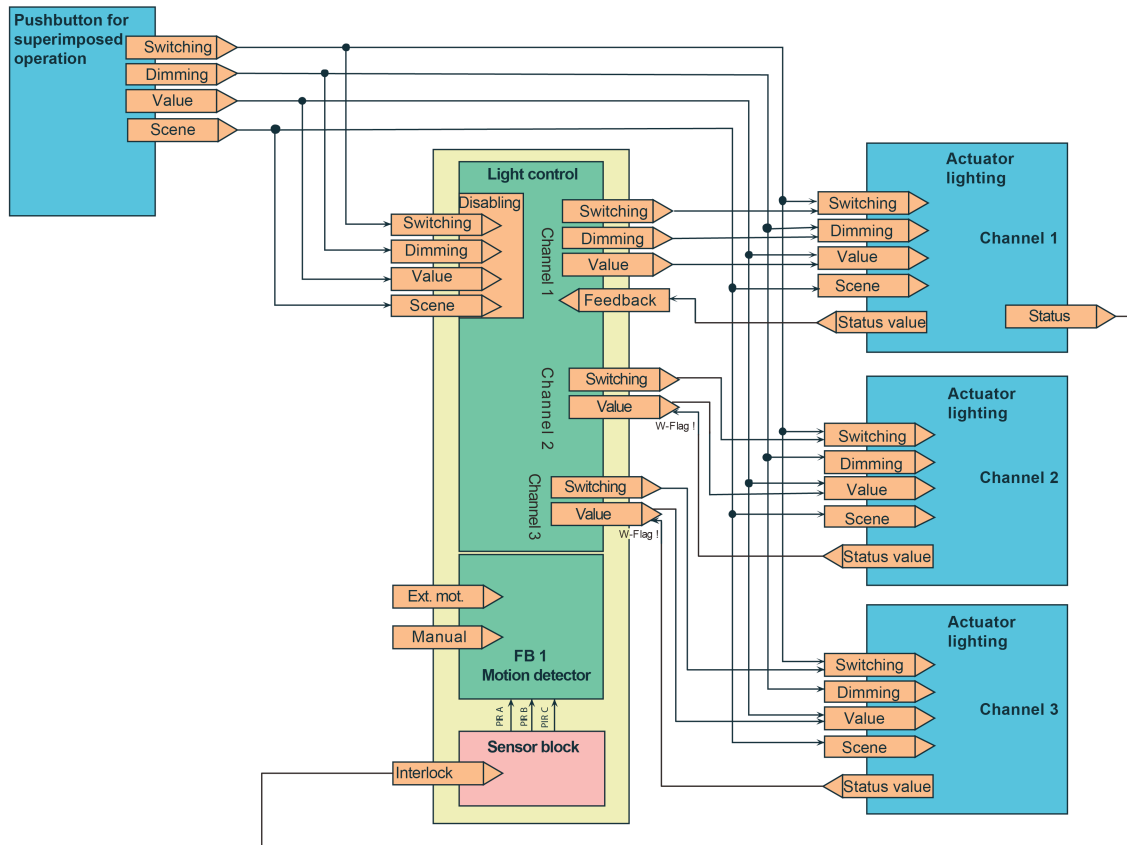

Figure 58: Application example 2
Function block 1 as presence detector for internal light control with 3 lighting channels and pushbutton for superimposed operation

4.2.4.5.10 Behaviour after a device reset

Behaviour after bus voltage return

The behaviour of the light control after bus voltage return can be defined. A distinction must be made as to whether the light control works autonomously or in combination with the first function block...

- Light control works in combination with the first function block:
The behaviour after bus voltage return is preset by the configuration of the first function block (according to parameter "Behaviour after bus voltage return" on the parameter page "FB - General").
- Light control works autonomously:
The behaviour of the light control is defined by the parameter "Behaviour after bus voltage return" on the parameter page "LC - General". The following settings are available...
"no reaction": With this configuration, the light control is in normal state after bus voltage return. It can be activated and operated regularly.
"Activate disabling function": With this setting the light control is set to the disabling state after bus voltage return. The configured behaviour is executed at the beginning of the disabling function.
"State as before bus voltage failure": With this setting the disabling state of the light control is adopted as it was before bus voltage failure. If the disabling function should be activated, the configured behaviour is executed at the beginning of the disabling function.

Behaviour after ETS programming

The behaviour of the light control is also definable after ETS programming. A distinction must also be made here as to whether the light control works autonomously or in combination with the first function block...

- Light control works in combination with the first function block:
The behaviour after ETS programming is preset by the configuration of the first function block (according to parameter "Behaviour after ETS programming operation" on the parameter page "FB - General").
- Light control works autonomously:
The behaviour of the light control is defined by the parameter "Behaviour after ETS programming operation" on the parameter page "LC - General". The following settings are available...
"no reaction": With this configuration, the light control is in normal state after ETS programming. It can be activated and operated regularly.
"Activate disabling function": With this setting the light control is set to the disabling state after ETS programming. The configured behaviour is executed at the beginning of the disabling function.

4.2.4.6 Brightness limiting values

The device has up to three mutually independent brightness limiting values that are continuously compared with the brightness value detected. If a limiting value configured in the ETS or predefined externally is exceeded or fallen below, the device can transmit switching, brightness value or scene recall telegrams to the bus and thus trigger appropriate reactions in other bus subscribers.

The "Function brightness limiting values" must be enabled in the ETS by the parameter of the same name on the parameter page "Brightness limiting values (BLV)" so that the function can be configured and used.

Output functions

Up to three limiting values can be evaluated. Each limiting value has its own output object. The parameter "Number of limiting values to be controlled" defines how many limiting values and thus how many output objects are configurable in the ETS.

Each output can be configured independently to one of the following data formats by the parameter "Function"...

- "Switching" function:
1-bit switching telegrams (ON / OFF) can be output.
- "Brightness value" function:
It is possible to output 1-byte brightness value telegrams (0...100 %).
- "Scene extension" function:
It is possible to execute a 1-byte scene recall (0...64) in another bus subscriber via the output object of a limiting value.

4.2.4.6.1 Limiting value definition

A brightness limiting value to be monitored always consists of an upper and lower brightness threshold. The brightness thresholds are assigned via a limiting value and hysteresis derived relatively from the limiting value. The type of limiting value (upper or lower threshold) must be preset accordingly by the parameter "Limiting value definition".

Depending on the configuration, a limiting value output can transmit a telegram if the brightness value exceeds the upper threshold and/or falls below the lower threshold.

i The limiting value is configured in the ETS and can be changed during ongoing operation of the device either by an external presetting via the 2-byte object "Limiting value 1 external presetting" or by the Teach function (see page 137-138).

The hysteresis is a static value that is configured in the ETS. The hysteresis cannot be adapted during operation of the device. The device recalculates the hysteresis automatically if a new limiting value is preset.

Example of the limiting value definition:

1. Brightness limiting value = Upper threshold (figure 59)
-> Lower threshold = brightness limiting value - hysteresis
2. Brightness limiting value = Lower threshold (figure 60)
-> Upper threshold = brightness limiting value + hysteresis

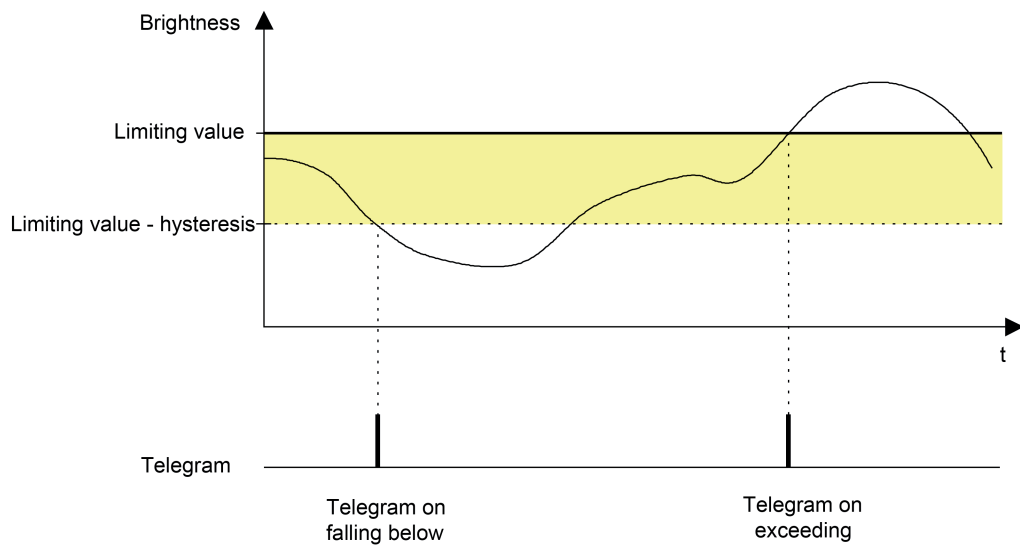

Figure 59: Example 1 of the limiting value definition
Limiting value is upper threshold

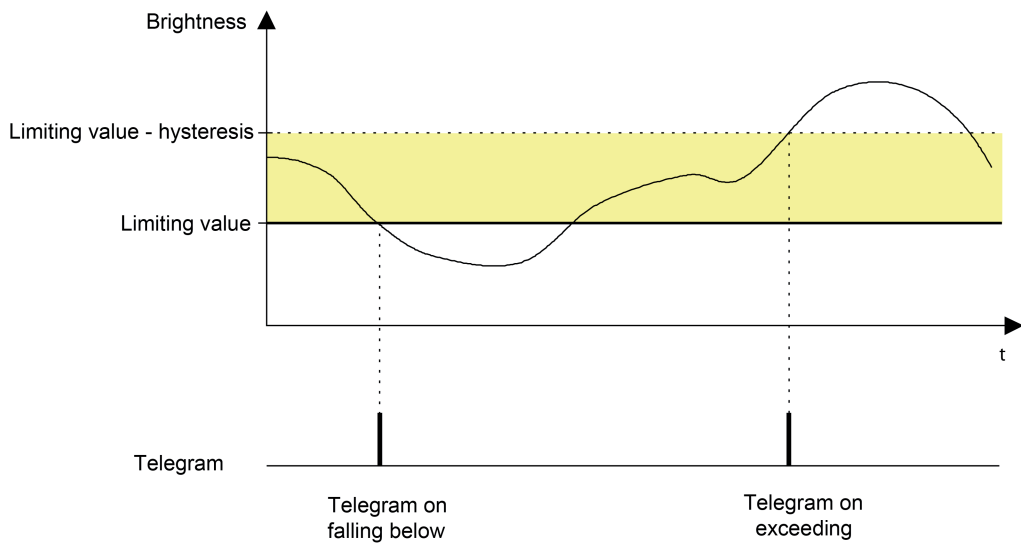

Figure 60: Example 2 of the limiting value definition
Limiting value is lower threshold

4.2.4.6.2 Limiting value presetting

During ongoing operation of the device, a brightness limiting value can be changed by an external presetting of a 2-byte brightness value via the object "Limiting value x external presetting" or by the Teach function and thus adapted to user requirements.

The 2-byte objects "limiting value x effective" can be used for the feedback of the limiting values evaluated by the device. These objects are configurable with group addresses if the parameter "Feedback 'limiting value effective'?" is set to "yes" per limiting value.

The feedback can optionally take place actively or passively (object is readable). In the function as an active signalling object, the current value is transmitted once automatically to the bus on each change of the brightness limiting value, after ETS programming or after bus voltage return (optionally delayed).

External presetting of the brightness limiting value

The brightness limiting value is reset in the device in accordance with DPT 9.004 by transmitting a 2-byte brightness value to the object "Limiting value x external presetting". The relative hysteresis value configured in the ETS results in a new value for both brightness thresholds depending on the type of limiting value definition. The new limiting value remains unchanged until a new presetting (externally via object or via Teach function). An ETS programming operation resets a limiting value automatically to the ETS presettings if this is provided for in the configuration (see below).

- i** A limiting value set via the 2-byte object will be lost during execution of the Teach function (see below).

Teach function

The Teach function is another possibility for the external presetting of a limiting value. With the Teach function, the currently measured brightness value is applied instantly by transmitting a corresponding telegram to the 1-bit object "Limiting value x Teach" as a new limiting value. The relative hysteresis value configured in the ETS results in a new value for both brightness thresholds depending on the type of limiting value definition.

The Teach object is configurable if the parameter "Teach function" is set to "enabled" on the parameter page "BLV - General". The polarity of a Teach telegram is configurable by the parameter "Teach operating mode". Depending on the configuration, it is possible to reset to the configured limiting value upon receiving the opposite object value (Teach inactive). The limiting value previously learned will be lost in the process. If, however, the Teach operating mode is configured to "1"- and "0"-active, it is not possible anymore to reset to the configured limiting value via this object during ongoing operation of the device! The new limiting value set with the Teach function remains unchanged until a new presetting (externally via object or by a new Teach function). An ETS programming operation resets a limiting value automatically to the ETS presettings if this is provided for in the configuration (see below).

- i** A limiting value set previously via the 2-byte object will be lost during execution of the Teach function. With the "Teach inactive" command, the brightness limiting value programmed by the ETS is always switched over to.
- i** Whenever several telegrams of the same polarity are received in succession on the Teach object with the "Teach active" command, a new save operation of the brightness limiting value is executed.

Limiting value presetting with ETS programming

The parameter "Overwrite limiting value in device for ETS download?" determines whether an actively set and active limiting value by previous external object presetting or by Teach is overwritten by the limiting value configured in the ETS during ETS programming. If the setting is

"yes", the last value preset externally or by Teach and still active is replaced automatically by the ETS presetting. If the setting is "no", the last limiting value preset externally or by Teach still remains active even after ETS programming.

- i** If the parameter "Overwrite limiting value in device for ETS download?" is set to "no" and no external presetting has been made yet - if provided for in the configuration - via the 2-byte object or by Teach after the first ETS commissioning, the device always works with the value configured in the ETS. The ETS parameter only becomes invalid within the above configuration after an external presetting or after a Teach.
- i** A bus voltage failure does not reset limiting values preset by the 2-byte object or by Teach. The disabling function has no effect on the external presetting of a new limiting value.

4.2.4.6.3 Disabling function

The limiting value evaluation can be disabled independently of the other functional units via the disabling function. A disabled limiting value evaluation is deactivated. No telegrams are then transmitted anymore via the output objects. The presetting of new brightness limiting values by an external brightness value or by the Teach function is not influenced by the disabling function, however.

The disabling function can be used if the parameter "Use disabling function?" is configured on the parameter page "BLV - Disable" to "yes". The disabling function is then activated and deactivated via the object "BLV - Disable input" in which the ETS telegram polarity is configurable. The disabling function can be activated by force after bus voltage return or after ETS programming.

Disabling function after bus voltage return

The state of the disabling function after bus voltage return is configurable and can be configured to the following settings...

- Setting "deactivated":
After bus voltage return, the brightness limiting values are ready for operation immediately. The configured thresholds for each output are compared with the current brightness value and evaluated. If the brightness value exceeds or does not reach the corresponding thresholds, the configured telegrams are transmitted.
- Setting "activated":
After bus voltage return, all brightness limiting values are disabled. The configured thresholds are not evaluated with the current brightness value. Thus, no telegram is transmitted via any output.
- Setting "state as before bus voltage failure":
If the device detects a bus voltage failure, it saves the current state of the disabling function. After bus voltage return, the disabling function adopts the saved state again (active or inactive).

Disabling function after ETS programming

The state of the disabling function after ETS programming is also configurable. The state can be configured as follows...

- Setting "deactivated":
After ETS programming, the brightness limiting values are ready for operation immediately. The configured thresholds for each output are compared with the current brightness value and evaluated. If the brightness value exceeds or does not reach the corresponding thresholds, the configured telegrams are transmitted.
- Setting "activated":
After ETS programming, all brightness limiting values are disabled. The configured thresholds are not evaluated with the current brightness value. Thus, no telegram is transmitted via any output.

4.2.4.7 IR remote control (accessory)

Certain settings for the device can also be carried out optionally with an IR remote control. This is recommended, for instance, if the user should carry out settings on the twilight level, sensitivity of the motion detection or on the run-on-time after commissioning using the ETS. With the remote control it is also possible to influence the motion evaluation manually and thus the switching on and off of the automatic mode and walking test function.

The IR remote control can only be used if the ETS configuration of a device provides for this. For this purpose, the parameter "IR remote control" can be set to "enabled" on the parameter page "Remote control (IR)".

- i** The IR remote control only influences the function block 1! Other function blocks - if in use - cannot be influenced by the IR remote control.
- i** When the device successfully receives commands of the IR remote control, it confirms this by briefly flashing the blue status LED.

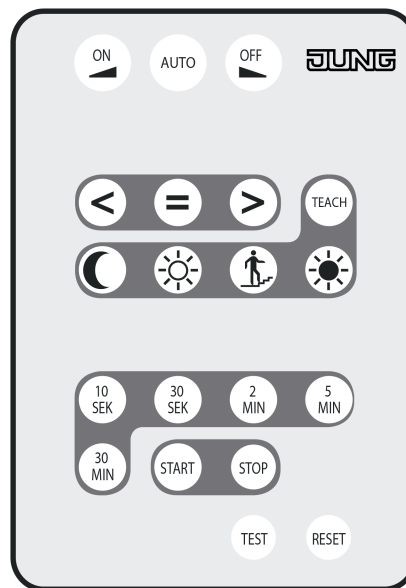



Figure 61: Buttons on the IR remote control

Push-button functions

The functions of the individual pushbuttons of the IR remote control are described in detail in the chapter entitled "Operation" of this documentation .

Parameters for the pushbutton functions define to what extent individual pushbuttons of the IR remote control can execute functions...

- Parameter "Operating mode presetting":
The **ON** , **AUTO** or **OFF**  buttons are influenced by this parameter. Depending on the parameter setting, the buttons can be deactivated individually.
- Parameter "'Test' button for walking test function":
The walking test function of the device can be activated and deactivated by pressing the **Test** button, but only if the button is also in the function. This parameter defines whether the button of the IR remote control is available in the function or not.

Disabling function

All buttons of the IR remote control can be disabled via the bus using the disabling function. The disabling function can be configured if the parameter "Use disabling function?" is configured to "yes" on the parameter page "IR - General". The disabling function is then activated and deactivated via the communication object "Disable IR input" in which the telegram polarity is configurable. During an active disable, no settings can be made via the IR remote control.

The state of the disabling function after bus voltage return can be configured in the ETS. The following settings are possible...

- "deactivated":
After bus voltage return, the IR remote control is ready for operation immediately.
- "activated":
After bus voltage return, the IR remote control is completely disabled.
- "State as before bus voltage failure":
The current state of the disabling function will be stored in case of bus voltage failure. After bus voltage return, the device tracks the saved disabling state (active or inactive).

The state of the disabling function after ETS programming can also be configured in the ETS. The following settings are possible here...

- "deactivated":
After ETS programming, the IR remote control is ready for operation immediately.
- "activated":
After ETS programming, the IR remote control is completely disabled.

4.2.4.8 General reset behaviour

The device - depending on configuration - has various feedback objects. These objects can be configured as "actively transmitting" so that a feedback telegram can be transmitted automatically to the bus when the state changes. These objects then transmit the current object value constantly even after bus voltage return in order to initialize other bus subscribers. A high telegram load can result after bus voltage return, particularly in large KNX systems with many sensors. To counteract such an overload, a transmission delay after bus voltage return is configurable with this device. This transmission delay only takes effect for automatically transmitting objects of the device after bus voltage return and is configured by the parameter "delay after bus voltage return" on the parameter page "General". It is recommended to configure different delay times in the individual sensors so that the devices do not transmit at the same time.

- i The delay is not active after ETS programming. In this case, the actively transmitting objects transmit their status immediately once the device has been restarted after the reset.

The functional units of the device (e.g. function blocks for motion evaluation, light control) can be set by configuration to a defined behaviour after bus voltage return or after ETS programming. For this purpose, the parameters "Behaviour after bus voltage return" and "Behaviour after ETS programming" are provided, which are available - depending on the functional unit - on the associated parameter pages.

The disabling functions can also be active automatically after bus voltage return depending on requirements. For this purpose, some disabling functions have their own parameters. Alternatively, disabling functions for defining the behaviour after bus voltage return or after ETS programming are influenced via the aforementioned parameters.

4.2.4.9 Delivery state

In the unprogrammed delivery state, the device behaves passively. It transmits no telegrams to the bus when a motion is detected. The IR remote control (accessory) is enabled in this state so that the walking test can be activated and executed by the IR remote control. As soon as the device has been programmed in the ETS, it is ready for operation.

- i The device flashes the status LED slowly (approx. 0.75 Hz) to indicate that a wrong application has been programmed into its memory by the ETS. Applications are non-executable even if they are intended for use in the ETS product database but cannot be combined with the selected device hardware. It should generally be ensured that the device hardware used matches the ETS configured device. The status LED flashes slowly even if the application program has been removed by the ETS. In both cases, the device is without function.

4.2.5 Parameters

Description	Values	Comment
<input type="checkbox"/> General		
Delay after bus voltage return Minutes (0...59)	0...59	<p>The device - depending on configuration - has various feedback objects. These objects can be configured as "actively transmitting" so that a feedback telegram can be transmitted automatically to the bus when the state changes. These objects then transmit the current object value constantly even after bus voltage return in order to initialize other bus subscribers. A high telegram load can result after bus voltage return, particularly in large KNX systems with many sensors. To counteract such an overload, a transmission delay after bus voltage return is configurable here. This transmission delay only takes effect for automatically transmitting objects of the device after bus voltage return. It is recommended to configure different delay times in the individual sensors so that the devices do not transmit at the same time.</p> <p>The delay is not active after ETS programming. In this case, the actively transmitting objects transmit their status immediately once the device has been restarted after the reset.</p> <p>Setting the delay time minutes.</p>
Seconds (0...59)	0...17...59	<p>Setting the delay time seconds.</p>
<input type="checkbox"/> Motion and light sensor		
Basic sensitivity of all PIR sectors	high low	<p>With application program of version 1.2, it is possible, in conjunction with devices from release version "V01" (printed on the device label), to influence the digital evaluation of all PIR sensors in terms of sensitivity. It is possible here to optionally reduce the basic sensitivity in order to reduce or even fully suppress unwanted motion detections in extensive installation environments (large detection radius) in parts. The signal evaluation of interfering signals in the outer detection area (e.g. air movements) can be influenced in particular - depending on their intensity - so that they no longer result in a motion detection. The detection of body heat motions or other motions in the immediate proximity of the device is not significantly affected, however, owing to a reduced basic sensitivity.</p>

If the setting is "low", this parameter reduces the basic sensitivity globally to a dimension defined by the manufacturer. This takes place quite independently of the individual default sensitivity of the individual PIR sectors. Even at low basic sensitivity, the sensitivity of individual PIR sectors can still be configured and influenced as described.

We generally recommend setting the basic sensitivity to "high". It should only be reduced if undesirable false triggers frequently occur in the long-distance range, particularly in the case of ceiling detector applications for large detection areas.

i The application program of version 1.2 can also be programmed in older devices (no release version "V01" or higher). In this case, the parameter for basic sensitivity will not be evaluated. With the application program of version 1.1, it is generally not possible to configure the basic sensitivity even if this application program is programmed in devices from release version "V01". In the cases last mentioned above, the devices always work with high basic sensitivity.

Sensitivity
PIR sector A

Sensor switched-off
25 %
50 %
75 %
100 %

The sensitivity of the motion detection, which is a gauge for the range of the PIR evaluation, can be configured here for the PIR sector A. The configuration can be adjusted directly on the device using the adjuster or with the aid of the IR remote control (accessory) after commissioning.

Sensitivity
PIR sector B

Sensor switched-off
25 %
50 %
75 %
100 %

The sensitivity of the motion detection, which is a gauge for the range of the PIR evaluation, can be configured here for the PIR sector B. The configuration can be adjusted directly on the device using the adjuster or with the aid of the IR remote control (accessory) after commissioning.

Sensitivity
PIR sector C

Sensor switched-off
25 %
50 %
75 %
100 %

The sensitivity of the motion detection, which is a gauge for the range of the PIR evaluation, can be configured here for the PIR sector C. The configuration can be adjusted directly on the device

		using the adjuster or with the aid of the IR remote control (accessory) after commissioning.
Adjuster for sensitivity of PIR sectors A-C	deactivated activated	The adjuster on the device makes it possible to change the configured sensitivity setting of <u>all</u> PIR sectors. The sensitivity can thereby be reduced or increased by a maximum of one level. This parameter enables the adjuster. With the parameter setting "deactivated", the adjuster is without function.
Interlock of all PIR-sectors by external telegram when	OFF ON ON and OFF	When the luminaires activated by the device are in the detection field, the switching on and off of the luminaires can result in motion detection due to changing thermal radiation. To prevent this inaccuracy, the switching status of the luminaires must be guided to the 1-bit object "Interlock PIR sensor". When a corresponding status telegram is received, the motion detection is disabled for a configurable lockout time, so that no motion is detected due to the changing thermal radiation. An ongoing lockout time is restarted upon receiving a new corresponding status telegram. This parameter defines the polarity of the telegrams that induce the interlocking of the PIR sectors.
Lockout time Seconds (0...59)	0... 3 ...59	This parameter defines the lockout time of the PIR sensor. The time is started by a telegram to the object "Interlock of PIR sensor" according to the polarity defined by the parameter "Interlock of all PIR-sectors by external telegram when".
Transmitting the brightness value	on change cyclical on change and cyclical only on read request	The brightness value determined by the device can be made available to the KNX system via the 2 byte-communication object "Measured brightness value". The device can transmit the brightness value actively and/or cyclically for a configured brightness change. It is also possible to only provide the brightness value passively and to transmit this on request. This parameter determines the transmission behaviour.

Transmit on brightness change by (5...200 Lux)	5 Lux... 20 Lux ...200 Lux in 5-Lux increments	This parameter defines the value by which the brightness value determined by the device must change so that this can be transmitted automatically to the bus. This parameter is only visible with the setting "transmission of the brightness value = on change" or "transmission of the brightness value = on change and cyclical".
Time for cyclical transmission Minutes (0...59)	0... 3 ...59	This parameter defines the time interval between two telegrams for the cyclical transmission of the brightness value. Setting the cycle time minutes.
Seconds (0...59)	0 ...59	Setting the cycle time seconds. These parameters are only visible with the setting "transmission of the brightness value = cyclical" or "transmission of the brightness value = on change and cyclical".
Sensor calibration	Factory calibration Calibration by telegram	The value for the brightness to be determined on the work surface or floor surface by the device depends on the measured brightness on the light guide. The brightness on the light guide is derived from the reflected brightness on the underlying surface. To determine the brightness on the measuring surface from the measured brightness on the light guide, the reflection coefficient of the surface must be known. In the factory calibration, the reflection coefficient for the measuring surface is set to 0.3. This already makes an adjustment to many surfaces possible. To compensate for any deviations of the determined brightness during factory calibration to the real brightness on the work surface, the brightness measurement can be calibrated using a calibration function (adjustment of the reflection coefficient) and thus adapted to special surface finishes (setting: "Calibration by telegram"). During calibration, an externally preset brightness value at the workplace is assigned to the currently measured brightness on the light guide. This presetting is made via the 2-byte communication object "sensor calibration".
	Do not transmit brightness value	If the parameter "sensor calibration" is set to "calibration by telegram", the

Behaviour in the event of a calibration not carried out	transmit invalid brightness value (\$7FFF)	device will not evaluate any brightness until a user calibration has been carried out! In this case, all function blocks and the light control will therefore have no function until a calibration has been carried out properly. The brightness value tracked via the object "Measured brightness value" can be influenced by this parameter in the event of a calibration not yet carried out. Depending on the setting, the device will either transmit no brightness value (value "0" in the object) or the value "7FFF" (hexadecimal) to indicate an invalid brightness measured value.
Walking test after ETS programming	deactivated activated	The device has a walking test function. The walking test function serves as a guide during the project design and setting of the PIR detection area. The walking test indicates the reaction of the device when detecting motions by means of a blue status LED that is clearly visible behind the sensor window. The walking test can be active immediately after the ETS commissioning, or alternatively, can be activated or deactivated using the IR remote control (accessory) during ongoing operation of the device. To activate the walking test via the ETS configuration, this parameter must be set to "activated". After subsequently programming the application program in the ETS, the walking test is then activated automatically. It is possible to deactivate a walking test with the aid of the ETS by resetting this parameter to "deactivated" and reprogramming the application program.
Display of motion impulses via walking test LED	only with active walking test with active walking test and in normal operation	The blue status LED is activated by the walking test. Optionally, the status LED can signal detected motions even in normal operation by configuring this parameter to the setting "with active walking test and in normal operation". The signalling enables the start and duration of the motion detection to be visualized by the device at any time. With the setting "only with active walking test" the status LED is only activated during motion detections in the walking test.

□-| Function blocks (FB)

Use function block 1?	yes	The first function block is always activated and enabled for application.
Group assignment function block 1	no group assigned Group 1 Group 2	The first function block is assigned optionally to a function block group by this parameter so that it can be activated and deactivated during the function block switch-over. Function blocks not assigned to any function block group (setting "no group assigned") are not influenced by the function block switch-over and thus always work autonomously.
Use function block 2?	yes no	This parameter enables the second function block if required.
Group assignment function block 2	no group assigned Group 1 Group 2	The second function block is assigned optionally to a function block group by this parameter so that it can be activated and deactivated during the function block switch-over. Function blocks not assigned to any function block group (setting "no group assigned") are not influenced by the function block switch-over and thus always work autonomously.
Use function block 3?	yes no	This parameter enables the third function block if required.
Group assignment function block 3	no group assigned Group 1 Group 2	The third function block is assigned optionally to a function block group by this parameter so that it can be activated and deactivated during the function block switch-over. Function blocks not assigned to any function block group (setting "no group assigned") are not influenced by the function block switch-over and thus always work autonomously.
Use function block 4?	yes no	This parameter enables the fourth function block if required.
Group assignment function block 4	no group assigned Group 1 Group 2	The fourth function block is assigned optionally to a function block group by this parameter so that it can be activated and deactivated during the function block switch-over. Function blocks not assigned to any

		function block group (setting "no group assigned") are not influenced by the function block switch-over and thus always work autonomously.
Use function block 5?	yes no	This parameter enables the fifth function block if required.
Group assignment function block 5	no group assigned Group 1 Group 2	The fifth function block is assigned optionally to a function block group by this parameter so that it can be activated and deactivated during the function block switch-over. Function blocks not assigned to any function block group (setting "no group assigned") are not influenced by the function block switch-over and thus always work autonomously.
Use switch-over of the function block groups?	yes no	The function block switch-over can be used if required. The function block switch-over makes it possible to toggle between two function block groups, in which assigned function blocks, for example, can be switched over depending on the time of day or depending on the state of the KNX system. This makes it possible to continuously change over during operation of the device and thus change its function (e.g. during the day presence detector for light control, during the night ceiling detector for service light / presence detector if present, detector for KNX signalling systems if absent). By the assignment of a function block to a function block group by the parameter "group assignment..." this is only active if the corresponding function block group is also active. Function blocks of deactivated groups are then also deactivated and do not react. The function block switch-over can be used if this parameter is set to "yes". The 1-bit object "FB groups input switch-over" is visible and the group assignment of the function blocks in the ETS relevant in this case only.
Polarity of function block group switch-over	0 = group 1 / 1 = group 2 1 = group 1 / 0 = group 2	This parameter defines the telegram polarity for the function block group switch-over. Similarly, the polarity of the status telegrams of the function block group switch-over is defined by this

parameter.

Switch-over behaviour

The switch-over of a function block group on receipt of a switch-over telegram can optionally take place directly or only at the end of a current motion detection.

immediately

In the immediate switch-over of the function block groups, the current motion detections of the assigned function blocks of the current group are ended immediately and the "behaviour at the end of a detection" is executed. After activation of the new function block group, the value for the new function block group is then transmitted to the bus via the object "FB groups output status switch-over" as positive acknowledgement. The polarity of the status telegram corresponds to the telegram polarity for the switch-over.

after ending a detection

To identify the end of a current motion detection, no assigned function blocks must be in an active motion detection anymore. If a motion detection of one or more assigned function blocks is still active at the desired switch-over time (receipt of telegram), the function block group is not switched over. The group active until now continues to remain active. The value for the current function block group is first transmitted via the object "FB groups output status switch-over" as negative acknowledgement. Here too, the polarity of the status telegram corresponds to the telegram polarity for the switch-over. At the end of the motion detection, the function block group as last requested - if the switch-over was not cancelled again by a new switch-over telegram - is then switched over and the value of the new function block group is transmitted via the status object.

Active group after bus voltage return

Group 1 active

Group 2 active

After bus voltage return and after ETS programming, the active function block group can be preset via this parameter. The assigned function blocks of the predefined group then process its configured behaviour after bus voltage return or after ETS programming (according to the configuration of the function block). The assigned function blocks of the deactivated function block group are inactive and do not react.

□-| FBx - General (x = 1...5)

Application	<p>Ceiling detector</p> <p>Presence detector</p> <p>Detector</p> <p>Presence detector for light control</p>	<p>Definition of the function block application. The setting "presence detector for light control" can only be configured for the first function block. This parameter - just like the parameter "application type" and "operating mode" - should be configured to the necessary setting at the very start of the device configuration, since all other function block parameters and objects depend on the above parameters.</p>
Application type	<p>Single device</p> <p>Main device</p> <p>Extension</p>	<p>Definition of the function block application type. It is possible to use several devices in a room to extend the detection area by combining a device configured as a main unit with several devices configured as an extension. A single device always works autonomously.</p> <p>In the application "detector", the application type is preset to "single device". With a "presence detector for light control" (only FB1), the device can only work as a "single device" or as a "main unit".</p> <p>This parameter - just like the parameter "application" and "operating mode" - should be configured to the necessary setting at the very start of the device configuration, since all other function block parameters and objects depend on the above parameters.</p>
Operating mode	<p>Fully automatic (Auto ON, Auto OFF)</p>	<p>In the case of function blocks with the application "ceiling detector" or "presence detector", the operating mode can be configured here. The operating mode specifies the function of the motion detection and defines whether or not the beginning and the end of a motion detection is identified automatically. This makes it possible to adjust the motion detection to many applications in private and public areas (e.g. toilet lighting, service lighting, control of ventilation systems).</p> <p>In this operating mode, the outputs of a function block are activated automatically by the motion detection and brightness evaluation. Manual activation of the device is not necessary.</p>

Semi-automatic I (manual ON, Auto OFF)	<p>In this operating mode, an ON telegram must first be transmitted to the object "Lighting manual ON/OFF" before a motion (including ext. motion) is detected and evaluated. At the same time, the ON telegram starts the first motion detection including the transmission delay. The end of the detection is identified automatically or initiated by an OFF telegram to the object "Lighting manual ON/OFF". Afterwards, a manual ON telegram is required again, in order to evaluate a new motion.</p>
Semi-automatic II (Auto ON, Manual OFF)	<p>In this operating mode, a detection is identified automatically as in the operating mode "Fully automatic". After detection of a motion and output of the telegrams for "beginning of a detection", no transmission delay is started. Thus, the end of the detection can only be achieved by an OFF telegram to the object "Lighting manual ON/OFF". The function block is then ready again for a new motion evaluation. This operating mode is not configurable in the application "presence detector for light control". This setting cannot be selected for the application "presence detector for light control".</p>
Behaviour after bus voltage return	<p>This parameter - just like the parameter "application" and "application type" - should be configured to the necessary setting at the very start of the device configuration, since all other function block parameters and objects depend on the above parameters.</p>
no reaction	<p>After bus voltage return, various states of operation (possibly with telegram output) can be adopted for the application types "single device" and "main unit". The behaviour of a function block is defined by this parameter. A distinction should be made as to whether the function block works autonomously or in combination with the light control (only for FB1).</p> <p>Autonomous operation: The function block switches to basic state (no motion, transmission delay inactive, disabling function inactive). No telegram output takes place.</p> <p>Combination with light control: The function block switches to basic state (no motion, transmission delay inactive, disabling function inactive). The</p>

	presence information for the light control is inactive.
Disabling function active	<p>Autonomous operation: With this setting the function block is set to the disabling state after bus voltage return. If a telegram output is configured at the beginning of the disabling function, these telegrams are then transmitted. The basic state (no motion, transmission delay inactive, disabling function inactive) is set as previous state for the disabling function.</p> <p>Combination with light control: After bus voltage return, the function block is set to the disabling state. The disabling information is transferred to the light control whereby the behaviour at the beginning of the disabling function is executed. If a telegram output is configured on the light control at the beginning of the disabling function, these telegrams are then transmitted.</p>
state as at the beginning of a detection	<p>Autonomous operation: With this setting, the state changes to that of an active motion detection after bus voltage return (an evaluation delay is not processed). The processing of the motion detection is only subject to the configured twilight level evaluation. In brightness-independent detection, the configured telegrams are transmitted at the beginning of the detection and the transmission delay started. In brightness-dependent detection, the configured telegrams are transmitted at the beginning of the detection, the transmission delay started and brightness-independent motion detection switched-over to only if the brightness values are below the twilight level. If no further motion is then detected, the device processes the end of the detection after the transmission delay has elapsed.</p> <p>Combination with light control: After bus voltage return, the motion state is set to "Motion detected" (presence information for light control active) and the transmission delay started. Depending on the brightness in the room, the light control is started up by the light control, and if no further motion is detected, stepped down again after the transmission delay has elapsed. If the brightness is sufficient, no telegrams are output by the light control.</p>
State as before bus voltage failure	With this setting, the state of the function block is adopted again as it was before bus voltage failure.

Behaviour after ETS programming

The behaviour configured here is not executed if the function block is not active (e.g. by function block switch-over, walking test) or the "Behaviour after ETS programming operation" is executed.

In the application types "single device" and "main unit", various states of operation (possibly with telegram output) can be adopted after ETS programming. The behaviour of a function block is defined by this parameter. A distinction should be made as to whether the function block works autonomously or in combination with the light control (only for FB1).

no reaction

Autonomous operation: The function block switches to basic state (no motion, transmission delay inactive, disabling function inactive). No telegram output takes place.

Combination with light control: The function block switches to basic state (no motion, transmission delay inactive, disabling function inactive). The presence information for the light control is inactive.

Disabling function active

Autonomous operation: With this setting the function block is set to the disabling state after ETS programming. If a telegram output is configured at the beginning of the disabling function, these telegrams are then transmitted. The basic state (no motion, transmission delay inactive, disabling function inactive) is set as previous state for the disabling function.

Combination with light control: After ETS programming, the function block is set to the disabling state. The disabling information is transferred to the light control whereby the behaviour at the beginning of the disabling function is executed. If a telegram output is configured on the light control at the beginning of the disabling function, these telegrams are then transmitted.

state as at the beginning of a detection

Autonomous operation: With this setting, the state changes to that of an active motion detection after ETS programming (an evaluation delay is not processed). The processing of the motion detection is only subject to the configured twilight level evaluation. In brightness-independent detection, the configured telegrams are transmitted at the beginning of the detection and the

transmission delay started. In brightness-dependent detection, the configured telegrams are transmitted at the beginning of the detection, the transmission delay started and brightness-independent motion detection switched-over to only if the brightness values are below the twilight level. If no further motion is then detected, the device processes the end of the detection after the transmission delay has elapsed.

Combination with light control: After ETS programming, the motion state is set to "Motion detected" (presence information for light control active) and the transmission delay started. Depending on the brightness in the room, the light control is started up by the light control, and if no further motion is detected, stepped down again after the transmission delay has elapsed. If the brightness is sufficient, no telegrams are output by the light control.

The behaviour configured here is not executed if the function block is not active (e.g. by function block switch-over, walking test).

Function output 1

Up to two output communication objects are available per function block via which the switching and control commands are transmitted on the bus to the KNX actuator, e.g. lighting system, room temperature control. The data format of the object of output 1 is defined depending on the function configured here and adapted to the controllable function units of the KNX system.

No function

The output is deactivated. There is no separate output communication object available.

Switching

1-bit switching telegrams (ON, OFF) can be output. Example application: Switching lighting.

Staircase function

1-bit switching telegrams (ON, OFF) are output cyclically in order to trigger the run-on-time in the activated KNX actuator. Example application: Switching staircase lighting

Switching with forced position

2-bit switching telegrams can be output for the forced position of an actuator channel in accordance with DPT 2.001. This makes it possible to set switching states with a higher priority (ON, OFF). Example application: Switching lighting

	by forced control (cleaning lighting, service light).
Dimming value transmitter	1-byte brightness value telegrams in accordance with DPT 5.001 (0...100 %) can be output. Example application: Dimming lighting.
Light scene extension	1-byte telegrams in accordance with DPT 18.001 (1...64) can be output for the scene recall. Example application: Recall actuator scenes (e.g. TV lighting).
Temperature value transmitter	2-byte temperature value telegrams in accordance with DPT 9.001 (0...+40 °C configurable in 1 °C-increments) can be output. Example application: Preset temperature setpoints.
Brightness value transmitter	2-byte brightness value telegrams in accordance with DPT 9.004 (0...2,000 Lux configurable in 50-Lux increments) can be output. Example application: Preset lighting setpoints.
Operating mode room temperature controller	1-byte telegrams for switching over the operating mode of a KNX room temperature controller in accordance with DPT 20.102 (comfort, standby, night, frost/heat protection, automatic operation) can be output. Example application: Influence room temperature control.
	In the application type "extension", no output functions are available. Therefore, these are then only configurable in the main unit. In the application "detector", the output 1 preset to the detector function (1-bit switching telegrams).
Function output 2	Up to two output communication objects are available per function block via which the switching and control commands are transmitted on the bus to the KNX actuator, e.g. lighting system, room temperature control. The data format of the object of output 2 is defined depending on the function configured here and adapted to the controllable function units of the KNX system.
No function	The output is deactivated. There is no separate output communication object available.
Switching	1-bit switching telegrams (ON, OFF) can be output. Example application: Switching lighting.
Staircase function	

		1-bit switching telegrams (ON, OFF) are output cyclically in order to trigger the run-on-time in the activated KNX actuator. Example application: Switching staircase lighting
	Switching with forced position	2-bit switching telegrams can be output for the forced position of an actuator channel in accordance with DPT 2.001. This makes it possible to set switching states with a higher priority (ON, OFF). Example application: Switching lighting by forced control (cleaning lighting, service light).
	Dimming value transmitter	1-byte brightness value telegrams in accordance with DPT 5.001 (0...100 %) can be output. Example application: Dimming lighting.
	Light scene extension	1-byte telegrams in accordance with DPT 18.001 (1...64) can be output for the scene recall. Example application: Recall actuator scenes (e.g. TV lighting).
	Temperature value transmitter	2-byte temperature value telegrams in accordance with DPT 9.001 (0...+40 °C configurable in 1 °C-increments) can be output. Example application: Preset temperature setpoints.
	Brightness value transmitter	2-byte brightness value telegrams in accordance with DPT 9.004 (0...2,000 Lux configurable in 50-Lux increments) can be output. Example application: Preset lighting setpoints.
	Operating mode room temperature controller	1-byte telegrams for switching over the operating mode of a KNX room temperature controller in accordance with DPT 20.102 (comfort, standby, night, frost/heat protection, automatic operation) can be output. Example application: Influence room temperature control.
		In the application type "extension", no output functions are available. Therefore, these are then only configurable in the main unit. In the application "detector", the output 2 cannot be configured.
□- FBx - Sensor assignment (x = 1...5)		
Assignment PIR sector A	assigned	The device detects motions digitally via 3 PIR sectors with a total detection area of 360°, in which each PIR sector covers a subarea of 120°. The function blocks of the device can be assigned as required to the PIR sectors for coordinating the detection area. This is carried out via this parameter. The
	not assigned	
Assignment PIR sector B	assigned	
	not assigned	

Assignment PIR sector C	<p>assigned</p> <p>not assigned</p>	<p>motion signals of all assigned PIR sectors of a function block are logical OR linked and combined to a motion signal.</p>
Detection of the brightness value by	<p>Internal sensor</p> <p>External sensor (object)</p> <p>Internal and external sensor (combined value)</p>	<p>The device has a brightness sensor, which is guided laterally from the housing by a light guide on the lens surface of the device for determining workplace brightness or ambient brightness. The brightness value determined by this internal sensor can be supplied to a function block internally for the twilight level evaluation. Optionally, an external 2-byte brightness value in accordance with DPT 9.004 can also be made available to the function block via the bus. This makes it possible to carry out the twilight level evaluation independently of the installation location of the device (e.g. provision of an external brightness value via a more favourably installed extension). In special cases, it is possible to link the determined brightness value of the internal sensor to an external brightness value. In this way, the light measurement of a function block can take place at 2 locations. At the same time, both sensor values are weighted for determining the effective brightness value.</p> <p>This parameter defines which sensors are used for the brightness evaluation of a function block.</p>
Weighting of the brightness values internal to external	<p>95% to 5%</p> <p>90% to 10%</p> <p>85% to 15%</p> <p>80% to 20%</p> <p>75% to 25%</p> <p>70% to 30%</p> <p>65% to 35%</p> <p>60% to 40%</p> <p>55% to 45%</p> <p>50% to 50%</p> <p>45% to 55%</p> <p>40% to 60%</p> <p>35% to 65%</p> <p>30% to 70%</p> <p>25% to 75%</p> <p>20% to 80%</p> <p>15% to 85%</p> <p>10% to 90%</p> <p>5% to 95%</p>	<p>This parameter defines the weighting of the brightness measured values from the internal sensor to the external sensor. The parameter is only visible if the brightness value is detected by means of a combined value from an internal and external sensor.</p>

□- FBx - Brightness evaluation (x = 1...5)

Evaluation of the twilight level ? **yes (brightness dependent operation)**

no (brightness independent operation)

During the motion detection in the applications "ceiling detector" and "presence detector", the evaluation of the twilight level can take place brightness-independently or brightness-dependently. In the brightness-independent evaluation, no brightness value is taken into account during the processing of a motion. Each motion then triggers a new detection process in the idle state. This configuration, for instance, is interesting for lighting-independent applications (e.g. presence detection for room temperature controls). In the brightness-dependent evaluation, the measured brightness value in relation to the effective twilight level is taken into account for processing a motion detection. The function block then only detects motions when the measured brightness value is below the set twilight level. This configuration is normally used to control lighting systems in corridors or rooms with some levels of daylight.

The following parameters are only available with brightness-dependent motion detection...

Twilight level (10...2,000 Lux)

10...**500**...2,000

The twilight level is preset by this parameter. This value can optionally be changed by an external twilight level value (via object) or with the Text function in state of operation and thus adapted to the user's needs. An additional setting is possible for the function block 1 via the IR remote control (accessory).

Overwrite twilight level in device for ETS-download?

yes
no

This parameter determines whether an actively set and active twilight level value by previous external object presetting or by Teach is overwritten automatically by the twilight level configured in the ETS during ETS programming. If the setting is "yes", the last value preset externally or by Teach and still active is replaced by the ETS presetting. If the setting is "no", the last twilight level preset externally or by

Object "Presetting twilight level"	<p>disabled</p> <p>enabled</p>	<p>Teach still remains active even after ETS programming.</p> <p>If this parameter is set to "no" and no external presetting has been made yet - if provided for in the configuration - via the 2-byte object or by Teach after the first ETS commissioning, the device always works with the ETS configured value. The ETS parameter only becomes invalid within the above configuration after an external presetting or after a Teach.</p>
Feedback "Active twilight level"	<p>active signalling object</p> <p>passive status object</p>	<p>The feedback of the twilight level effectively set in the function block is possible via the 2-byte object "Active twilight level" in accordance with DPT 9.004. This object can optionally act as an active signalling object or passive status object (object is readable). As an active signalling object, the current twilight level brightness value is transmitted once to the bus on each change of the twilight level, after ETS programming or after bus voltage return (optionally delayed).</p>
Evaluation of the twilight level	<p>only in the main unit</p>	<p>With the application types "single device" and "main unit" an external motion signal can be transmitted to the device. If the twilight level evaluation is configured to "brightness-dependent", the evaluation of the external motion detections can be influenced. This parameter defines the behaviour on receipt of a motion telegram on the main unit.</p> <p>External motion signals are ignored by the main unit if the brightness is above the twilight level.</p>

	in main unit and extension	External motion signals are always evaluated by the main unit even if the brightness is above the twilight level. This parameter is only visible with the application type "Main unit".
Evaluation of the twilight level with external motion telegram	<p>yes (brightness dependent operation)</p> <p>no (brightness independent operation)</p>	<p>With the application types "single device" and "main unit" an external motion signal can be transmitted to the device. If the twilight level evaluation is configured to "brightness-dependent", the evaluation of the external motion detections can be influenced. This parameter defines the behaviour on receipt of a motion telegram on as single device.</p> <p>External motion signals are ignored if the brightness is above the twilight level.</p> <p>External motion signals are always evaluated even if the brightness is above the twilight level.</p> <p>This parameter is only visible with the application type "single device".</p>
Use Teach function ?	<p>yes</p> <p>no</p>	<p>With the Teach function, the effective brightness value is applied instantly by transmitting a corresponding telegram to the 1-bit object "Teach twilight level" as a new twilight level value. The object is configurable if this parameter is set to "yes".</p>
Polarity for object "Teach twilight level"	<p>0 = inactive / 1 = active</p> <p>0 = active / 1 = inactive</p> <p>0 = active / 1 = active</p>	<p>The polarity of a Teach telegram is configurable by this parameter. Depending on the configuration, it is possible to reset to the configured twilight level upon receiving the opposite object value (Teach inactive). The twilight level previously learned will be lost in the process. If, however, the Teach polarity is configured to "1"- and "0"-active, it is no longer possible to reset to the configured twilight level via this object during ongoing operation of the device!</p> <p>This parameter is visible only if the teach function is enabled.</p>
<p>□- FBx - Beginning of detection (x = 1...5)</p> <p>Use evaluation delay?</p>	<p>yes</p> <p>no</p>	<p>This parameter enables the evaluation delay. The evaluation delay at the beginning of a motion detection ensures</p>

that no reaction to just a brief motion (e.g. when quickly striding through a room) takes place. The motion is only processed during a longer-lasting detection and - if configured - the telegram is transmitted at the beginning of the detection. During the detection of the first motion impulse of a new motion, the configured delay time of the transmission delay is initially started. After the delay time has elapsed, a check takes place within a time frame of 30 seconds to determine whether a motion is still present. If an ongoing motion is detected within this monitoring time, the telegram is then transmitted at the beginning of the detection and the transmission delay (possibly retriggering + standard delay 10 s + additional transmission delay) is started. If no motion is detected anymore within the monitoring time, the device transmits no telegram and does not start the standard delay and additional transmission delay either. A newly detected motion after that restarts the evaluation delay. An evaluation delay is not possible in the operating mode "semi-automatic I (manual ON, Auto OFF)" and in alert operation.

Delay time **0...59**
Minutes (0...59)

This parameter defines the delay time when evaluation delay is active. Definition of the delay time minutes.

Seconds (0...59) **0...30...59**

Definition of the delay time seconds.

FBx - End of detection (x = 1...5)

Additional transmission
delay type

A total motion always ends after the standard delay and additional transmission delay elapses. The standard delay time is preset to 10 seconds. The additional transmission delay is added to this time. The additional transmission delay can either be set discretely by parameter in the ETS, or alternatively, calculated by the device by means of self-learning. This parameter defines how the additional transmission delay is determined.

according to parameter

The additional transmission delay is configured in the ETS.

adaptive

With this setting, the device determines the additional transmission delay independently, depending on the frequency of the motion impulses within

		a range defined by the user.
Additional transmission delay Minutes (0...59)	0...59	This parameter defines the additional transmission delay. Setting the additional transmission delay minutes.
Seconds (0...59)	0...30...59	Setting the additional transmission delay seconds. This parameter is only visible if the additional transmission delay is to be preset via parameter.
Time extension for additional transmission delay	no extension Factor via object	Optionally, the time defined in the ETS can be extended by a 1-byte factor received via the bus. This makes it possible to dynamically adapt the additional transmission delay user-defined via the bus. The time extension is possible when this parameter is set to "Factor via object". In this case, the device evaluates the value of the object "Factor additional transmission delay" (DPT 5.010) and calculates the additional transmission delay (received factor x configured time). A newly received factor is first applied actively after a restart or when retriggering the transmission delay. Thus, the time of an ongoing transmission delay is not influenced immediately by a newly received factor. If the function block is inactive when a new factor is received (e.g. disabling function active, deactivated by the function block switch-over, walking test active), the value received is evaluated later during activation of the function block. After ETS programming or after bus voltage return, the device always works with the factor "1" (-> additional transmission delay = parameter value) until an object value is received.
Hysteresis for switch-off brightness presence detector (10...800 Lux)	10...300...800	The switch-off brightness in presence detector operation (only with the application types single device and main unit) is preset for brightness-dependent operation via this parameter. The switch-off brightness is calculated as follows: Switch-off brightness = effective twilight level + switch-off hysteresis (in Lux). If the measured brightness exceeds the set switch-off brightness during an active presence detection, no further

Teach function for switch-off brightness	<p>disabled</p> <p>enabled</p>	<p>motions are evaluated. The device then transmits the configured telegram at the end of the detection after the effective transmission delay, or alternatively, after a separately configurable switch-off delay (see parameter "Transmission delay upon reaching the switch-off brightness").</p> <p>With the Teach function, the effective brightness value is applied instantly by transmitting a corresponding telegram to the 1-bit object "Teach switch-off brightness" as a new switch-off brightness. The object is configurable if this parameter is set to "enabled".</p>
Overwrite switch-off brightness in device for ETS-Download?	<p>yes</p> <p>no</p>	<p>This parameter determines whether a switch-off brightness preset to active by Teach and which is active is overwritten automatically by the switch-off brightness configured in the ETS during ETS programming. If the setting is "yes", the last switch-off brightness preset by Teach and still active is replaced by the ETS presetting. If the setting is "no", the last switch-off value preset externally or by Teach still remains active even after ETS programming.</p> <p>If this parameter is set to "no" and no Teach has taken place yet - if provided for in the configuration - , the device always works with the ETS configured value. The ETS parameter in the above configuration only becomes invalid after a Teach.</p> <p>This parameter is visible only if the teach function is enabled.</p>
Teach operating mode	<p>0 = inactive / 1 = active</p> <p>0 = active / 1 = inactive</p> <p>0 = active / 1 = active</p>	<p>The polarity of a Teach telegram is configurable by this parameter. Depending on the configuration, it is possible to reset to the configured switch-off brightness upon receiving the opposite object value (Teach inactive). The switch-off brightness previously learned will be lost in the process. If, however, the Teach polarity is configured to "1"- and "0"-active, it is not possible anymore to reset to the configured switch-off brightness via this object during ongoing operation of the device!</p> <p>This parameter is visible only if the teach function is enabled.</p>

Transmission delay
after reaching the
switch-off brightness

This parameter determines the type of delay time if the measured brightness reaches or exceeds the set switch-off brightness during an active presence detection. The delay upon reaching or exceeding the switch-off brightness is used for the debouncing of brief light reflexes and prevents faulty switching of the lighting. If the switch-off brightness is fallen below again before the delay has elapsed, the device then cancels the switch-off process. Detected motions then retrigger the transmission delay. The switch-off delay is only configured in presence detector operation.

**like additional
transmission delay**

The delay time is defined by the effective additional transmission delay. No further settings are necessary.

Switch-off delay

The delay time can be configured as a separate switch-off delay in the ETS (see parameter "Time for switch-off delay").

Time for switch-off
delay
Minutes (0...59)

0...**5**...59

This parameter defines the switch-off delay.
Setting the switch-off delay minutes.

Seconds (0...59)

0...59

Setting the switch-off delay seconds.

These parameters are only visible if the switch-off delay is to be started after reaching or exceeding the switch-off brightness.

Measurement of the
time period after end of
the last motion

deactivated
activated

In brightness-independent operation, a function block can - depending on the configured operating mode - determine the time period after a last motion and transmit it to the bus via a communication object. This function, for example, allows simple monitoring of people's movements in assisted living or in a senior citizens' residence. The function is activated if this parameter is set to "activated".

Feedback "Time after
last motion"

active signalling object
passive status object

The current counter value for measuring the time period after the end of the last motion is tracked in the 2-byte communication object "Time after last motion" in the data format "minutes" in accordance with DPT 7.006. This object can act as an active signalling object, or alternatively, as a passive status object. This parameter is only visible if the time measurement is enabled.

<p>Cycle time for automatic transmission Hours (0...59)</p>	<p>0...59</p>	<p>As an active signalling object, the object "Time after last motion" transmits the current counter status cyclically to the bus. The cycle time can be configured here. Setting the cycle time hours.</p>
<p>Minutes (10...59)</p>	<p>10...59</p>	<p>Setting the cycle time minutes.</p> <p>These parameters are only visible if the time measurement is enabled and the object is actively transmitting.</p>
<p>□↵ FBx - Output 1 (x = 1...5)</p>		
<p>Send telegram at the beginning of the detection?</p>	<p>yes no</p>	<p>Here, it is defined whether a telegram is transmitted via the output object at the beginning of a detection.</p>
<p>Telegram at the beginning of the detection</p>	<p>ON telegram OFF telegram</p>	<p>This parameter defines the telegram at the beginning of the detection for the output function "Switching". This parameter is only visible if a telegram should be transmitted at the beginning of a detection.</p>
<p>Telegram at the beginning of the detection</p>	<p>ON telegram</p>	<p>In the staircase function, an ON telegram is always transmitted at the beginning of the detection. This parameter is only visible if the output function is configured to "Staircase function" and a telegram should be transmitted at the beginning of a detection.</p>
<p>Forced position at the beginning of the detection</p>	<p>Forced position active, ON Forced position active, OFF Forced position inactive</p>	<p>This parameter defines the telegram at the beginning of the detection for the output function "Switching with forced position". This parameter is only visible if a telegram should be transmitted at the beginning of a detection.</p>
<p>Dimming value at the beginning of the detection (0...100 %)</p>	<p>0...100</p>	<p>This parameter defines the telegram at the beginning of the detection for the output function "Dimming value transmitter". This parameter is only visible if a telegram should be transmitted at the beginning of a detection.</p>

<p>Light scene number at the beginning of the detection (1...64)</p>	<p>1...64</p>	<p>This parameter defines the telegram at the beginning of the detection for the output function "Light scene extension". This parameter is only visible if a telegram should be transmitted at the beginning of a detection.</p>
<p>Temperature value at the beginning of the detection</p>	<p>0 °C...23 °C...40 °C in 1 °C increments</p>	<p>This parameter defines the telegram at the beginning of the detection for the output function "Temperature value transmitter". This parameter is only visible if a telegram should be transmitted at the beginning of a detection.</p>
<p>Brightness value at the beginning of the detection</p>	<p>0 Lux...1,000 Lux... 2,000 lux in 50-Lux increments</p>	<p>This parameter defines the telegram at the beginning of the detection for the output function "Brightness value transmitter". This parameter is only visible if a telegram should be transmitted at the beginning of a detection.</p>
<p>Operating mode at the beginning of the detection</p>	<p>Auto Comfort Standby Night Frost/heat protection</p>	<p>This parameter defines the telegram at the beginning of the detection for the output function "Operating mode room temperature controller". This parameter is only visible if a telegram should be transmitted at the beginning of a detection.</p>
<p>Cyclical transmission during the detection?</p>	<p>yes no</p>	<p>Setting this parameter to "yes" activates the cyclical telegram output during a motion detection. The cyclical output only occurs during detected heat motions and within the standard delay. During an active additional transmission delay, no cyclical transmission takes place. If the device detects a new motion again (retriggering) during an ongoing additional transmission delay, the standard delay is restarted and the cyclical telegram output is either resumed (if the last cycle time has not yet elapsed after the previous telegram), or restarted by immediate transmission (if the last cycle time has already elapsed).</p>
<p>Time for cyclical transmission Minutes (0...59)</p>	<p>0...59</p>	<p>The time for the cyclical transmission is defined here. Setting the cycle time minutes.</p>

Seconds (0...59)	0... 10 ...59	Setting the cycle time seconds. These parameters are only visible if the transmission should be cyclical during a motion detection and the standard delay.
Triggering of a telegram when retriggering?	yes no	If the cyclical transmission is not activated, an output can repeat the telegram at the beginning of the transmission when retriggering. Retriggering takes place when the device detects a new motion during an ongoing additional transmission delay. No telegram is transmitted when retriggering during the standard delay! This parameter enables the triggering of a telegram when retriggering? (setting "yes"). This parameter is only visible if the transmission should not be cyclical during a motion detection and the standard delay.
Send telegram at the end of the detection?	yes no	Here, you it can be defined whether a telegram is transmitted via the output object at the end of a detection.
Telegram at the end of the detection	ON telegram OFF telegram	This parameter defines the telegram at the end of the detection for the output function "Switching". This parameter is only visible if a telegram should be transmitted at the end of a detection.
Telegram at the end of the detection	OFF telegram	In the staircase function, an ON telegram is always transmitted at the end of the detection. This parameter is only visible if the output function is configured to "Staircase function" and a telegram should be transmitted at the end of a detection.
Forced position at the end of the detection	Forced position active, ON Forced position active, OFF Forced position inactive 0...100	This parameter defines the telegram at the end of the detection for the output function "Switching with forced position". This parameter is only visible if a telegram should be transmitted at the end of a detection.

Dimming value at the end of the detection (0...100 %)

This parameter defines the telegram at the end of the detection for the output function "Dimming value transmitter". This parameter is only visible if a telegram should be transmitted at the end of a detection.

Light scene number at the end of the detection (1...64)

This parameter defines the telegram at the end of the detection for the output function "light scene extension". This parameter is only visible if a telegram should be transmitted at the end of a detection.

Temperature value at the end of the detection 0 °C...**21 °C**...40 °C in 1 °C increments

This parameter defines the telegram at the end of the detection for the output function "Temperature value transmitter". This parameter is only visible if a telegram should be transmitted at the end of a detection.

Brightness value at the end of the detection 0 Lux...**750 Lux**...2,000 lux in 50-Lux increments

This parameter defines the telegram at the end of the detection for the output function "Brightness value transmitter". This parameter is only visible if a telegram should be transmitted at the end of a detection.

Operating mode at the end of the detection
 Auto
 Comfort
Standby
 Night
 Frost/heat protection

This parameter defines the telegram at the end of the detection for the output function "Operating mode room temperature controller". This parameter is only visible if a telegram should be transmitted at the end of a detection.

FBx - Output 2 (x = 1...5) - See output 1!

FBx - Disabling (x = 1...5)

Polarity of disable object **0 = enable / 1 = disable**

This parameter defines the polarity of the disabling object.

0 = disable / 1 = enable

Behaviour at the beginning of the disabling function

A telegram can be transmitted separately at the beginning of the disabling function via each output (according to the configured function) for

the application types "single device" and "main unit". This parameter defines whether a telegram is transmitted. In the application "Alert operation" or in the application type "Extension", a telegram output is not provided for at the beginning of the disabling function. Here, the function block is merely interlocked.

On activation of the disabling function, ongoing transmission delays and switch-off delays are stopped and reset. The current state (motion active/inactive) of the motion detection is frozen and saved.

disable and send no telegram

At the start of the disabling function, the function block is interlocked. No telegram is transmitted.

disable and send telegram

At the start of the disabling function, the function block is interlocked. A telegram is transmitted according to configuration (see following parameter).

The following parameters "...at the beginning of the disabling function" are - if configured -available separately for the output 1 and 2.

Telegram at the beginning of the disabling function

ON telegram

This parameter defines the telegram at the beginning of the disabling function for the output function "Switching" and "Staircase function".

OFF telegram

This parameter is only visible if a telegram should be transmitted at the beginning of a the disabling function.

Forced position at the beginning of the disabling function

Forced position active, ON

This parameter defines the telegram at the beginning of the disabling function for the output function "Switching with forced position".

Forced position active, OFF

This parameter is only visible if a telegram should be transmitted at the beginning of a the disabling function.

Forced position inactive

Dimming value at the beginning of the disabling function (0...100 %)

0...100

This parameter defines the telegram at the beginning of the disabling function for the output function "Dimming value transmitter".

This parameter is only visible if a

		telegram should be transmitted at the beginning of a the disabling function.
Light scene number at the beginning of the disabling function (1...64)	1...64	This parameter defines the telegram at the beginning of the disabling function for the output function "Light scene extension". This parameter is only visible if a telegram should be transmitted at the beginning of a the disabling function.
Temperature value at the beginning of the disabling function	0 °C... 21 °C ...40 °C in 1 °C increments	This parameter defines the telegram at the beginning of the disabling function for the output function "Temperature value transmitter". This parameter is only visible if a telegram should be transmitted at the beginning of a the disabling function.
Brightness value at the beginning of the disabling function	0 Lux... 750 Lux ... 2,000 lux in 50-Lux increments	This parameter defines the telegram at the beginning of the disabling function for the output function "Brightness value transmitter". This parameter is only visible if a telegram should be transmitted at the beginning of a the disabling function.
Operating mode at the beginning of the disabling function	Auto Comfort Standby Night Frost/heat protection	This parameter defines the telegram at the beginning of the disabling function for the output function "Operating mode room temperature controller". This parameter is only visible if a telegram should be transmitted at the beginning of a the disabling function.
Behaviour at the end of the disabling function	enable and send no telegram enable and reaction as at end of a detection	This parameter defines the behaviour of all outputs at the end of the disabling function. The motion state is set to "no motion" (transmission delay not active). No telegrams are transmitted. This setting is unalterably active in the application type "extension" or in the application "detector". At the end of the disabling function, the behaviour at the "end of a detection" configured in the ETS is executed for each output (including telegram output) in order to restore the basic state of the actuator. The motion state is set to "no motion" (transmission delay active).

		After the configured lockout time has elapsed, the function block is then ready again - if the actuator activates the lockout - for a new motion detection.
	enable and reaction as at the start of a detection	At the end of the disabling function, the behaviour for "beginning of a detection" configured in the ETS, is executed for each output. For this purpose, a motion detection is simulated (including beginning of the transmission delay) whereby the telegrams are transmitted at the beginning of a detection. If no further motion is detected, the device processes the end of the detection after the transmission delay has elapsed (automatic switch-over to the basic state).
	enable and state as before the disabling function	To restore the state to how it was before the disabling function, the stored state of the motion detection at the beginning of the disabling function is evaluated. The output then reacts as follows... Motion state was "no motion" -> Behaviour as "enable and reaction as at end of a detection". Motion state was "Motion/presence present" -> Behaviour as "enable and reaction as at beginning of a detection".
<p>☐ Light control (LC)</p>		
Light control	disabled	This parameter enables the light control. If light control is enabled, all parameters and communication objects necessary for the light control are visible. The light control is always enabled here if this works in combination with the first function block.
	enabled	
<p>☐ LC - General</p>		
Effect of the brightness value-feedback on the actuator	active signalling object	It is necessary to know the current brightness level of the activated KNX actuator for some control processes (e.g. after ETS programming, after bus voltage return or after manual control intervention in the lighting). For this purpose, the brightness value-feedback of an actuator from output channel 1 must always be linked to the object "Feedback brightness value" of the light control. This parameter informs the light control as to how the actuator performs the feedback. This can then take place by actively transmitting (the actuator transmits the brightness value independently on change) or
	passive status object	

		alternatively, passively (the actuator does not transmit independently / it is requested by the object of the light control via a read telegram). Thus, the setting of this parameter must be adapted to the configuration of the actuator.
Behaviour after bus voltage return		The behaviour of the light control after bus voltage return can be defined here.
	no reaction	With this setting, the light control is in normal state after bus voltage return. It can be activated and operated regularly.
	Activate disabling function	With this setting, the light control is set to the disabling state after bus voltage return. The configured behaviour is executed at the beginning of the disabling function.
	state of disable fct as before bus voltage failure	With this setting, the disabling state of the light control is adopted as it was before bus voltage failure. If the disabling function should be activated, the configured behaviour is executed at the beginning of the disabling function.
		This parameter is only configurable if the light control works autonomously (independently of FB1). The reset behaviour is determined by the parameter of the function block in combination with the first function block!
Behaviour after ETS programming		The behaviour of the light control after ETS programming is definable here.
	no reaction	With this setting, the light control is in normal state after ETS programming. It can be activated and operated regularly.
	Activate disabling function	With this setting, the light control is set to the disabling state after ETS programming. The configured behaviour is executed at the beginning of the disabling function.
		This parameter is only configurable if the light control works autonomously (independently of FB1). The reset behaviour is determined by the parameter of the function block in combination with the first function block!
Adaptation of the control dynamic in the brightness range		The light control needs certain parameters that define the brightness range in the room. These parameters

are important for calculating certain control characteristics from which, among other things, the control dynamic and thus the subjective perceived comfort of the feedback control are derived. This parameter defines whether the light control works with standard control parameters that the manufacturer has predefined and generally adapted to many applications, or whether the control parameters can be customized.

Standard

The light control works with a standard configuration preset by the manufacturer. The control dynamic is thus adapted effectively to very many applications. The maximum illuminance is then not configurable in the ETS. This is calculated automatically depending on the setpoint configured in the ETS (factor x 1.2) and entered in the light control. When dimensioning the lighting system on-site, it must be ensured that the installed lighting can always supply brightness levels that correspond to the value "configured setpoint x 1.2". The lower brightness threshold is preconfigured to 0 Lux with this setting (no special control dynamic in the lower brightness range).

user-defined

With user-defined control dynamic the maximum illuminance (10...2,000 Lux) and lower brightness threshold (0...2,000 Lux) can be configured in the ETS. In this way, it is possible to customize the control parameters to special applications.

Maximum illuminance "Maximum value" (10...2,000 Lux) 10...**720**...2,000

The required control parameters in user-defined setting include the information regarding which maximum illuminance can be set by the lighting in the room (artificial light). In the case of a large difference between the brightness in the room and the setpoint, this maximum value defines larger control output changes or increments and thus increases the control dynamic (fast adjustment to the setpoint by larger control output commands). The maximum illuminance is also used for calculating the control output for the adaptive start up control. This control parameter must be configured to the maximum brightness value adjustable by the lighting (P-component of the light control). The

		<p>maximum value of the lighting is typically a factor of 1.2 higher than the setpoint configured in the ETS. When configuring the control parameters, the following dependency should be noted: Lower brightness threshold < Setpoint < Maximum illuminance.</p>
<p>Lower brightness threshold "darkness value" (0...2,000 Lux)</p>	<p>0...200...2,000</p>	<p>The darkness value of the room lighting (lower brightness threshold) is also decisive for the light control. If the lower brightness threshold is fallen below, the time between the control output telegrams is shortened thereby resulting in a higher control dynamic here as well. When configuring the control parameters, the following dependency should be noted: Lower brightness threshold < Setpoint < Maximum illuminance.</p>
<p>Setpoint</p>	<p>20 Lux, 50 Lux, 100 Lux, ... 600 Lux, ... 1,000 lux from 50 Lux in 50-Lux increments</p>	<p>The brightness setpoint corresponds to the value of the desired brightness that the light control is to set and keep as constant as possible with the aid of an assigned lighting device while taking changing external light influences into account. During the control phase, the lighting is only readjusted if the measured brightness value is not within the preset setpoint range. The lower limiting value of the setpoint range is preset directly by the "setpoint" (Setpoint range = setpoint + hysteresis). The "setpoint" thus represents the minimum brightness to be maintained. This parameter defines the setpoint. The possible adjustment range of the parameter depends on the configuration of the control dynamic. In a standard control dynamic, this parameter is visible. The setpoint can thus be configured within the range from 20 Lux to 1,000 Lux. As a result, virtually all standard applications are covered.</p>
<p>Setpoint (10...2,000 Lux)</p>	<p>10...600...2,000</p>	<p>The brightness setpoint corresponds to the value of the desired brightness that the light control is to set and keep as constant as possible with the aid of an assigned lighting device while taking changing external light influences into account. During the control phase, the lighting is only readjusted if the measured brightness value is not within the preset setpoint range. The lower</p>

		<p>limiting value of the setpoint range is preset directly by the "setpoint" (Setpoint range = setpoint + hysteresis). The "setpoint" thus represents the minimum brightness to be maintained.</p> <p>This parameter defines the setpoint. The possible adjustment range of the parameter depends on the configuration of the control dynamic. In user-defined control dynamic, this parameter is visible. The setpoint is thus continuously configurable within a range from 10 Lux to 2,000 Lux. This allows extended setpoint presettings for special applications.</p>
Hysteresis setpoint (+10...+50 %)	10...50	<p>In order to avoid permanent readjustment of the connected lighting device due to slight brightness and measurement value fluctuations, a setpoint range with a lower and upper limiting value is defined for the setpoint presetting. The upper limiting value is determined by the presetting of a relative hysteresis value (percentage) in relation to the setpoint.</p> <p>This parameter defines the hysteresis value. In this way, the upper limit of the setpoint range is derived directly from the effective setpoint.</p>
Overwrite setpoint in device for ETS-download?	yes no	<p>This parameter determines whether an actively set and active setpoint set by previous external object presetting or by Teach is overwritten automatically by the setpoint configured in the ETS during ETS programming. If the setting is "yes", the last value preset externally or by Teach and still active is replaced by the ETS presetting. If the setting is "no", the last setpoint preset externally or by Teach still remains active even after ETS programming.</p> <p>If the parameter is set to "no" and no external presetting has been made yet - if provided for in the configuration - via the 2-byte object or by Teach after the first ETS commissioning, the device always works with the ETS configured value. The ETS parameter only becomes invalid within the above configuration after an external presetting or after a Teach.</p>
Object "Preset setpoint"	disabled enabled	<p>The currently set brightness setpoint can be reset in accordance with DPT 9.004 by transmitting a 2-byte brightness value</p>

		<p>to the object "Preset setpoint". The object is configurable if this parameter is set to "enabled". The setpoint received via the object remains unchanged until a new setpoint presetting (by means of external setpoint presetting, setpoint shift or Teach) or until a new reset command to the object "Setpoint Reset". Even a bus voltage failure will not reset the brightness setpoint received via the bus. An ETS programming operation resets the setpoint automatically to the ETS presettings if this is provided for in the configuration.</p>
Allow setpoint shift?	yes no	<p>With the setpoint shift the setpoint can be changed within the configured limits during the control phase by direct control of the assigned lighting. The setpoint shift is enabled when this parameter is set to "yes".</p> <p>The setpoint shift is started by transmitting relative 4-bit dimming telegrams to the object "setpoint shift" during the control phase. At the same time, the light control controls the lighting via the relative dimming object of the first channel and thereby sets another brightness value. When the desired brightness is reached, a stop telegram must be received via the object "setpoint shift" which is then transmitted to channel 1 and output to the lighting.</p>
Upper limit setpoint shift (10...2,000 Lux)	10... 2,000	<p>The upper limiting value of the setpoint shift is configured here. If this upper limiting value is exceeded during the setpoint shift, the setpoint shift then stops automatically after detecting that the limiting value has been exceeded. The device then transmits a stop telegram to the bus via channel 1. The corresponding limiting value is then applied as new setpoint value instead of the set brightness value.</p> <p>This parameter is only visible if setpoint shift is enabled.</p>
Lower limit setpoint shift (10...2,000 Lux)	10 ...2,000	<p>The lower limiting value of the setpoint shift is configured here. If this lower limiting value is fallen below during the setpoint shift, the setpoint shift stops automatically after detecting this. The device then transmits a stop telegram to the bus via channel 1. The corresponding limiting value is then applied as new setpoint value instead of</p>

		<p>the set brightness value. This parameter is only visible if setpoint shift is enabled.</p>
Validity of the setpoint shift	<p>temporary till end of the current control phase</p> <p>permanently</p>	<p>With this parameter it is possible to define in the ETS whether a setpoint shift should only apply temporarily for the control phase that is currently active, or alternatively, should be applied permanently. If the setpoint shift is applied permanently, the set setpoint remains unchanged until a new setpoint presetting (by means of external setpoint presetting, setpoint shift or Teach) or until a new reset command via the object "Setpoint Reset". Even a bus voltage failure will not reset the brightness setpoint value. An ETS programming operation resets the setpoint automatically to the ETS presettings if this is provided for in the configuration. This parameter is only visible if setpoint shift is enabled.</p>
Teach function	<p>disabled</p> <p>enabled</p>	<p>With the Teach function, the effective brightness value is applied instantly by transmitting a corresponding telegram to the 1-bit object "Setpoint Teach" as a new brightness setpoint. The object is configurable if this parameter is set to "enabled".</p>
Teach operating mode	<p>0 = inactive / 1 = active</p> <p>0 = active / 1 = inactive</p> <p>0 = active / 1 = active</p>	<p>The polarity of a Teach telegram is configurable by this parameter. Depending on the configuration, it is possible to reset to the configured setpoint upon receiving the opposite object value (Teach inactive). The setpoint previously learned will be lost in the process. If, however, the Teach polarity is configured to "1"- and "0"- active, it is not possible anymore to reset to the configured setpoint via this object during ongoing operation of the device! This parameter is visible only if the teach function is enabled.</p>
Feedback "Setpoint effective"?	<p>yes</p> <p>no</p>	<p>The object "setpoint effective" that can be enabled by this parameter can be used for the feedback of the setpoint set effectively in the light control (lower limit setpoint range).</p>

Effect of the feedback	active signalling object passive status object	<p>The object "setpoint effective" contains the active setpoint of the light control and can either transmit the value actively on change, or make it available passively. As an active signalling object, the current value is transmitted once automatically to the bus on each change of the setpoint, after ETS programming or after bus voltage return (optionally delayed).</p> <p>This parameter is only visible if the feedback object is enabled.</p>
Number of lighting channels to be controlled	1 (Channel 1) 2 (Channel 1, 2) 3 (Channel 1, 2, 3)	<p>The light control can control up to three lighting groups. Up to 3 output channels are available for this purpose. It is possible to adapt control outputs for various installation locations of the lighting groups in the room by using several channels, for example. Thus, a lighting group near the window, for example, can be controlled by small control outputs as lighting in the centre of the room. These with less control outputs, used in turn as lighting in a remote recess.</p> <p>The number of channels can be defined via this parameter.</p>
<p>The following parameters is only configurable in the case of 2 or 3 channels...</p>		
Offset behaviour for channel 2 / for channel 2 and 3	Offset fixed with increasing control output	<p>If several channels are used, the control output of the feedback control in the startup and main control phase only takes place with absolute 1-byte dimming values. The basic regulation (control output calculation) always relates to channel 1. The control outputs of channels 2 and 3 are always calculated in relation to the control output of the first channel via corresponding offset settings. Three methods are available for calculating the control outputs of channel 2 and 3. This parameter defines which method is used.</p> <p>If this method is chosen, a fixed offset value is selected for channels 2 and 3 for the output control of the first channel. The offset remain constant across the</p>

		entire control output range. The offset calculation always starts from the control output "1" of channel 1. For the control output "0" (OFF), the control outputs of channel 2 and 3 are also set to "0".
	Offset increasing with increasing control output	With this method, the offset value is increased for channel 2 or 3 with increasing control outputs of channel 1. This takes place until channel 2 or 3 has reached the limiting value 255. The offset settings for the control outputs of channel 2 and 3 are specified in percentage relative to the control output of channel 1. Offset settings less than 100 % result in a negative offset value and offset settings greater than 100 % result in a positive offset value for the control output of the first channel.
	Offset decreasing with increasing control output	With this setting, the offset value for channel 2 or 3 is reduced continuously from the start offset with increasing control outputs of the first channel until a limiting control output of channel 1. The offset for channels 2 and 3 is always "0" from the limiting control output of channel 1 which results in a synchronization of the output channels. The offset calculation always starts from the control output "1" of channel 1. For the control output "0" (OFF), the control outputs of channel 2 and 3 are also set to "0".
ON-OFF hysteresis in the case of negative offset Channel 2 / Channel 2 und 3 (0...90)	0... 20 ...90	To prevent channels 2 and 3 from being switched too frequently in the case of negative offset in the threshold range, an ON-OFF hysteresis can be configured in relation to the control outputs of channel 1. The ON-OFF hysteresis should be less than the offset value for channel 1 or less than the start offset. This parameter is only visible with the offset behaviour "Offset fixed with increasing control output" and "Offset decreasing with increasing control output".
Offset Channel 2 to channel 1 (-128...127)	-128... 50 ...127	This parameter defines the static offset to channel 1 for the second channel with the offset behaviour "Offset fixed with increasing control output".
Offset Channel 3 to channel 1 (-128...127)	-128... 50 ...127	This parameter defines the static offset to channel 1 for the third channel with the offset behaviour "Offset fixed with

		increasing control output". This parameter is only visible if 3 channels are available.
Offset Channel 2 to channel 1 (1...200 %)	0... 150 ...200	This parameter defines the relative offset to channel 1 for the second channel with the offset behaviour "Offset increasing with increasing control output".
Offset Channel 3 to channel 1 (1...200 %)	0... 50 ...200	This parameter defines the relative offset to channel 1 for the third channel with the offset behaviour "Offset increasing with increasing control output". This parameter is only visible if 3 channels are available.
Start offset Channel 2 to channel 1 (-128...127)	-128... 50 ...127	To configure the offset setting "Offset decreasing with increasing control output", a start offset must be preset for channel 2.
Start offset Channel 3 to channel 1 (-128...127)	-128... -50 ...127	To configure the offset setting "Offset decreasing with increasing control output", a start offset must be preset for channel 3. This parameter is only visible if 3 channels are available.
Control output from channel 1 for synchronization to Channel 2 (0...255)	0... 200 ...255	To configure the offset behaviour "Offset decreasing with increasing control output", a control output from channel 1 must be preset for the synchronization to channel 2 (no more offset available in the case of larger control outputs).
Control output from channel 1 for synchronization to Channel 3 (0...255)	0... 200 ...255	To configure the offset behaviour "Offset decreasing with increasing control output", a control output from channel 1 must be preset for the synchronization to channel 3 (no more offset available in the case of larger control outputs). This parameter is only visible if 3 channels are available.
<input type="checkbox"/> LC - Control behaviour		
Startup control behaviour		The start up control phase represents the start behaviour of the light control and should quickly ensure sufficient

	brightness in the room. For this purpose, the brightness value setpoint is compared with the measured brightness value at the beginning of the startup control phase. If the measured value is greater or equal to the setpoint, the main control state is changed to immediately. If the measured value is below the setpoint, the configured startup control behaviour is executed.
Switch on	If the currently determined brightness value is less than the preset setpoint, the light control switches on the assigned lighting via a switching telegram (1-bit). The lighting is activated by the channel object "Switching". This setting cannot be selected in the case of 2 or 3 channels.
Control output presetting (relative dimming)	If the currently determined brightness value is less than the preset setpoint, the light control dims up the lighting via cyclically output dimming step telegrams until the brightness value has reached or even exceeded the setpoint. The increment of the dimming telegrams and the time for the telegram repetition are configurable (optional). After reaching or exceeding the setpoint limit, a stop telegram is transmitted. In the case of dimmer actuators with steep dimming curves, slight overshooting may occur that is then offset again by the main control phase. The lighting is activated by the channel object "Switching". This setting cannot be selected in the case of 2 or 3 channels.
Control output presetting (brightness value)	If the light control detects a lower brightness value than the preset setpoint, the lighting is then switched on by transmission of a configured dimming value. If a higher brightness value is preset (e.g. 100 %), this results in a brightness jump (like when switching on), which is then offset again by the main control phase if the higher brightness value is not required. The lighting is activated by the channel object "brightness value".
Ctr output presetting adaptive (brightness value)	With this startup control behaviour, depending on the currently measured brightness by the light control, a control output (1-byte) is calculated and transmitted automatically by means of the setpoint presetting and defined brightness range in order to approximately reach the exact setpoint range. The lighting is activated by the channel object "brightness value".

Dimming step width	100 % 50 % 25 % 12.5 % 6 % 3 % 1 %	If the startup control behaviour is executed via relative dimming commands (4-bit), the dimming step width can be configured here.
Telegram repetition	yes no	If the startup control behaviour is executed via relative dimming commands (4-bit), a telegram repetition can be configured here. A telegram repetition is advisable if the dimming step width is configured to values less than 100 % and should still be dimmed across the entire brightness range. Dimming processes can thus also be executed more smoothly in the actuators even in the case of steep dimming curves.
Time for telegram repetition Seconds (0...59)	0...59	The time for the cyclical telegram repetition is configure here. Setting the telegram repetition seconds.
Milliseconds (0...9 x 100)	0...5...9	Setting the telegram repetition milliseconds. This parameter is only visible if the telegram repetition is activated.
Waiting time after start up control Seconds (1...59)	1...5...59	Before changing from the start up control phase to the main control phase, the activated actuator should have reached its final value so that the feedback control can control with stable actuator states. For this purpose, the waiting time configurable here is started after the startup control phase. The main control phase is only changed to after this waiting time has elapsed. The length of the waiting time should be adapted to the startup control method used (e.g. longer waiting time with relative startup control behaviour) and the characteristics of the connected actuator (fast or slow dimming speed).
Control behaviour	Control output presetting (relative dimming) Control output presetting (brightness value)	In the main control phase, the light control adjusts the brightness of the lighting continuously to the active setpoint. At the same time, the data format used of the control outputs is configurable by the ETS parameter

	<p>"control behaviour". Alternatively, the lighting can be activated by absolute brightness value telegrams (channel object "brightness value") or by relative dimming step telegrams (channel object "dimming"). The setting "control output presetting (relative dimming)" cannot be selected in the case of 2 or 3 channels.</p>
<p>Minimum dimming step width</p> <p>12.5 % 6 % 3 % 1 %</p>	<p>This parameter defines in which steps the light control can dim the lighting by one telegram each, in the case of relative control output presetting.</p>
<p>Minimum control output change per dimming step (2...32)</p> <p>2...4...32</p>	<p>This parameter defines in which steps the light control can dim the lighting by one telegram each, in the case of absolute control output presetting.</p>
<p>Minimum repeat time for control outputs Seconds (1...59)</p> <p>1...2...59</p>	<p>This parameter specifies for the light control how long the minimum waiting time between two control output telegrams must be. Small dimming steps (relative 1...3% / absolute 2...10) with short repeat times (2...10 seconds) should normally be specified so that the light control is executed interruption-free and is subjectively pleasant. Since the dimming speed is primarily defined by the configuration of the actuator, the parameter of the light control should therefore be adapted to the dimming times of the actuators.</p>
<p>Influence behaviour in case of lower control output limit?</p> <p>yes</p> <p>no</p>	<p>When switching off the lighting in the room using the light control, it should be ensured during the main control phase that the lighting is not switched on again immediately by falling below the setpoint due to the light jump. For this purpose, the lower control output limit can be evaluated and a switch-off brightness can be configured.</p> <p>The light control only evaluates the lower control output limit if this parameter is set to "yes". In this case, it is possible to set additional parameters that specify the behaviour exactly.</p> <p>In the setting "no", no evaluation of the lower control output takes place. This is then set to the smallest possible control output. No reaction occurs once the lower control output limit is reached,</p>

whereby in this configuration a switch-off is not possible during the main control phase.

Lower control output limit
(1...128)

1...128

In the case of an absolute control output presetting - if this is evaluated - the lower control output limit is defined by this parameter within the range of 1...128 (0.4%...50%). The lower control output limit is preset to "1" if the behaviour of the control should not be influenced by the lower control output limit.

In the case of relative control output presetting, the lower control output limit cannot be configured. In this configuration, the device calculates rather the lower control output limit itself by means of the configured minimum dimming step width. The relative dimming step telegrams transmitted to the actuator then enable the light control to detect during the ongoing control process whether or not the lower control output limit has been reached. It is important that the activated KNX dimmer actuators can be dimmed to the lowest brightness level (basic brightness). The dimmable brightness range must not be limited by a minimum brightness on the actuators!

Behaviour if lower control output limit is fallen below

no reaction

The behaviour if the lower control output limit is fallen below can be configured here.

Once the lower control output limit is reached, the light control no longer reacts. A switch-off does not take place. The control output remains unchanged until the control has to dim up the lighting again or until the step down control phase is started due to the presence signal.

Switch off at switch-off brightness

As soon as the lower control output limit is reached and the switch-off brightness in the room has also been reached or exceeded, the light control switches off the lighting. The additional hysteresis for the switch-off brightness can only be configured in this setting.

Additional hysteresis setpoint for switch-off brightness
(0...+100 %)

0...10...100

After reaching the lower control output limit, the switch-off brightness in the room must also be reached or exceeded so that the lighting is switched off automatically during the main control

phase. The switch-off brightness is above the setpoint + hysteresis. The switch-off brightness is derived from an additional relative hysteresis value that is added to the hysteresis value of the setpoint:

$$\text{Switch-off brightness} = \text{setpoint} + (\text{setpoint} \times (\text{hysteresis setpoint} + \text{additional hysteresis switch-off brightness}))$$

The additional hysteresis for the switch-off brightness is configured here.

Behaviour at the beginning of the step down control phase

switch off immediately
transmit minimum control output

transmit configured control output *

The behaviour at the end of the control is determined in the step down control phase. This behaviour is defined by this parameter. The assigned lighting device can optionally be switched off immediately or first dimmed down to minimum brightness by transmitting the minimum control output. As a further alternative, it is possible for the device to transmit a configured control output (1...100 %).

*: Only with application version 1.2!

The following parameters for the step down control phase are only visible if a minimum or configured control output should be transmitted...

Step down control behaviour

Control output presetting (relative dimming)
Control output presetting (brightness value)

This parameter (value telegram "1" or dimming step telegram 100%) defines with which data format the minimum control output is transmitted. When transmitting a configured control output, the step down control behaviour must always be preset to "control output presetting (brightness value)".

Control output (1...100 %)

1...**50**...100

This parameter defines the control output transmitted at the beginning of the step down control phase. The parameter is only available in the application program of version 1.2 for the setting "Behaviour at the beginning of the step down control phase = Transmit configured control output"!

<p>Additional waiting time after step down control (Standard waiting time = 10 s) Minutes (0...59)</p>	<p>0...59</p>	<p>If the brightness is to be dimmed down to minimum brightness, a waiting time is started before starting the dimming process. The duration of the waiting time is derived from a standard waiting time (10 seconds) plus an additional waiting time that can be configured here. The standard waiting time ensures that the minimum brightness also can actually be set by the activated dimmer actuators before the end of the step down process. Setting the waiting time minutes.</p>
<p>Seconds (0...59)</p>	<p>0...59</p>	<p>Setting the waiting time seconds.</p>
<p>Behaviour on new presence detection during waiting time</p>	<p>ignore presence detection</p>	<p>During an ongoing waiting time in the step down control phase, a new presence can be transferred to the light control if, for example, people are present again in the room. In this case, this parameter defines how the light control should behave.</p> <p>In this setting, a presence detection is ignored. The light control then executes the step down control phase interruption-free until the end as preset. If the presence signal is still present at the end of the step down control phase, the light control restarts the startup control phase.</p>
	<p>Cancel step down phase and startup control anew</p>	<p>In this setting, the step down control phase is cancelled immediately during the detection of a new presence and the startup control phase is started at once interruption-free.</p>
<p>Behaviour after the waiting time has elapsed</p>	<p>Keep control output</p> <p>Switch off</p>	<p>After the waiting time has elapsed, this parameter decides which state the lighting adopts at the end of the control process. With the setting "switch off", the light control finally switches off the lighting. As an alternative to switching off, the minimum control output can also be kept constant. This setting is appropriate, for example, if a permanent basic brightness is to be set in the room (e.g. in long corridors or passageways).</p>
<p>Switch off by</p>	<p>Switching telegram (1-bit)</p> <p>Brightness value telegram (1-byte)</p>	<p>Here, you define with which data format the switch-off takes place at the end of the step down control phase.</p>

LC - Disable / Superimposed operation

Polarity of disable object	<p>0 = enable / 1 = disable</p> <p>0 = disable / 1 = enable</p>	<p>This parameter defines the telegram polarity of the disabling object. This parameter is only visible if the light control works autonomously (not in combination with FB1). The disabling function is activated and deactivated via the disabling object of the function block in combination with the first function block. In this case, the telegram polarity is configured on the parameter page "FB1 - Disable".</p>
Feedback "Status disabling function light control"?	<p>yes</p> <p>no</p>	<p>Optionally, the disabling status of the light control can be made available via the 1-bit object "Status disabling function light control". For this purpose, this parameter must be set to "yes". The disabling status is influenced by the disabling function and by the superimposed operation. A "1" indicates an active disabling function of the light control.</p>
Effect of the feedback	<p>active signalling object</p> <p>passive status object</p>	<p>The light control - if the object was enabled - transmits its own disabling status depending on this parameter either actively to the bus on each change, or it only provides the object value passively (object is readable).</p>
Behaviour at the beginning of the disabling function	<p>disable and send no telegram</p> <p>disable and send telegram</p> <p>execute disable and step down control behaviour</p>	<p>This parameter defines the behaviour of the light control if the disabling function is activated.</p> <p>At the start of disabling the function block, no telegrams are transmitted via the outputs. The assigned lighting is not influenced by the function block.</p> <p>At the start of the disabling function, freely configurable switching or brightness value telegrams can be output via the output channels in order to set the assigned lighting to the desired state. The telegrams are configured separately for each channel.</p> <p>With this setting, the configured step down control behaviour is executed on activation of the disabling function. Presence signals are ignored during execution of the step down control behaviour.</p>
Data format of the telegram	<p>Switching telegram (1-bit)</p>	<p>Here, it is defined which data format should activate the lighting of a channel at the beginning of the disabling</p>

	<p>Brightness value telegram (1-byte)</p>	<p>function. By setting the parameter you select whether the activation takes place via the 1-bit switching object or 1-byte brightness value object of a channel. This parameter is available separately for each channel and is only visible if the behaviour is configured to "disable and transmit telegram" at the beginning of the disabling function.</p>
<p>Telegram at the beginning of the disabling function</p>	<p>ON telegram OFF telegram</p>	<p>Here, the switching command of an output channel at the beginning of the disabling function is defined. This parameter is available separately for each channel and is only visible if the behaviour is configured to "disable and transmit telegram" at the beginning of the disabling function and the data format of the telegram is set to "switching telegram (1-bit)".</p>
<p>Dimming value at the beginning of the disabling function (0...100 %)</p>	<p>0...100</p>	<p>Here, the dimming value of an output channel at the beginning of the disabling function is defined. This parameter is available separately for each channel and is only visible if the behaviour is configured to "disable and transmit telegram" at the beginning of the disabling function and the data format of the telegram is set to "brightness value telegram (1-byte)".</p>
<p>Behaviour at the end of the disabling function</p>	<p>enable and send no telegram</p>	<p>On ending the disabling function, the light control is reset and the basic state (state OFF, no presence) set. The device then stops ongoing disabling reactions (e.g. step down control behaviour) immediately. This parameter defines the behaviour of the light control at the end of the disabling function. With this setting, the light control after enabling is internally in the state OFF and reacts to the newly received presence according to the configuration. The lighting state, which might have been changed externally during an active disabling function depending on the application, must be taken into account when enabling! At the end of the disabling function, the current existing lighting state will not be changed until new presence information by the light control. If control output presettings are made via absolute brightness values, the 1-byte object "Feedback brightness value" of the light</p>

		control must be connected to an actuator feedback object of channel 1 so that the light control knows the output state of the lighting. Otherwise, the light control may be adversely affected thereby resulting in erratic control behaviour.
	enable and switch off	At the end of the disabling function, the assigned lighting is switched off via the switching outputs in order to restore a defined basic state of the lighting. If a presence exists or a new presence is received, the control is restarted according to the measured brightness.
	execute enable and startup control behaviour	With this setting, a presence signal is activated artificially at the end of the disabling function. As a result, the startup control behaviour is executed automatically at the appropriate brightness value (determined brightness < value setpoint). The main control phase is then changed to. The further behaviour of the control process is dependent on the actual presence information.
Allow superimposed operation?	yes	With the superimposed operation, the assigned lighting device can be activated directly, for example, via a pushbutton or operating panel. In addition, the manually triggered switching or dimming commands to the lighting also have to be transmitted to the lighting control. For this purpose, the light control has 4 objects each with different data formats ("Input superimposed operation" - 1-bit switching, 4-bit relative dimming, 1-byte brightness value, 1-byte scene extension). By "listening in" to the telegrams via the named objects, the light control is disabled during the superimposed operation, whereby the lighting is no longer influenced by the control but only by the user. The objects of the superimposed operation are configurable if this parameter is set to "yes". Otherwise (setting "no"), a superimposed operation of the light control is not possible.
	no	
Enabling after superimposed operation	automatic at the end of the presence	The behaviour of the light control at the end of the superimposed operation is defined by this parameter. With this setting, the control is enabled automatically at the end of the tracked presence detection and the step down

control behaviour is executed. A distinction must be made here between the following cases:
 Light control in combination with function block 1: The automatic setting of the presence at the beginning of the superimposed operation ensures that the superimposed operation is always ended automatically in this application at the end of the presence detection after the transmission delay has elapsed and the step down control behaviour is executed. Additional (manual) intervention in the presence signal is not necessary here.
 Autonomous operation of the light control: With this application, the end of the presence (deactivation of the presence information) must be received actively via the object "Presence" in order to end the superimposed operation and execute the step down control behaviour. In this case, the superimposed operation can be ended alternatively via the disabling object (see setting "only via disabling object").

only via disabling object

With this setting, the disabling of the control after a superimposed operation can only be cancelled with an enabling telegram via the disabling object. With the enabling telegram the configured behaviour is executed at the end of the disabling function. It should be noted that in the combination of the light control with the first function block the enabling must take place via the disabling object of the function block (disabling object of the light control is then not present).

Brightness limiting values (BLV)

Function brightness limiting values	disabled
	enabled

The device has up to three mutually independent brightness limiting values that are continuously compared with the brightness value detected. If a limiting value configured in the ETS or predefined externally is exceeded or fallen below, the device can transmit switching, brightness value or scene recall telegrams to the bus and thus trigger appropriate reactions in other bus subscribers. The "Function brightness limiting values" must be enabled here so that the function can be configured and used.

BLV - General

Number of limiting values to be controlled	1 (Output 1)	Up to three limiting values can be evaluated. Each limiting value has its own output object. This parameter defines how many limiting values and thus how many output objects are configurable in the ETS.
	2 (Output 1, 2)	
	3 (Output 1, 2, 3)	

The following parameters are available separately for each limiting value (1...3)...



Limiting value definition	Limiting value is upper threshold	A brightness limiting value to be monitored always consists of an upper and lower brightness threshold. The brightness thresholds are assigned via a limiting value and hysteresis derived relatively from the limiting value. The type of limiting value (upper or lower threshold) must be preset accordingly here. Example of the limiting value definition: 1. Brightness limiting value = Upper threshold -> Lower threshold = Brightness limiting value - Hysteresis 2. Brightness limiting value = Upper threshold -> Lower threshold = Brightness limiting value + Hysteresis
	Limiting value is lower threshold	
Hysteresis (upper threshold)	+1 %... +10 % ...+20 % in 1 % increments	If the limiting value is the lower threshold, the upper threshold is defined by the hysteresis configurable here.
Limiting value (10...2,000 Lux) (lower threshold)	10... 1.000 ...2,000	The limiting value (lower threshold) is configured here. This parameter is only visible if the limiting value is the lower threshold.
Limiting value (10...2,000 Lux) (upper threshold)	10... 1.000 ...2,000	The limiting value (upper threshold) is configured here. This parameter is only visible if the limiting value is the upper threshold.
Hysteresis (lower threshold)	-1 %... -10 % ...-20 % in 1 % increments	If the limiting value is the upper threshold, the lower threshold is defined by the hysteresis configurable here.

<p>Overwrite limiting value in device for ETS download ?</p>	<p>yes no</p>	<p>This parameter determines whether an actively set and active limiting value by previous external object presetting or by Teach is overwritten by the limiting value configured in the ETS during ETS programming. If the setting is "yes", the last value preset externally or by Teach and still active is replaced automatically by the ETS presetting. If the setting is "no", the last limiting value preset externally or by Teach still remains active even after ETS programming. If this parameter is set to "no" and no external presetting has been made yet - if provided for in the configuration - via the 2-byte object or by Teach after the first ETS commissioning, the device always works with the ETS configured value. The ETS parameter only becomes invalid within the above configuration after an external presetting or after a Teach.</p>
<p>Object "Limit value extern presetting"</p>	<p>disabled enabled</p>	<p>The brightness limiting value is reset in the device by transmitting a brightness value to the 2-byte object "Limiting value x external presetting" in accordance with DPT 9.004, which can be enabled by this parameter. The relative hysteresis value configured in the ETS results in a new value for both brightness thresholds depending on the type of limiting value definition. The new limiting value remains unchanged until a new presetting (externally via object or via Teach function). An ETS programming operation resets a limiting value automatically to the ETS presettings if this is provided for in the configuration.</p>
<p>Teach function</p>	<p>disabled enabled</p>	<p>With the Teach function, the currently measured brightness value is applied instantly by transmitting a corresponding telegram to the 1-bit object "Limiting value x Teach" as a new limiting value. The relative hysteresis value configured in the ETS results in a new value for both brightness thresholds depending on the type of limiting value definition. The Teach object is configurable if this parameter is set to "enabled".</p>
<p>Teach operating mode</p>	<p>0 = inactive / 1 = active 0 = active / 1 = inactive 0 = active / 1 = active</p>	<p>The polarity of a Teach telegram is configurable by this parameter. Depending on the configuration, it is possible to reset to the configured limiting value upon receiving the</p>

		<p>opposite object value (Teach inactive). The limiting value previously learned will be lost in the process. If, however, the Teach polarity is configured to "1"- and "0"-active, it is not possible anymore to reset to the configured limiting value via this object during ongoing operation of the device!</p> <p>This parameter is visible only if the teach function is enabled.</p>
Feedback "limiting value effective" ?	<p>yes</p> <p>no</p>	<p>The 2-byte objects "limiting value x effective" can be used for the feedback of the limiting values evaluated by the device. The feedback object of a limiting value can be configured if this parameter is set to "yes".</p>
Effect of the feedback	<p>active signalling object</p> <p>passive status object</p>	<p>The feedback of the effective limiting value can optionally take place actively as well as passively (object is readable). In the function as an active signalling object, the current value is transmitted once automatically to the bus on each change of the brightness limiting value, after ETS programming or after bus voltage return (optionally delayed).</p>
Function	<p>Switching</p> <p>Brightness value</p> <p>Scene extension</p>	<p>Each output of a limiting value can be configured to a specific data format independently by this parameter.</p> <p>1-bit switching telegrams (ON / OFF) can be output.</p> <p>It is possible to output 1-byte brightness value telegrams (0...100 %).</p> <p>It is possible to execute a 1-byte scene recall (0...64) in another bus subscriber via the output object of a limiting value.</p>
Transmit telegram on exceeding the upper threshold?	<p>yes</p> <p>no</p>	<p>Depending on the configuration, a limiting value output can transmit a telegram if the brightness value exceeds the upper threshold and/or falls below the lower threshold. This parameter defines whether the corresponding channel output should transmit a telegram on exceeding the upper threshold.</p>
Telegram on exceeding the upper threshold	<p>ON telegram</p> <p>OFF telegram</p>	<p>This parameter defines the switching command, which is transmitted to the bus on exceeding the upper threshold.</p>

		The parameter is only visible if the function of the limiting value is configured to "switching" and a telegram should be transmitted on exceeding the upper threshold.
Telegram on exceeding the upper threshold (0...100 %)	0...100	This parameter defines the brightness value, which is transmitted to the bus on exceeding the upper threshold. The parameter is only visible if the function of the limiting value is configured to "brightness value" and a telegram should be transmitted on exceeding the upper threshold.
Telegram on exceeding the upper threshold (1...64)	1...64	This parameter defines the scene number for the scene recall command, which is transmitted to the bus on exceeding the upper threshold. The parameter is only visible if the function of the limiting value is configured to "scene extension" and a telegram should be transmitted on exceeding the upper threshold.
Transmit telegram on falling below the lower threshold?	yes no	Depending on the configuration, a limiting value output can transmit a telegram if the brightness value exceeds the upper threshold and/or falls below the lower threshold. This parameter defines whether the corresponding channel output should transmit a telegram on not reaching the lower threshold.
Telegram on not reaching lower threshold	ON telegram OFF telegram	This parameter defines the switching command, which is transmitted to the bus on not reaching the lower threshold. The parameter is only visible if the function of the limiting value is configured to "switching" and a telegram should be transmitted on not reaching the lower threshold.
Telegram on not reaching lower threshold (0...100 %)	0...100	This parameter defines the brightness value, which is transmitted to the bus on not reaching the lower threshold. The parameter is only visible if the function of the limiting value is configured to "brightness value" and a telegram should be transmitted on not reaching the lower threshold.

Telegram on not reaching lower threshold (1...64)	1...64	This parameter defines the scene number for the scene recall command, which is transmitted to the bus on not reaching the lower threshold. The parameter is only visible if the function of the limiting value is configured to "scene extension" and a telegram should be transmitted on not reaching the lower threshold.
<input type="checkbox"/> BLV - Disable		
Use disabling function ?	yes no	The limiting value evaluation can be disabled independently of the other functional units via the disabling function. A disabled limiting value evaluation is deactivated. No telegrams are then transmitted anymore via the output objects. The presetting of new brightness limiting values by an external brightness value or by the Teach function is not influenced by the disabling function, however. The disabling function can be used if this parameter is configured to "yes". The disabling function is then activated and deactivated via the object "BLV - Disable input".
Polarity of disable object	0 = enable / 1 = disable 0 = disable / 1 = enable	This parameter defines the telegram polarity of the disabling object. The parameter is only visible if the disabling function is enabled.
State of the disabling function after bus voltage return	deactivated activated	The state of the disabling function after bus voltage return can be configured here. The parameter is only visible if the disabling function is enabled. After bus voltage return, the brightness limiting values are ready for operation immediately. The configured thresholds for each output are compared with the current brightness value and evaluated. If the brightness value exceeds or does not reach the corresponding thresholds, the configured telegrams are transmitted. After bus voltage return, all brightness limiting values are disabled. The configured thresholds are not evaluated with the current brightness value. Thus, no telegram is transmitted via any output.

<p>State as before bus voltage failure</p>	<p>If the device detects a bus voltage failure, it saves the current state of the disabling function. After bus voltage return, the disabling function adopts the saved state again (active or inactive).</p>
<p>State of the disabling function after ETS programming</p>	<p>The state of the disabling function after ETS programming is configurable here. The parameter is only visible if the disabling function is enabled.</p>
<p>deactivated</p>	<p>After ETS programming, the brightness limiting values are ready for operation immediately. The configured thresholds for each output are compared with the current brightness value and evaluated. If the brightness value exceeds or does not reach the corresponding thresholds, the configured telegrams are transmitted.</p>
<p>activated</p>	<p>After ETS programming, all brightness limiting values are disabled. The configured thresholds are not evaluated with the current brightness value. Thus, no telegram is transmitted via any output.</p>
<p><input type="checkbox"/> Remote control (IR)</p>	
<p>IR remote control</p>	<p>disabled</p>
	<p>enabled</p>
	<p>Certain settings for the device can also be carried out optionally with an IR remote control. This is recommended, for instance, if the user should carry out settings on the twilight level, sensitivity of the motion detection or on the run-on-time after commissioning using the ETS. With the remote control it is also possible to influence the motion evaluation manually and thus the switching on and off of the automatic mode and walking test function. The IR remote control can only be used if the parameter here is set to "enabled". The IR remote control only influences the function block 1! Other function blocks - if in use - cannot be influenced by the IR remote control.</p>
<p><input type="checkbox"/> IR - General</p>	
<p>Operating mode presetting</p>	<p>1 / Auto / 0</p>
	<p>1 / Auto / -</p>
	<p>- / Auto / 0</p>
	<p>The ON , AUTO or OFF  buttons are influenced by this parameter. Depending on the parameter setting, the buttons can be deactivated individually.</p>

"Test" button for walking test function	deactivated activated	The walking test function of the device can be activated and deactivated by pressing the Test button, but only if the button is also in the function. This parameter defines whether the button of the IR remote control is available in the function or not.
Use disabling function ?	yes no	All buttons of the IR remote control can be disabled via the bus using the disabling function. The disabling function can be configured if this parameter is configured to "yes". The disabling function is then activated and deactivated via the communication object "Disable IR input". During an active disable, no settings can be made via the IR remote control.
Polarity of the disabling object	0 = enable / 1 = disable 0 = disable / 1 = enable	This parameter defines the telegram polarity of the disabling object. The parameter is only visible if the disabling function is enabled.
State of the disabling function after bus voltage return	deactivated activated State as before bus voltage failure	The state of the disabling function after bus voltage return can be configured by this parameter. After bus voltage return, the IR remote control is ready for operation immediately. After bus voltage return, the IR remote control is completely disabled. The current state of the disabling function will be stored in case of bus voltage failure. After bus voltage return, the device tracks the saved disabling state (active or inactive).
State of the disabling function after ETS programming	deactivated activated	The state of the disabling function after ETS programming is configurable by this parameter. After ETS programming, the IR remote control is ready for operation immediately. After ETS programming, the IR remote control is completely disabled.

5 Appendix

5.1 Index

A

Additional transmission delay.....	95
after last motion.....	98
alert operation.....	93
Application programs.....	28
application type.....	69

B

basic sensitivity.....	56
Beginning of the detection.....	90
Behaviour after bus voltage return.....	102
Behaviour after ETS programming.....	103
brightness limiting values.....	135
Brightness measurement.....	57
brightness range.....	126
brightness sensor.....	77
brightness sensor,.....	57
brightness setpoint.....	111

C

Calibration function.....	57
Ceiling detector.....	63
communication objects.....	29
Control operation.....	107

D

darkness value.....	126
Detection field.....	11
Detector.....	66
direction of motion.....	11

E

end of the detection.....	95
ETS	16,28
ETS search paths.....	25
Evaluation delay.....	92
Extension unit.....	71

F

function block group.....	63,105
function block switch-over.....	63,105

I

installation location.....	12
Interlock.....	56
IR remote control.....	19

L

light guide.....	57
lower control output limit.....	122-123

M

Main control phase.....	122
Main unit.....	70
manual operation.....	81
maximum illuminance.....	126
Motion detection.....	55
motion sensor.....	77

O

operating elements.....	18
-------------------------	----

P

physical address.....	16
Presence detector.....	65
Presence detector for light control.....	67
Push-button functions.....	140
push-on cover.....	13

R

range.....	11
reflection coefficient.....	57

S

Setpoint shift.....	112
single device.....	69
Staircase function.....	87
Startup control phase.....	119
Superimposed operation.....	130
Switch-off brightness.....	97

T

Teach.....	114,137
Total motion.....	90
Twilight level evaluation.....	78

W

walking test.....	16,61
-------------------	-------

ALBRECHT JUNG GMBH & CO. KG

Volmestraße 1
58579 Schalksmühle
GERMANY

Telefon: +49 2355 806-0
Telefax: +49 2355 806-204
kundencenter@jung.de
www.jung.de