



## Product documentation

Universal push-button module, 1-gang  
Art. No. 5091 TSM

Universal push-button module, 2-gang  
Art. No. 5092 TSM

Universal push-button module, 3-gang  
Art. No. 5093 TSM

Universal push-button module, 4-gang  
Art. No. 5094 TSM

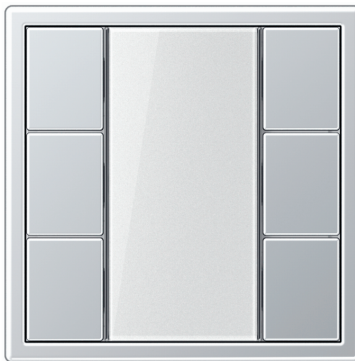

**ALBRECHT JUNG GMBH & CO. KG**  
Volmestraße 1  
58579 Schalksmühle  
GERMANY

Telefon: +49 2355 806-0  
Telefax: +49 2355 806-204  
kundencenter@jung.de  
www.jung.de

Issue: 07.09.2016  
6525x320 V2

## Table of Contents

<b>1</b>	<b>Product definition</b>	<b>4</b>
1.1	Product catalogue	4
1.2	Function	4
1.3	Accessories	6
<b>2</b>	<b>Installation, electrical connection and operation</b>	<b>7</b>
2.1	Safety instructions	7
2.2	Device components	8
2.3	Fitting and electrical connection	10
2.4	Commissioning	14
2.5	Operation	16
<b>3</b>	<b>Technical data</b>	<b>17</b>
<b>4</b>	<b>Software description</b>	<b>18</b>
4.1	Software specification	18
4.2	Software "Universal TSM 110x11"	20
4.2.1	Scope of functions	20
4.2.2	Notes on software	22
4.2.3	Object table	23
4.2.3.1	Rockers or button functions	23
4.2.3.2	Status LED	28
4.2.3.3	Disabling functions	30
4.2.3.4	Operation LED and labelling field illumination	34
4.2.3.5	Alarm signal	35
4.2.3.6	Controller extension and room temperature measurement	36
4.2.3.7	Scene function	38
4.2.3.8	Energy saving mode	39
4.2.4	Functional description	40
4.2.4.1	General settings	40
4.2.4.1.1	Button configuration	40
4.2.4.1.2	Operation concept and button evaluation	41
4.2.4.1.3	Operation LED	42
4.2.4.1.4	Labelling field illumination	43
4.2.4.1.5	Transmission delay	44
4.2.4.2	Rockers and button functions	45
4.2.4.2.1	Switching function	45
4.2.4.2.2	Dimming function	46
4.2.4.2.3	"Blind" function	48
4.2.4.2.4	"Value transmitter" function	52
4.2.4.2.5	Scene extension function	55
4.2.4.2.6	"2-channel operation" function	56
4.2.4.3	Status LED	58
4.2.4.4	Brightness setting for LEDs and labelling field illumination	63
4.2.4.5	Scene control	64

4.2.4.6	Disabling function .....	67
4.2.4.7	Controller extension .....	71
4.2.4.8	Room temperature measurement .....	75
4.2.4.9	Alarm signal .....	77
4.2.4.10	Energy saving mode .....	78
4.2.4.11	Delivery state .....	80
4.2.5	Parameters .....	81
<b>5</b>	<b>Appendix .....</b>	<b>124</b>
5.1	Index .....	124

## 1 Product definition

### 1.1 Product catalogue

Product name:	Universal push-button module, 1-gang / Universal push-button module, 2-gang / Universal push-button module, 3-gang / Universal push-button module, 4-gang
Use:	Sensor
Design:	FM (flush-mounted)
Art. No.	5091 TSM / 5092 TSM / 5093 TSM / 5094 TSM

### 1.2 Function

#### Push button functions

When its buttons are pushed, the universal pushbutton sensor modules send telegrams to the KNX, depending on the ETS parameter settings. These can be, for instance, telegrams for switching or push button control, for dimming or for controlling blinds. It is also possible to program value transmitter functions, such as dimming value transmitters, light scene extensions, temperature value transmitters or brightness value transmitters.

The pushbutton sensor modules consist of several control surfaces. The operation concept can be configured in the ETS either as a rocker function or alternatively as a push button function. With the rocker function, two neighbouring control surfaces are combined into one rocker switch. In the pushbutton function, each control surface is evaluated as single-surface operation.

If two control surfaces are used as a rocker function, then, depending on the configuration, it is also possible to trigger special functions through "full-surface operation" of the rocker switch, i.e. both control surfaces at the same time.

#### Push-button extension module

Optionally, the number of control surfaces of the device can be expanded to include up to 8 additional control surfaces, by connecting an extension module to the basic device. Configuration and commissioning of the extension module are clearly structured and easy to perform using the application program of the basic device. The connection between the pushbutton sensor module and the extension module is made using a two-wire cable (e.g. separate cable) and can be up to 30 metres long.

#### Room temperature controller extension

In connection with a room temperature controller, equipped with a 1-byte object for switch-over of operating modes, the device can be used as a full-featured controller extension. The device can also be used for presence detection or for setpoint shifting purposes.

#### Measurement of the room temperature

The device contains a temperature sensor. The determined room temperature can be displayed e.g. by a visualisation or otherwise is evaluated by a room temperature controller as an external temperature value. Determination of the room temperature can be further improved if a temperature sensor sends its measured value to the device. The resulting room temperature is yielded by the averaging of the individual temperature values, whereby the weighting of internal and external values can be specified.

## Lighting and LED functions

The universal pushbutton sensor modules have one status LED for each control surface. The status LEDs are executed in three colours and can – according to choice, in either red green or blue – be switched on or off permanently or can function as an operation indication or as status indication. As an alternative, with the aid of separate communication objects, they can signal widely varying display information completely independently of the pushbutton function, e.g. operation states of fault messages or also room temperature controllers, the results of logic value comparisons, flash or be permanently switched on or off. Each colour of a status LED can be controlled either by three separate objects or alternatively by a mutual object (superimposed function), so that traffic light functions can also be implemented, - for example, depending on a limiting value - by means of an LED.

The large labelling field offers space for the convenient labelling of the pushbutton functions and can be lit in white where needed. Depending on the programming, the lighting can be permanently switched on as orientation lighting, or else only by pressing a button for a parameterised time. A flash signal can also be used e.g. as an alarm message.

An operation LED can either serve as an orientation light (also flashing), or can be activated via a separate communication object. In programming operating mode, the operation LED flashes permanently with a frequency of approx. 8 Hz.

The brightness of all the displays can be set in six stages, using a common parameter. A separate communication object allows the brightness to be reduced, e.g. during night hours.

## Energy saving mode

The device has an energy saving mode to save electrical energy during operation. If the function is used, the device switches to the energy saving mode after a preset time without operation or controlled by an external telegram to a separate object, and switches off the signalling function of the device. The energy saving mode can be deactivated by an operation or by a special telegram. Afterwards, the device is fully functional again.

## Bus coupling unit

The pushbutton sensor modules contain a bus coupling unit and thus can be connected directly to the bus line. Pushbutton sensor extension modules do not include a bus coupling unit. Both the function and commissioning of the extension modules can only be carried out through a pushbutton sensor module basic device.

## 1.3 Accessories

Cover kit 1-gang	Art. No. ...501TSA..
Cover kit 2-gang	Art. No. ...502TSA..
Cover kit 3-gang	Art. No. ...503TSA..
Cover kit 4-gang	Art. No. ...504TSA..
Push-button extension module, 1-gang	Art. No. ...5091 TSEM
Push-button extension module, 2-gang	Art. No. ...5092 TSEM
Push-button extension module, 3-gang	Art. No. ...5093 TSEM
Push-button extension module, 4-gang	Art. No. ...5094 TSEM

## 2 Installation, electrical connection and operation

### 2.1 Safety instructions

Electrical equipment may only be installed and fitted by electrically skilled persons. The applicable accident prevention regulations must be observed.

Failure to observe the instructions may cause damage to the device and result in fire and other hazards.

**Danger of electric shock.** Make sure during the installation that there is always sufficient insulation between the mains voltage and the bus. A minimum distance of at least 4 mm must be maintained between bus conductors and mains voltage cores.

Use only the enclosed plastic screws for fastening to the supporting frame! Otherwise safe operation cannot be ensured. Electrostatic discharges can cause defects in the device.

Do not open device or operate it beyond the technical specification.

## 2.2 Device components

### Device components of universal push-button sensors TSM

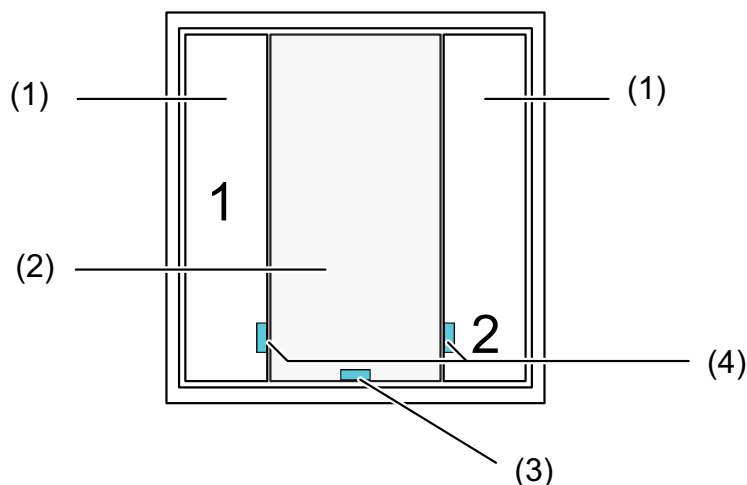

Figure 1: Front view, universal pushbutton sensor module, 1-gang

- (1) 2 control surfaces configurable as rocker 1 or as buttons 1...2.
- (2) Illuminable labelling field (white)
- (3) 1 operation LED (red, green, blue)
- (4) 2 status LEDs (red, green, blue) / one LED per button.

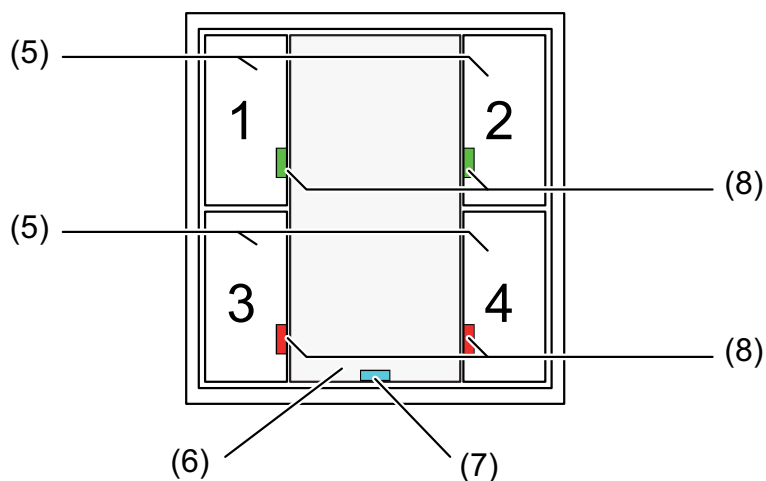

Figure 2: Front view, universal pushbutton sensor module, 2-gang

- (5) 4 control surfaces configurable as rocker 1...2 or as buttons 1...4.
- (6) Illuminable labelling field (white)
- (7) 1 operation LED (red, green, blue)
- (8) 4 status LEDs (red, green, blue) / one LED per button.



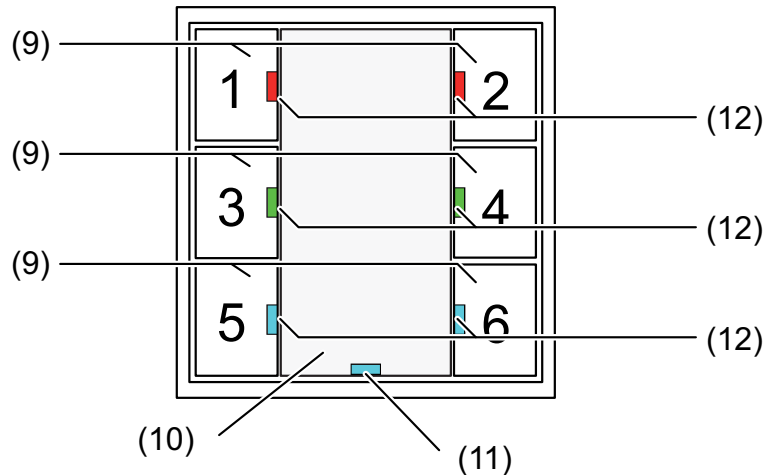

Figure 3: Front view, universal pushbutton sensor module, 3-gang

- (9) 6 control surfaces configurable as rocker 1...3 or as buttons 1...6.
- (10) Illuminable labelling field (white)
- (11) 1 operation LED (red, green, blue)
- (12) 6 status LEDs (red, green, blue) / one LED per button.

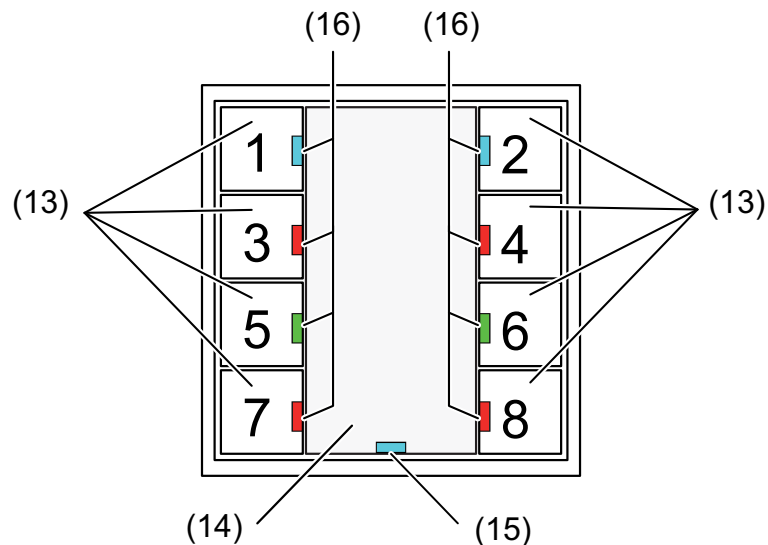

Figure 4: Front view, universal pushbutton sensor module, 4-gang

- (13) 8 control surfaces configurable as rocker 1...4 or as buttons 1...8.
- (14) Illuminable labelling field (white)
- (15) 1 operation LED (red, green, blue)
- (16) 8 status LEDs (red, green, blue) / one LED per button.

**i** The pushbutton sensor modules can be integrated into the switch programs A500, LS990 or CD500.

## 2.3 Fitting and electrical connection

### Push-button sensor basic module connecting and mounting

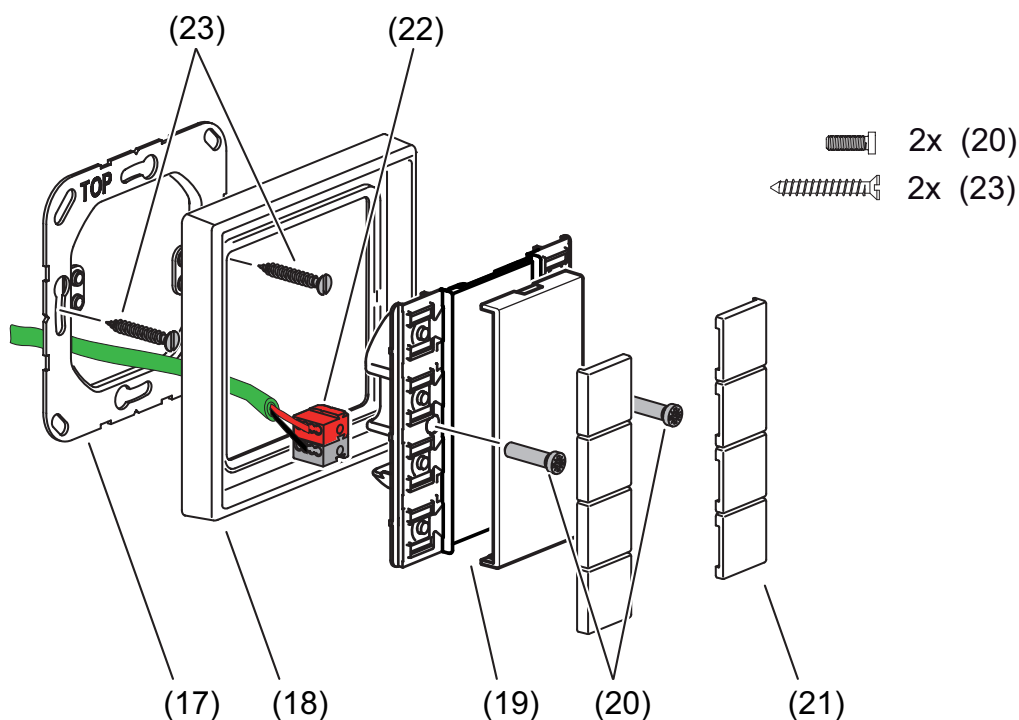

Figure 5: Assembling the push-button sensor basic module

- (17) Supporting frame
- (18) Design frame
- (19) Button sensor module
- (20) Fastening screws
- (21) Design control surfaces
- (22) KNX connection terminal
- (23) Box screws

- Mount supporting frame (17) in the right orientation on an appliance box. Note the **TOP** marking. Use the enclosed box screws (23).
- Position the decorative frame (18) on the supporting frame.
- Connect the push button module (19) with KNX connection terminal (22), which is connected to the KNX bus line, on the rear side of the module. Run the connection cable downwards from the push button module and then into the accessory socket from the rear.
- Attach the push button module onto the supporting frame.
- Fasten push button module to supporting frame using the enclosed plastic screws (20). Tighten the plastic screws only lightly.
- Before mounting the control surfaces (21), load the physical address into the device (see chapter 2.4. Commissioning).

## Mount and connect the push-button sensor basic module with push-button extension module.

One push-button extension module can be connected to each push-button sensor basic module. The white-yellow wire pair of the bus line, or alternatively a separate cable, can be used as the connection cable. When connecting, make sure the polarity is correct (e.g. on the TSM and TSEM yellow = "+", white = "-").

- i** When the white-yellow wire pair of the bus line is used as the connection cable, the two-wire pair can only connect one pushbutton sensor basic device and one pushbutton sensor extension module to each other along the shortest path. Leading the two-wire pair electrically into the system, e.g. to connect additional pushbutton sensor modules with each other, is not permitted! Leading further is also not permitted, if this results in total cabling paths of longer than is permitted (max. 30 m).
- i** The white-yellow wire pair of the bus line must not be used to connect pushbutton sensor modules, if these wires are already used to fulfil other tasks of the KNX installation (e.g. additional power supply for specific bus devices). In this case, a separate connection line is to be used. This is especially to be heeded when retrofitting an existing KNX system.

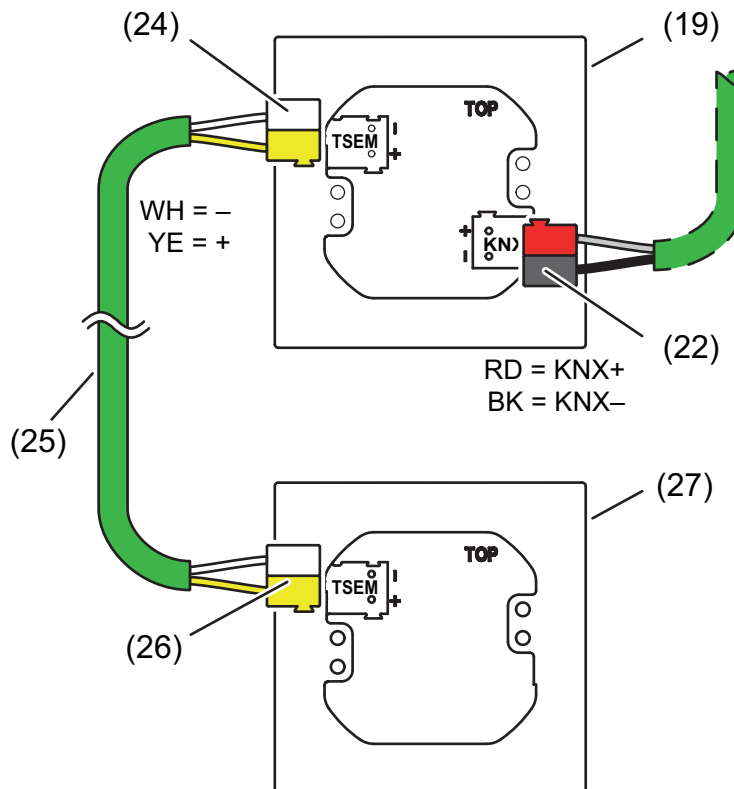

Figure 6: Connection of the pushbutton sensor extension module (view from rear)

- (19) Push button module Universal
- (22) KNX connection terminal
- (24) Terminal for connecting an extension module, white-yellow
- (25) Connection line for pushbutton sensor extension module
- (26) Terminal for extension module, white-yellow
- (27) Push-button extension module

The pushbutton sensor extension module can either be mounted in a flush-mounted device combination or also set into a flush-mounted box. Maximum total length of connection line between basic device and pushbutton sensor extension module: 30 m.

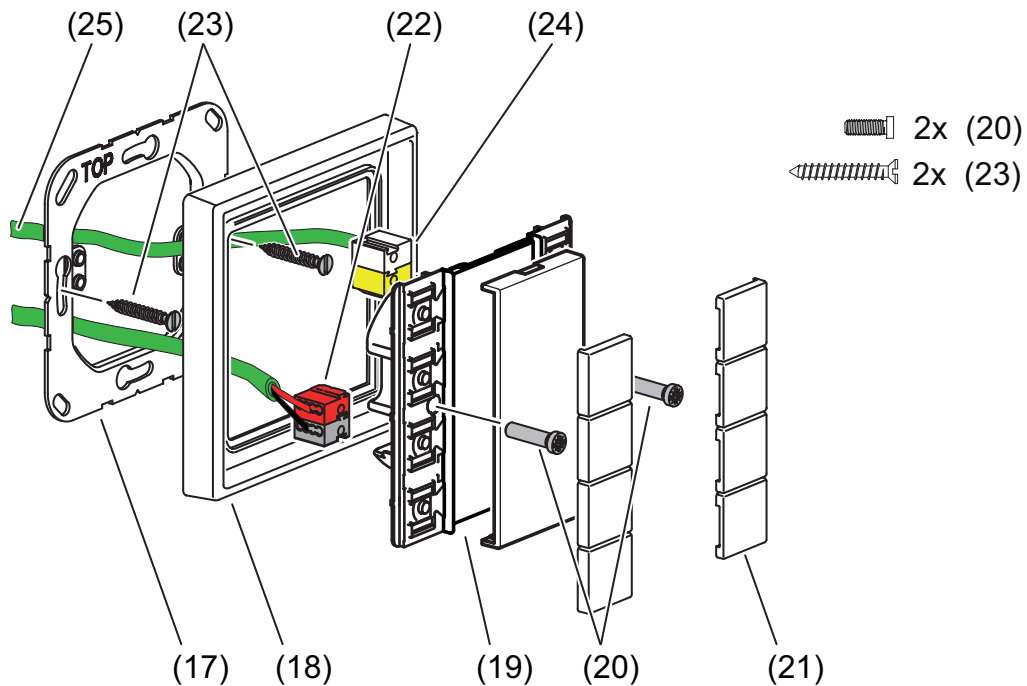

Figure 7: Mounting the pushbutton sensor module with connection of a pushbutton sensor extension module

- (17) Supporting frame
- (18) Design frame
- (19) Push-button module
- (20) Fastening screws
- (21) Design control surfaces
- (22) KNX connection terminal
- (23) Box screws
- (24) Terminal for connecting an extension module, white-yellow
- (25) Connection line for pushbutton sensor extension module

The pushbutton sensor basic device and a pushbutton sensor extension module are mounted in essentially the same manner:

- Mount supporting frame (17) in the right orientation on an appliance box. Note the **TOP** marking. Use the supplied box screws.
- Lead the bus line and connection line out of the box and through the supporting frame (17) and frame (18).
- Push frame (18) onto supporting frame (17).

On the pushbutton sensor basic device (19):

- Connect the KNX bus line with red-black KNX terminal (22) to the "**KNX**" slot at the back.
- Connect the connection line (25) with white-yellow terminal (24) to the "**TSEM**" slot at the back.

On the pushbutton sensor extension module (19):

- Connect the connection line (25) with white-yellow terminal (24) to the "**TSEM**" slot at the back.
- Attach the push button module onto the supporting frame (17).
- Fix push-button module to supporting frame using the supplied plastic screws (20). Tighten the plastic screws only lightly.
- Before mounting the control surfaces on the push-button sensor basic module, load the physical address into the device (see chapter 2.4. Commissioning).

## 2.4 Commissioning

After connection and mounting, the pushbutton sensor module can be put into operation. The start-up procedure is basically confined to programming with the ETS and attaching the decorative control surfaces.

- i** The extension module does not receive any physical address of its own. It is activated by the application program loaded in the basic module.

### Programming the physical address

The pushbutton sensor does not have a separate programming button or LED. Programming mode is activated by a defined and time-delayed press of the upper left and lower right of the pushbutton. Programming mode is signalled by flashing operation LEDs on the basic and extension modules. To program the physical address, the decorative control surfaces can be snapped onto the device.

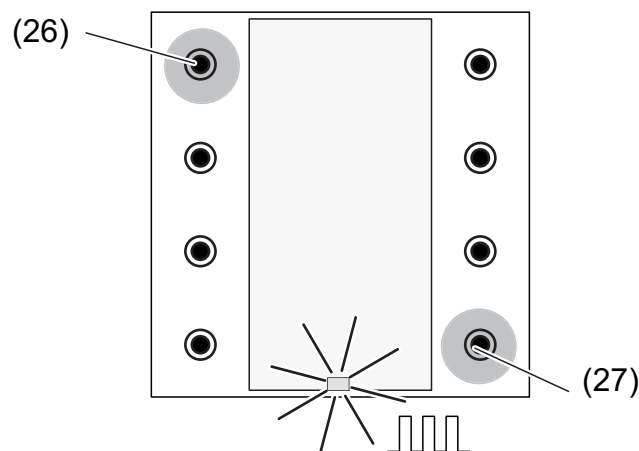

Figure 8: Buttons for activating Programming mode

- i** If the device does not contain any application software, or the wrong application software, then the operation LED (colour: blue) and the labelling field illumination on the basic and extension modules flash slowly.

For commissioning, the pushbutton sensor module must be connected and the bus voltage switched on.

- **Activate Programming mode.** Press and hold down the pushbutton at the top left of the basic device (26) (figure 8). Then press second push-button at the lower right (27).

Programming mode is activated. The operation LEDs (26) on the basic and extension modules flash quickly (approx. 8 Hz).

- i** Use suitable objects to push the buttons (e.g. thin screwdriver, tip of a ballpoint pen, etc.)
- i** To exclude any inadvertent activation of Programming mode during a 'normal' use of the control surface in later operation, the time between the first and the second button actuation must be at least 200 ms. Pressing both buttons simultaneously (time between first and second actuation < 200 ms) will not result in an activation of Programming mode.
- i** It should be noted that the labelling field illumination also flashes quickly in the case of a full-surface operation (see functional description). During full-surface operation of the rocker switch, the labelling field illumination reverts to the parameterised basic state as soon as the buttons are released.  
In programming mode, the operation LED flashes steadily in the colour blue. The flashing rate remains the same until the operating mode is ended. The state of the LED defined by Programming mode will always prevail.

- Program the physical address with the help of the ETS.
- Programming mode ends:
  - Automatically after adoption of the physical address
  - By pressing any button on the basic module
- ❗ If Programming mode is to be activated or deactivated in a device which is already programmed with a valid application, there is the possibility that telegrams will be transmitted to the bus at the time the button is pressed. The telegram transmitted depends on the button function programmed.
- ❗ The extension module does not receive any physical address of its own. It is activated by the application program loaded in the basic module. The programming mode cannot be activated or deactivated on the extension module.  
When programming mode is active, the extension module can be operated normally. Then the telegrams corresponding to the configuration are also transmitted to the bus.

### Programming the application program

Program the application into the device with the help of the ETS. For commissioning it is recommended to use the ETS4 or ETS3.0 from Version "d" onwards.

The ETS detects automatically whether a valid application has already been programmed into the device before. To reduce the programming time, the ETS downloads the whole application only if the device was programmed beforehand with another application or with no application at all. In all other cases, the ETS makes a time-optimised partial download in which only the modified data is loaded into the device.

### Installing the decorative control surfaces

The decorative control surfaces are available as a complete set of buttons. Individual buttons or the complete set of buttons can be replaced using buttons with icons.

The design control surfaces are not included in the scope of supply of the push-button sensor basic module or the push-button extension module. These must be ordered specially according to the required design.

- Place control surfaces on the push-button sensor basic module in the right orientation and also on the push-button extension module (if used), and snap in with a short push.

## 2.5 Operation

### Control surfaces

The universal pushbutton sensor modules consist of several control surfaces. The operation concept can be configured in the ETS either as a rocker function or alternatively as a push button function. With the rocker function, two neighbouring control surfaces are combined into one rocker switch. In the pushbutton function, each control surface is evaluated as single-surface operation. If two control surfaces are used as a rocker function, then, depending on the configuration, it is also possible to trigger special functions through "full-surface operation" of the rocker switch, i.e. both control surfaces at the same time.

The number of control surfaces depends on the push-button sensor used. As an option, the number of rockers of each universal pushbutton sensor module can be supplemented with a 1 to 4-gang pushbutton sensor extension module. This makes up to 4 additional rockers available.

The universal pushbutton sensor modules have one status LED for each control surface. The status LEDs are executed in three colours and can – according to choice, in either red green or blue – be switched on or off permanently or can function as an operation indication or as status indication. As an alternative, with the aid of separate communication objects, they can signal widely varying display information completely independently of the pushbutton function, e.g. operation states of fault messages or also room temperature controllers, the results of logic value comparisons, flash or be permanently switched on or off. Each colour of a status LED can be controlled either by three separate objects or alternatively by a mutual object (superimposed function), so that traffic light functions can also be implemented, - for example, depending on a limiting value - by means of an LED.

The operation LEDs and the labelling field, which can be illuminated, can signal the switching state of an own object, flash or be permanently switched on or off. Besides functions that can be set using the ETS, the operation LED also indicates that the push button sensor is in the programming mode for commissioning or diagnosis purposes.

Moreover, the universal pushbutton sensor module has functions which are not immediately linked with the rockers or buttons. These include the thermostat extension function, pushbutton function disable, the internal scenes and the display of alarm signals.

- i Configuration of the control surfaces (button or rocker function) is described in detail in the chapter "Software description"



## 3 Technical data

### General

Protection class	III
Mark of approval	KNX/EIB
Ambient temperature	-5 ... +45 °C
Storage/transport temperature	-25 ... +70 °C

### KNX/EIB supply

KNX medium	TP
Commissioning mode	S-mode
Rated voltage KNX	DC 21 ... 32 V SELV
Power consumption KNX	max. 150 mW
Connection mode KNX	device connection terminal

### Connection of the extension module

Number	1
Cable length	max. 30 m
Cable type	J-Y(St)Y 2 x 2 x 0.8 mm
Extension module current input	max. 12 mA

## 4 Software description

### 4.1 Software specification

ETS search paths:	Push-button / Push-button, 1-gang / Universal push-button module, 1-gang Push-button / Push-button, 2-gang / Universal push-button module, 2-gang Push-button / Push-button, 3-gang / Universal push-button module, 3-gang Push-button / Push-button, 4-gang / Universal push-button module, 4-gang
Configuration:	S-mode standard
PEI type:	"00" <sub>Hex</sub> / "0" <sub>Dec</sub>
PEI connector:	no connector

#### Application for universal pushbutton sensor module, 1-gang:

No.	Short description	Name	Version	from mask version
1	Multifunctional pushbutton sensor application: 2 control surfaces on basic module. Can be extended to up to 10 control surfaces using extension module.	Universal TSM 110611	1.1 for ETS3.0 Version d onwards and ETS4	705

#### Application for universal pushbutton sensor module, 2-gang:

No.	Short description	Name	Version	from mask version
1	Multifunctional pushbutton sensor application: 4 control surfaces on basic module. Can be extended to up to 12 control surfaces using extension module.	Universal TSM 110711	1.1 for ETS3.0 Version d onwards and ETS4	705

#### Application for universal pushbutton sensor module, 3-gang:

No.	Short description	Name	Version	from mask version
-----	-------------------	------	---------	-------------------

1	Multifunctional pushbutton sensor application: 6 control surfaces on basic module. Can be extended to up to 14 control surfaces using extension module.	Universal TSM 110811	1.1 for ETS3.0 Version d onwards and ETS4	705
---	---	-------------------------	---	-----

**Application for universal pushbutton sensor module, 4-gang:**

No.	Short description	Name	Version	from mask version
1	Multifunctional pushbutton sensor application: 8 control surfaces on basic module. Can be extended to up to 16 control surfaces using extension module.	Universal TSM 110911	1.1 for ETS3.0 Version d onwards and ETS4	705

## 4.2 Software "Universal TSM 110x11"

### 4.2.1 Scope of functions

#### Scope of functions

- Each control surface can be used as independent button or – when linked with the opposite button – as a rocker function.
- Each button can be used for the functions switching, dimming, shutter control, 1-byte value transmitter, 2-byte value transmitter, scene extension and room temperature controller extension value transmitter.
- Each rocker can be used for the functions 'switching', 'dimming', 'blind/shutter', '1-byte value transmitter', '2-byte value transmitter' and 'scene extension'.
- 2-channel control is possible: each rocker or each button can be set for controlling two independent channels. This means that only one button-press is enough to transmit up to two telegrams to the bus. The channels can be configured independently of one another for the Switching, Value transmitter (1 byte) or Temperature value transmitter (2 bytes) functions.
- For the rocker functions Dimming, Venetian blind (operation concept "Long – Short or Short") and 2-channel operation, full-surface rocker actuation can also be evaluated. With full-surface rocker operation, switching telegrams and scene recall requests can be triggered on the bus in addition to and independently of the configured rocker function.
- The switching function permits the following settings: reaction after pressing and/or releasing, switch on, switch off, and toggle.
- The dimming function permits the following settings: times for short and long actuation, dimming in different levels, telegram repetition on long press, transmission of stop telegram after end of press.
- The shutter control permits the following settings: four different operation concepts with times for short and long press and slat adjustment.
- The 1-byte and 2-byte value transmitter function permits the following settings: selection of the value range (0 ... 100 %, 0 ... 255, 0 ... 65535, 0 ... 1500 lux, 0 ... 40 °C), value on actuation, value change on long button-press with different step widths, times optional overflow when the end of the value range is reached.
- The scene control permits the following settings: Internal storage of eight scenes with eight output channels, recall of internal scenes by means of a presettable scene number, selection of object types for the output channels; for each scene, the storage of the individual output values and the transmission of the output values can be permitted or disabled; the individual channels can be delayed during scene recall; as scene extension 64 scenes can be recalled and stored.
- The controller extension function permits the following settings: operating mode selection with normal and high priority, defined selection of an operating mode, change between different operating modes, change of presence status, setpoint shift.
- Each control surface has one status LED of its own available. The status LED can light up in red, green or blue according to choice.
- When a status LED is internally connected with the rocker or the button, it can signal a button-press or the current status of a communication object. The status indication can also be in inverted form.
- When a status LED is not dependent on the rocker or button, it can be permanently on or off, indicate the status of an independent communication object, the operating state of a room temperature controller or the result of a comparison between signed or unsigned 1-byte values.
- The operation LED can be permanently on or off or alternatively be switched via a communication object. The operation LED can light up in red, green or blue according to choice.
- The lighting of the labelling field can be permanently switched on or off or, alternatively, be switched via a communication object.

- The rockers or buttons can be disabled via a 1-bit object. The following settings are possible: polarity of the disabling object, behaviour at the beginning and at the end of disabling. During an active disable, all or some of the rockers / buttons can have no function, can perform the function of a selected button or execute one of two presettable disabling functions.
- All LEDs of the push button sensor can flash simultaneously in the event of an alarm. The following settings are possible: Value of alarm signalling object for the states alarm / no alarm, alarm acknowledge by actuation of a button, transmission of the acknowledge signal to other devices.
- To save energy, an energy-saving mode can be activated. If the energy-saving mode is used, the signalling function of the device is switched off after a preset time without operation or by an external telegram. The energy saving mode can be deactivated by an operation or by a special telegram. Afterwards, the device is fully functional again.

## 4.2.2 Notes on software

### ETS configuration and commissioning

Configuration and commissioning of the device with the following ETS versions...

- ETS3.0 Version d or higher
- ETS4.0.7 or higher

The necessary product database is offered in the \*.VD4 format. No product database is available for ETS2 and older versions of ETS3.

## 4.2.3 Object table

Number of communication objects:	Max. 154 objects (4-gang variants with extension module)
Number of addresses (max):	254
Number of assignments (max):	255

### 4.2.3.1 Rockers or button functions

Objects for rocker or button function (basic and extension module):

---

Function:	Switching				
Object	Function	Name	Type	DPT	Flag
 0, 1, 2...15	Switching	Rocker/button 1 <sup>1,2</sup>	1-bit	1.xxx	C, W, T, (R) <sup>3</sup>
Description	1-bit object for transmission of switching telegrams (ON, OFF).				

---

Function:	Dimming				
Object	Function	Name	Type	DPT	Flag
 0, 1, 2...15	Switching	Rocker/button 1 <sup>1,2</sup>	1-bit	1.xxx	C, W, T, (R) <sup>3</sup>
Description	1-bit object for transmission of switching telegrams (ON, OFF).				

---

Function:	Dimming				
Object	Function	Name	Type	DPT	Flag
 18, 19, 20...-33	Dimming	Rocker/button 1 <sup>1,2</sup>	4-bit	3.007	C, W, T, (R) <sup>3</sup>
Description	4-bit object for the transmission of relative dimming telegrams.				

1: The number of rockers or buttons depends on the planned push-button sensor variant and the push-button sensor extension module. Mixed operation of rocker or button functions in a push-button sensor is possible on the basic module and the extension module.

2: The objects have been described for rocker 1 or button 1 as an example. The objects for the other rockers/buttons and for the module rockers are defined in the same way by shifting the object number and changing the object name.

3: For reading, the R-flag must be set. The last value written to the object via the bus will be read.

Function: Venetian blind

Object	Function	Name	Type	DPT	Flag
 0, 1, 2...15	Short time operation	Rocker/button 1 <sup>1,2</sup>	1-bit	1.007	C, -, T, (R) <sub>3</sub>

Description 1-bit object for the transmission of telegrams with which a Venetian blind or shutter drive motor can be stopped or with which the blind slats can be adjusted by short time operation.

Function: Venetian blind

Object	Function	Name	Type	DPT	Flag
 18, 19, 20...-33	Long-time operation	Rocker/button 1 <sup>1,2</sup>	1-bit	1.008	C, W, T, (R) <sub>3</sub>

Description 1-bit object for the transmission of telegrams with which a Venetian blind or shutter drive motor can be can be moved upwards or downwards.

Function: 1-byte value transmitter

Object	Function	Name	Type	DPT	Flag
 0, 1, 2...15	Value	Rocker/button 1 <sup>1,2</sup>	1 byte	5.xxx	C, W, T, (R) <sub>3</sub>

Description 1-byte object for the transmission of values from 0 to 255 (corresponding to values from 0 % to 100 %). If the adjustment of the value is enabled, the object can transmit telegrams cyclically after long actuation with which the value can be reduced or increased by a presettable amount.

Function: 2-byte value transmitter

Object	Function	Name	Type	DPT	Flag
 0, 1, 2...15	Value	Rocker/button 1 <sup>1,2</sup>	2 byte	7.xxx	C, W, T, (R) <sub>3</sub>

Description 2-byte object for the transmission of values from 0 to 65535. If the adjustment of the value is enabled, the object can transmit cyclical telegrams after a long press with which the value can be reduced or increased by an adjustable amount.

1: The number of rockers or buttons depends on the planned push-button sensor variant and the push-button sensor extension module. Mixed operation of rocker or button functions in a push-button sensor is possible on the basic module and the extension module.

2: The objects have been described for rocker 1 or button 1 as an example. The objects for the other rockers/buttons and for the module rockers are defined in the same way by shifting the object number and changing the object name.

3: For reading, the R-flag must be set. The last value written to the object via the bus will be read.



---

Function: 2-byte value transmitter

Object	Function	Name	Type	DPT	Flag
 0, 1, 2...15	Temperature value	Rocker/button 1 1,2	2 byte	9.001	C, W, T, (R) <sup>3</sup>

Description 2 -byte object for the transmission of a temperature value from 0 °C to 40 °C. If the adjustment of the value is enabled, the object can transmit telegrams cyclically after a long press with which the value can be reduced or increased by 1 K.

---

Function: 2-byte value transmitter

Object	Function	Name	Type	DPT	Flag
 0, 1, 2...15	Brightness value	Rocker/button 1 1,2	2 byte	9.004	C, W, T, (R) <sup>3</sup>

Description 2-byte object for the transmission of a brightness level value from 0 to 1500 lux. If the adjustment of the value is enabled, the object can transmit cyclical telegrams after a long press with which the value can be reduced or increased by 50 lux.

---

Function: Scene extension

Object	Function	Name	Type	DPT	Flag
 0, 1, 2...15	Scene extension	Rocker/button 1 1,2	1 byte	18.001	C, -, T, (R) <sub>3</sub>

Description 1-byte object for recalling or for storing one of 64 scenes max. from a scene push button sensor.

---

Function: 2-channel operation

Object	Function	Name	Type	DPT	Flag
 0, 1, 2...15	Channel 1 switching	Rocker/button 1 1,2	1-bit	1.xxx	C, W, T, (R) <sup>3</sup>

Description 1-bit object for the transmission of switching telegrams, if 2-channel operation is activated.

---

Function: 2-channel operation

Object	Function	Name	Type	DPT	Flag
 0, 1, 2...15	Channel 1 value	Rocker/button 1 1,2	1 byte	5.xxx	C, -, T, (R) <sub>3</sub>

Description 1-byte object for the transmission of value telegrams, if 2-channel operation is activated.

1: The number of rockers or buttons depends on the planned push-button sensor variant and the push-button sensor extension module. Mixed operation of rocker or button functions in a push-button sensor is possible on the basic module and the extension module.

2: The objects have been described for rocker 1 or button 1 as an example. The objects for the other rockers/buttons and for the module rockers are defined in the same way by shifting the object number and changing the object name.

3: For reading, the R-flag must be set. The last value written to the object via the bus will be read.

Function: 2-channel operation

Object	Function	Name	Type	DPT	Flag
 0, 1, 2...15	Channel 1 value	Rocker/button 1 <sup>1,2</sup>	2 byte	9.001	C, -, T, (R) <sub>3</sub>

Description 2-byte object for the transmission of value telegrams, if 2-channel operation is activated.

Function: 2-channel operation

Object	Function	Name	Type	DPT	Flag
 18, 19, 20...-33	Channel 2 switching	Rocker/button 1 <sup>1,2</sup>	1-bit	1.xxx	C, W, T, (R) <sub>3</sub>

Description 1-bit object for the transmission of switching telegrams, if 2-channel operation is activated.

Function: 2-channel operation

Object	Function	Name	Type	DPT	Flag
 18, 19, 20...-33	Channel 2 value	Rocker/button 1 <sup>1,2</sup>	1 byte	5.xxx	C, -, T, (R) <sub>3</sub>

Description 1-byte object for the transmission of value telegrams, if 2-channel operation is activated.

Function: 2-channel operation

Object	Function	Name	Type	DPT	Flag
 18, 19, 20...-33	Channel 2 value	Rocker/button 1 <sup>1,2</sup>	2 byte	9.001	C, -, T, (R) <sub>3</sub>

Description 2-byte object for the transmission of value telegrams, if 2-channel operation is activated.

1: The number of rockers or buttons depends on the planned push-button sensor variant and the push-button sensor extension module. Mixed operation of rocker or button functions in a push-button sensor is possible on the basic module and the extension module.

2: The objects have been described for rocker 1 or button 1 as an example. The objects for the other rockers/buttons and for the module rockers are defined in the same way by shifting the object number and changing the object name.

3: For reading, the R-flag must be set. The last value written to the object via the bus will be read.

Objects for full-surface operation with rocker function (with dimming, Venetian blind and 2-channel operation):

Function: Full-surface operation

Object	Function	Name	Type	DPT	Flag
 <sup>1, 3,</sup> <sub>5...15</sub>	Switching	Rocker 1 full-surface operation <sub>1,</sub>	1-bit	1.xxx	C, W, T, (R) <sup>3</sup>

Description 1-bit object for the transmission of switching telegrams (ON, OFF) when there is full-surface operation of a control surface.

Function: Full-surface operation

Object	Function	Name	Type	DPT	Flag
 <sup>1, 3,</sup> <sub>5...15</sub>	Scene extension	Rocker 1 full-surface operation <sub>1,</sub>	1 byte	18.001	C, -, T, (R) <sub>3</sub>

Description 1-byte object for recalling or for storing one of 64 scenes max. from a scene pushbutton sensor in case of full-surface operation of a control surface.

1: The number of rockers or buttons depends on the planned push-button sensor variant and the push-button sensor extension module. Mixed operation of rocker or button functions in a push-button sensor is possible on the basic module and the extension module.

2: The objects have been described for rocker 1 or button 1 as an example. The objects for the other rockers/buttons and for the module rockers are defined in the same way by shifting the object number and changing the object name.

3: For reading, the R-flag must be set. The last value written to the object via the bus will be read.

## 4.2.3.2 Status LED

Objects for status LED:

Function: Status LED (control via separate LED object)					
Object	Function	Name	Type	DPT	Flag
 36, 37...- 51	Switching	Status LED 1 <sup>1</sup>	1-bit	1.xxx	C, W, -, (R) <sub>2</sub>
Description		1-bit object for activation of the status LED.			

Function: Status LED (operating mode display, comparator)					
Object	Function	Name	Type	DPT	Flag
 36, 37...- 51	Value	Status LED 1 <sup>1</sup>	1 byte	5.xxx, 6.xxx, 20.102	C, W, -, (R) <sub>2</sub>
Description		1-byte object for activation of the status LED.			

Function: Superimposed function of the status LED (control via separate LED object)					
Object	Function	Name	Type	DPT	Flag
 90, 91... 105	Superposed switching function	Status LED 1 <sup>1</sup>	1-bit	1.xxx	C, W, -, (R)
Description		1-bit object for forced-control activation of the status LEDs. This can be used to change the colour and display information of individual status LEDs according to priority.			

Function: Superposed function for the status LED (Comparator)					
Object	Function	Name	Type	DPT	Flag
 90, 91... 105	Superposed value function	Status LED 1 <sup>1</sup>	1 byte	5.xxx, 6.xxx, 20.102	C, W, -, (R) <sub>2</sub>
Description		1-byte object for forced-control activation of the status LEDs. This can be used to change the colour and display information of individual status LEDs according to priority.			

Function: Separate control of status-LED red					
Object	Function	Name	Type	DPT	Flag
 106, 109 ... 151	Switching colour red	Status LED 1 <sup>1</sup>	1-bit	1.001	C, W, -, (R) <sub>2</sub>
Description		1-bit object for activation of the red status LED.			

1: The objects have been described for status LED 1 as an example. The objects for the other status LED are defined in the same way by shifting the object number and changing the object name.

2: For reading, the R-flag must be set. The last value written to the object via the bus will be read.

---

Function: Separate control of status-LED green

Object	Function	Name	Type	DPT	Flag
 107, 110 ... 152	Switching colour green	Status LED 1 <sup>1</sup>	1-bit	1.001	C, W, -, (R) <sub>2</sub>

Description 1-bit object for activation of the green status LED

---

Function: Separate control of status-LED blue

Object	Function	Name	Type	DPT	Flag
 108, 111 ... 153	Switching colour blue	Status LED 1 <sup>1</sup>	1-bit	1.001	C, W, -, (R) <sub>2</sub>

Description 1-bit object for activation of the blue status LED

---

1: The objects have been described for status LED 1 as an example. The objects for the other status LED are defined in the same way by shifting the object number and changing the object name.

2: For reading, the R-flag must be set. The last value written to the object via the bus will be read.

### 4.2.3.3 Disabling functions

Objects for disabling functions:

Function:	Switching				
Object	Function	Name	Type	DPT	Flag
 16, 17	Switching	Disabling function 1 / 2	1-bit	1.xxx	C, W, T, (R) <sup>1</sup>
Description	1-bit object for transmission of switching telegrams (ON, OFF).				

Function:	Dimming				
Object	Function	Name	Type	DPT	Flag
 16, 17	Switching	Disabling function 1 / 2	1-bit	1.xxx	C, W, T, (R) <sup>1</sup>
Description	1-bit object for transmission of switching telegrams (ON, OFF).				

Function:	Dimming				
Object	Function	Name	Type	DPT	Flag
 34, 35	Dimming	Disabling function 1 / 2	4-bit	1.007	C, W, T, (R) <sup>1</sup>
Description	4-bit object for the transmission of relative dimming telegrams.				

Function:	Venetian blind				
Object	Function	Name	Type	DPT	Flag
 16, 17	Short time operation	Disabling function 1 / 2	1-bit	1.007	C, -, T, (R) <sub>1</sub> <sup>1</sup>
Description	1-bit object for the transmission of telegrams with which a Venetian blind or shutter drive motor can be stopped or with which the blind slats can be adjusted by short time operation.				

Function:	Venetian blind				
Object	Function	Name	Type	DPT	Flag
 34, 35	Long-time operation	Disabling function 1 / 2	1-bit	1.008	C, W, T, (R) <sup>1</sup>
Description	1-bit object for the transmission of telegrams with which a Venetian blind or shutter drive motor can be moved upwards or downwards.				

1: For reading, the R-flag must be set. The last value written to the object via the bus will be read.

Function: 1-byte value transmitter

Object	Function	Name	Type	DPT	Flag
 16, 17	Value	Disabling function 1 / 2	1 byte	5.xxx	C, W, T, (R) <sup>1</sup>

Description 1-byte object for the transmission of values from 0 to 255 (corresponding to values from 0 % to 100 %). If the adjustment of the value is enabled, the object can transmit telegrams cyclically after long actuation with which the value can be reduced or increased by a presettable amount.

Function: 2-byte value transmitter

Object	Function	Name	Type	DPT	Flag
 16, 17	Value	Disabling function 1 / 2	2 byte	7.xxx	C, W, T, (R) <sup>1</sup>

Description 2-byte object for the transmission of values from 0 to 65535. If the adjustment of the value is enabled, the object can transmit cyclical telegrams after a long press with which the value can be reduced or increased by an adjustable amount.

Function: 2-byte value transmitter

Object	Function	Name	Type	DPT	Flag
 16, 17	Temperature value	Disabling function 1 / 2	2 byte	9.001	C, W, T, (R) <sup>1</sup>

Description 2 -byte object for the transmission of a temperature value from 0 °C to 40 °C. If the adjustment of the value is enabled, the object can transmit telegrams cyclically after a long press with which the value can be reduced or increased by 1 K.

Function: 2-byte value transmitter

Object	Function	Name	Type	DPT	Flag
 16, 17	Brightness value	Disabling function 1 / 2	2 byte	9.004	C, W, T, (R) <sup>1</sup>

Description 2-byte object for the transmission of a brightness level value from 0 to 1500 lux. If the adjustment of the value is enabled, the object can transmit cyclical telegrams after a long press with which the value can be reduced or increased by 50 lux.

Function: Scene extension

Object	Function	Name	Type	DPT	Flag
 16, 17	Scene extension	Disabling function 1 / 2	1 byte	18.001	C, -, T, (R) 1

Description 1-byte object for recalling or for storing one of 64 scenes max. from a scene push button sensor.

1: For reading, the R-flag must be set. The last value written to the object via the bus will be read.

Function: 2-channel operation

Object	Function	Name	Type	DPT	Flag
 16, 17	Channel 1 switching	Disabling function 1 / 2	1-bit	1.xxx	C, W, T, (R) <sup>1</sup>
Description		1-bit object for the transmission of switching telegrams, if 2-channel operation is activated.			

Function: 2-channel operation

Object	Function	Name	Type	DPT	Flag
 16, 17	Channel 1 value	Disabling function 1 / 2	1 byte	5.xxx	C, -, T, (R) 1
Description		1-byte object for the transmission of value telegrams, if 2-channel operation is activated.			

Function: 2-channel operation

Object	Function	Name	Type	DPT	Flag
 16, 17	Channel 1 value	Disabling function 1 / 2	2 byte	9.001	C, -, T, (R) 1
Description		2-byte object for the transmission of value telegrams, if 2-channel operation is activated.			

Function: 2-channel operation

Object	Function	Name	Type	DPT	Flag
 34, 35	Channel 2 switching	Disabling function 1 / 2	1-bit	1.xxx	C, W, T, (R) <sup>1</sup>
Description		1-bit object for the transmission of switching telegrams, if 2-channel operation is activated.			

Function: 2-channel operation

Object	Function	Name	Type	DPT	Flag
 34, 35	Channel 2 value	Disabling function 1 / 2	1 byte	5.xxx	C, -, T, (R) 1
Description		1-byte object for the transmission of value telegrams, if 2-channel operation is activated.			

Function: 2-channel operation

Object	Function	Name	Type	DPT	Flag
 34, 35	Channel 2 value	Disabling function 1 / 2	2 byte	9.001	C, -, T, (R) 1
Description		2-byte object for the transmission of value telegrams, if 2-channel operation is activated.			

1: For reading, the R-flag must be set. The last value written to the object via the bus will be read.



---

Function:     Disabling function

Object	Function	Name	Type	DPT	Flag
 <sup>62</sup>	Disabling	Button disabling	1-bit	1.001	C, W, -, (R) 1

Description     1-bit object by means of which the push button sensor can be disabled and enabled again (polarity configurable).

1: For reading, the R-flag must be set. The last value written to the object via the bus will be read.

## 4.2.3.4 Operation LED and labelling field illumination

Objects for operation LED and labelling field illumination:

Function:	Operation LED				
Object	Function	Name	Type	DPT	Flag
 52... 55	Operation LED	Switching	1-bit	1.001	C, W, -, (R) <sub>1</sub>
Description	1-bit object for switching the operation LED on or off ("1" = switch on; "0" = switch off).				

Function:	Operation LED				
Object	Function	Name	Type	DPT	Flag
 52...- 54, 55...- 57	Operation LED	Switching colour red [green, blue]	1-bit	1.001	C, W, -, (R) <sub>1</sub>
Description	1-bit object for switching the red colour of the operation LED on or off ("1" = switch on; "0" = switch off).				

Objects for labelling field illumination and brightness:

Function:	Labelling field illumination				
Object	Function	Name	Type	DPT	Flag
 58, 59	Labelling field illumination	Switching	1-bit	1.001	C, W, -, (R) <sub>1</sub>
Description	1-bit object for switching the labelling field illumination on or off ("1" = switch on; "0" = switch off).				

Function:	Brightness of all LEDs				
Object	Function	Name	Type	DPT	Flag
 60, 61	LED night reduction	Switching	1-bit	1.001	C, W, -, (R) <sub>1</sub>
Description	1-bit object for reducing the brightness of all status LEDs, the labelling field illumination and the operation LED ("1" = reduce; "0" = normal operation).				

1: For reading, the R-flag must be set. The last value written to the object via the bus will be read.

## 4.2.3.5 Alarm signal

Objects for alarm signalling

---

Function:	Alarm signal				
Object	Function	Name	Type	DPT	Flag
 <sup>63</sup>	Switching	Alarm signal	1-bit	1.xxx	C, W, -, (R) 1
Description	1-bit object for the reception of an alarm signalling (polarity configurable).				

---

Function:	Alarm signal				
Object	Function	Name	Type	DPT	Flag
 <sup>64</sup>	Switching	Alarm message acknowledge	1-bit	1.xxx	C, -, T, (R) 1
Description	1-bit object for transmitting the acknowledgement of an alarm signalling (polarity configurable).				

1: For reading, the R-flag must be set. The last value written to the object via the bus will be read.

## 4.2.3.6 Controller extension and room temperature measurement

Objects for the controller extension:

Function:		Controller extension			
Object	Function	Name	Type	DPT	Flag
 65, 71	Operating mode switch-over	Controller extension	1 byte	20.102	C, W, T, (R) <sup>1</sup>
Description		1-byte object for changing over a room temperature controller between the Comfort, Standby, Night and Frost/heat protection operating modes.			

Function:		Controller extension			
Object	Function	Name	Type	DPT	Flag
 66, 72	Forced operating mode switch-over	Controller extension	1 byte	20.102	C, W, T, (R) <sup>1</sup>
Description		1-byte object for changing over a room temperature controller under forced control between the Automatic, Comfort, Standby, Night and Frost / heat protection operating modes			

Function:		Controller extension			
Object	Function	Name	Type	DPT	Flag
 67, 73	Presence button	Controller extension	1-bit	1.001	C, W, T, (R) <sup>1</sup>
Description		1-bit object for changing over the presence status of a room temperature controller (polarity configurable).			

Function:		Controller extension			
Object	Function	Name	Type	DPT	Flag
 68, 74	Setpoint shift specification	Controller extension	1 byte	6.010	C, -, T, (R) <sub>1</sub>
Description		1-byte object for presetting a basic setpoint shift for a controller. $x \leq 0 \leq y$ (0 = no shift active); integral numbers Value object + 1 (increase level value) Value object - 1 (decrease level value) The possible range of values (x to y) is fixed by the setpoint adjusting range to the 'upper limit' or to the 'lower limit' (configurable) in combination with the level value <u>on the room temperature controller</u> .			

1: For reading, the R-flag must be set. The last value written to the object via the bus will be read.

---

Function:	Controller extension				
Object	Function	Name	Type	DPT	Flag
 69, 75	Current setpoint shift	Controller extension	1 byte	6.010	C, W, -, (R) 1
Description	1-byte object used by the extension unit for receiving the current setpoint shift of the room temperature controller. $x \leq 0 \leq y$ (0 = no shift active); integral numbers The possible range of values (x to y) is fixed by the setpoint adjusting range to the 'upper limit' or to the 'lower limit' (configurable) in combination with the level value <u>on the room temperature controller</u> .				

---

Function:	Controller extension				
Object	Function	Name	Type	DPT	Flag
 70, 76	Controller status	Controller extension	1 byte	Not defined	C, W, -, (R) 1
Description	1-byte object used by the extension unit for receiving the current state of operation of the controller. Status LEDs that can be used to indicate a status independently of a button function can display one of the various information units which are grouped in this byte (bit-oriented evaluation).				

## Objects for room temperature measurement

---

Function:	Room temperature measurement				
Object	Function	Name	Type	DPT	Flag
 77, 79	Measured room temperature	Room temperature measurement	2 byte	9.001	C, -, T, (R)
Description	2-byte object for the display of the actual temperature (room temperature) determined by the integrated temperature sensor. The output value considers the parameterised value for the calibration as well as the correction through an external temperature sensor connected to the object "External temperature sensor". Possible value range: -99.9 °C to +99.9 °C / Measurement range of internal temperature sensor: 0 °C to +40 °C. The temperature value is always output in the format "°C".				

---

Function:	Room temperature measurement				
Object	Function	Name	Type	DPT	Flag
 78, 80	External temperature sensor	Room temperature measurement	2 byte	9.001	C, W, -, (R) 1
Description	2-byte object for coupling an external KNX room temperature sensor. Thus cascading of multiple temperature sensors for room temperature measurement. Possible range of values: -99.9 °C to +99.9 °C. The temperature value must always be specified in the format "°C".				

1: For reading, the R-flag must be set. The last value written to the object via the bus will be read.

## 4.2.3.7 Scene function

Objects for scene function:

Function:	Scene function				
Object	Function	Name	Type	DPT	Flag
<input type="checkbox"/> ← <sup>81...-</sup> <sub>88</sub>	Switching	Scene output 1 <sup>1</sup>	1-bit	1.001	C, W, T, (R) <sup>2</sup>
Description	1-bit objects for controlling up to eight actuator groups (ON, OFF).				

Function:	Scene function				
Object	Function	Name	Type	DPT	Flag
<input type="checkbox"/> ← <sup>81...-</sup> <sub>88</sub>	Value	Scene output 1 <sup>1</sup>	1 byte	5.001	C, W, T, (R) <sup>2</sup>
Description	1-byte objects for controlling up to eight actuator groups (0...255).				

Function:	Scene function				
Object	Function	Name	Type	DPT	Flag
<input type="checkbox"/> ← <sup>89</sup>	Extension unit input	Scene	1 byte	18.001	C, W, -, (R) <sub>2</sub>
Description	1-byte object with which one of the eight internally stored scenes can be recalled or stored again.				

1: Scene outputs 2 ... 8 see scene output 1, shift of the object number (66 + number of scene output - 1).

2: For reading, the R-flag must be set. The last value written to the object via the bus will be read.

## 4.2.3.8 Energy saving mode

Object for energy saving mode:

Function:	Energy saving mode				
Object	Function	Name	Type	DPT	Flag
 <sup>154</sup>	Activate / deactivate	Energy saving mode	1-bit	1.001	C, W, (T), (R) <sup>1</sup>
Description	<p>1-bit object for activating or deactivating the energy saving mode. The function (only activate, only deactivate, activate and deactivate) and the telegram polarity are configurable.</p> <p>If the transmission flag is set, other devices can be informed of the deactivation of energy-saving mode through operation on the local device. These devices then exit energy-saving mode (precondition: all the devices are linked to the same group address and deactivation via the object must have been planned for in the parameterisation of the other devices). When energy-saving mode is deactivated with a set transmission flag, the device sends an "Energy-saving mode deactivated" telegram to the bus, according to the inverted activation telegram polarity.</p>				

1: For reading, the R-flag must be set. The last value written to the object via the bus will be read.

## **4.2.4 Functional description**

### **4.2.4.1 General settings**

#### **4.2.4.1.1 Button configuration**

In the general settings, it is possible to define whether an extension module (TSEM) is connected to the pushbutton sensor module (TSM). A push-button extension module expands the number of control surfaces in addition to the control surfaces of the basic unit, so that up to four rockers or 8 buttons more are available.

Thus, for example, a 1-gang pushbutton sensor module as a basic device can be supplemented with a 4-gang extension module, adding 8 to 10 control surfaces.

The rockers or buttons of the extension module are evaluated by the application program of the basic unit. In addition, each control surface of the extension module has a status LED, which is also activated by the application program of the basic device. Consequently, an extension module does not have any application program of its own or a bus coupling unit, and is configured and put into operation in the ETS via the product database of the basic device. Each basic unit can have only one extension module connected to it. Together, a basic unit and an extension module form the "Push-button sensor unit".

Configuration of the control surfaces of the connected extension module is also carried out in the ETS on the "General" parameter page.

The button configuration of the basic module is permanently specified by the application program used in the ETS project, and cannot be changed (e.g. 4-gang universal pushbutton sensor TSM = 4 rockers / buttons 1...8 on the basic device). If a pushbutton sensor extension module is connected, the type of the extension module, and with it the number of available buttons, must be enabled separately in the ETS. In the ETS parameter view, the corresponding communication objects and parameters are automatically displayed.

The enabled functions of the extension module are displayed and configured in the ETS in the same way as the rockers or buttons of the basic module.

The button numbers and all further functions for the basic module and extension module are separately displayed and counted.



#### 4.2.4.1.2 Operation concept and button evaluation

The changeover between rockers and pushbutton operation of a control surface of the basic or extension module is made on the parameter pages "TSM operation concept" and "TSEM operation concept". The parameter page "TSEM operation concept" is only visible if an extension module has been connected and enabled.

The "Operation concept..." parameters specify for each control surface whether the opposing buttons are combined into a common rocker function, or are evaluated as two separate pushbutton functions.

The additional parameter pages and the communication objects of the rockers or buttons are then also created and adapted depending on the setting parameterized here.

- i Pressing several rockers or buttons at the same time will be considered as a wrong operation. The special rocker function "Full-surface operation" is an exception to the above rule. In this case, the parameterisation of the rocker decides whether the operation is a wrong operation or not.

The functions of the individual rockers or buttons are set on the parameter pages "Rocker switch ... (buttons ...)" or "Button ...".

##### **Button pair as rocker function**

For rocker functions, the opposing buttons affect the communication objects together. As a rule, actuation of the two buttons then result in directly opposite information (e.g. switching: ON - OFF / blind: UP - DOWN). When a button is pressed, the commands should be made independently of each other.

##### **Full-surface operation with rocker function**

Depending on the basic function of a rocker, it is also possible with some settings to use a press on the full surface with a separate function. With full-surface operation, both buttons of a rocker switch are pressed at the same time.

##### **Button pair as push-button function**

With button operation, the control surfaces are evaluated independently of each other (single-surface operation).

### 4.2.4.1.3 Operation LED

Some of the functions of the operation LED of the pushbutton sensor modules are permanently predefined internally:

- In a non-programmed device (delivery state) or with an incorrectly-loaded application program, this LED flashes – together with the labelling field – at a slow frequency of approx. 0.75 Hz. For this case, the colour is permanently set to blue.
- When the push-button sensor is switched over into the programming mode for commissioning or for diagnosis purposes, the LED flashes at a fast rate of about 8 Hz (cf. "Commissioning" in the hardware description of this documentation). In this case too, the colour is permanently set to blue.

In the ETS, additional functions can be set through parameters:

- The LED can flash together with all other status LEDs with a frequency of about 2 Hz, when the communication object for the alarm signalling is active.
- The LED can display the status of a separate communication object in inverted or non-inverted form. Here the operation LED can also be activated as flashing with a frequency of approx. 2 Hz.
- It can be switched on permanently to serve as orientation lighting.
- It can be switched off permanently.
- It can be switched on by pressing a button of the pushbutton sensor module and switched off after a pre-set time has elapsed.

If several of the above states occur at the same time, the priority is as follows:

1. Indication of the programming mode.

The programming mode is cancelled automatically after any actuation on the basic module.

2. The display of an alarm.

The mode of resetting the alarm either automatically by a button-press or by the communication object must be specified in the parameters.

3. The status indication for the separate communication object or the permanent states (on, off, automatic switch-off).

The operation LEDs are activated using either one single or three separate 1-bit communication objects. In the first case, the colour is permanently predefined by the parameter "Colour of the operation LED". When the parameter "Function and colour of the operation LED" is set to the value "3-colour control via objects", an individual communication object is displayed for each colour red, green and blue. The most recently received communication object, which switches the LED to active, then determines the colour of the LED. A switch-off signal always only switches the corresponding colour off. Then the LED switches back to the colour of the previously received object. The LED is off when all communication objects have the value "0".

**i** The pushbutton sensor extension module also has an operation LED. The same display functions of the operation LEDs as in the basic device are available on the extension module.

#### 4.2.4.1.4 Labelling field illumination

The labelling field can be illuminated by white LEDs. The labelling field illumination can be used flexibly as needed, whereby individual functions are permanently predefined internally:

- In a non-programmed device (delivery state) or after downloading of a wrong application program, it flashes – together with the the operation LED – at a slow rate of approx. 0.75 Hz.
- When a full-surface press with the rocker function has been detected, the labelling field flashes at about 8 Hz.

The application software permits selecting parameters for further functions:

- The labelling field can flash together with all other red status LEDs at a frequency of approx. 2 Hz, when the communication object for the alarm message is active.
- The LED can display the status of a separate communication object in inverted or non-inverted form. The labelling field can also be activated as flashing with a frequency of approx. 2 Hz.
- The labelling field can be switched on permanently to serve as orientation lighting.
- The labelling field can be switched off permanently.
- The labelling field illumination can be switched on by pressing a button of the pushbutton sensor and switched off after a pre-set time has elapsed.

If several of the above states occur at the same time, the priority is as follows:

1. The display of a valid full-surface actuation with the rocker function.

2. The display of an alarm.

The mode of resetting the alarm either automatically by a button-press or by the communication object must be specified in the parameters.

3. The status indication for the separate communication object or the permanent states (on, off, automatic switch-off).

- i** The labelling field of a connected pushbutton sensor extension module can be illuminated in the same way. To do so, the same functions as in the basic device are available in the extension module.

#### 4.2.4.1.5 Transmission delay

After a reset (e.g. after the application program or the physical address is loaded or after the bus voltage is switched on), the push-button sensor for the room temperature controller extension unit can transmit telegrams automatically. In case of the controller extension, the pushbutton sensor attempts to retrieve values from the room temperature controller by means of read telegrams in order to update the object states. In case of the room temperature measurement, the pushbutton sensor transmits the current room temperature after a reset to the bus.

If in addition to the push button sensor there are still other devices installed in the bus which transmit telegrams immediately after a reset, it may be useful to activate the transmit delay for automatically transmitting objects on the "General" page in order to reduce the bus load.

When transmit delay is activated, the push button sensor determines the value of its individual delay from the device number of its physical address (phys. address: area.line.device number). This value can be about 30 seconds maximum. Without setting a special time delay, this principle prevents multiple push button modules from trying to transmit telegrams to the bus at the same time.

- i The transmit delay is not active for the rocker and button functions of the push button sensor.

#### **4.2.4.2 Rockers and button functions**

The following contains descriptions of the various functions that can be configured for each rocker or each button of the push-button sensor. The functions can be parameterized freely and without limitations for both the basic unit and for the push-button extension module.

##### **4.2.4.2.1 Switching function**

For each rocker or each button with the function set to "switching" the ETS indicates a 1-bit communication object. The parameters of the rocker or button permit fixing the value this object is to adopt on pressing and / or on releasing (ON, OFF, TOGGLE – toggling of the object value). No distinction is made between a brief or long press.

The status LEDs can be configured independently (see chapter 4.2.4.3. Status LED).

## 4.2.4.2.2 Dimming function

For each rocker or each button with the function set to "dimming" the ETS indicates a 1-bit and a 4-bit object. Generally, the push button sensor transmits a switching telegram after a brief press and a dimming telegram after a long press. In the standard parameterisation, the push button sensor transmits a telegram for stopping the dimming action after a long press. The time needed by the push button sensor to detect an actuation as a long actuation can be set in the parameters.

The status LEDs can be configured independently (see chapter 4.2.4.3. Status LED).

### Single-surface and double-surface operation in the dimming function

In the rocker function, the device is preprogrammed for double-surface operation for the dimming function. This means that the pushbutton sensor transmits a telegram for switch-on after a brief press and a telegram for increasing the brightness after a long press of the left button ("brighter"). Similarly, the pushbutton sensor transmits a telegram for switch-off after a brief press and a telegram for reducing the brightness after a long press on the right button ("darker").

With the pushbutton operation concept, the device is preprogrammed for single-surface operation for the dimming function. In this mode, the push button sensor transmits on each brief press ON and OFF telegrams in an alternating pattern ("TOGGLE"). After a long press, the push button sensor transmits "brighter" and "darker" telegrams in an alternating pattern.

The parameter "Command on pressing the button" or "Command on pressing the rocker" on the parameter pages of the buttons or rockers defines the single-surface or double-surface operation principle for the dimming function. For the rocker and also for the button function, the command issued on pressing the button or rocker can basically be selected at the user's discretion.

- i** If the actuator can be controlled from several sensors, a faultless single-surface operation requires that the addressed actuator reports its switching state back to the 1-bit object of the button or rocker and that the 4-bit objects of the push-button sensors are interlinked. The push button sensor would otherwise not be able to detect that the actuator has been addressed from another sensor, in which case it would have to be actuated twice during the next use in order to produce the desired reaction.

### Advanced parameters

For the dimming function, the pushbutton sensor can be programmed with advanced parameters which are hidden in the standard view for greater clarity. If necessary, these advanced parameters can be activated and thus be made visible.

The advanced parameters can be used to determine whether the pushbutton sensor is to cover the full adjusting range of the actuator with one dimming telegram continuously ("Increase brightness by 100 %", "Reduce brightness by 100 %") or whether the dimming range is to be divided into several small levels (50 %, 25 %, 12.5 %, 6 %, 3 %, 1.5 %).

In the continuous dimming mode (100%), the push-button sensor transmits a telegram only at the beginning of the long press to start the dimming process and generally a stop telegram after the end of the press. For dimming in small levels it may be useful if the push button sensor repeats the dimming telegram in case of a sustained press for a presettable time (parameter "Telegram repetition"). The stop telegram after the end of the press is then not needed. When the parameters are hidden ("Advanced parameters = deactivated"), the dimming range is set to 100 %, the stop telegram is activated and the telegram repetition is deactivated.

### Full-surface operation with the dimming function

When a rocker is used for dimming, the push button sensor needs some time at the beginning

of each operation in order to distinguish between a short and a long operation. When full-surface operation is enabled, the pushbutton sensor can make use of this time span to evaluate the otherwise invalid simultaneous actuation of both buttons of the rocker switch.

Full-surface operation of a rocker switch is detected by the pushbutton sensor when both buttons are pressed at the same time. When the pushbutton sensor has detected a valid full-surface actuation, the labelling field illumination flashes quickly at a rate of approx. 8 Hz for the duration of the operation. Full-surface operation must have been detected before the first telegram has been transmitted by the dimming function (switching or dimming). If this is not so (e.g. one of the two buttons is pressed too late), the full-surface operation will not be correctly executed.

Full-surface actuation is independent. It has a communication object of its own and can optionally be used for switching (ON, OFF, TOGGLE – toggling of the object value) or for scene recall without or with storage function. In the last case, a press on the full surface causes a scene to be recalled in less than a second. If the push button sensor is to send the telegram for storing a scene, full-surface actuation must be maintained for more than five seconds. If full-surface actuation ends between the first and the fifth second, the push button sensor will not send any telegrams. If the status LEDs of the rocker are used as "button-press displays", they will light up for three seconds during transmission of the storage telegram.

### 4.2.4.2.3 "Blind" function

For each rocker or each button with the function set to "blind" the ETS indicates the two 1-bit objects "STEP operation" and "MOVE operation".

The status LEDs can be configured independently (see chapter 4.2.4.3. Status LED).

#### Operation concept for the Venetian blind function

For the control of Venetian blind, roller shutter, awning or similar drives, the push button sensor supports four operation concepts in which the telegrams are transmitted in different time sequences. The push button can therefore be used to operate a wide variety of drive configurations.

The different operation concepts are described in detail in the following chapters.

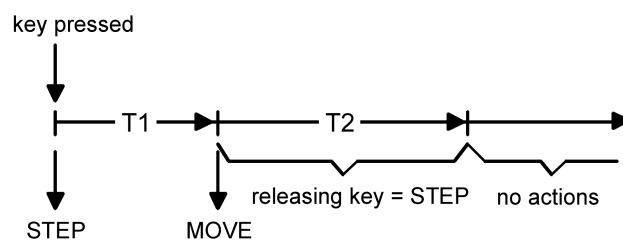

Figure 9: Operation concept "short – long – short"

#### Operation concept "short - long – short":

In the operation concept "short – long – short", the push button sensor shows the following behaviour:

- Immediately on pressing the button, the push button sensor transmits a short time telegram. Pressing the button stops a running drive and starts time T1 ("time between short time and long time command"). No other telegram will be transmitted, if the key is released within T1. This short time serves the purpose of stopping a continuous movement. The "time between short and long time command" in the push button sensor should be selected shorter than the short time operation of the actuator to prevent a jerky movement of the blind.
- If the button is kept depressed longer than T1, the push button sensor transmits a long time telegram after the end of T1 for starting up the drive and time T2 ("slat adjusting time") is started.
- If the button is released within the slat adjusting time, the push button sensor sends another short time telegram. This function is used for adjusting the slats of a blind. The function permits stopping the slats in any position during their rotation. The "slat adjusting time" should be chosen as required by the drive for a complete rotation of the slats. If the "slat adjusting time" is selected longer than the complete running time of the drive, a push button function is possible as well. This means that the drive is active only when the button is kept depressed.
- If the button is kept depressed longer than T2, the push button sensor transmits no further telegram. The drive remains on until the end position is reached.



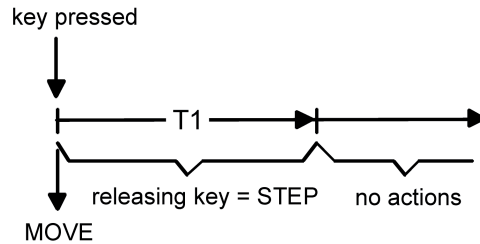

Figure 10: Operation concept "long – short"

### Operation concept "long – short":

If the operation concept "long – short" is selected, the push button sensor shows the following behaviour:

- Immediately on pressing the button, the push button sensor transmits a long time telegram. The drive begins to move and time T1 ("slat adjusting time") is started.
- If the button is released within the slat adjusting time, the push button sensor transmits a short time telegram. This function is used for adjusting the slats of a blind. The function permits stopping the slats in any position during their rotation. The "slat adjusting time" should be chosen as required by the drive for a complete rotation of the slats. If the "slat adjusting time" is selected longer than the complete running time of the drive, a push button function is possible as well. This means that the drive is active only when the button is kept depressed.
- If the button is kept depressed longer than T1, the push button sensor transmits no further telegram. The drive remains on until the end position is reached.

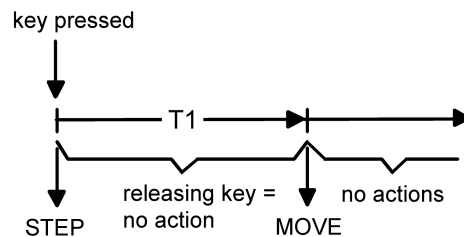

Figure 11: Operation concept "short – long"

### Operation concept "short – long":

In the operation concept "short – long", the push button sensor shows the following behaviour:

- Immediately on pressing the button, the push button sensor transmits a short time telegram. Pressing the button stops a running drive and starts time T1 ("time between short time and long time command"). No other telegram will be transmitted, if the key is released within T1. This short time serves the purpose of stopping a continuous movement. The "time between short and long time command" in the push button sensor should be selected shorter than the short time operation of the actuator to prevent a jerky movement of the blind.
- If the button is kept depressed longer than T1, the push button sensor transmits a long time telegram after the end of T1 for starting the drive.
- No further telegram is transmitted when the button is released. The drive remains on until the end position is reached.

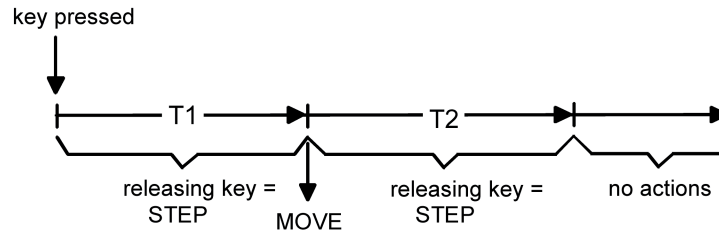

Figure 12: Operation concept "long – short or short"

### Operation concept "long – short or short":

In the operation concept "long – short or short", the push button sensor shows the following behaviour:

- Immediately on pressing the button, the push button sensor starts time T1 ("time between short and long time command") and waits. If the button is released again before T1 has elapsed, the push button sensor transmits a short time telegram. This telegram can be used to stop a running drive. A stationary drive rotates the slats by one level.
- If the button is kept depressed after T1 has elapsed, the push button sensor transmits a long time telegram and starts time T2 ("slat adjusting time").
- If the button is released within T2, the push button sensor sends another short time telegram. This function is used for adjusting the slats of a blind. The function permits stopping the slats in any position during their rotation. The "slat adjusting time" should be chosen as required by the drive for a complete rotation of the slats. If the "slat adjusting time" is selected longer than the complete running time of the drive, a push button function is possible as well. This means that the drive is active only when the button is kept depressed.
- If the button is kept depressed longer than T2, the push button sensor transmits no further telegram. The drive remains on until the end position is reached.

- i** In this operation concept, the push button sensor will not transmit a telegram immediately after depressing one side of the rocker. This principle permits detecting a full-surface operation when the sensor is configured as a rocker.

### Single-surface and double-surface operation in the blind function

As a rocker, the device is preprogrammed for double-surface actuation for the blind function. This means that the pushbutton sensor, e.g. with a press of the left button, transmits a telegram for an upward movement and, after a press of the right button, a telegram for a downward movement.

In the separate buttons function, the device is preprogrammed for single-surface actuation for the blind function. In this case, the push button sensor alternates between the directions of the long time telegram (TOGGLE) on each long actuation of the sensor. Several short time telegrams in succession have the same direction.

The parameter "Command on pressing the button" or "Command on pressing the rocker" on the parameter pages of the buttons or rockers defines the single-surface or double-surface operation principle for the Venetian blind function.

For the button function, the command issued on pressing the button can basically be selected at the user's discretion.

If the actuator can be controlled from several sensors, a faultless single-surface actuation requires that the long time objects of the push button sensors are interlinked. The push button sensor would otherwise not be able to detect that the actuator has been addressed from another sensor, in which case it would have to be actuated twice during the next use in order to produce the desired reaction.

## Full-surface operation with Venetian blind function

When a rocker is configured for Venetian blind operation and if the operation concept "long – short or short" is used, the push button sensor needs some time at the beginning of each operation in order to distinguish between a short and a long operation. When full-surface operation is enabled, the pushbutton sensor can make use of this time span to evaluate the otherwise invalid simultaneous actuation of both buttons of a rocker switch.

Full-surface operation of a rocker switch is detected by the pushbutton sensor when both buttons are pressed at the same time. When the pushbutton sensor has detected a valid full-surface actuation, the labelling field illumination flashes quickly at a rate of approx. 8 Hz for the duration of the operation. Full-surface operation must have been detected before the first telegram has been transmitted by the Venetian blind function (short time or long time). If this is not so (e.g. one of the two buttons is pressed too late), the full-surface operation will not be correctly executed.

Full-surface actuation is independent. It has a communication object of its own and can optionally be used for switching (ON, OFF, TOGGLE – toggling of the object value) or for scene recall without or with storage function. In the last case, a press on the full surface causes a scene to be recalled in less than a second. If the push button sensor is to send the telegram for storing a scene, full-surface actuation must be maintained for more than five seconds. If full-surface actuation ends between the first and the fifth second, the push button sensor will not send any telegrams. If the status LEDs of the rocker are used as "button-press displays", they will light up for three seconds during transmission of the storage telegram.

#### 4.2.4.2.4 "Value transmitter" function

For each rocker or each button with the function set to "1-byte value transmitter" or "2-byte value transmitter", the ETS indicates a corresponding object. On the press of a button, the configured value or the value last stored internally by a value change (see below) will be transmitted to the bus. In case of the rocker function, different values can be parameterized or varied for both actuation points.

The status LEDs can be configured independently (see chapter 4.2.4.3. Status LED).

##### Value ranges

The "Function" parameter determines the value range used by the push button.

As a 1-byte value transmitter, the push-button sensor can optionally transmit integers from 0 ... 255 or relative values within a range of 0 ... 100 % (e.g. as dimming value transmitter).

As a 2-byte value transmitter, the push-button sensor can optionally transmit integers from 0 ... 65535, temperature values within a range of 0 ... 40 °C or brightness values from 0 ... 1500 lux.

For each of these ranges, the value that can be transmitted to the bus for each actuation of a rocker or button is configurable.

##### Adjustment by means of long button-press

If the value adjustment feature has been enabled in the ETS, the button must be kept depressed for more than 5 seconds in order to vary the current value of the value transmitter. The value adjustment function continues to be active until the button is released again. In a value adjustment, the push button sensor distinguishes between the following options...

- The "Starting value in case of value adjustment" parameter defines the original starting value for the adjustment. Adjustment can begin from the value configured in the ETS, from the final value of the last adjustment cycle or from the current value of the communication object, with the last option not being available for the temperature and brightness value transmitter.
- The parameter "Direction of value adjustment" defines whether the values will always be increased ("upwards"), always reduced ("downwards") or alternately increased and reduced ("toggling").
- For the value transmitters 0 ... 255, 0 ... 100 % and 0 ... 65535, the "step width" by which the current value is to be changed during the value adjustment can be specified. In case of the temperature and the brightness value transmitter, the step width specifications (1 °C and 50 lux) are fixed.
- The parameter "Time between two telegrams" can be used in connection with the step width to define the time required to cycle through the full respective value range. This value defines the time span between two value transmissions.
- If, during the value adjustment, the push button sensor detects that the preset step width would result in the limits being exceeded with the next telegram, it adapts the step width once in such a way that the respective limit value is transmitted together with last telegram. Depending on the setting of the parameter "Value adjustment with overflow", the push button sensor stops the adjustment at this instance or inserts a pause consisting of two levels and then continues the adjustment beginning with the other limit value.

Value range limits for the different value transmitters:

	Function	Lower numerical limit	Upper numerical limit
1-byte value transmitter	0...255	0	255
1-byte value transmitter	0...100 %	0 % (value = 0)	100 % (value = 255)
2-byte value transmitter	0...65535	0	65535
2-byte value transmitter	Temperature value	0 °C	40 °C
2-byte value transmitter	Brightness value	0 lux	1.500 lux

- i** During a value adjustment, the newly adjusted values are only in the volatile RAM memory of the push button sensor. Therefore, the stored values are replaced by the preset values programmed in the ETS when a reset of the push button sensor occurs (bus voltage failure or ETS programming).
- i** During a value adjustment, the status LED of the corresponding button is switched off irrespective of configuration. The status LED will then light up for approx. 250 ms whenever a new value is transmitted.
- i** With the 1-byte value transmitter in the "Value transmitter 0...100 %" function, the step width of the adjustment will also be indicated in "%". If the starting value of the communication object is used, it may happen in this case during value adjustment that the value last received via the object must be rounded and adapted before a new value can be calculated on the basis of the step width and transmitted. Due to the computation procedure used, the new calculation of the value may be slightly inaccurate.

### Value adjustment examples

Configuration example:

- Value transmitter 1-byte (all other value transmitters identical)
- Function = value transmitter 0...255
- Value configured in the ETS (0...255) = 227
- Step width (1...10) = 5
- Start on value adjustment = same as configured value
- Direction of value adjustment = toggling (alternating)
- Time between two telegrams = 0.5 s

Example 1: Value adjustment with overflow? = No

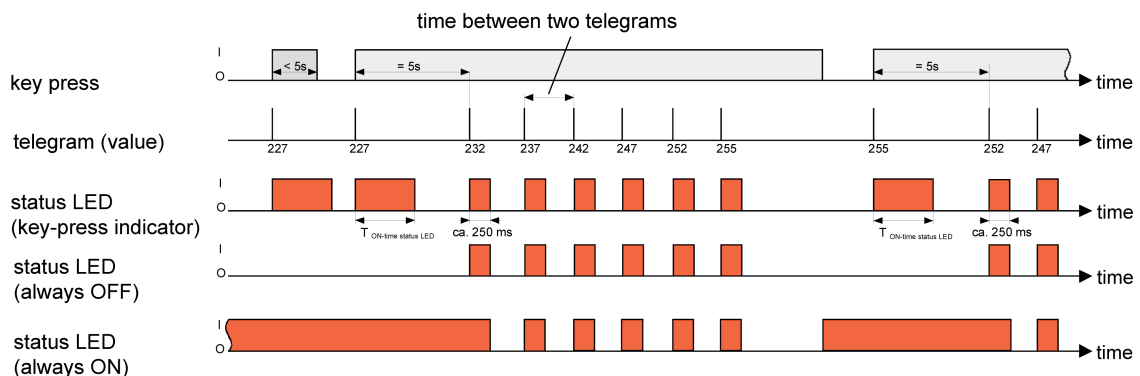

Figure 13: Example of value adjustment without value range overflow

Example 2: Value adjustment with overflow? = Yes

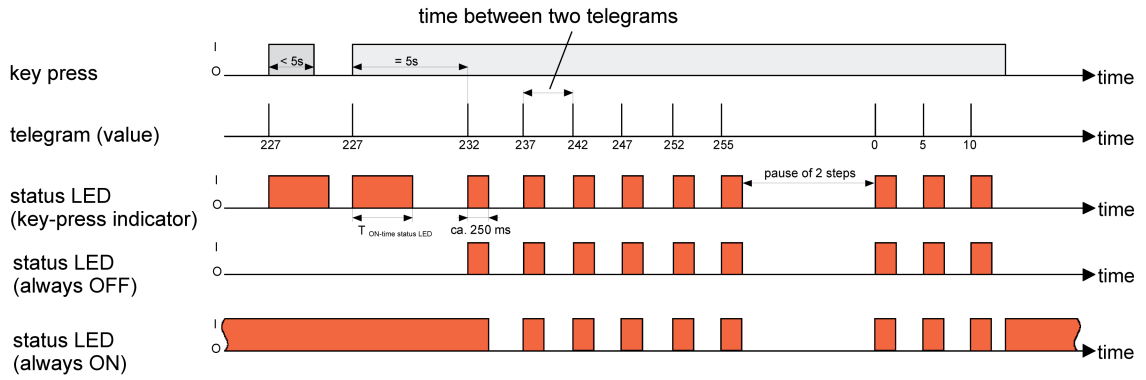

Figure 14: Example of value adjustment with value range overflow

#### 4.2.4.2.5 Scene extension function

For each rocker or each button with the function set to "scene extension" the ETS indicates the "Function" parameter which distinguishes between the settings...

- "Scene extension without store function",
- "Scene extension with storage function",
- "Recall internal scene without store function"
- "Recall internal scene with store function".

...unterscheidet.

In the scene extension function, the push button sensor transmits a preset scene number (1...64) via a separate communication object to the bus after a button-press. This feature permits recalling scenes stored in other devices and also storing them, if the storage function is used.

The recall of an internal scene does not result in a telegram being transmitted to the bus. For this reason, the corresponding communication object is missing. This function can rather be used to recall – and with the storage function also to store – the up to 8 scenes stored internally in the universal push-button sensor TSM.

In the setting "... without store function", a button-press triggers the simple recall of a scene. If the status LED is configured as button-press display, it will be switched on for the configured ON time. A long button-press has no further or additional effect.

In the setting "... with storage function", the push button sensor monitors the length of the actuation. A button-press of less than a second results in a simple recall of the scene as mentioned above. If the status LED is configured as button-press display, it will be switched on for the configured ON time.

After a button-press of more than five seconds, the push button sensor generates a storage instruction. In the scene extension function, a storage telegram is in this case transmitted to the bus. If configured for the recall of an internal scene, the sensor will store the internal scene. The internal scene control module of the Universal TSM pushbutton sensor will then request the current scene values for the actuator groups used from the bus (see chapter 4.2.4.5. Scene control).

An operation lasting between one and five seconds will be discarded as invalid.

The parameter "Scene number" specifies which of the maximum of 8 internal or 64 external scenes is to be used after a button-press. In case of the rocker function, two different scene numbers can be assigned.

The status LEDs can be configured independently (see chapter 4.2.4.3. Status LED).

## 4.2.4.2.6 "2-channel operation" function

In some situations it is desirable to control two different functions with a single button-press and to transmit different telegrams, i.e. to operate two function channels at a time. This is possible with the "2-channel operation" function.

For both channels, the parameters "Function channel 1" and "Function channel 2" can be used to determine the communication object types to be used. The following can be selected...

- Switching (1 bit)
- Value transmitter 0 ... 255 (1-byte)
- Value transmitter 0 ... 100 % (1-byte)
- Temperature value transmitter (2 bytes)

The object value the push button sensor is to transmit on a button-press can be selected depending on the selected object type. The "Switching (1 bit)" type permits selecting whether an ON or an OFF telegram is to be transmitted or whether the object value is to be switched over (TOGGLE) and transmitted on the press of a button.

The configuration as "Value transmitter 0 ... 255 (1 byte)" or as "Value transmitter 0 ... 100 % (1 byte)" permits entering the object value freely within a range from 0 to 255 or from 0% to 100%. The "Temperature value transmitter (2 bytes)" permits selecting a temperature value between 0°C and 40°C.

In this case, the adjustment of the object value on a long button-press is not possible as the determination of the actuation length is needed for the adjustable operation concepts.

Unlike in the other rocker and button functions, the application software assigns the "Telegram acknowledge" function instead of the "Button-press display" function to the status LED. In this mode, the status LED lights up for approx. 250 ms with each telegram transmitted. As an alternative, the status LEDs can be configured independently (see chapter 4.2.4.3. Status LED).

### Operation concept channel 1 or channel 2

In this operation concept, exactly one telegram will be transmitted on each press of a button.

- On a brief press the push button sensor transmits the telegram for channel 1.
- On a long press the push button sensor transmits the telegram for channel 2.

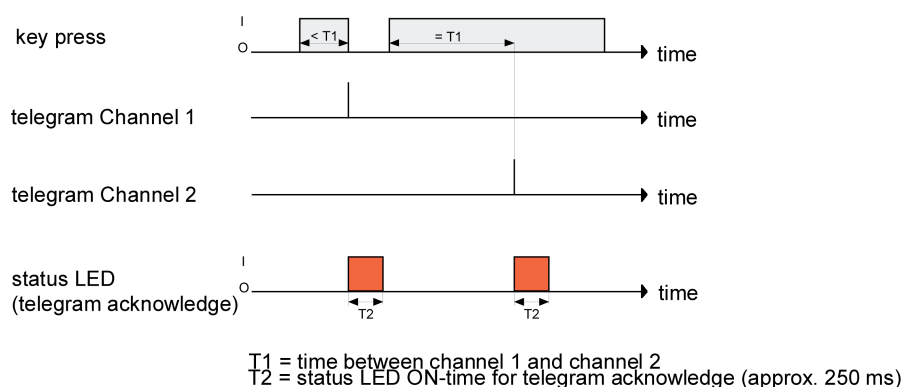

Figure 15: Example of operation concept "Channel 1 or Channel 2"

The time required for distinguishing between a short and a long operation is defined by the parameter "Time between channel 1 and channel 2". If the button is pressed for less than the configured time, only the telegram to channel 1 is transmitted. If the length of the button-press exceeds the time between channel 1 and channel 2, only the telegram to channel 2 will be transmitted. This concept provides the transmission of only one channel. To indicate that a



telegram has been transmitted, the status LED lights up for approx. 250 ms in the "Telegram acknowledge" setting.

In this operation concept, the push button sensor will not transmit a telegram immediately after the rocker has been depressed. This principle also permits the detection of full-surface operation. The settings that are possible with full-surface operation are described below.

### Operation concept channel 1 and channel 2

With this operation concept, one or alternatively two telegrams can be transmitted on each button-press.

- On a brief press the push button sensor transmits the telegram for channel 1.
- A long press causes the push button sensor to transmit first the telegram for channel 1 and then the telegram for channel 2.

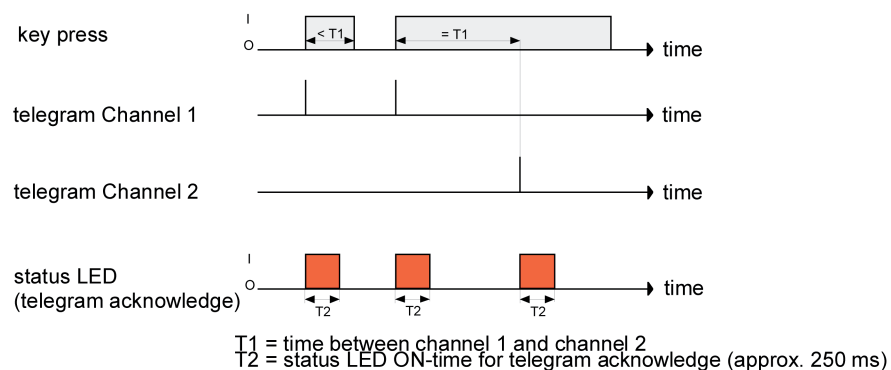

Figure 16: Example of operation concept "Channel 1 or Channel 2"

The time required for distinguishing between a short and a long operation is defined by the parameter "Time between channel 1 and channel 2". In this operation concept, a button-press sends this telegram immediately to channel 1. If the button is held depressed for the configured time, the telegram for the second channel is transmitted as well. If the button is released before the time has elapsed, no further telegram will be transmitted. This operation concept, too, offers the parameterizable possibility of having the transmission of a telegram signalled by the status LED (setting "Telegram acknowledge").

### Full-surface operation with 2-channel operation

When a rocker is programmed for 2-channel operation and if the operation concept "channel 1 or channel 2" is used, the push button sensor needs some time at the beginning of each operation in order to distinguish between a short and a long operation. When full-surface operation is enabled, the pushbutton sensor can make use of this time span to evaluate the otherwise invalid simultaneous actuation of both buttons of a rocker switch.

Full-surface operation of a rocker switch is detected by the pushbutton sensor when both buttons are pressed at the same time. When the pushbutton sensor has detected a valid full-surface actuation, the labelling field illumination flashes quickly at a rate of approx. 8 Hz for the duration of the operation. The full-surface operation must have been detected before the first telegram has been transmitted by the 2-channel function. If this is not so (e.g. one of the two buttons is pressed too late), the full-surface operation will not be correctly executed.

## 4.2.4.3 Status LED

### Functions of the status LED

Each control surface on the pushbutton sensor basic device or on the extension module has a three-colour status LED. The functions available differ slightly depending on the settings of the rockers or buttons.

- i** In order to keep the complexity of the ETS product database within limits, the ETS always offers all function settings for the status LED – regardless of the set function of the respectively corresponding rocker switch or button. In every case in which the combination of button / rocker switch functions and the LED function do not result in a sensible display, the LED remains switched off permanently.  
The LED functions configurable for each set button / rocker switch function are written as information text on the parameter pages "Status LED".

The following functions are always configurable for each status LED, even if the corresponding buttons have no assigned function...

- always OFF,
- always ON,
- Control via separate LED object,
- Operating mode display (KNX controller),
- Controller status indicator (activate controller extension!),
- Comparator without sign (1 byte),
- Comparator with sign (1 byte).

If a function has been assigned to a rocker switch or button, the following functions can be additionally parameterised...

- Button-press display.

For the function "2-channel operation", the LED function "Button-press display" corresponds to the setting...

- Telegram acknowledgment.

If the rocker switch or the button is used for switching or dimming, the following functions can additionally be parameterised...

- Status display (switching object)
- inverted status display (switching object).

If a button is used for the operation of a controller extension (controller extension must be enabled), the following settings can also be predefined...

- Controller status indication,
- Setpoint value shift display,
- Presence status,
- Inverted presence status.

- i** Besides the functions that can be set separately for each status LED, all status LEDs are also used together with the operation LED for alarm signalling. If this is active, all LEDs of the pushbutton sensor basic device or the extension module flash simultaneously. After deactivation of the alarm signalling, all LEDs will immediately return to the state corresponding to their configuration and communication objects.

## Status LED function "always OFF" or "always ON"

With this parameterisation, a status LED remains permanently switched on or off.

## Function of the status LED "Button-press display" or "Telegram acknowledgement"

A status LED used as button-press display is switched on by the sensor each time the corresponding rocker or button is pressed. The parameter "ON time of status LEDs as actuation indicators" on the parameter page "General" specifies for how long the LED is switched on in common for all status LEDs. The status LED lights up when the rocker or button is pressed even if the telegram is transmitted by the sensor only when the button or rocker is released.

With the function "2-channel operation" the option "Button-press display" is replaced by "Telegram acknowledge". In this case the status LED is illuminated when both channels are transmitted for about 250 ms each.

## Function of the status LED "Control via separate LED object", "Status display", and "Inverted status display"

Each status LED can indicate the status of a separate LED communication object independently of the rocker or pushbutton configuration. Here the LED can be switched on or off statically via the 1-bit object value received, or also activated as flashing.

Additionally, the status LEDs can be linked in the rocker or button functions "switching" and "dimming" also with the object used for switching and thus signal the current switching state of the actuator group.

Both for the status indication of the LED object and also for the status indication of the switching object it is possible to indicate or evaluate the inverted object value.

After a reset or after ETS programming, the value of the LED object is always "OFF".

## Function of status LED as "operating mode display (KNX controller)"

For switching over between different modes of operation, new room temperature controller can make use of two communication objects of the 20.102 "HVAC-Mode" data type. One of these objects can switch over with normal priority between the "Comfort", "Standby", "Night", "Frost/heat protection" operating modes. The second object has a higher priority. It permits switching over between "Automatic", "Comfort", "Standby", "Night", "Frost/heat protection". Automatic means in this case that the object with the lower priority is active.

If a status LED is to indicate the operating mode, the communication object of the status LED must be linked with the matching object of the room temperature controller. The desired operating mode which the LED is to indicate can then be selected with the parameter "Status LED on with". The LED is then lit up when the corresponding operating mode has been activated at the controller.

After a reset or after ETS programming, the value of the LED object is always "0" (automatic).

## Function of status LED as "controller status display"

If a status LED is to indicate the status of a room temperature controller, the controller extension must have been activated on the parameter page "Configuration...". The status LED is then internally linked directly with the 1-byte object "Controller status" of the controller extension. This object must then be linked via a group address with the corresponding communication object of the controller.

The object "Controller status" groups eight different information units in a bit-oriented way in a byte. For this reason it is important to select in the "Status LED on with" parameter which information is to be indicated, i.e. which bit is to be evaluated.

The following can be selected...

- Bit 0: Comfort mode
- Bit 1: Standby mode
- Bit 2: Night mode
- Bit 3: Frost/heat protection
- Bit 4: Controller disabled

- Bit 5: Heating / cooling (heating = 1 / cooling = 0)
- Bit 6: Controller inactive (dead zone operation)
- Bit 7: Frost alarm

Description of bit-oriented status messages of the room temperature controller (active = ON)

Comfort-mode: is active if operating mode "Comfort" or a comfort extension or is activated.

Standby mode: Active if the "Standby" operating mode is activated.

Night mode: Active if the "Night" operating mode is activated.

Frost/heat protection: Active if the "Frost/heat protection" operating mode is activated.

Controller disabled: Active if controller disable is activated (dew point mode).

Heating/cooling: Active if heating is activated and inactive if cooling is activated. (As a rule inactive with controller disabled.)

Controller inactive: Active with the "heating and cooling" operating mode when the measured room temperature lies within the dead zone. This status information is as a rule always "0" for the individual operating modes "heating" or "cooling"! (Inactive if controller is disabled.)

Frost alarm: Active if the measured room temperature reaches or drops below + 5 °C.

#### Function of the status LEDs "Setpoint value shift indicator", "Presence status indicator" and "Inverted presence status indicator":

With these LED functions, too, the controller extension must have been activated on parameter page "Configuration..." in order for a status LED to indicate the setpoint shift or the presence status of a room temperature controller. When a setpoint shift is indicated the LED evaluates the value of the object "Controller extension - Current setpoint shift" and switches either on or off, depending on the parameter configuration in the ETS. This object must be linked via a group address with the object of the controller with the same function.

When indicating the presence status the LED evaluates the state of the object "Controller extension - Presence button" and indicates it directly (presence mode on = LED on / presence mode off = LED off). This object, too, must be linked via a group address with the same object of the controller.

- i** The communication objects "Presence button", "Current setpoint shift" and "Controller status" of the controller extension update themselves automatically after a reset, if the parameter "Value request from controller extension" on parameter page "Configuration..." is set to "Yes". Updating is effected by means of a value read telegram to the room temperature controller. The thermostat must answer the request with a value return telegram. If the push button sensor does not receive the answer, the status LED remains off (object value "0"). In this case, the object must first be actively rewritten by the bus after a reset before a status information can be indicated by the LED. This is also the case, when the "Value request from controller extension?" is set to "No".

#### Function of status LED as "comparator"

The status LED can indicate whether a parameterized reference value is greater than, equal to or less than the 1-byte object value of the status object. This comparator can be used for unsigned (0 ... 255) or for signed integers (-128 ... 127). The data format of the comparison is defined by the function of the status LED.

The status LED lights up only if the comparison is "true".

- i** After a reset or after ETS programming, the value of the LED object is always "0".

## User-defined colour setting, superimposed function and automatic colour change

The colour of the status LEDs can be adjusted. If no 3-colour individual control is configured in the parameterisation, red, green and blue can be selected from for the status LED colours in the ETS. In the colour configuration, a distinction is made between whether all of the status LEDs of the basic device or extension module have the same colour (common colour setting), or whether alternatively different colours can be configured for the LEDs (separate colour setting). The difference is as follows...

- All status LEDs have the same colour.  
If the common colour setting is desired, then the parameter "Colour of all status LEDs" on parameter page "Configuration..." must be parameterised to the settings "red", "green" or "blue". The status LEDs light up later during operation of the pushbutton sensor basic device or the extension module unchangeably in the configured colour, if they are switched on.
- The status LEDs have various colours.  
If the separate colour setting is desired, then the parameter "Colour of all status LEDs" on parameter page "Configuration..." must be parameterised to the setting "Colour selection per status LED". In this case additional parameters become visible on the parameter pages of the individual status LEDs. The parameters "Colour of the status LED" can then be used individually to define the desired colour for each status LED. The LED lights up in the configured colour if it is subsequently switched on regularly in operation, in accordance with the basic configuration "Function of the status LED".

In addition, with separate colour setting it is possible to configure a superposed function separately for each status LED. The superposed function can be used change the colour of a status LED via a communication object during operation of the device. It is also possible here to change the display function. The superposed function of a status LED is enabled when the parameter with the same name is configured to "enabled" on the corresponding parameter page.

When a superposed function is enabled, additional parameters and a communication object become visible in the ETS. It is thus possible to configure which colour the status LED should have when a superposed function is active, and which display function is then executed. The parameter "Selection of the superposed LED function" defines the display function, and thus the data format of the object. The following selections are available: "Control via separate LED object" (1-bit) or alternatively "Comparator without / with sign" (1-byte). The fundamental function of these superposed display functions is the same as the functions of the basic display of a status LED.

In accordance with the selection of the display function and the parameter configuration resulting from it, the superposed function can be switched on or off via the 1-bit or 1-byte object. The status LED will only light up in the superposed colour when a function is switched on. When a superposed function is switched off the status LED will be activated according to its basic configuration (regular colour and display function).

For the user-defined colour settings, an automatic colour change can be configured for the LED functions "Operating mode display", "Controller status", "Setpoint shift" and "Comparator". In this case, the colour of the corresponding status LED does not depend on the user specification via ETS parameter or communication object (superimposed function). Instead, the device then automatically decides which in colour the status LED should light up, based on the function value. The parameter "Status LED = ON for" indicates the colour which is set in dependence on the function value. This parameter cannot be changed.

- i** The superposed function is initially always inactive after a device reset. The superposed function is only executed when a telegram is received via the corresponding object.

- i** Regardless of the basic configuration of the status LED and the superposed function, the LEDs always flash red when a display alarm message is active. An alarm message has a higher priority and thus overrides the basic display and the superposed function. After deactivation of the alarm signalling, all LEDs will immediately return to the state corresponding to their configuration and communication objects.
- i** During colour configuration it must be ensured that different colours are configured for the basic display and the superposed function. If this is not done (the colours are the same), then when the display is static it is not possible to determine which display function is being indicated.
- i** When the superposed function is activated via a 1-bit object it is possible to have the status LED flash in the superposed colour. During flashing the status LED switches cyclically between the "switched-on" and "switched-off" states. No colour change is performed between the regular colour and the superposed colour.
- i** The configuration of user-defined colours of the status LED and the superimposed functions is only possible in the described manner when the 3-colour individual control is not parameterised (see page 62).

### **3-colour individual control with separate communication objects**

Each status LED can visualise statuses completely separately from the pushbuttons, using three separate communication objects. In this case, a 1-bit object can be configured in the ETS for each colour, whereby each status LED can be statically switched on or off via the received object value, or also activated as flashing. At the same time, the colour of the LED is predefined by the actuated object.

The colour, in which the LED should light up, depends on which of the three objects of the LED concerned last receives a value. If two or all of the three objects of a LED are associated with a group address, no receiving sequence is recognisable. In this case, it is stipulated that the sequence green -> blue -> red then applies.

For a 3-colour individual control, the telegram polarity of the LED control can be configured on the parameter page of a status LED as follows:

- 1 = LED static ON / 0 = LED static OFF
- 1 = LED static OFF / 0 = LED static ON
- 1 = LED flashes / 0 = LED static OFF
- 1 = LED static OFF / 0 = LED flashes

- i** A flashing LED always changes between the active colour and the OFF state. Flashing between several colours, e.g. red and green, is not possible.
- i** The configuration of the 3-colour individual control as described is only possible when no user-defined colour configuration has been parameterised (see page 61-62).

#### 4.2.4.4 Brightness setting for LEDs and labelling field illumination

The brightness of all status LEDs, of the operation LED and the labelling field illumination of the push-button sensor as well as the extension module can be defined in the ETS. The parameter "Brightness for all LEDs" on the parameter page "Configuration TSM" or "Configuration TSEM" can be used to set the regular illumination brightness of all LEDs in 6 levels (level 0 = OFF, level 1 = dark, ... Level 5 = bright).

Optionally the brightness can be changed during operation of the push-button sensor, controlled by a 1-bit communication object. Changing may be advisable, for example, to reduce the brightness during nighttime hours. If change-over of the brightness via the object is required, then it is necessary to set the parameter "Night reduction for reduced brightness ?" must be set to "yes". In this case the communication object "LED night reduction" becomes visible in the ETS. As soon as a "1" telegram is received via this object, the push-button sensor or the extension module redirects to the "Brightness for all LEDs during night reduction" configured in the ETS. If a "0" telegram is received via the object, the devices redirect back to the regular brightness.

The change-over of the LED brightness is always performed softly by means of a brief dimming process. Dimming up to a higher level value results in quicker dimming than with dimming to a lower level value. This results in a slow soft dimming that is pleasing for the human eye. The dimming speeds are fixed in the devices and therefore not changeable.

If any button is operated, then all active LEDs of the push-button sensor or of the extension module are switched on with the regular brightness for a duration of 30 seconds. In this manner it is possible in night operation, especially with heavily reduced brightness values or even with switched-off (level 0) LEDs, to identify status changes more easily or in any case.

- i** When night mode is activated by a button locally on the device, it should be noted that the night reduction of the LEDs is done on the affected device after 30 seconds.
- i** In the ETS it is possible to perform configuration in accordance with the possible selection of required stage values for the regular and reduced brightness. No check is made whether a reduced brightness level is configured for the reduced brightness level. This also makes it possible to use the object to switch over the object to larger brightness levels in comparison to the regular brightness. It is recommended, however, to set the brightness value for the night reduction lower than the regular brightness.
- i** After a device reset the regular brightness for switched-on LEDs is always valid. A change-over via the night reduction only takes place if the corresponding object is written by a telegram after a reset.
- i** When the status LED is activated via the regular display function or via the superposed function, it is possible to let the status LED flash. The same applies for the operation LED or the labelling field illumination. During flashing the LEDs switch synchronously between the "switched-on" and "switched-off" states in the active brightness. This is not interpreted as a change of state of the display function, by means of which the brightness is therefore also not switched over automatically.
- i** When a display alarm message is active the LEDs and the labelling field illumination of the push-button sensor and the extension module always flash with the regular brightness. The devices automatically deactivate the night reduction for the duration of the display alarm message, and track it again, when the alarm message is switched off and the object for the night reduction is still "1"-active.

#### 4.2.4.5 Scene control

The push button sensor can be used in two different ways as part of a scene control system...

- Each rocker or button can work as a scene extension. This feature makes it possible to recall or to store scenes which may be stored in other devices (see chapter 4.2.4.2.5. Scene extension function).
- The push button can independently store up to eight scenes with eight actuator groups. These internal scenes can be recalled or stored by the rockers or buttons (internal scene recall) and also by the communication object "scene extension".  
In the following subsections the internal scene function will be dealt with in greater detail.

#### Scene definition and scene recall

If the internal scenes are to be used, the parameter "Scene function" on parameter page "Scenes" must be set to "Yes". The matching data types for the eight scene outputs must then be selected and adapted to the actuator groups used. The types "Switching", "Value (0 ... 255)" or "Value / blind position (0 ... 100 %)" can be selected. The data type "Scene extension" makes it possible to implement dynamic processes by linking scenes temporally, e.g. for the lighting control in a display window.

As a rule, Venetian blinds are controlled via two scene outputs. One output controls the blind height and the other one adjusts the slat position.

The ETS offers the communication objects and the parameters of the scene commands appropriate for these data types on the following parameter pages "Scene 1" to "Scene 8".

It is possible that the values for the individual scenes preset by the parameters are modified later on with the storage function (see chapter 4.2.4.5. Scene control) when the system is in operation. If the application program is then loaded again with the ETS, these locally adapted values will normally be overwritten by the parameters. Due to the fact that it may take considerable efforts to readjust the values for all scenes in the system, the parameter "Overwrite scene values during ETS download ?" offers the possibility of retaining the scene values stored in operation without overwriting them.

The scene parameters can be set on the parameter page of each individual scene ("Scene 1 ... 8"). The setting options are the same for all 8 scenes.

These internal scenes can be recalled directly via the rockers or buttons (function "recall internal scene") and also by another bus device via the "Extension input" communication object. This 1-byte communication object supports the evaluation of up to 64 scene numbers. For this reason it must be specified which of the external scene numbers (1 ... 64) is to recall the internal scene (1 ... 8). If the same scene number is listed for several internal scenes, it is always only the first of these scenes that will be activated (scene with the lowest scene number).

In some situations there may be the requirement that a group of actuators is not controlled by all, but only by certain scenes. A classroom, for instance, may require open blinds for the "Welcome" and "Break" scenes, closed blinds in the "PC presentation" scene and no change in the "Discussion" scene. In this example, the parameter "Permit transmission ?" can be set to "No" for the "Discussion" scene. The scene output is then deactivated during the corresponding scene.



The parameter "Transmit delay" permits entering an individual waiting time for each scene output. This transmit delay can be used in different situations...

- When the actuators participating in a scene transmit status messages automatically or when several scene buttons are used to increase the number of channels within the scenes, the recall of a scene may result for a short time in high bus loading. The transmit delay helps to reduce the bus load at the time of scene recall.
- Sometimes, it is desirable that an action is started only after another action has ended. This can be for instance the illumination which is to shut off only after the blinds/shutters have been raised.

The transmit delay can be set separately for each scene output. The transmit delay defines the time delay between the individual telegrams during a scene recall. The setting specifies how much time must pass after the first scene telegram before the second is transmitted. After transmission of the second scene telegram, the configured time must again pass before the third is transmitted and so forth... The transmit delay for the first scene telegram starts immediately after the scene has been recalled.

The transmit delay between telegrams can also be deactivated (setting "0"). The telegrams are then transmitted at the shortest possible time interval. In this case, however, the order of the telegrams transmitted can deviate from the numbering of the scene outputs.

When a new scene recall (also with the same scene number) occurs during a current scene recall - even in consideration of the pertaining transmit delays - the scene processing started first will be aborted and the newly received scene number will be processed. A running scene is also aborted when a scene is being stored!

During a scene recall - even if delayed - the control surfaces of the push button sensor are operational.

### **Dynamic light control with light scenes**

With the help of a temporal linking of scenes, it is possible to implement dynamic processes, which can be put to good use e.g. for display window lighting, guidance signs or other applications. The data type "Scene extension", which can recursively call up other light scenes, serves this purpose. The precondition is that the scene output defined last is configured as "Scene extension" and connected with the object "Scenes - extension input" via a group address.

#### Examples:

- A scene calls itself up recursively, by giving the value of the scene output configured as scene extension its own scene number. The practical connection with time delays between the individual scene outputs, as needed with additional timing functions in the actuators, results in an endless loop of always the same sequence. The process ends when an internal light scene that is not in use is called up.
- Cascading scenes: the scene output configured as scene extension calls up a subsequent scene. The process ends automatically after the last scene has been called up and been executed.
- Endless loop: several scenes call each other up successively in a cascade. When the scene defined as last in the sequence calls up the first scene, an endless sequence results. The process is ended when a scene not used in the sequence is called up.

### **Storing scenes**

For each output of a scene, the user can define a corresponding scene value in the ETS which is then transmitted to the bus during a scene recall. During the regular operation of the system it may be required to adapt these preset values and to store the adapted values in the universal push-button sensor TSM. This can be ensured by the storage function of the scene control.

The value storage function for the corresponding scene number is enabled with the parameter "Permit storing ?" ("Yes") or disabled ("No"). When the storage function is disabled, the object

value of the corresponding output is not sampled during storage.

A scene storage process can be initiated in two different ways...

- by a long press on a rocker or button of a control surface configured as "scene extension"
- by a storage telegram to the extension object.

During a storage process, the push button sensor reads the current object values of the connected actuators. This is carried out by means of eight read telegrams (ValueRead) addressed to the devices in the scene which return their own value (ValueResponse) as a reaction to the request. The returned values are received by the push button sensor and taken over permanently into the scene memory. Per scene output, the push button sensor waits one second for a response. If no answer is received during this time, the value for this scene output remains unchanged and the push button sensor scans the next output.

In order to enable the push button sensor to read the object value of the actuator addressed when a scene is stored, the read flag of the corresponding actuator object must be set. This should be done only for one actuator out of an actuator group so that the value response is unequivocal.

The stored values overwrite those programmed into the push button sensor with the ETS.

The storage process will always be executed completely by the push button sensor and cannot be aborted before it has ended. Recalling scenes in the course of a storage process is not possible, the control surfaces of the push-button sensor remaining nevertheless operational.

## 4.2.4.6 Disabling function

### Configuration

With the 1-bit communication object "Button disabling", the control surfaces of the push-button sensor can be partly or completely disabled. During a disable, the rockers or buttons cannot execute any functions or can execute, temporarily, another function.

An active disable applies only to the functions of the rockers or buttons. The functions of the status LED, the scene function, temperature measurement and the alarm signalling are not affected by the disabling function.

The disabling function and the pertaining parameters and communication objects are enabled if the parameter "Disabling function ?" is set to "Yes" on the "Disabling" parameter tab.

You can parameterize the polarity of the disabling object. In case of polarity inversion (disabled = 0 / enabled = 1), the disabling function is not activated immediately after a reset or after ETS programming (object value = "0"). There must first be an object update "0" until the disabling function will be activated.

Telegram updates from "0" to "0" or from "1" to "1" on the "button disabling" object remain without effect.

The disabling function can be selected to include all or only some buttons of the basic and extension modules. If not all buttons should be blocked with the disabling function, set the parameter "Assignment of the buttons for disabling function" to "Individual buttons assigned". In this case, an additional parameter page "Disabling - button selection" is shown. For each potentially possible button (basic and extension modules), a selection can be made on this page as to whether it should correspondingly change its performance when disabling is activated (set parameter "Button..." to "Yes") or continue to execute its standard function (set parameter "Button..." to "No").

### Defining the disabling function

- On parameter page "Disabling", set the parameter "Disabling function?" on parameter page "Ax – Scenes" to "Yes".  
The communication objects "Disabling function 1...", "Disabling function 2..." and "Disable buttons - disable" are shown, as are additional parameters and parameter pages.
- Specify the polarity of the disabling object.
- Select those buttons, which should be affected by the disabling function, with the parameter "Assignment of the buttons for disabling function" and, as needed, with the parameters on the page "Button selection".

### Configuring the reaction at the beginning and end of a disable

If the disabling function is used, the reaction of the pushbutton sensor on activation and deactivation of the disabling function can be set separately in the parameterisation (parameter "Reaction of pushbutton sensor at the beginning / end of disabling"). In this connection it is irrelevant which of the control surfaces is influenced and possibly also locked by disabling. The pushbutton sensor always shows the configured behaviour.

The disabling function must have been enabled in advance.

- Set the parameter "Reaction of pushbutton sensor at the beginning / end of disabling" to "No reaction".  
The pushbutton sensor (TSM + TSEM) shows no reaction at the beginning and at the end of disabling. The sensor only adopts the state as provided for by the "Behaviour during active disabling".
- Set the parameter "Reaction of pushbutton sensor at the beginning / end of disabling" to "Internal scene recall scene 1 ...8".  
The pushbutton sensor (TSM + TSEM) recalls one of the up to 8 internal scenes. Scene storage is not possible.

- Set the parameter "Reaction of pushbutton sensor at the beginning / end of disabling" to "Reaction as button >> X << / >> Y << when pressed / released".

The pushbutton sensor (TSM + TSEM) executes the function assigned to any "target button" in non-disabled state. Target buttons are operating buttons of the pushbutton sensor on the basic device as well as on the extension module, which may be configured for rocker or for button operation. The target buttons are parameterized separately for the beginning (X) or for the end (Y) of disabling (button X / Y: button 1 to max. button 16). For this purpose, the two buttons of a rocker are considered as two separate buttons.

The action configured for the respective target button is executed. If the target button is parameterized in such a way that it has no function or does not transmit a telegram on pressing or releasing of the button, then there is also no reaction to disabling or to re-enabling. If the selected target button is part of a configured rocker, the behaviour preset for the respective rocker side will be used. The telegrams are transmitted to the bus via the required communication object of the target button.

The following table shows all possible telegram reactions of the pushbutton sensor with respect to the target button function.

Function of >>target button<<	Reaction "as >>target button<< on pressing"	Reaction "as >>target button<< on releasing"
Switching / toggling	Switching telegram	Switching telegram
Dimming	Switching telegram	No telegram
Venetian blind	Move telegram	No telegram
Scene extension	Scene recall telegram	No telegram
1-byte value transmitter	Value telegram	No telegram
2-byte value transmitter	Value telegram	No telegram
Temperature value transmitter	Temperature value telegram	No telegram
Brightness value transmitter	Brightness value telegram	No telegram
2-channel operation Channel 1: 1-bit object type	Switching telegram	No telegram
2-channel operation Channel 1: 1-byte object type	Value telegram	No telegram
2-channel operation Channel 1: 2-byte object type	Temperature value telegram	No telegram
Controller extension Operating mode switchover	Operating mode telegram	No telegram
Controller extension Motion detection	Presence telegram	No telegram
Controller extension Setpoint shift	Level value telegram	No telegram

No function	No telegram	No telegram
-------------	-------------	-------------

Telegram reactions of the pushbutton sensor with respect to the target push-button function

- Set the parameter "Reaction of pushbutton sensor at the beginning / end of disabling" to "Reaction as disabling function 1 / 2 when pressed / released".

The pushbutton sensor (TSM + TSEM) executes the function assigned to either of the two "virtual" disabling functions. The disabling functions are internal button functions with independent communication objects and independent parameters. Except for the status LED, the setting possibilities available for disabling function 1 and disabling function 2 are the same as for the buttons.

The respective configuration of the predefined disabling function will be executed. If no function or no telegram is configuration in the disabling function on pressing or releasing of a button, then there is also no reaction to disabling or to re-enabling.

Also, for this setting, Table 1 shows all possible telegram reactions of the pushbutton sensor depending on the configuration of the disabling function.

The telegrams are transmitted to the bus via the required communication object of the disabling function.

### Configuring the reaction during a disable

Irrespective of the behaviour shown by the pushbutton sensor at the beginning or at the end of disabling, the control buttons can be separately influenced during disabling.

The disabling function must have been enabled in advance.

- Set the parameter "Behaviour during active disabling" to "all buttons without function".  
In this case, the pushbutton sensor is completely disabled during disabling. Pressing a button has no effect. The status LEDs of the disabled buttons are without function (no button-press display either). Only the "Always ON" or "Always OFF" state remains unaffected by the disabling function.
- Set the parameter "Behaviour during active disabling" to "all buttons behave like". Also set the parameters "All buttons with even / odd numbers behave during disabling like" to the desired button number, configure module button number or disabling function.  
All buttons behave as defined in the parameters for the two specified reference buttons of the pushbutton sensor. For all control buttons with an even number (2, 4, 6, ...) and for all buttons with an odd number (1, 3, 5, ...) it is possible to program not only different reference buttons, but also identical reference buttons. The two "virtual" disabling functions of the push button sensor can also be configured as a reference button.  
The telegrams are transmitted to the bus via the communication objects of the specified reference buttons. The status LEDs of the reference buttons are controlled according to their function. The status LEDs of the disabled buttons are without function (no button-press display either). Only the "Always ON" or "Always OFF" state remains unaffected by the disabling function.
- Set the parameter "Behaviour during active disabling" to "Individual buttons without function". The buttons that will be disabled are defined on the parameter page "Disable - Button selection" page.  
Only the individually specified buttons are locked during disabling. The other control buttons remain unaffected by disabling. The status LEDs of the disabled buttons are without function (no button-press display either). Only the "Always ON" or "Always OFF" state remains unaffected by the disabling function.
- Set the parameter "Behaviour during active disabling" to "Individual buttons behave like". The buttons that will be disabled are defined on the parameter page "Disable - Button selection" page. Continue to configure the parameters "All assigned left / right buttons behave like" to the required button number, module button number or disabling function.

Only the individually specified buttons behave as defined in the parameters of the two specified reference buttons of the pushbutton sensor. Different or identical reference buttons can also be configured for all the right (2, 4, 6, ...) and all the left buttons (1, 3, 5, ...). The two "virtual" disabling functions of the push button sensor can also be configured as a reference button. The buttons that will be disabled are defined in the parameters on the "Disable - buttons selection" page.

The telegrams are transmitted to the bus via the communication objects of the specified reference buttons. The status LEDs of the reference buttons are controlled according to their function. The status LEDs of the disabled buttons are without function (no button-press display either). Only the "Always ON" or "Always OFF" state remains unaffected by the disabling function.

- i If a button evaluation is taking place at the time of activation / deactivation of a disabling function, this function is aborted immediately and with it also the pertaining button function. It is first necessary to release all buttons before a new button function can be executed if so permitted by the state of disabling.

#### 4.2.4.7 Controller extension

##### Connection to room temperature controller

To control a KNX room temperature controller, one controller extension in the pushbutton sensor basic module or in the extension module can be activated. The controller extension function is enabled with the parameter "Controller extension" on the "Configuration TSM" tab (or "Configuration TSEM" if an extension module is configured).

The controller extension itself is not involved in the regulating process. With it, the user can operate the single-room regulation from different places in the room. It can also be used to adjust central heating control units which are located, for instance, in a distribution box.

Typical KNX room temperature controllers generally offer different ways of influencing or visualising the room temperature control:

- Switching over between different modes of operation (e.g. "Comfort", "Night" ...) with different setpoint temperatures assigned to each mode by the thermostat.
- Signalling the presence of a person in a room. The signalling may also be combined with a configured switchover in the mode of operation.
- Readjustment of the setpoint temperature in steps which are referred in each case to the configured setpoint temperature of the current mode of operation (basic setpoint shift).

Using its buttons, the universal pushbutton sensor module allows complete control of a room temperature controller by changing the operating mode, by presetting the presence situation or by readjusting the setpoint shift (cf. the following sub-chapters). For this purpose, the buttons of the push button sensor selected as extension operation buttons must be configured for the "Controller extension" function. It should be noted that an extension operation is possible only with button configuration of one control surface and if the controller extension function has been enabled on the "Configuration..." tab. In all other cases, controller extension operating does not function.

In addition, the pushbutton sensor can – even independently of the controller extension function – indicate the state of one or more room temperature controllers with the status LED. This feature permits the indication of modes of operation or the bit-oriented evaluation of different status objects of controllers (see chapter 4.2.4.3. Status LED).

With the controller extension functions "Setpoint shift" or "Presence button", the status LEDs can also signal the state of the corresponding functions directly.

The controller extension can work properly only if all extension objects are linked with the corresponding objects of the room temperature controller (see chapter 4.2.4.3. Status LED). All button functions configured for the controller extension act on the objects belonging to the extension. Several controller extensions can also act on one main controller.

The communication objects "Operating mode selection", "Forced operating mode switchover", "Presence button", "Current setpoint shift" and "Controller status" of the controller extension update themselves automatically after a reset or after ETS programming, if the parameter "Value request from controller extension?" on parameter page "Configuration..." is set to "Yes". Updating is effected by means of a ValueRead telegram to the room temperature controller. This must answer the request with a ValueResponse telegram. If the pushbutton sensor does not receive all or some of the answers, the affected objects are initialised with "0". In this case, the objects must first be actively rewritten by the bus after a reset. This is also the case, when the "Value request from controller extension?" is set to "No".

##### Pushbutton function "Operating mode switchover" and "Forced oper. mode switchover"

Switchover of the controller operating mode can be effected in accordance with the standard function block for room temperature controllers defined in the KNX handbook with two 1-byte communication objects. The operating mode can be switched over with the normal and with the

forced objects. The "Operating mode selection" object offers a selection between the following operating modes...

- Comfort mode
- Standby mode
- Night mode
- Frost/heat protection mode

The "Forced operating mode switch over" communication object has a higher priority. It permits forced switching between the following modes of operation...

- Auto (normal operating mode switchover)
- Comfort mode
- Standby mode
- Night mode
- Frost/heat protection mode

The operating mode transmitted to the bus on a button press of the controller extension is defined by the parameter "Operating mode on pressing the button". Depending on the configured functionality, it is possible that ...

- Either one of the above-mentioned modes is activated (single selection) on the press of the button,
- Or the device is switched over between two or three modes (multiple selection).

**i** Notes on multiple selection:

In order to ensure that a change-over from one operating mode to another works properly even from different locations, the operating mode objects of the controller and those of all controller extension push button sensors must be interlinked and have their "Write" flag set. In the objects concerned, this flag is set by default

By checking the linked operating mode switchover object, the controller extension knows which of the possible operating modes is active. Based on this information, the device switches over into the next operating mode in sequence when a button is pressed. In the event that none of the possible operating modes is active, the next operating mode in the sequence is set to "Comfort" mode (in case of "Standby - >Night" to "Standby" mode). As far as switching over between the forced operating modes and "Auto" is concerned, the device switches into the "Auto" operating mode when none of the configured operating modes is active.

**i** It is not possible to program a reaction on release of the button. A long button-press is evaluated in the same way as short one and switches into the corresponding operating mode insofar as this is acceptable for the controller.

**i** If a status LED is to indicate the current operating mode, the status LED function must be programmed for "Operating mode indication" and its status object be linked with the corresponding group address for operating mode switchover with normal or high priority (see chapter 4.2.4.3. Status LED).

## Pushbutton function "Presence button"

All buttons with functions set to "Presence button" are internally linked with the object "Presence button" of the controller extension. The parameter "Presence function on pressing the button" defines the object value transmitted to the bus on pressing a button.

In order to ensure that the object value transmitted in the "Presence TOGGLE" setting is always the correct one, the presence object of the room temperature controller and the "Presence button" objects of the controller extension push button sensors must be interlinked and have their "Write" flag set. In the extension objects concerned, this flag is set by default.

It is not possible to program a reaction on release of the button. A long button-press is evaluated in the same way as short one and switches into the corresponding presence mode



insofar as this is acceptable for the controller.

The status LED of the presence button can indicate both the presence status (setting "Button function indication active / inactive") and also the actuation of the button. In addition, the usual setting possibilities of the status LED are configurable as well (see chapter 4.2.4.3. Status LED).

### **Pushbutton function "Setpoint shift"**

The setpoint shift is another available function of the controller extension. It makes use of two 1-byte communication objects with data point type 6.010 (integer with sign). This extension function allows shifting of the basic setpoint for the temperature on a room temperature controller by pressing a button. The control on the extension is as a rule the same as a control on the main controller.

A button configured as a setpoint shifting button reduces or increases the setpoint shift value on each press by one step respectively. The direction of the value adjustment is defined by the parameter "Setpoint shift on pressing the button". Releasing the button and a long press have no other functions.

### Communication with the main controller point

In order to enable the device to effect a setpoint shift in a room temperature controller, the controller must have input and output objects for setpoint shifting. In this case, the output object of the controller must be linked with the input object of the extension unit and the input object of the controller must be linked with the output object of the extension via an independent group address.

All objects are of the same data point type and have the same value range. A setpoint shift is interpreted by count values: a shift in positive direction is expressed by positive values whereas a shift in negative direction is represented by negative object values. An object value of "0" means that no setpoint shift has been activated.

Via the "Current setpoint shift" object of the controller extensions, which is linked with the room temperature controller, the extensions are enabled to determine the current setpoint shift position. Starting from the value of the communication object, each button-press on an extension will adjust the setpoint in the corresponding direction by one count value level. Each time the setpoint is adjusted, the new shift is transmitted to the room temperature controller via the "Controller extension setpoint value specification" object of the controller extension. The controller itself checks the received value for the minimum and maximum temperature limits (see controller documentation) and adjusts the new setpoint shift if the values are valid. When the new count value is accepted as valid, the controller transfers this value to its output object for setpoint shifting and retransmits the value to the extension as positive feedback.

Due to the standard data point type used as the output and input object of the controller extension and the weighting of the individual level by the controller itself, each extension unit is able to determine whether a shift took place, in which direction it took place and by how many levels the setpoint was shifted. This requires that the communication objects are connected on all controller extensions and the controller.

The information for the step value as feedback from the controller enables the extension to continue the adjustment anytime at the right point. The extension units can likewise react to a reset of the setpoint shifting function by the controller.

The status LED of a setpoint shifting button can indicate both the setpoint shifting status (setting "Setpoint value shift indicator") and also the actuation of the button. In addition, the usual setting possibilities of the status LED are configurable as well (see chapter 4.2.4.3. Status LED).

For setpoint shifting status indication, the controller makes use of the step count value which is transmitted to the extension and evaluated for switching of the status LED. The "Status LED" parameter defines the switching behaviour: The LED can be permanently off and light up only after a shift has been detected (setting "ON, ..."). As an alternative, the LED can be permanently on and go out only after a shift has been detected (setting "OFF, ..."). It can also be distinguished whether the LED is ON or OFF only if...

- there has been shifting at all
- only a positive shift has been detected,
- only a negative shift has been detected.

## 4.2.4.8 Room temperature measurement

### Temperature detection and measured value formation

The universal pushbutton sensor basic module and the pushbutton sensor extension module both contain an integrated temperature sensor. This temperature sensor can be used to measure the ambient temperature and forward it via a 2-byte object to a room temperature controller in the room. Alternatively, temperature measurement can be supplemented by means of an additional external sensor. This external temperature sensor is connected to the device via the bus by means of an additional 2-byte communication object (for example an additional pushbutton sensor or a KNX/EIB room thermostat).

To be able to use the room temperature measurement, it must have been enabled on the parameter page "Configuration TSM" (or "Configuration TSEM" for the extension module) with the parameter "Room temperature measurement". After disconnection, the parameter pages "TSM - room temperature measurement" and "TSEM - room temperature measurement" are shown. Further settings can be made on these pages.

The "Temperature detection" parameter specifies the sensors to detect the room temperature. The following settings are possible:

- "internal temperature sensor"  
The temperature sensor integrated in the push button is activated. Thus, the actual temperature value is determined only locally on the device.
- "internal and external temperature sensor"  
With this setting, the internal as well as the external temperature sensor are both active. The external sensor must either be a KNX/EIB room thermostat coupled via the 2-byte object "External temperature sensor" or another bus device with temperature detection.  
The room temperature controller can request the current temperature value cyclically. For this the parameter "Request time for external sensors..." must be set to a value > "0". The request interval can be configured within the limits of 1 minute to 255 minutes.  
When evaluating the internal and the external sensors, the real actual temperature is made up from the two measured temperature values. The weighting of the temperature values is defined by the "Creation of measuring value internal against external" parameter.  
Depending on the different locations of the sensors or a possible non-uniform heat distribution inside the room, it is thus possible to adjust the actual temperature measurement. Often, those temperature sensors that are subject to negative external influences (for example, unfavourable location because of exposure to sun or heater or door / window directly next to it) are weighted less heavily.

Example: The push button has been installed next to the entrance door (internal sensor). An additional external temperature sensor has been mounted on an inner wall in the middle of the room below the ceiling.

Internal sensor: 21.5 °C

External sensor: 22.3 °C

Determination of measured value: 30 % to 70 %

$$\rightarrow T_{\text{Result internal}} = T_{\text{internal}} \cdot 0.3 = 6.45 \text{ °C},$$

$$\rightarrow T_{\text{Result external}} = T_{\text{external}} \cdot 0.7 = 15.61 \text{ °C}$$

$$\rightarrow T_{\text{Result actual}} = T_{\text{Result internal}} + T_{\text{Result external}} = \underline{22.06 \text{ °C}}$$

### Temperature calibration of the measurement values

In some cases during room temperature measurement, it may be necessary to adjust the temperature values of the internal and the external sensor. Adjustment becomes necessary, for example, if the temperature measured by the sensors stays permanently below or above the actual temperature in the vicinity of the sensor. To determine the temperature deviation, the actual room temperature should be detected with a reference measurement using a calibrated temperature measuring device.

The parameter "Internal sensor adjustment..." and "External sensor calibration..." on the parameter page "Room temperature measurement" can be used to configure the positive (temperature increase, factors: 1 ... 127) or negative (temperature decrease, factors -128... -1) temperature calibration in levels of 0.1 K. Thus, the calibration is made only once statically and is the same for all operating modes of the controller.

- i** The measured value has to be increased, if the value measured by the sensor lies below the actual room temperature. The measured value has to be decreased, if the value measured by the sensor lies above the actual room temperature.
- i** The pushbutton sensor always transmits the calibrated temperature value to the controller. When determining the measured value using the internal and external sensor, the two adjusted values are used to calculate the actual value.

### Transmission of room temperature

The determined room temperature can be transmitted to the bus via the 2-byte object "Measured room temperature". The parameter "Transmission after room temperature change by..." on the parameter page "Room temperature control" specifies the temperature value by which the actual value has to change in order to have the actual room temperature value transmitted automatically via the object. Possible temperature value changes lie within a range of 0.1 K and 25.5 K. If "0" is selected, the automatic transmission of the room temperature.

In addition, the actual value can be transmitted periodically. The "Cyclical transmission of the room temperature" parameter determines the cycle time (1 to 255 minutes). The value "0" will deactivate the periodical transmission of the room temperature value.

Setting the "Read" flag on the "Measured room temperature" object makes it possible to read out the current actual value at any time over the bus. It has to be pointed out that with deactivated periodical transmission and deactivated automatic transmission, no more room temperature telegrams will be transmitted in case of a change.

Following the return of bus voltage or reprogramming via the ETS the object value will be updated according to the determined room temperature value and transmitted on the bus. In case a temperature value telegram has not been received from the external sensor via the object "External temperature sensor" when evaluating an external temperature sensor, only the value provided by the internal sensor will be transmitted. For this reason, the external temperature sensor should always transmit the current value after a reset.

#### 4.2.4.9 Alarm signal

The device permits signalling of an alarm which might be, for instance, a burglar or a fire alarm from a KNX central alarm unit. An alarm is signalled by synchronous flashing of all the status LEDs of the pushbutton sensor – that is, all status LEDs, the operation LED and the labelling field illumination. This alarm indication can be enabled separately with the parameter "Alarm message indication" on parameter page "Alarm message".

When alarm signalling is enabled, the ETS displays the communication object "Alarm signalling" and further alarm function parameters.

The alarm signalling object is used as an input for activating or deactivating alarm signal displaying. The polarity of the object can be selected. When the object value corresponds to the "Alarm" condition, all status LEDs, the operation LED and the labelling field illumination always flash simultaneously with a frequency of approx. 2 Hz. If there is an alarm, the basic parameterisation of the LED has no significance. The LEDs adopt their originally configured behaviour only after the alarm signalling function has been deactivated. Changes of the state of the LEDs during an alarm - if they are controlled by separate LED objects or if they signal push-button functions - are internally stored and recovered at the end of the alarm.

Apart from the possibility of deactivating an alarm signal via the alarm object, it can also be deactivated locally by a button-press on the push button sensor itself. The "Reset alarm signalling by a button-press?" parameter defines the button response during an alarm:

- If this parameter is set to "Yes", active alarm signal displaying can be deactivated by a button-press on the push button sensor. This button-press does not cause the configured function of the pressed button to be executed. Only after the next button-press will the configuration of the button be evaluated and a telegram be transmitted to the bus, if applicable.
- If "No" has been selected, alarm signalling can only be deactivated via the alarm signalling object. A button-press will always directly execute the configured button function.

If an alarm indication can be deactivated by pressing any button, the parameter "Use alarm acknowledge object?" defines whether an additional telegram for acknowledging the alarm is to be transmitted to the bus via the separate object "Acknowledge alarm message".

Such an acknowledge telegram can, for instance, be sent via a 'listening' group address to the "Alarm signalling" objects of other push button sensors in order to reset the alarm status there as well. Attention must be paid during resetting of an alarm to the selectable polarity of the acknowledge object.

- i** Notes on the polarity of the alarm object: If the setting is "Alarm when OFF and alarm reset when ON", the alarm object must be actively written by the bus with "0" to activate the alarm after a reset or after programming with the ETS.
- i** An active alarm signalling is not stored so that the alarm signalling is generally deactivated after a reset or after programming with the ETS.

#### 4.2.4.10 Energy saving mode

The device has an energy-saving mode to save electrical energy during operation. If the function is used, the device switches to the energy saving mode after a preset time without operation or switches to a separate object controlled by an external telegram (see "Activating energy saving mode"). In energy-saving mode, all the operating and display functions of the device are switched off. The status LED, operating LED and the labelling field lighting do not then have a function.

Energy-saving mode can be deactivated through an operation on the push-button basic module or using a special telegram (see "Deactivating energy-saving mode"). Afterwards, the device is fully functional again.

#### Activating energy saving mode

The device has two different activation options for switching the pushbutton sensor to the energy saving mode. These can either be combined together or used separately. Firstly, the device can be set to the energy saving mode by a group telegram via a communication object designated for this purpose. To do this, the telegram polarity that triggers the activation of the energy saving mode must be defined in the ETS.

On the other hand, there is the option of switching to energy-saving mode automatically, if, within a defined period of time, there is no operation on the push-button basic module or on the extension module. The time for this case is defined in the ETS. Each operation restarts the time until the activation of energy-saving mode.

When energy-saving mode is active, no telegram evaluations or transmissions take place via the communication objects of the device (exception: Object "TSM/TSEM - Energy-saving mode"). In consequence, no status changes can be added for operation or display functions for as long as energy-saving mode is active.

If energy-saving mode is to be activated via the communication object and an operation takes place on the device at this time, then activation of the energy-saving mode is delayed until the end of the operation. This ensures that the operating functions are still executed properly until the end and all necessary telegrams are transmitted to the bus.

Energy-saving mode is never activated when an alarm message or the programming mode is active.

- i** If no push-button extension module is connected to the basic device, then the device will always activate energy-saving mode 2.5 minutes after a reset (bus voltage return, ETS programming operation). It is irrelevant whether a push-button extension module is configured in the ETS or not. If energy-saving mode is to be activated briefly after a reset using a specification, then execution will be delayed until the named timespan has elapsed.
- i** When energy-saving mode is activated, all the LEDs of the device are switched-off by force. Display functions for status LEDs, which were active before energy-saving mode operation (e.g. status indications), are executed unchanged when energy-saving operation is deactivated. New control of the objects of the display functions must only take place afterwards, so that the status LEDs signal a current status, and possibly a different one. The device does not activate energy-saving mode for as long as an alarm function is signalled by the status LED, the operation LED and the labelling panel lighting. If the device should activate the energy saving mode during an active alarm message, the execution of the energy saving mode will be delayed until the end of the alarm message. However, the device ignores telegrams for the activation of the alarm function, providing that energy-saving mode has already been activated successfully. Thus, an object update of the alarm function during the energy saving mode will not cause the alarm function to be executed. Just as with the status signals, an alarm function, which must be activated during energy-saving mode, is not automatically continued when energy-saving operation is deactivated. Here, too, the alarm object must first be reactivated.

- i** The communication object of the energy saving mode can either be used just for activation, or alternatively just for deactivation, or if required, for the combined activation and deactivation, too. In all cases, the telegram polarity can be configured in the ETS. Only different polarities can ever be configured (e.g. "0" = mode inactive / "1" = mode active ) for the combined activation and deactivation.
- i** Any activation attempts of the energy saving mode are ignored while the programming mode of the device is active. The device saves the activation attempt and executes energy-saving mode, as soon as the programming mode is terminated. If the device is programmed by the ETS (physical address and/or application program) in an active programming mode, the device does not then execute the energy saving mode automatically at the end of the programming operation.

## Deactivating energy saving mode

The device possesses two options for deactivating energy-saving mode, which can be combined as an option. On the one hand, there is always the option of deactivating energy-saving mode automatically, as soon as the push-button basic module or the extension module is operated. On the other hand, the deactivation can additionally be carried out using a group telegram via the intended communication object. For this purpose, the telegram polarity that triggers the deactivation of the energy saving mode must be defined in the ETS. If an operation deactivates the energy saving mode, the device always executes the configured operating function immediately as well (e.g. switching, dimming, etc.).

- i** The communication object of the energy saving mode can either be used just for activation, or alternatively just for deactivation, or if required, for the combined activation and deactivation, too. In all cases, the telegram polarity can be configured in the ETS. Only different polarities can ever be configured (e.g. "0" = mode inactive / "1" = mode active ) for the combined activation and deactivation.
- i** If the transmission flag is set, on the object of the energy-saving mode, other devices can be informed of the deactivation of energy-saving mode through operation on the local device. These devices then exit energy-saving mode (precondition: all the devices are linked to the same group address and deactivation via the object must have been planned for in the parameterisation of the other devices). When energy-saving mode is deactivated with a set transmission flag, the device sends an "Energy-saving mode deactivated" telegram to the bus, according to the inverted activation telegram polarity.
- i** The device also activates energy-saving mode, even when the control surfaces are disabled. When energy-saving mode is stopped, the device reactivates the previously-active disabling function, meaning that control surfaces may also remain disabled. It is not necessary here to reactivate the disabling functions after cancelling the energy saving mode.  
Energy-saving mode (first operation) can also be deactivated using a disabled button. The configured operating functions (switching, dimming...) will not be executed thereby, however.
- i** Programming connections to the device and broadcast telegrams lead to energy-saving mode being deactivated automatically.

#### **4.2.4.11 Delivery state**

For as long as the device has not yet been programmed with application data by means of the ETS, the operation LED (colour: blue) flashes slowly (approx. 0.75 Hz) together with the labelling field illumination. When any of the buttons are pressed, the appropriate status LED lights up for the duration the button is pressed (button-press display). The colour of the status LED changes with each new press of a button.

This condition persists until the application is programmed into the device.

In addition, the device can also indicate that an incompatible application has been programmed into its memory through the ETS, by a slow flashing of the operation LED (colour: blue) and the labelling field illumination (approx. 0.75 Hz). Applications are non run-capable if they are not intended for use with the device in the ETS product database.

The operation LED and labelling field illumination flash slowly also if the application program of the pushbutton sensor has been removed from the device by the ETS.

In both cases, the pushbutton sensor is not operational.



## 4.2.5 Parameters

Description	Values	Comment
<input type="checkbox"/> General		
Transmit delay after reset or bus voltage return	Yes	After a reset (e.g. after loading of an application program or the physical address or after return of bus voltage), the pushbutton sensor can automatically transmit telegrams for the room temperature controller extension functions. In case of the controller extension, the pushbutton sensor attempts to retrieve values from the room temperature controller by means of read telegrams in order to update the object states. In case of the room temperature measurement, the pushbutton sensor transmits the current room temperature after a reset to the bus. If there are still other bus devices besides the push button sensor transmitting telegrams immediately after a reset, it may be useful to activate the transmit delay for automatically transmitting objects in order to reduce the bus load.
	No	
Pushbutton sensor extension module (TSEM) connected	Yes  No	If a pushbutton sensor extension module is connected to the basic device, it must be enabled at this point. An extension module must only be enabled if an extension module is actually connected to the basic device.
Type of pushbutton sensor extension module	<b>1-gang</b> 2-gang 3-gang 4-gang	The type of the connected pushbutton sensor extension module is specified. The associated communication objects and parameter groups in the ETS are shown corresponding to this setting.

The same functions, parameters and settings as in the pushbutton sensor basic module TSM are available for the pushbutton sensor extension module TSEM. Thus, the settings in the extension module are independent of the settings in the basic module.

Description	Values	Comment
<input type="checkbox"/> Configuration TSM		
<input type="checkbox"/> Configuration TSEM		

Controller extension	enabled	This parameter enables the communication objects and the parameter page for the room temperature controller extension. In addition, at least two buttons must execute the functions for the controller extension.
	<b>Disabled</b>	
Value request for controller extension	<b>No</b>	In order to enable the pushbutton sensor to transmit the correct values after a press on the buttons representing the controller extension, the "Operating mode selection", "Forced operating mode change-over" and "Presence button" communication objects can transmit read requests after a reset.
	Yes	<p><b>i</b> Only visible, if the parameter "Controller extension" is set to "enabled".</p>
Room temperature measurement	enabled	The push button features an integrated temperature sensor. This temperature sensor can be used to measure the ambient temperature and forward it to a room temperature controller via a 2-byte object. With the "Enabled" setting this parameter enables room temperature measurement.
	<b>Disabled</b>	
Function and colour of all status LEDs	<b>User-defined (function selection per status LED)</b>	The display concept of the status LED for the basic device is selected at this point. In the setting "User-defined", the usual LED functions are available, e.g. status display or button-press display. These also include the user-defined colour selection and the superimposed display of several functions. The settings are selected separately for each status LED on the corresponding parameter page.
	3-colour individual control via objects	Alternatively, the different colours of each status LED can be addressed via their own communication objects. The setting "3-colour individual control via objects" is valid for all the status LEDs of the basic device. Three objects are generated for the 3 colours, status LED red, status LED green and status LED blue. The object which received its value last determines the colour that the status LED lights up in. This setting causes the additional parameter "Control of the status LED via object value" to be shown on the parameter pages of the status LED.
Colour of all status LEDs	<b>red</b> green blue User-defined (colour	With a user-defined colour configuration, a distinction is made between whether all of the status LEDs have the same colour (settings "red", "green" or "blue"),

	selection per status LED)	or whether alternatively various colours can also be configured for the LEDs (setting "User-defined" (Colour selection per status LED)"). With colour selection per status LED, it is possible to set the colour on the parameter pages of the individual status LEDs. This parameter is only visible with user-defined function and colour selection.
Light period of status LED for button-press indicator	1 sec 2 sec <b>3 sec</b> 4 sec 5 sec	This parameter defines the switch-on time the status LED is lit up to indicate actuation. The setting concerns all status LEDs whose function is set to "Button-press display".
Function and colour of the operation LED	<b>user-defined</b>  3-colour individual control via objects	At this point, the display concept of the operation LED is selected. In the setting "User-defined", the colour is permanently selected and the operation LED can be statically switched on or off, addressed via an object or automatically switched off after the last operation. Alternatively, the different colours of the operation LED can be addressed via its own communication objects (setting "3-colour individual control via objects").
Colour of the operation LED	red green <b>blue</b>	The colour of the operation LED is selected at this point. This parameter is only visible with user-defined function and colour selection.
Function of operation LED	always OFF <b>always ON</b> Control via object automatic switch-off	This parameter defines the user-defined function selection of the function of the operation LED. The operation LED can be permanently on or off or alternatively be switched via a communication object. Optionally, the operation LED can be switched on by pressing any desired button and switched off again automatically after a delay time has elapsed. Here the parameter "Time for automatic switch-off" defines the delay until switch-off after the last button-press. Each button-press re-initiates the delay time. This parameter is only visible with user-defined function and colour selection.
Control via object value	<b>1 = static ON /</b> <b>0 = static OFF</b>  1 = static OFF /	If the "Function of the operation LED" is set to "Control via object" or a 3-colour control is configured, then the telegram polarity of the 1-bit objects of the

	<p>0 = static ON</p> <p>1 = flashing / 0 = static OFF</p> <p>1 = static OFF / 0 = flashing</p>	<p>operation LED can be specified at this point.</p> <p>The LED can be switched on or off statically. In addition, the received switching telegram can be evaluated in such a way that the LED flashes.</p>
Time for automatic switch-off Minutes (0...20)	0...20	If the "Function of the operation LED" is set to "Automatic switch-off", the delay before switch-off after the last button-press can be configured here. Setting the delay time minutes.
Seconds (0...59)	0...3...59	Setting the delay time seconds.
Function of the labelling field illumination	<p>always OFF</p> <p><b>always ON</b></p> <p>Control via object</p> <p>automatic switch-off</p>	<p>This parameter defines the function of the labelling field illumination. The labelling field illumination can be permanently on or off or alternatively be switched via a communication object. Optionally the labelling field illumination can be switched on by pressing any desired button and switched off again automatically after a delay time has elapsed. Here the parameter "Time for automatic switch-off" defines the delay until switch-off after the last button-press. Each button-press re-initiates the delay time.</p>
Control via object value	<p><b>1 = static ON /</b> <b>0 = static OFF</b></p> <p>1 = static OFF / 0 = static ON</p> <p>1 = flashing / 0 = static OFF</p> <p>1 = static OFF / 0 = LED flashing</p>	<p>If the "Function of the labelling field illumination" is set to "Control via object", then the telegram polarity of the 1-bit object "Labelling field illumination" can be specified at this point.</p> <p>The illumination can be switched on or off statically. In addition, the received switching telegram can be evaluated in such a way that the illumination flashes.</p>
Time for automatic switch-off Minutes (0...20)	0...20	If the "Function of the labelling field illumination" is set to "Automatic switch-off", the delay before switch-off after the last button-press can be configured here. Setting the delay time minutes.
Seconds (0...59)	0...3...59	Setting the delay time seconds.
Brightness for all LEDs	<p>Level 0 (OFF)</p> <p>Level 1 (dark)</p>	

	... <b>Level 4</b> Level 5 (bright)	The brightness level for all status LEDs, the operation LED and the labelling field illumination is defined at this point.
Night reduction for reduced LED brightness	Yes <b>No</b>	Whether the parameter and communication object for reducing the brightness for all status LEDs, the operation LED and for the labelling field illumination should be shown is defined here.
Brightness for all LEDs in night reduction	Level 0 (OFF) <b>Level 1 (dark)</b> ... Level 5 (bright)	The brightness of all status LEDs, the operation LED and the labelling field illumination is reduced to the specified level as soon as the communication object "LED night reduction" receives the value "1".  <b>i</b> There is no check of whether the reduced level has a lower value than the regular brightness level.
<p><input type="checkbox"/> TSM operation concept</p> <p><input type="checkbox"/> TSEM operation concept</p>		
Operation concept of buttons 1 and 2  (The same parameters are available for the other control surfaces / button pairs.)	<b>Rocker function (rocker 1)</b> Button function	For each respectively opposing buttons, it can be set whether they are to be used combined as a rocker switch with a common basic function or as two buttons with separate functions. Depending on this setting, the ETS displays different communication objects and parameter pages.
<p><input type="checkbox"/> TSM room temperature measurement</p> <p><input type="checkbox"/> TSEM room temperature measurement</p>		
Temperature detection through	<b>Internal temperature sensor</b>  Internal and external temperature sensor	The "Temperature detection" parameter specifies the sensors to detect the room temperature.  "Internal sensor" setting: the temperature sensor integrated in the pushbutton sensor module is activated. Thus, the actual temperature value is determined only locally on the device.  "Internal and external sensor" setting: with this setting, the internal temperature sensor is combined with a temperature sensor coupled via the 2-byte object "External temperature sensor". The weighting of the internal and external temperature value can be defined.
Determination of measured value from internal / external ratio	10% to 90% 20% to 80% 30% to 70% 40% to 60% <b>50% to 50%</b>	The weighting of the measured temperature value for the internal and external sensors is specified here. That results in an overall value, which will be used for the further interpretation of the

	60% to 40% 70% to 30% 80% to 20% 90% to 10%	room temperature. This parameter is only visible with "temperature detection = internal and external sensor".
Internal sensor calibration (-128...127) * 0.1 K	-128 ... 127, <b>0</b>	Determines the value by which the internal sensor's room temperature value is calibrated.
External sensor calibration (-128...127) * 0.1 K	-128 ... 127, <b>0</b>	Determines the value by which the external sensor's room temperature value is calibrated. This parameter is only visible when the temperature detection system requires an external sensor.
Scanning time for external sensor (0...255) * 1 min 0 = inactive	0 ... 255, <b>0</b>	The polling time for the external temperature sensor is specified here. In the "0" setting, the temperature value is not automatically polled. In this case, the communication partner (e.g. temperature sensor) must transmit its temperature value itself. This parameter is only visible when the temperature detection system requires an external sensor.
Cyclical transmission of room temperature (0...255) * 1 min; 0 = inactive	0 ... 255, <b>0</b>	This parameter specifies whether and when the determined room temperature is to be periodically output via the "Measured room temperature" object.
Transmission after room temperature change by (0...255 * +/- 0.1 K) (0 = inactive)	0 ... 255, <b>0</b>	Determines the size of the value change of the detected temperature, after which the current values are automatically transmitted on the bus via the object "Measured room temperature".
<input type="checkbox"/> Rocker switch 1, function		
Function	<b>Switching</b> Dimming Venetian blind Value transmitter 1-byte 2-byte value transmitter Scene extension 2-channel operation Manual fan control	This parameter is used to define the basic function of the rocker. Depending on this choice, the ETS displays different communication objects and parameters for this rocker.
<input type="checkbox"/> Rocker switch 1, switching		
Command on pressing left rocker	No reaction <b>ON</b> OFF TOGGLE	These parameters specify the reaction when the left rocker is pressed or released.

Command on releasing left rocker	<b>No reaction</b> ON OFF TOGGLE	
Command on pressing right rocker	No reaction ON <b>OFF</b> TOGGLE	These parameters specify the reaction when the right rocker is pressed or released.
Command on releasing right rocker	<b>No reaction</b> ON OFF TOGGLE	
 <input type="checkbox"/> Rocker switch 1, dimming		
Command on pressing left rocker	No reaction <b>Brighter (ON)</b> Darker (OFF) Brighter / darker (TOGGLE) Brighter (TOGGLE) Darker (TOGGLE)	This parameter defines the reaction when the left rocker is pressed. If the push button sensor is to toggle on a brief press, the corresponding switching objects of other sensors with the same function must be linked with one another. In the "Brighter/darker (TOGGLE)" setting, the dimming objects must be interlinked as well so that the push button sensor can send the correct telegram on the next button-press.
Command on pressing right rocker	No reaction Brighter (ON) <b>Darker (OFF)</b> Brighter / darker (TOGGLE) Brighter (TOGGLE) Darker (TOGGLE)	This parameter defines the reaction when the right rocker is pressed. If the push button sensor is to toggle on a brief press, the corresponding switching objects of other sensors with the same function must be linked with one another. In the "Brighter/darker (TOGGLE)" setting, the dimming objects must be interlinked as well so that the push button sensor can send the correct telegram on the next button-press.
Time between switching and dimming, left rocker (100 ... 50000 x 1 ms)	100 ... <b>400</b> ... 50000	This parameter defines how long the left rocker must be pressed for the push button sensor to send a dimming telegram.

Time between switching and dimming, right rocker (100 ... 50000 x 1 ms)	100 ... <b>400</b> ... 50000	This parameter defines how long the right rocker must be pressed for the push button sensor to send a dimming telegram.
Advanced parameters	Activated <b>Deactivated</b>	When the advanced parameters are activated, the ETS shows the following parameters.
Advanced parameters activated...		
Increase brightness by	1.5 % 3 % 6 % 12.5 % 25 % 50 % <b>100 %</b>	This parameter sets the relative dimming level when the brightness is increased. On each button-press, the brightness is changed at maximum by the configured step width. Especially with smaller dimming levels it is advisable for the push button sensor to repeat the dimming telegrams automatically (see "telegram repetition").
Reduce brightness by	1.5 % 3 % 6 % 12.5 % 25 % 50 % <b>100 %</b>	This parameter sets the relative dimming level when the brightness is reduced. On each button-press, the brightness is changed at maximum by the configured step width. Especially with smaller dimming levels it is advisable for the push button sensor to repeat the dimming telegrams automatically (see "telegram repetition").
Transmit stop telegram?	<b>Yes</b> No	On "Yes" the push button sensor transmits a telegram for stopping the dimming process when the rocker is released. When the push button sensor transmits telegrams for dimming in smaller levels, the stop telegram is generally not needed.
Telegram repeat?	Yes <b>No</b>	This parameter can be used to activate telegram repetition for dimming. With the button held down, the push button sensor will then transmit the relative dimming telegrams (in the programmed step width) until the button is released.
Time between two telegrams	<b>200 ms</b> 300 ms 400 ms 500 ms	This parameter defines the interval at which the dimming telegrams are automatically repeated in the telegram repetition mode.



	750 ms 1 sec 2 sec	This parameter is visible only if "Telegram repetition = Yes"!
Full-surface operation	enabled <b>Disabled</b>	When the full-surface operation is enabled, the ETS shows the following parameters.
Function for full-surface operation	<b>Switching</b>  Scene recall without store function  Scene recall with storage function	In case of full-surface operation, this parameter defines the function that is to be used. The ETS shows the corresponding communication object and the other parameters. If the push button sensor is to recall a scene with storage function by full-surface actuation, it will make a distinction between a brief press (less than 1 s), a sustained press (longer than 5 s) and an invalid button-press (between 1 s and 5 s). A brief press recalls the scene, a sustained press stores a scene and an invalid full-surface operation is ignored. This parameter is visible only if "Full-surface actuation = enabled"!
Command for full-surface operation	ON OFF <b>TOGGLE</b>	This parameter defines the value of the transmitted telegram when a full-surface operation has been sensed. "TOGGLE" changes over the current object value. This parameter is visible only if "Full-surface actuation = enabled"!
Scene number (1 ... 64)	1, 2, ..., 64	This parameter defines the scene number which is to be transmitted to the bus after a scene recall or during storage of a scene. This parameter is visible only if "Full-surface actuation = enabled"!
☐ Rocker switch 1, Venetian blind		
Command on pressing rocker	<b>Left rocker: UP / Right rocker: DOWN</b>  Left rocker: DOWN / Right rocker: UP  Left rocker: TOGGLE / Right rocker: TOGGLE	This parameter defines the running direction of a drive after a button-press. If the setting is "TOGGLE", the direction is changed after each long time command. If several push buttons are to control the same drive, the long time objects of the push buttons must be interlinked for a correct change of the running direction.

Operation concept	<p><b>short – long – short</b></p> <p>long – short</p> <p>short – long</p> <p>long – short or short</p>	For Venetian blind control, four different operation concepts can be selected. For these concepts, the ETS shows further parameters.
Time between short and long time command, left rocker (1 ... 3000 x 100 ms)	1 ... <b>4</b> ... 3000	This parameter sets the time after which the long-time operation will be evaluated on pressing the left button of the rocker. This parameter is not visible with "Operation concept = long – short"!
Time between short and long time command, right rocker (1 ... 3000 x 100 ms)	1 ... <b>4</b> ... 3000	This parameter sets the time after which the long-time operation will be evaluated on pressing the right button of the rocker. This parameter is not visible with "Operation concept = long – short"!
Slat adjusting time, left rocker (0 ... 3000 x 100 ms)	0 ... <b>5</b> ... 3000	Time during which a transmitted long time telegram can be terminated by releasing the left button of the rocker (short time). This function serves to adjust the slats of a blind. This parameter is not visible with "Operation concept = long – short"!
Slat adjusting time, right rocker (0 ... 3000 x 100 ms)	0 ... <b>5</b> ... 3000	Time during which a transmitted long time telegram can be terminated by releasing the right button of the rocker (short time). This function serves to adjust the slats of a blind. This parameter is not visible with "Operation concept = long – short"!
Full-surface operation	<p>enabled</p> <p><b>Disabled</b></p>	When the full-surface operation is enabled, the ETS shows the following parameters. Full-surface operation can only be programmed if "Operation concept = long – short or short"!
Function for full-surface operation	<p><b>Switching</b></p> <p>Scene recall without store function</p>	In case of full-surface operation, this parameter defines the function that is to be used. The ETS shows the corresponding communication object

	Scene recall with storage function	<p>and the other parameters.          If the push button sensor is to recall a scene with storage function by full-surface actuation, it will make a distinction between a brief press (less than 1 s), a sustained press (longer than 5 s) and an invalid button-press (between 1 s and 5 s). A brief press recalls the scene, a sustained press stores a scene and an invalid full-surface operation is ignored.          This parameter is visible only if "Full-surface actuation = enabled"!</p>
Command for full-surface operation	<p>ON          OFF  <b>TOGGLE</b></p>	<p>This parameter defines the value of the transmitted telegram when a full-surface operation has been sensed. "TOGGLE" changes over the current object value. This parameter is visible only if "Full-surface actuation = enabled"!</p>
Scene number (1 ... 64)	1, 2, ..., 64	<p>This parameter defines the scene number which is to be transmitted to the bus after a scene recall or during storage of a scene.          This parameter is visible only if "Full-surface actuation = enabled"!</p>
☐↔ Rocker switch 1, value transmitter, 1-byte		
Function	<p>Left rocker / right, no function</p> <p><b>Left rocker: 0...255 / Right rocker: 0...255</b></p> <p>Left rocker: 0...100 % / Right rocker: 0...100 %</p> <p>Left rocker: 0...255 / Right rocker: No function</p> <p>Left rocker: 0...100 % / Right rocker: No function</p> <p>Left rocker: No function / Right rocker: 0...255</p> <p>Left rocker: No function / Right rocker: 0...100 %</p>	<p>A rocker configured as "Value transmitter 1 byte" permits selecting whether the values to be transmitted are interpreted as integers from 0 to 255 or as a percentage from 0 % to 100 %. The following parameters and their settings depend on this distinction.</p>
Value, left rocker (0...255)	0...255	<p>This parameter defines the object value when the left rocker is pressed.          Visible only if "Function = 0...255"!</p>

Value, right rocker (0...255)	<b>0...255</b>	This parameter defines the object value when the right rocker is pressed. Visible only if "Function = 0...255"!
Value, left rocker (0...100 %)	<b>0...100</b>	This parameter defines the object value when the left rocker is pressed. Visible only if "Function = 0...100 %"!
Value, right rocker (0...100 %)	<b>0...100</b>	This parameter defines the object value when the right rocker is pressed. Visible only if "Function = 0...100 %"!
Value adjustment by long button-press	enabled <b>Disabled</b>	If value adjustment by long button-press is enabled, the ETS shows further parameters. Value adjustment begins, when the button is held down for more than 5 s. In this case, the respective status LED flashes as a sign that a new telegram has been transmitted.
Starting value in case of value adjustment	Same as configured value  Same as value after last adjustment  <b>Same as value from communication object</b>	Value adjustment can begin with different starting values. "Same as parameterised value": After each long press, the push button sensor always starts with the value configured in the ETS. "Same as value after last adjustment": After a long press, the push button sensor starts with the value transmitted by itself or by another device with this group address as the last value. "Same as value from communication object": After a long press, the push button sensor starts with the value transmitted by itself or by another device with this group address as the last value. This parameter is only visible if "Value adjustment by long button-press = enabled"!
Direction of value adjustment	Upwards  Downwards  <b>Toggling (alternating)</b>	With a long press, the push button sensor can either vary the values always in the same direction or it stores the direction of the last adjustment and reverses it on the next button-press. This parameter is only visible if "Value adjustment by long button-press = enabled"!

Step width (1...15)	1... <b>15</b>	<p>In a value adjustment, the pushbutton sensor determines the new telegram value from the previous value and the preset step width. If the value falls below the lower limit of the adjustment range (0 or 0 %) or if it exceeds the upper limit (255 or 100%), the sensor adapts the step width of the last step automatically. This parameter is only visible if "Value adjustment by long button-press = enabled"!</p>
Time between two telegrams	<b>0.5 sec</b> 1 sec 2 sec 3 sec	<p>This parameter defines the interval at which the push button sensor transmits new telegrams during a value adjustment.            This parameter is only visible if "Value adjustment by long button-press = enabled"!</p>
Value adjustment with overflow	Yes <b>No</b>	<p>If value adjustment is to be effected without overflow (setting "No") and if the pushbutton sensor reaches the lower limit of the adjustment range (0 or 0 %) or the upper limit (255 or 100 %) during value adjustment, the adjustment will be stopped automatically by the sensor. If the value adjustment with overflow is programmed (setting "Yes") and if the push button sensor reaches the lower or the upper limit, it will transmit the value of this range limit and then add a pause the duration of which corresponds to two levels. Thereafter, the push button sensor transmits a telegram with the value of the other range limit and continues the value adjustment in the same direction.</p>
<input type="checkbox"/> Rocker switch 1, value transmitter, 2-byte Function	<b>Temperature value transmitter</b>  Brightness value transmitter  Value transmitter (0...65535)	<p>A rocker configured as "Value transmitter 2 byte" permits selecting whether the values to be transmitted are to be interpreted as temperature values (0 °C to 40 °C), as brightness values (0 lux to 1500 lux) or as integers (0 to 65535). The following parameters and their settings depend on this selection.</p>
	0... <b>20</b> ...40	

Temperature value (0...40 °C) Left rocker		This parameter defines the object value when the left rocker is pressed. This is only visible if "Function = Temperature value transmitter"!
Temperature value (0...40 °C) Right rocker	0... <b>20</b> ...40	This parameter defines the object value when the right rocker is pressed. This is only visible if "Function = Temperature value transmitter"!
Brightness value Left rocker	0, 50,... <b>300</b> ...1450, 1500 lux	This parameter defines the object value when the left rocker is pressed. This is only visible if "Function = Brightness value transmitter"!
Brightness value Right rocker	0, 50,... <b>300</b> ...1450, 1500 lux	This parameter defines the object value when the right rocker is pressed. This is only visible if "Function = Brightness value transmitter"!
Value (0..65535) Left rocker	<b>0</b> ...65535	This parameter defines the object value when the left rocker is pressed. This is only visible if "Function = Value transmitter (0...65535)"!
Value (0..65535) Right rocker	<b>0</b> ...65535	This parameter defines the object value when the right rocker is pressed. This is only visible if "Function = Value transmitter (0...65535)"!
Value adjustment by long button-press	enabled <b>Disabled</b>	If value adjustment by long button-press is enabled, the ETS shows further parameters. Value adjustment begins, when the button is held down for more than 5 s. In this case, the respective status LED flashes as a sign that a new telegram has been transmitted.
Starting value in case of value adjustment	<b>Same as configured value</b>  Same as value after last adjustment  Same as value from communication object	Value adjustment can begin with different starting values. "Same as parameterised value": After each long press, the push button sensor always starts with the value configured in the ETS. "Same as value after last adjustment": After a long press, the push button sensor starts with the value transmitted by itself or by another device with this

		group address as the last value. "Same as value from communication object": After a long press, the push button sensor starts with the value transmitted by itself or by another device with this group address as the last value. This setting selectable only if "Functionality = Value transmitter (0...65535)!" This parameter is only visible if "Value adjustment by long button-press = enabled"!
Direction of value adjustment	Upwards Downwards <b>Toggling (alternating)</b>	With a long press, the push button sensor can either vary the values always in the same direction or it stores the direction of the last adjustment and reverses it on the next button-press. This parameter is only visible if "Value adjustment by long button-press = enabled"!
Step width	<b>1 °C</b>	For temperature values, the step width of the adjustment is fixed to 1°C. This parameter is only visible if "Function = Temperature value transmitter" and "Value adjustment by long button-press = enabled"!
Step width	<b>50 lux</b>	For brightness values, the step width of the adjustment is fixed to 50 lux. This parameter is only visible if "Function = Brightness value transmitter" and "Value adjustment by long button-press = enabled"!
Step width	1 2 5 10 20 50 75 100 200 500 750 <b>1000</b>	This parameter sets the step width of the value adjustment for the 2-byte value transmitter. This parameter is only visible if "Function = Value transmitter (0...65535)" and "Value adjustment by long button-press = enabled"!
Time between two telegrams	0.5 sec <b>1 sec</b>	This parameter defines the interval at which the push button sensor transmits new telegrams during a value

	2 sec 3 sec	adjustment. This parameter is only visible if "Value adjustment by long button-press = enabled"!
Value adjustment with overflow	Yes <b>No</b>	If value adjustment is to be effected without overflow (setting "No") and if the pushbutton sensor reaches the lower limit of the adjustment range (0°C, 0 lux, 0) or the upper limit (40°C, 1500 lux, 65535) during value adjustment, the adjustment will be stopped automatically by the sensor. If the value adjustment with overflow is programmed (setting "Yes") and if the push-button sensor reaches the lower or the upper limit, it will transmit the value of this range limit and then add a pause the duration of which corresponds to two levels. Thereafter, the push button sensor transmits a telegram with the value of the other range limits and continues the value adjustment in the same direction.
<p><input type="checkbox"/> Rocker switch 1, scene extension</p>		
Function	<p><b>Scene extension without storage function</b></p> <p>Scene extension with storage function</p> <p>Recall of internal scene extension without storage function</p> <p>Recall of internal scene with storage function</p>	<p>This parameter defines the functionality of the extension.</p> <p>If the push button sensor is used as a scene extension, the scenes can either be stored in one or in several other KNX devices (e.g. light scene push button sensor).</p> <p>During a scene recall or in a storage function, the push button sensor transmits a telegram with the respective scene number via the extension object of the rocker.</p> <p>During the recall of an internal scene, a scene stored internally in the push button sensor is recalled or stored again. In this case, the sensor transmits no telegram to the bus via a scene extension object. For this setting, the internal scene function must be enabled.</p>
Scene number (1 ... 64) Left rocker	1...64	In accordance with the KNX standard, objects with data type 18.001 "Scene Control" can recall or store up to 64 scenes by their numbers. The parameter defines the scene number to be transmitted when a left button is pressed.



<p>Scene number (1 ... 64) Right rocker</p>	<p>1...64</p>	<p>In accordance with the KNX standard, objects with data type 18.001 "Scene Control" can recall or store up to 64 scenes by their numbers. The parameter defines the scene number to be transmitted when a right button is pressed.</p>
<p>Scene number (1 ... 8) Left rocker</p>	<p>1...8</p>	<p>This parameter defines the number of the internal scene which is recalled or stored when a left button is pressed.</p>
<p>Scene number (1 ... 8) Right rocker</p>	<p>1...8</p>	<p>This parameter defines the number of the internal scene which is recalled or stored when a right button is pressed.</p>
<p>☐⇩ Rocker switch 1, 2-channel operation</p>		
<p>Operation concept</p>	<p><b>Channel 1 or channel 2</b>  Channel 1 and channel 2</p>	<p>This parameter defines the 2-channel operation concept. If the setting "Channel 1 or channel 2" is selected, the push button sensor decides dependent on the button-press duration which of the channels will be used. If the setting "Channel 1 and channel 2" is selected, the push button sensor transmits only the telegram of channel 1 on a short button-press and both telegrams on a sustained button-press.</p>
<p>Function channel 1 (2)</p>	<p>No function <b>Switching (1 bit)</b> Value transmitter 0 ... 255 (1-byte) Value transmitter 0 ... 100 % (1-byte) Temperature value transmitter (2 bytes)</p>	<p>This parameter defines the channel function and specifies which other parameters and which communication object are to be displayed for channel 1 (2).</p>
<p>Command of button for channel 1 (2) Left rocker</p>	<p><b>ON</b> <b>OFF</b> <b>TOGGLE</b></p>	<p>This parameter defines the object value transmitted to the bus, when the left-hand rocker is pressed. This is only visible if "Function channel 1 (2) = Switching (1 bit)"!</p>
		<p>This parameter defines the object value transmitted to the bus, when the right-</p>

Command of button for channel 1 (2) Right rocker	ON <b>OFF</b> TOGGLE	hand rocker is pressed. This is only visible if "Function channel 1 (2) = Switching (1 bit)"!
Value of the button for Channel 1 (2) Left rocker (0...255)	0...255	This parameter defines the object value transmitted to the bus, when the left-hand rocker is pressed. It is only visible if "Function channel 1 (2) = Value transmitter 0...255 (1 byte)"!
Value of the button for Channel 1 (2) Right rocker (0...255)	0...255	This parameter defines the object value transmitted to the bus, when the right-hand rocker is pressed. It is only visible if "Function channel 1 (2) = Value transmitter 0...255 (1 byte)"!
Value of the button for Channel 1 (2) Left rocker (0 ... 100 %)	0...100	This parameter defines the object value transmitted to the bus, when the left-hand rocker is pressed. It is only visible if "Function channel 1 (2) = Value transmitter 0...100 % (1-byte)"!
Value of the button for Channel 1 (2) Right rocker (0 ... 100 %)	0...100	This parameter defines the object value transmitted to the bus, when the right-hand rocker is pressed. It is only visible if "Function channel 1 (2) = Value transmitter 0...100 % (1-byte)"!
Temperature value of the button for channel 1 (2) Left rocker (0 ... 40 °C)	0...40	This parameter defines the temperature value transmitted to the bus when the left-hand rocker is pressed. It is only visible if "Function channel 1 (2) = Temperature value transmitter (2 bytes)"!
Temperature value of the button for channel 1 (2) Right rocker (0 ... 40 °C)	0...40	This parameter defines the temperature value transmitted to the bus when the right-hand rocker is pressed. It is only visible if "Function channel 1 (2) = Temperature value transmitter (2 bytes)"!
Time between channel 1 and channel 2 Left rocker (1 ... 255 x 100 ms)	0... <b>30</b> ...255	Depending on the selected operation concept, this parameter defines the interval at which the push button transmits the telegram for channel 1 and the telegram for channel 2 when the left

		side of the rocker is pressed.
Time between channel 1 and channel 2 Right rocker (1 ... 255 x 100 ms)	0... <b>30</b> ...255	Depending on the selected operation concept, this parameter defines the interval at which the push button transmits the telegram for channel 1 and the telegram for channel 2 when the right side of the rocker is pressed.
Full-surface operation	enabled <b>Disabled</b>	When the full-surface operation is enabled, the ETS shows the following parameters. Full-surface operation can only be programmed if "Operation concept = Channel 1 or channel 2"!
Function for full-surface operation	<b>Switching</b> Scene recall without store function  Scene recall with storage function	In case of full-surface operation, this parameter defines the function that is to be used. The ETS shows the corresponding communication object and the other parameters. If the push button sensor is to recall a scene with storage function by full-surface actuation, it will make a distinction between a brief press (less than 1 s), a sustained press (longer than 5 s) and an invalid button-press (between 1 s and 5 s). A brief press recalls the scene, a sustained press stores a scene and an invalid full-surface operation is ignored. This parameter is visible only if "Full-surface actuation = enabled"!
Command for full-surface operation	ON OFF <b>TOGGLE</b>	This parameter defines the value of the transmitted telegram when a full-surface operation has been sensed. "TOGGLE" changes over the current object value. This parameter is visible only if "Full-surface actuation = enabled"!
Scene number (1 ... 64)	<b>1, 2, ..., 64</b>	This parameter defines the scene number which is to be transmitted to the bus after a scene recall or during storage of a scene. This parameter is visible only if "Full-surface actuation = enabled"!

Rockers 2 ... max. 4 see Rocker 1!

Button 1, function

Function	No function <b>Switching</b> Dimming Venetian blind Value transmitter 1-byte 2-byte value transmitter Scene extension 2-channel operation Controller extension	This parameter defines the basic function of the button. Depending on this setting, the ETS displays different communication objects and parameters for this button.
<input type="checkbox"/> Button 1, switching		
Command on pressing the button	No reaction ON OFF <b>TOGGLE</b>	These parameters specify the reaction when the button is pressed or released.
Command on releasing the button	<b>No reaction</b> ON OFF TOGGLE	
<input type="checkbox"/> Button 1, dimming		
Command on pressing the button	Brighter (ON) Darker (OFF) <b>Brighter / darker (TOGGLE)</b> Brighter (TOGGLE) Darker (TOGGLE)	This parameter defines the reaction when the button is pressed. If the push button sensor is to toggle on a brief press, the corresponding switching objects of other sensors with the same function must be linked with one another. In the "Brighter/darker (TOGGLE)" setting, the dimming objects must be interlinked as well so that the push button sensor can send the correct telegram on the next button-press.
Time between switching and dimming (100 ... 50000 x 1 ms)	100 ... <b>400</b> ... 50000	This parameter defines how long the button must be pressed for the push button sensor to transmit a dimming telegram.
Advanced parameters	Activated <b>Deactivated</b>	When the advanced parameters are activated, the ETS shows the following parameters.
Advanced parameters activated...		
Increase brightness by	1.5 % 3 % 6 % 12.5 % 25 % 50 % <b>100 %</b>	This parameter sets the relative dimming level when the brightness is increased. On each button-press, the brightness is changed at maximum by the configured step width. Especially with smaller dimming levels it is advisable for the push button sensor

		to repeat the dimming telegrams automatically (see "telegram repetition").
Reduce brightness by	1.5 % 3 % 6 % 12.5 % 25 % 50 % <b>100 %</b>	This parameter sets the relative dimming level when the brightness is reduced. On each button-press, the brightness is changed at maximum by the configured step width. Especially with smaller dimming levels it is advisable for the push button sensor to repeat the dimming telegrams automatically (see "telegram repetition").
Transmit stop telegram?	<b>Yes</b> No	On "Yes" the push button sensor transmits a telegram for stopping the dimming process when the rocker is released. When the push button sensor transmits telegrams for dimming in smaller levels, the stop telegram is generally not needed.
Telegram repeat?	Yes <b>No</b>	This parameter can be used to activate telegram repetition for dimming. With the button held down, the push button sensor will then transmit the relative dimming telegrams (in the programmed step width) until the button is released.
Time between two telegrams	<b>200 ms</b> 300 ms 400 ms 500 ms 750 ms 1 sec 2 sec	This parameter defines the interval at which the dimming telegrams are automatically repeated in the telegram repetition mode. This parameter is visible only if "Telegram repetition = Yes"!
<input type="checkbox"/> Button 1, Venetian blind		
Command on pressing the button	DOWN UP <b>TOGGLE</b>	This parameter defines the running direction of a drive after a button-press. If the setting is "TOGGLE", the direction is changed after each long time command. If several push buttons are to control the same drive, the long time objects of the push buttons must be interlinked for a correct change of the running direction.
Operation concept	<b>short – long – short</b>	For Venetian blind control, four different operation concepts can be selected. For

	long – short short – long long – short or short	these concepts, the ETS shows further parameters.
Time between short-time and long-time command (1 ... 3000 x 100 ms)	1 ... <b>4</b> ... 3000	This parameter sets the time after which the long-time operation will be evaluated on pressing the left button of the rocker. This parameter is not visible with "Operation concept = long – short"!
Slat adjusting time (0 ... 3000 x 100 ms)	0 ... <b>5</b> ... 3000	Time during which a transmitted long time telegram can be terminated by releasing the left button of the rocker (short time). This function serves to adjust the slats of a blind. This parameter is not visible with "Operation concept = long – short"!
<p>□⇩ Button 1, value transmitter, 1-byte</p> <p>Function                      <b>Value transmitter 0...255</b> Value transmitter 0...100 %</p> <p>A button configured as "Value transmitter 1 byte" permits selecting whether the values to be transmitted are interpreted as integers from 0 to 255 or as a percentage from 0 % to 100 %. The following parameters and their settings depend on this distinction.</p>		
Value (0...255)	<b>0</b> ...255	This parameter defines the object value when the button is pressed. Visible only if "Function = 0...255"!
Value (0...100 %)	<b>0</b> ...100	This parameter defines the object value when the button is pressed. Visible only if "Function = 0...100 %"!
Value adjustment by long button-press	enabled <b>Disabled</b>	If value adjustment by long button-press is enabled, the ETS shows further parameters. Value adjustment begins, when the button is held down for more than 5 s. In this case, the respective status LED flashes as a sign that a new telegram has been transmitted.
Starting value in case of value adjustment	Same as configured value Same as value after last	Value adjustment can begin with different starting values. "Same as parameterised value": After

	<p>adjustment</p> <p><b>Same as value from communication object</b></p>	<p>each long press, the push button sensor always starts with the value configured in the ETS.</p> <p>"Same as value after last adjustment": After a long press, the push button sensor starts with the value transmitted by itself or by another device with this group address as the last value.</p> <p>"Same as value from communication object": After a long press, the push button sensor starts with the value transmitted by itself or by another device with this group address as the last value.</p> <p>This parameter is only visible if "Value adjustment by long button-press = enabled"!</p>
<p>Direction of value adjustment</p>	<p>Upwards</p> <p>Downwards</p> <p><b>Toggling (alternating)</b></p>	<p>With a long press, the push button sensor can either vary the values always in the same direction or it stores the direction of the last adjustment and reverses it on the next button-press. This parameter is only visible if "Value adjustment by long button-press = enabled"!</p>
<p>Step width (1...15)</p>	<p>1...<b>15</b></p>	<p>In a value adjustment, the pushbutton sensor determines the new telegram value from the previous value and the preset step width. If the value falls below the lower limit of the adjustment range (0 or 0 %) or if it exceeds the upper limit (255 or 100%), the sensor adapts the step width of the last step automatically. This parameter is only visible if "Value adjustment by long button-press = enabled"!</p>
<p>Time between two telegrams</p>	<p><b>0.5 sec</b></p> <p>1 sec</p> <p>2 sec</p> <p>3 sec</p>	<p>This parameter defines the interval at which the push button sensor transmits new telegrams during a value adjustment. This parameter is only visible if "Value adjustment by long button-press = enabled"!</p>
<p>Value adjustment with overflow</p>	<p>Yes</p> <p><b>No</b></p>	<p>If value adjustment is to be effected without overflow (setting "No") and if the pushbutton sensor reaches the lower limit of the adjustment range (0 or 0 %) or the upper limit (255 or 100 %) during value adjustment, the adjustment will be stopped automatically by the sensor.</p>

If the value adjustment with overflow is programmed (setting "Yes") and if the push button sensor reaches the lower or the upper limit, it will transmit the value of this range limit and then add a pause the duration of which corresponds to two levels. Thereafter, the push button sensor transmits a telegram with the value of the other range limit and continues the value adjustment in the same direction.

□-| Button 1, value transmitter, 2-byte

Function	<b>Temperature value transmitter</b>	A button configured as "Value transmitter 2 byte" permits selecting whether the values to be transmitted are to be interpreted as temperature values (0 °C to 40 °C), as brightness values (0 lux to 1500 lux) or as integers (0 to 65535). The following parameters and their settings depend on this selection.
	Brightness value transmitter	
	Value transmitter (0...65535)	
Temperature value (0...40 °C)	0... <b>20</b> ...40	This parameter defines the object value when the button is pressed. This is only visible if "Function = Temperature value transmitter"!
Brightness value	0, 50,... <b>300</b> ...1450, 1500 lux	This parameter defines the object value when the button is pressed. This is only visible if "Function = Brightness value transmitter"!
Value (0...65535)	<b>0</b> ...65535	This parameter defines the object value when the button is pressed. This is only visible if "Function = Value transmitter (0...65535)"!
Value adjustment by long button-press	enabled <b>Disabled</b>	If value adjustment by long button-press is enabled, the ETS shows further parameters. Value adjustment begins, when the button is held down for more than 5 s. In this case, the respective status LED flashes as a sign that a new telegram has been transmitted.
Starting value in case of value adjustment	<b>Same as configured value</b> Same as value after last	Value adjustment can begin with different starting values. "Same as parameterised value": After



	adjustment	each long press, the push button sensor always starts with the value configured in the ETS. "Same as value after last adjustment": After a long press, the push button sensor starts with the value transmitted by itself or by another device with this group address as the last value. "Same as value from communication object": After a long press, the push button sensor starts with the value transmitted by itself or by another device with this group address as the last value. This setting selectable only if "Function = Value transmitter (0...65535)"! This parameter is only visible if "Value adjustment by long button-press = enabled"!
	Same as value from communication object	
Direction of value adjustment	Upwards Downwards <b>Toggleing (alternating)</b>	With a long press, the push button sensor can either vary the values always in the same direction or it stores the direction of the last adjustment and reverses it on the next button-press. This parameter is only visible if "Value adjustment by long button-press = enabled"!
Step width	<b>1 °C</b>	For temperature values, the step width of the adjustment is fixed to 1°C. This parameter is only visible if "Function = Temperature value transmitter" and "Value adjustment by long button-press = enabled"!
Step width	<b>50 lux</b>	For brightness values, the step width of the adjustment is fixed to 50 lux. This parameter is only visible if "Function = Brightness value transmitter" and "Value adjustment by long button-press = enabled"!
Step width	1 2 5 10 20 50 75 100 200 500 750	This parameter sets the step width of the value adjustment for the 2-byte value transmitter. This parameter is only visible if "Function = Temperature value transmitter" and "Value adjustment by long button-press = enabled"!

**1000**

Time between two telegrams	0.5 sec <b>1 sec</b> 2 sec 3 sec	This parameter defines the interval at which the push button sensor transmits new telegrams during a value adjustment. This parameter is only visible if "Value adjustment by long button-press = enabled"!
Value adjustment with overflow	Yes <b>No</b>	If value adjustment is to be effected without overflow (setting "No") and if the pushbutton sensor reaches the lower limit of the adjustment range (0°C, 0 lux, 0) or the upper limit (40°C, 1500 lux, 65535) during value adjustment, the adjustment will be stopped automatically by the sensor. If the value adjustment with overflow is programmed (setting "Yes") and if the push-button sensor reaches the lower or the upper limit, it will transmit the value of this range limit and then add a pause the duration of which corresponds to two levels. Thereafter, the push button sensor transmits a telegram with the value of the other range limits and continues the value adjustment in the same direction.
<input type="checkbox"/> Button 1, scene extension		
Function	<p><b>Scene extension without storage function</b></p> <p>Scene extension with storage function</p> <p>Recall of internal scene extension without storage function</p> <p>Recall of internal scene with storage function</p>	<p>This parameter defines the functionality of the extension.</p> <p>If the push button sensor is used as a scene extension, the scenes can either be stored in one or in several other KNX devices (e.g. light scene push button sensor). During a scene recall or in a storage function, the push button sensor transmits a telegram with the respective scene number via the extension object of the button.</p> <p>During the recall of an internal scene, a scene stored internally in the push button sensor is recalled or stored again. In this case, the sensor transmits no telegram to the bus via a scene extension object. For this setting, the internal scene function must be enabled.</p>
Scene number (1 ... 64)	1...64	In accordance with the KNX standard, objects with data type 18.001 "Scene

		Control" can recall or store up to 64 scenes by their numbers. The parameter defines the scene number to be transmitted when the button is pressed.
Scene number (1 ... 8)	1...8	This parameter defines the number of the internal scene which is recalled or stored when a button is pressed.
<p><input type="checkbox"/> Button 1, 2-channel operation</p>		
Operation concept	<b>Channel 1 or channel 2</b> Channel 1 and channel 2	This parameter defines the 2-channel operation concept. If the setting "Channel 1 or channel 2" is selected, the push button sensor decides dependent on the button-press duration which of the channels will be used. If the setting "Channel 1 and channel 2" is selected, the push button sensor transmits only the telegram of channel 1 on a short button-press and both telegrams on a sustained button-press.
Function channel 1 (2)	No function <b>Switching (1 bit)</b> Value transmitter 0 ... 255 (1-byte) Value transmitter 0 ... 100 % (1-byte) Temperature value transmitter (2 bytes)	This parameter defines the channel function and specifies which other parameters and which communication object are to be displayed for channel 1 (2).
Command of button for channel 1 (2)	ON OFF <b>TOGGLE</b>	This parameter defines the object value transmitted to the bus when the button is pressed. This is only visible if "Function channel 1 (2) = Switching (1 bit)"!
Value of the button for Channel 1 (2) (0 ... 255)	0...255	This parameter defines the object value transmitted to the bus when the button is pressed. It is only visible if "Function channel 1 (2) = Value transmitter 0...255 (1 byte)"!
Value of the button for Channel 1 (2) (0 ... 100 %)	0...100	This parameter defines the object value transmitted to the bus when the button is pressed. It is only visible if "Function channel 1 (2) = Value transmitter 0...100 % (1 byte)"!

<p>Temperature value of the button for channel 1 (2) (0 ... 40 °C)</p>	<p>0...<b>20</b>...40</p>	<p>This parameter defines the temperature value transmitted to the bus when the button is pressed. It is only visible if "Function channel 1 (2) = Temperature value transmitter (2 bytes)"!</p>
<p>Time between channel 1 and channel 2 (1 ... 255 x 100 ms)</p>	<p>0...<b>30</b>...255</p>	<p>Depending on the selected operation concept, this parameter defines the interval at which the push button transmits the telegram for channel 1 and the telegram for channel 2 when the button is pressed.</p>
<p>☐ Button 1, controller extension</p>		
<p>Function</p>	<p><b>Operating mode switch-over</b></p> <p>Forced oper. mode switchover</p> <p>Presence button</p> <p>Setpoint shift</p>	<p>A controller extension can optionally switch over the operating mode with normal or high priority, change the presence state or change the current room temperature value. With regard to the setting of this parameter, the ETS shows further parameters.</p>
<p>Operating mode when the following button is pressed</p>	<p><b>Comfort mode</b></p> <p>Standby mode</p> <p>Night mode</p> <p>Frost/heat protection mode</p> <p>Comfort mode -&gt; Standby mode -&gt;</p> <p>Comfort mode -&gt; Night mode -&gt;</p> <p>Standby mode -&gt; Night mode -&gt;</p> <p>Comfort mode -&gt; Standby mode -&gt; Night mode -&gt;</p>	<p>If the controller extension is to change over the operating mode of the connected room temperature controller with normal priority, the extension can – when operated – either switch on a defined operating mode or change over between different operating modes.</p> <p>In order for this change to work properly, the controller extension should request the current state of the extension objects after a reset or after re-programming (set parameter under "General" to "Value request from controller extension = Yes"). This parameter is only visible if "Function = operating mode switchover"!</p>
<p>Forced operating mode when the following button is pressed</p>	<p>Auto (Normal operating mode change-over)</p> <p><b>Comfort mode</b></p>	<p>If the controller extension is to change over the operating mode of the connected room temperature controller with high priority, the extension can – when actuated – either enable the</p>

	Standby mode	change-over with normal priority (auto), switch on a defined operating mode with a high priority or change over between different operating modes.
	Night mode	
	Frost/heat protection mode	In order for this change to work properly, the controller extension should request the current state of the extension objects after a reset or after re-programming (set parameter under "General" to "Value request from controller extension = Yes").
	Comfort mode -> Standby mode ->	"Value request from controller extension = Yes").
	Comfort mode -> Night mode ->	This parameter is only visible if "Function = forced operating mode switchover"!
	Standby mode -> Night mode ->	
	Comfort mode -> Standby mode -> Night mode ->	
	Auto -> Comfort mode ->	
	Auto -> Standby mode ->	
	Auto -> Night mode ->	
	Auto -> Frost/heat protection mode ->	
Presence function when the following button is pressed	Presence OFF <b>Presence ON</b> Presence TOGGLE	When a button is pressed, the controller extension can switch on or switch off the presence state of the connected room temperature controller in a defined way or the extension can change over between the two states ("Presence TOGGLE"). In order for this change-over to work properly, the controller extension should request the current state of the extension objects after a reset or after re-programming (set parameter under "General" to "Value request from controller extension? = Yes"). This parameter is only visible if "Function = presence button"!
Setpoint shift on pressing the button	Reduce setpoint value (level size) <b>Increase setpoint (level size)</b>	This parameter defines the direction of the setpoint shift on the extension. For a setpoint value shift, the controller extension makes use of the two communication objects "Setpoint shift specification" and "Current setpoint shift".

The "Current setpoint shift" communication object informs the extension about the current state of the connected room temperature controller. Based on this value and the respective parameter, the controller extension determines the new level size which it transmits via the "Setpoint shift specification" communication object to the room temperature controller. This parameter is only visible if "Function = Setpoint shift"!

☐↵ Buttons 2 ... max. 8 see Button 1!

☐↵ TSM W1 status LED

☐↵ TSM T1 status LED

Function of left / right status LED      always OFF

Irrespective of the pushbutton or rocker function, the status LED is switched off permanently.

always ON

Irrespective of the pushbutton or rocker function, the status LED is switched on permanently.

Button-press display

The status LED indicates a button actuation. The ON time is set on the parameter page "General" in common for all status LEDs that are configured as actuation displays.

Telegram acknowledgment

The status LED indicates the transmission of a telegram in 2-channel operation. This setting can only be configured for the push button or rocker function "2-channel operation".

Status display (switching object)

The status LED indicates the state of the communication object "Switching". If the object value is "ON", the status LED is illuminated. If the object value is "OFF" the status LED is switched off. This setting can only be configured for the push button or rocker function "Switching" or "Dimming".

Inverted status display (switching object)

The status LED indicates the state of the communication object "Switching". If the object value is "OFF", the status LED is illuminated. If the object value is "ON" the status LED is switched off. This setting can only be configured for the push button or rocker function "Switching" or "Dimming".

Control via separate LED object

The status LED indicates the state of its own, separate 1-bit LED object. This setting causes the additional parameter

	"Control of the status LED via object value" to be shown.
Operating mode display (KNX controller)	The status LED indicates the state of a KNX room temperature controller via a separate 1-byte communication object. This setting causes the additional parameter "Status LED ON with" to be shown.
Controller status indication (activate controller extension!)	The status LED indicates the state of the controller extension. This setting causes the additional parameter "Status LED ON with" to be shown.
Setpoint value shift display	The status LED indicates the state of a setpoint shift in case of controller extension operation. This setting causes the additional parameter "Status LED" to be shown. This setting can only be configured in the pushbutton function "Controller extension" and with the button function "Setpoint shift".
Presence status	The status LED indicates the state of the presence button in case of controller extension operation. The LED lights up if the presence function is activated. The LED is off if the presence function is inactive. This setting can only be configured in the pushbutton function "Controller extension" and with the button function "Presence button".
Inverted presence status	The status LED indicates the state of the presence button in case of controller extension operation. The LED lights up if the presence function is inactive. The LED is off if the presence function is activated. This setting can only be configured in the pushbutton function "Controller extension" and with the button function "Presence button".
Comparator without sign (1-byte)	The status LED is activated depending on a comparison. In this configuration there is a separate 1-byte communication object available via which the unsigned reference value (0...255) is received. This setting causes the additional parameter "Status LED ON with" to be shown.
Comparator with sign (1-byte)	The status LED is activated depending on a comparison. In this configuration there is a separate 1-byte communication object available via which the positive or negative reference value (-128...127) is received. This setting causes the additional parameter

"Status LED ON with" to be shown.

The display parameters "Possible LED functions" on the parameter pages of the status LEDs show the specific LED functions that can be configured. If LED functions other than the possible ones are configured, the affected status LEDs will not have any function during subsequent operation of the push button sensor (always OFF).

The function of the status LED = "Display via separate LED object"...

Control of the status LED via object value

**1 = LED static ON /**  
**0 = LED static OFF**

1 = LED static OFF /  
0 = LED static ON

1 = LED flashes /  
0 = LED static OFF

1 = LED static OFF /  
0 = LED flashes

If the "Function of status LED ..." is set to "Control via separate LED object", then the telegram polarity of the 1-bit object "Status LED" can be specified at this point.

The LED can be switched on or off statically. In addition, the received switching telegram can be evaluated in such a way that the LED flashes.

If the function of status LED = "Operating mode display (KNX controller)"...

Status LED ON with

Automatic mode  
**Comfort mode**  
Standby mode  
Night mode  
Frost/heat protection mode

The values of a communication object with data type 20.102 "HVAC Mode" are defined as follows:

0 = Automatic  
1 = Comfort  
2 = Standby  
3 = Night  
4 = Frost/heat protection

The value "Automatic" is used only by the "forced operating mode switchover" objects.

The status LED is illuminated when the object receives the value configured here.

The function of the status LED = "Controller status indication"...



Status LED ON with **Comfort mode**  
 Standby mode  
 Night mode  
 Frost/heat protection mode  
 Controller disabled  
 Heating / cooling  
 Controller inactive  
 (deadband operation)  
 Frost alarm

The "Controller status" communication object of the controller extension function includes eight bits of information in one byte. This parameter defines which bit is to be indicated by the LED.  
 The controller status can be indicated only if the controller extension is enabled (parameter page "General")!

If the function of status LED = "Comparator without sign"...

Status LED ON with **Reference value greater than received value**  
 Reference value less than received value  
 Reference value equal to received value

The status LED indicates whether the configured reference value is greater or less than or equal to the value of the "Status LED" object".

Reference value (0 ... 255) **0...255**

This parameter defines the reference value to which the value of the "Status LED" object is compared.

If the function of status LED = "Comparator with sign"...

Status LED ON with **Reference value greater than received value**  
 Reference value less than received value  
 Reference value equal to received value

The status LED indicates whether the configured reference value is greater or less than or equal to the value of the "Status LED" object".

Reference value (-128 ... 127) **-128...0...127**

This parameter defines the reference value to which the value of the "Status LED" object is compared.

With user-defined function and colour configuration and "Colour of all status LEDs" = "Colour selection per status LED"...

Automatic colour change of the status LED	Yes <b>No</b>	When user-defined colour settings are used, an automatic colour change can be configured here for the LED functions "Operating mode display", "Controller status", "Setpoint shift" and "Comparator". If the function has been enabled (setting YES), the colour of the corresponding status LED does not depend on the user specification via ETS parameter or communication object (superimposed function). Instead, the device then automatically decides which in colour the status LED should light up, based on the function value. With the setting "No", the colour of the status LED, and optionally a superimposed function, can be configured.
Status LED ON for" / "Status-LED"	Setting depends on the LED function / read-only	The parameter "Status LED ON for" or "Status LED" indicates the colour which is set for an automatic colour change, depending on the function value. This parameter is only visible for an automatic colour change and cannot be changed.
Colour of the status LED	<b>red</b> green blue	If separate colour settings for the status LEDs are required, then this parameter can be used individually to define the desired colour for each status LED. The LED lights up in the configured colour if it is subsequently switched on regularly in operation of the push button sensor in accordance with the basic configuration "Function of the status LED". This parameter is only visible if the parameter "Colour selection of all status LEDs" on parameter page "General" is set to "Colour selection per rocker switch/button". This parameter is only visible when no automatic colour change is configured.
Superposed function	enabled <b>Disabled</b>	With separate colour setting it is additionally possible to configure a superposed function separately for each status LED. The superposed function can be used change the colour of a status LED via a communication object during operation of the device. It is also possible here to change the display function. The superposed function of a status LED is enabled when this parameter is configured to "enabled". This parameter is only visible when no

		automatic colour change is configured.
Colour of the status LED for superposed function	red <b>green</b> blue	If the superposed function is enabled, this parameter can be used to define the desired superposed colour. The LED lights up in the configured colour if the superposed function is later activated in operation of the push button sensor. This parameter is only visible if the parameter "Superposed function" is set to "enabled".
Selection of the superposed LED function	Control via separate LED object	With the superposed function the status LED indicates the state of a separate 1-bit LED object. This setting causes the additional parameter "Control of the status LED via object value" to be shown.
	Comparator without sign (1-byte)	In the superposed function the status LED is activated depending on a comparison. In this configuration there is a separate 1-byte communication object available via which the unsigned reference value (0...255) is received. This setting causes the additional parameter "Superposed function ON with" to be shown.
	Comparator with sign (1-byte)	In the superposed function the status LED is activated depending on a comparison. In this configuration there is a separate 1-byte communication object available via which the positive or negative reference value (-128...127) is received. This setting causes the additional parameter "Superposed function ON with" to be shown.
Control of the status LED via object value	<b>1 = superposed Funct. ON /</b> <b>0 = superposed Funct. OFF</b>	If the "Selection of the superposed LED function" is set to "Control via separate LED object", this parameter can be used to specify the telegram polarity of the "Superposed polarity" 1-bit object of the status LED concerned.
	1 = superposed Funct. OFF / 0 = superposed Funct. ON	The superposed function can be switched on or off statically. In addition, the received switching telegram can be evaluated in such a way that the LED flashes when a superposed function is active.
	1 = superposed Funct. flashes / 0 = superposed Funct. OFF	
	1 = superposed Funct. OFF / 0 = superposed Funct. flashes	

<p>Superposed function ON when</p>	<p><b>Reference value greater than received value</b></p> <p>Reference value less than received value</p> <p>Reference value equal to received value</p>	<p>In the superposed function the status LED indicates whether the configured reference value is greater or less than or equal to the value of the "Superposed value function" object. This parameter is only visible when "Selection of the superposed LED function" = "Comparator without sign" / "Comparator with sign".</p>
<p>Reference value (0 ... 255)</p>	<p><b>0...255</b></p>	<p>This parameter defines the reference value to which the value of the "Superposed value function" object is compared. This parameter is only visible when "Selection of the superposed LED function" = "Comparator without sign".</p>
<p>Reference value (-128 ... 127)</p>	<p><b>-128...0...127</b></p>	<p>This parameter defines the reference value to which the value of the "Superposed value function" object is compared. This parameter is only visible when "Selection of the superposed LED function" = "Comparator with sign".</p>
<p><input type="checkbox"/> Disabling Disabling function?</p>	<p><b>Yes</b></p> <p><b>No</b></p>	<p>With this parameter, the disabling function of the push-button sensor can be centrally activated. If "Yes", the ETS shows further communication object and parameters.</p>
<p>Polarity of disabling object</p>	<p><b>disable = 1 / enable = 0</b></p> <p>disable = 0 / enable = 1</p>	<p>This parameter defines the value of the disabling object at which the disabling function is active.</p>
<p>Button assignment of the buttons for disabling function</p>	<p><b>All buttons assigned (TSM + TSEM)</b></p> <p>Individual buttons assigned</p>	<p>With active disabling, either all buttons of the basic and extension modules or only individual buttons may be affected by the disable. This can be used to limit the control function of the push button sensor completely or only partially. Setting "All buttons assigned": the disabling function affects all the buttons of the pushbutton sensor basic module</p>

		and extension module. As soon as any button of the device is pressed while a disabling function is active, the "Behaviour when a disabling function is active" is executed.
		"Individual buttons assigned" setting: the disabling function affects only the buttons that are assigned on the "Disable - Button selection" parameter page. As soon as one of the assigned buttons is pressed while a disabling function is active, the "Behaviour when a disabling function is active" for this button is executed. All other, non-disabled buttons respond normally when pressed.
Reaction of pushbutton sensor at the beginning of the disabling function	<b>No reaction</b>	Besides disabling of rocker and button functions, the pushbutton sensor can also and in addition trigger a specific function at the time of activation of the disabling state.
	Reaction as button >>X<< when pressed	This function can...
	Reaction as button >>X<< when released	correspond to the function assigned to any of the buttons in the non-disabled state ("Reaction as button >>X<< ..."),
	Reaction as disabling function 1 when pressed	be defined on the following parameter pages
	Reaction as disabling function 1 when released	("Reaction as disabling function ..."),
	Reaction as disabling function 2 when pressed	recall a scene stored internally in the pushbutton sensor
	Reaction as disabling function 2 when released	("Internal scene recall ...").
	Internal scene recall scene 1	
	Internal scene recall scene 2	
	Internal scene recall scene 3	
	Internal scene recall scene 4	
	Internal scene recall scene 5	
	Internal scene recall scene 6	
	Internal scene recall scene 7	
	Internal scene recall	

scene 8

Button >>X<<

**Button 1 (TSM)**  
 Button 2 (TSM)  
 ...  
 Button 16 (TSEM - if present)\*

If the pushbutton sensor is to perform the function of a specific button at the beginning of the disabling state, this button will be selected here.

Visible only if "Reaction of pushbutton sensor at the beginning of the disabling function = Reaction as button >>X<< on pressing / releasing"!

**i** \*: The number of buttons depends on the configured pushbutton sensor variant! Moreover, the extension module (TSEM) buttons can only be selected here if a corresponding extension module is also connected to the basic device.

Behaviour during active disabling

**all buttons without function**  
 All buttons behave as  
 Individual buttons without function  
 Individual buttons behave as

While disabling is active...

all buttons or only individually selected buttons can be disabled ("... no function"),

all buttons or only individually selected buttons can be restricted to a specific function ("... behave as"). In this case, the ETS shows further parameters.

All buttons with even numbers behave during disabling as

**Button 1 (TSM)**  
 Button 2 (TSM)  
 ...  
 Button 16 (TSEM - if present)\*  
 Disabling function 1  
 Disabling function 2

If a specific button function is to be assigned during disabling to all or to individual buttons, this parameter can be used to select the desired button the function of which will then be executed. During disabling, all buttons with even numbers (2, 4, 6,...) behave like the one configured here.

The desired functions can either correspond to the function of an existing button or they can be configured as special disabling functions.

**i** Visible only if "Behaviour during active disabling = all buttons behave as" or "Behaviour during active disabling = individual buttons behave as"!

All buttons with odd numbers behave during disabling as

- Button 1 (TSM)**
- Button 2 (TSM)
- ...
- Button 16 (TSEM - if present)\*
- Disabling function 1
- Disabling function 2

**i** \*: The number of buttons depends on the configured pushbutton sensor variant! Moreover, the extension module (TSEM) buttons can only be selected here if a corresponding extension module is also connected to the basic device.

If a specific button function is to be assigned during disabling to all or to individual buttons, this parameter can be used to select the desired button the function of which will then be executed. During disabling, all buttons with odd numbers (1, 3, 5,...) behave like the one configured here. The desired functions can either correspond to the function of an existing button or they can be configured as special disabling functions.

**i** Visible only if "Behaviour during active disabling = all buttons behave as" or "Behaviour during active disabling = individual buttons behave as"!

**i** \*: The number of buttons depends on the configured pushbutton sensor variant! Moreover, the extension module (TSEM) buttons can only be selected here if a corresponding extension module is also connected to the basic device.

Reaction of pushbutton sensor at the end of disabling

- No reaction**
- Reaction as button >>Y<< when pressed
- Reaction as button >>Y<< when released
- Reaction as disabling function 1 when pressed
- Reaction as disabling function 1 when released
- Reaction as disabling function 2 when pressed
- Reaction as disabling function 2 when released
- Internal scene recall scene 1
- Internal scene recall

Besides disabling of rocker and button functions, the pushbutton sensor can also trigger a special function immediately at the end of disabling.

This function can... correspond to the function assigned to any of the buttons in the non-disabled state ("Reaction as button >>X<< ..."), be defined on the following parameter pages ("Reaction as disabling function ..."), recall a scene stored internally in the pushbutton sensor ("Internal scene recall ...").

scene 2

...

Scene 8

Button >>Y<<

**Button 1 (TSM)**

Button 2 (TSM)

...

Button 16 (TSEM - if present)\*

If the pushbutton sensor is to perform the function of a specific button at the end of the disabling state, this button will be selected here.

Only visible if "Reaction of pushbutton sensor at the end of disabling = Reaction as button >>Y<< on pressing / releasing"!

**i** \*: The number of buttons depends on the configured pushbutton sensor variant! Moreover, the extension module (TSEM) buttons can only be selected here if a corresponding extension module is also connected to the basic device.

Disable button selection (Only visible with "Button assignment of the buttons for disabling function" = "Individual buttons assigned"!)

Selection of the buttons for behaviour during disabling

Button 1? (TSM)

Yes  
**No**

The user can specify for each button separately whether it will be affected by the disabling function during the disabling state.

Button 2? (TSM)

Yes  
**No**

**i** \*: The number of buttons depends on the configured pushbutton sensor variant! Moreover, the extension module buttons can only be selected here if a corresponding extension module is also connected to the basic device.

...

Yes  
**No**

Button 16? (TSEM - if present)\*

Disabling function 1 disable / Disabling function 2 disable. With the exception of the status LED control, the parameters available for the two disabling functions are the same as those for the button functions.

The same functions, parameters and settings as in the pushbutton sensor basic module TSM are available for the pushbutton sensor extension module TSEM. Thus, the settings in the extension module are independent of the settings in the basic module.

Description	Values	Comment
<input type="checkbox"/> Alarm signal		
Alarm signal display		



	<p>Activated</p> <p><b>Deactivated</b></p>	<p>This parameter can be used to enable alarm signal displaying.</p> <p>When alarm signalling is enabled, the ETS displays further parameters and up to two further communication objects.</p>
<p>Polarity of the alarm signalling object</p>	<p><b>Alarm when ON and Alarm reset when OFF</b></p> <p>Alarm when OFF and Alarm reset when ON</p>	<p>The alarm signalling object is used as an input for activating or deactivating alarm signal displaying.</p> <p>If the object value corresponds to the "Alarm" state, all status LEDs, the operation LED and the labelling field flash with a frequency of approx. 2 Hz.</p> <p>If the setting is "Alarm when OFF and alarm reset when ON", the object must first be actively written by the bus with "0" to activate the alarm after a reset.</p> <p>An alarm signal is not stored so that the alarm signalling is generally deactivated after a reset or after programming with the ETS.</p>
<p>Reset alarm signalling by a button-press?</p>	<p><b>Yes</b></p> <p>No</p>	<p>If this parameter is set to "Yes", active alarm signal displaying can be deactivated by a button-press on the push button sensor.</p> <p>This button-press does not cause the configured function of the pressed button to be executed. Only after the next button-press will the configuration of the button be evaluated and a telegram be transmitted to the bus, if applicable.</p> <p>If "No" has been selected, alarm signalling can only be deactivated via the alarm signalling object. A button-press will always execute the configured button function.</p>
<p>Use the alarm acknowledge object?</p>	<p>Yes</p> <p><b>No</b></p>	<p>If alarm signalling can be deactivated by a button-press, this parameter defines whether an additional alarm acknowledge telegram is to be transmitted to the bus via the separate object "Alarm signalling acknowledge" after triggering by this button-press.</p> <p>A telegram can, for instance, be sent via this object to the "Alarm signalling" objects of other push button sensors in order to reset the alarm status there as well (observe the polarity of the acknowledge object!).</p>

Acknowledge alarm  
signalling by

**OFF telegram \***  
**ON telegram \***

This parameter sets the polarity of the  
"Alarm signalling acknowledge" object.

**i** \*: The presetting for this parameter  
depends on the polarity set for the  
alarm message object.

Energy saving mode

Energy saving mode

**Disabled**  
enabled

The device has an energy saving mode  
to save electrical energy during  
operation. If the energy-saving mode is  
used, the signalling function of the  
device is switched off after a preset time  
without operation or by an external  
telegram.  
This parameter enables the energy  
saving mode so that it can be used.

Activating energy  
saving mode

by object

**automatically by time**

automatically by time or by  
object

The device has two different activation  
options for switching the pushbutton  
sensor to the energy saving mode.  
These can either be combined together  
or used separately. Firstly, the  
pushbutton sensor can be set to the  
energy saving mode by a group  
telegram via a communication object  
designated for this purpose. Secondly, it  
is possible to switch to the energy  
saving mode automatically if no  
operation occurs within a defined time  
period.

Deactivating energy  
saving mode

**automatically on  
operation**

automatically on operation  
or via object

The device also has two different  
options for the deactivation of the  
energy saving mode. Firstly, it is  
possible to deactivate the energy saving  
mode automatically as soon as the basic  
module or the extension module is  
operated. If an operation of the device  
deactivates the energy saving mode, the  
device always executes the configured  
operating function immediately as well  
(e.g. switching, dimming, etc.).  
Secondly, the energy saving mode can  
be deactivated by a group telegram via  
a communication object designated for  
this purpose. However, this possibility  
can only be combined with the  
automatic deactivation on operation.

Polarity object "energy saving mode"	<p>"0" = --- / "1" = <b>mode active</b></p> <p>"0" = mode active / "1" = ---</p> <p>"0" = <b>mode inactive</b> / "1" = <b>mode active</b></p> <p>"0" = mode active / "1" = mode inactive</p> <p>"0" = <b>mode inactive</b> / "1" = ---</p> <p>"0" = --- / "1" = mode inactive</p>	<p>This parameter defines the telegram polarity for the object for activating or deactivating the energy saving mode. The options and thus standard setting of this parameter depend on whether the energy saving mode can only be activated, only deactivated or activated as well as deactivated via the object.</p>
Time for energy saving mode Minutes (1...59)	1...59	<p>This parameter defines the time that must elapse after an operation so that the device activates the energy saving mode. Each operation restarts the time. Setting the delay time minutes. This parameter is only visible when the energy saving mode is to be activated automatically by time.</p>

## 5 Appendix

### 5.1 Index

#### Numerical

3-colour individual control..... 62

#### A

application program..... 15

automatic colour change..... 61

#### B

brightness..... 63

#### C

Configuration TSEM..... 81

Configuration TSM..... 81

Control surfaces..... 16

Controller extension..... 71

Controller extension unit button functions ..... 71

#### D

decorative control surfaces..... 15

Device components..... 8

#### E

energy-saving mode..... 78

ETS configuration..... 22

#### O

Objects for full-surface operation..... 27

Objects for room temperature measurement ..... 37

#### P

Parameter group "Disabling"..... 116

Parameter group "General"..... 81

physical address..... 14

product database..... 22

#### R

room temperature..... 76

#### S

Scene definition..... 64

scene recall..... 64

Scope of functions..... 20

Status LED..... 58

Storing scenes..... 65

superimposed function..... 61

#### T

Temperature calibration..... 75

Temperature detection..... 75

#### U

User-defined colour setting..... 61

**ALBRECHT JUNG GMBH & CO. KG**

Volmestraße 1  
58579 Schalksmühle  
GERMANY

Telefon: +49 2355 806-0  
Telefax: +49 2355 806-204  
kundencenter@jung.de  
www.jung.de