

Audio indoor station  
Video indoor station  
Modules

SIEDLE Systemtechnik  
In-Home

**JUNG**

SIAI..  
SIVI..  
SITM.. / SIVM.. / SIAM..

Operating instructions



ALBRECHT JUNG GMBH & CO. KG  
Volmestraße 1  
58579 Schalksmühle  
GERMANY

Tel. +49 2355 806-0  
Fax +49 2355 806-204

kundencenter@jung.de  
www.jung.de

---

## Table of contents

Safety instructions .....	3
Intended use .....	3
Device variants .....	4
Functioning combinations.....	5
Audio indoor station.....	6
Video indoor station.....	6
Secondary signal unit (bell).....	7
Audio indoor station variants.....	8
Video indoor station variants.....	9
Accessories.....	10
Individual inscription using design covers.....	10
Dismounting protection.....	10
Product characteristics.....	11
Operation.....	16
Accepting door calls .....	16
Actuating the door release .....	16
Switching off the ring tone.....	16
Switching on the light.....	17
Dialling the door station.....	17
Voice volume.....	17
Switching over the speech direction.....	17
Inscription field illumination (only universal push-button module).....	17
Configuration .....	18
Ring tone volume.....	18
Ring tone melody.....	18
Button assignment.....	18
Video functions.....	19
Switching on the monitor (only with video).....	19
Setting the brightness (only with video).....	19
Setting the colour (only with video).....	19
Setting the microphone sensitivity .....	19

---

Mounting.....	20
Rear view.....	21
Connecting the cables.....	22
Terminating resistor.....	23
Commissioning.....	23
Cleaning.....	23
Warranty.....	24

## Safety instructions



Electrical equipment may only be installed and fitted by electrically skilled persons. Failure to observe the instructions may cause damage to the device and result in fire and other hazards.

This product is only intended for use in dry rooms.

These instructions are an integral part of the product and must remain with the end customer.

## Intended use

### Application

- Bus handsfree telephone for Siedle In-Home bus
- Flush mounting
- Optional video function

### Audio indoor station:

- Mounting in two flush mounting junction boxes in compliance with DIN 49073
- Mounting in surface caps ..582A.. is possible

### Video indoor station:

- Mounting in three flush mounting junction boxes in compliance with DIN 49073
- Mounting in surface caps ..583A.. is possible

---

## Device variants

### Modules

The modular system comprises the following individual components, which are linked using the provided colour-coded connection cables designed for failsafe connection:

#### a. Audio module

The audio module is the core element of every functioning combination.

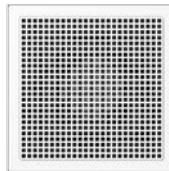

It incorporates terminals for the Siedle In-Home bus, the storey call button and other modules.

#### b. Standard push-button module

The standard push-button module is used for the operation of audio systems or for adding extra buttons. The inscription field cannot be illuminated.



The push-button module comes with an audio connection cable (red, 220 mm) and the finished inscription for audio/video.

It is not possible to add another push-button module to a standard push-button module.

### c. Universal push-button module

The universal push-button module is used for the operation of audio or video systems or for adding extra buttons. The inscription field can be illuminated.



The push-button module comes with an audio connection cable (red, 220 mm) and the finished inscription for audio/video.

The supplementary supply for the video module and/or inscription field illumination is connected using this module

It is possible to connect another push-button module to a universal push-button module. A maximum of two push-button modules are possible.

### d. Video module

The video module is used to display camera images from the connected door station.



The video module is supplied together with the video connection cable (black, 220 mm).

### Functioning combinations

The following devices can be combined using modules a. - d.:

## Audio indoor station

The audio indoor station SIAL.. is supplied complete as a functioning unit.

Included in delivery of SIAL.:

- Audio module
- Standard push-button module
- Cover kit for push-button module
- Transparent nameplate with labelling foils for audio/video
- Audio connection cable (red, 220 mm)
- 6-gang connection block with terminating resistor
- 2 supporting frames
- Product information

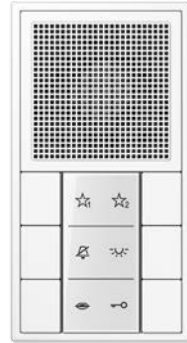

## Video indoor station

The video indoor station SIVI.. is supplied complete as a functioning unit.

Included in delivery of SIVI.:

- Audio module
- Universal push-button module
- Video module
- Cover kit for push-button module
- Transparent nameplate with labelling foils for audio/video
- Audio connection cable (red, 220 mm)
- Video connection cable (black, 220 mm)
- 6-gang connection block with terminating resistor
- 2-gang connection block for universal push-button module
- 3 supporting frames
- Product information

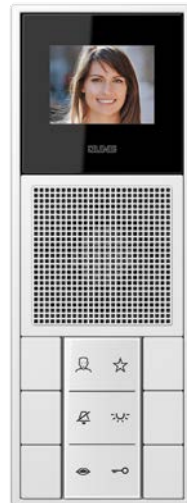

---

## Secondary signal unit (bell)

The secondary signal unit corresponds to the audio module. This can be purchased under the article number SIAM... As this module does not have any buttons, a storey call button must be connected during manual commissioning or commissioning using the Bus Programming Software.

Included in delivery of SIAM..:

- Audio module
- 1 supporting frame
- 6-gang connection block with terminating resistor
- Product information

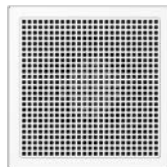

## Audio indoor station variants

The audio indoor station can be extended with 6 additional buttons by means of a universal push-button module. This increases the number of buttons which can be used for functions such as internal calls, control, switching, direct door dialling and additional convenience functions.

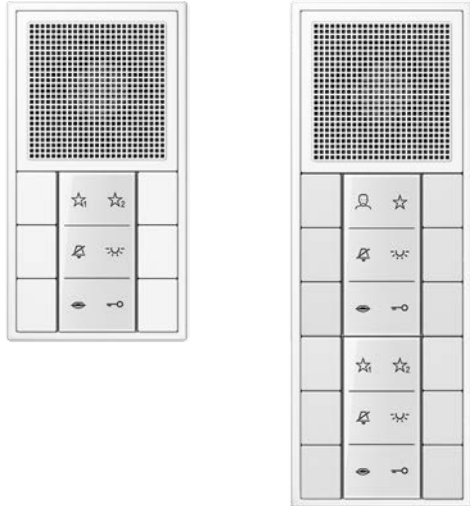

Possible combinations:

- 1 x audio module  
1 x standard push-button module
  
- 1 x audio module  
1 x universal push-button module
  
- 1 x audio module  
1 x universal push-button module  
1 x standard push-button module
  
- 1 x audio module  
2 x universal push-button module

### Note

The combinations shown here are only provided as examples. Installation can take place in combination or individually - horizontally or vertically.

The modules are combined with the frames of the design ranges AS, A, CD or LS.

The frames are not included in the delivery.



## Video indoor station variants

The video indoor station can be extended with 6 additional buttons by means of a standard / universal push-button module. This increases the number of buttons which can be used for functions such as internal calls, control, switching, direct door dialling and additional convenience functions.

Possible combinations:

- 1 x video module  
1 x audio module  
1 x universal push-button module
- 1 x video module  
1 x audio module  
1 x universal push-button module  
1 x standard push-button module
- 1 x video module  
1 x audio module  
2 x universal push-button module

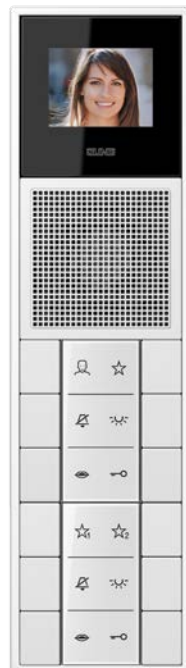
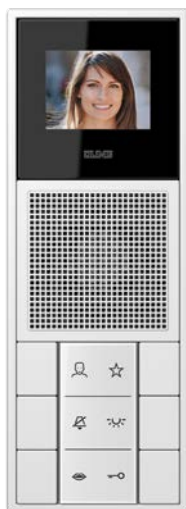

### Note

The modules are interconnected using the supplied connection cables. Connection to the Siedle In-Home bus takes place at the audio module.

For separate mounting, 700 mm long connection cables are required.

---

## Accessories

The following accessories can be ordered in addition to the modules and modular indoor stations:

### Connection cable 700 mm (audio/video)

Using the optionally available connection cables, the modules can be positioned up to 500 mm apart from each other.

### Individual inscription using design covers

The push-button modules include a transparent nameplate with labelling foil for audio and video. Alternatively, the design covers of the F50 push-button modules can be inserted in the inscription field and individually inscribed using the JUNG Graphic Tool.

Symbol covers already labelled for audio and video are available under the following article numbers:

Audio           SIA6 .. DC ..

Video           SIV6 .. DC ..

### Dismounting protection

The dismounting protection ensures that the modules can only be removed with the use of a tool. A flat-bladed screwdriver or the button lever (ref.-no. W-KEIL) can be used for this.

One dismounting protection, ref.-no. M-DMS, is required for each module.

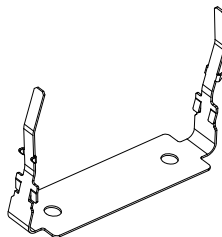

---

## Product characteristics

### Standard push-button module

- 5 LEDs as indicators (e.g. door open) without additional wiring
- Ready status indicated by an LED
- Optical call indication by flashing LED at the speech button
- Inscription field
- Labelling foils with symbols for audio and video included
- Audio connection cable (red, 220 mm) included

### Universal push-button module

- 5 LEDs as indicators (e.g. door open) without additional wiring
- Ready status indicated by an LED
- Optical call indication by flashing LED at the speech button
- Illuminable inscription field
- Labelling foils with symbols for audio and video included
- Audio connection cable (red, 220 mm) included
- Connection for supplementary supply (required for operation of a video module, illumination of the inscription field in the universal push-button module, and when connecting a second push-button module)
- Connection for an additional push-button module (standard or universal, max. 2 push-button modules per indoor station)

### Video module 2.2"

- TFT colour monitor
- Screen diagonal 55 mm (2.2")
- 320 x 240 pixels
- Brightness and colour setting
- Video connection cable (black, 220 mm) included
- Operation only in combination with universal push-button module and audio module

---

## Audio module

- Can also be used as a secondary signal unit (bell)
- Calling and storey call
- 2-wire installation (J-Y(St)Y 2 x 2 x 0.8), protected against polarity reversal
- Parallel switching (simultaneous calling) of max. 4 audio modules or audio indoor stations (from the 3rd device, Siedle BPS is required for programming)
- High-quality sound and great loudspeaker dynamics
- Electret condenser microphone
- Connection for Siedle In-Home bus
- Connections for storey call button and to additional modules
- Call generator with 11 ring tone melodies, including chime
- Ring tone volume adjustable in 5 steps up to 92 dB(A)
- Voice volume adjustable in 5 steps
- Programming manual, Plug+Play and using Siedle bus programming software (BPS), in accordance with the Siedle system manual
- Automatic call pickup with internal call

## Audio indoor station

- Calling, speech, door release, light, storey call, switching/control functions and internal communication
- 2-wire installation (J-Y(St)Y 2 x 2 x 0.8), protected against polarity reversal
- Speech button with green status LED
- Light, mute and two function buttons are freely configurable. Button functions can be triggered without supplementary installation, e.g. for internal telephony, to initiate switching/control functions in conjunction with Siedle bus switching module BSM/BSE 650-.., selective dialling of door loudspeakers
- Using the BPS, a switching function can be configured to the door release button (in conjunction with the Siedle bus switching module BSM/BSE 650-..).
- Integrated audio privacy function
- Parallel switching (simultaneous calling) of max. 4 audio modules or audio indoor stations (from the 3rd device, Siedle BPS is required for programming)
- Speech connection possible at any time, also without a preceding door call
- High-quality sound and great loudspeaker dynamics
- Electret condenser microphone

- 
- Connection for Siedle In-Home bus
  - Connection for storey call button
  - Call generator with 11 ring tone melodies, including chime
  - Ring tone volume adjustable in 5 steps up to 92 dB(A)
  - Voice volume adjustable in 5 steps
  - Programming manual, Plug+Play and using Siedle bus programming software (BPS), in accordance with the Siedle system manual
  - Indoor station with handsfree communication
  - Status indication during active speech connection
  - Call silencing with status indication
  - Call differentiation for storey call, 2 door calls and internal call
  - Door release / light function at any time via the bus line
  - Door call pickup
  - Group formation for door calls. Each indoor station can belong to up to 4 groups in the same line
  - Intercom functions:
    - Call forwarding
    - Internal group call
    - Automatic call pickup with internal call
    - Doormatic
  - 5 LEDs as indicators (e.g. door open) without additional wiring
  - Ready status indicated by an LED
  - Optical call indication by flashing LED at the speech button
  - Inscription field
  - Labelling foils with symbols for audio and video included
  - Audio connection cable (red, 220 mm) included

---

## Video indoor station

- TFT colour monitor
- Screen diagonal 55 mm (2.2")
- 320 x 240 pixels
- Brightness and colour setting
- Video connection cable (black, 220 mm) included
- Calling, speech, vision, door release, light, storey call, switching/control functions and internal communication
- 2-wire installation, protected against polarity reversal; 2-pole supplementary supply required (J-Y(St)Y 2 x 2 x 0.8)
- Automatic video connection at door call
- Speech button with green status LED
- Light, mute, monitor and function button are freely configurable. Button functions can be triggered without supplementary installation, e.g. for internal telephony, to initiate switching/control functions in conjunction with Siedle bus switching module BSM/BSE 650-., selective dialling of door loudspeakers/cameras
- Using the BPS, a switching function can be configured to the door release button (in conjunction with the Siedle bus switching module BSM/BSE 650-..).
- Integrated audio and video privacy function
- Parallel switching (simultaneous calling) of max. 16 video indoor stations (from the 3rd device, Siedle BPS is required for programming)
- Speech/video connection at any time, also without a preceding door call
- High-quality sound and great loudspeaker dynamics
- Electret condenser microphone
- Connection for Siedle In-Home bus
- Connection for storey call button
- Call generator with 11 ring tone melodies, including chime
- Ring tone volume adjustable in 5 steps up to 92 dB(A)
- Voice volume adjustable in 5 steps
- Programming manual, Plug+Play and using Siedle bus programming software (BPS), in accordance with the Siedle system manual
- Indoor station with handsfree communication
- Status indication during active speech connection
- Call silencing with status indication
- Call differentiation for storey call, 2 door calls and internal call

- 
- Door release / light function at any time via the bus line
  - Door call pickup
  - Group formation for door calls. Each indoor station can belong to up to 4 groups in the same line
  - Intercom functions:
    - Call forwarding
    - Internal group call
    - Collective announcement
    - Automatic call pickup with internal call
    - Doormatic
  - 5 LEDs as indicators (e.g. door open) without additional wiring
  - Ready status indicated by an LED
  - Optical call indication by flashing LED at the speech button
  - Illuminable inscription field
  - Labelling foils with symbols for audio and video included
  - Audio connection cable (red, 220 mm) included
  - Connection for supplementary supply (required for operation of a video module, illumination of the inscription field in the universal push-button module, and when connecting a second push-button module)
  - Connection for an additional push-button module (standard or universal, max. 2 push-button modules per indoor station)

## Operation



Speech button



Door release button



Mute button (+)



Light button (-)



Monitor button (only with video)



Function button (with audio, marked 1 and 2)

## Accepting door calls

When a visitor presses the door bell, the indoor station rings and the speech button LED flashes.



The call can be accepted by briefly pressing the speech button within 45 seconds after the last door call. During the call, the speech button LED is alight.

The call is ended by briefly pressing the speech button again.

## Actuating the door release



When you press the door release button, the door from which the last call came is opened for 3 seconds. The LED of the door release button lights up as confirmation.

## Switching off the ring tone



Pressing the mute button briefly will switch all ring tones off and then on again. The LED of the mute button lights up in red to indicate that the call silencing is active.

If a visitor rings the doorbell, this is indicated only by the speech button LED flashing for as long as the indoor station is mute.



---

## Switching on the light



When you press the light button, the lighting is switched on, provided this has been connected by your electrician. The LED of the light button lights up as confirmation.

## Dialling the door station



Press the speech button to make a speech connection to the door station from which the last call came.

## Voice volume



During a call, the voice volume can be set by the mute button (+) or light button (-).

## Switching over the speech direction

This handsfree telephone transmits speech in only one direction and switches over automatically.



If the automatic switch-over function does not work due to loud background noise at the door station, it is possible to switch over the speech direction from indoors to outdoors by pressing and holding down the speech button.

If this button is released, the speech direction switches over from the door station to the indoor station.

## Inscription field illumination (only universal push-button module)



By pressing the light button for 3 seconds, the inscription field illumination is switched on or off respectively.

---

## Configuration

### Ring tone volume

The ring tone volume can be set in 5 different steps:



Hold down the mute button for 3 seconds to hear the set ring tone volume.



The volume can be set by the mute button (+) or light button (-).



Save the selected volume by pressing the mute button for 3 seconds.

### Ring tone melody

You can choose between 11 ring tone melodies.

The ring tone for the last call (door call, storey call, internal call, group call) is always set. Before changing the setting, you will therefore have to first initiate the call you wish to change.



Press and hold down the door release and light button simultaneously for 3 seconds to hear the set ring tone melody.



The ring tone can be selected by pressing the mute button (+) or light button (-).



Save the selected ring tone by pressing the mute button for 3 seconds.

### Button assignment



The buttons of the indoor station can be used e.g. for making internal calls or for switching and control functions. Each button is assigned to an LED to indicate switching statuses.

For further information, please contact your electrician.

## Video functions

### Switching on the monitor (only with video)



Pressing the monitor button will show the camera picture from the door station which placed the last door call. This function is not possible during a call.

### Setting the brightness (only with video)



When a video image is displayed, holding down the mute button for a long time changes the brightness setting of the video image. The brightness can be set at 7 different levels.

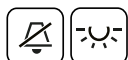

Every time the mute button (+) or light button (-) is pressed, the system changes to the next or previous level. If no button is actuated for a period of 10 seconds, the setting mode is deactivated. The last set brightness level is stored.

### Setting the colour (only with video)



When a video image is displayed, holding down the light button for a long time changes the colour setting of the video image. The colour can be set at 7 different levels.

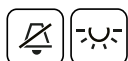

Every time the mute button (+) or light button (-) is pressed, the system changes to the next or previous level.

If no button is actuated for a period of 10 seconds, the setting mode is deactivated. The last set colour value is stored.

### Setting the microphone sensitivity

Depending on the installation environment, it may be necessary to change the microphone sensitivity of the indoor station in order to permit clear speech transmission.

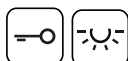

If a speech connection exists, press the door release button and light button simultaneously for 3 seconds until an acknowledgement tone is audible.



Using the mute button (+) or the light button (-), the microphone sensitivity can be set at 3 levels.



Save the set microphone sensitivity by pressing the mute button for 3 seconds. If no input is made within 10 seconds, the microphone setting switches off again.

## Mounting

The recommended mounting height is 1.50 m.

Siedle In-Home bus  
(where applicable  
supplementary supply +  
storey call button)

Black  
cable

Red  
cable

Red  
cable

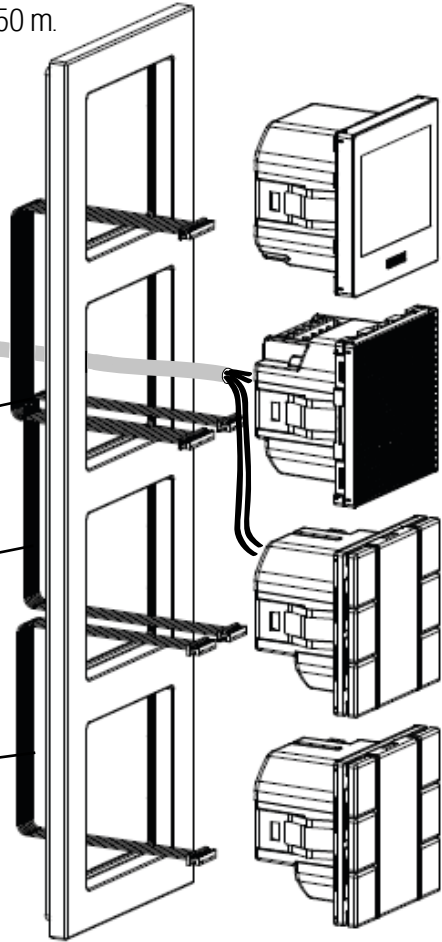

Each module is mounted in a flush-mounted appliance box according to DIN 49073. We recommend using a deep junction box for mounting. Mounting takes place using the provided supporting frames.

## Rear view

Installation can take place in combination or individually - horizontally or vertically. The modules are combined with the frames of the design ranges AS, A, CD or LS.

The modules are interconnected using the supplied connection cables. Connection to the Siedle In-Home bus takes place at the audio module.

For separate mounting, 700 mm long connection cables are required.

A supplementary supply is connected at the universal push-button module.

Here, the two audio connecting jacks are interchangeable.

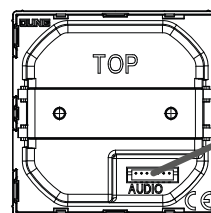
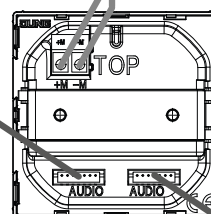
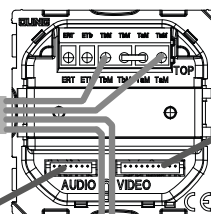
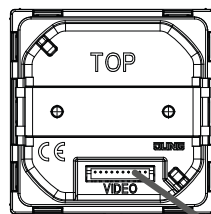

## Safety instructions



Electrical equipment may only be installed and fitted by electrically skilled persons. Failure to observe the instructions may cause damage to the device and result in fire and other hazards.

This product is only intended for use in dry rooms.

These instructions are an integral part of the product and must remain with the end customer.

## Connecting the cables

Cable type: Telecom cable J-Y(St)Y with twisted pairs.  
The customary diameter is 0.6 mm or 0.8 mm.

- Remove the plug-in screw terminal.
- Connect the cables in accordance with the inscription (TaM/TbM).
- A storey call button must be connected between the terminals ERT and ETb.
- Plug the screw terminal back into place.
- Ensure that the terminals are positioned correctly.

## Terminal assignment

at the audio module:

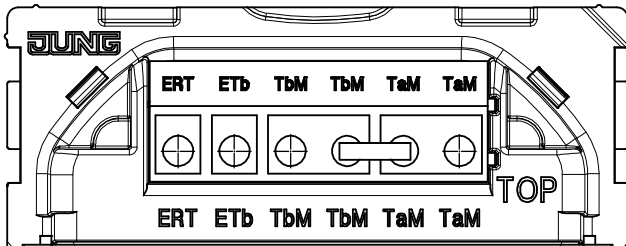

TaM/TbM = Siedle In-Home bus terminal

ERT/ETb = Storey call button terminal

at the universal push-button module:

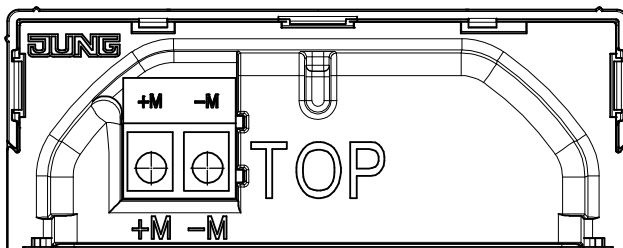

M+/M- = Supplementary supply terminal (max. 30 V DC)

---

## Safety instructions



Electrical equipment may only be installed and fitted by electrically skilled persons. Failure to observe the instructions may cause damage to the device and result in fire and other hazards.

This product is only intended for use in dry rooms.

These instructions are an integral part of the product and must remain with the end customer.

### Terminating resistor

A terminating resistor is connected between TaM and TbM. This terminating resistor is required if the modular indoor station is the last device in a video line.

If you loop the bus through the modular indoor station, this terminating resistor must be removed.

### Commissioning

Installation, commissioning and programming are described in the Siedle system manual (enclosed with the Siedle bus line rectifiers BNG/BVNG 650-..).

Localization of a secondary signal unit in the Siedle Bus Programming Software is only possible via a connected storey call button.

### Cleaning

Ensure that no water penetrates the device! Do not use aggressive or abrasive cleaning agents!

Clean the device using a dry or slightly damp cloth. Remove heavy soiling with a mild household detergent.

## Warranty

The warranty is provided in accordance with statutory requirements via the specialist trade.



The CE-sign is a free trade sign addressed exclusively to the authorities and does not include any warranty of any properties.

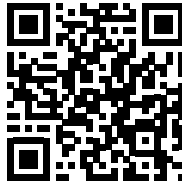

ALBRECHT JUNG GMBH & CO. KG  
Volmestraße 1  
58579 Schalksmühle  
GERMANY

**JUNG**

Tel. +49 2355 806-0  
Fax +49 2355 806-204  
kundencenter@jung.de  
www.jung.de

Subject to changes.

en\_0024086001\_Six\_V03  
06/2015  
0024086001