



Product documentation

Room controller display compact module 2-gang
Art. No. ..5192KRMTSD

Room controller display compact module 4-gang
Art. No. ..5194KRMTSD



ALBRECHT JUNG GMBH & CO. KG
Volmestraße 1
58579 Schalksmühle
GERMANY

Telefon: +49 2355 806-0
Telefax: +49 2355 806-204
kundencenter@jung.de
www.jung.de

Issue: 10.06.2022
TD 135579x0 V03

Table of Contents

1	Product definition	4
1.1	Product catalogue	4
1.2	Function	4
1.3	Accessories	6
2	Installation, electrical connection and operation	7
2.1	Safety instructions	7
2.2	Device components	8
2.2.1	Front view 2-gang	8
2.2.2	Front view 4-gang	10
2.2.3	Rear side	12
2.3	Mounting and electrical connection	13
2.4	Commissioning	18
2.5	Operation	20
2.5.1	Operating level	21
2.5.2	Menu level	22
3	Technical data	34
4	Software description	35
4.1	Software specification	35
4.2	Software "Room controller display compact module"	38
4.2.1	Scope of functions	38
4.2.2	Notes on software	43
4.2.2.1	Device generations and using the application programs	43
4.2.3	Object table	44
4.2.3.1	Rockers or button functions	44
4.2.3.2	Status LED	49
4.2.3.3	Disabling functions	51
4.2.3.4	Display	55
4.2.3.5	Alarm signal	58
4.2.3.6	Room temperature measurement	59
4.2.3.7	Scene function	62
4.2.3.8	Room temperature controller	63
4.2.3.9	Controller extension	80
4.2.3.10	Operation LED and labelling field illumination	84
4.2.4	Functional description	85
4.2.4.1	General settings	85
4.2.4.1.1	Button configuration	85
4.2.4.1.2	Operation concept and button evaluation	86
4.2.4.1.3	Transmission delay	87
4.2.4.2	Display	88
4.2.4.2.1	Displayed information	88
4.2.4.2.2	Display control	93
4.2.4.2.3	Button function icons	96
4.2.4.3	Room temperature controller	98
4.2.4.3.1	Operating modes and operating mode change-over	98
4.2.4.3.2	Control algorithms and calculation of command values	101

4.2.4.3.3	Adapting the control algorithms	109
4.2.4.3.4	Operating mode switchover	112
4.2.4.3.5	Temperature setpoints	122
4.2.4.3.6	Command value and status output	136
4.2.4.3.7	Fan controller	146
4.2.4.3.8	Disable functions of the room temperature controller	154
4.2.4.3.9	Valve protection	155
4.2.4.3.10	Underfloor heating temperature limit	156
4.2.4.4	Controller extension	157
4.2.4.4.1	Connection to room temperature controller	157
4.2.4.4.2	Operating functions	160
4.2.4.4.3	Display functions	163
4.2.4.4.4	Behaviour after a device restart	165
4.2.4.5	Room temperature measurement	166
4.2.4.6	Rockers and button function	169
4.2.4.6.1	Switching function	169
4.2.4.6.2	Dimming function	170
4.2.4.6.3	"Blind" function	172
4.2.4.6.4	"Value transmitter" function	176
4.2.4.6.5	Scene extension function	179
4.2.4.6.6	2-channel operation function	180
4.2.4.6.7	Controller extension function	182
4.2.4.6.8	Controller operation function	183
4.2.4.6.9	"Change in the display reading" function	186
4.2.4.7	Status LED	187
4.2.4.7.1	Functions of the status LED	187
4.2.4.7.2	Standard display function	194
4.2.4.8	Scene function	198
4.2.4.9	Disabling function	202
4.2.4.10	Alarm signal	206
4.2.4.11	Delivery state	207
4.2.5	Parameters	208
4.2.5.1	Parameter group "General"	208
4.2.5.2	Parameter group "TSM" and "TSEM"	217
4.2.5.2.1	Rocker functions	223
4.2.5.2.2	Push-button functions	237
4.2.5.2.3	Functions of the status LED	251
4.2.5.3	Parameter group "Room temperature control"	259
4.2.5.3.1	Room temperature controller	260
4.2.5.3.2	Controller extension	285
4.2.5.4	Parameter group "Room temperature measurement"	288
4.2.5.5	Parameter group "Disabling"	290
4.2.5.6	Parameter group "Scenes"	294
4.2.5.7	Parameter group "Alarm"	299
4.2.5.8	"Display" parameter group	301
5	Appendix	308
5.1	Index	308

1 Product definition

1.1 Product catalogue

Product name: Room controller display compact module 2-gang / Room controller display compact module 4-gang

Use: Sensor

Design: FM (flush-mounted)

Art. No. ..5192KRMTSD / ..5194KRMTSD

1.2 Function

The compact room controller module is a TSM (pushbutton sensor basic module). The TSM combines the functions of a KNX/EIB bus coupling unit, two single-room temperature controllers with setpoint specification, a pushbutton sensor (2-gang or 4-gang), and a display unit in just one KNX subscriber.

The combination of these functions makes it possible, for example, to control the light, the blinds, and the room temperature centrally from the entry area of a room.

The room temperature controller and pushbutton sensor functions are each independent function sections of the device with their own parameter blocks in the ETS.

The 2-gang compact room controller module possesses up to 4 control surfaces. The 4-gang compact room controller module possesses up to 8 control surfaces. The control surfaces can be used to operate the integrated room temperature controllers and the pushbutton sensor functions. The functions can be configured in the ETS.

Optionally, the number of control surfaces can be expanded to include 8 additional ones by connecting a TSEM (pushbutton sensor extension module or room controller extension module) to the TSM. The configuration and commissioning of the TSEM are clearly structured and easy to perform using the application program of the room controller display compact module.

Display functions:

The integrated display shows statuses of room temperature controllers and the settings of the control operating modes for up to two rooms in the Heating and Cooling operating modes. The TSM can show up to 17 pieces of display information, either changing cyclically or directly via a communication object. The menu level is shown on the display, providing that it has been enabled in the parameters. Various temperature values can be displayed in the menu level as an option. It is also possible to change controller settings (setpoint temperatures, presence operation, operating mode, fan control, etc) directly on the device and adjust the brightness of the display. In addition, configurable pushbutton function icons (only in the design ranges LS and CD!) support the operation of the button and rocker functions on the device.

Room temperature controller:

The device unites two independent room temperature controllers. Both controllers can be used for separate single-room temperature controllers. Depending on the operating mode, current temperature setpoint and room temperature, a variable for heating or cooling control can be transmitted to the KNX for each control circuit. In addition to the heating or cooling basic level, activating an additional heater and/or cooling unit means that an additional heating or cooling unit can be used. In this connection, you can set the temperature setpoint difference between the basic and the additional level by a parameter in the ETS. For major deviations between the temperature setpoint and the actual temperature, you can activate this additional level to heat up or cool down the room faster. You can assign different control algorithms to the basic and additional stages.

For heating and cooling functions, you can select continuous or switching PI or switching 2-point feedback control algorithms.

The controller distinguishes between different operating modes (comfort, standby, night, frost/heat protection) each with their own temperature setpoints for heating or cooling.

Room temperature measurement:

The product database of the device contains three independent blocks for room temperature measurement. Up to three temperatures can be determined in parallel, when the device is installed combined with a TSEM and/or with a connected remote sensor. With a device installation without TSEM and a remote sensor, a room temperature can be determined on the device. Each room temperature measurement can be performed by the internal sensor or, optionally, by a received temperature value. Combined temperature recording (internal sensor + received temperature value) can also be configured.

Push-button sensor functionality:

When a rocker or button is pressed, the device transmits telegrams to the KNX, depending on the ETS parameter settings. The following functions can be set: Switching, dimming, Venetian blind, 1-byte value transmitter and 2-byte value transmitter. Using the value transmitter functions, values between 0 and 255, 0 and 100%, 0 and 65535, temperature values (0...40°C) or brightness values can be transmitted to the KNX according to the parameters.

In addition, when a rocker or a button is actuated, the device can execute the Scene extension function, 2-channel operation or a change of the display.

A configured button can also operate one of the internal controllers or affect one of the two controller extensions.

The operation concept of two operating elements can be configured in the ETS either as a rocker function or alternatively as a button function. With the rocker function, two control elements work together and execute a basic function. In the button function, each operating element is evaluated separately.

With the rocker function, similar buttons are arranged "horizontally" (left-right operation). Thanks to full-area operation, additional special functions can be triggered if a rocker function is designed.

The compact 2-gang room controller possesses two status LEDs for each control surface.

The compact 4-gang room controller possesses one status LED for each control surface.

The status LEDs can be internally connected to the operating function, according to the function of the rocker or button. Each status LED can then also signal completely independent display information, operating states of room temperature controllers or indicate the results of logic value comparisons, flash or be permanently switched on or off.

LED functions:

The compact room controller module possesses eight status LEDs. The status LEDs are executed in three colours and can – according to choice, in either red, green or blue – be switched on or off permanently or can function as an operation display or as a status display. Furthermore, different statuses of the internal controller can be displayed. As an alternative, with the aid of separate communication objects, they can signal widely varying display information completely independently of the pushbutton function, e.g. operation states of fault messages or also room temperature controllers, the results of logic value comparisons, flash or be permanently switched on or off. Each colour of a status LED can be controlled either by three separate objects or alternatively by a mutual object (superimposed function), so that traffic light functions can also be implemented, - for example, depending on a limiting value - by means of an LED. When switched-off, the status LEDs can shine in a designed colour, creating an orientation light. The brightness of the status LED can be set to five levels. Through night reduction, the brightness of the status LED can be reduced at night using a communication object.

The active programming mode on the TSM is indicated by changing the colour of status LED 1 and status LED 2 between red and blue. The active programming mode continues to be displayed by the "Prog" message in the display of the TSM. When a TSEM is connected, the backlighting and the operation LED flash when the TSM is in programming mode.

1.3 Accessories

Cover kit 2-gang

Cover kit 4-gang

Room controller extension module 2-gang

Push-button extension module, 1-gang

Push-button extension module, 2-gang

Push-button extension module, 3-gang

Push-button extension module, 4-gang

External sensor

Art. No. ..502TSA..

Art. No. ..504TSA..

Art. No. ..5178TSEM

Art. No. ..5091TSEM

Art. No. ..5092TSEM

Art. No. ..5093TSEM

Art. No. ..5094TSEM

Art. No. FF7.8

2 Installation, electrical connection and operation

2.1 Safety instructions



Electrical devices may only be mounted and connected by electrically skilled persons.

Failure to observe the instructions may cause damage to the device and result in fire and other hazards.

Danger of electric shock. Make sure during the installation that there is always sufficient insulation between the mains voltage and the bus. A minimum distance of at least 4 mm must be maintained between bus conductors and mains voltage cores.

Use only the enclosed plastic screws for fastening to the supporting frame! Otherwise safe operation cannot be ensured. Electrostatic discharges can cause defects in the device.

Do not open device or operate it beyond the technical specification.

2.2 Device components

Device components of room controller display compact module

The compact room controller module is available in the 2-gang and 4-gang variants. The device can be integrated into the switch programs A500, LS990 or CD500.

Irrespective of the switch range, the devices make the same button and rocker functions, room temperature controller functions, disabling, scene and alarm signalling functions, as well as status LED functions, available.

There are only differences between the devices of the different switch ranges in the display. The displays of the devices for the LS990 and CD500 switch ranges have the same design and differ from the display of the A500 switch range through a different arrangement of the display information and displayable button function icons.

2.2.1 Front view 2-gang

Device components of room controller display compact module 2-gang

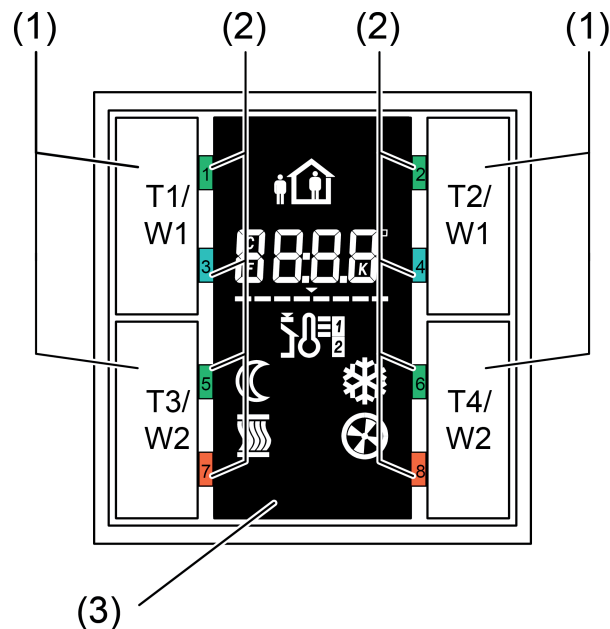

Figure 1: Front view of room controller display compact module 2-gang
(Display: A500 switch range)

- (1) 4 control surfaces configurable as rocker 1...2 or as buttons 1...4
- (2) 8 status LEDs (red, green, blue), can be freely configured
- (3) Display: A500 switch range

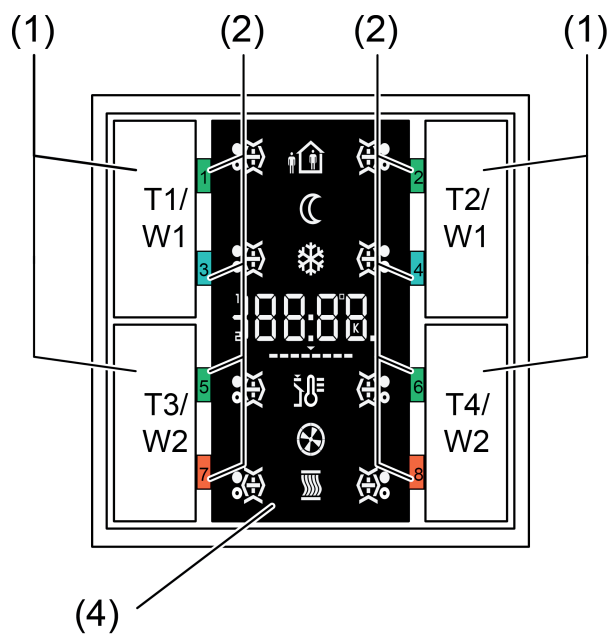

Figure 2: Front view of room controller display compact module 2-gang
(Display: LS990 & CD500 switch range)

(4) Display: LS990 & CD500 switch range

2.2.2 Front view 4-gang

Device components of room controller display compact module 4-gang

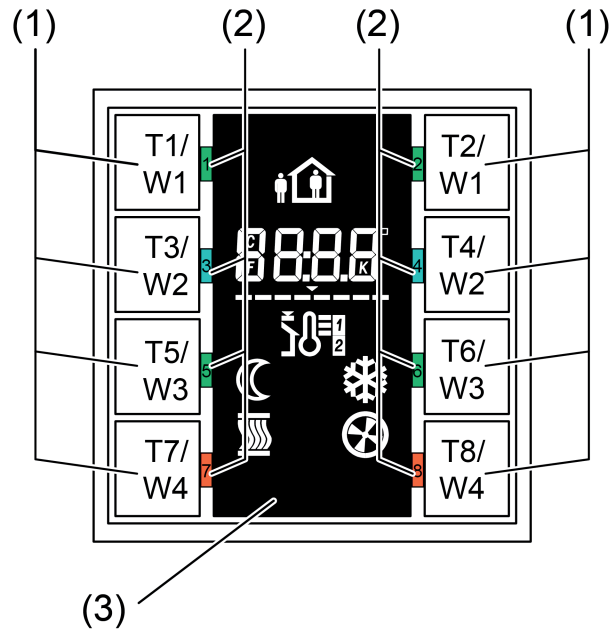

Figure 3: Front view of room controller display compact module 4-gang
(Display: A500 switch range)

- (1) 8 control surfaces configurable as rocker 1...4 or as buttons 1...8
- (2) 8 status LEDs (red, green, blue), can be freely configured
- (3) Display: A500 switch range

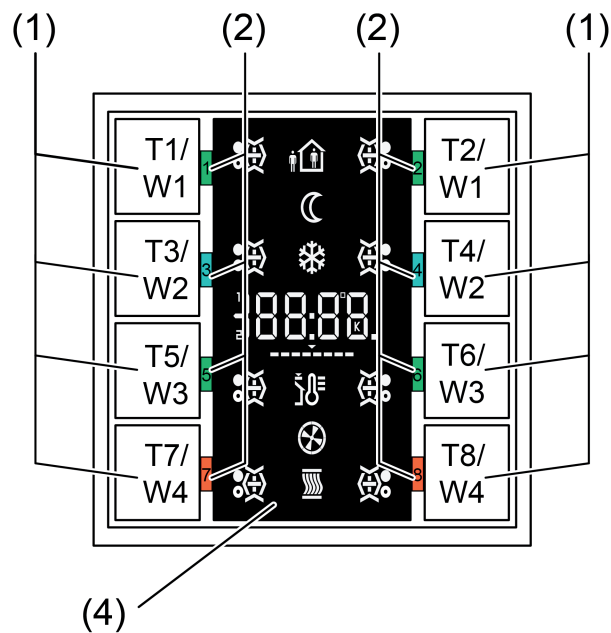

Figure 4: Front view of room controller display compact module 4-gang
(Display: LS990 & CD500 switch range)

(4) Display: LS990 & CD500 switch range

- i The room controller display compact module can be integrated into the switch programs A500, LS990 or CD500.

2.2.3 Rear side

Device components of room controller display compact module rear side

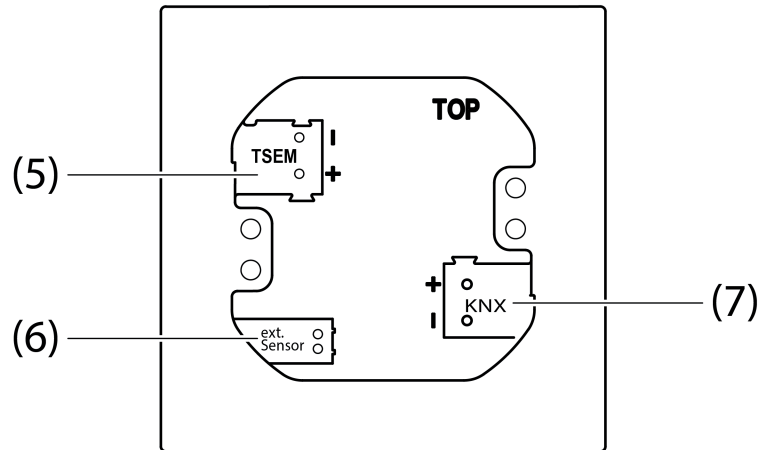

Figure 5: Rear side of room controller display compact module 2-gang/4-gang

- (5) Connection of push-button sensor extension module
Alternatively: Connection of room controller extension module
- (6) Connection of remote sensor (external sensor)
- (7) Connection of KNX bus cable

2.3 Mounting and electrical connection



DANGER!

Electrical shock on contact with live parts in the installation environment.
Electrical shocks can be fatal.

Before working on the device, disconnect the power supply and cover up live parts in the working environment.



DANGER!

Danger of electrical shock!

When mounting with 230 V socket outlets under a common cover there is a danger of electrical shocks in the event of a fault!

Use only the enclosed plastic screws for fastening to the supporting frame!



CAUTION!

Protect the device against electrostatic discharges. Electrostatic discharges occur when the device is operated in a poor installation situation, dependent on the material characteristics of the floor, wall and device cover.

Electrostatic discharges can cause defects in the device.

Use only the enclosed plastic screws.

Mounting and connecting the device

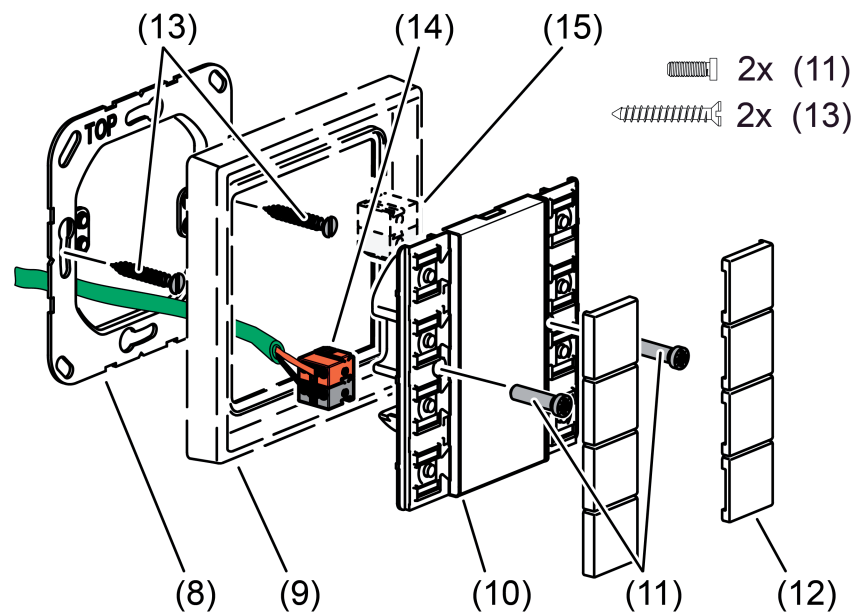

Figure 6: Mounting the room controller display compact module

- (8) Supporting frame
- (9) Design frame
- (10) Room controller display compact module
- (11) Fastening screws
- (12) Design control surfaces
- (13) Box screws

(14) KNX device connection terminal

(15) TSEM device connection terminal

- Mount supporting frame (8) in the right orientation on an appliance box. Note the **TOP** marking. Use the enclosed box screws (13).
- Position the design frame (9) on the supporting frame.
- Connect the room controller display compact module (10) with KNX device connection terminal (14), which is connected to the KNX bus line, on the rear side of the module. Run the connection cable downwards from the room controller display compact module and then into the appliance box from the rear.
- Push the room controller display compact module onto the supporting frame.
- Fix the room controller display compact module to supporting frame using the supplied plastic screws (11). Tighten the plastic screws only lightly.

Connecting and fitting the room controller display compact module with push-button sensor extension module

A pushbutton sensor extension module (TSEM) or, alternatively, a room controller extension module (TSEM) can be connected to a compact room controller module (TSM). The white-yellow wire pair of the bus line, or alternatively a separate cable, can be used as the connection cable. When connecting, make sure the polarity is correct (e.g. on the TSM and TSEM yellow = "+", white = "-").

- i** When the white-yellow wire pair of the bus line is used as the connection cable, the two-wire pair can only connect one TSM and one TSEM to each other along the shortest path. Leading the two-wire pair electrically into the system, e.g. to connect additional push-button sensor modules with each other, is not permitted! Leading further is also not permitted, if this results in total cabling paths of longer than is permitted (max. 30 m).
- i** The white-yellow wire pair of the bus line must not be used to connect room controller display compact modules, if these wires are already used to fulfil other tasks of the KNX installation (e.g. additional power supply for specific bus devices). In this case, a separate connection line is to be used. This is especially to be heeded when retrofitting an existing KNX system.

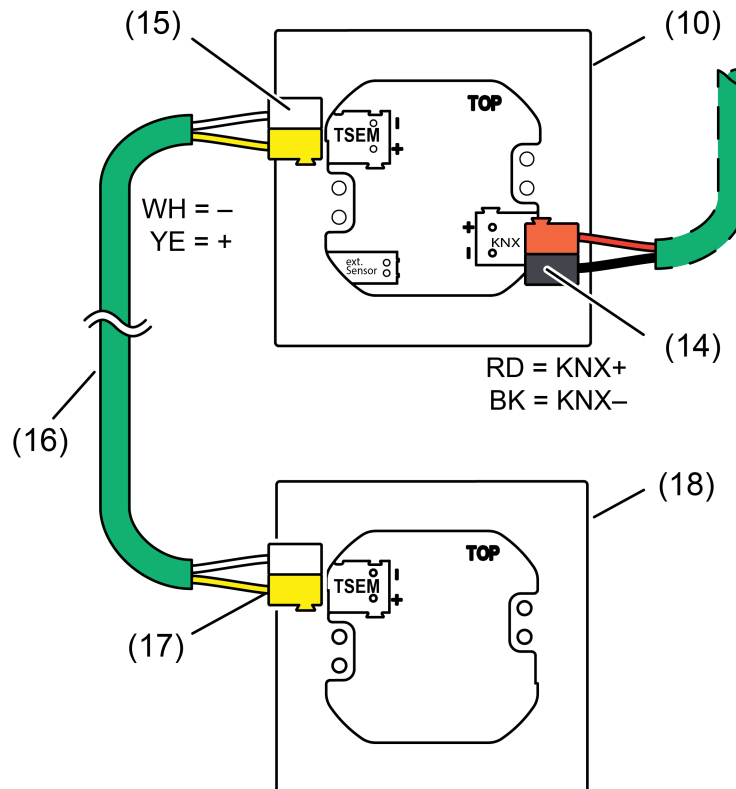

Figure 7: Connection of push-button sensor extension module
Alternatively: Room controller extension module (rear view)

- (10) Room controller display compact module
- (14) KNX device connection terminal
- (15) Connection terminal for connecting an extension module to TSM, white-yellow
- (16) Connection line for extension module
- (17) Terminal for extension module on TSEM, white-yellow
- (18) Push-button sensor extension module
Alternatively: Room controller extension module

The TSEM (pushbutton sensor extension module or room controller extension module) can either be mounted in a flush-mounted device combination or also set into a flush-mounted box. Maximum total length of connection line between room controller display compact module and sensor extension module: 30 m.

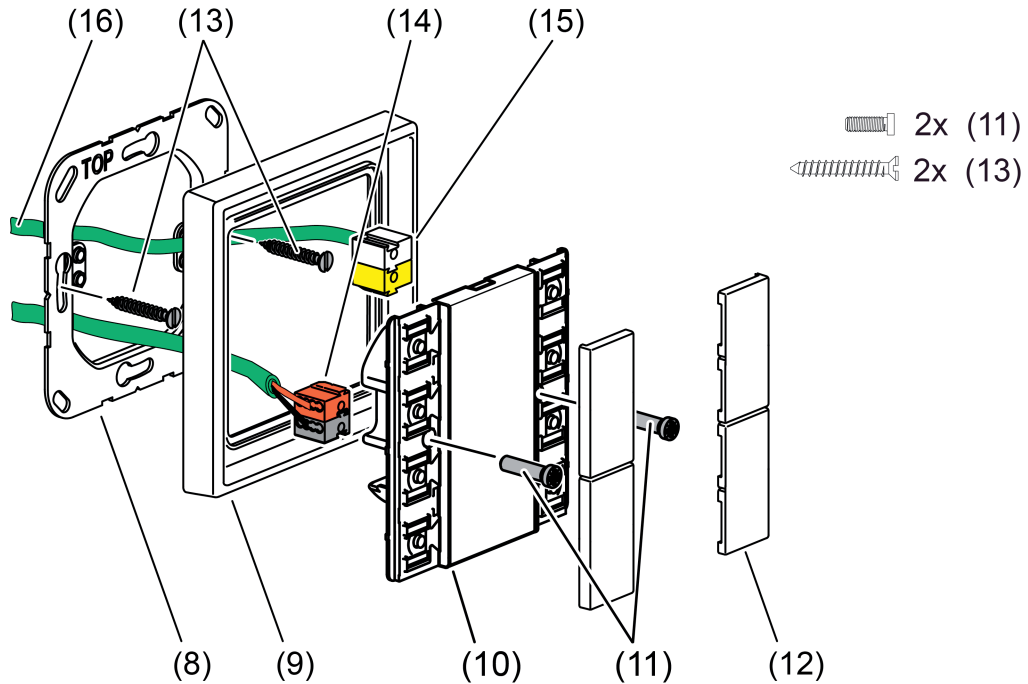

Figure 8: Mounting the compact room controller module with connection of an extension module

- (8) Supporting frame
- (9) Design frame
- (10) Room controller display compact module
- (11) Fastening screws
- (12) Design control surfaces
- (13) Box screws
- (14) KNX device connection terminal
- (15) TSEM device connection terminal
- (16) Connection line for TSEM

The compact room controller module and the extension are mounted in more or less the same manner:

- Mount supporting frame (8) in the right orientation on an appliance box. Note the **TOP** marking. Use the supplied box screws.
- Lead the bus line and connection line out of the box and through the supporting frame (8) and design frame (9).
- Push design frame (9) onto supporting frame (8).

On the compact room controller module (10):

- Connect the KNX bus line with red-black KNX device connection terminal (14) to the "**KNX**" slot at the back.
- Connect the connection line (16) with white-yellow device connection terminal (15) to the "**TSEM**" slot at the back.

On the TSEM (17) (pushbutton sensor extension module or room controller extension module):

- Connect the connection line (16) with white-yellow device connection terminal (15) to the "**TSEM**" slot at the back.
- Attach the push button module onto the supporting frame (8).

- Fix push-button sensor module to supporting frame using the supplied plastic screws (11). Tighten the plastic screws only lightly.

Installing the decorative control surfaces

- Place the Design control surfaces individually on the device. For the arrangement of the Design control surfaces, see "Device components" (figure 6)
- When a Design control surface is in the correct position, engage it by pushing it briefly.

2.4 Commissioning

After connection and mounting, the room controller display compact module can be put into operation. The commissioning is basically confined to programming with the ETS and attaching the decorative control surfaces.

- i** The extension module does not receive any physical address of its own. It is activated by the application program loaded in the TSM.

Programming the physical address

The device does not have a separate programming button or LED. Programming mode is activated by a defined and time-delayed press of the upper left and lower right of the actuation points. The active programming mode on the TSM is indicated by changing the colour of status LED 1 and status LED 2 between red and blue with a frequency of about 4 Hz. An active programming mode is displayed by the "Prog" display. An extension module signals an active programming mode by the labelling panel and the operation LED flashing. To program the physical address, the decorative control surfaces can be snapped onto the device.

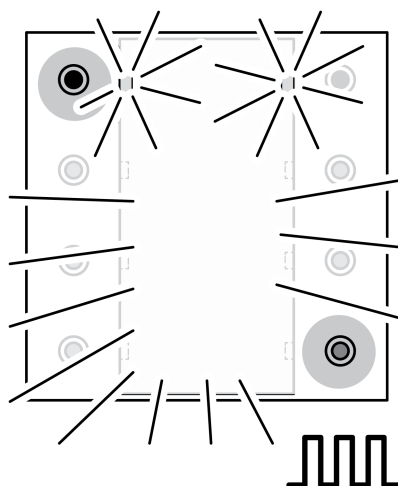

Figure 9: Actuation points for activating programming mode

- i** If the device does not contain an application program - or contains the wrong one - the top two status LEDs 1 and 2 change their colour between red, off, blue and off, at a frequency of around 0.75 Hz as an error display. The word "LEEr" is displayed when empty. If a push-button sensor extension module is connected, the operation LED (colour: blue) and the labelling field illumination of the module flashes slowly.

For commissioning, the TSM must be connected and the bus voltage switched on.

- Activate Programming mode. Press the actuation point at the top left (1) on the TSM and keep it depressed (figure 9). Then press the second actuation point at the lower right (pushbutton element 8) (figure 10).

Programming mode is activated. Both upper status LEDs (status LED 1 and 2) change their colour between red and blue with a frequency of about 4 Hz. If a extension module is connected, its operation LED flashes quickly (approx. 8 Hz). If connected, the active programming mode is still displayed by the flashing labelling field illumination of the TSEM.

- i** Use suitable objects to push the actuation points (e.g. thin screwdriver, tip of a ballpoint pen, etc.).

- i** To exclude any inadvertent activation of Programming mode during 'normal' use of the control surface in later operation, the time between the first and the second actuation must be at least 200 ms. Pressing simultaneously (time between first and second actuation < 200 ms) will not result in an activation of Programming mode!
 - Program the physical address with the help of the ETS.
 - Programming mode ends:
 - Automatically after adoption of the physical address
 - By pressing a button on the TSM
- i** If Programming mode is to be activated or deactivated in a device which is already programmed with a valid application, there is the possibility that telegrams will be transmitted to the bus at the time the button is pressed. The telegram transmitted depends on the button function programmed.
- i** The extension module does not receive any physical address of its own. It is activated by the application program loaded in the TSM. The programming mode cannot be activated or deactivated on the extension module.

When programming mode is active, the extension module can be operated normally. Then the telegrams corresponding to the project design are also transmitted to the bus.

Programming the application program

Program the application into the device with the help of the ETS. Commissioning using ETS5 or ETS4.2 is possible.

The ETS detects automatically whether a valid application has already been programmed into the device before. To reduce the programming time, the ETS downloads the whole application only if the device was programmed beforehand with another application or with no application at all. In all other cases, the ETS makes a time-optimised partial download in which only the modified data is loaded into the device.

Installing the decorative control surfaces

The decorative control surfaces are available as a complete set of buttons. Individual buttons or the complete set of buttons can be replaced using buttons with icons.

The design control surfaces are not included in the scope of supply of the device or the extension module. These must be ordered specially according to the required design.

- Place control surfaces on the device in the right orientation and also on the extension module (if used), and snap in with a short push.

2.5 Operation

The device possesses 8 mechanically separated pushbutton elements. The operating areas are the pushbutton elements combined under an attached design cover. Irrespective of the device variant, the device always possesses eight pushbutton elements. In the 2-gang device variant, 2 pushbutton elements are always combined to form a control surface. The pushbutton elements are visible when no design covers are attached. In the 2-gang device variant, two pushbutton elements are always combined to form a button. Using pushbutton elements 1 and 2, (figure 10) it is possible to operate the operation level and the menu level of the display. For this reason, full-surface operation of rocker 1 is not possible when the menu level is enabled. Depending on the configuration, it is possible to implement a change of the display using each button.

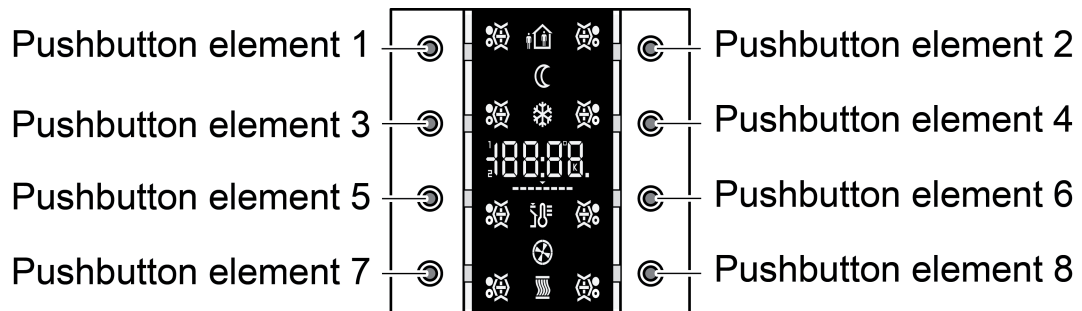

Figure 10: Arrangement of the pushbutton elements

The function of the control surfaces can also be configured in the ETS to any desired pushbutton sensor function. Alternatively, it is possible to set operation of the integrated room temperature controller or change the display. In addition, simultaneous actuation of pushbutton elements 1 and 2 allows activation of the menu level (see chapter 2.5.2. Menu level). Pushbutton elements 1 to 4 operate the activated menu level.

The push-button sensor function is an independent function section of the device with its own parameter blocks in the ETS. Insofar as the control surfaces are to operate one of the integrated room temperature controller, the following functions can be parameterised in the pushbutton configuration: setpoint shift, presence button, operating mode change-over, fan control. For a more detailed description of the operating functions, please see this documentation.

The operation concept can be configured in the ETS either as a rocker function or alternatively as a button function. With the rocker function, two neighbouring control surfaces are combined into one rocker. In the button function, each control surface is evaluated as single-area operation.

If two control surfaces are used as a rocker function, then, depending on the configuration, it is also possible to trigger special functions through "full-surface operation" of the rocker. For this, both control surfaces should be actuated simultaneously. If the menu level is enabled, full-surface operation of rocker 1 is not possible, because rocker 1 is intended for recall of the menu level.

Optionally, the number of control surfaces can be expanded to include up to 8 additional control surfaces by connecting an extension module to the device. The configuration and commissioning of the extension module are clearly structured and easy to perform using the application program of the room controller display compact module. The control surfaces of the extension module can be set in the ETS to any desired pushbutton sensor function, or also to controller operation.

The device possesses eight status LEDs. The status LEDs are executed in three colours and can – according to choice, in either red, green or blue – be switched on or off permanently or

can function as an operation display or as a status display. Furthermore, different statuses of the internal controller can be displayed. As an alternative, with the aid of separate communication objects, they can signal widely varying display information completely independently of the pushbutton function, e.g. operation states of fault messages or also room temperature controllers, the results of logic value comparisons, flash or be permanently switched on or off. Each colour of a status LED can be controlled either by three separate objects or alternatively by a mutual object (superimposed function), so that traffic light functions can also be implemented, - for example, depending on a limiting value - by means of an LED.

Moreover, the device has functions which are not linked directly with the rockers or buttons. These include the thermostat extension function, pushbutton function disable, the internal scenes and the display of alarm signals.

2.5.1 Operating level

Up to 17 pieces of display information (actual temperature, setpoint temperature, outdoor temperature, any temperature) can be optionally displayed on the LC display in the basic display of the device with the room temperature controller icons. The information is shown separately on the display. It is possible to change over between the information automatically after set times or in a controlled manner by pressing a button on the device (see chapter 4.2.4.2.2. Display control). These properties, and the actually visible display information, are configured in the ETS before the device is commissioned (see chapter 4.2.4.2.1. Displayed information)

- i The temperatures can be displayed in °C or alternately in °F. The display format can be configured in common for all temperature values in the ETS.

2.5.2 Menu level

The menu level makes it possible to make various basic settings on the unit locally without using the ETS. In order to avoid the unintentional disruption of essential functions, access to individual settings or to the entire menu level can be prevented via the parameterisation in the ETS. An active button disable also disables access to the menu level.

- i** Access to the menu level is also disabled when buttons 1 to 4 are not assigned to the button disable.

Recalling the menu level

The menu level is recalled by pressing buttons 1 and 2 on the device simultaneously (figure 11).

Exiting the menu level

The device leaves the menu level again when buttons 1 and 2 are pressed again simultaneously. In this case, depending on the setting of the ETS parameter "Save changes after manual exit", all the settings made are saved or rejected. The parameters "Automatic exit of the menu level", "Time until automatic exit of the menu level" and "Save changes after automatic exit" define whether the device terminates the menu level automatically if no entries are made, and whether in this case all of the changed settings are saved or discarded.

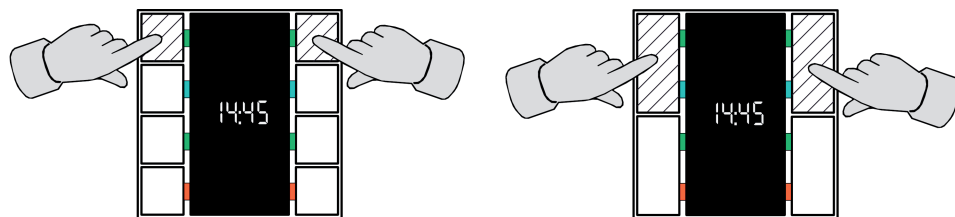

Figure 11: Button combination to recall the menu level
(Left: 4-gang device variant, right: 2-gang device variant)

Operation in the menu level

The settings in the menu level are organised in a ring-shaped menu. This is shown in the display. Selection and settings are performed using the 1...4 buttons of the device.

The following graphic depicts the functions within the menu level, using the example of display brightness adjustment. The graphics show the display for the LS990 and CD500 switch ranges. The four buttons have the following functions:

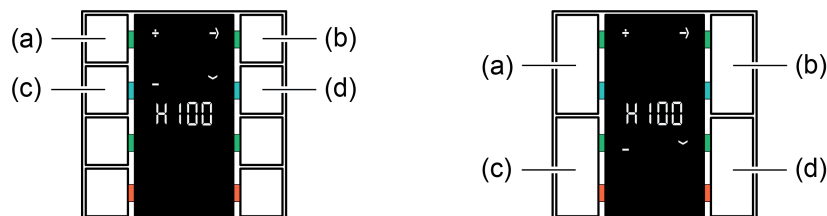

Figure 12: Button functions in the menu level
(Left: 4-gang device variant, right: 2-gang device variant)

- (a) Positive value adjustment
- (b) Jump to the menu item / jump back to the menu level

- (c) Negative value adjustment
- (d) Jump to the next menu entry

i Continuous adjustment of the value settings is possible if buttons 1 or 2 are held in the depressed position.

Project design in the ETS offers various options for influencing the entries that are visible and changeable in the menu:

1. If entries are configured via parameterisation as "hidden", they do not appear in the menu. This setting is performed in the ETS separately for various menu entries in the parameter node "General -> Basic settings -> Menu level". Some entries are always visible and can thus not be configured as invisible in the ETS. When the device functions as a controller extension, controller settings (setpoint temperatures, setpoint shifting, operating mode, fan control) are fundamentally not accessible in the menu level.

2. The setpoint temperatures of the controller can either be changeable, or can alternatively only show the current value and thus not be changeable. This setting is performed in the ETS in the parameter node "General -> Basic settings -> Menu level".

The menu entry that is shown as the first entry when the menu level is called up can be selected in the ETS using the parameter "First menu item in menu level". The sequence of the subsequent entries is then fixed as shown below.

The following menu functions can be called up in the menu level, if not explicitly disabled in the ETS. The icons shown in the display indicated which function or which temperature value is displayed or set.

Indicating the time:

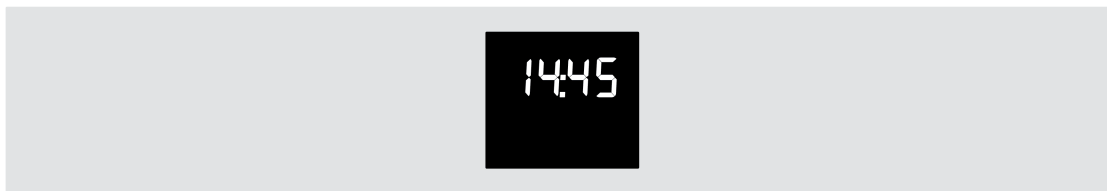

Figure 13: Indicating the time

Only indication of the current time. No adjustment possibility.
The menu entry "Time" is visible as an option.

Indication of actual temperature:

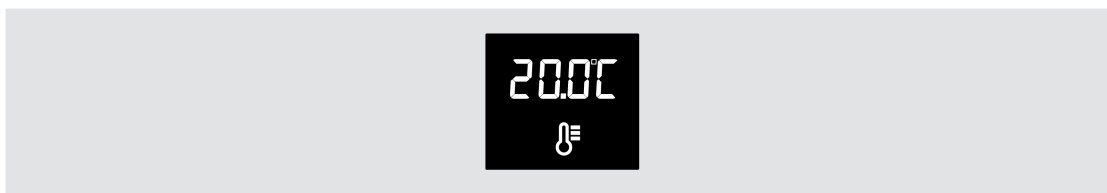

Figure 14: Indication of actual temperature

Only display of the actual temperature received via object. No adjustment possibility.
The menu entry "Actual temperature" is visible as an option.

Indication of setpoint temperature:



Figure 15: Indication of setpoint temperature

Only display of the setpoint temperature received via object. No adjustment possibility.
The menu entry "Setpoint temperature" is visible as an option.

Indicating the outdoor temperature:



Figure 16: Indicating the outdoor temperature

Only display of the outdoor temperature received via object. No adjustment possibility.
The menu entry "Outdoor temperature" is visible as an option.

Display of up to any three temperatures:



Figure 17: Display of any temperatures 1 to 3

Only display of any temperature 1 to 3 received via the object. No setting option.
The menu entry "Any temperature n" is visible as an option.

Display for recalling the Controller 1 and 2 submenu:



Figure 18: Display for recalling the Controller 1 and 2 submenu

Display of the Controller 1 and Controller 2 submenu. Actuating button 2 jumps to this submenu. The menu entry "Controller *n* submenu" is visible as an option.

Display for recalling the display settings:



Figure 19: Display for recalling the display settings

Display of the submenu of the display settings. Actuating button 2 jumps to this submenu. The menu entry "Display settings" is visible as an option.

Setting the basic temperature / comfort temperature (Controller *n* submenu):

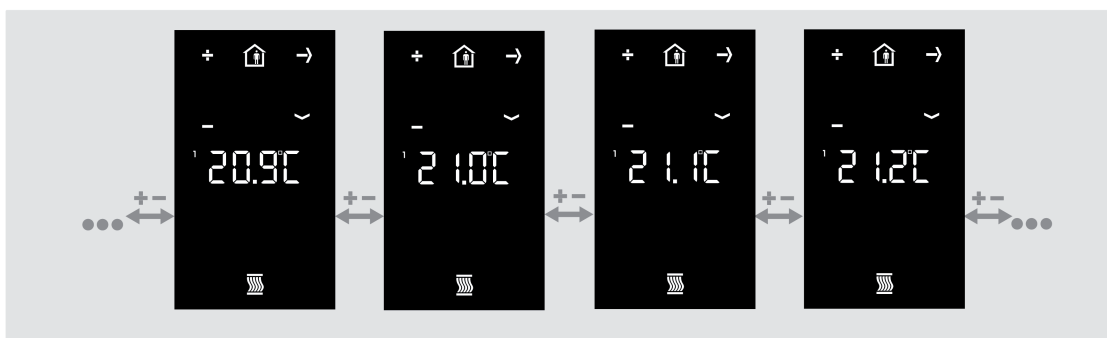



Figure 20: Setting the basic temperature / comfort temperature

The + and - buttons can be used to adjust the basic temperature / comfort temperature in step width of +/- 0.1 K. The icons  and  are illuminated in the display. The basic temperature / comfort temperature is displayed flashing as an absolute value in °C or °F (parameter-dependent).

The basic temperature designates the comfort setpoint temperatures for heating and cooling, depending on the configured operating mode. With "Heating only" it sets the setpoint temperature for comfort heating directly. With "Cooling only", on the other hand, it sets the setpoint temperature for comfort cooling. With "Heating and cooling" the basic setpoint sets the setpoint temperature for heating directly or indirectly depending on the deadband position. The setpoint temperature for cooling is then derived from this, taking the deadband into account.



(see chapter 4.2.4.3.5. Temperature setpoints)

The menu entry "Basic temperature / comfort temperature" is visible as an option as a component of the Controller *n* submenu. The editing function can be disabled separately. This menu is not accessible in controller extensions.

Setting the setpoint temperature "Lowering for standby mode, heating" ("Controller *n*" submenu):



Figure 21: Setting the setpoint temperature "Lowering for standby mode, heating"



The + and - buttons can be used to adjust the temperature decrease for standby mode for heating with a step width of +/- 0.1 K. The icons  and  are illuminated in the display. The temperature decrease is displayed flashing as a relative value in K.

The menu entry "Setpoint temperature heating standby" is optionally visible as a component of the "Controller *n*" submenu. The editing function can be disabled separately. This menu is not accessible in controller extensions.

Setting the setpoint temperature "Raising for standby mode, cooling" ("Controller *n*" submenu):



Figure 22: Setting the setpoint temperature "Raising for standby mode, cooling"

The + and - buttons can be used to adjust the temperature increase for standby mode for cooling with a step width of +/- 0.1 K. The icons  and  are illuminated in the display. The temperature increase is displayed flashing as a relative value in K.

The menu entry "Setpoint temperature raising standby" is optionally visible as a component of the "Controller *n*" submenu. The editing function can be disabled separately. This menu is not accessible in controller extensions.

Setting the setpoint temperature "Lowering for night mode, heating" ("Controller *n*" submenu):



Figure 23: Setting the setpoint temperature "Lowering for night mode, heating"

The + and - buttons can be used to adjust the temperature decrease for night mode for heating with a step width of +/- 0.1 K. The icons ☾ and ☿ are illuminated in the display. The temperature decrease is displayed flashing as a relative value in **K**. The menu entry "Setpoint temperature lowering night" is optionally visible as a component of the "Controller *n*" submenu. The editing function can be disabled separately. This menu is not accessible in controller extensions.

Setting the setpoint temperature "Raising for night mode, cooling" ("Controller *n*" submenu):



Figure 24: Setting the setpoint temperature "Raising for night mode, cooling"

The + and - buttons can be used to adjust the temperature increase for night mode for cooling with a step width of +/- 0.1 K. The icons ☾ and ☿ are illuminated in the display. The temperature increase is displayed flashing as a relative value in **K**. The menu entry "Setpoint temperature raising night" is optionally visible as a component of the "Controller *n*" submenu. The editing function can be disabled separately. This menu is not accessible in controller extensions.

Setting presence mode ("Controller *n*" submenu):

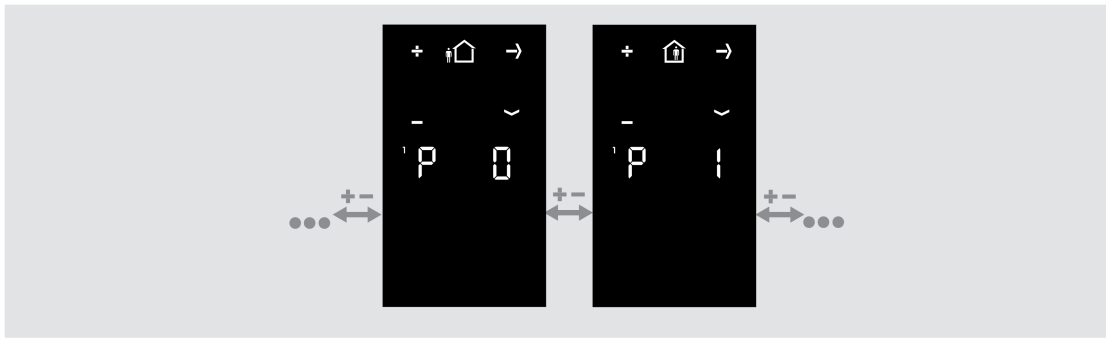





Figure 25: Setting presence mode

A "P" is shown in the display to indicate that the presence mode can be edited. "P 0" displays that no presence is active. "P 1" stands for active presence. The icons additionally shown in the display identify the active operating mode of the internal room temperature controller. Depending on this, presence mode can be adjusted as follows using the + and - buttons.



"Comfort" operating mode active:

No setting of presence mode is possible. The  icon lights up statically.



"Standby" operating mode active:

The buttons + or - can be used to change over the operating mode between Comfort  and Standby . In each case, the icons activated by the Presence operating mode flash.

"Night" operating mode active:

The buttons + or - can be used to change over the operating mode between Night  and Comfort extension . In each case, the icons activated by the Presence operating mode flash.

"Frost/heat protection" operating mode active:

The buttons + or - can be used to change over the operating mode between Frost/heat protection  and Comfort extension . In each case, the icons activated by the Presence operating mode flash.

 The comfort extension cannot be activated using the presence function in the menu level if the frost/heat protection has been activated via the window status!

 In the menu level, presence mode and operating mode (see "Setting the operating mode" below) may never be changed at the same time before a "save" command. Otherwise the presence status is always reset, and thus the manual setting may not be applied. If the controller operating mode and the presence mode have to be changed, first the operating mode has to be changed and the setting has to be saved. Only after that is it possible to change the presence mode and save this setting by calling up the menu level again.

The menu entry "Presence" is visible as an option. This menu is not accessible in controller extensions.

Setting the setpoint shift ("Controller n" submenu):



Figure 26: Setting the setpoint shift

The menu entry for setpoint shifting is indicated in the display by the bar scale "- - - - -". The buttons + and - can be used to adjust the basic setpoint shift by up to 4 levels. Here the shift is shown in the display as a relative numeric value in kelvin (K)

The step width of the shift depends on the ETS parameter "Increment of the 4-level setpoint shift" in the parameter branch "Room temperature controller -> Controller general -> Setpoints".

- i** A setpoint shift cannot be saved when the menu level is exited if the frost/heat protection is activated in the controller! In this case the settings of the setpoint shift in the menu level are lost.

The menu entry "Setpoint shift" is visible as an option. This menu is not accessible in controller extensions.

Setting the operating mode ("Controller n" submenu):







Figure 27: Setting the operating mode

The buttons + and - can be used to adjust the controller operating mode.

The set operating mode is indicated in the display by the following codes:

- b Co = Operating mode Comfort
- b Sb = Operating mode Standby
- b Ni = Operating mode Night
- b FH = Operating mode Frost/heat protection

The icons additionally shown in the display identify the active operating mode of the internal room temperature controller. The modes that can be set are "Comfort" , "Standby" , "Night"  and "Frost/heat protection" .

It should be noted that a set operating mode with a low priority cannot be activated immediately when the menu level is exited if an operating mode with a higher priority (e.g. frost protection via

window status) has been specified by the controller.(see chapter 4.2.4.3.4. Operating mode switchover). The operating mode set in the menu level is only accepted by the controller when the operating mode with a higher priority has been terminated and in the meantime no other operating mode specification with a higher priority has been performed (e.g. via operation of a pushbutton sensor or via communication objects).

The menu entry "Operating mode" is visible as an option. This menu is not accessible in controller extensions.

Fan controller ("Controller n" submenu):

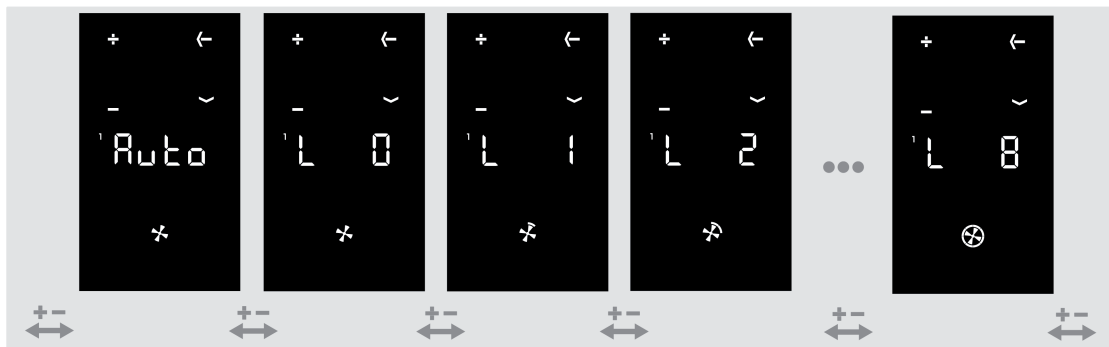

Figure 28: Fan controller

The + and - buttons can be used to influence the fan operating mode (automatic / manual mode). In manual mode, it is possible to change over the fan level independently of the controller command values (see chapter 4.2.4.3.7. Fan controller).

The set fan level is indicated in the display by the following codes:

- Auto = Automatic mode
- L 0 = Fan level 0 (manual operation)
- L 1 = Fan level 1 (manual operation)
- L 2 = Fan level 2 (manual operation)
- L 3 = Fan level 3 (manual operation)
- L 4 = Fan level 4 (manual operation)
- L 5 = Fan level 5 (manual operation)
- L 6 = Fan level 6 (manual operation)
- L 7 = Fan level 7 (manual operation)
- L 8 = Fan level 8 (manual operation)

The additionally flashing icon in the display indicates the current fan level by means of the illuminated arc segments (✱, ✱, ✱, ✱ etc.). If no arc segment is illuminated, the fan is switched off. The number of illuminated arc segments depends on the number of fan levels configured.

i In fan control in the menu level the fan level and automatic mode can be set directly without taking into account the specific settings of the fan controller (Parameter "Fan level on change-over to manual", the switch-on level or fan run-on times).

The menu item "Fan levels" is visible as an option, but only if the fan control is also enabled in the controller for the ETS. This menu is not accessible in controller extensions.

Recall the display pixel text ("Display settings" submenu):



Figure 29: Pixel text in the design ranges LS and CD

All the segments are switched on in the display. The view to be expected in the design ranges LS and CD during the pixel test is shown (figure 29).

The view to be expected in the design range A500 during the pixel test is shown (figure 30) below.



Figure 30: Pixel text in the design range A500

Setting the display brightness ("Display settings" submenu):



Figure 31: Setting the display brightness

"H" and the brightness value of the backlighting are displayed in the backlighting. The buttons + and - can be used to adjust the brightness of the display in the range from 5 to 100%. For additional notes about control of the backlighting, via the menu level, please see the chapter "Display control" (see page 94-95). The menu item "Display brightness" is visible as an option.

Exiting the menu level with saving:



Figure 32: Exiting the menu level with saving

"Stor" is displayed. The button 2 can be used to exit the menu level with a "save" command (see "Exiting the menu level"). This option is always visible.

Exiting the menu level without saving:



Figure 33: Exiting the menu without saving

"ESC" is shown on the display. Button 2 can be used to exit the menu level without saving the settings (see "Exiting the menu level"). This option is always visible.

- i** All menu entries are displayed or not depending on the configuration of the ETS. If, for example, the controller is parameterised only for heating, no setpoints for cooling can be displayed or set in the menu. When the device functions as a controller extension, controller settings (setpoint temperatures, setpoint shifting, operating mode, fan control) are fundamentally not accessible in the menu level.
If an entry has been parameterised as the first menu item in the ETS that is not accessible at all due to the other settings, the first possible entry is displayed according to the defined menu sequence (see above).
- i** When a menu entry is shown on the display, the setting currently valid in the controller is identified using the icons or the display value, if the setting has not already been changed previously in the menu level. If the setting has already been changed and not yet accepted validly (see "Exiting the menu level"), the last manual setting will be shown on the display, and not the real state of the controller.

Exiting the menu level

Settings that have been made in the menu level are only accepted validly in the device when the menu level is exited with a "Save" command. It is possible to discard settings by exiting the menu level without a "Save" process.

When exiting the menu level, a distinction is made among the following cases:

- Exiting by means of button combination: The menu level is exited by pressing buttons 1 and 2 on the device simultaneously. The parameter "Save changes after manual exiting" defines whether the settings are saved or not when the menu level is exited using the button combination (button 1 and button 2 simultaneously).
- Automatic exiting: Automatic exiting of the menu level can optionally be configured in the ETS using the parameter of the same name in the parameter branch "General -> Basic settings -> Menu level". In this case the device leaves the menu level when no additional operation takes place after the last push-button operation within the "Time until automatic manu level exit" configured in the ETS. With automatic exiting, it is also possible to define with the parameter "Save changes after automatic exiting" whether the settings are saved or not.
- Exiting with "**Stor**": In the menu level the menu item "**Stor**" can be selected with the button 4. The button 2 can then be used to exit the menu level. All settings are always saved in this case!
- Exiting with "**ESC**": In the menu level the menu item "**ESC**" can be selected with the button 4. The button 2 can then be used to exit the menu level. In this case the settings are not saved and are discarded!

3 Technical data

General

Protection class	III
Test mark	KNX/EIB
Ambient temperature	-5 ... +45 °C
Storage/transport temperature	-25 ... +70 °C

KNX/EIB supply

KNX medium	TP
Commissioning mode	S-mode
Rated voltage KNX	DC 21 ... 32 V SELV
Current consumption KNX without TSEM	max. 15 mA
with TSEM	max. 20 mA

Connection of the extension module

Number	1
Cable length	max. 30 m
Cable type	J-Y(St)Y 2 x 2 x 0.8 mm

Connecting remote sensor

Cable length remote sensor	max. 50 m
----------------------------	-----------

4 Software description

4.1 Software specification

ETS search paths: - Heating, A/C, Ventilation / Regulator / Room controller display compact module 2-gang
 - Push-button / Push-button, general / Room controller display compact module 2-gang
 - Heating, A/C, Ventilation / Regulator / Room controller display compact module 4-gang
 - Push-button / Push-button, general / Room controller display compact module 4-gang

Configuration: S-mode standard

Application programs for device versions A5192KRMTSD and A5194KRMTSD:

No.	Short description	Name	Version	from mask version
1	Multifunctional room temperature controller / push-button sensor application: 4 control surfaces on the room controller module for the pushbutton sensor function and for operation of the integrated room temperature controller. Can be expanded to include 8 additional control surfaces using an extension module. This application program is compatible with the following versions of the firmware: 1.04, 1.05, 1.06, 1.07 and 1.08. Compatible devices have the marking "V0.2" or "V1.2".	Room controller display compact module 146D11	1.1 for ETS 4.2 and ETS 5	705
2	Optimization of the multifunctional room temperature controller / push-button sensor application: Optimization of the time display and correction of the "Bus current" value displayed in the ETS. This application program is compatible with the following versions of the firmware: 1.04, 1.05, 1.06, 1.07 and 1.08. Compatible devices have the marking "V0.2" or "V1.2".	Room controller display compact module 146DA0	A.0 for ETS 4.2 and ETS 5	705

3	No change in the multifunctional room temperature controller / push-button sensor application:	Room controller display compact module 146DA1	A.1 for ETS 4.2 and ETS 5	705
---	--	---	---------------------------	-----

A microcontroller was replaced.

This application program is compatible with the following version of the firmware: 1.09.
Compatible devices have the marking "V2.3".

Application programs for device versions LS5192KRMTSD/CD5192KRMTSD and LS5194KRMTSD/CD5194KRMTSD:

No.	Short description	Name	Version	from mask version
1	Multifunctional room temperature controller / push-button sensor application: 8 control surfaces on the room controller module for the pushbutton sensor function and for operation of the integrated room temperature controller. Can be expanded to include 8 additional control surfaces using an extension module. This application program is compatible with the following versions of the firmware: 1.04, 1.05, 1.06, 1.07 and 1.08. Compatible devices have the marking "V1.3" or "V2.3".	Room controller display compact module 146F11	1.1 for ETS 4.2 and ETS 5	705
2	Optimization of the multifunctional room temperature controller / push-button sensor application: Optimization of the time display and correction of the "Bus current" value displayed in the ETS. This application program is compatible with the following versions of the firmware: 1.04, 1.05, 1.06, 1.07 and 1.08. Compatible devices have the marking "V1.3" or "V2.3".	Room controller display compact module 146FA0	A.0 for ETS 4.2 and ETS 5	705

- | | | | | |
|---|--|---|---------------------------------|-----|
| 3 | No change in the multifunctional room temperature controller / push-button sensor application: | Room controller display compact module 146FA1 | A.1
for ETS 4.2
and ETS 5 | 705 |
|---|--|---|---------------------------------|-----|

A microcontroller was replaced.

This application program is compatible with the following version of the firmware: 1.09.
Compatible devices have the marking "V3.4".

4.2 Software "Room controller display compact module"

4.2.1 Scope of functions

General functions

- The backlighting can be switched permanently on or off. It can be switched on with a button-press, be switched on during night operation or be switched by a communication object. The brightness of the background illumination can be set within the menu level or optionally via a communication object.
- Integrated scene control. Internal storage of up to eight scenes with eight output channels, recall of internal scenes by means of a presettable scene number, selection of object types for the output channels; for each scene, the storage of the individual output values and the transmission of the output values can be permitted or inhibited; the individual channels can be delayed during scene recall; as scene extension, 64 scenes can be recalled and stored.
- Alarm signal. If the alarm message is activated, all the status LEDs flash red.
- Push button lock. The designed scope of functions ranges from the disabling of all the buttons, through the disabling of individual buttons up to the assignment of a special disabling function behaviour of the buttons.
- The number of control surfaces can be expanded using a push-button sensor extension module.

Display functions

- The backlighting can be switched permanently on or off. It can be switched on with a button-press, be switched on during night operation or be switched by a communication object. The brightness of the background illumination can be set within the menu level or optionally via a communication object.
- Display of a cycle of up to 17 display pages or activated directly via an object. Optionally, the indication can also be switched by pressing a button on the device.
- Display of a temperature optionally combined with the icons of one of the two controller cycles. The following temperatures can be displayed: Actual temperature, setpoint temperature, outdoor temperature, any temperature 1-3.
- In the menu level, actual controller values, setpoint controller values, the controller status, the controller operating mode or the fan levels can be displayed for both controller circuits.
- Display of button function icons for visualisation of the button functions (only in the design ranges LS and CD!).
- Display of menu level
- Programming mode is signalled by the text "Prog" on the display. If a valid application is already loaded into the device and the device is set back into Programming mode, Programming mode is signalled alternately by the text "Prog" and the displayed firmware version (e.g. "A1.00") in the display.
- The display shows the text "LOAD" during an active programming operation.
- In the delivery state, the text "NEU" is shown in the display.
- If the device does not contain an application program - or contains the wrong one - the text "LEER" appears.

Functions of the integrated room temperature controller

- Parallel operation of both controllers is possible.
- Function buttons for operation of the room temperature controller.
- Various operating modes can be activated: Comfort, Standby, Night and Frost/heat protection
- Each operating mode can be assigned its own temperature-setpoints (for heating and/or cooling).
- Configuring the temperature setpoints as relative (derived from basic setpoint) or absolute (independent setpoint temperatures for each operating mode).
- Comfort extension possible using presence button in Night or Frost/heat protection mode. Configurable duration of the comfort extension.
- Operating mode change-over via a 1-byte object according to KNX or using up to 4 individual 1-bit objects.
- Frost/heat protection switchover via window status or by automatic frost protection.
- Display of room temperature controller information via the status LED and the display.
- Operating modes "Heating", "Cooling", "Heating and cooling" each with or without additional level.
- Various control types can be configured for each heating or cooling level: PI control (permanent or switching PWM) or 2-point feedback control (switching).
- Control parameter for PI controller (if desired: proportional range, reset time) and 2-point controller (hysteresis) adjustable.
- The temperature setpoints for the additional level are derived via a configurable level offset from the values of the basic level.
- Automatic or object oriented switch-over between "heating" and "cooling".
- A temporary or permanent setpoint shift for a relative setpoint presetting through operation of the function buttons on the device or via communication objects is possible. Setpoint value shift indication by status LED possible.
- Control of an external fan using an automatic or manual fan controller possible. Status display of the fan controller possible by individual status LEDs. Furthermore, a temporary fan level indication can be implemented via all 8 status LEDs of the TSM.
- Status feedback telegrams (also KNX compliant) can be configured.
- Deactivating the feedback control or the additional level possible using separate 1-bit objects.
- Internal and external temperature sensor for room temperature measurement possible.
- Configurable internal to external determination of measured value and external sensor for room temperature measurement. Settable polling time of the external temperature sensor.
- The room temperature measurement (actual value) can be adjusted separately for the internal and external sensor using parameters.

- The actual and setpoint temperatures can be output on the bus if a configurable deviation is detected (also periodically).
- Separate or shared command value output in heating and cooling mode. This produces one or two command value objects for each level.
- Normal or inverted command value output configurable.
- Automatic transmission and cycle-time for actuating output configurable.
- Command value limit possible.
- Clipping mode (response of the controller to command values = 100 %) can be set.
- Floor temperature limit possible in heating mode. Thus temperature-controlled switch-off of a floor heater as protective function.
- Setpoint temperature limit possible in cooling mode. If necessary, the controller limits the setpoint temperature to specific values and prevents an adjustment beyond statutory limits.
- It is possible to convert the command value output value of the room temperature controller function to a control parameter for a rotation angle of a rotary actuator.

Functions of the integrated controller extension

- Alternatively to the function of the room temperature controller, the extension mode can be activated. This allows control of an external room temperature controller.
- Full control of the controller (operating modes, presence functions and setpoint shift).
- Full-featured indication of the controller status via the status LED of the extension (heating / cooling reporting, setpoint shift, room temperature, setpoint temperature and current operating mode).
- Room temperature measurement also possible on the extension.

Functions of the integrated push button sensor

- Each of the control surfaces can be used as an independent button or – when linked with the opposite button – as a rocker function.
- Each button can be used for the functions: Switching, dimming, Venetian blind, 1-byte value transmitter, 2-byte value transmitter, scene extension, 2-channel operation, Controller extension 1, Controller extension 2, pushbutton sensor controller extension, controller operation controller 1, controller operation controller 2 and change display. An operating mode switchover, comfort extension using a presence button, a setpoint shift and a fan controller can be implemented using the Controller operation function that is used to operate one of the internal room temperature controllers.
- Each rocker can be used for the functions 'switching', 'dimming', 'Venetian blind', '1 byte value transmitter', '2-byte value transmitter', 'scene extension' and '2-channel operation'.
- 2-channel operating function: each rocker or each button can be set for controlling two independent channels. This means that only one button-press is enough to transmit up to two telegrams to the KNX. The channels can be configured independently of one another for the Switching, Value transmitter (1 byte) or Temperature value transmitter (2 bytes) functions.

- For the rocker functions Dimming, Venetian blind (operation concept "Long – Short or Short") and 2-channel operation, full-surface rocker operation can also be evaluated. With full-surface operation, switching telegrams and scene recall requests can be triggered on the KNX in addition to and independently of the configured rocker function.
- The switching function permits the following settings: reaction after pressing and/or releasing, switch on, switch off, and toggle.
- The dimming function permits the following settings: times for short and long actuation, dimming in different levels, telegram repetition on long press, transmission of stop telegram after end of press.
- The shutter control permits the following settings: four different operation concepts with times for short and long press and slat adjustment.
- The 1-byte and 2-byte value transmitter function permits the following settings: selection of the value range (0 ... 100 %, 0 ... 255, 0 ... 65535, 0 ... 1500 lux, 0 ... 40 °C), value on button-press, value change on sustained button-press with different step widths, optional overflow on reaching the end of a value range.
- The controller extension function permits the following settings to operate an external room temperature controller: operating mode change-over with normal and high priority, defined selection of an operating mode, change between different operating modes, change of presence status, setpoint shift.
- The rockers or buttons can be disabled via a 1-bit object. The following settings are possible: polarity of the disabling object, behaviour at the beginning and at the end of disabling. During an active disable, all or some of the rockers / buttons can have no function, can perform the function of a selected button or execute one of two presettable disabling functions.
- A delay to the automatically transmitted communication objects of the controller external after a device reset can be configured. The delay time is automatically produced by the subscriber address (physical address).

LED functions

- The status LED can light up in red, green or blue according to choice. An automatic colour change is also possible depending on the function. When switched-off, the status LEDs can shine in a designed colour, creating an orientation light.
- The brightness of the status LED can be set to five levels. Through night reduction, the brightness of the status LED can be reduced at night using a communication object.
- Possible status LED functions include, among others, "always OFF", "always ON", "button-press display", "Status display", "2-colour status display", "Activation via separate LED object", "Operating mode display", "Controller status display", "Comparator without/with sign (1 byte)" and "Fan controller display".
- The operation LED of the TSEM can be permanently on or off or alternatively be switched via a communication object. The operation LED can light up in red, green or blue according to choice.
- All status LEDs of the device can flash simultaneously in the event of an alarm. The following settings are possible: Value of alarm signalling object for the states alarm / no alarm, alarm acknowledge by actuation of a button, transmission of the acknowledge signal to other devices.

- When a status LED is internally connected with the rocker or the button, it can signal a button-press or the current status of a communication object. The status indication can also be in inverted form. When a status LED is not dependent on the rocker or button, it can be permanently on or off, indicate the status of an independent communication object, the operating state of a room temperature controller or the result of a comparison between signed or unsigned 1 byte values.
- With the enabled standard display function of the compact room controller module, the LED functions of four status LEDs of the basic module are predefined. The standard display function contains the display of the setpoint shift and the temporary fan level display via the status LED.

4.2.2 Notes on software

ETS project design and commissioning

Project design and commissioning of the device with the following ETS versions:

- ETS4.2
- ETS5 or higher

The necessary product database is offered in the *.knxprod format. No product database is available for ETS2, ETS3 and older versions of ETS4.

4.2.2.1 Device generations and using the application programs

There are different device generations and application programs available. It is possible to distinguish between the application programs and device generations by means of the version designation.

- i** Only application programs with the version A.1 or higher can be programmed in devices with device generation V2.3 (A5192KRMTSD and A5194KRMTSD) resp. V3.4 (LS5192KRMTSD/CD5192KRMTSD and LS5194KRMTSD/CD5194KRMTSD) or higher. Application programs with the version 1.1 and A.0 cannot be programmed in devices with the device generation V2.3 (A5192KRMTSD and A5194KRMTSD) resp. V3.4 (LS5192KRMTSD/CD5192KRMTSD and LS5194KRMTSD/CD5194KRMTSD) or higher.
- i** Only application programs with the version 1.1 or A.0 can be programmed in older devices with device generation V1.2 (A5192KRMTSD and A5194KRMTSD) resp. V2.3 (LS5192KRMTSD/CD5192KRMTSD and LS5194KRMTSD/CD5194KRMTSD) or lower. Application programs with the version A.1 or higher cannot be programmed in older devices with the device generation V1.2 (A5192KRMTSD and A5194KRMTSD) resp. V2.3 (LS5192KRMTSD/CD5192KRMTSD and LS5194KRMTSD/CD5194KRMTSD) or lower.
- i** With the ETS function "Update Application Program Version" the parameter settings and group address connections are taken over.

The marking of the device generation is applied to the device.

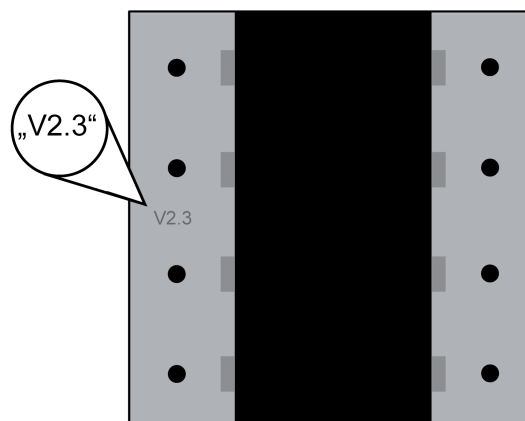



Figure 34: Position and marking of the device generation

4.2.3 Object table

Number of communication objects	Max. 195 objects (4-gang variants with extension module)
Number of addresses (max.):	254
Number of assignments (max.):	255

4.2.3.1 Rockers or button functions

Function:	Switching				
Object	Function	Name	Type	DPT	Flag
 1, 2, 3, 9, 10, ...16	Switching	Rocker/button 1 ^{1,2}	1-bit	1.xxx	C, (R), W, T, - ³
Description	1-bit object for transmission of switching telegrams (ON, OFF).				

Function:	Dimming				
Object	Function	Name	Type	DPT	Flag
 1, 2, 3, 9, 10, ...16	Switching	Rocker/button 1 ^{1,2}	1-bit	1.xxx	C, (R), W, T, - ³
Description	1-bit object for transmission of switching telegrams (ON, OFF).				

Function:	Dimming				
Object	Function	Name	Type	DPT	Flag
 19, 20, 21, 27, 28, 29, ...34	Dimming	Rocker/button 1 ^{1,2}	4-bit	3,007	C, (R), W, T, - ³
Description	4-bit object for the transmission of relative dimming telegrams.				

1: The number of rockers or buttons depends on the planned push-button sensor variant and the push-button sensor extension module. Mixed operation of rocker or button functions in a push-button sensor is possible on the basic module and the extension module.

2: The objects have been described for rocker 1 or button 1 as an example. The objects for the other rockers/buttons and for the module rockers are defined in the same way by shifting the object number and changing the object name.

3: For reading, the R-flag must be set. The last value written to the object via the bus will be read.

Function: Venetian blind

Object	Function	Name	Type	DPT	Flag
□← 1, 2, 3, 9, 10, ...16	Short time operation	Rocker/button 1 ^{1,2}	1-bit	1,007	C, -, -, T, - ₃

Description: 1-bit object for the transmission of telegrams with which a Venetian blind or shutter drive motor can be stopped or with which the blind slats can be adjusted by short time operation.

Function: Venetian blind

Object	Function	Name	Type	DPT	Flag
□← 19, 20, 21, 27, 28, 29, ...34	Long-time operation	Rocker/button 1 ^{1,2}	1-bit	1,008	C, (R), W, T, - ³

Description: 1-bit object for the transmission of telegrams with which a Venetian blind or shutter drive motor can be moved upwards or downwards.

Function: 1-byte value transmitter

Object	Function	Name	Type	DPT	Flag
□← 1, 2, 3, 9, 10, ...16	Value	Rocker/button 1 ^{1,2}	1 byte	5.xxx	C, (R), W, T, - ³

Description: 1-byte object for the transmission of values from 0 to 255 (corresponding to values from 0 % to 100 %). If the adjustment of the value is enabled, the object can transmit telegrams cyclically after long actuation with which the value can be reduced or increased by a presettable amount.

Function: 2-byte value transmitter

Object	Function	Name	Type	DPT	Flag
□← 1, 2, 3, 9, 10, ...16	Value	Rocker/button 1 ^{1,2}	2 byte	7.xxx	C, (R), W, T, - ³

Description: 2-byte object for the transmission of values from 0 to 65535. If the adjustment of the value is enabled, the object can transmit cyclical telegrams after a long press with which the value can be reduced or increased by an adjustable amount.

1: The number of rockers or buttons depends on the planned push-button sensor variant and the push-button sensor extension module. Mixed operation of rocker or button functions in a push-button sensor is possible on the basic module and the extension module.

2: The objects have been described for rocker 1 or button 1 as an example. The objects for the other rockers/buttons and for the module rockers are defined in the same way by shifting the object number and changing the object name.

3: For reading, the R-flag must be set. The last value written to the object via the bus will be read.

Function: 2-byte value transmitter

Object	Function	Name	Type	DPT	Flag
 1, 2, 3, 9, 10, ...16	Temperature value	Rocker/button 1 _{1,2}	2 byte	9,001	C, (R), W, T, - ³

Description 2 -byte object for the transmission of a temperature value from 0 °C to 40 °C. If the adjustment of the value is enabled, the object can transmit telegrams cyclically after a long press with which the value can be reduced or increased by 1 K.

Function: 2-byte value transmitter

Object	Function	Name	Type	DPT	Flag
 1, 2, 3, 9, 10, ...16	Brightness value	Rocker/button 1 ^{1,2}	2 byte	9,004	C, (R), W, T, - ³

Description 2-byte object for the transmission of a brightness level value from 0 to 1500 lux. If the adjustment of the value is enabled, the object can transmit cyclical telegrams after a long press with which the value can be reduced or increased by 50 lux.

Function: Scene extension

Object	Function	Name	Type	DPT	Flag
 1, 2, 3, 9, 10, ...16	Scene extension	Rocker/button 1 _{1,2}	1 byte	18,001	C, -, -, T, - ₃

Description 1-byte object for recalling or for storing one of 64 scenes max. from a scene push button sensor.

Function: 2-channel operation

Object	Function	Name	Type	DPT	Flag
 1, 2, 3, 9, 10, ...16	Channel 1 switching	Rocker/button 1 _{1,2}	1-bit	1.xxx	C, (R), W, T, - ³

Description 1-bit object for transmission of switching telegrams. This object is enabled if 2-channel operation is activated with the function "Switching (1-bit)" for channel 1.

1: The number of rockers or buttons depends on the planned push-button sensor variant and the push-button sensor extension module. Mixed operation of rocker or button functions in a push-button sensor is possible on the basic module and the extension module.

2: The objects have been described for rocker 1 or button 1 as an example. The objects for the other rockers/buttons and for the module rockers are defined in the same way by shifting the object number and changing the object name.

3: For reading, the R-flag must be set. The last value written to the object via the bus will be read.

Function: 2-channel operation

Object	Function	Name	Type	DPT	Flag
 1, 2, 3, 9, 10, ...16	Channel 1 value	Rocker/button 1 _{1,2}	1 byte	5.xxx	C, -, -, T, - ₃

Description 1-byte object to transmit value telegrams. This object is enabled if 2-channel operation is activated with the function "Value transmitter 0...255 (1-byte)" or "Value transmitter 0...100% (1-byte)" for channel 1.

Function: 2-channel operation

Object	Function	Name	Type	DPT	Flag
 1, 2, 3, 9, 10, ...16	Channel 1 temperature value	Rocker/button 1 _{1,2}	2 byte	9,001	C, -, -, T, - ₃

Description 2-byte object to transmit value telegrams. This object is enabled if 2-channel operation is activated with the function "Temperature value transmitter (2-byte)" for channel 1.

Function: 2-channel operation

Object	Function	Name	Type	DPT	Flag
 19, 20, 21, 27, 28, 29, ...34	Channel 2 switching	Rocker/button 1 _{1,2}	1-bit	1.xxx	C, (R), W, T, - ₃

Description 1-bit object for transmission of switching telegrams. This object is enabled if 2-channel operation is activated with the function "Switching (1-bit)" for channel 2.

Function: 2-channel operation

Object	Function	Name	Type	DPT	Flag
 19, 20, 21, 27, 28, 29, ...34	Channel 2 value	Rocker/button 1 _{1,2}	1 byte	5.xxx	C, -, -, T, - ₃

Description 1-byte object to transmit value telegrams. This object is enabled if 2-channel operation is activated with the function "Value transmitter 0...255 (1-byte)" or "Value transmitter 0...100% (1-byte)" for channel 2.

1: The number of rockers or buttons depends on the planned push-button sensor variant and the push-button sensor extension module. Mixed operation of rocker or button functions in a push-button sensor is possible on the basic module and the extension module.

2: The objects have been described for rocker 1 or button 1 as an example. The objects for the other rockers/buttons and for the module rockers are defined in the same way by shifting the object number and changing the object name.

3: For reading, the R-flag must be set. The last value written to the object via the bus will be read.

Function: 2-channel operation

Object	Function	Name	Type	DPT	Flag
<input type="checkbox"/> ← 19, 20, 21, 27, 28, 29, ...34	Channel 2 temperature value	Rocker/button 1 ^{1,2}	2 byte	9,001	C, -, -, T, - ₃

Description 2-byte object to transmit value telegrams. This object is enabled if 2-channel operation is activated with the function "Temperature value transmitter (2-byte)" for channel 2.

Objects for full-surface operation with rocker function (with dimming, Venetian blind and 2-channel operation):

Function: Full-surface operation

Object	Function	Name	Type	DPT	Flag
<input type="checkbox"/> ← 2, 4, 6, 8, 10, 12, 14, 16	Switching	Rocker 1 full-surface operation ^{1,2}	1-bit	1.xxx	C, (R), W, T, - ³

Description 1-bit object for the transmission of switching telegrams (ON, OFF) when there is full-surface operation of a control surface.

Function: Full-surface operation

Object	Function	Name	Type	DPT	Flag
<input type="checkbox"/> ← 2, 4, 6, 8, 10, 12, 14, 16	Scene extension	Rocker 1 full-surface operation ^{1,2}	1 byte	18,001	C, -, -, T, - ³

Description 1-byte object for recalling or for storing one of 64 scenes max. from a scene pushbutton sensor in case of full-surface operation of a control surface.

1: The number of rockers or buttons depends on the planned push-button sensor variant and the push-button sensor extension module. Mixed operation of rocker or button functions in a push-button sensor is possible on the basic module and the extension module.

2: The objects have been described for rocker 1 or button 1 as an example. The objects for the other rockers/buttons and for the module rockers are defined in the same way by shifting the object number and changing the object name.

3: For reading, the R-flag must be set. The last value written to the object via the bus will be read.

4.2.3.2 Status LED

Function: Status LED (control via separate LED object)					
Object	Function	Name	Type	DPT	Flag
 37, 38, ...52	Switching	Status LED 1 ¹	1-bit	1.xxx	C, (R), W, -, - ²
Description: 1-bit object for activation of the status LED.					

Function: Status LED (operating mode display, comparator)					
Object	Function	Name	Type	DPT	Flag
 37, 38, ...52	Value	Status LED 1 ¹	1 byte	5,010, 6,010, 20,102	C, (R), W, -, - ²
Description: 1-byte object for activation of the status LED.					

Function: Superimposed function of the status LED (control via separate LED object)					
Object	Function	Name	Type	DPT	Flag
 91, 92... 106	Superposed switching function	Status LED 1 ¹	1-bit	1.xxx	C, (R), W, -, - ²
Description: 1-bit object for forced-control activation of the status LEDs. This can be used to change the colour and display information of individual status LEDs according to priority. This object is enabled when "Activation via separate LED object" is selected as the overlaid LED function.					

Function: Superposed function for the status LED (Comparator)					
Object	Function	Name	Type	DPT	Flag
 91, 92... 106	Superposed value function	Status LED 1 ¹	1 byte	5,010, 6,010	C, (R), W, -, - ²
Description: 1-byte object for forced-control activation of the status LEDs. This can be used to change the colour and display information of individual status LEDs according to priority. This object is enabled when "Comparator with/without sign" is selected as the overlaid LED function.					

Function: Separate control of status LED red					
Object	Function	Name	Type	DPT	Flag
 107, 110 ... 152	Switching colour red	Status LED 1 ¹	1-bit	1,001	C, (R), W, -, - ²
Description: 1-bit object for activation of the red status LED. This object is enabled when "3-colour individual control via objects" is activated.					

1: The objects have been described for status LED 1 as an example. The objects for the other status LED are defined in the same way by shifting the object number and changing the object name.

2: For reading, the R-flag must be set. The last value written to the object via the bus will be read.

Function: Separate control of status LED green

Object	Function	Name	Type	DPT	Flag
 108, 111 ... 153	Switching colour green	Status LED 1 ¹	1-bit	1,001	C, (R), W, -, - ²

Description 1-bit object for activation of the green status LED. This object is enabled when "3-colour individual control via objects" is activated.

Function: Separate control of status LED blue

Object	Function	Name	Type	DPT	Flag
 109, 112 ... 154	Switching colour blue	Status LED 1 ¹	1-bit	1,001	C, (R), W, -, - ²

Description 1-bit object for activation of the blue status LED. This object is enabled when "3-colour individual control via objects" is activated.

1: The objects have been described for status LED 1 as an example. The objects for the other status LED are defined in the same way by shifting the object number and changing the object name.

2: For reading, the R-flag must be set. The last value written to the object via the bus will be read.

4.2.3.3 Disabling functions

Function:	Switching				
Object	Function	Name	Type	DPT	Flag
 17, 18	Switching	Disabling function 1 / 2	1-bit	1.xxx	C, (R), W, T, -1
Description	1-bit object for transmission of switching telegrams (ON, OFF).				

Function:	Dimming				
Object	Function	Name	Type	DPT	Flag
 17, 18	Switching	Disabling function 1 / 2	1-bit	1.xxx	C, (R), W, T, -1
Description	1-bit object for transmission of switching telegrams (ON, OFF).				

Function:	Dimming				
Object	Function	Name	Type	DPT	Flag
 35, 36	Dimming	Disabling function 1 / 2	4-bit	3,007	C, (R), W, T, -1
Description	4-bit object for the transmission of relative dimming telegrams.				

Function:	Venetian blind				
Object	Function	Name	Type	DPT	Flag
 17, 18	Short time operation	Disabling function 1 / 2	1-bit	1,007	C, (R), -, T, _1
Description	1-bit object for the transmission of telegrams with which a Venetian blind or shutter drive motor can be stopped or with which the blind slats can be adjusted by short time operation.				

Function:	Venetian blind				
Object	Function	Name	Type	DPT	Flag
 35, 36	Long-time operation	Disabling function 1 / 2	1-bit	1,008	C, (R), W, T, -1
Description	1-bit object for the transmission of telegrams with which a Venetian blind or shutter drive motor can be moved upwards or downwards.				

1: For reading, the R-flag must be set. The last value written to the object via the bus will be read.

Function: 1-byte value transmitter

Object	Function	Name	Type	DPT	Flag
 17, 18	Value	Disabling function 1 / 2	1 byte	5.xxx	C, (R), W, T, -1

Description 1-byte object for the transmission of values from 0 to 255 (corresponding to values from 0 % to 100 %). If the adjustment of the value is enabled, the object can transmit telegrams cyclically after long actuation with which the value can be reduced or increased by a presettable amount.

Function: 2-byte value transmitter

Object	Function	Name	Type	DPT	Flag
 17, 18	Value	Disabling function 1 / 2	2 byte	7.xxx	C, (R), W, T, -1

Description 2-byte object for the transmission of values from 0 to 65535. If the adjustment of the value is enabled, the object can transmit cyclical telegrams after a long press with which the value can be reduced or increased by an adjustable amount.

Function: 2-byte value transmitter

Object	Function	Name	Type	DPT	Flag
 17, 18	Temperature value	Disabling function 1 / 2	2 byte	9,001	C, (R), W, T, -1

Description 2 -byte object for the transmission of a temperature value from 0 °C to 40 °C. If the adjustment of the value is enabled, the object can transmit telegrams cyclically after a long press with which the value can be reduced or increased by 1 K.

Function: 2-byte value transmitter

Object	Function	Name	Type	DPT	Flag
 17, 18	Brightness value	Disabling function 1 / 2	2 byte	9,004	C, (R), W, T, -1

Description 2-byte object for the transmission of a brightness level value from 0 to 1500 lux. If the adjustment of the value is enabled, the object can transmit cyclical telegrams after a long press with which the value can be reduced or increased by 50 lux.

Function: Scene extension

Object	Function	Name	Type	DPT	Flag
 17, 18	Scene extension	Disabling function 1 / 2	1 byte	18,001	C, (R), -,T, _1

Description 1-byte object for recalling or for storing one of 64 scenes max. from a scene push button sensor.

1: For reading, the R-flag must be set. The last value written to the object via the bus will be read.

Function: 2-channel operation

Object	Function	Name	Type	DPT	Flag
 17, 18	Channel 1 switching	Disabling function 1 / 2	1-bit	1.xxx	C, (R), W, T, -1

Description 1-bit object for the transmission of switching telegrams, if 2-channel operation is activated.

Function: 2-channel operation

Object	Function	Name	Type	DPT	Flag
 17, 18	Channel 1 value	Disabling function 1 / 2	1 byte	5.xxx	C, (R), -,T, _1

Description 1-byte object for the transmission of value telegrams, if 2-channel operation is activated.

Function: 2-channel operation

Object	Function	Name	Type	DPT	Flag
 17, 18	Channel 1 temperature value	Disabling function 1 / 2	2 byte	9,001	C, (R), -,T, _1

Description 2-byte object for the transmission of value telegrams, if 2-channel operation is activated.

Function: 2-channel operation

Object	Function	Name	Type	DPT	Flag
 35, 36	Channel 2 switching	Disabling function 1 / 2	1-bit	1.xxx	C, (R), W, T, -1

Description 1-bit object for the transmission of switching telegrams, if 2-channel operation is activated.

Function: 2-channel operation

Object	Function	Name	Type	DPT	Flag
 35, 36	Channel 2 value	Disabling function 1 / 2	1 byte	5.xxx	C, (R), -,T, _1

Description 1-byte object for the transmission of value telegrams, if 2-channel operation is activated.

Function: 2-channel operation

Object	Function	Name	Type	DPT	Flag
 35, 36	Channel 2 temperature value	Disabling function 1 / 2	2 byte	9,001	C, (R), -,T, _1

Description 2-byte object for the transmission of value telegrams, if 2-channel operation is activated.

1: For reading, the R-flag must be set. The last value written to the object via the bus will be read.

Function: Disabling function

Object	Function	Name	Type	DPT	Flag
 ⁶³	Disabling	Button disabling	1-bit	1,001	C, (R), W, -, - ¹

Description 1-bit object by means of which the buttons can be disabled and enabled again (polarity configurable).

1: For reading, the R-flag must be set. The last value written to the object via the bus will be read.

4.2.3.4 Display

Function:	Backlighting				
Object	Function	Name	Type	DPT	Flag
 ²⁷⁵	Backlighting On/Off	D.Input	1-bit	1,001	C, R, W, -, - ₁
Description	1-bit object for switching the backillumination of the LC display (polarity configurable).				

Function:	Backlighting				
Object	Function	Name	Type	DPT	Flag
 ²⁷⁵	Backlighting brightness	D.Input	1 byte	5,001	C, (R), W, -, - ₁
Description	1-byte object for presetting a brightness for the backlighting of the LC display.				

Function:	Time				
Object	Function	Name	Type	DPT	Flag
 ²⁷⁶	Time	D.Input	3 byte	10,001	C, (R), W, T, - ₁
Description	3-byte object for receiving the current time via the bus. The time can be shown on the display (parameter-dependent).				

Function:	Time				
Object	Function	Name	Type	DPT	Flag
 ²⁷⁷	Time	D.Output	1-bit	1,001	C, -, -, T, - ₁
Description	1-bit object to request the current time via the bus. The time can be shown on the display (parameter-dependent).				

Function:	Temperature display				
Object	Function	Name	Type	DPT	Flag
 ²⁷⁸	Indication of actual temperature	D.Input	2 byte	9,001	C, -, W, -, - ₁
Description	2-byte object for receiving an actual temperature. The actual temperature can be shown on the display.				

1: For reading, the R-flag must be set. The last value written to the object via the bus will be read.

Function: Temperature display

Object	Function	Name	Type	DPT	Flag
 279	Display of setpoint temperature	D.Input	2 byte	9,001	C, -, W, -, - 1

Description 2-byte object for receiving a setpoint temperature. The setpoint temperature can be shown on the display.

Function: Temperature display

Object	Function	Name	Type	DPT	Flag
 280	Display of outdoor temperature	D.Input	2 byte	9,001	C, -, W, -, - 1

Description 2-byte object for receiving an outdoor temperature. The outdoor temperature can be shown on the display.

Function: Temperature display

Object	Function	Name	Type	DPT	Flag
 281, 282, 283	Display of any temperature (1-3)	D.Input	2 byte	9,001	C, -, W, -, - 1

Description 2-byte objects for receiving any temperature values. The temperatures can be shown on the display.

Function: Recalling display information

Object	Function	Name	Type	DPT	Flag
 284	Recall fixed display information	D.Input	1-bit	1,001	C, -, W, -, - 1

Description 1-bit object, using which previously configured display information is recalled on the display.

Function: Recalling display information

Object	Function	Name	Type	DPT	Flag
 284	Recall variable display information	D.Input	1 byte	5,010	C, -, W, -, - 1

Description 1-byte object, using which the up to 17 items of configurable display information can be recalled.
 "1" telegram: Recall display 1
 "2" telegram: Recall display 2
 ...
 "17" telegram: Recall display 17

1: For reading, the R-flag must be set. The last value written to the object via the bus will be read.

Function:	Recalling display information				
Object	Function	Name	Type	DPT	Flag
 ²⁸⁵	Cycl. Disable change of display information	D.Input	1-bit	1,001	C, -, W, -, - 1
Description	<p>1-bit object, using which the cyclical change of the display information can be disabled.</p> <p>"1" telegram: Disabling active</p> <p>"0" telegram: Disabling inactive</p> <p>The most recently set display information remains visible in the display if the cyclical change of display information is disabled. As soon as disabling is removed, the display information are shown cyclically in the display.</p>				

1: For reading, the R-flag must be set. The last value written to the object via the bus will be read.

4.2.3.5 Alarm signal

Function:	Alarm signal				
Object	Function	Name	Type	DPT	Flag
 ⁶⁴	Switching	Alarm signal	1-bit	1.xxx	C, (R), W, -, - ¹
Description	1-bit object for the reception of an alarm signalling (polarity configurable).				

Function:	Alarm signal				
Object	Function	Name	Type	DPT	Flag
 ⁶⁵	Switching	Alarm message acknowledge	1-bit	1.xxx	C, -, -, T, - ¹
Description	1-bit object for transmitting the acknowledgement of an alarm signalling (polarity configurable).				

1: For reading, the R-flag must be set. The last value written to the object via the bus will be read.

4.2.3.6 Room temperature measurement

Function:	Room temperature measurement				
Object	Function	Name	Type	DPT	Flag
 78	Measured value	S. Temperature TSM output	2 byte	9,001	C, (R), -,T, -
Description	<p>2-byte object for the display of the determined actual temperature. The actual temperature is either determined by the internal sensor, a received temperature value or by a combination of both measurement methods. The output temperature value takes the configured value for calibration into account, as well as the measured value formation between the temperature values. Possible value range: -99.9 °C to +99.9 °C / Measurement range of internal temperature sensor: 0 °C to +40 °C. Depending on the configuration, the temperature value is output in the display of the TSM in the format "°C" or "°F".</p> <p>This communication object is assigned to the room temperature measurement of the TSM. It is only enabled when the room temperature measurement of the TSM is enabled.</p>				

Function:	Room temperature measurement				
Object	Function	Name	Type	DPT	Flag
 79	External temperature	S.Temperature TSM input	2 byte	9,001	C, -,W, T, U ¹
Description	<p>2-byte object for coupling an external KNX room temperature sensor. Thus cascading of multiple temperature sensors for room temperature measurement. Possible range of values: -99.9 °C to +99.9 °C. The temperature value must always be specified in the format "°C".</p> <p>This communication object is assigned to the room temperature measurement of the TSM. It is only enabled when the room temperature measurement of the TSM is enabled and when a "received temperature value" is involved in temperature detection.</p>				

Function:	Room temperature measurement				
Object	Function	Name	Type	DPT	Flag
 272	Non-balanced measured value	S. Temperature TSM output	2 byte	9,001	C, (R), -,T, -
Description	<p>2-byte object for the display of the determined actual temperature. The actual temperature is either determined by the internal sensor, a received temperature value or by a combination of both measurement methods. The output value does not take the configured value for calibration into account. Internal to external measured value formation is taken into account. Possible value range: -99.9 °C to +99.9 °C / Measurement range of internal temperature sensor: 0 °C to +40 °C. Depending on the configuration, the temperature value is output in the display of the TSM in the format "°C" or "°F".</p> <p>This communication object is assigned to the room temperature measurement of the TSM. It is only enabled when the room temperature measurement of the TSM is enabled.</p>				

1: For reading, the R-flag must be set. The last value written to the object via the bus will be read.

Function: Room temperature measurement

Object	Function	Name	Type	DPT	Flag
 80	Measured value	S. Temperature TSEM output	2 byte	9,001	C, (R), -,T, -

Description 2-byte object for the display of the determined actual temperature. The actual temperature is either determined by the internal sensor, a received temperature value or by a combination of both measurement methods. The output temperature value takes the configured value for calibration into account, as well as the measured value formation between the temperature values. Possible value range: -99.9 °C to +99.9 °C / Measurement range of internal temperature sensor: 0 °C to +40 °C. Depending on the configuration, the temperature value is output in the display of the TSM in the format "°C" or "°F".
This communication object is assigned to the room temperature measurement of the TSEM. It is only enabled when the room temperature measurement of the TSEM is enabled.

Function: Room temperature measurement

Object	Function	Name	Type	DPT	Flag
 81	External temperature	S.Temperature TSEM input	2 byte	9,001	C, -,W, T, U ¹

Description 2-byte object for coupling an external KNX room temperature sensor. Thus cascading of multiple temperature sensors for room temperature measurement. Possible range of values: -99.9 °C to +99.9 °C. The temperature value must always be specified in the format "°C".
This communication object is assigned to the room temperature measurement of the TSEM. It is only enabled when the room temperature measurement of the TSEM is enabled and when a "received temperature value" is involved in temperature detection.

Function: Room temperature measurement

Object	Function	Name	Type	DPT	Flag
 273	Non-balanced measured value	S. Temperature TSEM output	2 byte	9,001	C, (R), -,T, -

Description 2-byte object for the display of the determined actual temperature. The actual temperature is either determined by the internal sensor, a received temperature value or by a combination of both measurement methods. The output value does not take the configured value for calibration into account. Internal to external measured value formation is taken into account. Possible value range: -99.9 °C to +99.9 °C / Measurement range of internal temperature sensor: 0 °C to +40 °C. Depending on the configuration, the temperature value is output in the display of the TSM in the format "°C" or "°F".
This communication object is assigned to the room temperature measurement of the TSEM. It is only enabled when the room temperature measurement of the TSEM is enabled.

1: For reading, the R-flag must be set. The last value written to the object via the bus will be read.

Function: Room temperature measurement

Object	Function	Name	Type	DPT	Flag
 270	Measured value	S. Temperature RS output	2 byte	9,001	C, (R), -, T, -

Description 2-byte object for the display of the determined actual temperature. The actual temperature is either determined by the internal sensor, a received temperature value or by a combination of both measurement methods. The output temperature value takes the configured value for calibration into account, as well as the measured value formation between the temperature values. Possible value range: -99.9 °C to +99.9 °C / Measurement range of internal temperature sensor: 0 °C to +40 °C. Depending on the configuration, the temperature value is output in the display of the TSM in the format "°C" or "°F".
This communication object is assigned to the room temperature measurement of the remote sensor (RS). It is only enabled when the room temperature measurement of the RS is enabled.

Function: Room temperature measurement

Object	Function	Name	Type	DPT	Flag
 271	External temperature	S.Temperature RS input	2 byte	9,001	C, -, W, -, - 1

Description 2-byte object for coupling an external KNX room temperature sensor. Thus cascading of multiple temperature sensors for room temperature measurement. Possible range of values: -99.9 °C to +99.9 °C. The temperature value must always be specified in the format "°C".
This communication object is assigned to the room temperature measurement of the remote sensor (RS). It is only enabled when the room temperature measurement of the RS is enabled and when a "received temperature value" is involved in temperature detection.

Function: Room temperature measurement

Object	Function	Name	Type	DPT	Flag
 274	Non-balanced measured value	S. Temperature RS output	2 byte	9,001	C, (R), -, T, -

Description 2-byte object for the display of the determined actual temperature. The actual temperature is either determined by the internal sensor, a received temperature value or by a combination of both measurement methods. The output value does not take the configured value for calibration into account. Internal to external measured value formation is taken into account. Possible value range: -99.9 °C to +99.9 °C / Measurement range of internal temperature sensor: 0 °C to +40 °C. Depending on the configuration, the temperature value is output in the display of the TSM in the format "°C" or "°F".
This communication object is assigned to the room temperature measurement of the remote sensor (RS). It is only enabled when the room temperature measurement of the RS is enabled.

1: For reading, the R-flag must be set. The last value written to the object via the bus will be read.

4.2.3.7 Scene function

Function:	Scene function				
Object	Function	Name	Type	DPT	Flag
 82...- 89	Switching	Scene output 1 ¹	1-bit	1.xxx	C, (R), W, T, A ²
Description		1-bit objects for controlling up to eight actuator groups (ON, OFF).			

Function:	Scene function				
Object	Function	Name	Type	DPT	Flag
 82...- 89	Value	Scene output 1 ¹	1 byte	5.xxx	C, (R), W, T, A ²
Description		1-byte objects for controlling up to eight actuator groups (0...255; 0%...100%).			

Function:	Scene function				
Object	Function	Name	Type	DPT	Flag
 82...- 89	Scene extension	Scene output 1 ¹	1 byte	18,001	C, (R), W, T, A ²
Description		1-byte object, using which the function of a scene extension is implemented. A scene number between 1 and 64 can be recalled.			

Function:	Scene function				
Object	Function	Name	Type	DPT	Flag
 90	Extension unit input	Scenes	1 byte	18,001	C, W, -, (R) ₂
Description		1-byte object with which one of the eight internally stored scenes can be recalled or stored again.			

1: Scene outputs 2 ... 8 see scene output 1, shift of the object number.

2: For reading, the R-flag must be set. The last value written to the object via the bus will be read.

4.2.3.8 Room temperature controller

Objects for Controller 1 and Controller 2. Both controllers possess the same communication objects, meaning that the controller objects are only documented once for both controllers (First object number = Controller 1; second object number = Controller 2).

Object for setpoint temperature specification

Function:	Setpoint temperature specification				
Object	Function	Name	Type	DPT	Flag
 156, 216	Basic setpoint	C.Input	2 byte	9,001	C, (R), W, -, - ¹
Description	2-byte object for external setting of the basic setpoint for absolute setpoint presetting. Depending on the operating mode, the possible range of values is limited by the configured frost protection and/or heat protection temperature. The controller rounds the temperature values received via the object depending on the configured interval of the basic setpoint shift (0.1 K or 0.5 K). The temperature value must always be specified in the format "°C".				

Function:	Setpoint temperature specification				
Object	Function	Name	Type	DPT	Flag
 156, 216	Setpoint active operating mode	C.Input	2 byte	9,001	C, (R), W, (T), - ¹
Description	2-byte object for external setting of a setpoint for <u>absolute setpoint presetting</u> . Depending on the operating mode, the possible range of values is limited by the configured frost protection and/or heat protection temperature. The controller rounds the temperature values received via the object to 0.1 K. The temperature value must always be specified in the format "°C". The setpoint modified by the setpoint shift can be reported back to the bus via the object by setting the "Transmit" flag.				

Objects for operating mode change-over

Function:	Operating mode switchover				
Object	Function	Name	Type	DPT	Flag
 158, 218	Operating mode switchover	C.Input	1 byte	20,102	C, (R), W, T, - ¹
Description	1-byte object for change-over of the operating mode of the controller according to the KNX specification. This object is only available in this way when the operating mode change-over is to take place over 1 byte (parameter-dependent).				

1: For reading, the R-flag must be set. The last value written to the object via the bus or by the device will be read.

Function: Operating mode switchover

Object	Function	Name	Type	DPT	Flag
 158, 218	Comfort mode	C.Input	1-bit	1,001	C, (R), W, T, - ¹

Description 1-bit object for change-over to the "Comfort" operating mode. This object is only available in this way when the operating mode change-over is to take place over 4 x 1 bit (parameter-dependent).

Function: Operating mode switchover

Object	Function	Name	Type	DPT	Flag
 159, 219	Standby mode	C.Input	1-bit	1,001	C, (R), W, T, - ¹

Description 1-bit object for change-over to the "Standby" operating mode. This object is only available in this way when the operating mode change-over is to take place over 4 x 1 bit (parameter-dependent).

Function: Operating mode switchover

Object	Function	Name	Type	DPT	Flag
 160, 220	Night operation	C.Input	1-bit	1,001	C, (R), W, T, - ¹

Description 1-bit object for change-over to the "Night" operating mode. This object is only available in this way when the operating mode change-over is to take place over 4 x 1 bit (parameter-dependent).

Function: Operating mode switchover

Object	Function	Name	Type	DPT	Flag
 161, 221	Frost/ heat protection	C.Input	1-bit	1,001	C, W, T, (R) ¹

Description 1-bit object for change-over to the "Frost / heat protection" operating mode. This object is only available in this way when the operating mode change-over is to take place over 4 x 1 bit (parameter-dependent).

Function: Operating mode switchover

Object	Function	Name	Type	DPT	Flag
 162, 222	Operating mode forced-control	C.Input	1 byte	20,102	C, W, T, (R) ¹

Description 1-byte object for forced change-over (highest priority) of the operating mode of the controller according to the KNX specification. This object is only available in this way when the operating mode change-over is to take place over 1 byte (parameter-dependent).

1: For reading, the R-flag must be set. The last value written to the object via the bus or by the device will be read.

Function: Operating mode change-over presence detection

Object	Function	Name	Type	DPT	Flag
 163, 223	Presence object	C.Input / Output	1-bit	1,001	C, (R), W, T, -1

Description 1-bit object through which a presence detector or an external presence button (e.g. from a controller extension) can be linked to the controller. The object can optionally be read (set "Read" flag), meaning that an internally changed presence status (e.g. through operating a button on the controller) can also be evaluated in other bus devices. No telegram is sent automatically in the case of an internal change in the presence status!
Polarity: presence detected = "1", presence not detected = "0".

Function: Operating mode change-over window status

Object	Function	Name	Type	DPT	Flag
 164, 224	Windows status	C.Input	1-bit	1,019	C, (R), W, T, -1

Description 1-bit object for the coupling of window contacts. Polarity: Window open = "1", window closed = "0".

Object for operating mode change-over

Function: Operating mode change-over

Object	Function	Name	Type	DPT	Flag
 165, 225	Heating / cooling change-over	C.Output	1-bit	1,100	C, (R), -, T, -1

Description 1 bit object to transmit the automatically set operating mode of the controller ("Heating" or "Cooling" modes).
Object value "1" = Heating; Object value "0" = Cooling. This object is only available in this way when the operating mode change-over is to take place automatically (parameter-dependent).

Function: Operating mode change-over

Object	Function	Name	Type	DPT	Flag
 165, 225	Heating / cooling change-over	C.Input / Output	1-bit	1,100	C, (R), W, T, -1

Description 1 bit object to change-over the operating mode of the controller ("Heating" or "Cooling" modes). Object value "1" = Heating; Object value "0" = Cooling. This object is only available in this way when the operating mode change-over is to take place manually (not automatically by the controller) (parameter-dependent).

1: For reading, the R-flag must be set. The last value written to the object via the bus or by the device will be read.

Object for controller status

Function: Status signal

Object	Function	Name	Type	DPT	Flag
 166, 226	Controller status	C.Output	1 byte	---	C, (R), -,T, _1

Description 1-byte object used by the controller to output the current state of operation (e.g. to a controller extension).
Only when "Controller status" = "Controller general".

Function: Status signal

Object	Function	Name	Type	DPT	Flag
 184, 244	Status signal addition	C.Output	1 byte	---	C, (R), -,T, _1

Description 1-byte object used by the controller to output the current enlarged state of operation (e.g. to a controller extension).
Only when "Controller status" = "Controller general".

Function: Status signal

Object	Function	Name	Type	DPT	Flag
 166, 244	Controller status ...	C.Output	1-bit	1,001	C, (R), -,T, _1

Description 1-bit object for single status feedback of configured controller functions. This object is only available in this way when a part of the controller status is to be transmitted singly as 1-bit information (parameter-dependent).

Function: Status signal

Object	Function	Name	Type	DPT	Flag
 166, 226	KNX status operating mode	C.Output	1 byte	20,102	C, (R), -,T, _1

Description 1-byte object used by the controller to output the current operating mode. This object is generally used to enable controller extensions to display the controller operating mode correctly in the KNX compliant status display. Therefore this object should be connected with controller extensions if the KNX compliant status feedback is not configured.
Only when "Controller status" = "KNX compliant".

1: For reading, the R-flag must be set. The last value written to the object via the bus or by the device will be read.

Function: Status signal

Object	Function	Name	Type	DPT	Flag
 185, 245	KNX status forced oper. mode	C.Output	1 byte	20,102	C, (R), -,T, _1

Description 1-byte object used by the controller to output the operating mode in the event of forced position. This object is generally used to enable controller extensions to display the controller operating mode correctly in the KNX compliant status display. Therefore this object should be connected with controller extensions if the KNX compliant status feedback is not configured.
Only when "Controller status" = "KNX compliant".

Function: Status signal

Object	Function	Name	Type	DPT	Flag
 184, 244	KNX controller status	C.Output	2 byte	22,101	C, (R), -,T, _1

Description 2-byte object that the controller uses to display elementary basic functions in a KNX-harmonised manner.
Only when "Controller status" = "KNX compliant".

Objects for heating / cooling signal functions

Function: Heating energy message

Object	Function	Name	Type	DPT	Flag
 167, 227	Heating indication	C.Output	1-bit	1,001	C, (R), -,T, _1

Description 1-bit object for the controller to report a request for heating energy. Object value = "1": energy request, object value = "0": no energy request.

Function: Cooling energy message

Object	Function	Name	Type	DPT	Flag
 168, 228	Cooling indication	C.Output	1-bit	1,001	C, (R), -,T, _1

Description 1-bit object for the controller to report a request for cooling energy. Object value = "1": energy request, object value = "0": no energy request.

Objects for controller disabling functions

Function: Disable controller

Object	Function	Name	Type	DPT	Flag
 170, 230	Disable controller	C.Input	1-bit	1,001	C, (R), W, -, _1

Description 1-bit object for deactivating the controller (activating dew point operation). Polarity: Controller deactivated = "1", controller activated = "0".

1: For reading, the R-flag must be set. The last value written to the object via the bus or by the device will be read.

Function: Disable controller

Object	Function	Name	Type	DPT	Flag
 171, 231	Disable additional level	C.Input	1-bit	1,001	C, (R), W, -, -1

Description 1-bit object for deactivating the additional level of the controller. Polarity: Additional level deactivated = "1", additional level activated = "0". This object is only available in this way if two-level heating or cooling operation is configured.

Object for heating command value output and combined valve heating/cooling

Function: Command value

Object	Function	Name	Type	DPT	Flag
 172, 232	Command value for heating / command value, basic heating	C.Output	1 byte	5,001	C, (R), -, T, _1

Description 1-byte object to output the continuous command value of the heating mode. In two-level heating mode, command value output for the basic heating. This object is only available in this way if the type of feedback control is configured to "Continuous PI control".

Function: Command value

Object	Function	Name	Type	DPT	Flag
 172, 232	Command value for heating (PWM) / command value, basic heating (PWM)	C.Output	1-bit	1,001	C, (R), -, T, _1

Description 1-bit object to output the PWM command value of the heating mode. In two-level heating mode, command value output for the basic heating. This object is only available in this way if the type of feedback control is configured to "Switching PI control (PWM)".

Function: Command value

Object	Function	Name	Type	DPT	Flag
 172, 232	Command value for heating / command value, basic heating	C.Output	1-bit	1,001	C, (R), -, T, _1

Description 1-bit object to output the switching command value of the heating mode. In two-level heating mode, command value output for the basic heating. This object is only available in this way if the type of feedback control is configured to "Switching 2-point feedback control".

1: For reading, the R-flag must be set. The last value written to the object via the bus or by the device will be read.

Function:	Command value				
Object	Function	Name	Type	DPT	Flag
 172, 232	Command value for heating/cooling / command value, basic level	C.Output	1 byte	5,001	C, (R), -,T, _1
Description	1-byte object to output the combined continuous command value of the heating and cooling mode. In two-level heating/cooling mode, command value output for the basic level This object is only available in this way if the command values for heating and cooling mode are output to a shared object (parameter-dependent). The type of feedback control must also be configured to "Continuous PI control".				

Function:	Command value				
Object	Function	Name	Type	DPT	Flag
 172, 232	Command value for heating/cooling (PWM) / command value, basic level (PWM)	C.Output	1-bit	1,001	C, (R), -,T, _1
Description	1-bit object to output the combined PWM command value of the heating and cooling mode. In two-level heating/cooling mode, command value output for the basic level This object is only available in this way if the command values for heating and cooling mode are output to a shared object (parameter-dependent). The type of feedback control must also be configured to "Switching PI control (PWM)".				

Function:	Command value				
Object	Function	Name	Type	DPT	Flag
 172, 232	Command value for heating/cooling / command value, basic level	C.Output	1-bit	1,001	C, (R), -,T, _1
Description	1-bit object to output the combined switching command value of the heating and cooling mode. In two-level heating/cooling mode, command value output for the basic level This object is only available in this way if the command values for heating and cooling mode are output to a shared object (parameter-dependent). The type of feedback control must also be configured to "Switching 2-point feedback control".				

Object for command value output, additional heating and combined valve additional heating/cooling

Function:	Command value				
Object	Function	Name	Type	DPT	Flag
 173, 233	Cmd. value, additional heating	C.Output	1 byte	5,001	C, (R), -,T, _1
Description	1-byte object to output the continuous command value for additional heating in two-level operation. This object is only available in this way if the type of feedback control is configured to "Continuous PI control".				

1: For reading, the R-flag must be set. The last value written to the object via the bus or by the device will be read.

Function: Command value

Object	Function	Name	Type	DPT	Flag
 173, 233	Cmd. value, add. heating (PWM)	C.Output	1-bit	1,001	C, (R), -,T, -1

Description: 1-bit object to output the continuous PWM command value for additional heating in two-level operation. This object is only available in this way if the type of feedback control is configured to "Switching PI control (PWM)".

Function: Command value

Object	Function	Name	Type	DPT	Flag
 173, 233	Cmd. value, additional heating	C.Output	1-bit	1,001	C, (R), -,T, -1

Description: 1-byte object to output the switching command value for additional heating in two-level operation. This object is only available in this way if the type of feedback control is configured to "Switching 2-point feedback control".

Function: Command value

Object	Function	Name	Type	DPT	Flag
 173, 233	Cmd. value, add. level	C.Output	1 byte	5,001	C, (R), -,T, -1

Description: 1-byte object to output the combined continuous command value for additional level in two-level operation. This object is only available in this way if the command values for heating and cooling mode are output to a shared object (parameter-dependent). The type of feedback control must also be configured to "Continuous PI control".

Function: Command value

Object	Function	Name	Type	DPT	Flag
 173, 233	Cmd. value, add. level (PWM)	C.Output	1-bit	1,001	C, (R), -,T, -1

Description: 1-bit object to output the combined switching PWM command value for additional level in two-level operation. This object is only available in this way if the command values for heating and cooling mode are output to a shared object (parameter-dependent). The type of feedback control must also be configured to "Switching PI control (PWM)".

Function: Command value

Object	Function	Name	Type	DPT	Flag
 173, 233	Cmd. value, add. level	C.Output	1-bit	1,001	C, (R), -,T, -1

Description: 1-bit object to output the combined switching command value for additional level in two-level operation. This object is only available in this way if the command values for heating and cooling mode are output to a shared object (parameter-dependent). The type of feedback control must also be configured to "Switching 2-point feedback control".

1: For reading, the R-flag must be set. The last value written to the object via the bus or by the device will be read.

Object for command value output, cooling

Function: Command value

Object	Function	Name	Type	DPT	Flag
 174, 234	Command value for cooling / command value, basic cooling	C.Output	1 byte	5,001	C, (R), -,T, _1

Description 1-byte object to output the continuous command value of the cooling mode. In two-level cooling mode, command value output for the basic cooling. This object is only available in this way if the type of feedback control is configured to "Continuous PI control".

Function: Command value

Object	Function	Name	Type	DPT	Flag
 174, 234	Command value for cooling (PWM) / command value, basic cooling (PWM)	C.Output	1-bit	1,001	C, (R), -,T, _1

Description 1-bit object to output the PWM command value of the cooling mode. In two-level cooling mode, command value output for the basic cooling. This object is only available in this way if the type of feedback control is configured to "Switching PI control (PWM)".

Function: Command value

Object	Function	Name	Type	DPT	Flag
 174, 234	Command value for cooling / command value, basic cooling	C.Output	1-bit	1,001	C, (R), -,T, _1

Description 1-bit object to output the switching command value of the cooling mode. In two-level cooling mode, command value output for the basic cooling. This object is only available in this way if the type of feedback control is configured to "Switching 2-point feedback control".

Object for command value output, additional cooling

Function: Command value

Object	Function	Name	Type	DPT	Flag
 175, 235	Cmd. value, additional cooling	C.Output	1 byte	5,001	C, (R), -,T, _1

Description 1-byte object to output the continuous command value for additional cooling in two-level operation. This object is only available in this way if the type of feedback control is configured to "Continuous PI control".

1: For reading, the R-flag must be set. The last value written to the object via the bus or by the device will be read.

Function:	Command value				
Object	Function	Name	Type	DPT	Flag
 175, 235	Cmd. value, add. cooling (PWM)	C.Output	1-bit	1,001	C, (R), -,T, -1
Description	1-bit object to output the continuous PWM command value for additional cooling in two-level operation. This object is only available in this way if the type of feedback control is configured to "Switching PI control (PWM)".				

Function:	Command value				
Object	Function	Name	Type	DPT	Flag
 175, 235	Cmd. value, additional cooling	C.Output	1-bit	1,001	C, (R), -,T, -1
Description	1-byte object to output the switching command value for additional cooling in two-level operation. This object is only available in this way if the type of feedback control is configured to "Switching 2-point feedback control".				

Object for additional PWM heating command value output and combined valve PWM additional heating/cooling

Function:	Command value				
Object	Function	Name	Type	DPT	Flag
 176, 236	PWM command value for heating / PWM command value, basic heating	C.Output	1 byte	5,001	C, (R), -,T, -1
Description	1-byte object to output the internal continuous command value of a PWM controller of the heating mode. In two-level heating mode, command value output for the basic heating. This object is only available in this way if the type of feedback control is configured to "Switching PI control (PWM)". In addition to the switching 1 bit command value of the PWM, the calculated continuous command value of the controller can also be transmitted to the bus and displayed, e.g. in a visualisation.				

Function:	Command value				
Object	Function	Name	Type	DPT	Flag
 176, 236	PWM command value for heating/cooling / PWM command value, basic level	C.Output	1 byte	5,001	C, (R), -,T, -1
Description	1-byte object to output the combined continuous command value of a PWM controller of the heating and cooling mode. In two-level heating/cooling mode, command value output for the basic level This object is only available in this way if the command values for heating and cooling mode are output to a shared object (parameter-dependent). The type of feedback control must also be configured to "Switching PI control (PWM)". In addition to the switching 1 bit command value of the PWM, the calculated continuous command value of the controller can also be transmitted to the bus and displayed, e.g. in a visualisation.				

1: For reading, the R-flag must be set. The last value written to the object via the bus or by the device will be read.

Object for additional command value output, PWM additional heating and combined valve PWM additional heating/cooling

Function: Command value

Object	Function	Name	Type	DPT	Flag
 177. 237	PWM cmd. value, add. heating	C.Output	1 byte	5,001	C, (R), -,T, _1

Description 1-byte object to output the internal continuous command value of a PWM controller for additional heating in two-level operation. This object is only available in this way if the type of feedback control is configured to "Continuous PI control". In addition to the switching 1 bit command value of the PWM, the calculated continuous command value of the controller can also be transmitted to the bus and displayed, e.g. in a visualisation.

Function: Command value

Object	Function	Name	Type	DPT	Flag
 177. 237	PWM command value, add. level	C.Output	1 byte	5,001	C, (R), -,T, _1

Description 1-byte object to output the combined continuous command value of a PWM feedback controller for additional level in two-level operation. This object is only available in this way if the command values for heating and cooling mode are output to a shared object (parameter-dependent). The type of feedback control must also be configured to "Switching PI control (PWM)". In addition to the switching 1 bit command value of the PWM, the calculated continuous command value of the controller can also be transmitted to the bus and displayed, e.g. in a visualisation.

Object for additional command value output, PWM cooling

Function: Command value

Object	Function	Name	Type	DPT	Flag
 178. 238	PWM command value for cooling / PWM command value, basic cooling	C.Output	1 byte	5,001	C, (R), -,T, _1

Description 1-byte object to output the internal continuous command value of a PWM feedback controller of the cooling mode. In two-level cooling mode, command value output for the basic cooling. This object is only available in this way if the type of feedback control is configured to "Switching PI control (PWM)". In addition to the switching 1 bit command value of the PWM, the calculated continuous command value of the controller can also be transmitted to the bus and displayed, e.g. in a visualisation.

1: For reading, the R-flag must be set. The last value written to the object via the bus or by the device will be read.

Object for additional command value output, PWM additional cooling

Function: Command value

Object	Function	Name	Type	DPT	Flag
 179, 239	PWM cmd. value, add. cooling	C.Output	1 byte	5,001	C, (R), -,T, _1

Description: 1-byte object to output the internal continuous command value of a PWM feedback controller for additional cooling in two-level operation. This object is only available in this way if the type of feedback control is configured to "Switching PI control (PWM)". In addition to the switching 1 bit command value of the PWM, the calculated continuous command value of the controller can also be transmitted to the bus and displayed, e.g. in a visualisation.

Object for outputting the setpoint temperature

Function: Set temperature

Object	Function	Name	Type	DPT	Flag
 180, 240	Set temperature	C.Output	2 byte	9,001	C, (R), -,T, _1

Description: 2-byte object for the output of the current temperature setpoint. Depending on the operating mode, the possible range of values is limited by the configured frost protection and/or heat protection temperature. The temperature value is always output in the format "°C".

Object for basic setpoint shift (only for relative setpoint presetting)

Function: Basic setpoint shifting

Object	Function	Name	Type	DPT	Flag
 182, 242	Current setpoint shifting	C.Output	1 byte	6,010	C, R, -,T, -1

Description: 1-byte object for giving feedback on the current setpoint shifting. The value of a counter value in the communication object is 0.5 K. The value "0" means that no shift is active. The value is depicted in a double complement in the positive and negative direction. This object is only available in this way if relative setpoint presetting is configured.

1: For reading, the R-flag must be set. The last value written to the object via the bus or by the device will be read.

Function: Basic setpoint shifting

Object	Function	Name	Type	DPT	Flag
 183, 243	Preset setpoint shifting	C.Input	1 byte	6,010	C, (R), W, -, - ¹

Description 1-byte object for setting a basic setpoint shifting, e.g. via a controller extension. The value of a counter value in the communication object is 0.5 K. The value "0" means that no shift is active. The value is depicted in a double complement in the positive and negative direction. In case the limits of the value range are exceeded by the preset external value, the controller will automatically reset the received value to the minimum and maximum limits. This object is only available in this way if relative setpoint presetting is configured.

Object for command value limit

Function: Command value limit

Object	Function	Name	Type	DPT	Flag
 186, 246	Command value limit	C.Input	1-bit	1,001	C, (R), W, -, - ¹

Description 1-bit object for activating or deactivating the command value limit.

Objects for fan control

Function: Fan controller

Object	Function	Name	Type	DPT	Flag
 188, 248	Ventilation, automatic/manual	C.Input	1-bit	1,001	C, (R), W, T, - ¹

Description 1-bit object to change-over the operating mode of the fan controller (configurable polarity). When the operating mode is changed over using a button function, a telegram matching the current status is transmitted to the bus.

Function: Fan controller

Object	Function	Name	Type	DPT	Flag
 189, 249	Ventilation, fan level 1-8	C.Output	1-bit	5,010	C, R, -, T, - ¹

Description 1-byte object for value-guided activation of the fan levels. This object is only available in this way when the fan control is to take place over 1 byte (parameter-dependent).

1: For reading, the R-flag must be set. The last value written to the object via the bus or by the device will be read.

Function: Fan controller

Object	Function	Name	Type	DPT	Flag
 189, 249	Ventilation, fan level 1	C.Output	1-bit	1,001	C, R, -,T, - 1

Description 1-bit object for switching activation of the first fan level. This object is only available in this way when the fan control is to take place over 3 x 1 bit and at least one fan level is enabled (parameter-dependent).

Function: Fan controller

Object	Function	Name	Type	DPT	Flag
 190, 250	Ventilation, fan level 2	C.Output	1-bit	1,001	C, R, -,T, - ¹

Description 1-bit object for switching activation of the second fan level. This object is only available when the fan control is to take place over 3 x 1 bit and at least two fan levels are enabled (parameter-dependent).

Function: Fan controller

Object	Function	Name	Type	DPT	Flag
 191, 251	Ventilation, fan level 3	C.Output	1-bit	1,001	C, R, -,T, - ¹

Description 1-bit object for switching activation of the third fan level. This object is only available when the fan control is to take place over 3 x 1 bit and at least three fan levels are enabled (parameter-dependent).

Function: Fan controller

Object	Function	Name	Type	DPT	Flag
 192, 252	Ventilation, fan level 4	C.Output	1-bit	1,001	C, R, -,T, - ¹

Description 1-bit object for switching activation of the fourth fan level. This object is only available when the fan control is to take place over 3 x 1 bit and at least four fan levels are enabled (parameter-dependent).

Function: Fan controller

Object	Function	Name	Type	DPT	Flag
 193, 253	Ventilation, fan level 5	C.Output	1-bit	1,001	C, R, -,T, - ¹

Description 1-bit object for switching activation of the fifth fan level. This object is only available when the fan control is to take place over 3 x 1 bit and at least five fan levels are enabled (parameter-dependent).

1: For reading, the R-flag must be set. The last value written to the object via the bus or by the device will be read.

Function: Fan controller

Object	Function	Name	Type	DPT	Flag
 194, 254	Ventilation, fan level 6	C.Output	1-bit	1,001	C, R, -, T, - ¹

Description 1-bit object for switching activation of the sixth fan level. This object is only available when the fan control is to take place over 3 x 1 bit and at least six fan levels are enabled (parameter-dependent).

Function: Fan controller

Object	Function	Name	Type	DPT	Flag
 195, 255	Ventilation, fan level 7	C.Output	1-bit	1,001	C, R, -, T, - ¹

Description 1-bit object for switching activation of the seventh fan level. This object is only available when the fan control is to take place over 3 x 1 bit and at least seven fan levels are enabled (parameter-dependent).

Function: Fan controller

Object	Function	Name	Type	DPT	Flag
 196, 256	Ventilation, fan level 8	C.Output	1-bit	1,001	C, R, -, T, - ¹

Description 1-bit object for switching activation of the eighth fan level. This object is only available when the fan control is to take place over 3 x 1 bit and at least eight fan levels are enabled (parameter-dependent).

Function: Fan controller

Object	Function	Name	Type	DPT	Flag
 197, 257	Ventilation, forced position	C.Input	1-bit	1,001	C, (R), W, -, - ¹

Description 1-bit object for activation of the fan forced position. Polarity: Forced position ON = "1"; Forced position OFF = "0".

Function: Fan controller

Object	Function	Name	Type	DPT	Flag
 198, 258	Ventilation, level limit	C.Input	1-bit	1,001	C, (R), W, -, - ¹

Description 1-bit object for activation of the fan level limitation. Polarity: Fan level limitation ON = "1"; Fan level limitation OFF = "0".

1: For reading, the R-flag must be set. The last value written to the object via the bus or by the device will be read.

Function: Fan controller

Object	Function	Name	Type	DPT	Flag
 199, 259	Ventilation, fan protection	C.Input	1-bit	1,001	C, (R), W, -, - ¹

Description 1-bit object for activating the fan protection. Polarity:
Fan protection ON = "1" / Fan protection OFF = "0".

Function: Fan controller

Object	Function	Name	Type	DPT	Flag
 200, 260	Ventilation visualisation	C.Output	1 byte	5,010	C, R, -, W, - ₁

Description 1-byte object for additional value-guided acknowledgement of the active fan level. Value meaning: "0" = Fan OFF, "1" = level 1 active, "2" = level 2 active, ..., "8" = level 8 active.

Object for detecting the outdoor temperature

Function: Outdoor temperature

Object	Function	Name	Type	DPT	Flag
 201, 261	Outdoor temperature	C.Input	2 byte	9,001	C, (R), W, T, - ¹

Description 2-byte object for detecting the outdoor temperature The received value is used solely for the display. Possible range of values: -99.9 °C to +99.9 °C. The temperature value must always be specified in the format "°C".

Object for limiting the setpoint temperature

Function: Setpoint temperature limit

Object	Function	Name	Type	DPT	Flag
 202, 262	Limit of cooling setpoint temperature	C.Input	1-bit	1,001	C, (R), W, -, - ¹

Description 1-bit object for activating the setpoint temperature limit. Polarity:
Setpoint temperature limit ON = "1"; Setpoint temperature limit OFF = "0".

1: For reading, the R-flag must be set. The last value written to the object via the bus or by the device will be read.

Object for limiting the floor temperature

Function: Floor temperature limitation

Object	Function	Name	Type	DPT	Flag
 203, 263	Floor temperature	C.Input	2 byte	9,001	C, (R), W, -, -1

Description: 2-byte object for coupling an external temperature sensor for floor temperature limitation.
The temperature value must always be specified in the format "°C".

Object for rotation angle conversion

Function: Output of the rotation angle

Object	Function	Name	Type	DPT	Flag
 204, 264	Rotation angle	C.Output	1 byte	5,001	C, R, -, T, -1

Description: 1-byte object for output of the calculated rotation angle for activating a control ball valve.

Function: Output of the rotation angle

Object	Function	Name	Type	DPT	Flag
 206, 266	Rotation angle	C.Output	1 byte	5,001	C, R, -, T, -1

Description: 1-byte object for output of the calculated rotation angle for activating a control ball valve.

1: For reading, the R-flag must be set. The last value written to the object via the bus or by the device will be read.

4.2.3.9 Controller extension

Objects for Controller extension 1 and Controller extension 2. Both controller extensions possess the same communication objects, meaning that the controller extension objects are only documented once for both controllers
(First object number = Controller extension 1; second object number = Controller extension 2).

Objects for the controller extension:

Function: Controller extension					
Object	Function	Name	Type	DPT	Flag
 ^{66,} ₇₂	Operating mode switch-over	RNST n .Button fct. Output/Input	1 byte	20,102	C, (R), W, T, A ¹
Description		1-byte object for changing over a room temperature controller between the Comfort, Standby, Night and Frost/heat protection operating modes.			

Function: Controller extension					
Object	Function	Name	Type	DPT	Flag
 ^{67,} ₇₃	Forced oper. mode switch-over	RNST n .Button fct. Output/Input	1 byte	20,102	C, (R), W, T, A ¹
Description		1-byte object for changing over a room temperature controller under forced control between the Automatic, Comfort, Standby, Night and Frost / heat protection operating modes			

Function: Controller extension					
Object	Function	Name	Type	DPT	Flag
 ^{68,} ₇₄	Presence button	RNST n .Button fct. Output/Input	1-bit	1,001	C, (R), W, T, A ¹
Description		1-bit object for changing over the presence status of a room temperature controller (polarity configurable).			

Function: Controller extension					
Object	Function	Name	Type	DPT	Flag
 ^{69,} ₇₅	Preset setpoint shifting	RNST n .Button fct. Output	1 byte	6,010	C, (R), -, T, ₁
Description		1-byte object for presetting a basic setpoint shift for a controller. $x \leq 0 \leq y$ (0 = no shift active); integral numbers Value object + 1 (increase level value) Value object - 1 (decrease level value) The possible range of values (x to y) is fixed by the setpoint adjusting range to the 'upper limit' or to the 'lower limit' (configurable) in combination with the level value <u>on the room temperature controller</u> .			

1: For reading, the R-flag must be set. The last value written to the object via the bus will be read.

Function: Controller extension

Object	Function	Name	Type	DPT	Flag
 70, 76	Current setpoint shifting	RNST n .Button fct. Input	1 byte	6,010	C, (R), W, -, A ¹

Description 1-byte object used by the extension unit for receiving the current setpoint shift of the room temperature controller.
 $x \leq 0 \leq y$ (0 = no shift active); integral numbers
 The possible range of values (x to y) is fixed by the setpoint adjusting range to the 'upper limit' or to the 'lower limit' (configurable) in combination with the level value on the room temperature controller.

Function: Controller extension

Object	Function	Name	Type	DPT	Flag
 166, 226	Controller status	RNST n .Display fct. Input	1 byte	Not defined	C, (R), W, -, A ¹

Description 1-byte object used by the extension unit for receiving the current state of operation of the controller. Status LEDs that can be used to indicate a status independently of a button function can display one of the various information units which are grouped in this byte (bit-oriented evaluation). This object is enabled when the "Controller status" parameter is set to "KNX-conformant".

Function: Controller extension

Object	Function	Name	Type	DPT	Flag
 166, 226	KNX status operating mode	RNST n .Display fct. Input	1 byte	Not defined	C, (R), W, -, A ¹

Description 1-byte object used by the extension unit for receiving the current state of operation of the controller. Status LEDs, that can be used to display a status independently of a button function, can display one of the various pieces of information which are grouped in this byte (bit-oriented evaluation). This object is enabled when the "Controller status" parameter is set to "KNX-conformant".

Function: Controller extension

Object	Function	Name	Type	DPT	Flag
 176, 236	Command value for heating 0%...100%	RNST n .Display fct. Input	1 byte	5,001	C, -,W, -, U ¹

Description 1-byte object to output the continuous command value of the heating mode. In two-level heating mode, command value output for the basic heating. This object is only available in this way if the type of feedback control is configured to "Continuous PI control".

Function: Controller extension

Object	Function	Name	Type	DPT	Flag
 176, 236	Command value for heating On/Off	RNST n .Display fct. Input	1 byte	1,001	C, -,W, -, U ¹

Description 1-bit object to output the switching command value of the heating mode. In two-level heating mode, command value output for the basic heating. This object is only available in this way if the type of feedback control is configured to "Switching 2-point feedback control".

1: For reading, the R-flag must be set. The last value written to the object via the bus will be read.

Function: Controller extension

Object	Function	Name	Type	DPT	Flag
 178, 238	Command value for cooling 0%...100%	RNST n .Display fct. Input	1 byte	5,001	C, -,W, -, U ¹
Description	1-byte object to output the continuous command value of the cooling mode. In two-level cooling mode, command value output for the basic cooling. This object is only available in this way if the type of feedback control is configured to "Continuous PI control".				

Function: Controller extension

Object	Function	Name	Type	DPT	Flag
 178, 238	Command value for cooling On/Off	RNST n .Display fct. Input	1 byte	1,001	C, -,W, -, U ¹
Description	1-bit object to output the switching command value of the cooling mode. In two-level cooling mode, command value output for the basic cooling. This object is only available in this way if the type of feedback control is configured to "Switching 2-point feedback control".				

Function: Controller extension

Object	Function	Name	Type	DPT	Flag
 180, 240	Set temperature	RNST n .Display fct. Input	2 byte	9,001	C, -,W, -, U ¹
Description	2-byte object for the output of the current temperature setpoint. Depending on the operating mode, the possible range of values is limited by the configured frost protection and/or heat protection temperature. The temperature value is always output in the format "°C".				

Function: Controller extension

Object	Function	Name	Type	DPT	Flag
 184, 244	KNX controller status	RNST n .Display fct. Input	2 byte	22,101	C, -,W, -, U ¹
Description	2-byte object that the controller uses to display elementary basic functions in a KNX-harmonised manner. Only when "Controller status" = "KNX compliant".				

Function: Controller extension

Object	Function	Name	Type	DPT	Flag
 184, 244	Controller status addition	RNST n .Display fct. Input	1 byte	---	C, -,W, -, U ¹
Description	1-byte object used by the controller to output the current enlarged state of operation. Only when "Controller status" = "Controller general".				

1: For reading, the R-flag must be set. The last value written to the object via the bus will be read.

Function: Controller extension

Object	Function	Name	Type	DPT	Flag
 200, 260	Ventilation visualisation	RNSTn.Display fct. Input	1 byte	5,010	C, -,W, -, U ¹
Description	1-byte object for additional value-guided acknowledgement of the active fan level. Value meaning: "0" = Fan OFF, "1" = level 1 active, "2" = level 2 active, ..., "8" = level 8 active.				

Function: Controller extension

Object	Function	Name	Type	DPT	Flag
 201, 261	Outdoor temperature	RNSTn.Display fct. Input	2 byte	9,001	C, -,W, -, U ¹
Description	2-byte object for detecting the outdoor temperature The received value is used solely for the display. Possible range of values: -99.9 °C to +99.9 °C. The temperature value must always be specified in the format "°C".				

Function: Controller extension

Object	Function	Name	Type	DPT	Flag
 205, 265	Actual-temperature	RNSTn.Display fct. Input	2 byte	9,001	C, -,W, -, U ¹
Description	2-byte object for the detection of the actual temperature. The received value is used solely for the display. Possible range of values: -99.9 °C to +99.9 °C. The temperature value must always be specified in the format "°C".				

1: For reading, the R-flag must be set. The last value written to the object via the bus will be read.

4.2.3.10 Operation LED and labelling field illumination

Function: Operation LED					
Object	Function	Name	Type	DPT	Flag
 ⁵⁶	Switching	TSEM.Operation LED	1-bit	1,001	C, W, -, (R) ₁
Description		1-bit object for switching the operation LED of the connected TSEM on or off ("1" = switch on; "0" = switch off).			

Function: Operation LED					
Object	Function	Name	Type	DPT	Flag
 ^{56, 57, 58}	Switching colour red [green, blue]	TSEM.Operation LED	1-bit	1,001	C, W, -, (R) ₁
Description		1-bit object for switching the red colour of the operation LED of the TSEM in the case of 3-colour control via objects on or off ("1" = switch on; "0" = switch off).			

Objects for labelling field illumination and brightness:

Function: Labelling field illumination					
Object	Function	Name	Type	DPT	Flag
 ⁶⁰	Switching	TSEM.Labelling field illumination	1-bit	1,001	C, W, -, (R) ₁
Description		1-bit object for switching the labelling field illumination of the TSEM on or off ("1" = switch on; "0" = switch off).			

Function: Brightness of all LEDs					
Object	Function	Name	Type	DPT	Flag
 ^{61, 62}	Switching	LED night reduction	1-bit	1,001	C, W, -, (R) ₁
Description		1-bit object for reducing the brightness of all status LEDs of the TSM or the TSEM. If the TSEM is connected, this object also reduces the labelling field illumination and the operation LED ("1" = reduce; "0" = normal operation).			

1: For reading, the R-flag must be set. The last value written to the object via the bus will be read.

4.2.4 Functional description

4.2.4.1 General settings

4.2.4.1.1 Button configuration

The compact room controller module can be extended to 16 control surfaces using a pushbutton or room controller extension module, if necessary. An extension module expands the number of control surfaces in addition to the control surfaces of the basic unit, so that up to four rockers or 8 buttons more are available.

The rockers or buttons of the extension module are evaluated by the application program of the basic unit. In addition, each control surface of the extension module has a status LED, which is also activated by the application program of the basic device. Consequently, an extension module does not have any application program of its own or a bus coupling unit. The extension module is configured and put into operation in the ETS via the product database of the basic device. Each basic unit can have only one extension module connected to it. Together, a basic unit and an extension module form a unit.

Configuration of the control surfaces of the connected extension module is carried out in the ETS on the "Configuration TSEM" parameter page.

The button configuration of the basic module is permanently specified by the application program of the basic device used in the ETS project, and cannot be changed (Compact room controller module 2-gang = 2 rockers / buttons 1...4 on the basic device; compact room controller module 4-gang = 4 rockers / buttons 1...8 on the basic device). If a extension module is connected, the type of the extension module, and with it the number of available buttons, must be enabled separately in the ETS. In the ETS parameter view, the corresponding communication objects and parameters are automatically displayed.

The enabled functions of the extension module are displayed and configured in the ETS in the same way as the rockers or buttons of the basic module.

The button numbers and all further functions for the basic module and extension module are separately displayed and counted.

4.2.4.1.2 Operation concept and button evaluation

The changeover between rockers and button operation of a control surface of the basic or extension module is made on the parameter pages "TSM operation concept" and "TSEM operation concept". The parameter page "TSEM operation concept" is only visible if an extension module has been connected and enabled.

The parameter "Operation concept..." specify for each control surface whether the opposing buttons are combined into a common rocker function, or are evaluated as two separate button functions.

The additional parameter pages and the communication objects of the rockers or buttons are then also created and adapted depending on the setting parameterized here.

- i** Pressing several rockers or buttons at the same time will be considered as a wrong operation. The special rocker function "Full-surface operation" is an exception to the above rule. In this case, the parameterisation of the rocker decides whether the operation is a wrong operation or not.

The functions of the individual rockers or buttons are set on the parameter pages "Rocker ..." (buttons ...) or "button ..." "Button ...".

Button pair as rocker function

For rocker functions, the opposing buttons affect the communication objects together. As a rule, actuation of the two buttons then result in directly opposite information (e.g. switching: ON - OFF / blind: UP - DOWN). When a button is pressed, the commands should be made independently of each other.

Full-surface operation with rocker function

Depending on the basic function of a rocker, it is also possible with some settings to use a press on the full surface with a separate function. With full-surface operation, both buttons of a rocker are pressed at the same time.

Button pair as button function

With button operation, the control surfaces are evaluated independently of each other (single-area operation).

4.2.4.1.3 Transmission delay

After a reset (e.g. after loading of an application program or the physical address or after switch-on of the bus voltage), the device can automatically transmit telegrams for the "Room temperature controller extension" function. In case of the controller extension, the device attempts to retrieve values from the room temperature controller by means of read telegrams in order to update the object states. In case of the room temperature measurement, the device transmits the current room temperature after a reset to the bus.

If, besides this compact room controller module, there are still other devices installed in the bus which transmit telegrams immediately after a reset, it may be useful to activate the transmit delay for automatically transmitting objects on the "General" page in order to reduce the bus load.

When transmit delay is activated, the device determines the value of its individual delay from the device number of its physical address (phys. address: area.line.device number). This value can be about 30 seconds maximum. Without setting a special time delay, this principle prevents multiple TSM from trying to transmit telegrams to the bus at the same time.

- i The transmit delay is not active for the rocker or button functions of the TSM. In addition, the controller objects are not influenced by the transmission delay.

4.2.4.2 Display

Introduction

On the front side of the device, between the control surfaces, there is a LC display (LCD = Liquid crystal display) with switchable backlighting. On the display, icons signal various operating states of the integrated room temperature controller or the controller extension. In addition, up to 17 pieces of display information (actual temperature, setpoint temperature, outdoor temperature and any temperatures) can be shown either alternating over time or controlled by pressing a button on the device.

The device can be integrated into the switch programs A500, LS990 or CD500. The displays of the devices for the LS990 and CD500 switch ranges have the same design and differ from the display of the A500 switch range through a different arrangement of the display information. Button function icons can only be displayed on the displays with the switch ranges LS990 and CD500 (figure 35).

Full-surface operation of rocker 1 can recall the menu level of the device. The content of the menu level can be configured in the ETS.

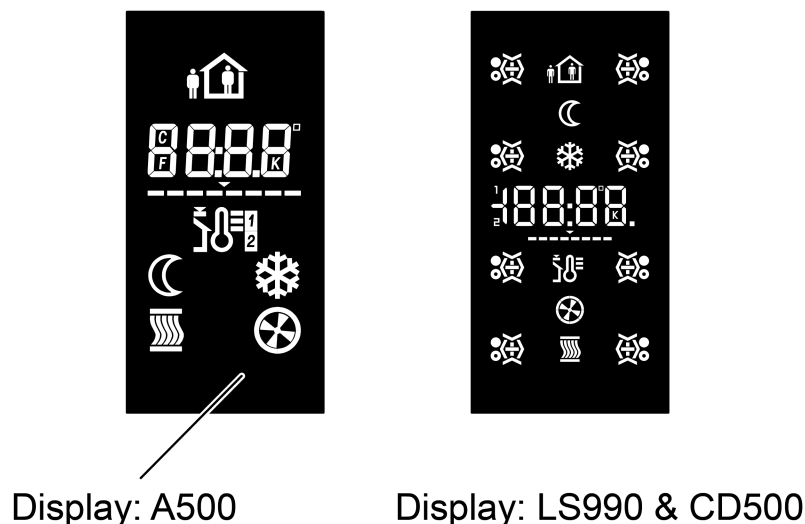

Figure 35: Device display

4.2.4.2.1 Displayed information

Icons of the room temperature controller

The table clarifies the meaning of all the display icons. The icons signal various states of the integrates room temperature controller or the controller extension and the display operation.

Icon	Meaning
	"Comfort" operating mode active. Can flash when setting the operating mode in the menu level.
	"Standby" operating mode active. Can flash when setting the operating mode in the menu level.
	"Night" operating mode active. Can flash when setting the operating mode in the menu level.

✱	"Frost/heat protection" operating mode active. Flashes on frost alarm. Frost alarm is dependent on an active "Controller status": - For "KNX-conformant" ("Frost protection setpoint (°C) fallen below), - For "General controller" ($T_{\text{Room}} \leq +5 \text{ °C} / +41 \text{ °F}$), - For "Transmit individual state" ($T_{\text{Room}} \leq +5 \text{ °C} / +41 \text{ °F}$).
🏠🌙	A "Night comfort extension" is active.
🏠✱	A "Frost/heat protection comfort extension" is active.
---- ▼ ----	Indication of the basic setpoint in the positive " ▼ ----" or negative "---- ▼" direction. A bar corresponds to shifting by one level value. The value of a level can be parameterised in the ETS. If no shift is active, only " ▼" is displayed.
⊗	Display of a fan controller configured in the ETS (impeller) with display of the active fan level ✱, ✱, ✱, ..., ⊗. If no icon is displayed, either the fan control is completely deactivated in the ETS or the fan function is activated in the ETS but is switched off.
▮▮▮	The controller uses this icon to signal that heating energy is being fed to the room. In continuous feedback control, the command value is indicated by the number of streaks that are visible (0 %), (1...20 %), (21...40 %), (41...60 %), (61...80 %), (81...100 %). In 2-point feedback control, ▮▮▮ indicates a command value that is switched on and _ one that is switched off. This icon ▮▮▮ is also visible in the menu level for setpoint temperature settings for heating mode.
▮▮▮	The controller uses this icon to signal that cooling energy is being fed to the room. In continuous feedback control, the command value is indicated by the number of streaks that are visible (0 %), (1...20 %), (21...40 %), (41...60 %), (61...80 %), (81...100 %). In 2-point feedback control, ▮▮▮ indicates a command value that is switched on and ▮ one that is switched off. This icon ▮▮▮ is also visible in the menu level for setpoint temperature settings for cooling mode.

Table: Meaning of the display icons

Display information

In addition to the icons, it is possible to use the numeric display to show up to 17 display functions in the display. Thus, up to 17 pieces of display information (actual temperature, setpoint temperature, outdoor temperature, any temperature) can be optionally displayed with the room temperature controller icons.

In the ETS, it is possible to configure which of this information is actually shown in the display. In the "No display" setting, no information is shown in the display on recalling the appropriate display.

The information is shown separately on the display. It is possible to change over between the information automatically after set times or in a controlled manner by pressing a button on the device. The display information are switched in the sequence Display 1, Display 2, Display 3, ..., Display 17.

The following four figures show the possible display information in a sample sequence. Various temperatures, received by input objects of the controller or the display, are shown. In this application, Controller 1 works as the main controller and Controller 2 works as a controller extension.

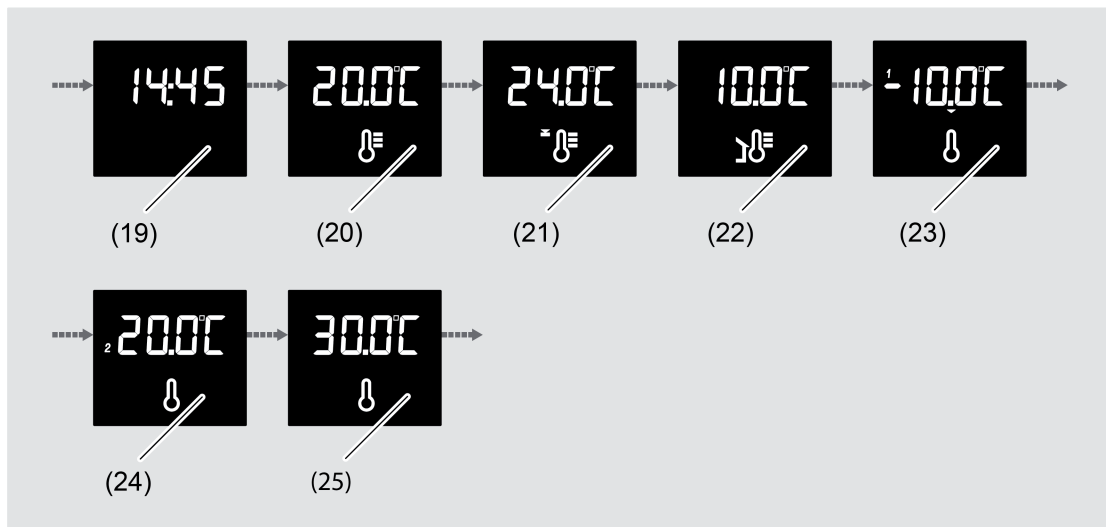

Figure 36: Possible display information of the display

- (19) Display 1: Display information "Actual temperature (via object)"
- (20) Display 2: Display information "Setpoint temperature (via object)"
- (21) Display 3: Display information "Outdoor temperature (via object)"
- (22) Display 4: Display information "Any temperature 1"
- (23) Display 5: Display information "Any temperature 2"
- (24) Display 6: Display information "Any temperature 3"

The graphic (figure 36) shows an example of seven pieces of display information, recalled at different times or by a button-press. Seven items of general display information are shown. The display shows values which the device receives via the communication objects "S.Input". These values should be regarded independently of the controllers.

In the ETS, it is possible to set the display information on the parameter pages "Display -> General -> Display information -> Display n". During the period, in which the device does not receive any valid values, the following wildcard is shown in the device display: "--.-°C" for temperatures.

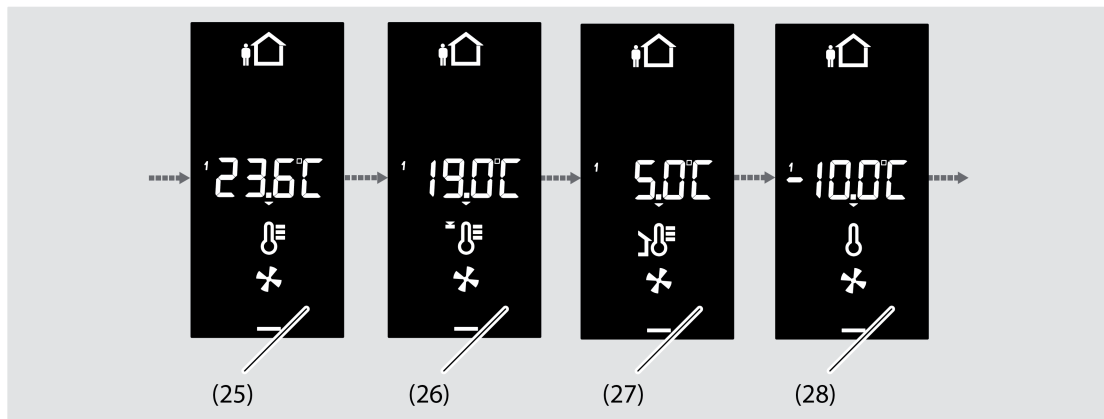

Figure 37: Possible display information of the display

- (25) Display 7: Display information "Controller 1: Actual temperature + icons"
- (26) Display 8: Display information "Controller 1: Setpoint temperature + icons"
- (27) Display 9: Display information "Controller 1: Outdoor temperature + icons"
- (28) Display 10: Display information "Controller 1: Any temperature 1 + icons"

The graphic (figure 37) shows an example of five pieces of display information, recalled at different times or by a button-press. Display information related to controller 1 are shown. The display shows values which the devices make available (e.g. actual temperature) or is received via the communication objects "C1.Input".

In the ETS, it is possible to set the display information on the parameter pages "Display -> General -> Display information -> Display n". During the period, in which the device does not receive any valid values, the following wildcard is shown in the device display: "--.-°C" for temperatures.

Indication of temperature values

The indication of the room temperature has a resolution of 0.1 °C and covers a range from -99.9 °C to +99.9 °C. The indication will refresh as soon as the determined room temperature changes within the resolution interval. Should the room temperature reach or go below +5 °C / +41 °F, the icon ✱ also flashes in the display as a temperature alarm.

The indication of the outdoor temperature has a resolution of 0.1 °C and also covers a range from -99.9 °C to +99.9 °C. The temperature display will refresh as soon as a temperature value telegram is received via the "Outdoor temperature" object. After a device reset, the display shows "--.-" until a telegram is received. If configured, the outdoor temperature will only be read on the display and cannot be used for any further temperature or variable calculation in the controller.

The setpoint temperature is indicated as an absolute temperature value. The currently adjusted setpoint temperature of the active operating mode is displayed. The device always rounds the indication to half degrees and shows the rounded-off temperature in the display. Its possible temperature range depends on the configured operating mode and is given by the fixed values for the frost and/or heat protection temperature. The indication will refresh once a new setpoint temperature for the controller results (e. g. from a change of the operating mode or of the basic setpoint, etc.).

The display of any temperatures 1 to 3 has a resolution of 0.1 °C and also covers a range from -99.9 °C to +99.9 °C. The temperature display will refresh as soon as a temperature value telegram is received via the "Any temperature display" object. After a device reset, the display

shows "---" until a telegram is received. If configured, any temperature will only be read on the display and cannot be used for any further temperature or variable calculation in the controller.

The temperatures can be indicated in °C or alternatively in °F. This display format can be configured in common for all temperature values in the "General" parameter node of the ETS.

Special display information

Programming mode is signalled by the text "Prog" on the display. If a valid application is already loaded into the device and the device is set back into Programming mode, Programming mode is signalled alternately by the text "Prog" and the displayed firmware version (e.g. "A1.00") in the display. If the device does not contain an application program - or contains the wrong one - the text "LEEr" appears. In the delivery state, the text "NEU" is shown in the display. The display shows the text "LOAd" during an active programming operation.

4.2.4.2.2 Display control

Change-over of the display

Up to 17 pieces of display information (actual temperature, setpoint temperature, outdoor temperature, any temperature) can be optionally displayed on the LC display of the device with the room temperature controller icons. (see page 89). The individual pieces of information are shown separately in the numeric display.

It is possible to switch between the information automatically after set times or, independently of this, in a controlled manner by pressing a button on the device:

- **Change-over by time:**
If more than one piece of display information is configured in the ETS in the parameter node "Display", then the display must be switched over during operation. The ETS parameter "Cyclical change of display functions" specifies the display time of a piece of information. The next piece of information is displayed when this time has elapsed. When the last piece of information has been reached, there is a changeover to the first piece of information.

 - **Change-over through button-press**
In addition to the cyclical change, the indication can also be switched by pressing a button on the device. To do this it is possible to configure a button for the "Change in the display reading" function. This configuration is performed in the parameter block of the respective button (see chapter 4.2.4.6.9. "Change in the display reading" function). This function can be configured for any desired buttons on the room controller display compact module and optionally also for buttons on the extension module.
When a button is pressed, depending on the button parameterisation either the next or the previous display information is called up in accordance with the cyclical change. With this setting the display information specified according to the configuration in the "Display" parameter node can be switched directly.
Alternatively it is also possible to call up a particular piece of information immediately independently of the display information of the cyclical change (e.g. button function "Recall display information 1"). It is not assumed here that the indication called up in this manner is in fact integrated into the cyclical change. After a piece of information is called up by pressing a button, the indication is retained until the time for the cyclical change has elapsed.
- i** In the parameter node "Display -> General -> General information -> Display *n*", it is also possible to set that no information is displayed using the parameter "Display information *n*". In this case, the normal depiction of the display is dark (only the designed button function icons are displayed). It is then only possible as necessary to call up individual display information by pressing a button using the button function "Change in the display reading". The indication called up in this manner then remains temporarily visible in the display depending on the time configured for the cyclical change.
- i** The piece of display information last called up by the cyclical change or by a button press is overridden and overwritten in the display if the device is operated locally in another way (e.g. temporary setpoint temperature display in the case of setpoint shift, menu level).

Backlighting

The display of the device has white backlighting that can be switched or dimmed. The function of the backlighting is specified in the parameter of the same name in the "Display" parameter node in the ETS. The backlighting can be switched permanently on or off. In addition, event-controlled activation of the backlighting is possible by...

- pressing any desired control surface and activating the operating mode "Night ☾" on the internal room temperature controller,
- pressing any desired operating area and the normal or inverted value of a switching telegram via the 1-bit communication object "Backlighting On / Off",
- pressing any desired operating area and the value of a value telegram via the 1-byte communication object "Backlighting brightness". The lighting can be dimmed using the value.

If the lighting is switched on by pressing a operating area (rocker or button), the device switches the lighting off automatically when the switch-off time configured in the ETS elapses. The switch-off time is retrIGGERED each time a control surface is actuated. If the lighting is to be switched on in the "Night" operating mode, the lighting remains switched on continuously when night mode is active. Switching on by pressing a button or via the operating mode "Night" always takes place using the brightness value configured in the ETS or specified locally in the menu level.

When the backlighting is switched by the 1-bit communication object (alternatively to the 1-byte object), the lighting remains switched on continuously according to the switching value (not inverted: "0" = OFF / "1" = ON; inverted: "0" = ON / "1" = OFF). Here the switch-on brightness is defined by the display brightness value configured in the ETS or specified locally in the menu level.

In the case of activation by the value object the lighting is dimmed in accordance with the received value ("1...254") or actuated to the maximum ("255"). The value "0" switches the lighting off completely.

Lighting activation by operating a operating area can be combined with switching or dimming via the corresponding objects. In this case the control via the communication objects has a higher priority. The lighting is switched on automatically by pressing a control surface, and is only switched off again when the switch-off time configured in the ETS elapses, if the lighting is to be switched off via the corresponding communication object (object value "OFF" or "0"). Switching on by pressing a button always takes place using the brightness value configured in the ETS or specified locally in the menu level.

In addition, the lighting can also be switched or dimmed by the communication objects, independently of operation on the device. In this case, the lighting is not switched off automatically when the time has elapsed. The switch-off can then only take place using a switch-off telegram in accordance with the normal or inverted telegram polarity or via a value = "0" It is not possible to switch-off backlighting switched on by operation early using a bus telegram.

- i** The brightness of the LCD backlighting in the switched-on state (always on, through button-press, night mode or 1-bit object) and the display contrast can be set locally on the device in the menu level (see chapter 2.5.2. Menu level). The brightness value set in the menu level is saved in the device in non-volatile memory, and overwrites the value last programmed using the ETS.

When the brightness value is set in the menu level, the following points must be noted in combination with the 1-byte brightness value object:

- In transition to the menu level, the lighting is switched on using the value last set via the value object. If the backlighting is controlled exclusively via the value object, the following applies: If the object value is 0...9 %, then the backlighting is controlled to 10% minimum brightness (initial value after commissioning) or to the value last selected in the menu level (5...100%). If the backlighting can also be switched on by pressing a button, the following applies: If the object value is 0...9 %, the backlighting is set to the last value programmed via the ETS or selected in the menu level (5...100 %).

In the menu level, the menu item "Brightness" always offers the value from the ETS or the value last set using the buttons "+" or "-". If the menu item "Brightness" is selected, the device always works with the brightness value displayed in the menu level (a before activation of the object value received in the menu level is then discarded).

- If a brightness value is received while the menu level is active, then when the menu level is exited a decision is made whether the settings of the operating level are saved or not. During saving, the brightness value last received by the object is discarded and the value of the menu level is adopted. If no saving is performed, the object value last received is adopted as the new brightness value. In this case the adoption takes place in the configuration "Switching on the lighting by pressing a button and value object" only after the time for automatic switch-off has elapsed.

- i** After a programming via the ETS or after a bus reset the value of the communication object of the backlighting is always "0", which means that the lighting is switched off.
- i** Switching on the backlighting or dimming it up is performed immediately. Switching off or dimming down is performed gradually (soft OFF with fixed dimming time implemented).
- i** In the un-programmed delivery state of the of the device (indication of the firmware version in the display) or during a programming process ("**Prog**" shown in the display), the brightness value of the backlighting is preset to the initial brightness (100 %).

4.2.4.2.3 Button function icons

Button function icons (only in the design ranges LS and CD!) can support the user of the device in the operation of button and rocker functions by visualising the button function. Up to eight button function icons can be configured in the ETS. Up to eight button function icons are displayed, irrespective of the device variant (2-gang or 4-gang). The button function icons 1 to 8 are each assigned to a fixed position in the display (figure 38).

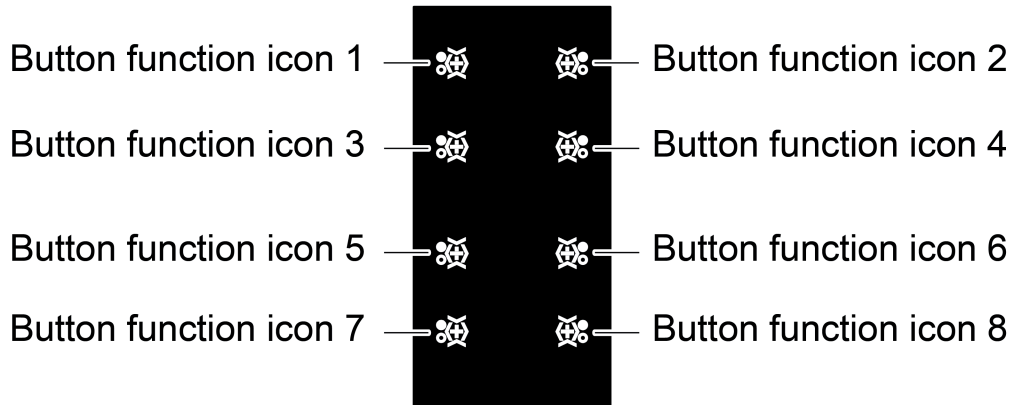

Figure 38: Arrangement of the button function icons

The button function icons are configured by making individual segments visible in the ETS. It is possible to select from the same segments for each button function icon. The 9 available segments are listed on parameter pages "Icon 1" to "Icon 8". During project design, individual segments, as well as multiple segments, can be shown. Together, all the shown segments define the button function icon.

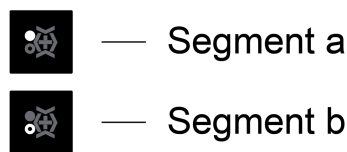

Figure 39: Button function icons: Segment a and b

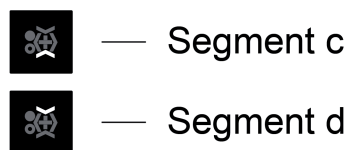

Figure 40: Button function icons: Segment c and d

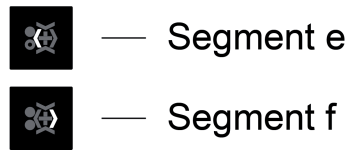

Figure 41: Button function icons: Segment e and f



Figure 42: Button function icons: Segment g, h and i

i To activate an '+' icon, segments g, h and i can jointly be switched to visible.

The defined button function icons are shown statically on the display. No button function icon is displayed when all the segments on a "Icon *n*" parameter page are set to "Hidden". In this case, the appropriate item in the display remains empty.

With the 2-gang device variant, two button function icons are available for each button.

4.2.4.3 Room temperature controller

The device unites two independent room temperature controllers (Controller 1 and Controller 2). Each controller is an independent function section of the device and has its own parameter and object range in the ETS. Therefore, the room temperature controllers can be switched on or off, irrespective of the pushbutton sensor function, or configured as a controller extension.

A controller can be used for single-room temperature control. Depending on the operating mode, current temperature setpoint and room temperature, command values for heating or cooling control and fan controller can be sent to the KNX. These command values are usually then converted by a suitable KNX actuator, e.g. heating or switching actuators or directly by bus-compatible actuating drives, evaluated and converted to physical variables for air conditioning control.

The controllers of the device can either work as a main controller or as a controller extension. As the main controller, the room temperature controller function is fully switched on and the control algorithm activated. Only the main controller transmits control value telegrams. A controller extension itself is not involved in the temperature regulating process. With it, the user can operate the single-room controller, i.e. the main controller from different places in the room. In this way, any number of operating extensions can be set up.

In this chapter, the functions of the room temperature controller are described as the main controller.

- i** The following chapters on room temperature control apply for both Controller 1 and Controller 2. The functions of both controllers are identical.

4.2.4.3.1 Operating modes and operating mode change-over

Introduction

The room temperature controller distinguishes between two different operating modes. The operating modes specify whether you want the controller to use its variable to trigger heating systems ("heating" single operating mode) or cooling systems ("cooling" single operating mode). You can also activate mixed operation, with the controller being capable of changing over between "Heating" and "Cooling" either automatically or, alternatively, controlled by a communication object.

In addition, you can establish two-level control operation to control an additional heating or cooling unit. For two-level feedback control, separate command values will be calculated as a function of the temperature deviation between the setpoint and the actual value and transmitted to the bus for the basic and additional levels. The parameter "Operating mode" in the "Room temperature control -> Controller general" parameter branch specifies the operating mode and, if necessary, enables the additional level(s).

"Heating" or "cooling" single operating modes

In the single "Heating" or "Cooling" operating modes without any additional level, the controller will always work with one command value and, alternatively, when the additional level is enabled, it will use two command values in the configured operating mode. Depending on the determined room temperature and on the specified setpoint temperatures of the operating modes (see chapter 4.2.4.3.4. Operating mode switchover) the room temperature controller will automatically decide whether heating or cooling energy is required and calculates the command value for the heating or cooling system.

"Heating and cooling" mixed operating mode

In the "Heating and cooling" mixed operating mode, the controller is capable of triggering heating and cooling systems. In this connection, you can set the change-over behaviour of the operating modes...

- "Change over between heating and cooling" parameter in the "Room temperature control -> Controller general -> Setpoints" parameter branch set to "Automatic".
In this case, a heating or cooling mode will be automatically activated, depending on the room temperature determined and on the given temperature basic setpoint, or on the deadband, respectively. If the room temperature is within the preset deadband neither heating nor cooling will take place (both command values = "0"). If the room temperature is higher than the cooling temperature setpoint cooling will take place. If the room temperature is lower than the cooling temperature setpoint heating will take place.
When the heating/cooling operating mode is changed over automatically, the information can be actively sent to the bus via the object "Heating/cooling change-over" to indicate whether the controller is working in the heating mode ("1" telegram) or in the cooling mode ("0" telegram). In this connection, the "Automatic heating/cooling change-over transmission" parameter specifies when an operating mode change-over will be transmitted...
Setting "On changing the operating mode": in this case, a telegram will be transmitted solely on change-over from heating to cooling (object value = "0") or from cooling to heating (object value = "1"), respectively.
- Setting "On changing the output command value": with this setting, the current operating mode will be transmitted whenever there is a modification of the output command value. If the variable = "0" the operating mode which was active last will be transmitted. If the room temperature determined is within the dead band the operating mode activated last will be retained in the object until a switch-over into the other operating mode takes place, if necessary. In addition, the object value can be output in cycles when automatic switch-over is being made.
The "Cyclical transmission heating/cooling change-over" parameter enables cyclic transmission (factor > "0" setting) and specifies the cycle time.
With an automatic operating mode change-over, it should be noted that under certain circumstances there will be continuous change-over between heating and cooling if the deadband is too small. For this reason, you should, if possible, not set the deadband (temperature difference between the setpoint temperatures for the comfort heating and cooling modes) below the default value (2 K).

- "Change-over between heating and cooling" parameter in the "Room temperature control -> Controller general -> Setpoints" parameter branch set to "Via object".
In this case, the operating mode is controlled via the object "Heating/cooling change-over", irrespective of the deadband. This type of change-over can, for example, become necessary if both heating and cooling should be carried out through a one-pipe system (heating and cooling system). For this, the temperature of the medium in the single-pipe system must be changed via the system control. Afterwards the heating/cooling operating mode is set via the object (often the single-pipe system uses cold water for cooling during the summer, hot water for heating during the winter).
The "Heating/cooling change-over" object has the following polarities: "1": heating; "0" cooling. After a reset, the object value will be "0", and the "Heating/cooling operating mode change-over after reset" set in the ETS will be activated. You can use the "Heating/cooling operating mode after reset" parameter to set which mode you want to activate after a reset. For the "Heating" or "Cooling" settings, the controller will activate the configured heating/cooling operating mode immediately after the initialisation phase. In case of parameterisation "Operating mode before reset" the operating mode which was selected before the reset will be activated.
If a change-over is made through the object the operating mode will first be changed into the one specified to be activated after a reset. A change-over to the other operating mode will only take place after the device receives an object update, if necessary.
Notes on the setting "Operating mode before reset": frequent changing of the operating mode (e. g. several times a day) during running operation can adversely affect the life of the device as the read-only memory (EEPROM) used has been designed for less frequent write access events only.

It is not possible to heat and cool at the same time (command value > "0"). Only for PWM, a short-time 'variable overlapping' could occur during the transition between heating and cooling, due to the matching of the variable at the end of a time cycle. However, such overlapping will be corrected at the end of a PWM time cycle.

Heating/cooling message

Depending on the set operating mode, separate objects can be used to indicate whether the controller is currently demanding heating or cooling energy and is thus actively heating or cooling. As long as the heating command value is > "0", a "1" telegram will be transmitted through the "Heating" signal object. The signal telegram is only reset when the command value is "0" ("0" telegram is transmitted). The same applies to the signal object for cooling.

- i** It should be noted that with a 2-point feedback control the message objects for heating and cooling will already become active as soon as the temperature falls short of the temperature setpoint of the active operating mode in case of heating or exceeds the temperature setpoint in case of cooling. In this case, the configured hysteresis is not taken into account.

The signal objects can be enabled by the "Heating message" or "Cooling message" parameters in the "Room temperature control -> Command value and status output" parameter branch. The control algorithm controls the signal objects. Please note that the command value is recalculated every 30 s, followed by an updating of the signal objects.

4.2.4.3.2 Control algorithms and calculation of command values

Introduction

To facilitate convenient temperature control in living or business spaces a specific control algorithm which controls the installed heating or cooling systems is required. Taking account of the preset temperature setpoints and the actual room temperature, the controller thus determines command values which trigger the heating or the cooling system. The control system (control circuit) consists of a room temperature controller, an actuator or switching actuator (when ETD electrothermal drives are used), the actual heating or cooling element (e. g. radiator or cooling ceiling) and of the room. This results in a controlled system (figure 43).

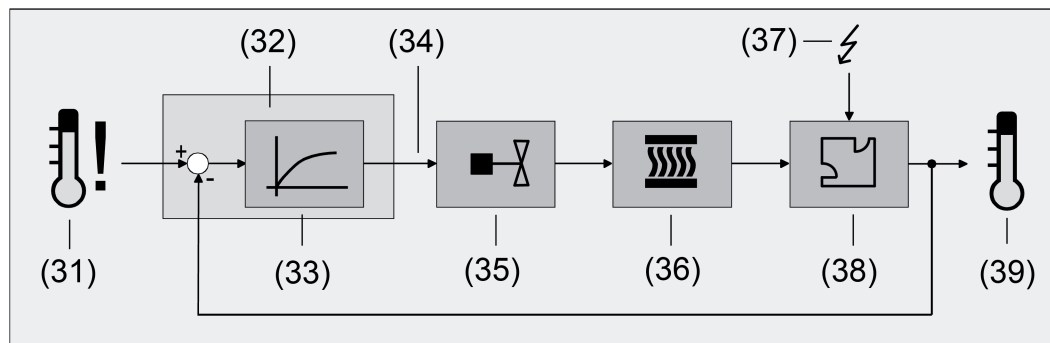

Figure 43: Controlled system of single-room temperature control

- (31) Setpoint temperature specification
- (32) Room temperature controller
- (33) Control algorithm
- (34) Command value
- (35) Valve control (actuating drive, ETD, heating actuator, ...)
- (36) Heat / cold exchanger (radiator, cooling ceiling, FanCoil, ...)
- (37) Fault variable (sunlight penetration, outdoor temperature, illumination systems, ...)
- (38) Room
- (39) Actual temperature (room temperature)

The controller measures the actual temperature (39) and compares it with the given setpoint temperature (31). With the aid of the selected control algorithm (34), the command value (35) is then calculated from the difference between the actual and the setpoint temperature. The command value controls valves or fans for heating or cooling systems (35), meaning that heating or cooling energy in the heat or cold exchangers (36) is passed into the room (38). Regular readjustment of the command value means that the controller is able to compensate for setpoint / actual temperature differences caused by external influences (37) in the control circuit. In addition, the flow temperature of the heating or cooling circuit influences the control system which necessitates adaptations of the variable.

The room temperature controller facilitates either proportional/integral (PI) feedback control as a continuously working or switching option, or, alternatively, switching 2-point feedback control. In some practical cases, it can become necessary to use more than one control algorithm. For example, in bigger systems using floor heating, one control circuit which solely triggers the floor heating can be used to keep the latter at a constant temperature. The radiators on the wall, and possibly even in a side area of the room, will be controlled separately by an additional level with its own control algorithm. In such cases, distinction must be made between the different types of control, as floor heating systems, in most cases, require control parameters which are different to those of radiators on the wall, for example. It is possible to configure up to four independent

control algorithms in two-level heating and cooling operation.

The command values calculated by the control algorithm are output via the "Heating command value" or "Cooling command value" communication objects. Depending on the control algorithm selected for the heating and/or cooling mode, the format of the command value objects is, among other things, also specified. In this way, 1-bit or 1-byte actuating objects can be created. The control algorithm is specified by the parameters "Type of heating control" or "Type of cooling control" in the "Room temperature control -> Controller general" parameter branch and, if necessary, also with a distinction of the basic and additional stages.

Continuous PI control

PI control is an algorithm which consists of a proportional part and an integral part. Through the combination of these control properties, you can obtain room temperature control as quickly and precisely as possible without or only with low deviations.

When you use this algorithm, the room temperature controller will calculate a new continuous command value in cycles of 30 seconds and send it to the bus via a 1-byte value object if the calculated command value has changed by a specified percentage. You can use the "Automatic transmission on change by..." parameter in the "Room temperature control -> Command value and status output" parameter branch to set the change interval in percent.

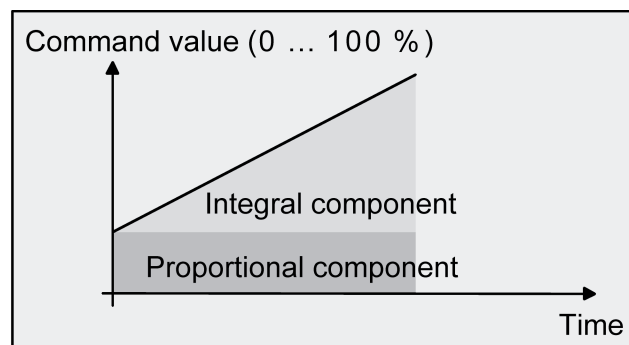

Figure 44: Continuous PI control

An additional heating or cooling level as PI control works in the same way as the PI control of the basic level, with the exception that the setpoint will shift, taking account of the configured level width.

Switching PI control

With this type of feedback control, the room temperature will also be kept constant by the PI control algorithm. Taking the mean value for a given time, the same behaviour of the control system will result as you would obtain with a continuous controller. The difference compared with continuous feedback control is only the way how the command value is output. The command value calculated by the algorithm in cycles of every 30 seconds is internally converted into a pulse-width-modulated (PWM) command value signal and sent to the bus via a 1-bit switching object after the cycle time has elapsed. The mean value of the command value signal resulting from this modulation is a measure for the averaged position of the control valve, thus being a reference to the room temperature set, taking account of the cycle time which you can set through the "Cycle time of the switching command value..." parameter in the "Room temperature control -> Command value and status output" parameter branch.

A shift of the mean value, and thus a change in the heating capacity, can be obtained by

changing the duty factor of the switch-on and switch-off pulses of the command value signal. The duty factor will be adapted by the regulator only at the end of a time period, depending on the variable calculated. This applies to any change of the command value, regardless of what the ratio is by which the command value changes (the "Automatic transmission on change by..." and "Cycle time for automatic transmission..." parameters will have no function in this case). Each command value calculated last during an active time period will be converted. Even after you have changed the setpoint temperature, for example, by switching over the operating mode, the command value will still be adapted after the end of an active cycle time. The diagram below shows the command value switching signal output according to the internally calculated command value (first of all, a command value of 30 %, then of 50 %, with the command value output not being inverted).

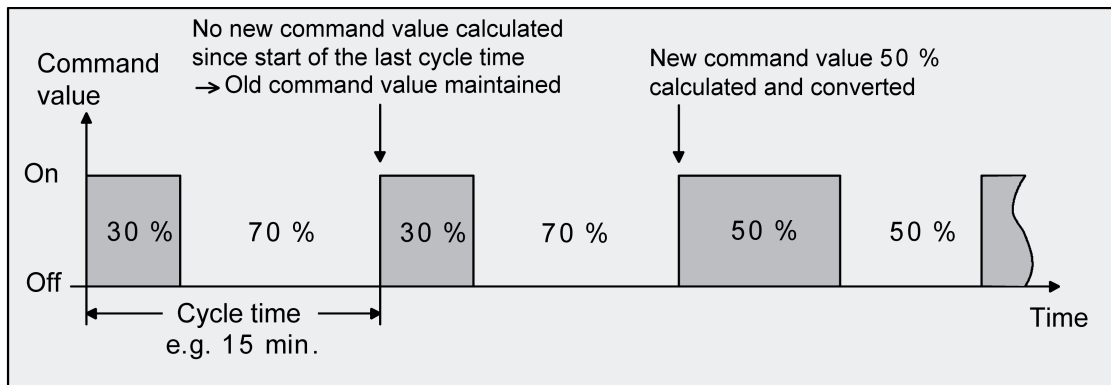

Figure 45: Switching PI control

For a command value of 0 % (permanently off) or of 100 % (permanently on), a command value telegram corresponding to the command value ("0" or "1") will always be sent after a cycle time has elapsed.

For switching PI control, the controller will always use continuous command values for internal calculation. Such continuous values can additionally be sent to the bus via a separate 1-byte value object, for example, as status information for visualisation purposes (if necessary, also separately for the additional levels). The status value objects will be updated at the same time as the command value is output and will only take place after the configured cycle time has elapsed. The parameters "automatic transmission on change by..." and "Cycle time for automatic transmission..." parameters will have no function in this case. An additional heating or cooling level as switching PI control works in the same way as the PI control of the basic stage, with the exception that the setpoint will shift, taking account of the configured level width. All PWM control options will use the same cycle time.

Cycle time:

The pulse-width-modulated command values are mainly used for activating electrothermal drives (ETD). In this connection, the room temperature controller sends the switching command values telegrams to a switching actuator equipped with semiconductor switching elements which the drives are connected to (e.g. heating actuator or room actuator). By setting the cycle time of the PWM signal on the controller, you can adapt the feedback control to the drives used. The cycle time sets the switching frequency of the PWM signal and allows adaptation to the adjusting cycle times of the actuators used (the adjusting time it takes the drive to bring the valve from its completely closed to its completely opened position). In addition to the adjusting cycle time, take account of the dead time (the time in which the actuators do not show any response when being switched or off). If different actuators with different adjusting cycle times are used, take account of the longest of the times. Always note the information given by the manufacturers of the actuators.

During cycle time configuration, a distinction can always be made between two cases...

Case 1: Cycle time $> 2 \times$ adjusting cycle time of the electrothermal drives used (ETD)

In this case, the switch-on or switch-off times of the PWM signal are long enough for the actuators to have sufficient time to fully open or fully close within a given time period.

Advantages:

The desired mean value for the command value and thus for the required room temperature will be set relatively precisely, even for several actuators triggered at the same time.

Disadvantages:

It should be noted, that, due to the full valve lift to be continuously 'swept', the life expectancy of the actuators can diminish. For very long cycle times (> 15 minutes) with less sluggishness in the system, the heat emission into the room, for example, in the vicinity of the radiators, can possibly be non-uniform and be found disturbing.

- This setting is recommended for sluggish heating systems (such as underfloor heating).
- Even for a bigger number of triggered actuators, maybe of different types, this setting can be recommended to be able to obtain a better mean value of the adjusting travels of the valves.

Case 2: Cycle time $<$ adjusting cycle time of the electrothermal drives used (ETD)

In this case, the switch-on or switch-off times of the PWM signal are too short for the actuators to have enough time to fully open or fully close within a given period.

Advantages:

This setting ensures continuous water flow through the radiators, thus facilitating uniform heat emission into the room.

If only one actuator is triggered the regulator can continuously adapt the variable to compensate the mean value shift caused by the short cycle time, thus setting the desired room temperature.

Disadvantages:

If more than one drive is triggered at the same time the desired mean value will become the command value, which will result in a very poor adjustment of the required room temperature, or in adjustment of the latter with major deviations, respectively.

The continuous flow of water through the valve, and thus the continuous heating of the drives causes changes to the dead times of the drives during the opening and closing phase. The short cycle time and the dead times means that the required variable (mean value) is only set with a possibly large deviation. For the room temperature to be regulated constantly after a set time, the controller must continually adjust the command value to compensate for the mean value shift caused by the short cycle time. Usually, the control algorithm implemented in the controller (PI control) ensures that control deviations are compensated.

- This setting is recommended for quick-reaction heating systems (such as surface radiators).

2-point feedback control

2-point feedback control represents a very simple temperature control. For this type of feedback control, two hysteresis temperature values are set. The actuators are triggered by the controller via switch-on and switch-off command value commands (1-bit type). A continuous variable is not calculated for this type of control.

The room temperature is also evaluated by this type of control in cycles every 30 seconds. Thus the command values change, if required, only at these times. The disadvantage of a continuously varying temperature as a result of this feedback control option is in contrast with the advantage of this very simple 2-point room temperature control. For this reason, quick-reaction heating or cooling systems should not be triggered by a 2-point feedback control system, for this can lead to very high overshooting of the temperature, thus resulting in loss of comfort. When presetting the hysteresis limiting values, you should distinguish between the operating modes.

"Heating" or "cooling" single operating modes:

In heating mode, the controller will turn on the heating when the room temperature has fallen below a preset limit. In heating mode, the feedback control will only turn off the heating once a preset temperature limit has been exceeded.

In cooling mode, the controller will turn on the cooling system when the room temperature has exceeded a preset limit. The control system will only turn off the cooling system once the temperature has fallen below a preset limit. In this connection, the command value "1" or "0" will be output, depending on the switching status, if the temperature exceeds or falls below the hysteresis limits.

The hysteresis limits of both operating modes can be configured in the ETS.

- i** It has to be pointed out that the message objects for heating and cooling will already become active as soon as the temperature falls short of the temperature setpoint of the active operating mode in case of heating or exceeds the temperature setpoint in case of cooling. In this case the hysteresis is not being considered.

The following two images each show a 2-point feedback control for the individual operating modes "Heating" (figure 46) or "Cooling" (figure 47). The images take two temperature setpoints, one-stage heating or cooling and non-inverted command value output.

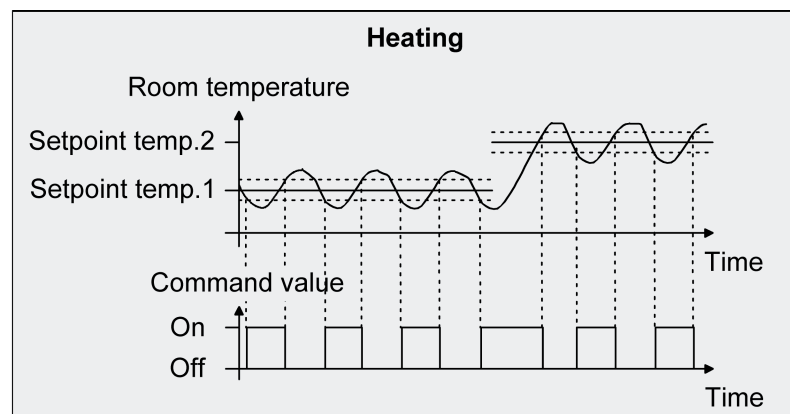

Figure 46: 2-point feedback control for the single "Heating" operating mode

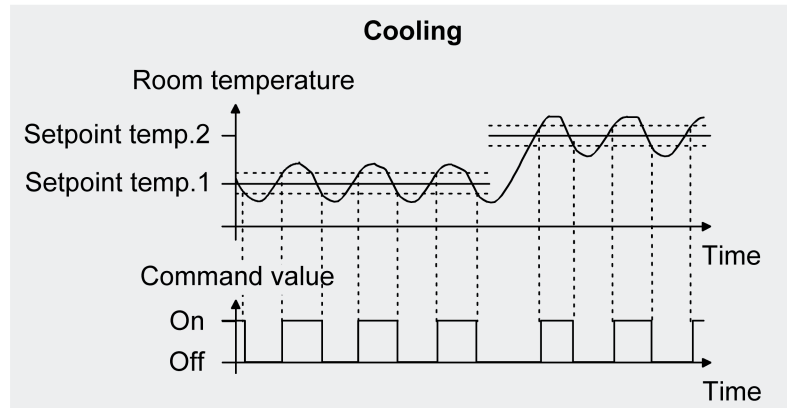

Figure 47: 2-point feedback control for the single "Cooling" operating mode

An additional 2-point feedback control heating or cooling level works exactly the same as the 2-point feedback control of the basic level. The difference is that the setpoint and the hysteresis values will shift by taking into account the configured level offset.

"Heating and cooling" mixed operating mode:

In mixed operation, a distinction is made whether the change-over between heating and cooling is to be effected automatically or in a controlled way through the object...

- With automatic operating mode change-over, in the heating mode the controller will turn on the heating when the room temperature has fallen below a preset hysteresis limit. In this case, as soon as the room temperature exceeds the setpoint of the current operating mode, the feedback control will turn off the heating in the heating mode. In the same way, in cooling mode, the controller will turn on the cooling system when the room temperature has exceeded a preset hysteresis limit. As soon as the room temperature falls below the setpoint of the current operating mode, the feedback control will turn off the cooling system in the cooling mode. Thus, in mixed operation, there is no upper hysteresis limit for heating or no lower one for cooling, respectively, for these values would be in the deadband. Within the deadband, neither heating nor cooling will take place.
- With an operating mode switchover via the object, in heating mode, the controller will turn on the heating when the room temperature has fallen below a preset hysteresis limit. The feedback control will only turn off the heating in the heating mode once the preset upper hysteresis limit has been exceeded. In the same way, in cooling mode, the controller will turn on the cooling system when the room temperature has exceeded a preset hysteresis limit. The feedback control will only turn off the cooling system in the cooling mode once the temperature has fallen below the preset lower hysteresis limit. As with the individual operating modes of heating or cooling, there are two hysteresis limits per operating mode. Although there is a deadband for the calculation of the temperature setpoints for cooling, it has no influence of the calculation of the two-point control value, as the operating mode is switched over "manually" through the corresponding object. Within the hysteresis spans, it thus will be possible to request heating or cooling energy for temperature values that are located within the deadband.

i Also, with an automatic operating mode change-over, an upper hysteresis limiting value for heating and a lower hysteresis limiting value for cooling can be configured in the ETS for 2-point control, although they have no function.

The following two images show 2-point feedback control for the mixed operating mode "Heating and cooling", distinguishing between heating mode (figure 48) and cooling mode (figure 49). The images take two temperature setpoints, a non-inverted command value output and an automatic operating mode change-over. When the operating mode is changed-over via the object, an upper hysteresis for heating and a lower hysteresis for cooling and be configured.

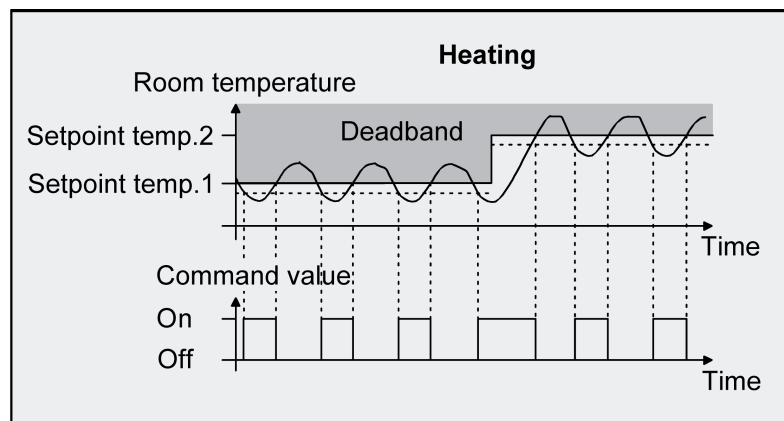

Figure 48: 2-point feedback control for mixed "Heating and cooling" mode with active heating mode.

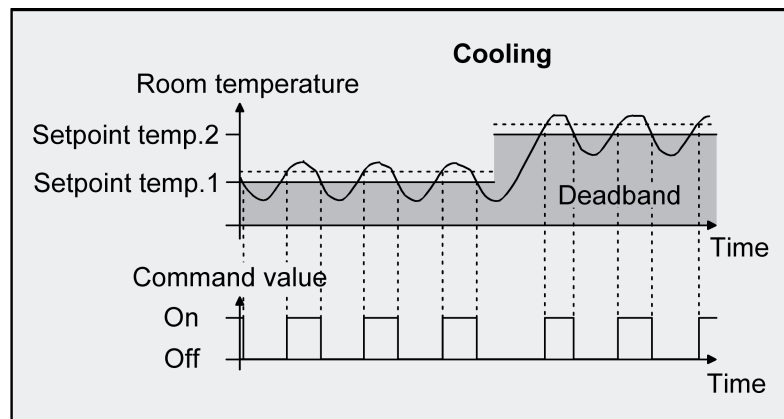

Figure 49: 2-point feedback control for mixed "Heating and cooling" mode with active cooling operation.

The command value "1" or "0" will be output, depending on the switching status, if the temperature exceeds or falls below the hysteresis limits or the setpoints.

- i** It has to be pointed out that the message objects for heating and cooling will already become active as soon as the temperature falls short of the temperature setpoint of the active operating mode in case of heating or exceeds the temperature setpoint in case of cooling. In this case the hysteresis is not being considered.

An additional 2-point feedback control heating or cooling level works exactly the same as the 2-point feedback control of the basic level. The difference is that the setpoint and the hysteresis values will shift by taking into account the configured level offset.

4.2.4.3.3 Adapting the control algorithms

Adapting the PI control

There are several systems available, which may heat or cool a room. One option is to uniformly heat or cool the surroundings via heat transfer media (preferably water or oil) in connection with room air convection. Such systems are used, for example, with wall mounted heaters, underfloor heating or cooling ceilings.

Alternatively or additionally forced air systems may heat or cool rooms. In most cases such systems are electrical forced hot air systems, forced cool air systems or refrigerating compressors with fan. Due to the direct heating of the room air such heating and cooling systems work quite swiftly.

The control parameters need to be adjusted so that the PI control algorithm may efficiently control all common heating and cooling systems thus making the room temperature control work as fast as possible and without deviation. Certain factors can be adjusted with a PI control that can influence the control behaviour quite significantly at times. For this reason, the room temperature controller can be set to predefined 'experience values' for the most common heating and cooling systems. In case the selection of a corresponding heating or cooling system does not yield a satisfactory result with the default values, the adaptation can optionally be optimised using control parameters.

Predefined control parameters for the heating or cooling stage and, if applicable, also for the additional stages are adjusted via the "type of heating" or "type of cooling" parameters. These fixed values correspond to the practical values of a properly planned and executed air conditioning system and will result in an ideal behaviour of the temperature control. The heating and cooling types shown in the following tables can be specified for heating and cooling operation.

Type of heating	Proportional range (preset)	Reset time (preset)	Recommended PI control type	Recommended PWM cycle time
Heat water heating	5 Kelvin	150 minutes	Continuous / PWM	15 min.
Underfloor heating	5 Kelvin	240 minutes	PWM	15-20 min.
Electrical heating	4 Kelvin	100 minutes	PWM	10-15 min.
Fan coil unit	4 Kelvin	90 minutes	Continuous	---
Split unit (split climate control unit)	4 Kelvin	90 minutes	PWM	10-15 min.

Table 3: Predefined control parameters and recommend control types for heating systems

Cooling type	Proportional range (preset)	Reset time (preset)	Recommended PI control type	Recommended PWM cycle time
Cooling ceiling	5 Kelvin	240 minutes	PWM	15-20 min.
Fan coil unit	4 Kelvin	90 minutes	Continuous	---
Split unit (split climate control unit)	4 Kelvin	90 minutes	PWM	10-15 min.

Table 4: Predefined control parameters and recommend control types for cooling systems

If the "Type of heating" or "Type of cooling" parameters are set to "Via control parameters" it will be possible to adjust the control parameter manually. The feedback control may be considerably influenced by presetting the proportional range for heating or for cooling (P component) and the reset time for heating or for cooling (I component).

- i** Even small adjustments of the control parameters will lead to noticeable different control behaviour.
- i** The adaptation should start with the control parameter setting for the corresponding heating or cooling system according to the fixed values mentioned in Tables 3 & 4.

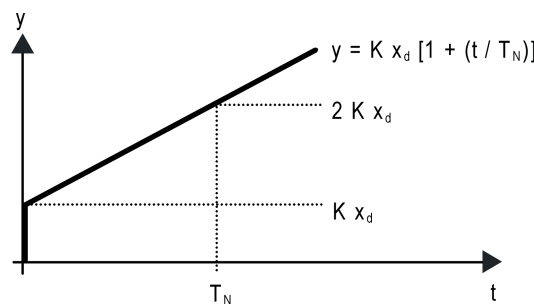

Figure 50: Function of the command value of a PI control

y: Command value
 x_d : Control difference ($x_d = x_{set} - x_{act}$)
 $P = 1/K$: Configurable proportional band
 $K = 1/P$: Gain factor
 T_N : Configurable reset time

PI control algorithm: Command value $y = K x_d [1 + (t / T_N)]$

Deactivation of the reset time (setting = "0") ->
 P control algorithm: Command value $y = K x_d$

Parameter setting	Effect
P: Small proportional range	Large overshoot in case of setpoint changes (possibly permanently), quick adjustment to the setpoint
P: Large proportional range	no (or small) overshooting but slow adjustment
T_N : Short reset time	Fast compensation of control deviations (ambient conditions), risk of permanent oscillations
T_N : Long reset time	Slow compensation of control deviations

Table 5: Effects of the settings for the control parameters

Adapting the 2-point feedback control

2-point feedback control represents a very simple temperature control. For this type of feedback control, two hysteresis temperature values are set. The upper and lower temperature hysteresis limits can be adjusted via parameters. It has to be considered that...

- A small hysteresis will lead to small temperature variations but to a higher bus load.
- A large hysteresis switches less frequently but will cause uncomfortable temperature variations.

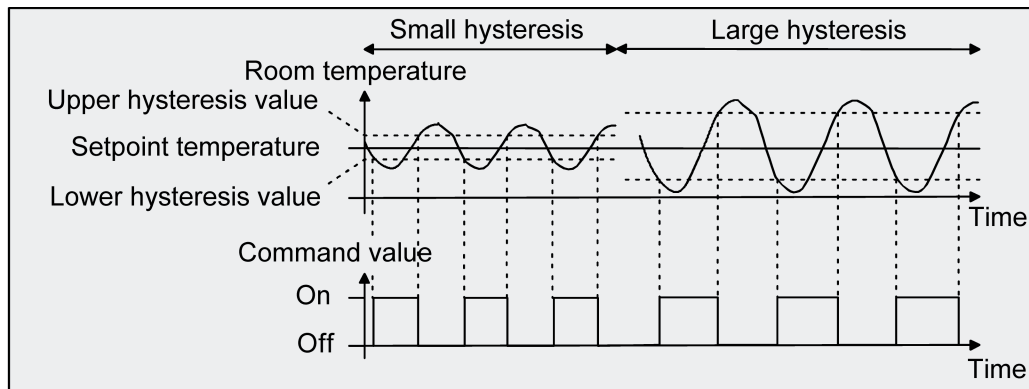

Figure 51: Effects of the hysteresis on the switching behaviour of the command value of 2-point feedback control

4.2.4.3.4 Operating mode switchover

Introduction - The operating modes

The room temperature controller has various operating modes. The selection of these modes will, for example, facilitate the activation of different temperature setpoints, depending on the presence of a person, on the state of the heating or cooling system, on the time of the day, or on the day of the week. The following operating modes can be distinguished...

- Comfort mode



Comfort mode is usually activated if persons are in a room, and the room temperature should, for this reason, be adjusted to an adequately convenient value. The change-over to this operating mode can take place either by pressing a button or with presence control, for example, using a PIR motion detector on the wall or a ceiling mounted detector. An activated comfort mode can be indicated by the function of a status LED.

- Standby mode



If a room is not used during the day because persons are absent, you can activate the Standby mode. Thereby, you can adjust the room temperature on a standby value, thus to save heating or cooling energy, respectively. The activated standby mode can be indicated by the function of a status LED.

- Night operation



During the night hours or during the absence of persons for a longer time, it mostly makes sense to adjust the room temperature to lower values for heating systems (e.g. in bedrooms). In this case, cooling system can be set to higher temperature values, if air conditioning is not required (e.g. in offices). For this purpose, you can activate the Night mode. The activated night mode can be indicated by the function of a status LED.

- Frost/heat protection mode



Frost protection will be required if, for example, the room temperature must not fall below critical values while the window is open. Heat protection can be required where the temperature rises too much in an environment which is always warm, mainly due to external influences. In such cases, you can activate the Frost/heat protection operating mode and prescribe some temperature setpoint of its own for either option, depending on whether "Heating" or "Cooling" has been selected, to prevent freezing or overheating of the room.

The activated frost/heat protection can be indicated by the function of a status LED.

- Comfort extension (temporary Comfort mode)

You can activate the comfort extension from the night or frost/heat protection mode (not triggered by the "Window status" object) and use it to adjust the room temperature to a comfort value for some time if, for example, the room is also 'used' during the night hours. This mode can exclusively be activated by a presence button or also by the presence object, respectively. The comfort extension option will be automatically deactivated after a definable time has elapsed, or by pressing the presence button once more, or by receiving a presence object value = 0, respectively. You cannot retrigger this extension.

The activated comfort prolongation option can be indicated by the function of a status LED.

- i** You can assign an own temperature setpoint to the "Heating" or "Cooling" operating modes for each operating mode.

Operating mode switchover

You can activate or switch over the operating modes in various ways. Depending on one another in priority, activation or change-over is possible by...

- Local control on the room controller display compact module using push button function (controller operation) and configured operating mode change-over,
- KNX communication objects separately available for each operating mode or alternatively through the 1-byte object "Operating mode change-over". In the last case, also through a controller extension.

The following section describes the individual options for changing over the operating modes in more detail.

- i** The presence message, the window status and the forced object for operating mode switchover (see following sections) have a higher priority than the change-over of the operating mode via the controller operation. Therefore, change-overs by evaluating the appropriate objects have priority.

Change-over of the operating mode using button function

As soon as a button of the TSM is configured to "Controller operating", the "Operating mode change-over" function can be configured in the button parameters. In this case, a further definition is required in the ETS configuration as to which operating mode is activated when a button is pressed. For this purpose, the "comfort", "standby", "night" and "frost/heat protection" modes are available.

To be able to activate the comfort extension, it is possible to use a presence button either optionally or in addition. The presence button, just as with the operating mode change-over, is a

button function of the TSM for the controller operating mode. The presence button means it is possible to change to the comfort extension or to deactivate it prematurely when Night or Frost/heat protection mode (not activated by the "Window status" object) has been activated. Also, it is possible to change over from the Standby to the Comfort mode when the presence button is pressed.

The function of the status LED of a button can be configured irrespective of the button function. For example, it is possible that the controller status LED is controlled by a separate communication object.

Change-over of the operating mode using KNX/EIB communication objects

A distinction is made whether the operating modes should be changed over via separate 1-bit objects or, alternatively, by the 1-byte objects.

The "Operating mode change-over" parameter in the "Room temperature control -> Controller general" parameter branch specifies the switching method as follows:

- Operating mode change-over "Via switching (4 x 1 bit)"

There is a separate 1-bit change-over object for each operating mode. Each of these objects allows the current operating mode to be switched over or to be set, depending on the priority. Taking account of the priority, a specific hierarchy will result from the operating mode switchover by the objects, a distinction being made between presence detection by the presence button or the presence detector. In addition, the status of the window in the room can be evaluated using the "Window status" object, meaning that, when the window is open, the controller can switch to Frost/heat protection mode, irrespective of the set operating mode, in order to save energy.

Table 6 also shows the status of the communication objects and the resulting operating mode.

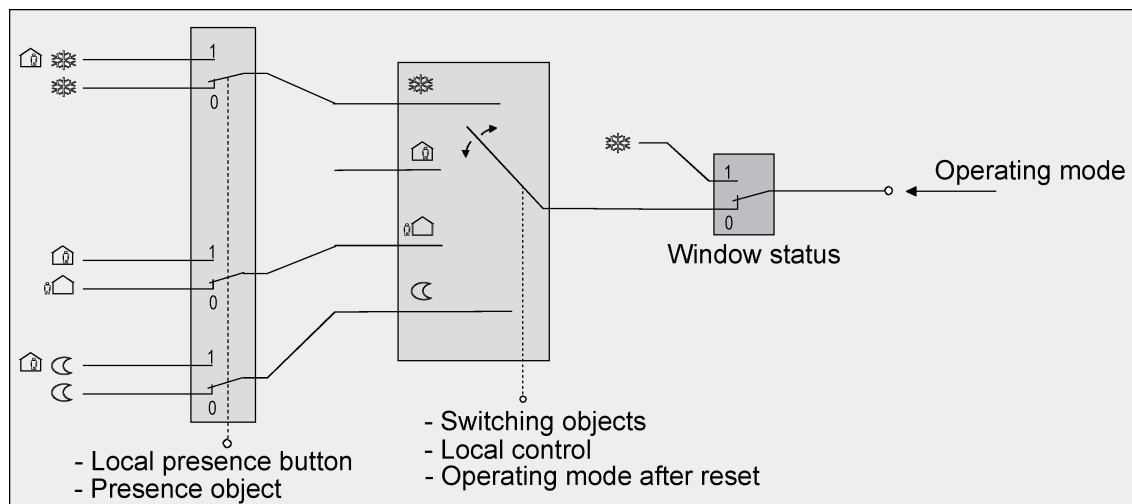

Figure 52: Operating mode change-over through 4 x 1-bit objects with presence button

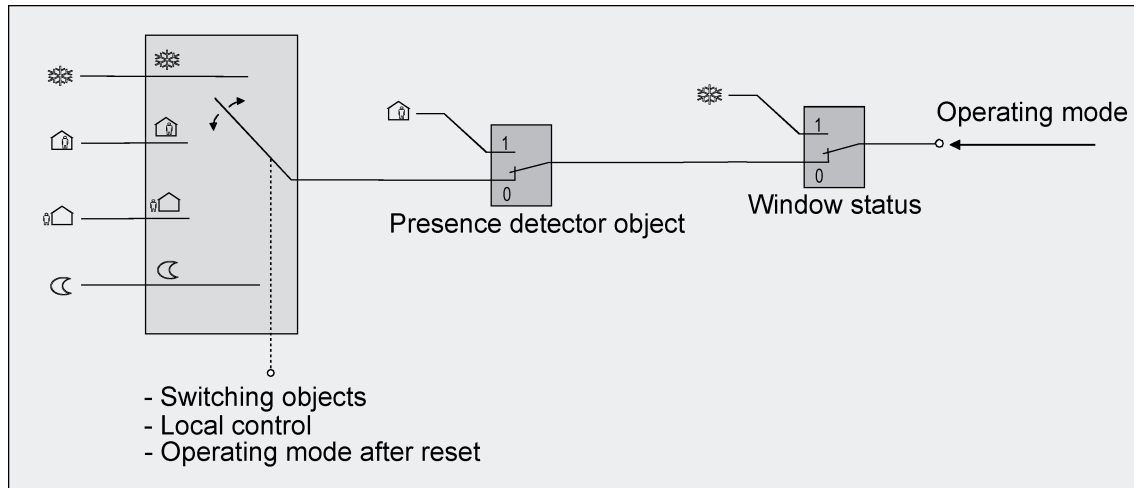

Figure 53: Operating mode change-over through 4 x 1-bit objects with presence detector

Object ❄	Object 🏠	Object 🪟	Object 🌙	Object "Window status"	Motion button	Motion detector	Resulting operating mode
1	X	X	X	0	0	-	Frost/heat protection
0	1	X	X	0	0	-	Comfort mode
0	0	1	X	0	0	-	Standby mode
0	0	0	1	0	0	-	Night operation
0	0	0	0	0	0	-	no change / last state
X	X	X	X	1	X	-	Frost/heat protection
1	X	X	X	0	1	-	Comfort extension
0	1	X	X	0	1	-	Comfort mode
0	0	1	X	0	1	-	Comfort mode
0	0	0	1	0	1	-	Comfort extension
0	0	0	0	0	1	-	Comfort mode/extension *
1	X	X	X	0	-	0	Frost/heat protection
0	1	X	X	0	-	0	Comfort mode
0	0	1	X	0	-	0	Standby mode
0	0	0	1	0	-	0	Night operation
0	0	0	0	0	-	0	no change / last state
X	X	X	X	1	-	X	Frost/heat protection
X	X	X	X	0	-	1	Comfort mode

Table 6: Status of the communication objects and the resulting operating mode

X: Status irrelevant

-: Not possible

*: Dependent on the last active operating mode.

- i** When changing over the operating mode, the objects "Comfort mode", "Standby mode", "Night mode" and "Frost/heat protection" are updated by the controller and can be read out when the appropriate Read flags are set. If the "Transmit" flag has been set for these objects the current values will, in addition, be automatically transmitted to the bus when they are changed. After bus voltage recovery or after initialisation of the controller, the object which corresponds to the selected operating mode will be updated and its value actively transmitted to the bus if the "Transmit" flag has been set.
 - i** A change-over through the objects has the same importance as a local change-over on the device (button as controller operation). An operating mode set by an object can therefore be shifted by an operating mode change-over on the device, if no higher-priority mode (e.g. window contact / presence detector) is activated.
 - i** In parameterisation of a presence button: the presence object will be active ("1") for the period of an comfort extension. The presence object will be automatically deleted ("0") if the comfort extension is stopped after the extension time has elapsed, or if the operating mode has been changed by a higher-priority operation through the change-over objects or by local control. The controller therefore automatically resets the status of the presence button when an object is received via the operating mode objects.
- Operating mode change-over through "value (1 byte)"

There is a common 1-byte change-over object for all operating modes. During the running time, the operating mode can be changed over through this value object immediately after the receipt of only one telegram. In this connection, the value received will set the operating mode. In addition, a second 1-byte object is available which, by forced control and through higher level, can set an operating mode, irrespective of any other change-over options. According to the KNX specification, both 1-byte objects have been implemented. Taking account of the priority, a specific hierarchy will result from the operating mode change-over by the objects, a distinction being made between presence detection by the presence button (figure 54) or the presence detector (figure 55). In addition, the status of the window in the room can be evaluated using the "Window status" object, meaning that, when the window is open, the controller can switch to Frost/heat protection mode, irrespective of the set operating mode, in order to save energy . Table 7 also shows the status of the communication objects and the resulting operating mode.

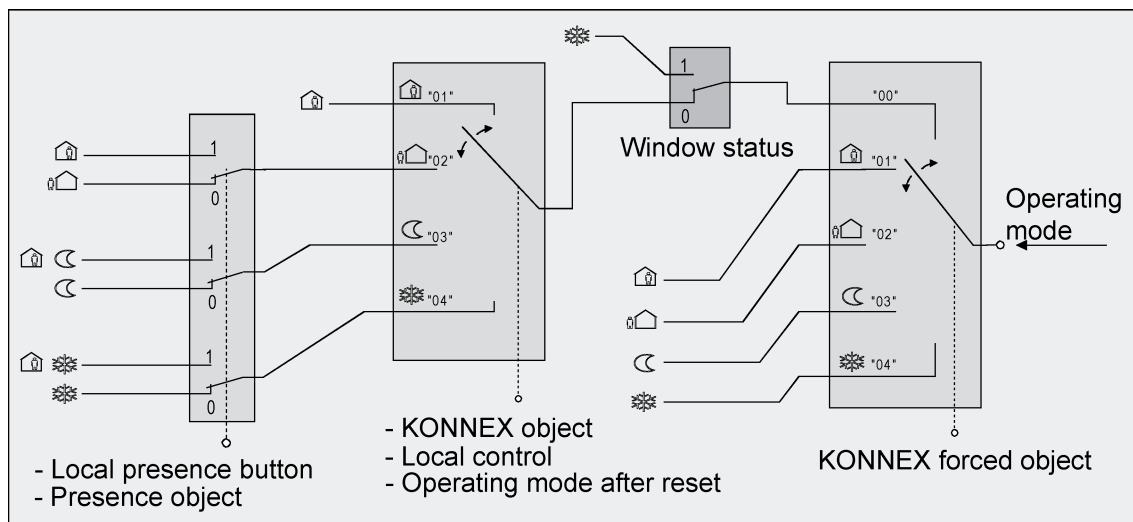

Figure 54: Operating mode change-over through KONNEX object with presence button

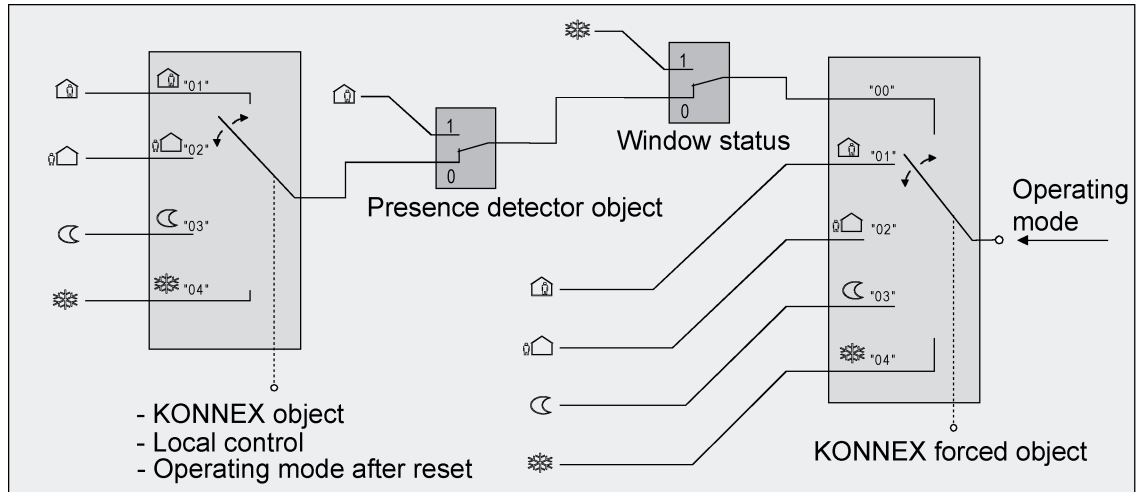

Figure 55: Operating mode change-over through KONNEX object with presence detector

Object value "Operating mode change-over"	Object value "Forced object operating mode"	Object "Window status"	Motion button	Motion detector	Resulting operating mode
00	00	0	X	0	Undefined status, no modification
01	00	0	0	-	Comfort mode
02	00	0	0	-	Standby mode
03	00	0	0	-	Night operation
04	00	0	0	-	Frost/heat protection
01	00	0	1	-	Comfort mode
02	00	0	1	-	Comfort mode
03	00	0	1	-	Comfort extension
04	00	0	1	-	Comfort extension
01	00	0	-	0	Comfort mode
02	00	0	-	0	Standby mode
03	00	0	-	0	Night operation
04	00	0	-	0	Frost/heat protection
X	00	0	-	1	Comfort mode
X	00	1	-	X	Frost/heat protection
X	00	1	X	-	Frost/heat protection
X	01	X	X	X	Comfort mode
X	02	X	X	X	Standby mode
X	03	X	X	X	Night operation

X	04	X	X	X	Frost/heat protection
---	----	---	---	---	-----------------------

Table 7: Status of the communication objects and the resulting operating mode

X: Status irrelevant

-: Not possible

- i** When changing over an operating mode, for example through local control, the KONNEX switching object is updated by the controller and can be read out when the "Read" flag is set. If the "Transmit" flag has been set for this object the current value will, in addition, be automatically transmitted to the bus when it is changed.
After bus voltage recovery or after initialisation of the controller, the value corresponding to the set operating mode will be actively transmitted to the bus if the "Transmit" flag has been set. The "Transmit" flag must always be set when using controller extensions.
- i** Change-over by the KONNEX object "Operating mode change-over" has the same priority as a local change-over on the push-button sensor. An operating mode set by the object (e.g. by a controller extension) can therefore be shifted by an operating mode change-over on the device, if no higher-priority mode (e.g. window contact / presence detector) or the KONNEX forced object is activated.
The KONNEX override object will always have the highest priority.
- i** In parameterisation of a presence button: the presence object will be active ("1") for the period of an active comfort extension. The presence object will be automatically deleted ("0") if the comfort extension is stopped after the extension time has elapsed, or if the operating mode has been changed by a higher-priority operation through the change-over objects or by local control or a forced operating mode is deactivated by the KONNEX forced object (forced object -> "00"). The controller therefore automatically resets the status of the presence button when an object value is received via the operating mode objects or the forced object is reset.

Additional information on the Presence function / Comfort extension

With presence detection, the room temperature controller can quickly change over to a comfort extension upon push button actuation or go into the Comfort mode when movement by a person in the room is detected. In this connection, the "Presence detection" parameter in the "Room temperature control -> Controller functionality" parameter node sets whether presence detection should be movement-controlled by a motion detector or manual through presence button actuation...

- Presence detection by the presence button

If the presence button is configured for presence detection, you can select the "Presence button" setting in the "Controller operation" button functions. In addition, the "Presence object" is enabled. In this way, you can actuate the presence button or use a presence object value = "1" to change over to comfort extension when the Night or the Frost/heat protection mode is active (not activated by the "window status" object). The extension will be automatically deactivated as soon as the configured "Length of comfort extension" time has elapsed. If you press the presence button once more, or if the presence object receives a value = "0", you can deactivate the comfort extension earlier. You cannot re-trigger such extension time.

If you have set the length of comfort extension to "0" in the ETS, you cannot activate a comfort extension from the night or frost/heat protection mode. In this case, the operating mode will not be changed, although the presence function has been activated.

If the standby mode is active you can operate the presence button or use a presence object value = "1" to change over to the comfort mode. This will also be the case if you have configured the length of comfort prolongation to "0". The comfort mode will remain active as long as the presence function remains active, or until another operating mode comes into effect.

The presence object or the presence function, respectively, will always be deleted whenever a change-over to a different operating mode takes place, or after a forced operating mode has been deactivated (associated with KONNEX forced change-over). A presence function activated before a device reset (programming operation, bus voltage failure) is always deleted, along with the object value, after the reset.

- Presence detection by the presence detector

If a motion detector is configured for motion detection, then the controller only evaluates the "Presence object". With this object, it is possible to integrate presence detectors into room temperature control. If a movement is detected ("1" telegram) the controller will change over into the Comfort mode. In this connection, it is irrelevant what has been set by the change-over objects or by local control directly on the device. Only a window contact or the KONNEX forced object are of higher priority.

After the movement delay time has elapsed in the presence detector ("0" telegram), the controller will return to the operating mode which was active before presence detection, or it will compensate the telegrams of the operating mode objects received during presence detection, respectively. During active presence detection, you cannot change-over the operating mode on the room temperature controller.

A presence function activated before a device reset (programming operation, bus voltage failure) is always deleted, along with the object value, after the reset. In this case, the presence detector must transmit a new "1" telegram to the controller to activate the presence function.

- i** If the motion detector is configured for presence detection, it is always possible to configure the presence button in the "Controller operation" button functions. However, this parameterisation then has no effect.

Additional information on the window status and the automatic frost protection

The room temperature controller offers various options to change over into the Frost/heat protection mode. In addition to the switchover by the corresponding operating mode switchover object or by room temperature controller operation on the TSM (button function), the frost/heat protection mode can be activated by a window contact or, alternatively, frost protection can be activated by an automatic temperature control option. With these options, the window contact or the automatic function has higher priority. You can use the "frost/heat protection" parameter in the "room temperature control -> controller general" parameter branch to set the way how such higher-priority switch-over will take place...

- Frost/heat protection switch-over "via window status"
The 1-bit object, "window status" is enabled. A telegram having the value of = "1" (open window) and sent to this object will activate the frost/heat protection mode. If this is the case, the operating mode cannot be deactivated, neither by local operation nor by the switch-over objects (with the exception of the KNX override object). Only a telegram with the value of = "0" (closed window) will reset the window status and deactivate the frost/heat protection mode. After this, the operating mode set before the opening of the window or that mode carried by the bus while the window was open will be activated.
You can optionally parameterise a window status delay. This delay can make sense if short ventilation of the room by opening the window is not supposed to cause an operating mode switchover. You can use the "window status delay" parameter to set this delay time between 1 and 255 minutes. The window status will only be changed and thus the frost/heat protection mode activated after this parameterized time has elapsed. A setting of "0" will effect the immediate activation of the frost/heat protection mode when the window is open. The window status will be in effect in the heating and in the cooling mode. The value of the object "window status" is deleted after a reset.

 - Frost protection mode switch-over by "automatic frost protection"
For this setting, automatic switch-over to the frost protection mode can be made at times, depending on the room temperature determined. If there are no window contacts, this setting can prevent unnecessary heating up of the room when windows or external doors are open. In connection with this function, a quick temperature drop can be detected by measuring the actual temperature every minute as, for example, is the case when a window is open. If the temperature decrease detected reaches a parameterised value the room temperature regulator will automatically switch over to the frost protection mode. You can use the "automatic frost protection temperature drop" parameter to set the maximum temperature drop in K/min for switching over to the frost protection mode. After the time preset by the "frost protection period in automatic mode" parameter has elapsed, the regulator will return into the mode which was set before frost protection. Re-triggering will not be possible.
If a new operating mode was received during the frost protection when switching over by 1-byte via the KNX switch-over object, this tracked mode is set according to the automatic frost protection. If a switch-over was made by 4 x 1 bit during frost protection via the change-over object, then this newly received mode will be discarded after the end of the automatic frost protection. The controller then remains in frost protection. Only after that can the operating mode be switched over by the objects or locally on the device. The KNX override object has a higher priority than the automatic frost protection mode and can interrupt the latter.
- i** The automatic frost protection mode only acts on heating for temperatures below the set value temperature of the operating mode selected. Thus, no automatic switch-over to frost protection can take place at room temperatures in the dead band or in the active cooling mode if the "heating and cooling" operating mode is on. Automatic heat protection activation is not intended with this parameterization.

- i** When a window is open or when the automatic frost protection is active, it is not possible to switch over the controller operating mode using buttons with the "Controller operation" function, and not in the menu for the settings. A button press will thus not be effected after the window closes, or at the end of the automatic frost protection.
- i** Frequent draughts in a room can cause unintentional activation/deactivation of frost protection when the automatic frost protection mode is active, and if the parameterized temperature decrease is not low enough. Therefore switching into the frost/heat protection mode by window contacts should generally be preferred to the automatic option.

Additional information on the operating mode after a reset

In the ETS, it is possible to use the "Operating mode after reset" parameter in the "Room temperature control -> Controller general" parameter node to set which operating mode should be activated after bus voltage recovery or re-programming by the ETS. The following settings are possible...

- "Comfort operation" -> The comfort mode will be activated after the initialisation phase.
- "Standby mode" -> The standby mode will be activated after the initialisation phase.
- "Night operation" -> The night mode will be activated after the initializing phase.
- "Frost/heat protection operation" -> The frost/heat protection mode will be activated after the initialisation phase.

- "Restore operation mode before reset" -> The mode set before a reset according to the operating mode object or by pushbutton function (normal priority) will be restored after the initialisation phase of the device. Operating modes set by a function with a higher priority before the reset (Forced, Window status, Presence status) are not effected.

The objects associated with the activated operating mode will be updated after a reset.

- i** Note on the "restore operation mode before reset" setting:
Frequent changing of the operating mode (e. g. several times a day) during running operation can adversely affect the life of the device as the read-only memory (EEPROM) used has been designed for less frequent write access events only.

4.2.4.3.5 Temperature setpoints

Setpoint temperature presetting

Temperature setpoints can be preset for each operating mode in the ETS as part of first configuration. It is possible to configure the setpoints for the "Comfort", "Standby" and "Night" modes directly (absolute setpoint presetting) or relatively (derivation from basic setpoint). The setpoint temperatures can later be adapted during regular operation if desired, controlled by the KNX communication objects.

- i** The "Frost/heat protection" operating mode allows the separate configuration of two temperature setpoints for heating (frost protection) and cooling (heat protection) solely in the ETS. These temperature values cannot be changed later during controller operation.

The "Setpoint presetting" parameter on the parameter page "Room temperature control -> Controller general -> Setpoints" defines the way the setpoint temperature is preset...

- "Relative (setpoint temperatures from basic setpoint)" setting:
When presetting the set-temperatures for comfort, standby and night mode, attention has to be paid to the fact that all setpoints depend on each other as all values are derived from the basic temperature (basic setpoint). The "Basic temperature after reset" parameter in the "Room temperature control -> Controller general -> Setpoints" parameter page determines the basic setpoint, which is loaded when the device is programmed via the ETS. Taking into account the "Reduce / increase the setpoint temperature in standby mode" or "Reduce / increase the setpoint temperature in night mode" parameters the temperature setpoints for the standby and night mode are derived from this value depending on the heating or cooling operating mode. The deadband will be additionally considered for the "Heating and cooling" operating mode.
The 2-byte object "Basic setpoint" provides the option of changing the basic temperature, and thus all the dependent setpoint temperatures during device operation. A change via the object must always be enabled in the ETS by configuring the parameter "Change the basic temperature setpoint via bus" to "Approve". If the basic setpoint adjustment via the bus is disabled, the "Basic setpoint" object will be hidden. The controller rounds the temperature values received via the object to the configured interval of the basic setpoint shift (0.1 K or 0.5 K).
- "Absolute (independent setpoint temperatures)" setting
The setpoint temperatures for comfort, standby and night mode are independent of each other. Depending on the operating mode and heating/cooling mode, various temperature values can be specified in the ETS within the range +7.0 °C to +40.0 °C. The temperature values are not checked in the ETS. It is thus possible, for example, to select smaller setpoint temperatures for cooling mode than for heating mode, or to specify lower temperatures for comfort mode than for standby mode.
After commissioning using the ETS the setpoint temperatures can be changed via the bus by means of temperature telegrams. This can be done using the communication object "Setpoint active operating mode". When the controller receives a telegram via this object, it immediately sets the received temperature as the new setpoint of the active operating mode, and operates from then on with this setpoint. In this manner it is possible to adapt the setpoint temperatures of all operating modes separately for heating and cooling mode. The frost or heat protection temperature programmed in using the ETS cannot be changed in this manner.
- i** With absolute setpoint presetting there is no basic setpoint and also no deadband in the mixed operating mode "Heating and cooling" (if necessary also with additional level). Consequently the room temperature controller cannot control the switch-over of the operating mode automatically, which is why in this configuration the setting for the parameter "Switch-over between heating and cooling" is fixed in the ETS to "Via object". Furthermore, setpoint shifting does not exist for absolute setpoint presetting.

- i** Since the setpoint shift option is not necessary when using the absolute setpoint presetting, the status LED function "Setpoint value shift display" is also ineffective.

The temperature setpoints programmed in the room temperature controller by the ETS during commissioning can be changed via communication objects. In the ETS the parameter "Override setpoints in device during ETS programming operation?" can be used on the parameter page "Room temperature control -> Controller general -> Setpoints" to define whether the setpoints present in the device, which may have been changed subsequently, are overwritten during an ETS programming operation and thus replaced again by the values parameterised in the ETS. If this parameter is on "Yes", then the temperature setpoints are deleted in the device during a programming operation and replaced by the values of the ETS. If this parameter is configured to "No", then setpoints present in the device remain unchanged. The setpoint temperatures entered in the ETS then have no significance.

- i** During initial commissioning of the device the parameter "Override setpoints in device during ETS programming operation?" must be set to "Yes" in order to perform valid initialisation of the memory slots in the device. The setting "Yes" is also necessary if essential controller properties (operating mode, setpoint presetting, etc.) are being changed in the ETS using new parameter configurations!

Setpoint temperatures for relative setpoint presetting

Depending on the operating mode, different cases should be distinguished when specifying the relative setpoint temperature, which then have an impact on the temperature derivation from the basic setpoint.

Setpoints for operating mode "Heating"

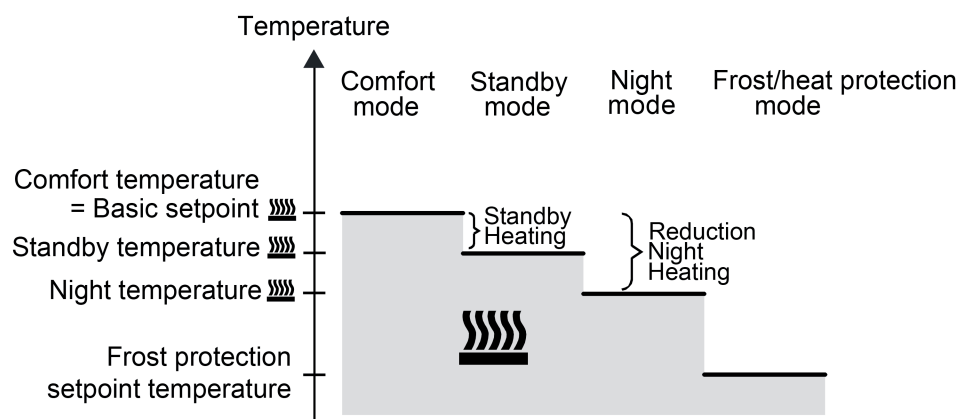

Figure 56: Setpoint temperatures in the operating mode "Heating"

The setpoint temperatures for comfort, standby and night mode exist for this operating mode. The frost protection temperature can be preset (figure 56).
The following applies

$$T_{\text{Standby setpoint heating}} \leq T_{\text{Comfort setpoint heating}}$$

or

$$T_{\text{Night setpoint heating}} \leq T_{\text{Comfort setpoint heating}}$$

The standby and night setpoint temperatures are derived from the reduction temperatures configured in the ETS from the comfort setpoint temperature (basic setpoint). The frost protection is supposed to prevent the heating system from freezing. For this reason the frost protection temperature (default: +7 °C) should be to a set smaller value than the night temperature. In principle, however, it is possible to select frost protection temperature values between +7.0 °C and +40.0 °C. The possible range of values for a setpoint temperature lies between +7.0 °C and +99.9 °C for "heating" and is bounded by the frost protection temperature in the lower range.

The level offset configured in ETS will be additionally considered in a two-level heating mode (figure 57).

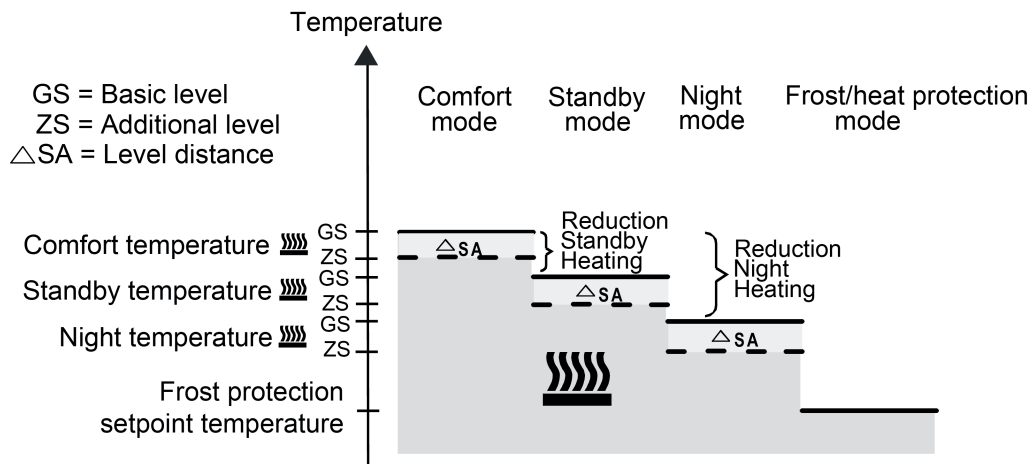

Figure 57: Setpoint temperatures in the operating mode "Basic and additional heating"

$$T_{\text{Comfort setpoint additional level heating}} \leq T_{\text{Comfort setpoint basic level heating}}$$

$$T_{\text{Standby setpoint additional level heating}} \leq T_{\text{Standby setpoint basic level heating}}$$

$$T_{\text{Standby setpoint heating}} \leq T_{\text{Comfort setpoint heating}}$$

or

$$T_{\text{Comfort setpoint additional level heating}} \leq T_{\text{Comfort setpoint basic level heating}}$$

$$T_{\text{Night setpoint additional level heating}} \leq T_{\text{Night setpoint basic level heating}}$$

$$T_{\text{Night setpoint heating}} \leq T_{\text{Comfort setpoint heating}}$$

Setpoints for the "cooling" operating mode

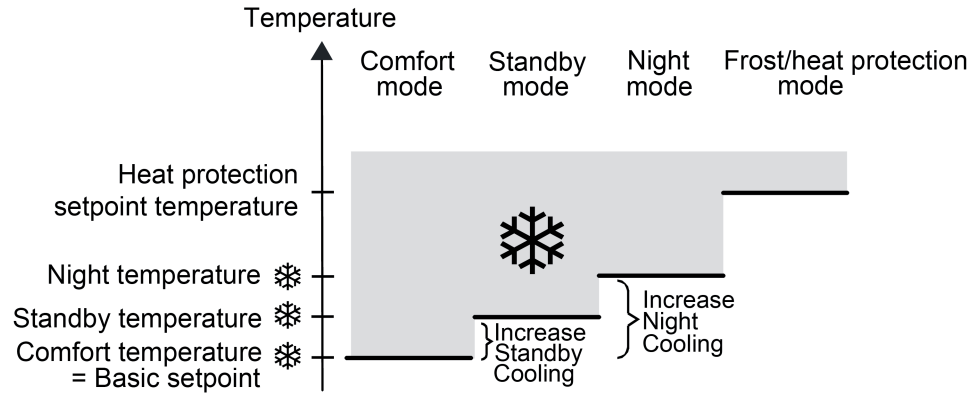

Figure 58: Setpoint temperatures in the operating mode "Cooling"

The setpoint temperatures for comfort, standby and night mode exist for this operating mode. The heat protection temperature can be preset (figure 58). The following applies...

$$T_{\text{Comfort setpoint cooling}} \leq T_{\text{Standby setpoint cooling}}$$

or

$$T_{\text{Comfort setpoint cooling}} \leq T_{\text{Night setpoint cooling}}$$

The standby and night set-temperatures are derived after the configured increase temperatures from the comfort set-temperature (basic setpoint). The heat protection is supposed to ensure that the temperature does not exceed the maximum permissible room temperature in order to protect system components. For this reason the heat protection temperature (default: +35 °C) should be set to a larger value than the night temperature. In principle, however, it is possible to select heat protection temperature values between +7.0 °C and +45.0 °C. The possible range of values for a setpoint temperature lies between -99.9 °C and +45.0 °C for "cooling" and is bounded by the heat protection temperature in the upper range.

The level offset configured in ETS will be additionally considered in a two-level cooling mode (figure 59).

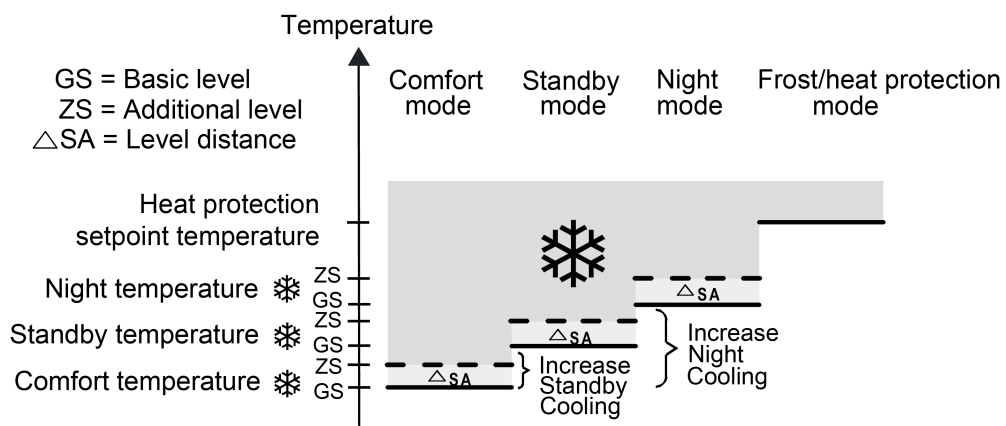

Figure 59: Setpoint temperatures in the operating mode "Basic and additional cooling"

$T_{\text{Comfort setpoint basic level heating}} \leq T_{\text{Comfort setpoint additional level heating}}$
 $T_{\text{Standby setpoint basic level heating}} \leq T_{\text{Standby setpoint additional level heating}}$
 $T_{\text{Comfort setpoint cooling}} \leq T_{\text{Standby setpoint cooling}}$

or

$T_{\text{Comfort setpoint basic level heating}} \leq T_{\text{Comfort setpoint additional level heating}}$
 $T_{\text{Night setpoint basic level heating}} \leq T_{\text{Night setpoint additional level heating}}$
 $T_{\text{Comfort setpoint cooling}} \leq T_{\text{Night setpoint cooling}}$

Setpoints for the "heating and cooling" operating mode

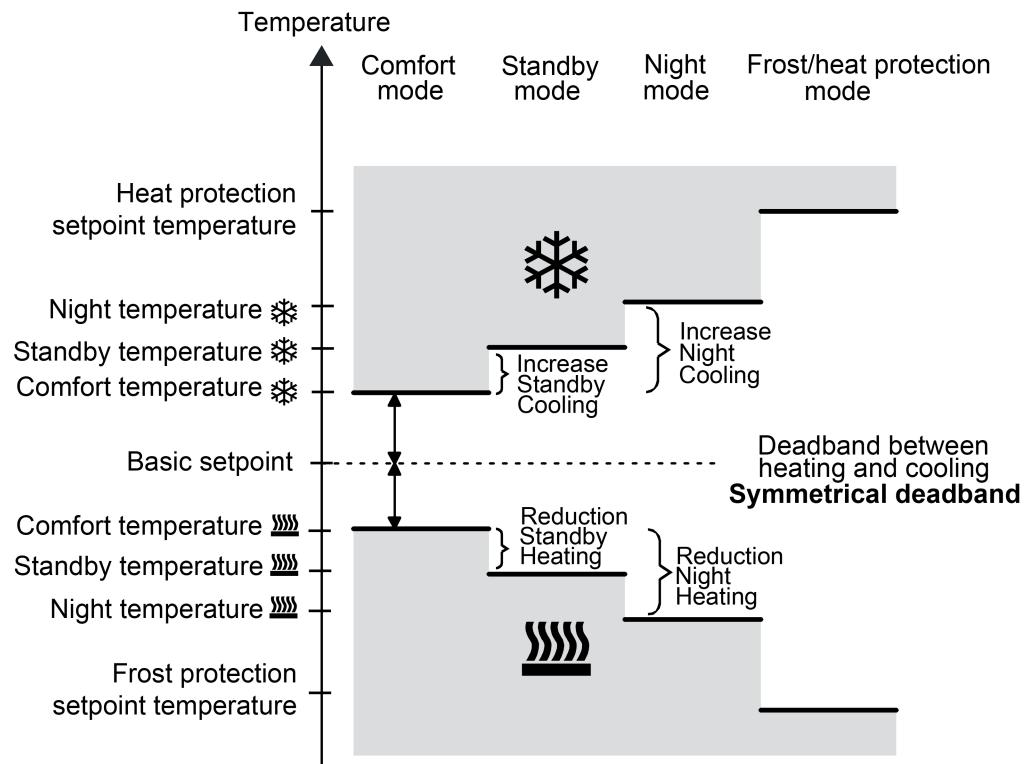

Figure 60: Setpoint temperatures in the operating mode "Heating and cooling" with symmetrical deadband

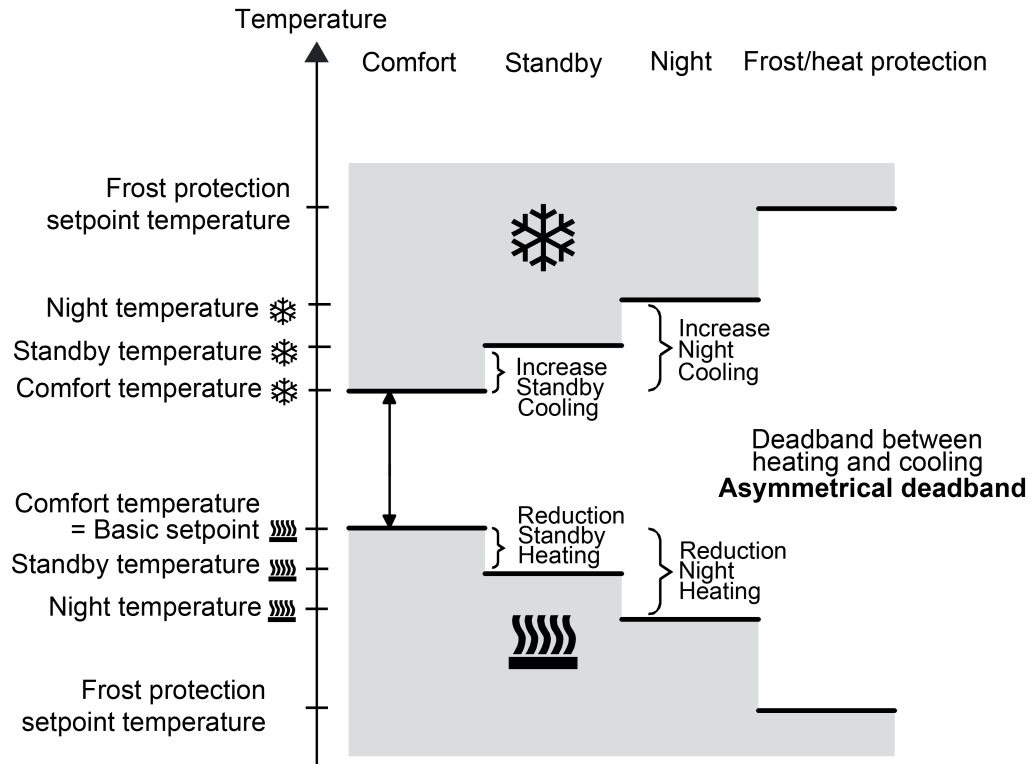

Figure 61: Setpoint temperatures in the operating mode "Heating and cooling" with asymmetrical deadband

For this heating/cooling operating mode, the setpoint temperatures of both heating/cooling modes exist for the Comfort, Standby and Night operating modes as well as the deadband. A distinction is made in the deadband position with combined heating and cooling. A symmetrical (figure 60) or an asymmetrical (figure 61) dead zone position can be configured. In addition, the frost protection and the heat protection temperatures can be preset. The following applies...

$$T_{\text{Standby setpoint heating}} \leq T_{\text{Comfort setpoint heating}} \leq T_{\text{Comfort setpoint cooling}} \leq T_{\text{Standby setpoint cooling}}$$

or

$$T_{\text{Night setpoint heating}} \leq T_{\text{Comfort setpoint heating}} \leq T_{\text{Comfort setpoint cooling}} \leq T_{\text{Night setpoint cooling}}$$

The set-temperatures for "Standby" and "Night" are derived from the comfort setpoint temperatures for heating or cooling. The temperature increase (for cooling) and the temperature decrease (for heating) of both operating modes can be preset in ETS. The comfort temperatures itself are derived from the deadband and the basic setpoint.

The frost protection is supposed to prevent the heating system from freezing. For this reason the frost protection temperature (default: +7 °C) should be set to a smaller value than the night temperature for heating. In principle, however, it is possible to select frost protection temperature values between +7.0 °C and +40.0 °C. The heat protection is supposed to ensure that the temperature does not exceed the maximum permissible room temperature in order to protect system components. For this reason the heat protection temperature (default: +35 °C) should be set to a larger value than the night temperature for cooling. In principle, however, it is possible to select heat protection temperature values between +7.0 °C and +45.0 °C. The possible range of values for a setpoint temperature ("heating and cooling") lies between +7.0 °C and +45.0 °C and is bounded by the frost protection temperature in the lower range and by the heat protection temperature in the upper range.

The level offset configured in ETS will be additionally considered in a two-level heating or

cooling mode.

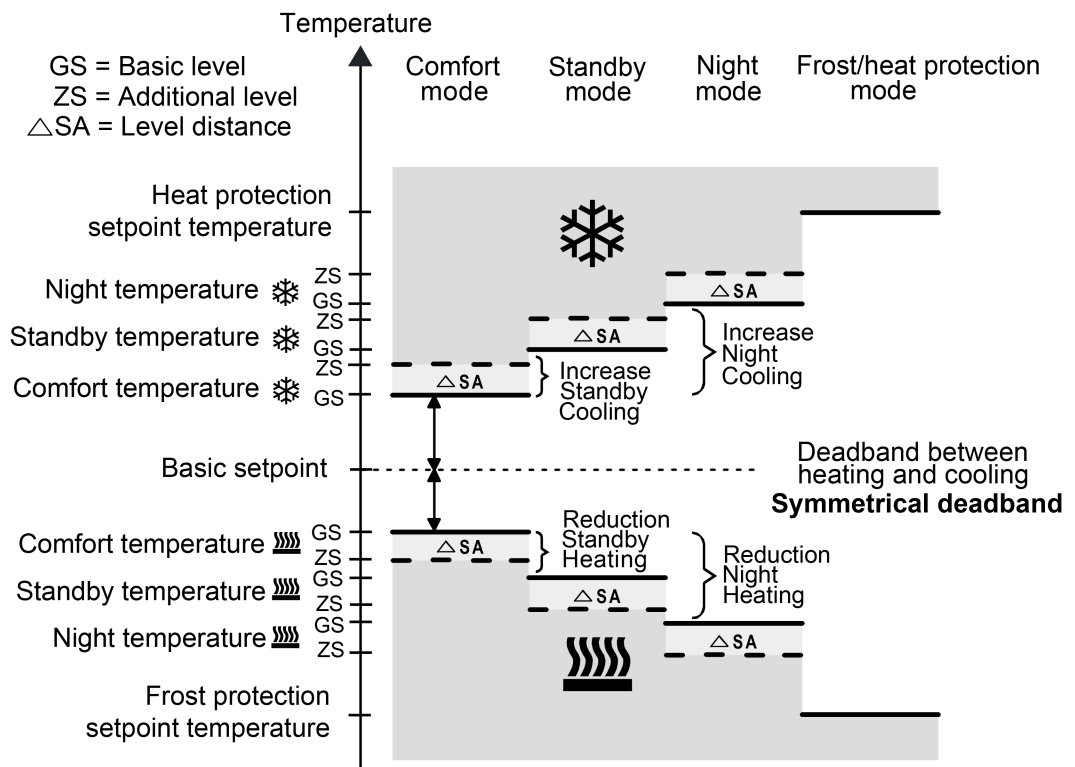

Figure 62: Setpoint temperatures in the operating mode "Basic and additional heating and cooling" with symmetrical deadband

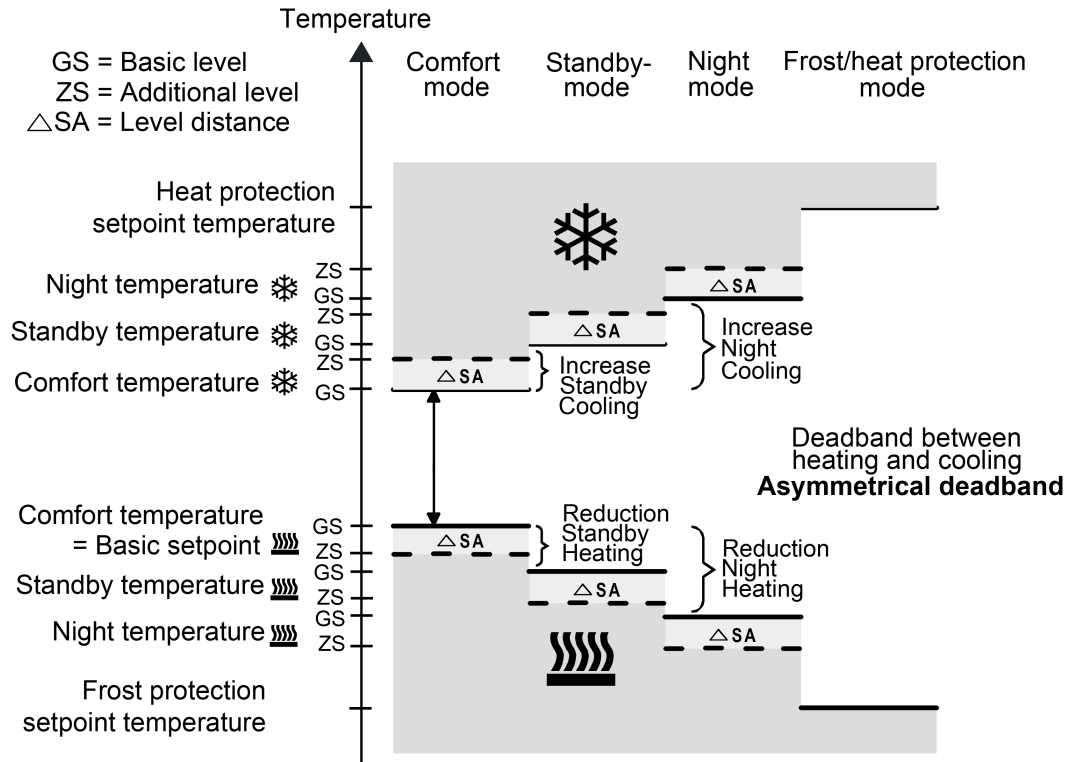

Figure 63: Setpoint temperatures in the operating mode "Basic and additional heating and cooling" with asymmetrical deadband

$$T_{\text{Comfort setpoint add. level Heating}} \leq T_{\text{Comfort setpoint basic level Heating}} \leq T_{\text{Comfort setpoint basic level Cooling}} \leq T_{\text{Comfort setpoint add. level Cooling}}$$

$$T_{\text{Standby setpoint add. level Heating}} \leq T_{\text{Standby setpoint basic level Heating}} \leq T_{\text{Standby setpoint basic level Cooling}} \leq T_{\text{Standby setpoint add. level Cooling}}$$

$$T_{\text{Standby setpoint heating}} \leq T_{\text{Comfort setpoint heating}} \leq T_{\text{Comfort setpoint cooling}} \leq T_{\text{Standby setpoint cooling}}$$

or

$$T_{\text{Comfort setpoint add. level Heating}} \leq T_{\text{Comfort setpoint basic level Heating}} \leq T_{\text{Comfort setpoint basic level Cooling}} \leq T_{\text{Comfort setpoint add. level Cooling}}$$

$$T_{\text{Night setpoint add. level Heating}} \leq T_{\text{Night setpoint basic level Heating}} \leq T_{\text{Night setpoint basic level Cooling}} \leq T_{\text{Night setpoint add. level Cooling}}$$

$$T_{\text{Night setpoint heating}} \leq T_{\text{Comfort setpoint heating}} \leq T_{\text{Comfort setpoint cooling}} \leq T_{\text{Night setpoint cooling}}$$

deadband and deadband positions in the combined heating and cooling operating mode

With relative setpoint presetting, the comfort setpoint temperatures for heating and cooling are derived from the basic setpoint in consideration of the adjusted Dead band. The deadband (temperature zone for which there is neither heating nor cooling) is the difference between the comfort setpoint temperatures. This deadband does not exist for absolute setpoint presetting.

The "deadband between heating and cooling", "deadband position" parameters as well as the "Basic temperature after reset" parameter are preset in the ETS configuration. One distinguishes between the following settings...

- deadband = "symmetrical"
The deadband preset in the ETS is divided into two parts at the basic setpoint. The comfort setpoint temperatures are derived directly from the basic setpoint resulting from the half deadband.
The following applies...
$$T_{\text{Basic setpoint}} - \frac{1}{2}T_{\text{deadband}} = T_{\text{Comfort heating setpoint}}$$

and
$$T_{\text{Basic setpoint}} + \frac{1}{2}T_{\text{deadband}} = T_{\text{Comfort setpoint cooling}}$$

-> $T_{\text{Comfort cooling setpoint}} - T_{\text{Comfort heating setpoint}} = T_{\text{deadband}}$
-> $T_{\text{Comfort cooling setpoint}} \geq T_{\text{Comfort heating setpoint}}$
- deadband position = "Asymmetrical"
With this setting the comfort setpoint temperature for heating equals the basic setpoint. The deadband preset in the ETS is effective only from the basic setpoint in the direction of comfort temperature for cooling. Thus the comfort set-temperature for cooling is derived directly from the comfort setpoint for heating.
The following applies...
$$T_{\text{Basic setpoint}} = T_{\text{Comfort heating setpoint}}$$

-> $T_{\text{Basic setpoint}} + T_{\text{deadband}} = T_{\text{Comfort cooling setpoint}}$
-> $T_{\text{Comfort cooling setpoint}} - T_{\text{Comfort heating setpoint}} = T_{\text{deadband}}$
-> $T_{\text{Comfort cooling setpoint}} \geq T_{\text{Comfort heating setpoint}}$

Accept setpoints permanently

If the basic setpoint has been modified by the communication objects "Basic setpoint" or "Setpoint of active operating mode", two possible cases can be distinguished, which are set by the parameter "Apply change of the setpoint of the basic temperature" (with relative setpoint presetting) or "Apply change of the setpoint permanently" (with absolute setpoint presetting)...

- Case 1: The setpoint adjustment is permanently accepted ("Yes" setting):
If, with this setting, the temperature setpoint is adjusted, the controller saves the value permanently to the EEPROM (permanent storage). The newly adjusted value will overwrite the initial value, i.e. the basic temperature originally configured via the ETS after a reset or the absolute setpoint temperature loaded using the ETS. The changed values are also retained after a device reset, after a switch-over of the operating mode or after a switch-over of the heating/cooling mode (with absolute setpoint presetting individually for each operating mode for heating and cooling).
With this setting, it should be noted that frequent changing of the basic temperature (e.g. several times a day because of cyclical telegrams) can affect the product life of the device as the non-volatile storage is designed for less frequent write access.
The "Basic setpoint" object (relative setpoint presetting) is not bidirectional, meaning that a shifted basic setpoint is not signalled back to the KNX. The object "Setpoint active operating mode" (absolute setpoint presetting) can be bidirectional if necessary (set "Transmit" flag!). This makes it possible to use this object to feedback to the bus the setpoint temperature resulting from a setpoint shift.

 - Case 2: The basic setpoint adjustment is only temporarily accepted ("No" setting):
The setpoints received via the objects remain active only temporarily. In case of a bus voltage failure or following a switch-over to another operating mode (e.g. Comfort followed by Standby, or also Comfort followed by Comfort), or after a switch-over of the heating/cooling mode (e.g. heating after cooling), the last setpoint changed will be discarded and replaced by the initial value.
-
- i** If the setpoint is accepted on a non-temporary basis ("Yes" setting), the setpoints restored after a device reset are not effected immediately in the communication objects. Only after the telegrams have been received from the bus via the objects and the room temperature controller accepts the newly received setpoint can the objects be read out, for example for visualisation purposes (Set "Read" flag!).
 - i** With relative setpoint presetting: Independent of the "accept modification of the basic temperature setpoint value permanently" parameter, the temperature setpoints for the standby or night mode or "cooling" comfort mode (deadband) will always be stored in the non-volatile EEPROM memory.
With absolute setpoint presetting: As described, dependent on the "accept modification of the setpoint value permanently" parameter, the temperature setpoints for the standby or night mode for heating or cooling will always be stored in the volatile or non-volatile memory.

Basic setpoint shift for relative setpoint presetting

In addition to presetting individual temperature setpoints by the ETS or basic setpoint object, the user, when presetting relative setpoints, can shift the basic setpoint in predefined limits within a specific range. When doing so, the basic setpoint is adjusted up or down in levels. The value of a level is 0.5 K.

- i** No basic setpoint shift can be performed if the controller is configured for absolute setpoint presetting.

- i** It has to be considered that a shift of the displayed setpoint temperature (temperature offset of the basic temperature) will directly affect the basic setpoint and as a result shift all other temperature setpoints.
A positive shift is possible up to the configured heat protection temperature. A negative shift is possible up to the set frost protection temperature.
- i** The "Basic setpoint" object is not bidirectional, meaning that a shifted basic setpoint is not signalled back to the KNX.

Whether a basic setpoint shifting only affects the currently active operating mode or whether it influences all other set-temperatures of the remaining operating modes is determined by the "Accept modification of shift of basic setpoint value permanently" parameter in the "Room temperature control -> Controller general -> Setpoints" parameter page...

- "No" setting:
The basic setpoint shifting carried out is in effect for only as long as the operating mode or heating/cooling mode has not changed or the basic setpoint is maintained. Otherwise the setpoint shift will be reset to "0".
- Setting "yes":
In general, the shifting of the basic setpoint carried out affects all operating modes. The shifting is maintained even after switching-over the operating mode or the heating/cooling mode or readjusting the basic setpoint.
- i** Since the value for the basic setpoint shift is stored exclusively in volatile memory (RAM), the shift will get lost in case of a reset (e.g. bus voltage failure).
- i** A setpoint shift does not affect the temperature setpoints for frost or heat protection!

Communication objects for the basic setpoint shift:

The setpoint shift of the controller can be adjusted externally by the communication object "Setpoint shift specification" with a 1-byte counter value (in compliance with KNX DPT 6.010 – Depiction of positive and negative values in a double complement. By connecting to the "Setpoint shift specification" object the controller extensions are able to directly adjust the current setpoint shift of the controller. As soon as the controller receives a value, it will adjust the setpoint shift correspondingly. Values that lie within the possible value range of the basic setpoint shift can be directly jumped to.

The controller monitors the received value independently. As soon as the external preset value exceeds the limits of the adjustment options for the setpoint shift in positive or negative direction, the controller will correct the received value and adjust the setpoint shift to maximum. Depending on the direction of the shift, the value feedback is set to the maximum value via the communication object "Current setpoint shift".

The current setpoint shift is tracked by the controller in the communication object "Current setpoint shift". This object has the same data point type and value range as the object "Setpoint shift specification" (see above). By connecting to this object the controller extensions are also able to display the current setpoint shift. As soon as there is an adjustment by one temperature increment in positive direction, the controller counts up the value. The counter value will be counted down if there is a negative adjustment of the temperature. A value of "0" means that no setpoint shifting has been adjusted.

Example:

Starting situation: current setpoint temperature = 21.0°C / Counter value in "Current setpoint shift" = "0" (no active setpoint shift)

After the setpoint shifting:

- > A setpoint shift by one temperature increment in the positive direction will count up the value in the "Current setpoint shift" object by one = "1".
- > Current setpoint temperature = 21.5°C
- > An additional setpoint shift by one temperature increment in the positive direction will again count up the value in the "Current setpoint shift" object by one = "2".
- > Current setpoint temperature = 22.0°C
- > A setpoint shift by one temperature increment in the negative direction will count down the value in the "Current setpoint shift" object by one = "1".
- > Current setpoint temperature = 21.5°C
- > An additional setpoint shift by one temperature increment in the negative direction will again count down the value in the "Current setpoint shift" object by one = "0".
- > Current setpoint temperature = 21.0°C
- > An additional setpoint shift by one temperature increment in the negative direction will again count down the value in the "Current setpoint shift" object by one = "-1".
- > Current setpoint temperature = 20.5°C, etc. ...

- i** To ensure that controller extensions indicate the correct shifts and also control the functions of the controller (as main unit) correctly, it is necessary for the controller extensions to be set to the same shift limits of the setpoint shift as the main unit. Controller extensions must work with the same step width for the setpoint shift as the controller itself (0.5 K).

Display function for the basic setpoint shift for relative setpoint presetting:

Optionally the setpoint of the respective current operating mode can be shown automatically in the display if a setpoint shift is performed using the buttons of the device ("Setpoint shift" button function). The setpoint temperature is then displayed temporarily for 5 s in °C or °F, and overwrites the normal display (actual temperature, etc.).

The setpoint display in the case of a setpoint shift can be activated by setting the "Show temporary setpoint controller n on setpoint shift?" parameter to "Yes". With the setting "No" the temporary display is inactive, meaning that in case of a setpoint shift only the line graphic "- - - - 0 - - - -" is activated, but the temperature value is not also displayed automatically.

Depending on the configuration in the ETS, the normal depiction of the display can show various display information with cyclical change or by button control, including the setpoint temperature. Therefore for a setpoint shift a distinction is made among the following cases...

- The temporary setpoint display for setpoint shift is **active**. At the time the button is pressed for a setpoint shift the setpoint temperature is **not** visible in the display via the cyclical change of the display information or via a previous "change in the display reading" button call-up.
In this case the first button-press of the setpoint shift causes the setpoint temperature of the active operating mode to be displayed. Only another button-press will shift the temperature by one level. The setpoint remains visible in the display for 5 s. After that the display switches back to the normal display, if the button for the setpoint shift is not pressed another time. Additional button actuations shift the setpoint temperature value again and cause it to be visible in the display for another 5 seconds.

- The temporary setpoint display for setpoint shift is **active**. At the time the button is pressed for a setpoint shift the setpoint temperature is visible in the display via the cyclical change of the display information or via a previous "change in the display reading" button call-up. In this case the setpoint is shifted by one level immediately by the first button-press of the setpoint shift. The display of the setpoint is updated in the display and thus shows the shifted setpoint temperature. However, the setpoint only remains visible in the display for the configured time of the cyclical change. After that the display switches over to the next piece of display information, if the button for the setpoint shift is not pressed another time. Additional button actuations activate the temporary setpoint display and cause the setpoint temperature value to be visible in the display for at least another 5 seconds.
 - The temporary setpoint display for setpoint shift is **inactive**. At the time the button is pressed for a setpoint shift the setpoint temperature is visible in the display via the cyclical change of the display information or via a previous "change in the display reading" button call-up. In this case the setpoint is shifted by one level immediately by the first button-press of the setpoint shift. The display of the setpoint is updated in the display and thus shows the shifted setpoint temperature. However, the setpoint only remains visible in the display for the configured time of the cyclical change. After that the display switches over to the next piece of display information. The setpoint shift is then only shown via the line graphic, and no longer as a temperature value, even in case of further button-presses.
- i** No temporary setpoint display takes place if a setpoint shift is performed in the menu level of the device or via the communication objects (e.g. via controller extensions).

Setpoint shift with absolute setpoint presetting

In addition to the setting of individual temperature setpoints via the ETS or via the setpoint object, with absolute setpoint presetting the user is also able to shift the setpoint via the basic setpoint object with the "Controller operation-setpoint shift" button function, if this is configured to a function button of the device. Each time a button is pressed, the setpoint is shifted upwards or downwards (depending on the button operation and parameterisation) by one level (0.1 K or 0.5 K). The step value corresponds to the designed "Setpoint shift value". Hold the button down for continuous shifting.

With absolute setpoint presetting the setpoint shift directly affects the object "Setpoint active operating mode" and thus directly only the specified setpoint temperature of the specific active operating mode. The last setpoint temperature specified via the bus or by the ETS is first overwritten by a shift. If the "Accept modification of the setpoint value permanently" parameter is set to "Yes", the controller saves the shifted temperature value in non-volatile memory (EEPROM). Otherwise (setting "No") the shifted setpoint remains active only temporarily for the active operating mode. It sets itself back to the initial value if the operating mode or the heating/cooling mode is switched over or a device reset is performed.

The setpoint temperatures of other operating modes for heating or cooling are not affected by the shifting of the setpoint of a specific operating mode. If, for example, the setpoint temperature for the comfort mode for heating is shifted, the other setpoints for night or standby mode for heating and cooling remain unchanged. If a shift is desired here, too, then the temperature values must be shifted individually.

- i** In the case of relative setpoint presetting, shifting of the basic setpoint is possible (see page 131). If accepted on a non-temporary basis this has an effect on all operating modes of the controller, and thus differs from the setpoint shift for absolute setpoint presetting.
- i** The object "Setpoint active operating mode" can be bidirectional if necessary (set "Transmit" flag!). This makes it possible to use this object to feedback to the bus the setpoint temperature of an operating mode resulting from a setpoint shift.

i A setpoint shift does not affect the temperature setpoints for frost or heat protection!

In the case of absolute setpoint presetting, a setpoint shift can only be performed on main controllers. A "setpoint shift" is only available on a control extension if the main controller is working with relative setpoint presetting (basic setpoint). In the case of an absolute setpoint shift on the main controller, the setpoint shift on the controller extension has no effect. In this case controller extensions can forward setpoints to main controllers, for example by pressing a function button (Temperature value transmitter to the "Setpoint active operating mode" object).

Transmitting the setpoint temperature

The setpoint temperature, which is given by the active operating mode can be actively transmitted onto the bus via the 2-byte "Set temperature" object. The "Transmission at setpoint temperature modification by..." parameter in the "Room temperature control -> controller general -> setpoint values" parameter node determines the temperature value by which the setpoint has to change in order to have the setpoint temperature value transmitted automatically via the object. Possible temperature value changes lie within a range of 0.1 K and 25.5 K. The setting "0" at this point will deactivate the automatic transmission of the setpoint temperature.

In addition, the setpoint can be transmitted periodically. The "Cyclical transmission of setpoint temperature" parameter determines the cycle time (1 to 255 minutes). The value "0" will deactivate the periodical transmission of the setpoint temperature value. It has to be pointed out that with deactivated periodical transmission and deactivated automatic transmission, no setpoint temperature telegrams will be transmitted in case of a change.

Setting the "Read" flag on the "Setpoint temperature" object makes it possible to read out the current setpoint. Following the return of bus voltage or after re-programming via the ETS, the object value will be initialised according to the current setpoint temperature value and actively transmitted to the bus.

4.2.4.3.6 Command value and status output

Command value objects

The format of the command value objects are determined depending on the control algorithm selected for heating and / or cooling and, if applicable, also for the additional levels. 1 bit or 1 byte command value objects can be created in the ETS. The control algorithm calculates the command values in intervals of 30 seconds and outputs them via the objects. With the pulse width modulated PI control (PWM) the command value is updated, if required, solely at the end of a time cycle.

Possible object data formats for the command values separately for both heating/cooling operating modes, for the basic and the additional level or for both control circuits are...

- continuous PI control: 1 byte
- Switching PI control: 1 bit + additionally 1 byte (for example for the status indication with visualisations),
- switching 2-point feedback control: 1 bit.

Depending on the selected heating/cooling operating mode, the controller is able to address heating and / or cooling systems, to determine command values and to output them via separate objects. One distinguishes between two cases for the "Heating and cooling" mixed operating mode...

- Case 1: Heating and cooling system are two separate systems
In this case the "Transmit heating and cooling command value to one common object" parameter should be set to "No" in the "Room temperature control -> Controller functions" parameter node. Thus, there are separate objects available for each command value, which can be separately addressed via the individual systems.
This setting allows to define separate types of control for heating and cooling.
- Case 2: Heating and cooling system are a combined system
In this case the "Transmit heating and cooling command value to one common object" parameter may be set, if required, to "Yes". This will transmit the command values for heating and cooling to the same object. In case of a two-level feedback control, another shared object will be enabled for the additional levels for heating and cooling.
With this setting it is only possible to define the same type of feedback control for heating and for cooling as the feedback control and the data format must be identical. The ("Type of heating / cooling") control parameter for cooling and heating still has to be defined separately.
A combined command value object may be required, for example, if heating as well as cooling shall take place via a single-pipe system (combined heating and cooling system). For this, the temperature of the medium in the single-pipe system must be changed via the system control. Afterwards the heating/cooling operating mode is set via the object (often the single-pipe system uses cold water for cooling during the summer, hot water for heating during the winter).

If required, the command value can be inverted before the transmission to the KNX/EIB. With output via a combined object, the parameters "Output of heating command value", "Output of cooling command value" or "Output of command values..." output the command value in inverted fashion according to the object data format. The parameters for inverting the additional level(s) are additionally available in the two-level control.

The following applies...

For continuous command values:

-> not inverted: Command value 0 % ... 100 %, value 0 ... 255

-> inverted: Command value 0 % ... 100 %, value 255 ... 0

For switching command values:

-> not inverted: Command value off / on, value 0 / 1

-> inverted: Command value off / on, value 1 / 0

Automatic transmission

On automatic transmission, a distinction is made with regard to the type of control...

- Continuous PI control:
In case of a continuous PI control, the room temperature controller calculates a new command value periodically every 30 seconds and outputs it to the bus via a 1-byte value object. The change interval of the command value can be determined in percent according to which a new command value is to be output on the bus via the "Automatic transmission on change by..." parameter in the "Room temperature control -> Controller general -> Command values and status output" parameter node. The change interval can be configured to "0" so that a change in the command value will not result in an automatic transmission.
In addition to the command value output following a change, the current command value value may be periodically transmitted on the bus. In addition to the times when changes are to be expected, other command value telegrams will be output according to the active value after a configurable cycle time. This ensures that during a periodic access control of the command value in servo drive or in the addressed switching actuator, telegrams are received within the control interval. The time interval predetermined by the "Cycle time for automatic transmission..." parameter should correspond to the control interval in the actuator (cycle time in the controller is preferably to be configured smaller). The "0" setting will deactivate the periodic transmission of the command value.
With continuous PI control it must be noted that if the cyclical and the automatic transmission are both deactivated, no command value telegrams will be transmitted in case of a change!

- Switching PI control (PWM):
In case of a switching PI control (PWM), the room temperature controller calculates a new command value internally every 30 seconds. In this feedback control, however, the update of the command value takes place, if required, solely at the end of a PWM cycle. The parameters "automatic transmission on change by..." and "Cycle time for automatic transmission..." are not enabled with this control algorithm. The parameter "Cycle time of the switching command value..." defines the cycle time of the PWM command value signal.

- 2-point feedback control:
In case of a 2-point feedback control, the room temperature and thus the hysteresis values are evaluated periodically every 30 seconds, so that the command values, if required, will change solely during these times. The "Automatic transmission on change by..." parameter is not enabled as this control algorithm does not calculate continuous command values.
In addition to the command value output following a change, the current command value value may be periodically transmitted on the bus. In addition to the times when changes are to be expected, other command value telegrams will be output according to the active value after a configurable cycle time. This ensures that during a periodic access control of the command value in servo drive or in the addressed switching actuator, telegrams are received within the control interval. The time interval predetermined by the "Cycle time for automatic transmission..." parameter should correspond to the control interval in the actuator (cycle time in the controller is preferably to be configured smaller). The "0" setting will deactivate the periodic transmission of the command value.

Controller status

The room temperature controller can transmit its current status to the KNX/EIB. A choice of data formats is available for this. The "Controller status" parameter in the "Room temperature control -> Controller general -> Command value and status output" parameter branch will enable the status signal and set the status format...

- "KNX compliant"
The KNX-compliant controller status feedback is harmonised on a manufacturer-specific basis, and consists of 3 communication objects. The 2-byte object "KNX status" (DPT 22.101) indicates elementary functions of the controller (see Table 8). This object is supplemented by the two 1-byte objects "KNX status operating mode" and "KNX status forced operating mode" (DPT 20.102), which report back the operating mode actually set on the controller. The last two objects mentioned above are generally used to enable controller extensions to display the controller operating mode correctly in the KNX compliant status display. Therefore these objects should be connected with controller extensions if the KNX compliant status feedback is not configured.

Bit of the status telegram	Meaning
0	Controller error status ("0" = no error / "1" = error)
1	not used (permanent "0")
2	not used (permanent "0")
3	not used (permanent "0")
4	not used (permanent "0")
5	not used (permanent "0")
6	not used (permanent "0")
7	not used (permanent "0")
8	Operating mode ("0" = Cooling / "1" = Heating)
9	not used (permanent "0")
10	not used (permanent "0")
11	not used (permanent "0")
12	Controller disabled (dew point operation) ("0" = Controller enabled / "1" = Controller disabled)
13	Frost alarm ("0" = Frost protection temperature exceeded / "1" = frost protection temperature undershot)
14	Heat alarm ("0" = heat protection temperature exceeded / "1" = Heat protection temperature exceeded)
15	not used (permanent "0")

Table 8: Bit encoding of the 2 byte KNX compliant status telegram

- "Controller general":
The general controller status collects essential status information of the controller in two 1-byte communication objects. The "Controller status" object contains fundamental status information (see Table 9). The "Status signal addition" object collects in a bit-orientated manner further information that is not available via the "Controller status" object (see Table 10). For example, controller extensions can evaluate the additional status information, in order to be able to display all the necessary controller status information on the extension display.

Bit of the status telegram	Meaning
0	On "1": Comfort operation activated
1	On "1": Standby mode active
2	On "1": Night mode active
3	On "1": Frost/heat protection mode active
4	On "1": Controller disabled
5	On "1": Heating, on "0": Cooling
6	On "1": Controller inactive (deadband)
7	On "1": Frost alarm ($T_{\text{Room}} \leq +5 \text{ }^{\circ}\text{C}$)

Table 9: Bit encoding of the 1 byte status telegram

Bit of the status telegram	Meaning on "1"	Meaning on "0"
0	Normal operating mode	Forced operating mode
1	Comfort extension active	No comfort extension
2	Presence (Presence detector)	No presence (Presence detector)
3	Presence (Presence button)	No presence (Presence button)
4	Window opened	No window opened
5	Additional level active	Additional level inactive
6	Heat protection active	Heat protection inactive
7	Controller disabled (dew point operation)	Controller not disabled

Table 10: Bit encoding of the 1 byte additional status telegram

- "Transmit individual state"
The 1 bit status object "Controller status, ..." contains the status information selected by the "Single status" parameter. Meaning of the status signals:
 - "Comfort mode active" -> Active if operating mode "Comfort " or a comfort extension "" is activated.
 - "Standby mode active" -> active if the "standby " operating mode is activated.
 - "Night-mode active" -> active if the "night " operating mode is activated.
 - "Frost/heat protection active" -> active if the "frost/heat protection" operating mode is activated.
 - "Controller disabled" -> Active if controller disable is activated (dew point mode).
 - "Heating / cooling" -> Active if heating is activated and inactive if cooling is activated. Inactive if controller is disabled.
 - "Controller inactive" -> Is active in the following parameter settings: "Operating mode = Heating and cooling" and "Switchover between heating and cooling = Automatic" when the measured room temperature lies within the dead zone. This status information is always "0" for the individual "Heating" or "Cooling" operating modes. In the "Heating and cooling" operating mode, the status information is also "0", if the switchover between heating and cooling takes place using an object. Inactive if controller is disabled.
 - "Frost alarm" -> Is active if the detected room temperature reaches or falls below +5 °C. This status signal will have no special influence on the control behaviour.

i Upon a reset, the status objects will be updated after the initialisation phase. After this, updating is performed cyclically every 30 seconds in parallel with the command value calculation of the controller command values. Telegrams are only transmitted to the bus when the status changes.

Additional controller status

The additional controller status is a 1-byte object, in whose value various information is collected in orientated to bits. In this way, controller statuses, which are not available via the 'normal' 1-bit or 1-byte controller status, can be displayed on other KNX/EIB devices or processed further (see Table 11). For example, controller extensions can evaluate the additional status information, in order to be able to display all the necessary controller status information on the extension display. The 1-byte object "Status signal addition" is a pure visualisation object, which cannot be written.

i The object "Status signal addition" is only visible when the parameter "Status controller" is configured to "Controller general".

Bit of the status telegram	Meaning on "1"	Meaning on "0"
0	Normal operating mode	Forced operating mode
1	Comfort extension active	No comfort extension

2	Presence (Presence detector)	No presence (Presence detector)
3	Presence (Presence button)	No presence (Presence button)
4	Window opened	No window opened
5	Additional level active	Additional level inactive
6	Heat protection active	Heat protection inactive
7	Controller disabled (dew point operation)	Controller not disabled

Table 11: Bit encoding of the 1 byte additional status telegram

- i** Upon a reset, the additional status object will be updated after the initialisation phase. After this, the status will be updated cyclically every 30 seconds in parallel with the command value calculation of the controller command values.

Command value limit

Optionally a command value limit can be configured in the ETS. The command value limit allows the restriction of calculated command values to the range limits "minimum" and "maximum". The limits are permanently set in the ETS and, if command value limitation is active, can be neither undershot or exceeded during device operation. It is possible, if available, to specify various limiting values for the basic and additional stages and for heating and cooling.

- i** It should be noted that the command value limit has no effect with "2-point feedback control" and with "Transmitting of command values for heating and cooling via a common object"! In that case it is still possible to configure the command value limit in the ETS, but it will have no function.

The "Command value limit" parameter on the parameter page "Room temperature control -> Controller general -> Command values and status output" defines the mode of action of the limiting function. The command value limit can either be activated or deactivated using the 1-bit communication object "Command value limit", or be permanently active. When controlling via the object, it is possible to have the controller activate the command value limit automatically after bus voltage return or an ETS programming operation. Here the "Command value limit after reset" parameter defines the initialisation behaviour. In the "Deactivated" setting, the command value limit is not automatically activated after a device reset. A "1" telegram must first be received via the "Command value limit" object for the limit to be activated. In the "Activated" setting, the controller activates the command value limit automatically after a device reset. To deactivate the limit a "0" telegram must be received via the "Command value limit" object. The limit can be switched on or off at any time using the object.

With a permanently active command value limit, the initialisation behaviour cannot be configured separately after a device reset, as the limit is always active. In this case it is also not possible to configure any object.

As soon as the command value limit is active, calculated command values are limited according to the limiting values from the ETS. The behaviour with regard to the minimum or maximum command value is then as follows...

- **Minimum command value:**
The "Minimum command value" parameter specifies the lower command value limiting value. The setting can be made in 5 % increments in the range 5 % ... 50 %. With an active command value limit, the set minimum command value is not undershot by command values. If the controller calculates smaller command values, it sets the configured minimum command value. The controller transmits a 0% command value if no more heating or cooling energy has to be demanded.

- **Maximum command value:**
The "Maximum command value" parameter specifies the upper command value limiting value. The setting can be made in 5 % increments in the range 55 % ... 100 %. With an active command value limit, the set maximum command value is not exceeded. If the controller calculates larger command values, it sets the configured maximum command value.

If the limit is removed, the device automatically repositions the most recently calculated command value to the unlimited values when the next calculation interval for the command values (30 seconds) has elapsed.

- i** If the controller executes a valve protection function, the command value limit is temporarily deactivated in order to make use of the full motion range of the valve.
- i** An active command value limit has a negative effect on the control result when the command value range is very restricted. A control deviation must be expected.

Special case for command value 100% (Clipping mode)

If with a PI control the calculated command value of the controller exceeds the physical limits of the actuator, in other words if the calculated command value is greater than 100%, then the command value is set to the maximum value (100%) and thus limited. This special, necessary control behaviour is also called "clipping". With PI control the command value can reach the value "100%" if there is a large deviation of the room temperature from the setpoint temperature or the controller requires a long time to adjust to the setpoint with the heating or cooling energy that is being applied. The controller can evaluate this state in a particular manner and react to it in various ways.

The parameter "Behaviour with command value = 100% (clipping mode PI control)" on the parameter page "Room temperature control -> Controller general -> Command values and status output" defines the functions of the PI controller when the command value is 100%...

- "keep 100% until setpoint = actual, then 0%" setting:
The controller keeps the maximum command value until the room temperature (actual value) reaches the setpoint temperature. After that it reduces the command value down to 0% all at once (controller reset).
The advantage of this control behaviour is that in this way sustainable heating up of undercooled rooms or effective cooling of overheated rooms will be achieved by overshooting the setpoint. The disadvantage is that in some circumstances the overshooting of the room temperature may be found disturbing.
- Setting "keep 100% as required, then adjust downwards":
The controller maintains the maximum command value only as long as it is necessary. After that it adjusts the command value downwards according to the PI algorithm. The advantage of this control characteristic is the fact that the room temperature does not exceed the setpoint temperature at all, or only slightly. The disadvantage is that this control principle increases the tendency to oscillate about the setpoint.

Which of the methods of functioning described above is used often depends on what heating or cooling system is used (underfloor heating, radiators, fan coils, cooling ceilings, etc.), and how effective these systems are. We recommend selecting the setting "keep 100% until setpoint = actual, then 0%" (default setting). Only if this control behaviour has an adverse effect on the people's perception of the temperature in a room should the setting "keep 100% as required, then adjust downwards" be used.

- i** Clipping may also occur when a command value limit is active (maximum command value). In this case, if the internally calculated command value reaches 100%, then the controller only transmits to the bus the maximum command value according to the ETS configuration. The clipping (switching off when setpoint = actual or adjusting downwards) is performed, however.
- i** It should be noted that the clipping mode has no effect with "2-point feedback control"! In that case it is still possible to configure the parameter "Behaviour with command value = 100%" in the ETS, but it will have no function.

Rotation angle conversion

In the ETS, it is possible to optionally convert a command value output of the room temperature controller function of the device to a control parameter for a rotation angle of a rotary actuator.

To convert the command value, specific settings of the room temperature controller function are required:

Parameter description	required project design
Operating mode	Heating and cooling
Sending command value for heating and cooling to a shared object	Yes
Type of control	Continuous PI control
Output of the command value	Normal (under current, this means opened)

Rotation angle conversion: required settings of the controller parameters

The "heating" and "cooling" command values of the controller function are converted to a rotary angle for activating a rotary actuator. This in turn, for example, moves a control ball valve. From a technical point of view, the controller command value of the device is converted to a 1-byte control parameter (0...255) which corresponds to the rotary angle for a rotary actuator. This control parameter is transmitted to the KNX bus, for example, received from a gateway and converted. The rotary actuator adjusts the rotary angle transmitted to it. It is mechanically connected, for example, to a 6-way control ball valve.

The gateway has a 1-byte control input "setpoint" corresponding to the setpoint flap setting or setpoint volume flow. The angular opening of the ball valve for heating and cooling is to be taken from the valve curve.

If the rotation angle conversion is enabled, the room temperature controller function continues to work unchanged. Even the communication objects of the controller remain unchanged. Additionally, the conversion of the controller command value for heating and cooling is carried out in one rotary angle. This determined rotary angle receives its own object for activating a rotary actuator via the MP bus gateway.

The rotary angle is activated based on the controller command values heating and cooling. The cooling operating mode is in a rotary angle range from 0° to 30° by default. The rotary angle range for heating is normally between 60° and 90°. Between this at 45° is the deadband of the rotary angle. Here, 0° stands for cooling performance of 100%. The larger the rotary angle becomes, the smaller the cooling efficiency. From a rotary angle of 30° the cooling is at 100%. In this case, the cooling is not active. From a rotary angle of 60° the heating operating mode begins. The heating performance in percentage terms increases with the enlargement of the rotary angle up to 100% at 90°.

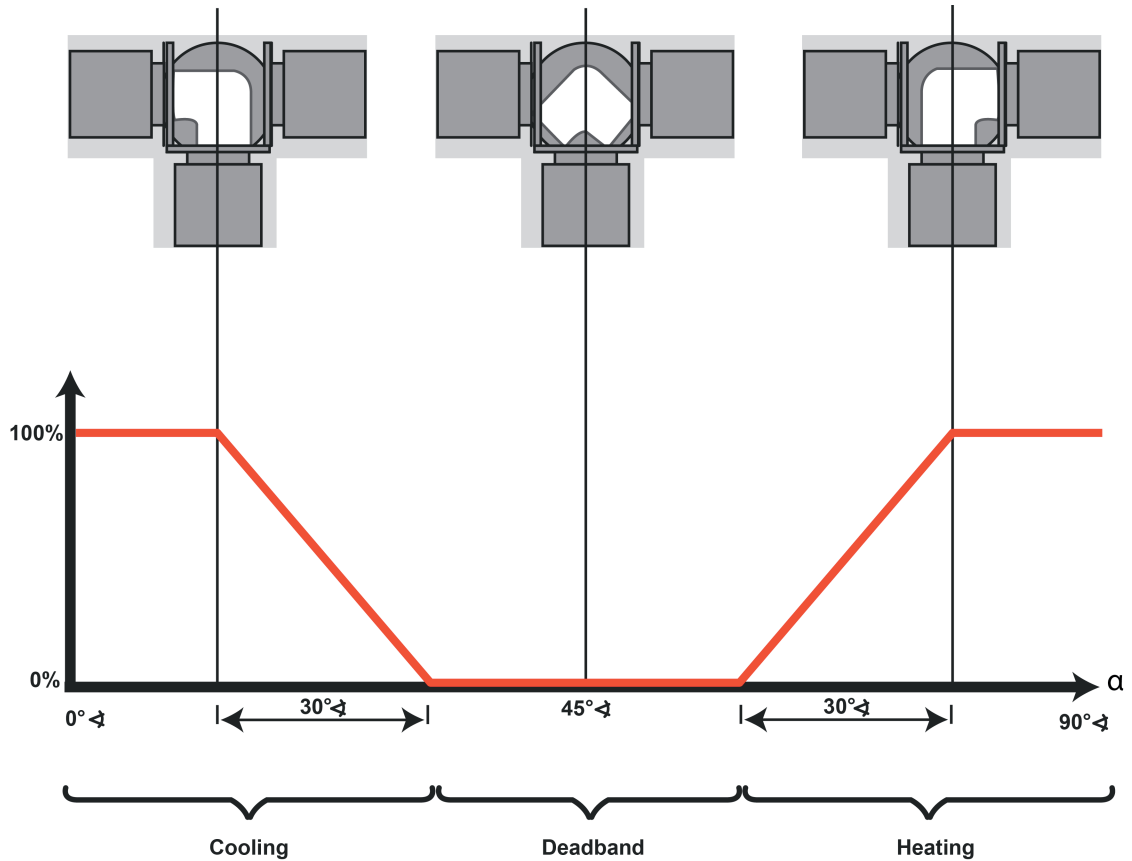

Figure 64: Control ball valve - valve curve

Immediately after processing the room temperature controller function, the conversion is carried out if the rotary angle output was enabled in the parameters of the database. The controller operating mode (heating and cooling) and the current command value as well as the configured rotary angles are included in the calculation of the rotary angle to be set. The determined rotary angle is scaled to the control parameter that is output as an object value of the "rotary angle" object. The transmission behaviour of the "rotary angle" object is identical to the transmission behaviour of the "command value heating/cooling" object.

As a result, the "Automatic transmission at modification by ..." and "Cycle time for automatic transmission ..." parameters determine the volume of telegrams transmitted to the KNX bus.

- i The larger the parameters values of the "Automatic transmission at modification by ..." and "Cycle time for automatic transmission ..." are set, the lower the bus load is.

4.2.4.3.7 Fan controller

Operating mode and fan levels

The room temperature control can be supplemented with a fan controller. This makes it possible to control the fan from heating and cooling systems operated by circulating air, such as fan coil units (FanCoil units), depending on the command value calculated in the controller or using manual operation. If necessary, the fan controller can be enabled separately by setting the "Fan controller available" parameter in the "Room temperature control -> Controller general" parameter node to "Yes". When the function is enabled additional parameters will appear in the ETS in the "Room temperature control -> Controller general -> Fan controller" as well as additional communication objects.

If the fan controller is enabled, the icon ✖ becomes visible in the display after the device is commissioned (ETS programming operation).

- i** The fan controller works only in conjunction with PI feedback controls with continuous or switching (PWM) command value output. In 2-point feedback control, the fan controller is inactive, even if the function is enabled in the ETS.

Depending on the operating mode of the room temperature control, as configured in the ETS (see chapter 4.2.4.3.1. Operating modes and operating mode change-over) various controller command values can be used as the basis for fan control. The "Fan operating mode" parameter specifies which command value of the controller controls the fan controller. With one-level room temperature control, it is possible to select whether the fan is activated during heating and/or during cooling. With two-level room temperature control, it is also possible for the fan controller to be set to the basic level or the additional level during heating and cooling. However, under no circumstances is it possible to use the basic and additional levels simultaneously for a fan controller within an operating mode.

Fan coil units are as a rule equipped with filters, and have multi-level blowers whose speed and thus ventilation output can be varied by means of fan level inputs. For this reason, the fan controller of the room temperature controller supports up to 8 fan level outputs, for which the actually used number of levels (1...8) is set using the "Number of fan levels" parameter. The controller controls the levels of a fan using bus telegrams. Usually, the fan level telegrams are received and evaluated by simple switching actuators. The electrical control of the fan level inputs of a fan coil unit takes place via these actuators. Depending on the data format of the objects of the controlled actuators, the change-over between the fan levels can either take place via up to 8 separate 1-bit objects or, alternatively, via one 1-byte object. The "Fan level change-over via" parameter defines the data format of the objects to output the fan level. With the 1-bit objects, each fan level discreetly receives its own object. With the 1-byte object, the active fan level is expressed by a value.



Fan level	Object value
Fan OFF	0
1	1
2	2
3	3
4	4
5	5
6	6
7	7
8	8

Table 11: Value meaning for 1 byte fan level object





Due to fan motors' inertia, as a rule there is a limit to how short the time intervals for switching the fan levels can be, i.e. there is a limit to how quickly the fan speed can be varied. Often the technical information for a fan coil unit specifies change-over times that the fan controller must maintain for each fan level change-over. The change-over direction, i.e. whether the level is being increased or decreased, does not play any role here.

With a change-over via the 1-bit objects, when the fan level is changed by the controller, the active fan level is first switched off before the new level is switched on. If the fan controller is working in automatic mode, the settable "Waiting time on level change-over" is maintained on change-over of the levels. For this short time, the fan level objects all receive the status "0 - Fan off". A new level is only then switched on when the waiting time has elapsed. Only one fan level output is ever switched on (changeover principle).

With change-over via the 1-byte object, on changing the fan level, the change-over takes place directly into the new level, without setting the "OFF" status. If the fan controller is working in automatic mode, the settable "Waiting time on level change-over" (dwell time) is always taken into account before change-over of the levels. With rapid level change-over, the change to the new level only takes place once the waiting time has elapsed.

-  The change from level 1 to OFF always takes place immediately, without a waiting time. An optionally-configured switch-on level is applied directly.
-  In manual mode, the "Waiting time on level change-over" is only significant for the switch-on level (Start-up via level). Here, the fan levels can be switched over without a delay through manual operation.
-  When changing from manual operation to automatic operation, the waiting time is taken into account in the case of a connected level change.

The fan level active in the current controller operating state is shown with using the fan icon in the display of the device. In both automatic and manual operation (for a function description, please see the section "Automatic operation / manual operation"), the display takes place via arc segments in the fan icon in the following manner:

-  Fan OFF
-  Fan level 1 active
-  Fan level 2 active
- ...
-  Fan level 8 active

With up to 8 fan levels each individual fan level is identified in the fan icon by an individual arc segment. The arc is closed when all 8 fan levels are switched on. If the number of fan levels is reduced in the ETS (e.g. "3"), adjacent arc segments are joined into groups, so that, when the largest fan level ("3" - ) is activated, all of the arc segments of the fan icon are illuminated. For smaller fan levels, fewer group segments are illuminated in like manner

Optionally, the active fan level can be indicated via all 8 status LEDs by means of the temporary fan level display. Temporary fan level display takes place in manual mode only.

- i** The fans of a fan coil unit are - as described above - controlled by the fan level objects of the controller. The electromechanical valves for heating and/or cooling, integrated into the blower devices, can be activated via suitable switching actuators using the objects "Heating message" or (see page 100)"Cooling message".
- i** The 1-byte object "Ventilation visualisation" can, if necessary, also be evaluated by other bus devices (e.g. visualisation - panel / PC software). It always transmit the current fan level as a 1-byte value, either automatically on a change or passively on reading out (value explanation according to Table 11).
- i** The objects of the fan levels are only updated by the controller. These objects may not be written to by other bus subscribers. Reading out is possible.
- i** After a device reset, the fan level objects and the visualisation object are updated and the status transmitted to the bus.

Automatic operation / manual operation

The fan control distinguishes between automatic and manual operation. The change-over between the two operating modes takes place using the 1-bit object "Ventilation, auto/manual", through the operation of a button on the device configured for "Fan control", or in the menu level locally on the device.

The parameter "Interpretation object fan control automatic/manual" in the fan control parameter group defines with which switching value the automatic or manual operation is set via the communication object. Automatic mode is always active after a device reset.

- i** The "Ventilation, auto/manual" object transmits actively ("Transmit" flag set). When the operating mode is changed over using local control, the valid status is transmitted to the bus.
- i** Updates to the object value "Automatic mode active" -> "Automatic mode active" or "Manual mode active" -> "Manual mode active" do not produce any reaction.

Automatic mode:

The command value of the controller is used internally in the device for automatic control of the fan levels. As a transition between the levels, there are threshold values, defined according to the command value of the controller, which can be set using parameters in the ETS. If the command value exceeds the threshold value of a level, the appropriate level is activated. If the command value sinks below a threshold value, minus the configured hysteresis, then the change-over takes place into the next lowest fan level. The hysteresis value applies to all the threshold values.

The threshold values for the individual fan levels can be configured freely in the range from 1 ... 99 %. The threshold values are not checked for plausibility in the ETS, meaning that incorrect configuration is possible. For this reason, it must be ensured that the threshold values, compared to the level value, are configured in a rising direction (level 1 threshold value > level 2 threshold value > level 3 threshold value > etc.).

When the command value changes, and thus the fan level, it is only possible to switch directly into neighbouring levels (exception: switch-on level). Thus, in Automatic operation, it is only possible, for example, to switch from level 2 down to level 1 or up to level 3. If the command value change exceeds or undershoots the threshold values of multiple fan levels, then, starting with the current fan level, all the fan levels are activated in succession until the fan level specified by the command value is reached.

If the fan is switched off by the automatic system, then it runs on for the time configured as "Fan run-on time, heating" or "Fan run-on time, cooling", providing that these run-on times are configured in the ETS.

- i** In automatic mode, the fan level objects are updated according to the internal command value calculation (cyclically every 30 seconds) plus the waiting time configured for level change-over. Telegram transmission only takes place when the object values of the fan levels are changed. After a device reset, the fan level objects are updated and the status transmitted to the bus.
- i** If a switch-on level is configured in the ETS ("Start-up via level" parameter), then, before the automatic activation of a fan level, it is possible to switch to a level, specified in the ETS and usually higher, for a brief time according to the command value (see section "Switch-on level").
- i** The command value evaluated by the fan controller in Automatic mode can be optionally limited by in the top and bottom command value ranges by the parameters "Command value is 0% until internal command value is greater than" and "Command value is 100% as soon as internal command value is greater than". In addition, the command value can also be raised by a constant value by the "Command value offset" parameter (see page 152).

Manual operation:

With the local control of a button configured to "Function = Fan control" and "Button function = Manual control" on the device, the controller makes a distinction as to whether it was in automatic or manual mode at the time the button was pressed.

If the controller is in automatic mode, then pressing a button switches to manual mode. The parameter "Fan level on change-over to manual" then decides whether the fan level most recently set in automatic mode is maintained, the fan is switched off or a defined fan level is set (see also next section "Switch-on level").

If, at the time the button is pressed, the manual controller is already active, then the controller switches to the next highest fan level without a delay. If the fan is in the highest level, then pressing a button switches it back to the OFF level. From there, every additional press causes the fan level to be raised. The switch-on level is ignored.

If the fan is switched off manually from the highest level, then it runs on for the time configured as "Fan run-on time, heating" or "Fan run-on time, cooling", providing that these run-on times are configured in the ETS. If, during the run-on time, the manual control button is pressed again, the controller will terminate the run-on time. The fan switches off briefly and then switches immediately to level 1.

In fan control in the menu level, the fan level and automatic mode can be set directly without taking into account the parameter "Fan level on change-over to manual", the switch-on level or fan run-on times (see chapter 2.5.2. Menu level).

- i** The 1-bit object "Ventilation, auto/manual" only allows change-over between automatic and manual operation. It is not possible to switch the fan levels on using the object. This function is reserved solely for local control.
- i** Local actuation of a button configured to "Function = Fan control" and "Button function = Automatic" on the device deactivates manual operation and causes the controller to change over to automatic operation.
- i** When changing from manual operation to automatic operation, the waiting time configured in the ETS is taken into account in the case of a connected level change.
- i** The parameter "Fan level on change-over to manual" is not checked for plausibility in the ETS, meaning that an incorrect configuration is possible. For this reason, care should be taken to ensure that there is no level in the configuration which is higher than the actual fan levels. If a level which does not exist is to be configured for the change-over to manual control, then the fan controller changes over to the maximum possible level when changing over to manual operation.
- i** In manual operation, the switch-on level only functions in certain situations (see next section "Switch-on level").

Switch-on level

The fan can, if it was switched off before and should now start up, be switched on at a defined switch-on level. This switch-on level can be any of the available fan levels, and is set in the ETS using the "Start-up via level" parameter. The switch-on level is generally one of the higher fan levels of a fan coil unit, so that at the beginning of a heating or cooling process the fan can start up correctly (reliable start-up of the fan motor through transfer of a higher torque, and thus a higher fan speed).

The switch-on level remains active for the "Waiting time on level change-over" configured in the ETS. In automatic operation, the controller only switches to the fan level specified by the command value, when the waiting time has elapsed. There is no change-over if, after the waiting time has elapsed, the fan level specified by the command value equals the switch-on level.

- i** If the controlled fan requires a longer period of time for the start-up, then the waiting time in the ETS should be configured to higher values (possible time range 100 ms ... 25.5 s). It should be noted that the waiting time is also taken into account on each level change-over in automatic operation!

The switch-on level is always taken into account by the fan controller in automatic mode on switching the fan on (if it was previously switched off by the command value evaluation) and, in certain situations, after activation of manual operation. On changing over to manual operation, the behaviour of the fan depends on the settings of the parameter "Fan level on changing over to manual" and "Start-up via level" and the previous fan level in automatic operation as follows...

- If, due to the "Fan level on change-over to manual" parameter, a defined level from level 1 to level 8 is requested, the controller will set this level on activating manual operation. In this case, the parameter "Start-up via level" is not taken into account if the fan was most recently switched off in automatic operation.
- If, due to the "Fan level on change-over to manual" parameter, "Fan level OFF" is requested, the controller will switch the fan off during the change-over to manual operation. On subsequent pressing of the button for manual control, the "Start-up via level" parameter is taken into account and the switch-on level set. Then, the controller waits in this level until further manual operation.
- If, due to the "Fan level on change-over to manual" parameter, no defined level is requested ("No change" setting) and the fan was switched off during automatic operation, then it will remain switched off on changing over to manual operation. On subsequent pressing of the button for manual control, the fan is switched to the first level. The "Start-up via level" parameter is thus not taken into account.

- i** A configured switch-on level is applied directly without a waiting time.
- i** With a fan change-over via the 1-bit objects, when the fan level is changed by the controller, the active fan level is first switched off before the new level is switched on. In this case, the switch-off of a fan level and the subsequent changeover to a new fan level is not evaluated as a fan start-up, also meaning that the switch-on level is not set. In automatic operation, the switch-on level is only taken into account if the fan was switched off previously by the command value evaluation (command value < level 1 threshold value minus hysteresis) and then it is to start up using a new command value.
- i** The start-up via the switch-on level also takes place after a change-over from manual operation to automatic operation, providing that the fan was most recently switched off in manual operation and, in automatic operation, a new command value requires the fan to be switched on.

- i** The parameter "Start-up via level" is not checked for plausibility in the ETS, meaning that an incorrect configuration is possible. For this reason, care should be taken to ensure that there is no switch-on level in the configuration which is higher than the actual fan levels. The fan controller automatically corrects a faulty parameterisation by activating level 1 for the start-up, meaning that the fan starts up normally without a switch-on level.

Fan level limit

To reduce the fan noise of a fan coil, the fan level limit can be activated. The level limit reduces the sound emissions by limiting the maximum fan level to a fan level value specified in the ETS by the "Level limit" parameter (limit level). The limitation can be switched on and off via a 1-bit "Fan, level limit" object, and thus activated in accordance with requirements, for example via a timer during night-time hours in order to reduce noise in bedrooms, or via "manual" operation of a pushbutton when a "quiet room" is needed (auditorium or the like). The limitation of the fan level is activated by receipt of a "1" telegram via the object "Fan, level limitation". Deactivation is therefore achieved through the receipt of a "0" telegram.

While a limitation is active, the fan controller prevents the fan from being switched to a higher level than the limitation level. If, at the instant that the limit is activated, the fan is running at a level that is greater than the limit level, then the fan level is immediately reduced to the limitation value. In this case the switching sequence of the individual levels and the waiting time configured in the ETS are also taken into account in the level change-over.

The limitation level can be one of the available fan levels.

The level controller distinguishes between Automatic and Manual operation.

- i** The fan level limit overdrives the switch-on level. As a result, when the fan is switched on, if the limit is active, the level has an active limit and the switch-on limit is not started. In this case, the limit level is jumped to without waiting.
- i** The level limit has no effect with an activated fan forced position.
- i** The parameter "Level limit" is not checked for plausibility, meaning that an incorrect configuration is possible. For this reason, care should be taken to ensure that there is no limit level in the configuration which is higher than the actual fan levels. If a higher limit level is configured, then the limit has no effect.

Forced fan position

The controller provides the option of activating a forced fan position via the bus. With an active forced position, the fan levels can neither be controlled nor switched over in either automatic or manual mode. The fan remains in the forced state until the forced position is removed using the bus. In this manner, it is possible to switch the fan to a locked and controlled state, for example for servicing purposes.

As soon as a "1" telegram is received via the 1-bit object "Ventilation, forced position", the controller immediately sets the fan level configured in the ETS without delay. The fan can also be completely switched off. The only special feature when activating the forced position is the fact that the fan controller is in automatic operation and a waiting time elapses, due to a previous level change-over. In this case, the fan controller only switches to the forced position level without the waiting time elapsing.

The forced position is dominant. For this reason, it cannot be overdriven from automatic mode, manual mode, the level limit or fan protection. Only when the forced position is removed does the fan control begin to control the fan levels according to the active operating mode.

The removal takes place when a "0" telegram is received via the object "Ventilation, forced position". The fan always switches itself off first. In automatic operation, the controller then evaluates the active command value and, when the waiting time configured in the ETS has elapsed, switches to the required fan level, taking an optionally-configured switch-on level into account. In manual operation, the fan first remains switched off. The fan level is only raised when the manual control button is pressed again. If a switch-on level

is configured, the controller will, when a button is pressed, switch to the switch-on level and remain there until further operation occurs.

- i** The parameter "Behaviour in a forced position" is not checked for plausibility, meaning that an incorrect configuration is possible. For this reason, care should be taken to ensure that there is no fan level in the configuration which is higher than the actual fan levels. If a higher level is configured for behaviour in a forced position than the number of fan levels, then the fan controller will start up the maximum possible level when the forced position is activated.
- i** The forced fan position does not influence the control algorithm integrated in the controller. The command values of the PI feedback control continue to be transmitted to the bus, even with a forced fan.

Command value limiting values and command value offset

In automatic operation, the command value of the controller is used internally in the device to control the fan levels, according to the fan operating mode. As a transition between the levels, there are threshold values, defined according to the command value of the controller, which can be set using parameters in the ETS. The evaluation of the controller command values can be specially influenced for automatic fan control.

The command value to be evaluated for the fan controller can be influenced by the "Command value is 0% until internal command value is greater than" parameter in the lower command value range. The fan controller only evaluates the command value according to the configured threshold values when the internal command value of the controller exceeds the configured limiting value. With smaller command values, the fan remains at a standstill.

Similarly, the command value to be evaluated for the fan controller can be limited by the "Command value is 100% as soon as internal command value is greater than" parameter in the upper command value range. In this case, the controller evaluates command values which exceed the configured limiting value as 100%. This means that the fan works at full power even with command values not at the maximum.

The "Command value offset" parameter allows configuration of a constant command value offset for the fan. The fan controller always adds the configured offset to the command value to be evaluated. The effect of this is that the fan turns at greater power than required by the command value, according to the threshold values. The result of this is that, even if the command value is switched off, the fan will continue to work when the first command value threshold value is exceeded by the offset.

- i** A configured command value offset cannot not affect a command value of greater than 100%. The maximum command value of the fan controller is therefore defined as 100 %.

Fan protection

The fan protection function allows the fan of a fan coil unit, which has not been active for some time, to be temporarily switched to the maximum level. In this way, the controller fan motors can be protected against stiffness. In addition, the fan blades and the heat exchanger of the fan coil unit are protected against dust against dust.

If the fan protection is to be used, it must be enabled using the parameter of the same name in the ETS. Fan protection can then be activated or deactivated directly using the 1-bit communication object "Ventilation, fan protection", for example using a KNX/EIB time switch.

If the fan protection object has the switching value "1", then the fan protection function is active. The fan then works at the highest possible fan level and overdrives automatic and manual operation. Fan protection can then be switched off again using the "0" switching value in the

communication object.

The reaction of the fan to switching fan protection depends on the operating mode of the automatic fan system. In automatic operation, the fan switches back to the level determined by the command value of the room temperature control. In manual operation, the fan switches off and can then be switched on again by additional manual actuation. The "Start-up via level" parameter is taken into account here.

- i** Even if the fan controller is inactive due to the controller operating mode, it is possible to activate the fan using fan protection.
- i** With an active level limit, the maximum fan level of fan protection is specified by the limit level.
- i** For reasons of safety, fan protection is not carried out with an active forced position.
- i** If fan run-on times are configured in the ETS, then the fan is switched off after a delay when fan protection is deactivated.

4.2.4.3.8 Disable functions of the room temperature controller

Certain operation conditions may require the deactivation of the room temperature control. For example, the controller can be switched-off during the dew point mode of a cooling system or during maintenance work on the heating or cooling system. The "Via object" setting in the "Switch off controller (dew point operation)" parameter in the "Room temperature control -> Controller functionality" parameter node enables the 1-bit "Disable controller" object. In addition, the controller disable function can be switched off when set to "No".

In case a "1" telegram is received via the enabled disable object, the room temperature control will be completely deactivated. In this case, all command values are equal "0" (wait 30 s for update interval of the command values). The controller, however, can be operated in this case.

The additional stage can be separately disabled when in two-stage heating or cooling mode. When set to "Yes", the "Additional level disabling object" parameter in the "Room temperature control -> Controller general" parameter node will enable the 1 bit "Disable additional level" object. In addition, the disable function of the additional level can be switched off when set to "No". In case a "1" telegram is received via the enabled disable object, the room temperature control is completely deactivated by the additional level. The command value of the additional level is "0" while the basic level continues to operate.

- i The controller has no function in dew point operation. The building functions to be controlled are in a critical state, which must be monitored by the building system.
- i A disable is always deleted after a reset (return of bus voltage, ETS programming operation).

4.2.4.3.9 Valve protection

Valve protection may be carried out periodically in order to prevent the addressed control valves of the heater or cooling system from becoming calcified or stuck. When set to "Yes", the "Valve protection" parameter in the "Room temperature control -> Controller functionality" parameter node activates valve protection.

This type of protection is generally started not only for non-active command value outputs, i.e. for outputs which have not requested any heating or cooling energy over the past 24 hours. For these outputs, by taking into account the following parameterisation the controller will periodically set the command value to the maximum value once a day for a duration of approx. 5 minutes...

Command value output not inverted:

-> 1-bit command value: "1", 1-byte command value: "255"

Command value output inverted:

-> 1-bit command value: "0", 1-byte command value: "0"

Thus even long closed valves will be opened briefly on a regular basis.

- i** A controller disable has no influence on the valve protection. This means that valve protection is carried out, even when the controller is disabled.
- i** The controller checks the 24 hr time cycle for valve protection using its internal clock. With a time-synchronised clock, valve protection takes place each day at 8.00 in the morning. If the time signal has not been synchronised via the bus for a long time, then the time is hidden in the display. However, the clock continues to run internally with the deviation to be expected. This means that the valve protection time may shift continually with an unsynchronised clock.

4.2.4.3.10 Underfloor heating temperature limit

The temperature limit can be activated in the controller in order to protect an underfloor heating system. If the temperature limit is enabled in the ETS, the controller continuously monitors the floor temperature. Should the floor temperature exceed a specific limiting value on heating, the controller immediately switches the command value off, thus switching the heating off and cooling the system. Only when the temperature falls below the limiting value, minus a hysteresis of 1 K, will the controller add the most recently calculated command value.

In the ETS, the temperature limit can be activated by setting the "Underfloor heating temperature limit available" parameter in the "Room temperature control -> Controller functionality" parameter node to "Present".

- i** It should be noted that the temperature limit only affects command values for heating. Thus, the temperature limit requires the controller operating modes "Heating" or "Heating and cooling" (see chapter 4.2.4.3.1. Operating modes and operating mode change-over). The temperature limit cannot be configured in the operating mode "Cooling".

The temperature limit can also be used in a two-level feedback control with basic and additional levels. However, it must then be specified in the ETS to which level the limit shall apply. The limit can then either apply to the basic level or to the additional level for heating using the "Affects" parameter.

The underfloor heating temperature to be monitored can be fed into the controller via the KNX/EIB communication object "Floor temperature". As soon as the temperature limit is enabled in the ETS, the 2-byte object "Floor temperature" becomes visible. This object can be used to inform the controller of the current floor temperature using suitable temperature value telegrams from other bus devices (e.g. analogue input with temperature sensor, etc.).

The maximum limit temperature, which the underfloor heating system may reach, is specified in the ETS using the "Maximum underfloor heating system temperature" parameter. The temperature can be set to a value between 20 and 70 °C. If this temperature is exceeded, the controller switches the underfloor heating system off using the command value. As soon as the floor temperature has fallen 1 K under the limit temperature, the controller switches the command value on again, assuming that this is intended in the control algorithm. The 1 K hysteresis is fixed and cannot be changed.

- i** Depending on the configuration, the temperature may have a strong impact on the controller behaviour. Poor parameterisation of the limit temperature (limit temperature near to the room/setpoint temperature) means that it is possible that the specified setpoint temperature for the room can never be reached!

4.2.4.4 Controller extension

The device unites two independent room temperature controllers (Controller 1 and Controller 2). Each controller is an independent function section of the device and has its own parameter and object range in the ETS. Therefore, the room temperature controllers can be switched on or off, irrespective of the pushbutton sensor function, or configured as a controller extension.

A controller can be used for single-room temperature control. Depending on the operating mode, current temperature setpoint and room temperature, command values for heating or cooling control and fan controller can be sent to the KNX. These command values are usually then converted by a suitable KNX actuator, e.g. heating or switching actuators or directly by bus-compatible actuating drives, evaluated and converted to physical variables for air conditioning control.

The controllers of the device can either work as a main controller or as a controller extension. As the main controller, the room temperature controller function is fully switched on and the control algorithm activated. Only the main controller transmits control value telegrams. A controller extension itself is not involved in the temperature regulating process. With it, the user can operate the single-room controller, i.e. the main controller from different places in the room. In this way, any number of operating extensions can be set up.

In this chapter, the functions of the room temperature controller are described as an extension.

i The following chapters on room temperature control apply for both Controller 1 and Controller 2. The functions of both controllers are identical.

4.2.4.4.1 Connection to room temperature controller

Function

The controller extension can be activated to control a KNX room temperature controller. The controller extension function is enabled using the "Controller extension *n*" setting of the parameter "Controller *n*" in the "Room temperature control" parameter node.

The controller extension itself is not involved in the regulating process. With it, the user can operate the single-room regulation from different places in the room. It can also be used to adjust central heating control units which are located, for instance, in a distribution box.

Typical KNX room temperature controllers generally offer different ways of influencing or visualising the room temperature control...

- Switching over between different modes of operation (e.g. "Comfort", "Night" ...) with different setpoint temperatures assigned to each mode by the thermostat.
- Signalling the presence of a person in a room. The signalling may also be combined with a configured switchover in the mode of operation.
- Readjustment of the setpoint temperature in levels which are referred in each case to the configured setpoint temperature of the current operating mode (basic setpoint shift).

The room controller display compact module permits by means of its control buttons the complete control of an external room temperature controller by changing the operating mode, by predefining the presence situation or by readjusting the setpoint shift (cf. the following sub-chapters). For this purpose, the TSM buttons selected as extension operation buttons must be configured for the "Controller extension" function. (see chapter 4.2.4.6.7. Controller extension function). It should be noted that an extension operation is possible only with button

configuration of one control surface and if the controller extension function has been enabled on the "Room temperature control..." tab. In all other cases, controller extension operating does not function.

In addition, the TSM can – even independently of the controller extension function – indicate the state of one or more room temperature controllers with the status LED. This feature permits the indication of operating modes or the bit-oriented evaluation of different status objects of controllers (see chapter 4.2.4.7.1. Functions of the status LED). With the controller extension functions "Setpoint shift" or "Presence button", the status LEDs can also signal the state of the corresponding functions directly.

The controller extension can work properly only if all extension objects are linked with the corresponding objects of the room temperature controller (see chapter 4.2.4.7.1. Functions of the status LED). All button functions configured for the controller extension act on the objects belonging to the extension. Several controller extensions can also act on one main controller.

The communication objects "Operating mode selection", "Forced operating mode switchover", "Presence button", "Current setpoint shift" and "Controller status" of the controller extension update themselves automatically after a reset or after ETS programming, if the parameter "Value request from controller extension?" on parameter page "Configuration..." is set to "Yes". Updating is effected by means of a ValueRead telegram to the room temperature controller. This must answer the request with a ValueResponse telegram. If the device does not receive all or some of the answers, the affected objects are initialised with "0". In this case, the objects must first be actively rewritten by the bus after a reset. This is also the case, when the "Value request from controller extension?" is set to "No".

Besides the operating function, the controller extension also possesses a display function. As on the main controller, various items of status information of the temperature controller can be shown on the device display. As the displayed states and information and also some operating functions are strongly dependent on the parameterisation of the main controller, the controller extension must also be configured and thus match the functions of the main controller. These functions are matched by parameters in the parameter node "Room temperature control" (see chapter 4.2.4.4.3. Display functions).

In addition to the status indication on the device display, the device can indicate the state of one or more room temperature controllers with the status LEDs of the rockers or buttons. This feature permits the indication of operating modes or the bit-oriented evaluation of different status objects of controllers. In case of the controller extension functions "Setpoint shift" or "Presence function", the status LEDs can also signal the state of the corresponding functions directly (see chapter 4.2.4.7.1. Functions of the status LED).

Communication objects

The controller extension can work properly only if all extension objects are linked with the objects of the same function in the main controller. The controller extension with the objects exists only once in the device (indication in the object name "RNSTn."). All button functions configured for the controller extension act on the objects belonging to the extension. Objects with the same function can be linked together using identical group addresses, meaning that multiple controller extensions can affect one main controller.

- i The actual room temperature can be detected by the communication objects of the room temperature measurement system, which are also available in the controller extension, and then shown in the display.

4.2.4.4.2 Operating functions

Operating mode switchover

Change-over of the controller operating mode can be effected in accordance with the standard function block for room temperature controllers defined in the KNX handbook with two 1-byte communication objects. The operating mode can be switched over with the normal and with the forced objects. The "RNSTn.Buttonfct.Input/output operating mode switchover" object offers a selection between the following operating modes:

- Comfort mode
- Standby mode
- Night mode
- Frost/heat protection mode

The "RNSTn.Button fct.Input/output forced object operating mode" communication object has a higher priority. It permits forced switching between the following modes of operation:

- Auto (normal operating mode switchover)
- Comfort mode
- Standby mode
- Night mode
- Frost/heat protection mode

The operating mode transmitted to the bus on a button press of the controller extension is defined by the parameter "Operating mode on pressing the button". Depending on the configured functionality, it is possible that

- either one of the above-mentioned modes is activated (single selection) on pressing the button,
- or the device is switched over between two or three modes (multiple selection).

i Notes on multiple selection:

In order to ensure that a change-over from one operating mode to another works properly even from different locations, the operating mode objects of the controller and those of all controller extensions must be interlinked and have their "Write" flag set. In the objects concerned, this flag is set by default

By checking the linked operating mode switchover object, the controller extension knows which of the possible operating modes is active. Based on this information, the device changes over into the next operating mode in sequence when a button is pressed. In the event that none of the possible operating modes is active, the next operating mode in the sequence is set to "Comfort" mode (in case of "Standby ->Night" to "Standby" mode). As far as switching over between the forced operating modes and "Auto" is concerned, the device switches into the "Auto" operating mode when none of the configured operating modes is active.

i It is not possible to program a reaction on release of the button. A long button-press is evaluated in the same way as short one and switches into the corresponding operating mode insofar as this is acceptable for the controller.

i If a status LED is to indicate the current operating mode, the status LED function must be programmed for "Operating mode indication" and its status object be linked with the corresponding group address for operating mode change-over with normal or high priority.

Presence button

All buttons with their function set to "Presence button" are internally linked with the "RNSTn.Button fct.Input/output presence button" object. The parameter "Presence function on pressing the button" defines the object value transmitted to the bus on pressing a button. In order to ensure that the object value transmitted in the "Presence TOGGLE" setting is always the correct one, the presence object of the main controller and the "Presence button" objects of the controller extensions must be interlinked and have their "Write" flag set. In the extension objects concerned, this flag is set by default.

It is not possible to program a reaction on release of the button. A long button-press is evaluated in the same way as short one and switches into the corresponding presence mode insofar as this is acceptable for the controller.

The status LED of the presence button can indicate both the presence status (setting "Button function indication active / inactive") and also the actuation of the button. In addition, the usual setting possibilities of the status LED are configurable as well .

Setpoint shift

The setpoint shift is another available function of the controller extension. It makes use of two 1-byte communication objects with datapoint type 6.010 (integer with sign). This extension function allows shifting of the basic setpoint for the temperature on a room temperature controller by pressing a button. Operation of the extension is generally the same as the operation of the main controller.

A button configured as a setpoint shift button reduces or increases the setpoint shift value on each press by one step width as specified by the main controller. The direction of the value adjustment is defined by the parameter "Setpoint shift on pressing the button". Releasing the button and a long press have no other functions.

Communication with main controller:

In order to enable the controller extension to effect a setpoint shift in a room temperature controller, the controller must have input and output objects for setpoint shifts. In this case, the output object of the controller must be linked with the input object of the extension unit and the input object of the controller must be linked with the output object of the extension via an independent group address.

All objects are of the same data point type and have the same value range. A setpoint shift is interpreted by count values: a shift in positive direction is expressed by positive values whereas a shift in negative direction is represented by negative object values. An object value of "0" means that no setpoint shift has been activated.

Via the "RNSTn.Button fct.Input current setpoint shift", the extensions are enabled to determine the current setpoint shift position. Starting from the value of the communication object, each button-press on an extension will adjust the setpoint in the corresponding direction by one count value level. Each time the setpoint is adjusted, the new shift is transmitted to the room temperature controller via the "RNSTn.Button fct.Output setpoint value specification" object of the controller extension. The controller itself checks the received value for the minimum and maximum temperature limits (see controller documentation) and adjusts the new setpoint shift if the values are valid. When the new count value is accepted as valid, the controller transfers this value to its output object for setpoint shifting and retransmits the value to the extension as positive feedback.





Due to the standard data point type used as the output and input object of the controller extension and the weighting of the individual level by the controller itself, each extension unit is able to determine whether a shift took place, in which direction it took place and by how many levels the setpoint was shifted. This requires that the communication objects are connected on all controller extensions and the controller.





The information for the step value as feedback from the controller enables the extension to

continue the adjustment anytime at the right point. The extension units can likewise react to a reset of the setpoint shifting function by the controller.

4.2.4.4.3 Display functions

Indication of the controller operating mode

The controller extension can indicate the current operating mode of the controller in the display. Just like on the controller itself, the operating mode is indicated by the comfort , standby , night  and frost/heat protection  icons.

A comfort extension ,  / ,  can also be shown in the display. This display information is obtained from the communication objects "RNSTn.Display fct.Input controller status" and "RNSTn.Display fct.Input controller status addition". These objects should be connected to the main controller objects with the same function!

It is not possible to use the display information to distinguish whether the operating mode has been set via a forced object or via the 'normal' operating mode change-over in case of a KONNEX change-over. It is possible to change over the operating mode using the control function of the controller extension.

-  It is not possible to change over the controller operating mode in the menu level on a controller extension in local control.

Indication of a setpoint shift

The controller extension can indicate on the display in the form of a line graphic "- - - - ▾ - - - -" whether a basic setpoint shift has been adjusted on the controller. Furthermore, the display shows whether the shift is active in the positive " ▾ - - - -" or negative "- - - - ▾" direction. A bar corresponds to shifting by one level value. The value of a level can be parameterised in the ETS. If no shift is active, only "0" is displayed.

In order for the display of a basic setpoint shift to function correctly, the "B.Controller extension current setpoint shifting" communication object has to be connected to the object of the same function in the main controller. A basic setpoint shift can also be set using the operating function of the controller extension.



For the controller extension to be able to display the setpoint shift correctly, the extension must also be configured and matched to the functions of the main controller. These functions are matched by the "step width of the 4-level setpoint shift" parameter in the parameter node "Room temperature control". These parameters must agree with the settings of the parameters of the same name in the main controller.

-  It is not possible to perform a basic setpoint shift in the menu level on a controller extension in local control.

Indication of setpoint temperature

The controller extension can indicate the setpoint temperature of the room temperature controller in the display. If this display is desired, then the communication object "RNSTn.Display fct.Input setpoint temperature" must be linked to the functionally-identical object of the main controller. In addition, the display of the extension must be configured for the indication of the temperature setpoint. For this, display information in the "Display" parameter block must be configured to "Setpoint temperature".

Indication of the heating and cooling messages

The main controller can indicate on the display that heating and cooling energy is requested by the heating or cooling systems. This is indicated by the  icon for heating or by the  icon for





cooling.

For the display to function, the communication objects for the controller command values of heating mode and/or cooling mode of the extension and main controller must be connected.

The command value format are strongly dependent on the parameterisation of the main controller. For the controller extension to be able to evaluate the command value telegrams correctly, the extension must also be configured and thus matched to the functions of the main controller. These functions are matched by the following parameters in the parameter node "Room temperature control"...

"Controller operating mode", "Controller transmits heating and cooling command values to a shared object" (only on "Controller operating mode" = "Heating and cooling"), "Type of feedback control", "Controller outputs command value ... in inverted form".

Fan levels display

As on a main controller, a controller extension can also indicate the current fan level of a fan controller in the display. There is no difference in the control function of the fan symbol , , , ...,  compared with the main controller function.

For the fan level indication to function, the communication object "RNST n .Display fct.Input ventilation visualisation" must be connected to the object of the same function of the main controller.

The fan level display must be enabled separately on the controller extension using the "Controller fan control available" parameter. In addition, it is necessary to set with how many fan levels (1...8) the main controller works.

4.2.4.4.4 Behaviour after a device restart

The different indication and operating functions of the controller extension are controlled via different communication objects as described in the previous chapters. A main controller must transmit the current status to the extensions, i.e. updating the communication objects so that, after a programming operation or after the return of bus voltage, all the status information is available for the initialisation of the extension. This takes place automatically for some objects during the initialisation of the main controller.

To ensure that all the objects are initialised correctly, some communication objects of the controller extension can also initialise automatically after a device restart as an option. For this, the parameter "Value request from controller extension?" the parameter node "Room temperature control" can be set to "Yes". The update takes place after a reset by means of a ValueRead telegram to the room temperature controller. This must answer the request with a ValueResponse telegram. If the extension does not receive all or some of the answers, the affected objects are initialised with "0". In this case, after a reset the objects must first be actively rewritten by the bus by other bus subscribers, e.g. through automatic transmission by the main controller. This is also always the case when the parameter "Value request from controller extension?" is configured to "No".

The automatic update takes place for all the transmitting objects with the name "RNSTn.Button fct.Output" and additionally for the objects "RNSTn.Display fct.Input controller status addition" and "RNSTn.Display fct.Input visualisation ventilation".

- i The automatic update can take place with a delay after a device reset. If there are still other bus devices besides the room controller display compact module transmitting telegrams immediately after a reset, it may be useful to activate the transmit delay for in order to reduce the bus load (see chapter 4.2.4.1.3. Transmission delay).
- i During commissioning, all extensions should be put into operation first. Only then should the main controller be connected and programmed. For larger KNX/EIB installations where the extensions are sometimes distributed over several lines, the remaining lines should also be initialized after a reset of one line.

4.2.4.5 Room temperature measurement

Basic principles

The room temperature controller possesses an integrated temperature sensor, using which the room temperature can be detected. The TSEM offers a second option for room temperature measurement, as it also possesses an internal temperature sensor. Alternatively (e.g. if the room temperature controller has been installed in an unfavourable location or operates in difficult conditions, for example, in a moist atmosphere) or in addition (e.g. in large rooms or halls), a permanently wired remote sensor can be connected to the TSM for temperature detection. Thus, the device offers a total of three methods for room temperature measurement, which can run in parallel.

The three methods for room temperature measurement can be configured on the "Room temperature measures -> TSM", "Room temperature measurement -> TSEM" and "Room temperature measurement -> Remote sensor" parameter pages. For each method, the temperature can be detected by the internal sensor, a received temperature value or the combination of measured temperature value (internal sensor) and received temperature value. The "Received temperature value" setting enables a communication object for receiving the temperature.

When choosing the installation location of the controller or the external sensors, the following points should be considered:

- The controller or temperature sensor should not be used in multiple combinations, especially together with flush-mounted dimmers.
- Do not install the temperature sensor in the area of large electrical consumers (avoid heat influences).
- The push button sensor should not be installed in the vicinity of radiators or cooling systems.
- The temperature sensor should not be exposed to direct sun.
- The installation of sensors on the inside of an outside wall might have a negative impact on the temperature measurement.
- Temperature sensors should be installed at least 30 cm away from doors, windows or ventilation units and at least 1.5 m above the floor.

- i** Room temperature measurement by the device is active, irrespective of the "Room temperature control" or "Controller extension" functions and can thus be used independently (e.g. for simple measurement and display of a room temperature without control).

- i** A deviation may occur in the measured temperature after a device reset or after switching on the background illumination of the display. Comparative measurements for the calibration of the room temperature measurement should take place approx. 30 minutes after a device reset or switching on the display.

Temperature detection and measured value formation

The "Temperature detection by" parameter in the "Room temperature measurement -> ..." parameter node specifies the sensors to detect the room temperature.

The following settings are possible for temperature detection:

- "internal temperature sensor"
The temperature sensor integrated in the device is activated. Thus, the actual temperature value is determined only locally on the device.
In this configuration, the feedback control will start directly after a device reset.

- "received temperature value"
The actual temperature is determined solely via a temperature value received from the bus. In this case, the sensor must either be a KNX room thermostat coupled via the 2-byte object "External temperature" or a controller extension with temperature detection. The device can request the current temperature value cyclically. For this purpose, the parameter "Request time for external sensor" must be set to a value > "0". The request interval can be configured within the limits of 1 minute to 255 minutes.
After a device reset the device will first wait for a valid temperature telegram until the feedback control starts and a command value, if applicable, is output.

- "internal sensor + received temperature value"
This setting is used to combine the selected temperature sources. The sensors can either be a KNX room thermostat coupled via the 2-byte object "External temperature" or controller extensions with temperature detection.
With the setting "Received temperature value" the device can request the current temperature value cyclically. For this purpose, the parameter "Request time for external sensor" must be set to a value > "0". The request interval can be configured within the limits of 1 minute to 255 minutes. After a device reset the device will first wait for a valid temperature telegram until the feedback control starts and a command value, if applicable, is output.
When evaluating, the real actual temperature is made up from the two respective measured temperature values. The weighting of the temperature values is defined by the "Creation of measuring value internal against external" parameter. Depending on the different locations of the sensors or a possible non-uniform heat distribution inside the room, it is thus possible to adjust the actual temperature measurement. Often, those temperature sensors that are subject to negative external influences (for example, unfavourable location because of exposure to sun or heater or door / window directly next to it) are weighted less heavily.

Example: a room temperature controller is installed next to the entrance to the room (internal sensor). An additional wired temperature sensor has been mounted on an inner wall in the middle of the room below the ceiling.

Internal sensor: 21.5 °C

External sensor: 22.3 °C

Determination of measured value: 30 % to 70 %

$$\rightarrow T_{\text{Result internal}} = T_{\text{internal}} \cdot 0.3 = 6.45 \text{ °C},$$

$$\rightarrow T_{\text{Result external}} = T_{\text{external}} \cdot 0.7 = 15.61 \text{ °C}$$

$$\rightarrow T_{\text{Result actual}} = T_{\text{Result internal}} + T_{\text{Result external}} = \underline{22.06 \text{ °C}}$$

Calibrating the measured values

In some cases during room temperature measurement, it may be necessary to adjust the temperature values of the internal and the external sensor (received temperature value).

Adjustment becomes necessary, for example, if the temperature measured by the sensors stays

permanently below or above the actual temperature in the vicinity of the sensor. To determine the temperature deviation, the actual room temperature should be detected with a reference measurement using a calibrated temperature measuring device.

The parameter "Internal sensor calibration..." and/or "External sensor adjustment..." allows configuration of the positive (temperature increase, factors: 1 ... 127) or negative (temperature decrease, factors -128... -1) temperature calibration in levels of 0.1 K. Thus, the calibration is made only once statically and is the same for all operating modes of the controller.

- i** The measured value has to be increased, if the value measured by the sensor lies below the actual room temperature. The measured value has to be decreased, if the value measured by the sensor lies above the actual room temperature.
- i** During room temperature control, the device always uses the adjusted temperature value to calculate the command values. The adjusted temperature value is transmitted to the bus via the "Actual temperature" object (see "Transmission of the actual temperature"). When determining the measured value using the internal and external sensor, the two calibrated values are used to calculate the actual value. If necessary, the unadjusted room temperature of the internal temperature sensor can additionally be transmitted to the bus as an information value (object "Actual temperature, unadjusted") and, for example, be evaluated in other bus devices or displayed in visualisations.
- i** Temperature adjustment only affects the room temperature measurement.

Transmission of the actual temperature

The determined actual temperature can be actively transmitted to the bus via the 2-byte "Actual temperature" object. The parameter "Transmission when room temperature change by..." specifies the temperature value by which the actual value has to change in order to have the actual temperature value transmitted automatically via the object. Possible temperature value changes lie within a range of 0.1 K and 25.5 K. Setting to "0" at this point will deactivate the automatic transmission of the actual temperature.

In addition, the actual value can be transmitted periodically. The "Cyclical transmission of the room temperature" parameter determines the cycle time (1 to 255 minutes). The value "0" will deactivate the periodical transmission of the actual temperature value.

Setting the "Read" flag on the "actual temperature" object makes it possible to read out the current actual value at any time over the bus. It has to be pointed out that with deactivated periodical transmission and deactivated automatic transmission, no more actual-temperature telegrams will be transmitted".

Following the return of bus voltage, new programming via the ETS, the object value will be updated according to the actual temperature value and transmitted on the bus. In case a temperature value telegram has not been received from the external sensor via the object "Received temperature value" when evaluating an external temperature sensor, only the value provided by the internal sensor will be transmitted. If only the external sensor is used, then the value "0" is located in the "Actual temperature" object after a reset. For this reason, the external temperature sensor should always transmit the current value after a reset.

During room temperature control, the controller always uses the adjusted temperature value to calculate the command values. The adjusted temperature value is transmitted to the bus via the "Actual temperature" object. If necessary, the unadjusted room temperature can additionally be transmitted to the bus as an information value via the object "Actual temperature, unadjusted" and, for example, be displayed in visualisations. The object for the unadjusted temperature is updated and transmitted at the same times as the "Actual temperature" object.

4.2.4.6 Rockers and button function

The following contains descriptions of the various functions that can be configured for each rocker or each button of the push-button sensor. The functions can be parameterized freely and without limitations for both the basic unit and for the push-button sensor extension module.

4.2.4.6.1 Switching function

For each rocker or each button with the function set to "switching" the ETS indicates a 1-bit communication object. The parameters of the rocker or button permit fixing the value this object is to adopt on pressing and / or on releasing (ON, OFF, TOGGLE – toggling of the object value). No distinction is made between a brief or long press.

The status LEDs can be configured independently .(see chapter 4.2.4.7.1. Functions of the status LED).

4.2.4.6.2 Dimming function

For each rocker or each button with the function set to "dimming" the ETS indicates a 1-bit and a 4-bit object. Generally, the push-button sensor transmits a switching telegram after a brief press and a dimming telegram after a long press. In the standard parameterisation, the push-button sensor transmits a telegram for stopping the dimming action after a long press. The time needed by the push-button sensor to detect an actuation as a long actuation can be set in the parameters.

The status LEDs can be configured independently . (see chapter 4.2.4.7.1. Functions of the status LED).

Single-area and dual-area operation in the dimming function

In the rocker function, the device is preprogrammed for dual-area operation for the dimming function. This means that the push-button sensor transmits a telegram for switch-on after a brief press and a telegram for increasing the brightness after a long press of the left button ("brighter"). Similarly, the push-button sensor transmits a telegram for switch-off after a brief press and a telegram for reducing the brightness after a long press on the right button ("darker").

With the button operation concept, the device is preprogrammed for single-area operation for the dimming function. In this mode, the push-button sensor transmits on each brief press ON and OFF telegrams in an alternating pattern ("TOGGLE"). After a long press, the push-button sensor transmits "brighter" and "darker" telegrams in an alternating pattern.

The parameter "Command on pressing the button" or "Command on pressing the rocker" on the parameter pages of the buttons or rockers defines the single-surface or dual-area operation principle for the dimming function. For the rocker and also for the button function, the command issued on pressing the button or rocker can basically be selected at the user's discretion.

- i** If the actuator can be controlled from several sensors, a faultless single-area operation requires that the addressed actuator reports its switching state back to the 1-bit object of the button or rocker and that the 4-bit objects of the push-button sensors are interlinked. The push-button sensor would otherwise not be able to detect that the actuator has been addressed from another sensor, in which case it would have to be actuated twice during the next use in order to produce the desired reaction.

Advanced parameters

For the dimming function, the push-button sensor can be programmed with advanced parameters which are hidden in the standard view for greater clarity. If necessary, these advanced parameters can be activated and thus be made visible.

The advanced parameters can be used to determine whether the push-button sensor is to cover the full adjusting range of the actuator with one dimming telegram continuously ("Increase brightness by 100 %", "Reduce brightness by 100 %") or whether the dimming range is to be divided into several small levels (50 %, 25 %, 12.5 %, 6 %, 3 %, 1.5 %).

In the continuous dimming mode (100%), the push-button sensor transmits a telegram only at the beginning of the long press to start the dimming process and generally a stop telegram after the end of the press. For dimming in small levels it may be useful if the push-button sensor repeats the dimming telegram in case of a sustained press for a presettable time (parameter "Telegram repetition"). The stop telegram after the end of the press is then not needed. When the parameters are hidden ("Advanced parameters = deactivated"), the dimming range is set to 100 %, the stop telegram is activated and the telegram repetition is deactivated.

Full-surface operation with the dimming function

When a rocker is used for dimming, the device needs some time at the beginning of each operation in order to distinguish between a short and a long operation. When full-surface

operation is enabled, the device can make use of this time span to evaluate the otherwise invalid simultaneous actuation of both buttons of the rocker.

Full-surface operation of a rocker switch is detected by the device when both buttons are pressed at the same time. As soon as the device detects a valid, full-surface operation, both status LEDs of the rocker flash green. The status LEDs flash for the length of the operation. Full-surface operation must have been detected before the first telegram has been transmitted by the dimming function (switching or dimming). If this is not so (e.g. one of the two buttons is pressed too late), the full-surface operation will not be correctly executed.

A full-surface operation is independent. It has a communication object of its own and can optionally be used for switching (ON, OFF, TOGGLE – toggling of the object value) or for scene recall without or with storage function. In the last case, the full-surface actuation causes a scene to be recalled in less than a second. If the device is to send the telegram for storing a scene, full-surface actuation must be maintained for more than five seconds. If full-surface actuation ends between the first and the fifth second, the device will not send any telegrams. If the status LEDs of the rocker are used as "button-press displays", they will light up for three seconds during transmission of the storage telegram.

4.2.4.6.3 "Blind" function

For each rocker or each button with the function set to "blind" the ETS indicates the two 1-bit objects "STEP operation" and "MOVE operation".

The status LEDs can be configured independently . (see chapter 4.2.4.7.1. Functions of the status LED).

Operation concept for the Venetian blind function

For the control of Venetian blind, roller shutter, awning or similar drives, the push-button sensor supports four operation concepts in which the telegrams are transmitted in different time sequences. The push-button sensor can therefore be used to operate a wide variety of drive configurations.

The different operation concepts are described in detail in the following chapters.

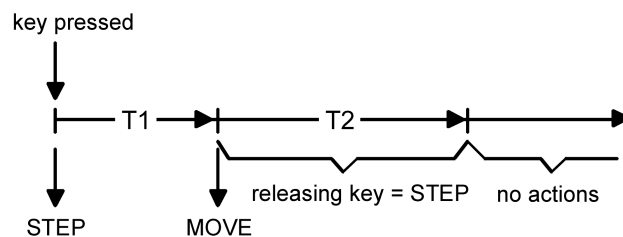

Figure 65: Operation concept "short – long – short"

Operation concept "short – long – short"

In the operation concept "short – long – short", the push-button sensor shows the following behaviour:

- Immediately on pressing the button, the push-button sensor transmits a short time telegram. Pressing the button stops a running drive and starts time T1 ("time between short time and long time command"). No other telegram will be transmitted, if the key is released within T1. This short time serves the purpose of stopping a continuous movement. The "time between short and long time command" in the push-button sensor should be selected shorter than the short time operation of the actuator to prevent a jerky movement of the blind.
- If the button is kept depressed longer than T1, the push-button transmits a long time telegram after the end of T1 for starting up the drive and time T2 ("slat adjusting time") is started.
- If the button is released within the slat adjusting time, the push-button sensor sends another short time telegram. This function is used for adjusting the slats of a blind. The function permits stopping the slats in any position during their rotation. The "slat adjusting time" should be chosen as required by the drive for a complete rotation of the slats. If the "slat adjusting time" is selected longer than the complete travelling time of the drive, a pushbutton function is possible as well. This means that the drive is active only when the button is kept depressed.
- If the button is kept depressed longer than T2, the push-button sensor transmits no further telegram. The drive remains on until the end position is reached.

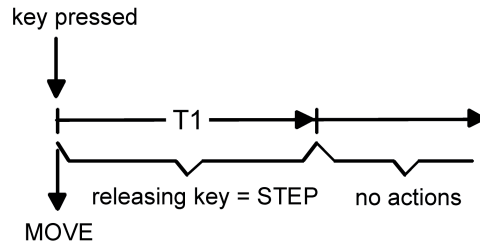

Figure 66: Operation concept "long – short"

Operation concept "long – short":

In the operation concept "short – long – short", the push-button sensor shows the following behaviour:

- Immediately on pressing the button, the push-button sensor transmits a long time telegram. The drive begins to move and time T1 ("slat adjusting time") is started.
- If the button is released within the slat adjusting time, the push-button sensor transmits a short time telegram. This function is used for adjusting the slats of a blind. The function permits stopping the slats in any position during their rotation. The "slat adjusting time" should be chosen as required by the drive for a complete rotation of the slats. If the "slat adjusting time" is selected longer than the complete travelling time of the drive, a pushbutton function is possible as well. This means that the drive is active only when the button is kept depressed.
- If the button is kept depressed longer than T1, the push-button sensor transmits no further telegram. The drive remains on until the end position is reached.

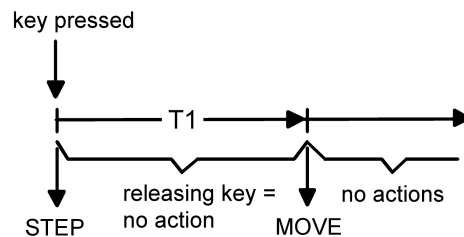

Figure 67: Operation concept "short – long"

Operation concept "short – long"

In the operation concept "short – long – short", the push-button sensor shows the following behaviour:

- Immediately on pressing the button, the push-button sensor transmits a short time telegram. Pressing the button stops a running drive and starts time T1 ("time between short time and long time command"). No other telegram will be transmitted, if the key is released within T1. This short time serves the purpose of stopping a continuous movement. The "time between short and long time command" in the push-button sensor should be selected shorter than the short time operation of the actuator to prevent a jerky movement of the blind.
- If the button is kept depressed longer than T1, the push-button transmits a long time telegram after the end of T1 for starting the drive.
- No further telegram is transmitted when the button is released. The drive remains on until the end position is reached.

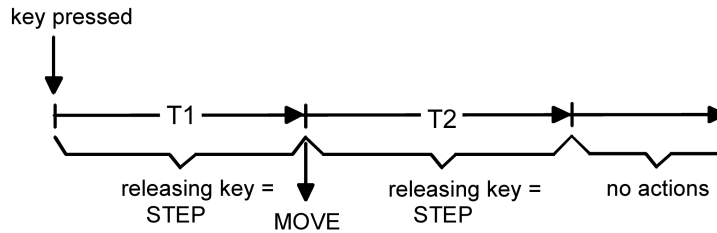

Figure 68: Operation concept "long – short or short"

Operation concept "long – short or short":

In the operation concept "long – short or short", the push-button sensor shows the following behaviour:

- Immediately on pressing the button, the push-button sensor starts time T1 ("time between short and long time command") and waits. If the button is released again before T1 has elapsed, the push-button sensor transmits a short time telegram. This telegram can be used to stop a running drive. A stationary drive rotates the slats by one level.
- If the button is kept depressed after T1 has elapsed, the push-button sensor transmits a long time telegram and starts time T2 ("slat adjusting time").
- If the button is released within T2, the push-button sensor sends another short time telegram. This function is used for adjusting the slats of a blind. The function permits stopping the slats in any position during their rotation. The "slat adjusting time" should be chosen as required by the drive for a complete rotation of the slats. If the "slat adjusting time" is selected longer than the complete travelling time of the drive, a pushbutton function is possible as well. This means that the drive is active only when the button is kept depressed.
- If the button is kept depressed longer than T2, the push-button sensor transmits no further telegram. The drive remains on until the end position is reached.

i In this operation concept, the push-button sensor will not transmit a telegram immediately after depressing one side of the rocker. This principle permits detecting a full-surface operation when the sensor is configured as a rocker.

Single-surface and dual-area operation in the blind function

As a rocker, the device is preprogrammed for dual-area operation for the blind function. This means that the push-button sensor, e.g. with a press of the left button, transmits a telegram for an upward movement and, after a press of the right button, a telegram for a downward movement.

In the separate buttons function, the device is preprogrammed for single-area operation for the blind function. In this case, the push-button sensor alternates between the directions of the long time telegram (TOGGLE) on each long actuation of the sensor. Several short time telegrams in succession have the same direction.

The parameter "Command on pressing the button" or "Command on pressing the rocker" on the parameter pages of the buttons or rockers defines the single-surface or dual-area operation principle for the Venetian blind function.

For the button function, the command issued on pressing the button can basically be selected at the user's discretion.

If the actuator can be controlled from several sensors, a faultless single-area operation requires that the long time objects of the push-button sensors are interlinked. The push-button sensor would otherwise not be able to detect that the actuator has been addressed from another sensor, in which case it would have to be actuated twice during the next use in order to produce the desired reaction.

Full-surface operation with Venetian blind function

When a rocker is configured for Venetian blind operation and if the operation concept "long – short or short" is used, the push-button sensor needs some time at the beginning of each operation in order to distinguish between a short and a long operation. When full-surface operation is enabled, the device can make use of this time span to evaluate the otherwise invalid simultaneous actuation of both buttons of a rocker.

Full-surface operation of a rocker switch is detected by the device when both buttons are pressed at the same time. As soon as the device detects a valid, full-surface operation, both status LEDs of the rocker flash green. The status LEDs flash for the length of the operation. Full-surface operation must have been detected before the first telegram has been transmitted by the Venetian blind function (short time or long time). If this is not so (e.g. one of the two buttons is pressed too late), the full-surface operation will not be correctly executed.

A full-surface operation is independent. It has a communication object of its own and can optionally be used for switching (ON, OFF, TOGGLE – toggling of the object value) or for scene recall without or with storage function. In the last case, the full-surface actuation causes a scene to be recalled in less than a second. If the device is to send the telegram for storing a scene, full-surface actuation must be maintained for more than five seconds. If full-surface actuation ends between the first and the fifth second, the device will not send any telegrams. If the status LEDs of the rocker are used as "button-press displays", they will light up for three seconds during transmission of the storage telegram.

4.2.4.6.4 "Value transmitter" function

For each rocker or each button with the function set to "1-byte value transmitter" or "2-byte value transmitter" the ETS indicates a corresponding object. On the press of a button, the configured value or the value last stored internally by a value change (see below) will be transmitted to the bus. In case of the rocker function, different values can be configured or varied for both actuation points.

The status LEDs can be configured independently (see chapter 4.2.4.7.1. Functions of the status LED).

Value ranges

The "Function" parameter determines the value range used by the push-button.

As a 1-byte value transmitter, the push-button sensor can optionally transmit integers from 0 ... 255 or relative values within a range of 0 ... 100 % (e.g. as dimming value transmitter).

As a 2-byte value transmitter, the push-button sensor can optionally transmit integers from 0 ... 65535, temperature values within a range of 0 ... 40 °C or brightness values from 0 ... 1500 lux.

For each of these ranges, the value that can be transmitted to the bus for each actuation of a rocker or button is configurable.

Adjustment by means of long button-press

If the value adjustment feature has been enabled in the ETS, the button must be kept depressed for more than 5 seconds in order to vary the current value of the value transmitter. The value adjustment function continues to be active until the button is released again. In a value adjustment, the push-button sensor distinguishes between the following options...

- The "Starting value in case of value adjustment" parameter defines the original starting value for the adjustment. Adjustment can begin from the value configured in the ETS, from the final value of the last adjustment cycle or from the current value of the communication object, with the last option not being available for the temperature and brightness value transmitter.
- The parameter "Direction of value adjustment" defines whether the values will always be increased ("upwards"), always reduced ("downwards") or alternately increased and reduced ("toggling").
- For the value transmitters 0 ... 255, 0 ... 100 % and 0 ... 65535, the "step width" by which the current value is to be changed during the value adjustment can be specified. In case of the temperature and the brightness value transmitter, the step width specifications (1 °C and 50 lux) are fixed.
- The parameter "Time between two telegrams" can be used in connection with the step width to define the time required to cycle through the full respective value range. This value defines the time span between two value transmissions.
- If, during the value adjustment, the push-button sensor detects that the preset step width would result in the limits being exceeded with the next telegram, it adapts the step width once in such a way that the respective limit value is transmitted together with last telegram. Depending on the setting of the parameter "Value adjustment with overflow", the push-button sensor stops the adjustment at this instance or inserts a pause consisting of two levels and then continues the adjustment beginning with the other limit value.

Value range limits for the different value transmitters:

	Function	Lower numerical limit	Upper numerical limit
--	----------	-----------------------	-----------------------

1-byte value transmitter	0...255	0	255
1-byte value transmitter	0...100 %	0 % (value = 0)	100 % (value = 255)
2-byte value transmitter	0...65535	0	65535
2-byte value transmitter	Temperature value	0 °C	40 °C
2-byte value transmitter	Brightness value	0 lux	1.500 lux

- i** During a value adjustment, the newly adjusted values are only in the volatile RAM memory of the push button sensor. Therefore, the stored values are replaced by the preset values programmed in the ETS when a reset of the push button sensor occurs (bus voltage failure or ETS programming).
- i** During a value adjustment, the status LED of the corresponding button is switched off irrespective of configuration. The status LED will then light up for ca. 250 ms whenever a new value is transmitted.
- i** With the 1-byte value transmitter in the "Value transmitter 0...100 %" function, the step width of the adjustment will also be indicated in "%". If the starting value of the communication object is used, it may happen in this case during value adjustment that the value last received via the object must be rounded and adapted before a new value can be calculated on the basis of the step width and transmitted. Due to the computation procedure used, the new calculation of the value may be slightly inaccurate.

Value adjustment examples

Configuration example:

- Value transmitter 1-byte (all other value transmitters identical)
- Function = value transmitter 0...255
- Value configured in the ETS (0...255) = 227
- Step width (1...10) = 5
- Start on value adjustment = same as configured value
- Direction of value adjustment = toggling (alternating)
- Time between two telegrams = 0.5 s

Example 1: Value adjustment with overflow? = No

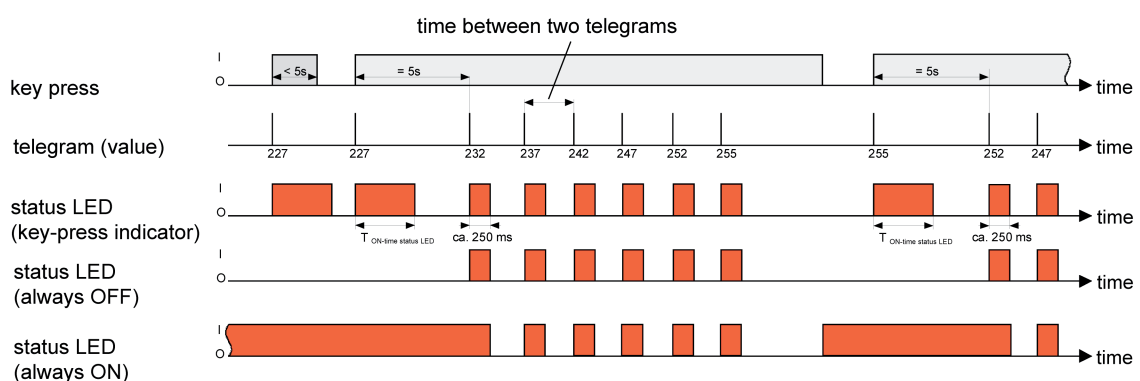

Figure 69: Example of value adjustment without value range overflow

Example 2: Value adjustment with overflow? = Yes

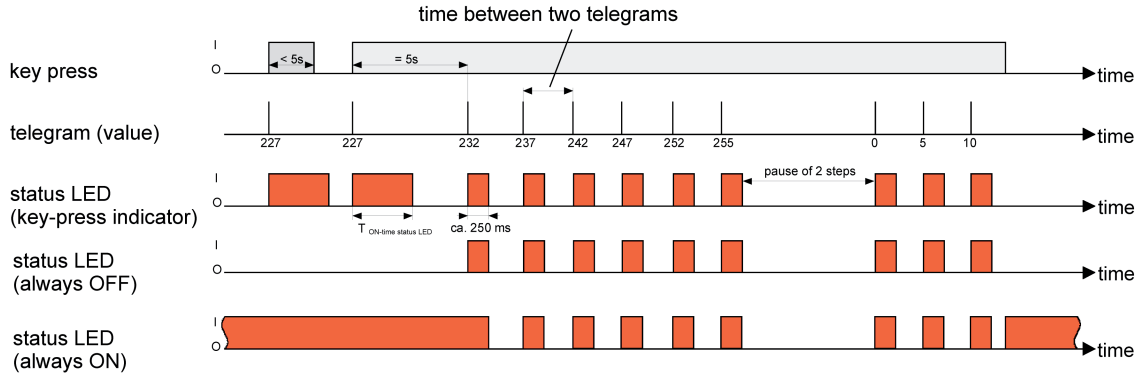

Figure 70: Example of value adjustment with value range overflow

4.2.4.6.5 Scene extension function

For each rocker or each button with the function set to "scene extension" the ETS indicates the "Function" parameter which distinguishes between the settings...

- "Scene extension without storage function",
- "Scene extension with storage function",
- "Recall internal scene without storage function"
- "Recall internal scene with storage function".

...unterscheidet.

In the scene extension function, the push-button sensor transmits a preset scene number (1...64) via a separate communication object to the bus after a button-press. This feature permits recalling scenes stored in other devices and also storing them, if the storage function is used.

The recall of an internal scene does not result in a telegram being transmitted to the bus. For this reason, the corresponding communication object is missing. This function can rather be used to recall – and with the storage function also to store – the up to 8 scenes stored internally in the device.

In the setting "... without storage function", a button-press triggers the simple recall of a scene. If the status LED is configured as button-press display, it will be switched on for the configured ON time. A long button-press has no further or additional effect.

In the setting "... with storage function", the push-button sensor monitors the length of the actuation. A button actuation of less than a second results in a simple recall of the scene as mentioned above. If the status LED is configured as button-press display, it will be switched on for the configured ON time.

After a button actuation of more than five seconds, the push-button sensor generates a storage instruction. In the scene extension function, a storage telegram is in this case transmitted to the bus. If configured for the recall of an internal scene, the sensor will store the internal scene. The internal scene control module of the device will then request the current scene values for the actuator groups used from the bus (see chapter 4.2.4.8. Scene function). If the status LED is configured as an actuation display, then the status LED signals that the saving of the scene situation has been initiated by a static switch-on for three seconds.

An operation lasting between one and five seconds will be discarded as invalid.

The parameter "Scene number" specifies which of the maximum of 8 internal or 64 external scenes is to be used after a button-press. In case of the rocker function, two different scene numbers can be assigned.

The status LEDs can be configured independently (see chapter 4.2.4.7.1. Functions of the status LED).

4.2.4.6.6 2-channel operation function

In some situations it is desirable to control two different functions with a single button-press and to transmit different telegrams, i.e. to operate two function channels at a time. This is possible with the "2-channel operation" function.

For both channels, the parameters "Function channel 1" and "Function channel 2" can be used to determine the communication object types to be used. The following can be selected...

- Switching (1 bit)
- Value transmitter 0 ... 255 (1-byte)
- Value transmitter 0 ... 100 % (1-byte)
- Temperature value transmitter (2 bytes)

The object value the push-button sensor is to transmit on a button actuation can be selected depending on the selected object type. The "Switching (1 bit)" type permits selecting whether an ON or an OFF telegram is to be transmitted or whether the object value is to be switched over (TOGGLE) and transmitted on the press of a button.

The configuration as "Value transmitter 0 ... 255 (1 byte)" or as "Value transmitter 0 ... 100 % (1 byte)" permits entering the object value freely within a range from 0 to 255 or from 0% to 100%. The "Temperature value transmitter (2 bytes)" permits selecting a temperature value between 0°C and 40°C.

In this case, the adjustment of the object value on a long button-press is not possible as the determination of the actuation length is needed for the adjustable operation concepts.

Unlike in the other rocker and button functions, the application software assigns the "Telegram acknowledge" function instead of the "Button-press display" function to the status LED. In this mode, the status LED lights up for approx. 250 ms with each telegram transmitted. Alternatively, the status LEDs can be configured independently (see chapter 4.2.4.7.1. Functions of the status LED).

Operation concept channel 1 or channel 2

In this operation concept, exactly one telegram will be transmitted on each press of a button.

- On a brief press the push button-sensor transmits the telegram for channel 1.
- On a long press the push-button sensor transmits the telegram for channel 2.

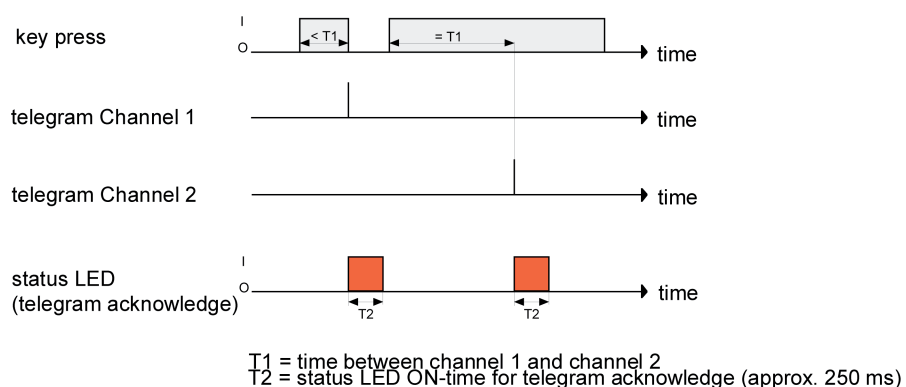

Figure 71: Example of operation concept "Channel 1 or Channel 2"

The time required for distinguishing between a short and a long operation is defined by the parameter "Time between channel 1 and channel 2". If the button is pressed for less than the configured time, only the telegram to channel 1 is transmitted. If the length of the button-press exceeds the time between channel 1 and channel 2, only the telegram to channel 2 will be transmitted. This concept provides the transmission of only one channel. To indicate that a

telegram has been transmitted, the status LED lights up for approx. 250 ms in the "Telegram acknowledge" setting.

In this operation concept, the push-button sensor will not transmit a telegram immediately after the rocker has been depressed. This principle also permits the detection of full-surface operation. The settings that are possible with full-surface operation are described below.

Operation concept channel 1 and channel 2

With this operation concept, one or alternatively two telegrams can be transmitted on each button-press.

- On a brief press the push button-sensor transmits the telegram for channel 1.
- A long press causes the push-button sensor to transmit first the telegram for channel 1 and then the telegram for channel 2.

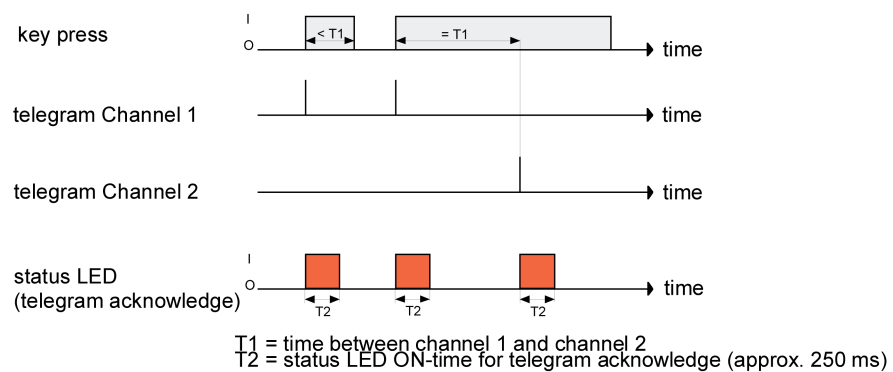

Figure 72: Example of operation concept "Channel 1 or Channel 2"

The time required for distinguishing between a short and a long operation is defined by the parameter "Time between channel 1 and channel 2". In this operation concept, a button-press sends this telegram immediately to channel 1. If the button is held depressed for the configured time, the telegram for the second channel is transmitted as well. If the button is released before the time has elapsed, no further telegram will be transmitted. This operation concept, too, offers the configurable possibility of having the transmission of a telegram signalled by the status LED (setting "Telegram acknowledge").

Full-surface operation with 2-channel operation

When a rocker is programmed for 2-channel operation and if the operation concept "channel 1 or channel 2" is used, the push-button sensor needs some time at the beginning of each operation in order to distinguish between a short and a long operation. When full-surface operation is enabled, the push-button sensor can make use of this time span to evaluate the otherwise invalid simultaneous actuation of both buttons of a rocker.

Full-surface operation of a rocker switch is detected by the device when both buttons are pressed at the same time. As soon as the device detects a valid, full-surface operation, both status LEDs of the rocker flash green. The status LEDs flash for the length of the operation. The full-surface operation must have been detected before the first telegram has been transmitted by the 2-channel function. If this is not so (e.g. one of the two buttons is pressed too late), the full-surface operation will not be correctly executed.

4.2.4.6.7 Controller extension function

- i** The "controller extension" function is purely a button function and thus is not available with the "rocker function" operation concept.

For each button with the function set to "controller extension" the ETS indicates the "Function" parameter which distinguishes between the settings:

- "Operating mode switchover"
- "Forced oper. mode switchover"
- "Presence button"
- "Setpoint shift"

...unterscheidet.

- i** The "Controller extension" button function of the TSM is only effective when the "Room temperature controller function" parameter has been set to "Controller extension" on the "Room temperature control" parameter page.

- i** The "Controller extension" button function of the TSEM is only effective when the "Controller extension" parameter has been set to "enabled" on the "Configuration TSEM" parameter page.

In one of the previous chapters, (see chapter 4.2.4.4.1. Connection to room temperature controller) we will discuss the "Controller extension" function in more detail.

4.2.4.6.8 Controller operation function

- i** The "Controller operation" function is purely a button function and thus is not available with the "rocker function" operation concept.

The "Controller operation" button function can be used to control the internal room temperature controller. If this button function is used, it is possible to change over the operating mode, shift the setpoint, change-over the presence status or change the fan level.

These functions allow the controller to be operated immediately when a button is pressed, without triggering a telegram immediately to the communication objects of the controller. The setpoint shift is cited here as an example. Whereas a controller extension transmits a telegram to the "Preset setpoint shifting" object and the controller evaluates and transmits its value to the bus according to the new setpoint and current setpoint shift, the "Controller operation" function with the "setpoint shift" functionality affects the controller directly.

For each button with the function set to "Controller operation" the ETS indicates the "Function" parameter which distinguishes between the settings...

- "Operating mode switchover"
- "Forced oper. mode switchover"
- "Presence button"
- "Setpoint shift"
- "Fan controller"

...unterscheidet.

- i** The "Controller operation" button function of the device is only effective when the "Room temperature controller function" parameter has been set to "switched on" on the "Room temperature control" parameter page.

Functions for "Operating mode selection" and "Forced operating mode switchover"

Switchover of the controller operating mode can be effected in accordance with the standard function block for room temperature controllers defined in the KNX handbook with two 1-byte communication objects. The operating mode can be switched over with the normal and with the forced objects. The "operating mode switchover" object offers a selection between the following operating modes...

- Comfort mode
- Night mode
- Standby mode
- Frost/heat protection mode

The "Forced operating mode switch over" communication object has a higher priority. It permits forced switching between the following modes of operation...

- Auto (normal operating mode switchover)
- Comfort mode
- Night mode
- Standby mode
- Frost/heat protection mode

The operating mode transmitted to the bus on a button press of the controller extension is defined by the parameter "Operating mode on pressing the button". Depending on the configured functionality, it is possible that ...

- either one of the above-mentioned modes is activated (single selection) on pressing the button,
- or the device is switched over between two or three modes (multiple selection).

i If a status LED is to indicate the current operating mode, the status LED function must be programmed for "Operating mode indication" and its status object be linked with the corresponding group address for operating mode change-over with normal or high priority.

"Presence button" function

All buttons with their function set to "Presence button" are internally linked with the "presence button" object. The parameter "Presence function on pressing the button" defines the object value transmitted to the bus on pressing a button.

It is not possible to program a reaction on release of the button. A long button-press is evaluated in the same way as short one and switches into the corresponding presence mode insofar as this is acceptable for the controller.

The status LED of the presence button can indicate both the presence status (setting "Button function indication active / inactive") and also the actuation of the button. In addition, the usual setting possibilities of the status LED are configurable as well .

"Setpoint shift" function"

The setpoint shift is another available function of the controller operation. It makes use of two 1-byte communication objects with datapoint type 6.010 (integer with sign). This controller function allows the basic setpoint for the temperature of the internal room temperature controller to be shifted by pressing a button. A button configured as a setpoint shifting button reduces or increases the setpoint shift value on each press by one step respectively. The direction of the value adjustment is defined by the parameter "Setpoint shift on pressing the button". Releasing the button and a long press have no other functions.

i Optionally the setpoint of the respective current operating mode can be shown automatically in the display if a setpoint shift is performed using the buttons of the device. The setpoint temperature is then displayed temporarily for 5 s in °C or °F, and overwrites the normal display (actual temperature, etc.). The setpoint display in the case of a setpoint shift can be activated by setting the "Show temporary setpoint controller n on setpoint shift?" parameter to "Yes". With the setting "No" the temporary indication is inactive, meaning that in case of a setpoint shift only the line graphic is activated, but the temperature value is not also displayed automatically.

"Fan controller" function

Another function of the controller operation can be the "fan controller".

Here, the fan controller can be configured so that it either sets the fan controller to automatic mode or takes over the manual control.

When the button with the "Automatic" function is pressed, the device is switched to automatic mode. If the fan controller was already in automatic mode, there is no reaction. If the fan controller was in manual mode (manual control), the manually set fan level is adjusted to the controller command value via the automatic system.

When the button with the "Manual" function is pressed, if automatic mode is active, the device is switched to manual mode. If the fan controller is in manual mode, the fan level is incremented when a button is pressed.

Releasing the button and a long press have no other functions. The status LED can be

configured so that it is permanently on or off, the pressing of the button or the status of the switching object "fan control automatic or manual" does not display inverted or displays inverted.

4.2.4.6.9 "Change in the display reading" function

Up to 17 pieces of display information (actual temperature, setpoint temperature, outdoor temperature, any temperature) can be optionally displayed on the LC display of the device with the room temperature controller icons (see chapter 4.2.4.2.1. Displayed information).

The individual pieces of information are shown separately in the numeric display. If more than one piece of display information is configured in the ETS in the parameter node "Display", then the display must be switched over during operation.

In addition to the cyclical change, the indication can also be switched by pressing a button on the device. To do this it is possible to configure a button for the "Change in the display reading" function. This configuration is performed in the parameter block of the respective button. This function can be configured for any desired buttons on the TSM and optionally also for buttons on the extension module.

When a button is pressed, depending on the "On pressing a button" parameter either the next or the previous display information is called up in accordance with the cyclical change. With this setting the display information specified according to the configuration in the "Display" parameter node can be switched directly.

Alternatively it is also possible to call up a particular piece of information immediately independently of the display information of the cyclical change (e.g. button function "Recall display information 1"). It is not assumed here that the indication called up in this manner is in fact integrated into the cyclical change. After a piece of information is called up by pressing a button, the indication is retained until the time for the cyclical change has elapsed.

i In the parameter node "Display -> General -> General information -> Display n", it is also possible to set that there is no display using the parameter "Display information n". In the "No display" setting, no information is shown in the display when the display information is recalled (by button function, by object or cyclically). The appropriate segments for display information are switched off. In this case, the display is dark when the button function icons are not displayed (only the icons of the room temperature controller are displayed). It is then only possible as necessary to call up individual display information by pressing a button using the button function "Change in the display reading". The indication called up in this manner then remains temporarily visible in the display depending on the time configured for the cyclical change.

In the "No display" setting, no information is shown in the display when the display information is recalled (by button function, by object or cyclically). The appropriate segments for display information are switched off.

i The time for the cyclical change of the display can be set in the ETS in the parameter node "Display".

4.2.4.7 Status LED

4.2.4.7.1 Functions of the status LED

Each control surface on the TSM or on the TSEM has a three-colour status LED. The functions available differ slightly depending on the settings of the rockers or buttons.

- i** In order to keep the complexity of the ETS product database within limits, the ETS always offers all function settings for the status LED – regardless of the set function of the respectively corresponding rocker or button. In every case in which the combination of button / rocker switch functions and the LED function do not result in a sensible display, the LED remains switched off permanently.
The LED functions configurable for each set button / rocker function are written as information text on the parameter pages "Status LED".

The following functions are always configurable for each status LED, even if the corresponding buttons have no assigned function...

- always OFF,
- always ON,
- 2-colour status indicator (LED object) (only if "colour selection per status LED"!),
- Control via separate LED object,
- Operating mode display (KNX controller),
- Controller status indication,
- Comparator without sign (1 byte),
- Comparator with sign (1 byte).

If a function has been assigned to a rocker or button, the following functions can be additionally parameterised...

- Button-press display.

For the function "2-channel operation", the LED function "Button-press display" corresponds to the setting...

- Telegram acknowledgment.

If the rocker or the button is used for switching or dimming, the following functions can additionally be parameterised...

- Status display (switching object),
- inverted status display (switching object).

If a button is used for controller operation or for operation of a controller extension (controller extension must be enabled), the following settings can also be predefined...

- Setpoint value shift display,
- Presence status,
- Inverted presence status.
- Fan controller display (only if "controller operation"!).

- i** Besides the functions that can be set separately for each status LED, all status LEDs are also used together with the operation LED for alarm signalling. If this is active, all LEDs of the TSM or of the TSEM flash simultaneously. After deactivation of the alarm signalling, all LEDs will immediately return to the state corresponding to their configuration and communication objects.

Status LED function "always OFF" or "always ON"

With this parameterisation, a status LED remains permanently switched on or off.

Function of the status LED "Button-press display" or "Telegram acknowledgement"

A status LED used as button-press display is switched on by the sensor each time the corresponding rocker or button is pressed. The parameter "ON time of status LEDs as actuation indicators" on the parameter page "General" specifies for how long the LED is switched on in common for all status LEDs. The status LED lights up when the rocker or button is pressed even if the telegram is transmitted by the sensor only when the button or rocker is released.

With the function "2-channel operation" the option "Button-press display" is replaced by "Telegram acknowledge". In this case the status LED is illuminated when both channels are transmitted for about 250 ms each.

With the "Scene extension with storage function" and "Recall internal scene with storage function" functions, the status LED signals that the saving of the scene situation has been initiated by a static switch-on for three seconds.

Function of the status LED "Control via separate LED object", "Status display", and "Inverted status display"

Each status LED can indicate the status of a separate LED communication object independently of the rocker or button configuration. Here the LED can be switched on or off statically via the 1-bit object value received, or also activated as flashing.

Additionally, the status LEDs can be linked in the rocker or button functions "switching" and "dimming" also with the object used for switching and thus signal the current switching state of the actuator group.

Both for the status indication of the LED object and also for the status indication of the switching object it is possible to indicate or evaluate the inverted object value.

After a reset or after ETS programming, the value of the LED object is always "OFF".

Function of the status LED "2-colour status display"

The status LEDs can indicate the current switching state of a separate LED communication object for each rocker or button function. A colour can be configured for each switching state of the object. The parameter "colour of status LED" defines the display colour of status LED for the switching states "ON" and "OFF", e.g. "OFF= blue, ON = green".

This requires that the parameter "Colour of all status LEDs" on the parameter page "Configuration TSM" is set to "Colour selection per status LED".

After a reset or after ETS programming, the value of the communication object is always "OFF".

Function of status LED as "operating mode display (KNX controller)"

For switching over between different modes of operation, new room temperature controller can make use of two communication objects of the 20.102 "HVAC-Mode" data type. One of these objects can switch over with normal priority between the "Comfort", "Standby", "Night", "Frost/heat protection" operating modes. The second object has a higher priority. It permits switching over between "Automatic", "Comfort", "Standby", "Night", "Frost/heat protection". Automatic means in this case that the object with the lower priority is active.

If a status LED is to indicate the operating mode, the communication object of the status LED must be linked with the matching object of the room temperature controller. The desired operating mode which the LED is to indicate can then be selected with the parameter "Status LED on with". The LED is then lit up when the corresponding operating mode has been activated at the controller.

After a reset or after ETS programming, the value of the LED object is always "0" (automatic).

Function of status LED as "controller status display"

If a status LED is to indicate the status of a room temperature controller, the room temperature controller function or controller extension must have been activated on the parameter page "room temperature controller..." With this function the status of the general controller and KNX compliant controller can be displayed. The status LED is then internally connected immediately with the corresponding communication object of the internal room temperature controller or controller extension, for the general controller status with 1-byte object "Controller status" and additionally with the 1-byte object "Status signal addition" or with the 2-byte object "KNX controller status" in the case of a KNX compliant status output. If the device is configured as a controller extension, the corresponding object must then be linked via a group address to the corresponding communication object of the controller. The "Status LED ON if" parameter defines which information should be evaluated and displayed via the status LED.

Below is a breakdown of the status objects listed separately for the general controller status...

Controller status: Controller general

The object "Controller status" groups eight different information units in a bit-oriented way in a byte. For this reason it is important to select in the "Status LED on with" parameter which information is to be indicated, i.e. which bit is to be evaluated.

The following can be selected...

- Bit 0: Comfort mode
- Bit 1: Standby mode
- Bit 2: Night mode
- Bit 3: Frost/heat protection mode
- Bit 4: Controller disabled
- Bit 5: Heating / cooling (heating = 1 / cooling = 0)
- Bit 6: Controller inactive (dead zone operation)
- Bit 7: Frost alarm

Description of bit-oriented status messages of the room temperature controller (active = ON)

Comfort mode: Active if operating mode "Comfort" or a comfort extension is activated.

Standby mode: Active if the "Standby" operating mode is activated.

Night mode: Active if the "Night" operating mode is activated.

Frost/heat protection: Active if the "Frost/heat protection" operating mode is activated.

Controller disabled: Active if controller disable is activated (dew point mode).

Heating/cooling: Active if heating is activated and inactive if cooling is activated. (As a rule inactive with controller disabled.)

Controller inactive: Active with the "heating and cooling" operating mode when the measured room temperature lies within the dead zone. This status information is as a rule always "0" for the individual operating modes "heating" or "cooling"! (Inactive if controller is disabled.)

Frost alarm: Active if the measured room temperature reaches or drops below + 5 °C.

The object "Status signal addition" groups eight different information units in a bit-oriented way in a byte. For this reason it is important to select in the "Status LED on with" parameter which information is to be indicated, i.e. which bit is to be evaluated.

The following can be selected...

- Bit 0: Normal/ forced operation (normal operation = 1 / forced operation = 0)

- Bit 1: Comfort mode extension
- Bit 2: Status of the presence detector (presence = 1 / no presence = 0)
- Bit 3: Status of the presence button (presence = 1 / no presence = 0)
- Bit 4: Window status (Window open = 1 / Window closed = 0)
- Bit 5: Additional level active
- Bit 6: Heat protection active
- Bit 7: Dew point alarm active

Description of bit-oriented status messages of the room temperature controller (active = ON)

Normal/ forced operation: Active if the normal operation is activated and inactive if the forced operation is activated.

Comfort mode extension: Active if the comfort mode extension is activated.

Presence detector: Presence: Active if presence via sensor is activated.

Presence button: Presence: Active if presence via button is activated.

Window open: Active if window contact is active.

Additional level active: Active if the additional level is activated.

Heat protection active: Active if the heat protection is activated.

active dew point alarm: Active if the dew point alarm is activated.

Below is a breakdown of the status objects listed separately for the KNX compliant controller status...

Controller status: KNX compliant

The object "KNX controller status" groups 5 different information units in a bit-oriented way in two bytes. For this reason it is important to select in the "Status LED on with" parameter which information is to be indicated, i.e. which bit is to be evaluated.

The following can be selected...

- Bit 0: Controller fault
- Bit 8: Heating / cooling (heating = 1 / cooling = 0)
- Bit 12: Dew point alarm active
- Bit 13: Frost protection temperature undershot!
- Bit 14: Heat protection temperature exceeded!

Description of bit-oriented KNX compliant status messages of the room temperature controller (active = ON)

Bit 0: Active if controller fault.

Bit 8: Active in heating mode and inactive in cooling mode.

Bit 12: Active in active dew point operation.

Bit 13: Active if frost protection temperature is undershot.

Bit 14: Active if heat protection temperature is exceeded.

Function of the status LEDs "Setpoint value shift indicator", "Presence status indicator" and "Inverted presence status indicator":

With these LED functions, too, the room temperature controller function or the controller extension must have been activated on parameter page "Room temperature controller..." in order for a status LED to indicate the setpoint shift or the presence status of a room temperature controller function. When a setpoint shift is indicated, the LED evaluates the value of the object "C.Output - Current setpoint shift" or "Controller extension - Current setpoint shift" and switches either on or off, depending on the parameter configuration in the ETS. In the case of configuration as controller extension, this object must be linked via a group address to the object of the controller with the same function.

When indicating the presence status, the LED evaluates the state of the object "C.Input/Output - Presence object" or "Controller extension - Presence button" and indicates it immediately (presence mode on = LED on / presence mode off = LED off). When using the device as a controller extension, this object, too, must be linked via a group address to the same object of the controller.

- i** The communication objects "Presence button", "Current setpoint shift" and "Controller status" of the internal controller or controller extension update themselves automatically after a reset, if the parameter "Value request from controller extension" on parameter page "Configuration..." is set to "Yes". Updating is effected by means of a value read telegram to the room temperature controller. The thermostat must answer the request with a value return telegram. If the push-button sensor does not receive the answer, the status LED remains off (object value "0"). In this case, the object must first be actively rewritten by the bus after a reset before a status information can be indicated by the LED. This is also the case, when the "Value request from controller extension?" is set to "No".

Function of the status LED "Fan controller display":

- i** This function of a status LED is only available for the TSM.

With this LED function, too, the room temperature controller function must have been activated on the parameter page "Room temperature controller..." in order for a status LED to indicate the fan controller of a room temperature controller. When a fan controller is indicated, the LED evaluates the current status of the fan controller of the internal controller and switches either on or off, depending on the parameter configuration in the ETS. Depending on the project design, the status display is performed for automatic fan controller or manual controller.

Function of status LED as "comparator"

The status LED can indicate whether a parameterized reference value is greater than, equal to or less than the 1-byte object value of the status object. This comparator can be used for unsigned (0 ... 255) or for signed integers (-128 ... 127). The data format of the comparison is defined by the function of the status LED.

The status LED lights up only if the comparison is "true".

- i** After a reset or after ETS programming, the value of the LED object is always "0".

User-defined colour setting, superimposed function and automatic colour change

The colour of the status LEDs can be adjusted. If no 3-colour individual control is configured in the parameterisation, red, green and blue can be selected from for the status LED colours in the ETS. In the colour configuration, a distinction is made between whether all of the status LEDs of the basic device or extension module have the same colour (common colour setting), or whether alternatively different colours can be configured for the LEDs (separate colour setting).

The difference is as follows...

- All status LEDs have the same colour.
If the common colour setting is desired, then the parameter "Colour of all status LEDs" on parameter page "Configuration..." must be parameterised to the settings "red", "green" or "blue". The status LEDs light up later during operation of the TSM or of the TSEM unchangeably in the configured colour, if they are switched on.

- The status LEDs have various colours.
If the separate colour setting is desired, then the parameter "Colour of all status LEDs" on parameter page "Configuration..." must be parameterised to the setting "Colour selection per status LED". In this case additional parameters become visible on the parameter pages of the individual status LEDs. The parameters "Colour of the status LED" can then be used individually to define the desired colour for each status LED. The LED lights up in the configured colour if it is subsequently switched on regularly in operation, in accordance with the basic configuration "Function of the status LED".

In addition, with separate colour setting it is possible to configure a superposed function separately for each status LED. The superposed function can be used change the colour of a status LED via a communication object during operation of the device. It is also possible here to change the display function. The superposed function of a status LED is enabled when the parameter with the same name is configured to "enabled" on the corresponding parameter page.

When a superposed function is enabled, additional parameters and a communication object become visible in the ETS. It is thus possible to configure which colour the status LED should have when a superposed function is active, and which display function is then executed. The parameter "Selection of the superposed LED function" defines the display function, and thus the data format of the object. The following selections are available: "Control via separate LED object" (1-bit) or alternatively "Comparator without / with sign" (1-byte). The fundamental function of these superposed display functions is the same as the functions of the basic display of a status LED.

In accordance with the selection of the display function and the parameter configuration resulting from it, the superposed function can be switched on or off via the 1-bit or 1-byte object. The status LED will only light up in the superposed colour when a function is switched on. When a superposed function is switched off the status LED will be activated according to its basic configuration (regular colour and display function).

For the user-defined colour settings, an automatic colour change can be configured for the LED functions "Operating mode display", "Controller status", "Setpoint shift" and "Comparator". In this case, the colour of the corresponding status LED does not depend on the user specification via ETS parameter or communication object (superimposed function). Instead, the device then automatically decides which in colour the status LED should light up, based on the function value. The parameter "Status LED = ON for" indicates the colour which is set in dependence on the function value. This parameter cannot be changed.

- i** The superposed function is initially always inactive after a device reset. The superposed function is only executed when a telegram is received via the corresponding object.
- i** Regardless of the basic configuration of the status LED and the superposed function, the LEDs always flash red when a display alarm message is active. An alarm message has a higher priority and thus overrides the basic display and the superposed function. After deactivation of the alarm signalling, all LEDs will immediately return to the state corresponding to their configuration and communication objects.
- i** During colour configuration it must be ensured that different colours are configured for the basic display and the superposed function. If this is not done (the colours are the same), then when the display is static it is not possible to determine which display function is being indicated.

- i** When the superposed function is activated via a 1-bit object it is possible to have the status LED flash in the superposed colour. During flashing the status LED switches cyclically between the "switched-on" and "switched-off" states. No colour change is performed between the regular colour and the superposed colour.
- i** The configuration of user-defined colours of the status LED and the superimposed functions is only possible in the described manner when the 3-colour individual control is not parameterised . (see page 193).

3-colour individual control with separate communication objects

Each status LED can visualise statuses completely separately from the buttons, using three separate communication objects. In this case, a 1-bit object can be configured in the ETS for each colour, whereby each status LED can be statically switched on or off via the received object value, or also activated as flashing. At the same time, the colour of the LED is predefined by the actuated object.

The colour, in which the LED should light up, depends on which of the three objects of the LED concerned last receives a value. If two or all of the three objects of a LED are associated with a group address, no receiving sequence is recognisable. In this case, it is stipulated that the sequence green -> blue -> red then applies.

For a 3-colour individual control, the telegram polarity of the LED control can be configured on the parameter page of a status LED as follows:

- 1 = LED static ON / 0 = LED static OFF
- 1 = LED static OFF / 0 = LED static ON
- 1 = LED flashes / 0 = LED static OFF
- 1 = LED static OFF / 0 = LED flashes

- i** A flashing LED always changes between the active colour and the OFF state. Flashing between several colours, e.g. red and green, is not possible.
- i** The configuration of the 3-colour individual control as described is only possible when no user-defined colour configuration has been parameterised (see page 191).

4.2.4.7.2 Standard display function

The room controller display compact module can be configured and put into operation without a great deal of project design work using a standard operating and display function.

This function can be switched on or off using the parameter "Standard display function (TSM)" on the parameter page "Configuration TSM".

When the standard display function is switched on, the status LEDs of the device optionally execute the following functions:

- The left or right row of status LEDs continuously visualise the current setpoint shift of a controller.
- All 8 status LEDs visualise the fan level of a controller temporarily after a fan level adjustment.

Both functions of the status display function can be enabled together. The enabled standard display function can be adjusted on the "Standard display function" parameter page according to the user's requirements.

- i** The precondition for a functioning standard display function is the project design of the room temperature controller and the configuration of the TSM.
- i** If the standard display function is activated, the following parameters are permanently set: "Function and colour of all status LEDs = User-defined ..." and "Colour of all status LEDs = Colour selection per status LED".

Predefined status LED functions

With the enabled standard display function of the compact room controller module, the LED functions of the basic module are optionally predefined. The standard display function contains the display of the setpoint shift and the temporary fan level display via the status LED.

- i** The status LEDs are internally connected to the controller. No group addresses need be assigned.

Standard display function: Setpoint shift

In the ETS, the parameter "Side of LED row setpoint shift" defines whether the device shows the status of the current setpoint shift using four status LEDs. The parameter also defines the side of the device upon which the current setpoint shift is shown. The device either shows the current setpoint shift on the right-hand side (status LEDs 2, 4, 6 and 8) or on the left-hand side of the device (status LEDs 1, 3, 5 and 7). A positive adjustment is represented by a red illuminated status LED and a negative adjustment by a blue status LED. The status LEDs of the selected side are permanently set to the visualisation of the setpoint shift and cannot be changed further on the parameter pages of the status LED. By contrast, the status LEDs of the unselected side can be designed freely when the standard display function is active.

The parameter "Setpoint shift display" on the "Configuration TSM" parameter page determines whether the standard display function setpoint shift is displayed in two (figure 75) or 4 steps (figure 73).

Furthermore, the state of the selected status LED row can be configured in case the setpoint is not shifted (figure 76).

Setpoint shifting display: 4 steps in each direction

With the "4 steps per direction" display, all four right status LEDs of the selected side are allocated to the respective current state of the negative or positive adjustment. All four status LEDs display the current setpoint shift depending on the configured increment. The display of the negative adjustment starts at the top and builds up (with steadily increasing adjustment) downwards. The positive adjustment starts at the top and builds up (with steadily increasing adjustment) downwards.

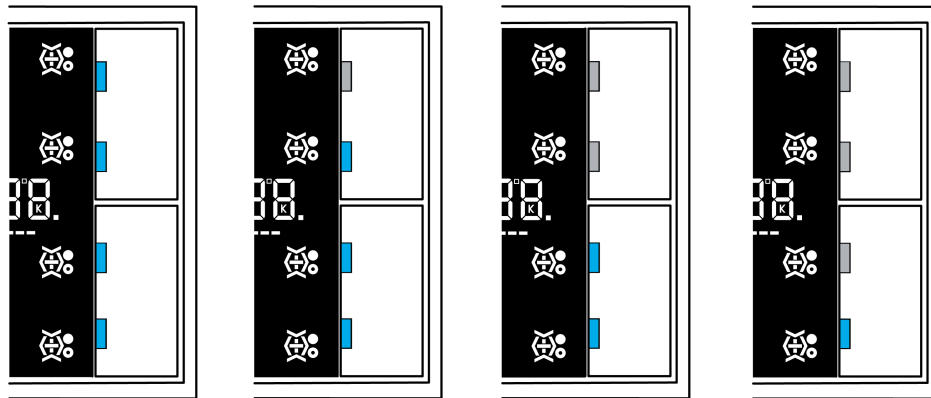

Figure 73: Standard display function: negative setpoint shift "4 steps"

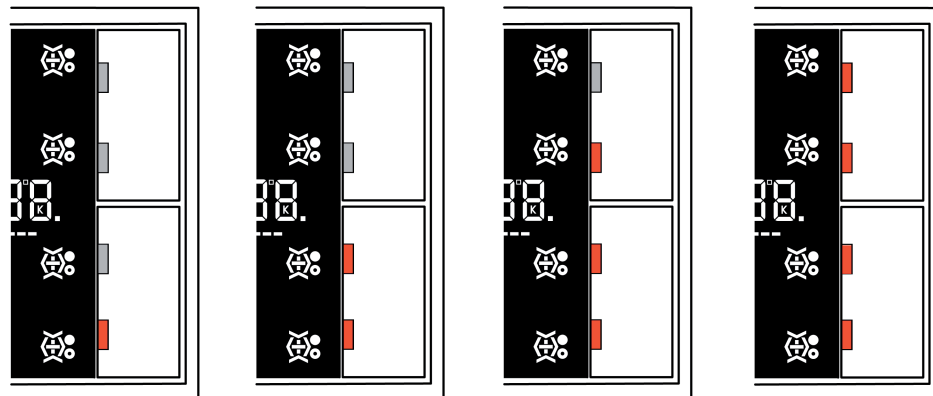

Figure 74: Standard display function: positive setpoint shift "4 steps"

Setpoint shifting display: 2 steps in each direction

With the "2 steps" display, the two upper status LEDs (status LEDs 2 and 4 or 1 and 3) of are allocated to the positive adjustment and the two lower right status LEDs (status LEDs 6 and 8 or 5 and 7) are allocated to the negative adjustment. The current setpoint shift is displayed with the two corresponding status LEDs depending on the configured increment. The display of the negative and positive adjustment starts in the centre of the device and builds up (with steadily

increasing adjustment) from the centre outwards, depending on the direction of the adjustment.

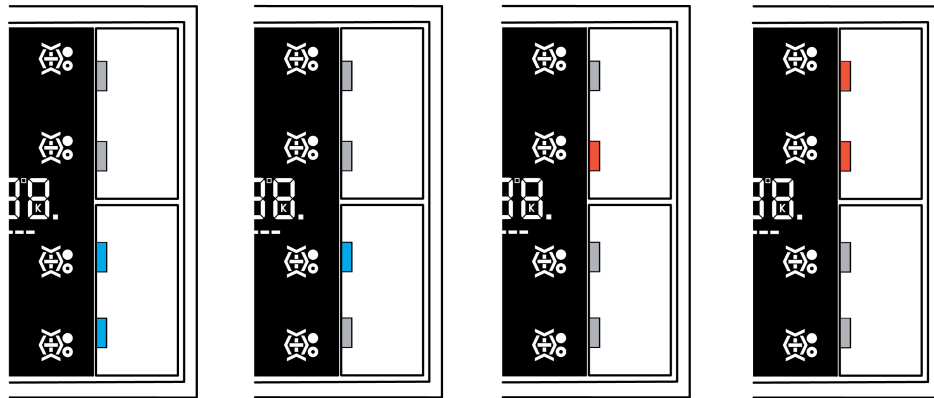

Figure 75: Standard display function: setpoint shift display "2 steps"

Setpoint shift display: No adjustment

During the standard display function, various types of display for displaying the state of the setpoint shift = 0, i.e. no adjustment, can be configured.

Configurable display forms for "No adjustment" are:

- Standard (no status LED lights up)
- 1 LED green (status LEDs 4 and 6 light up green)
- 2 LEDs green (status LED 6 lights up green)
- 4 LEDs green (status LEDs 2, 4, 6 and 8 light up green)

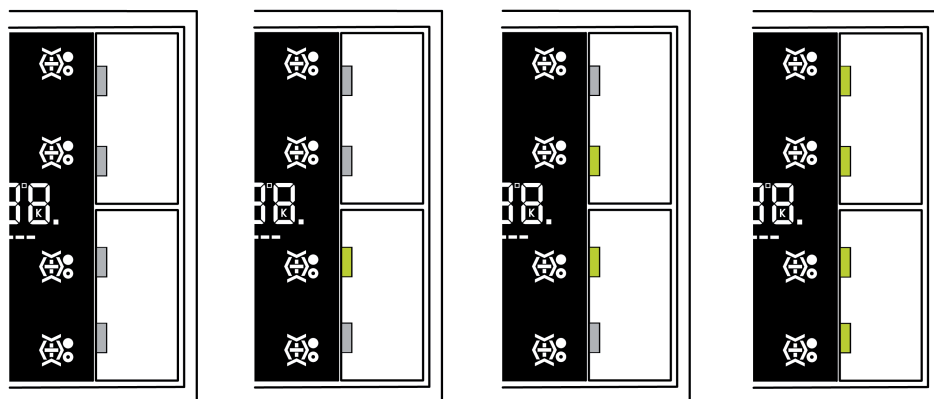

Figure 76: Standard display function: Setpoint value shift display "No adjustment"

- i** If the standard display function is enabled, the status LEDs of the selected side cannot be changed and are permanently assigned to the setpoint shift.

Standard display funktion: temporary fan level display

One function to be regarded as an extension of the LED function "Fan controller display" is the "Temporary fan level display". The temporary fan level display can be used if the following settings have been configured thus:

- Fan controller available: Yes
- Standard display function: Yes
- Function of a button: Controller operation
- Function of the button: Fan controller
- Function of the fan controller when pressing the button: Manual control
- Function of a status LED associated with the button: Fan controller display

The temporary fan level display is displayed in combination with all 8 status LEDs of the device for the light period of the button-press display. The current fan level is always displayed in blue and takes place in clockwise direction, beginning with status LED 7 (bottom left) via status LED 5, status LED 3, status LED 1, status LED 2, status LED 4 and status LED 6 until status LED 8.

Fan level	Status LED	Switching state
0	7, 5, 3, 1, 2, 4, 6, 8	OFF
1	7	ON
2	7, 5	ON
3	7, 5, 3	ON
4	7, 5, 3, 1	ON
5	7, 5, 3, 1, 2	ON
6	7, 5, 3, 1, 2, 4	ON
7	7, 5, 3, 1, 2, 4, 6	ON
8	7, 5, 3, 1, 2, 4, 6, 8	ON

Temporary fan level display: Status LED of switching states

- i** No remaining LED functions (except for alarm message) are executed for the duration of the temporary fan level display. Once the duration of the button-press display has elapsed, all status LEDs reassume their regular state.

4.2.4.8 Scene function

The room controller display compact module can be used in two different ways as part of a scene control system...

- Each rocker or button can work as a scene extension. This feature makes it possible to recall or to store scenes which may be stored in other devices (see chapter 4.2.4.6.5. Scene extension function).
- The TSM can independently store up to eight scenes with eight actuator groups. These internal scenes can be recalled or stored by the rockers or buttons (internal scene recall) and also by the communication object "scene extension".
In the following subsections the internal scene function will be dealt with in greater detail.

Scene definition and scene recall

If the internal scenes are to be used, the parameter "Scene function" on parameter page "Scenes" must be set to "Yes". The matching data types for the eight scene outputs must then be selected and adapted to the actuator groups used. The types "Switching", "Value (0 ... 255)" or "Value / blind position (0 ... 100 %)" can be selected. The data type "Scene extension" makes it possible to implement dynamic processes by linking scenes temporally, e.g. for the lighting control in a display window.

As a rule, Venetian blinds are controlled via two scene outputs. One output controls the blind height and the other one adjusts the slat position.

The ETS offers the communication objects and the parameters of the scene commands appropriate for these data types on the following parameter pages "Scene 1" to "Scene 8".

It is possible that the values for the individual scenes preset by the parameters are modified later on with the storage function when the system is (see chapter 4.2.4.8. Scene function) in operation. If the application program is then loaded again with the ETS, these locally adapted values will normally be overwritten by the parameters. Due to the fact that it may take considerable efforts to readjust the values for all scenes in the system, the parameter "Overwrite scene values during ETS download ?" offers the possibility of retaining the scene values stored in operation without overwriting them.

The scene parameters can be set on the parameter page of each individual scene output ("Scene output 1 ... 8"). The setting options are the same for all 8 scenes.

These internal scenes can be recalled directly via the rockers or buttons (function "recall internal scene") and also by another KNX device via the "Extension input" communication object. This 1-byte communication object supports the evaluation of up to 64 scene numbers. For this reason it must be specified which of the external scene numbers (1 ... 64) is to recall the internal scene (1 ... 8). If the same scene number is listed for several internal scenes, it is always only the first of these scenes that will be activated (scene with the lowest scene number).

In some situations there may be the requirement that a group of actuators is not controlled by all, but only by certain scenes. A classroom, for instance, may require open blinds for the "Welcome" and "Break" scenes, closed blinds in the "PC presentation" scene and no change in the "Discussion" scene. In this example, the parameter "Permit transmission ?" can be set to "No" for the "Discussion" scene. The scene output is then deactivated during the corresponding scene.

The parameter "Transmit delay" permits entering an individual waiting time for each scene output. This transmit delay can be used in different situations...

- When the actuators participating in a scene transmit status messages automatically or when several scene buttons are used to increase the number of channels within the scenes, the recall of a scene may result for a short time in high bus loading. The transmit delay helps to reduce the bus load at the time of scene recall.
- Sometimes, it is desirable that an action is started only after another action has ended. This can be for instance the illumination which is to shut off only after the blinds/shutters have been raised.

The transmit delay can be set separately for each scene output. The transmit delay defines the time delay between the individual telegrams during a scene recall. Amongst other things, this specifies the time that must elapse after recalling a scene (e.g. via "Extension input" object) until the KNX telegram for scene output 1 is transmitted. After the transmission of the KNX telegram for scene output 1, the configured transmission delay of scene output 2 elapses before the KNX telegram for scene output 2 is transmitted, etc. The transmission delay for the KNX telegram of scene output 1 starts to elapse immediately after the recall of the scene (figure 77).

The transmit delay between telegrams can also be deactivated (setting "0"). The telegrams are then transmitted at the shortest possible time interval. In this case, however, the order of the telegrams transmitted can deviate from the numbering of the scene outputs.

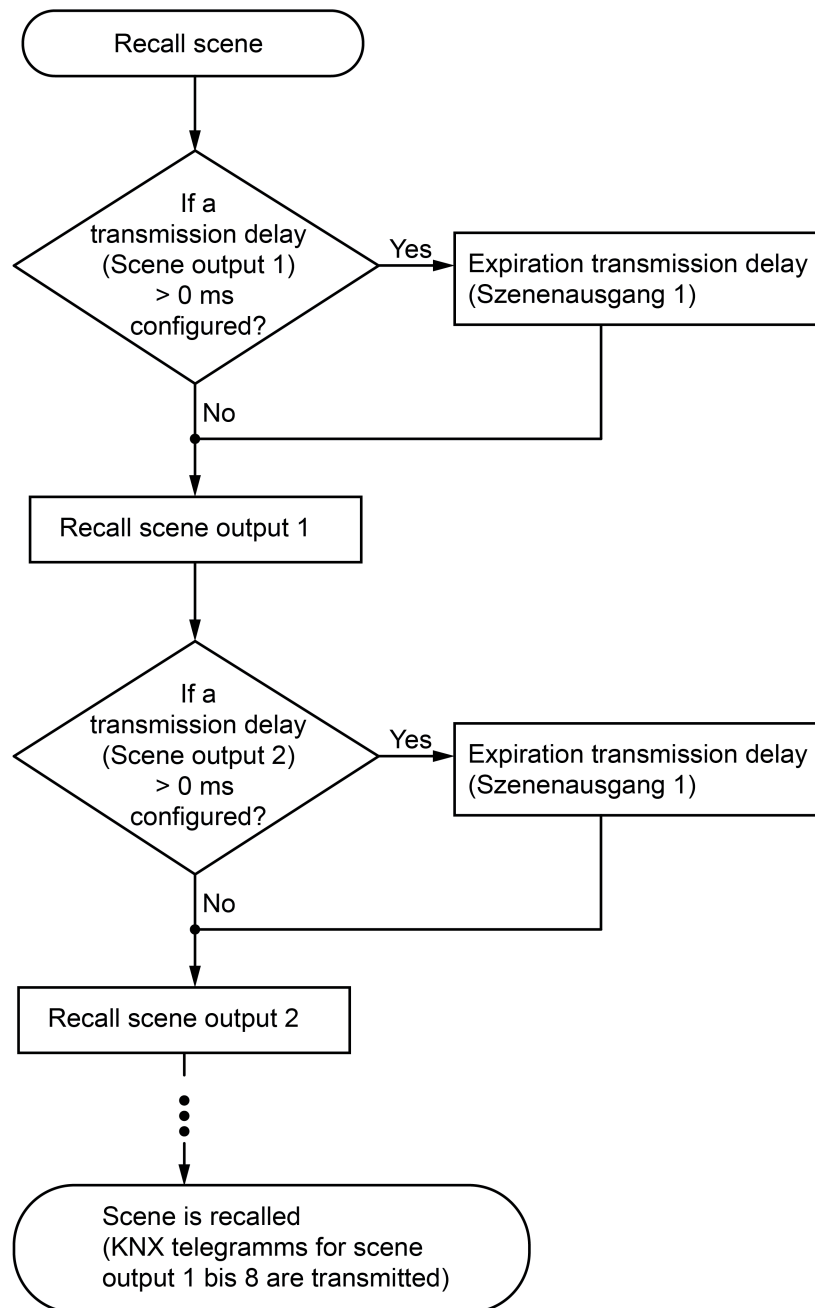

Figure 77: Flow chart for the transmission delay of scene output

When a new scene recall (also with the same scene number) occurs during a current scene recall - even in consideration of the pertaining transmit delays - the scene processing started first will be aborted and the newly received scene number will be processed. A running scene is also aborted when a scene is being stored!

During a scene recall - even if delayed - the control surfaces of the push button sensor are operational.

Dynamic light control with light scenes

With the help of a temporal linking of scenes, it is possible to implement dynamic processes, which can be put to good use e.g. for display window lighting, guidance signs or other applications. The data type "Scene extension", which can recursively call up other light scenes,

serves this purpose. The precondition is that the scene output defined last is configured as "Scene extension" and connected with the object "Scenes - extension input" via a group address.

Examples:

- A scene calls itself up recursively, by giving the value of the scene output configured as scene extension its own scene number. The practical connection with time delays between the individual scene outputs, as needed with additional timing functions in the actuators, results in an endless loop of always the same sequence. The process ends when an internal light scene that is not in use is called up.
- Cascading scenes: the scene output configured as scene extension calls up a subsequent scene. The process ends automatically after the last scene has been called up and been executed.
- Endless loop: several scenes call each other up successively in a cascade. When the scene defined as last in the sequence calls up the first scene, an endless sequence results. The process is ended when a scene not used in the sequence is called up.

Storing scenes

For each output of a scene, the user can define a corresponding scene value in the ETS which is then transmitted to the bus during a scene recall. During the ongoing operation of the system, it may be necessary to adapt these preset values and to save the adapted values in the basic module of the device. This can be ensured by the storage function of the scene control.

The value storage function for the corresponding scene number is enabled with the parameter "Permit storing ?" ("Yes") or disabled ("No"). When the storage function is disabled, the object value of the corresponding output is not sampled during storage.

A scene storage process can be initiated in two different ways...

- by a long press on a rocker or button of a control surface configured as "scene extension"
- by a storage telegram to the extension object.

During a storage process, the push-button sensor reads the current object values of the connected actuators. This is carried out by means of eight read telegrams (ValueRead) addressed to the devices in the scene which return their own value (ValueResponse) as a reaction to the request. The returned values are received by the push-button sensor and taken over permanently into the scene memory. Per scene output, the push-button sensor waits one second for a response. If no answer is received during this time, the value for this scene output remains unchanged and the push-button sensor scans the next output.

In order to enable the push-button sensor to read the object value of the actuator addressed when a scene is stored, the read flag of the corresponding actuator object must be set. This should be done only for one actuator out of an actuator group so that the value response is unequivocal.

The stored values overwrite those programmed into the push-button sensor with the ETS.

The storage process will always be executed completely by the push-button sensor and cannot be aborted before it has ended. Recalling scenes in the course of a storage process is not possible, the control surfaces of the push-button sensor remaining nevertheless operational.

4.2.4.9 Disabling function

Configuration

With the 1-bit communication object "Disable buttons", the control surfaces on the TSM and TSEM can be partly or completely disabled. During a disable, the rockers or buttons cannot execute any functions or can execute, temporarily, another function.

An active disable applies only to the functions of the rockers or buttons. The functions of the status LED, the scene function, temperature measurement and the alarm signalling are not affected by the disabling function.

The disabling function and the pertaining parameters and communication objects are enabled if the parameter "Disabling function ?" is set to "Yes" on the "Disabling" parameter tab.

You can parameterize the polarity of the disabling object. In case of polarity inversion (disabled = 0 / enabled = 1), the disabling function is not activated immediately after a reset or after ETS programming (object value = "0"). There must first be an object update "0" until the disabling function will be activated.

Telegram updates from "0" to "0" or from "1" to "1" on the "button disabling" object remain without effect.

The disabling function can be selected to include all or only some buttons of the basic and extension modules. If not all buttons should be blocked with the disabling function, set the parameter "Assignment of the buttons for disabling function" to "Individual buttons assigned". In this case, an additional parameter page "Disabling - button selection" is shown. For each potentially possible button (basic and extension modules), a selection can be made on this page as to whether it should correspondingly change its performance when disabling is activated (set parameter "Button..." to "Yes") or continue to execute its standard function (set parameter "Button..." to "No").

Defining the disabling function

- On parameter page "Disabling", set the parameter "Disabling function?" to "Yes".
The communication objects "Disabling function 1...", "Disabling function 2..." and "Disable buttons - disable" are shown, as are additional parameters and parameter pages.
- Specify the polarity of the disabling object.
- Select those buttons, which should be affected by the disabling function, with the parameter "Assignment of the buttons for disabling function" and, as needed, with the parameters on the page "Button selection".

Configuring the reaction at the beginning and end of a disable

If the disabling function is used, the reaction of the pushbutton sensor on activation and deactivation of the disabling function can be set separately in the parameterisation (parameter "Reaction of pushbutton sensor at the beginning / end of disabling"). In this connection it is irrelevant which of the control surfaces is influenced and possibly also locked by disabling. The push-button sensor always shows the configured behaviour.

The disabling function must have been enabled in advance.

- Set the parameter "Reaction of pushbutton sensor at the beginning / end of disabling" to "No reaction".
The push-button sensor (TSM + TSEM) shows no reaction at the beginning and at the end of disabling. The sensor only adopts the state as provided for by the "Behaviour during active disabling".
- Set the parameter "Reaction of pushbutton sensor at the beginning / end of disabling" to "Internal scene recall scene 1 ...8".
The push-button sensor (TSM + TSEM) recalls one of the up to 8 internal scenes. Scene storage is not possible.
- Set the parameter "Reaction of pushbutton sensor at the beginning / end of disabling" to "Reaction as button >> X << / >> Y << when pressed / released".

The device (TSM + TSEM) executes the function assigned to any "target button" in non-disabled state. Target buttons are operating buttons of the pushbutton sensor on the basic device as well as on the extension module, which may be configured for rocker or for button operation. The target buttons are parameterized separately for the beginning (X) of for the end (Y) of disabling (button X / Y: button 1 to max. button 16). For this purpose, the two buttons of a rocker are considered as two separate buttons.

The action configured for the respective target button is executed. If the target button is configured in such a way that it has no function or does not transmit a telegram on pressing or releasing of the button, or a module button is configured without an extension module being connected to the basic device, then there is also no reaction to disabling or to re-enabling. If the selected target button is part of a configured rocker, the behaviour preset for the respective rocker side will be used. The telegrams are transmitted to the bus via the required communication object of the target button.

The following table shows all possible telegram reactions of the pushbutton sensor with respect to the target button function.

Function of >>target button<<	Reaction "as >>target button<< on pressing"	Reaction "as >>target button<< on releasing"
Switching / toggling	Switching telegram	Switching telegram
Dimming	Switching telegram	No telegram
Venetian blind	Move telegram	No telegram
Scene extension	Scene recall telegram	No telegram
1-byte value transmitter	Value telegram	No telegram
2-byte value transmitter	Value telegram	No telegram
Temperature value transmitter	Temperature value telegram	No telegram
Brightness value transmitter	Brightness value telegram	No telegram
2-channel operation Channel 1: 1-bit object type	Switching telegram	No telegram
2-channel operation Channel 1: 1-byte object type	Value telegram	No telegram
2-channel operation Channel 1: 2-byte object type	Temperature value telegram	No telegram
Controller extension Operating mode switchover	Operating mode telegram	No telegram
Controller extension Motion detection	Presence telegram	No telegram
Controller extension Setpoint shift	Level value telegram	No telegram
Controller operation Operating mode switchover	Operating mode telegram	No telegram

Controller operation Motion detection	Presence telegram	No telegram
Controller operation Setpoint shift	Level value telegram	No telegram
Controller operation Fan controller	Fan level telegram	No telegram
No function	No telegram	No telegram

Telegram reactions of the pushbutton sensor with respect to the target push-button function

- Set the parameter "Reaction of pushbutton sensor at the beginning / end of disabling" to "Reaction as disabling function 1 / 2 when pressed / released".

The device (TSM + TSEM) executes the function assigned to either of the two "virtual" disabling functions. The disabling functions are internal button functions with independent communication objects and independent parameters. Except for the status LED, the setting possibilities available for disabling function 1 and disabling function 2 are the same as for the buttons.

The respective configuration of the predefined disabling function will be executed. If no function or no telegram is configuration in the disabling function on pressing or releasing of a button, then there is also no reaction to disabling or to re-enabling.

Also, for this setting, Table 1 shows all possible telegram reactions of the push/button sensor depending on the project design of the disabling function.

The telegrams are transmitted to the bus via the required communication object of the disabling function.

Configuring the reaction during a disable

Irrespective of the behaviour shown by the push-button sensor at the beginning or at the end of disabling, the control buttons can be separately influenced during disabling.

The disabling function must have been enabled in advance.

- Set the parameter "Behaviour during active disabling" to "all buttons without function".

The device is then completely disabled during disabling. Pressing a button has no effect. The status LEDs of the disabled buttons are without function (no button-press display either). Only the "Always ON" or "Always OFF" state remains unaffected by the disabling function.
- Set the parameter "Behaviour during active disabling" to "all buttons behave like". Also, set the parameters "All buttons with even / odd numbers behave during disabling like" to the desired button number, module button number or disabling function.

All buttons behave as defined in the parameters for the two specified reference buttons of the pushbutton sensor. For all control buttons with an even number (2, 4, 6, ...) and for all buttons with an odd number (1, 3, 5, ...) it is possible to program not only different reference buttons, but also identical reference buttons. The two "virtual" disabling functions of the push button sensor can also be configured as a reference button.

The telegrams are transmitted to the bus via the communication objects of the specified reference buttons. The status LEDs of the reference buttons are controlled according to their function. The status LEDs of the disabled buttons are without function (no button-press display either). Only the "Always ON" or "Always OFF" state remains unaffected by the disabling function.
- Set the parameter "Behaviour during active disabling" to "Individual buttons without function". The buttons that will be disabled are defined on the parameter page "Disable - Button selection" page.

Only the individually specified buttons are locked during disabling. The other control buttons remain unaffected by disabling. The status LEDs of the disabled buttons are without function (no button-press display either). Only the "Always ON" or "Always OFF" state remains unaffected by the disabling function.

- Set the parameter "Behaviour during active disabling" to "Individual buttons behave like". The buttons that will be disabled are defined on the parameter page "Disable - Button selection" page. Continue to configure the parameters "All assigned left / right buttons behave like" to the required button number, module button number or disabling function.

Only the individually specified buttons behave as defined in the parameters of the two specified reference buttons of the pushbutton sensor. Different or identical reference buttons can also be configured for all the right (2, 4, 6, ...) and all the left buttons (1, 3, 5, ...). The two "virtual" disabling functions of the push button sensor can also be configured as a reference button. The buttons that will be disabled are defined in the parameters on the "Disable - buttons selection" page.

The telegrams are transmitted to the bus via the communication objects of the specified reference buttons. The status LEDs of the reference buttons are controlled according to their function. The status LEDs of the disabled buttons are without function (no button-press display either). Only the "Always ON" or "Always OFF" state remains unaffected by the disabling function.

- ❗ If a button evaluation is taking place at the time of activation / deactivation of a disabling function, this function is aborted immediately and with it also the pertaining button function. It is first necessary to release all buttons before a new button function can be executed if so permitted by the state of disabling.

4.2.4.10 Alarm signal

The device permits signalling of a alarm which might be, for instance, a burglar or a fire alarm from a KNX central alarm unit. The alarm is signalled by synchronous flashing of all the status LEDs of the compact room controller module. This alarm signal can be enabled separately with the parameter "Alarm message display" on the parameter page "Alarm".

When alarm signalling is enabled, the ETS displays the communication object "TSM/TSEM.Alarm message" and further alarm message parameters.

The communication object "Alarm message" is used as an input for activating or deactivating the alarm message. The polarity of the object can be selected. When the object value corresponds to the "Alarm" condition, all the status LEDs flash at a frequency of approx. 2 Hz. If there is an alarm, the actual configurations of the status LED have no significance. The status LEDs adopt their originally configured behaviour only after the alarm message has been deactivated. Changes of the state of the status LEDs during an alarm - if they are controlled by separate LED objects or if they signal push-button functions - are internally stored and recovered on deactivation of the alarm.

Apart from the possibility of deactivating an alarm message via the alarm object, it can also be deactivated locally by a button-press on the TSM itself. The "Reset alarm signalling by a button actuation?" parameter defines the button response during an alarm:

- If this parameter is set to "Yes", an active alarm can be deactivated by a button-press on the TSM. This button function does not cause the configured function of the pressed button to be executed. Only after then next button-press will the configuration of the button be evaluated and a telegram be transmitted to the bus, if applicable.
- If "No" has been selected, an alarm can only be deactivated via the alarm signalling object. A button function will always directly execute the configured button function.

If an alarm can be deactivated by pressing any button, the parameter "Use alarm acknowledge object?" defines whether an additional telegram for acknowledging the alarm is to be transmitted to the bus via the separate object "Acknowledge alarm message".

Such an acknowledge telegram can, for instance, be sent via a 'listening' group address to the "Alarm signalling" objects of other push button sensors in order to reset the alarm status there as well. Attention must be paid during resetting of an alarm to the selectable polarity of the acknowledge object.

- i** Notes on the polarity of the alarm object: If the setting is "Alarm when OFF and alarm reset when ON", the alarm object must be actively written by the bus with "0" to activate the alarm after a reset or after programming with the ETS.
- i** An active alarm signalling is not stored so that the alarm signalling is generally deactivated after a reset or after programming with the ETS.

4.2.4.11 Delivery state

The delivery state defines the functions of the device when it is connected to the KNX but has not been programmed with application data by the ETS.

This condition persists until the application is programmed into the device.

The text NEU appears in the device display, as soon as the device is supplied with bus voltage and no button has been pressed. In the delivery state, the device makes four displays available, which are switched through by pressing button 1. Changing the display also changes the display brightness. The information is shown in the following order in the display of the TSM:

- NEU / Display brightness: 100 %
- Actual temperature (TSM) / Display brightness: 20 %
- Actual temperature (remote sensor) / Display brightness: 20 %
- Segment test / Display brightness: 100 %

The first actuation of button 1 causes the display to switch to the actual temperature measured by the TSM, which is shown in °C. When button 1 is pressed again, the actual temperature measured by the remote sensor is shown, providing that a remote sensor is connected to the TSM. After the third button-press of button 1, all the available segments in the display are activated. This segment test provides the installation engineer with an overview of the designable display information and button icons at a display brightness of 100%. The next time a button is pressed, the display begins again with the NEU text.

In the delivery state of this device, the eight status LEDs execute the function of an actuation display. In so doing, the status LEDs light up for the length of the actuation of the corresponding button. The colour of the status LED changes in the following order with each press of a button:

- Red
- Green
- Blue

Using the top two status LEDs 1 and 2, the device can also indicate that an application which cannot run has been programmed into its memory by the ETS. The status LEDs 1 and 2 then change colour between red, blue and off at a frequency of around 0.75 Hz. Applications cannot run if they are not intended for use with the device in the ETS product database.

The top two status LEDs flash even if the TSM application program has been removed by the ETS.

In both cases, the room controller display compact module is not operational.

4.2.5 Parameters

4.2.5.1 Parameter group "General"

Description	Values	Comment
<p><input type="checkbox"/> General</p> <p>No parameters are shown on this parameter page. The "Basic settings" parameter page is subordinate to the "General" parameter page.</p>		
<p><input type="checkbox"/> Basic settings</p> <p>The "Menu level" parameter page is subordinate to the "Basic settings" parameter page.</p>		
Transmit delay after reset or bus voltage return	<p>Yes</p> <p>No</p>	<p>After a reset (e.g. after loading of an application program or the physical address or after return of bus voltage), the push-button sensor can automatically transmit telegrams for the room temperature controller extension functions. In case of the controller extension, the push-button sensor attempts to retrieve values from the room temperature controller by means of read telegrams in order to update the object states. In case of the room temperature measurement, the push-button sensor transmits the current room temperature after a reset to the bus. If there are still other bus devices besides the push-button sensor transmitting telegrams immediately after a reset, it may be useful to activate the transmit delay for automatically transmitting objects in order to reduce the bus load.</p> <p>When transmit delay is activated (setting: "Yes"), the push-button sensor computes the time delay from its device ID in the physical address. The sensor then waits 30 seconds maximum before transmitting telegrams.</p>
Push-button sensor module (TSM / basic unit)	<p>4-gang</p> <p>2-gang</p>	<p>This parameter adjusts the database to the device being used. The compact room controller module is available in the 2-gang and 4-gang variants.</p>
Extension module (TSEM) connected?	<p>Yes</p> <p>No</p>	<p>If a push-button sensor extension module is connected to the basic device, it must be enabled at this point. An extension module must only be enabled if an extension module is actually connected to the basic device.</p>

Type of TSEM	1-gang 2-gang 3-gang 4-gang Room controller extension module	The type of the connected pushbutton sensor extension module is specified. The associated communication objects and parameter groups in the ETS are shown corresponding to this setting.
Time display	24 hours 12 hours	The time can be displayed in the 24h or 12h time format. In the 12h time format, the display does not allow any distinction between a.m. and p.m.
Request time	Yes No	The device possesses an internal clock, set using a communication object. The internal calculation of the current time is primarily influenced by the scope of the internally planned functions and the resulting data traffic. This may cause particularly large time deviations. For this reason, the internal clock should be synchronised on a regular basis. The device will consider the internal time invalid for as long as no time telegram is received after a device reset, or if there has been no update for a day. In this case, an optional automatic time poll can take place. For this, the automatic time poll can be activated using the "Yes" setting here. In so doing, if the time information is invalid, the device will request the time once only by sending a read telegram to the bus. The read request should be confirmed by another bus subscriber using an answer telegram.
Request time with	Switching telegram value '1' Switching telegram value '0'	In order to request the time, the telegram polarity of the request telegram can be configured here.
Temperature display	Display of temperature values in °C Display of temperature values in °F	The display can show temperature values in the formats °C and °F. This parameter decides in which format temperature values are shown on the display. Room temperature control and room temperature measurement always takes place with temperature values in the °C format. The compact room controller module converts the received temperature values into °F, if °F values are to be displayed.

Menu level	Disabled Enabled	The menu level makes it possible to make various basic settings on the unit locally without using the ETS. In order to avoid the unintentional disruption of essential functions, access to the menu level can be prevented by setting this parameter to "disabled". The setting "enabled" allows access to the menu level. Then, the "Menu level" is shown in the ETS with additional parameters. If the menu level is enabled, full-surface operation of the TSM rocker 1 is not possible.
------------	--------------------------------	--

☐ Menu level

The parameter pages "Submenu controller 1", "Submenu controller 2" and "Display settings" are subordinate to the parameter page "Menu level".

Automatically exit menu level	Yes No	This parameter can be used to configure the automatic exiting of the menu level. In the "Yes" setting, the device leaves the menu level when no additional operation takes place after the last push-button operation within the "Time until automatic menu level exit" configured in the ETS. With "No", the menu level remains active until it is exited manually with the button combination or using the menu entries "OK" or "ESC".
-------------------------------	----------------------	--

Time until automatic menu level exit	10 sec 20 sec 30 sec 1 min 2 min	This parameter specifies the time until automatic exiting of the menu level after no more buttons are pressed. This parameter is only visible if the parameter "Automatic menu level exit" is set to "Yes".
--------------------------------------	---	---

Save changes after automatic exiting	Yes No	For automatic exiting of the menu level, this parameter can be used to define whether the settings are saved or not.
--------------------------------------	------------------	--

Save changes after manual exiting	Yes No	This parameter defines whether the settings are saved or not when the menu level is exited using the button combination.
-----------------------------------	------------------	--

First menu item in menu level	Time Actual temperature via object Setpoint temperature via object Outdoor temperature via object Any temperature 1	The menu entry that is shown as the first entry when the menu level is called up can be selected using this parameter. The sequence of the subsequent entries is fixed as shown in the parameter structure. The following parameter is displayed according to this parameter. The first menu item in the menu level
-------------------------------	---	---

	<p>Any temperature 2 Any temperature 3 Submenu Controller 1 Submenu Controller 2 Display settings</p>	cannot be hidden.
Time	<p>Hidden Visible</p>	The current time can optionally be displayed in the menu level ("Visible" setting). With the setting "Hidden", the time is not displayed in the menu level. This can then be configured only if needed in the basic display ("Display" parameter node).
Actual temperature via object	<p>Hidden Visible</p>	The actual temperature (room temperature) can optionally be displayed in the menu level ("Visible" setting). With the setting "Hidden", the actual temperature is not displayed in the menu level. This can then be configured only if needed in the basic display ("Display" parameter node).
Setpoint temperature via object	<p>Hidden Visible</p>	The setpoint temperature can optionally be displayed in the menu level ("Visible" setting). With the setting "Hidden", the setpoint temperature is not displayed in the menu level. This can then be configured only if needed in the basic display ("Display" parameter node).
Outdoor temperature via object	<p>Hidden Visible</p>	The outdoor temperature can optionally be displayed in the menu level ("Visible" setting). With the setting "Hidden", the outdoor temperature is not displayed in the menu level. This can then be configured only if needed in the basic display ("Display" parameter node).
Any temperature 1	<p>Hidden Visible</p>	Any temperature 1 received via an object can optionally be displayed in the menu level ("Visible" setting). With the setting "Hidden", any temperature 1 is not displayed in the menu level. This can then be configured only if needed in the basic display ("Display" parameter node).
Any temperature 2	<p>Hidden Visible</p>	Any temperature 2 received via an object can optionally be displayed in the menu level ("Visible" setting). With the setting "Hidden", any temperature 2 is

		not displayed in the menu level. This can then be configured only if needed in the basic display ("Display" parameter node).
Any temperature 3	Hidden Visible	Any temperature 3 received via an object can optionally be displayed in the menu level ("Visible" setting). With the setting "Hidden", any temperature 3 is not displayed in the menu level. This can then be configured only if needed in the basic display ("Display" parameter node).
Submenu Controller 1	Hidden Visible	This parameter specifies whether the settings of the first controller are displayed in the menu level ("Visible" setting). The settings of the first controller are the basic setpoint and the setpoint temperatures for Standby and Night mode for heating and cooling. Whether these temperature values are not just displayed, but can also be changed, is specified by additional parameters in the parameter node "General -> Basic settings -> Menu level -> Submenu controller 1". With the setting "Hidden" the setpoint temperatures of the controller are not shown in the menu level, and thus cannot be changed, either. This parameter has no effect in a controller extension.
Submenu Controller 2	Hidden Visible	This parameter specifies whether the settings of the first controller are displayed in the menu level ("Visible" setting). The settings of the first controller are the basic setpoint and the setpoint temperatures for Standby and Night mode for heating and cooling. Whether these temperature values are not just displayed, but can also be changed, is specified by additional parameters in the parameter node "General -> Basic settings -> Menu level -> Submenu controller 2". With the setting "Hidden" the setpoint temperatures of the controller are not shown in the menu level, and thus cannot be changed, either. This parameter has no effect in a controller extension.

Display settings

Hidden

Visible

This parameter specifies whether the settings of the display are shown in the "Menu level" parameter node ("Visible" setting). The parameters "Brightness" and "Pixel test" in the parameter node "General -> Basic settings -> Menu level -> Display settings" become available. In the "Hidden" setting, the "Display settings" parameter page is hidden. Accordingly, it is not possible to display or change the display brightness in the menu level. The pixel test is also not possible in this setting.

☐ Submenu Controller 1 / Submenu Controller 2

Basic temperature

Hidden

Visible

Visible and changeable

This temperature specifies for Controller 1 and Controller 2 whether the basic temperature can be changed in the submenu of the menu level (setting "Visible and changeable") or whether it should only be visible ("Visible" setting). With the setting "Hidden", the basic temperature is not displayed in the submenu and cannot be set. This parameter has no effect in a controller extension.

Setpoint temperature,
standby heating

Hidden

Visible

Visible and changeable

This temperature specifies for Controller 1 and Controller 2 whether the setpoint temperature for the Standby operating mode in the Heating operating mode can be changed in the submenu of the menu level (setting "Visible and changeable") or whether it should only be visible ("Visible" setting). With the setting "Hidden", the setpoint temperature is not displayed in the submenu and cannot be set. This parameter has no effect in a controller extension.

Setpoint temperature,
standby cooling

Hidden

Visible

Visible and changeable

This temperature specifies for Controller 1 and Controller 2 whether the setpoint temperature for the Standby operating mode in the Cooling operating mode can be changed in the submenu of the menu level (setting "Visible and changeable") or whether it should only be visible ("Visible" setting). With the setting "Hidden", the setpoint temperature is not displayed in the submenu and cannot be set. This parameter has no effect in a controller extension.

Setpoint temp. night mode heating	Hidden Visible Visible and changeable	This temperature specifies for Controller 1 and Controller 2 whether the setpoint temperature for the Night operation operating mode in the Heating operating mode can be changed in the submenu of the menu level (setting "Visible and changeable") or whether it should only be visible ("Visible" setting). With the setting "Hidden", the setpoint temperature is not displayed in the submenu and cannot be set. This parameter has no effect in a controller extension.
Setpoint temp. night mode cooling	Hidden Visible Visible and changeable	This temperature specifies for Controller 1 and Controller 2 whether the setpoint temperature for the Night operation operating mode in the Cooling operating mode can be changed in the submenu of the menu level (setting "Visible and changeable") or whether it should only be visible ("Visible" setting). With the setting "Hidden", the setpoint temperature is not displayed in the submenu and cannot be set. This parameter has no effect in a controller extension.
Presence mode	Hidden Visible Visible and changeable	This temperature specifies for Controller 1 and Controller 2 whether presence operation can be set in the submenu of the menu level (setting "Visible and changeable") or whether it should only be visible ("Visible" setting). With the setting "Hidden", it is not possible to set the presence mode in the submenu. This parameter has no effect in a controller extension.
Setpoint shift	Hidden Visible Visible and changeable	This temperature specifies for Controller 1 and Controller 2 whether the setpoint shift can be set in the submenu of the menu level (setting "Visible and changeable") or whether it should only be visible ("Visible" setting). With the setting "Hidden", it is not possible to set the setpoint shift in the submenu. This parameter has no effect in a controller extension.
Operating mode		

	<p>Hidden Visible Visible and changeable</p>	<p>This temperature specifies for Controller 1 and Controller 2 whether the operating mode can be set in the submenu of the menu level (setting "Visible and changeable") or whether it should only be visible ("Visible" setting). With the setting "Hidden", it is not possible to set the operating mode in the submenu. This parameter has no effect in a controller extension.</p>
Fan controller	<p>Hidden Visible Visible and changeable</p>	<p>This temperature specifies for Controller 1 and Controller 2 whether fan control is possible in the submenu of the menu level (setting "Visible and changeable") or whether it should only be visible ("Visible" setting). The menu item "Fan control" is actually only visible in the menu level if the fan control has been configured as present under "Room temperature control -> Controller general". With the setting "Hidden", fan control is not possible in the menu level. This parameter has no effect in a controller extension.</p>
Actual-temperature	<p>Hidden Visible</p>	<p>This temperature specifies for Controller 1 and Controller 2 whether the actual temperature is displayed in the submenu of the menu level ("Visible" setting). With the setting "Hidden", the actual temperature is not displayed in the submenu. This parameter has no effect in a controller extension.</p>
Setpoint temperature	<p>Hidden Visible</p>	<p>This temperature specifies for Controller 1 and Controller 2 whether the setpoint temperature is displayed in the submenu of the menu level ("Visible" setting). With the setting "Hidden", the setpoint temperature is not displayed in the submenu. This parameter has no effect in a controller extension.</p>
Outdoor temperature	<p>Hidden Visible</p>	<p>This temperature specifies for Controller 1 and Controller 2 whether the outdoor temperature is displayed in the submenu of the menu level ("Visible" setting). With the setting "Hidden", the outdoor temperature is not displayed in the submenu.</p>

		This parameter has no effect in a controller extension.
Any temperature 1	Hidden Visible	This temperature specifies for Controller 1 whether any temperature 1 is displayed in the submenu of the menu level ("Visible" setting). With the setting "Hidden", any temperature 1 is not displayed in the submenu. This parameter has no effect in a controller extension.
Any temperature 2	Hidden Visible	This temperature specifies for Controller 2 whether any temperature 2 is displayed in the submenu of the menu level ("Visible" setting). With the setting "Hidden", any temperature 2 is not displayed in the submenu. This parameter has no effect in a controller extension.
□ Display settings		
Brightness	Hidden Visible Visible and changeable	This temperature specifies whether the display brightness can be set in the submenu of the menu level (setting "Visible and changeable") or whether it should only be visible ("Visible" setting). With the setting "Hidden", the display brightness is not displayed in the submenu and cannot be set.
Pixel test	Hidden Visible	This parameter specifies whether the pixel test of the display can be recalled in the submenu of the menu level ("Visible" setting). With the setting "Hidden", the pixel test cannot be recalled in the menu level.

4.2.5.2 Parameter group "TSM" and "TSEM"

Description	Values	Comment
-------------	--------	---------

☐-| TSM

No parameters are shown on this parameter page. The parameter pages "Configuration TSM", "TSM - Rocker 1 (buttons 1/2)", "TSM - Rocker 2 (buttons 3/4)", "TSM - Rocker 3 (buttons 5/6)", "TSM - Rocker 4 (buttons 7/8)" are subordinate to the parameter page "TSM".

☐-| TSEM

No parameters are shown on this parameter page. The parameter pages "Configuration TSEM", "TSEM - Rocker 1 (buttons 1/2)", "TSEM - Rocker 2 (buttons 3/4)", "TSEM - Rocker 3 (buttons 5/6)", "TSEM - Rocker 4 (buttons 7/8)" are subordinate to the parameter page "TSEM".

A large part of the same functions, parameters and settings as in the TSM are available for the push-button sensor extension module TSEM. Differences between TSM and TSEM only exist among parameters of the controller operation. These differences are indicated in the following list of parameters by a separate note. Thus, the settings in the extension module are independent of the settings in the basic module.

☐-| Configuration TSM

☐-| Configuration TSEM

The following parameters are valid for: Configuration TSM and Configuration TSEM

Function and colour of all status LEDs

**user-defined
(function selection per
status-LED)**

3-colour-individual control
via objects

The display concept of the status LED for the TSM or TSEM is selected at this point. In the setting "User-defined", the usual LED functions are available, e.g. status display or button-press display. These also include the user-defined colour selection and the superimposed display of several functions. The settings are selected separately for each status LED on the corresponding parameter page. Alternatively, the different colours of each status LED can be addressed via their own communication objects. The setting "3-colour individual control via objects" is valid for all the status LEDs of the TSM or TSEM. 3 objects are created for each module (TSM & TSEM) for the three colours (switching colour red, switching colour green and switching colour blue). The object which received its value last determines the colour that the status LED lights up in. This setting causes the additional parameter "Control of the status LED via object value" to be shown on the parameter

Colour of all status LEDs	red green blue User-defined (colour selection per status LED)	pages of the status LED. Only with TSM: Depending on the parameter "Standard display function (...)", this parameter is not set visibly to user-defined.
Light period of status LED for button-press indicator	1 sec 2 sec 3 sec 4 sec 5 sec	This parameter defines the switch-on time the status LED is lit up to indicate actuation. The setting concerns all status LEDs whose function is set to "Button-press display".
Brightness for all LEDs	Level 0 (OFF) Level 1 (dark) ... Level 4 Level 5 (bright)	The brightness level for all status LEDs, the operation LED and the labelling field illumination is defined at this point.
Night reduction for reduced LED brightness	Yes No	Whether the parameter and communication object for reducing the brightness for all status LEDs, the operation LED and for the labelling field illumination should be shown is defined here.
Brightness for all LEDs in night reduction	Level 0 (OFF) Level 1 (dark)	The brightness of all status LEDs, the operation LED and the labelling field illumination is reduced to the specified

i If a button operation takes place when reduced brightness is activated, then all the active displays are displayed with the regular brightness for a period of about 30 seconds.

	... Level 5 (bright)	level as soon as the communication object "LED night reduction" receives the value "1". <i>i</i> There is no check of whether the reduced level has a lower value than the regular brightness level.
Standard display function	Yes No	With the help of this parameter, the standard display function of the TSM or TSEM is enabled. With the enabled standard display function of the compact room controller module, the LED functions of four status LEDs of the basic module are predefined. The standard display function contains the display of the setpoint shift and the temporary fan level display via the status LED. To ensure that the standard display function can function correctly in the preset variant, some parameters are configured as follows: <ul style="list-style-type: none"> - Room temperature controller function = switched on Controller status = KNX compliant - Setpoint presetting = Relative Some parameters are enabled or disabled depending on this parameter setting.
<p>The following parameter is valid for: Configuration TSEM</p>		
Function and colour of the operation LED	user-defined 3-colour-individual control via objects	At this point, the display concept of the operation LED is selected. In the setting "User-defined", the colour is permanently selected and the operation LED can be statically switched on or off, addressed via an object or automatically switched off after the last operation. Alternatively, the different colours of the operation LED can be addressed via its own communication objects (setting "3-colour individual control via objects").
Colour of the operation LED	red green blue	The colour of the operation LED is selected at this point. This parameter is only visible with user-defined function and colour selection.
Function of operation LED	always OFF always ON Control via object automatic switch-off	This parameter defines the user-defined function selection of the function of the operation LED. The operation LED can be permanently on or off or alternatively

		<p>be switched via a communication object. Optionally the operation LED can be switched on by pressing any desired button and switched off again automatically after a delay time has elapsed. Here the parameter "Time for automatic switch-off" defines the delay until switch-off after the last button-press. Each button-press re-initiates the delay time.</p> <p>This parameter is only visible with user-defined function and colour selection.</p>
Control via object value	<p>1 = static ON / 0 = static OFF</p> <p>1 = static OFF / 0 = static ON</p> <p>1 = flashing / 0 = static OFF</p> <p>1 = static OFF / 0 = flashing</p>	<p>If the "Function of the operation LED" is set to "Control via object" or a 3-colour control is configured, then the telegram polarity of the 1-bit objects of the operation LED can be specified at this point.</p> <p>The LED can be switched on or off statically. In addition, the received switching telegram can be evaluated in such a way that the LED flashes.</p>
Time for automatic switch-off (Minutes)	0...20	<p>If the "Function of the operation LED" is set to "Automatic switch-off", the delay before switch-off after the last button-press can be configured here.</p> <p>Setting the delay time minutes.</p>
Seconds	0...3...59	Setting the delay time seconds.
Function of the labelling field illumination	<p>always OFF always ON Control via object automatic switch-off</p>	<p>This parameter defines the function of the labelling field illumination. The labelling field illumination can be permanently on or off or alternatively be switched via a communication object. Optionally the labelling field illumination can be switched on by pressing any desired button and switched off again automatically after a delay time has elapsed. Here the parameter "Time for automatic switch-off" defines the delay until switch-off after the last button-press. Each button-press re-initiates the delay time.</p>
Control via object value	<p>1 = static ON / 0 = static OFF</p> <p>1 = static OFF / 0 = static ON</p> <p>1 = flashing /</p>	<p>If the "Function of the labelling field illumination" is set to "Control via object", then the telegram polarity of the 1-bit object "Labelling field illumination" can be specified at this point.</p> <p>The illumination can be switched on or off statically. In addition, the received</p>

	0 = static OFF 1 = static OFF / 0 = LED flashing	switching telegram can be evaluated in such a way that the illumination flashes.
Time for automatic switch-off (Minutes)	0...20	If the "Function of the labelling field illumination" is set to "Automatic switch-off", the delay before switch-off after the last button-press can be configured here. Setting the delay time minutes.
Seconds	0...3...59	Setting the delay time seconds.

- TSM - Operation concept
- TSEM - Operation concept

Operation concept of buttons 1 and 2 (The same parameters are available for the other control surfaces / button pairs.)	Rocker function (rocker 1) Button function	For each respectively opposing buttons, it can be set whether they are to be used combined as a rocker with a common basic function or as two buttons with separate functions. Depending on this setting, the ETS displays different communication objects and parameter pages. Depending on the parameter "Standard operating/display function", this parameter is preset to button function.
--	--	--

The following parameters are valid for: Standard display function (TSM) and standard display function (TSEM).

- Standard display function

Page of LED line setpoint shift	none Right Left	This parameter defines whether the device shows the status of the current setpoint shift using four status LEDs and the side of the device showing the current setpoint shift. The device either shows the current setpoint shift on the right-hand side (status LEDs 2, 4, 6 and 8) or on the left-hand side of the device (status LEDs 1, 3, 5 and 7). A positive adjustment is represented by a red illuminated status LED and a negative
---------------------------------	------------------------------	--

		adjustment by a blue status LED. The status LEDs of the selected side are permanently set to the visualisation of the setpoint shift and cannot be changed on the parameter pages of the status LED. By contrast, the status LEDs of the unselected side can be designed freely when the standard display function is active.
Setpoint source for LED line	Controller 1 Controller 2	The standard display function can be set up for one of the two controllers. This parameter defines the controller. Output of the setpoint shift is orientated to the setpoint of this controller.
Setpoint shifting display	2 steps in each direction 4 steps in each direction	This parameter defines how the setpoint shift is displayed. Furthermore, this parameter defines by how many steps the setpoint can be shifted if the standard display function is enabled. In the "4 steps in each direction" setting, all 4 status LEDs are used once to indicate the positive setpoint shift and also to indicate a negative setpoint shift. Positive adjustments are indicated by red illuminated LEDs and negative adjustments by green illuminated LEDs. If "2 steps in each direction" are configured, both upper status LEDs are used to indicate the positive shift, and both lower status LEDs are used to indicate the negative shift.
Display "no adjustment"	Standard 1 LED green 2 LEDs green 4 LED green	In the event that there is no setpoint shift, the behaviour can be set to user-oriented with this parameter. These options are available: - Standard (no LED lights up) - 1 LED green (status LED 5 or 6) - 2 LED green (status LED 3+5 or 4+6) - 4 LED green (status LED 1+3+5+7 or 2+4+6+8)
Temporary fan level display	No Controller 1 Controller 2	This parameter enables the temporary fan level display depending on various functions. When the fan level changes, this function displays the current fan level with the help of all 8 status LEDs. The current fan level is always displayed in blue. The duration of the temporary display is determined by the parameter "light period of the button-press display".
	Temporary fan level display possible, if:	- Function of a button = "Controller operation"

- Function of the button = "Fan controller"
- Function of the fan controller when pressing the button = "Manual control"
- Function of a status LED associated with the button = "Fan controller display"

4.2.5.2.1 Rocker functions

Description	Values	Comment
<input type="checkbox"/> TSM Rocker 1 (Buttons 1/2)		
<input type="checkbox"/> Rocker 1, function		
Function	Switching Dimming Venetian blind Value transmitter 1-byte Value transmitter 2-byte Scene extension 2-channel operation	This parameter is used to define the basic function of the rocker. Depending on this choice, the ETS displays different communication objects and parameters for this rocker.
<input type="checkbox"/> Rocker 1, switching		
Command on pressing left rocker	No reaction ON OFF TOGGLE	These parameters specify the reaction when the left rocker is pressed or released.
Command on releasing left rocker	No reaction ON OFF TOGGLE	
Command on pressing right rocker	No reaction ON OFF TOGGLE	These parameters specify the reaction when the right rocker is pressed or released.
Command on releasing right rocker	No reaction ON OFF TOGGLE	
<input type="checkbox"/> Rocker 1, dimming		
Command on pressing left rocker	No reaction Brighter (ON)	This parameter defines the reaction when the left rocker is pressed.

	Darker (OFF) Brighter / darker (TOGGLE) Brighter (TOGGLE) Darker (TOGGLE)	If the push-button sensor is to toggle on a brief press, the corresponding switching objects of other sensors with the same function must be linked with one another. In the "Brighter/darker (TOGGLE)" setting, the dimming objects must be interlinked as well so that the push-button sensor can send the correct telegram on the next button-press.
Command on pressing right rocker	No reaction Brighter (ON) Darker (OFF) Brighter / darker (TOGGLE) Brighter (TOGGLE) Darker (TOGGLE)	This parameter defines the reaction when the right rocker is pressed. If the push-button sensor is to toggle on a brief press, the corresponding switching objects of other sensors with the same function must be linked with one another. In the "Brighter/darker (TOGGLE)" setting, the dimming objects must be interlinked as well so that the push-button sensor can send the correct telegram on the next button-press.
Time between switching and dimming, left rocker (100 ... 50000 x 1 ms)	100 ... 400 ... 50000	This parameter defines how long the left rocker must be pressed for the push-button sensor to send a dimming telegram.
Time between switching and dimming, right rocker (100 ... 50000 x 1 ms)	100 ... 400 ... 50000	This parameter defines how long the right rocker must be pressed for the push-button sensor to send a dimming telegram.
Advanced parameters	activated deactivated	When the advanced parameters are activated, the ETS shows the following parameters.
Advanced parameters activated...		
Increase brightness by	1.5 % 3 % 6 % 12.5 % 25 % 50 % 100 %	This parameter sets the relative dimming level when the brightness is increased. On each button-press, the brightness is changed at maximum by the configured step width. Especially with smaller dimming levels it is advisable for the push-button sensor to repeat the dimming telegrams automatically (see "telegram repetition").
Reduce brightness by	1.5 % 3 %	This parameter sets the relative dimming level when the brightness is

	<p>6 % 12.5 % 25 % 50 % 100 %</p>	<p>reduced. On each button-press, the brightness is changed at maximum by the configured step width. Especially with smaller dimming levels it is advisable for the push-button sensor to repeat the dimming telegrams automatically (see "telegram repetition").</p>
Transmit stop telegram?	<p>Yes No</p>	<p>On "Yes" the push-button sensor transmits a telegram for stopping the dimming process when the rocker is released. When the push-button sensor transmits telegrams for dimming in smaller levels, the stop telegram is generally not needed.</p>
Telegram repeat?	<p>Yes No</p>	<p>This parameter can be used to activate telegram repetition for dimming. With the button held down, the push-button sensor will then transmit the relative dimming telegrams (in the programmed step width) until the button is released.</p>
Time between two telegrams	<p>200 ms 300 ms 400 ms 500 ms 750 ms 1 sec 2 sec</p>	<p>This parameter defines the interval at which the dimming telegrams are automatically repeated in the telegram repetition mode. This parameter is visible only if "Telegram repetition = Yes"!</p>
Full-surface operation	<p>enabled Disabled</p>	<p>When the full-surface operation is enabled, the ETS shows the following parameters.</p>
Function for full-surface operation	<p>Switching Scene recall without storage function Scene recall with storage function</p>	<p>In case of full-surface operation, this parameter defines the function that is to be used. The ETS shows the corresponding communication object and the other parameters. If the push-button sensor is to recall a scene with storage function by full-surface actuation, it will make a distinction between a brief press (less than 1 s), a sustained press (longer than 5 s) and an invalid button-press (between 1 s and 5 s). A brief press recalls the scene, a sustained press stores a scene and an invalid full-surface operation is ignored. This parameter is visible only if "Full-surface actuation = enabled"!</p>

Command for full-surface operation	ON OFF TOGGLE	This parameter defines the value of the transmitted telegram when a full-surface operation has been sensed. "TOGGLE" changes over the current object value. This parameter is visible only if "Full-surface actuation = enabled"!
Scene number (1 ... 64)	1, 2, ..., 64	This parameter defines the scene number which is to be transmitted to the bus after a scene recall or during storage of a scene. This parameter is visible only if "Full-surface actuation = enabled"!
☐ ↙ Rocker 1, Venetian blind		
Command on pressing rocker	Left rocker: UP / Right rocker: DOWN Left rocker: DOWN / Right rocker: UP Left rocker: TOGGLE / Right rocker: TOGGLE	This parameter defines the running direction of a drive after a button actuation. If the setting is "TOGGLE", the direction is changed after each long time command. If several push-buttons are to control the same drive, the long time objects of the push-buttons must be interlinked for a correct change of the running direction.
Operation concept	short – long – short long – short short – long long – short or short	For Venetian blind control, four different operation concepts can be selected. For these concepts, the ETS shows further parameters.
Time between short and long time command, left rocker (1 ... 3000 x 100 ms)	1 ... 4 ... 3000	This parameter sets the time after which the long-time operation will be evaluated on pressing the left button of the rocker. This parameter is not visible with "Operation concept = long – short"!
Time between short and long time command, right rocker (1 ... 3000 x 100 ms)	1 ... 4 ... 3000	This parameter sets the time after which the long-time operation will be evaluated on pressing the right button of the rocker. This parameter is not visible with "Operation concept = long – short"!
Slat adjusting time, left rocker (0 ... 3000 x 100 ms)	0 ... 5 ... 3000	Time during which a transmitted long time telegram can be terminated by releasing the left button of the rocker (short time). This function serves to adjust the slats of a blind.

		This parameter is not visible with "Operation concept = short - long"!
Slat adjusting time, right rocker (0 ... 3000 x 100 ms)	0 ... 5 ... 3000	Time during which a transmitted long time telegram can be terminated by releasing the right button of the rocker (short time). This function serves to adjust the slats of a blind. This parameter is not visible with "Operation concept = short - long"!
Full-surface operation	enabled Disabled	When the full-surface operation is enabled, the ETS shows the following parameters. Full-surface operation can only be programmed if "Operation concept = long – short or short"!
Function for full-surface operation	Switching Scene recall without storage function Scene recall with storage function	In case of full-surface operation, this parameter defines the function that is to be used. The ETS shows the corresponding communication object and the other parameters. If the push-button sensor is to recall a scene with storage function by full-surface actuation, it will make a distinction between a brief press (less than 1 s), a sustained press (longer than 5 s) and an invalid button-press (between 1 s and 5 s). A brief press recalls the scene, a sustained press stores a scene and an invalid full-surface operation is ignored. This parameter is visible only if "Full-surface actuation = enabled"!
Command for full-surface operation	ON OFF TOGGLE	This parameter defines the value of the transmitted telegram when a full-surface operation has been sensed. "TOGGLE" changes over the current object value. This parameter is visible only if "Full-surface actuation = enabled"!
Scene number (1 ... 64)	1 , 2, ..., 64	This parameter defines the scene number which is to be transmitted to the bus after a scene recall or during storage of a scene. This parameter is visible only if "Full-surface actuation = enabled"!
<p><input type="checkbox"/> Rocker 1, value transmitter, 1-byte Function</p>		

	<p>Left rocker / right, no function</p> <p>Left rocker: 0...255 / Right rocker: 0...255</p> <p>Left rocker: 0...100 % / Right rocker: 0...100 %</p> <p>Left rocker: 0...255 / Right rocker: No function</p> <p>Left rocker: 0...100 % / Right rocker: No function</p> <p>Left rocker: No function / Right rocker: 0...255</p> <p>Left rocker: No function / Right rocker: 0...100 %</p>	<p>A rocker configured as "Value transmitter 1 byte" permits selecting whether the values to be transmitted are interpreted as integers from 0 to 255 or as a percentage from 0 % to 100 %. The following parameters and their settings depend on this distinction.</p>
Value, left rocker (0...255)	0...255	This parameter defines the object value when the left rocker is pressed. Visible only if "Function = 0...255"!
Value right rocker (0...255)	0...255	This parameter defines the object value when the right rocker is pressed. Visible only if "Function = 0...255"!
Value, left rocker (0...100 %)	0...100	This parameter defines the object value when the left rocker is pressed. Visible only if "Function = 0...100 %"!
Value right rocker (0...100 %)	0...100	This parameter defines the object value when the right rocker is pressed. Visible only if "Function = 0...100 %"!
Value adjustment by long button-press	<p>enabled</p> <p>Disabled</p>	<p>If value adjustment by long button-press is enabled, the ETS shows further parameters.</p> <p>Value adjustment begins, when the button is held down for more than 5 s. In this case, the respective status LED flashes as a sign that a new telegram has been transmitted.</p>
Starting value in case of value adjustment	<p>Same as configured value</p> <p>same as value after last adjustment</p> <p>Same as value from</p>	<p>Value adjustment can begin with different starting values.</p> <p>"Same as parameterised value": After each long press, the push-button sensor always starts with the value configured in the ETS.</p>

	communication object	<p>"Same as value after last adjustment": After a long press, the push-button sensor starts with the value transmitted by itself or by another device with this group address as the last value.</p> <p>"Same as value from communication object": After a long press, the push-button sensor starts with the value transmitted by itself or by another device with this group address as the last value.</p> <p>This parameter is only visible if "Value adjustment by long button-press = enabled"!</p>
Direction of value adjustment	upwards	<p>With a long press, the push-button sensor can either vary the values always in the same direction or it stores the direction of the last adjustment and reverses it on the next button-press. This parameter is only visible if "Value adjustment by long button-press = enabled"!</p>
	downwards	
	toggling (alternating)	
Step width (1...15)	1... 15	<p>In a value adjustment, the push-button sensor determines the new telegram value from the previous value and the preset step width. If the value falls below the lower limit of the adjustment range (0 or 0 %) or if it exceeds the upper limit (255 or 100%), the sensor adapts the step width of the last step automatically. This parameter is only visible if "Value adjustment by long button-press = enabled"!</p>
Time between two telegrams	0.5 sec	<p>This parameter defines the interval at which the push-button sensor transmits new telegrams during a value adjustment. This parameter is only visible if "Value adjustment by long button-press = enabled"!</p>
	1 sec	
	2 sec	
	3 sec	
Value adjustment with overflow	Yes	<p>If value adjustment is to be effected without overflow (setting "No") and if the push-button sensor reaches the lower limit of the adjustment range (0 or 0 %) or the upper limit (255 or 100 %) during value adjustment, the adjustment will be stopped automatically by the sensor. If the value adjustment with overflow is programmed (setting "Yes") and if the push-button sensor reaches the lower or the upper limit, it will transmit the value</p>
	No	

of this range limit and then add a pause the duration of which corresponds to two levels. Thereafter, the push-button sensor transmits a telegram with the value of the other range limit and continues the value adjustment in the same direction.

☐ ↩ Rocker 1, value transmitter, 2-byte

Function	Temperature value transmitter	
	Brightness value transmitter	A rocker configured as "Value transmitter 2 byte" permits selecting whether the values to be transmitted are to be interpreted as temperature values (0 °C to 40 °C), as brightness values (0 lux to 1500 lux) or as integers (0 to 65535). The following parameters and their settings depend on this selection.
	Value transmitter (0...65535)	
Temperature value (0...40 °C) Left rocker	0... 20 ...40	This parameter defines the object value when the left rocker is pressed. This is only visible if "Function = Temperature value transmitter"!
Temperature value (0...40 °C) Right rocker	0... 20 ...40	This parameter defines the object value when the right rocker is pressed. This is only visible if "Function = Temperature value transmitter"!
Brightness value Left rocker	0, 50,... 300 ...1450, 1500 lux	This parameter defines the object value when the left rocker is pressed. This is only visible if "Function = Brightness value transmitter"!
Brightness value Right rocker	0, 50,... 300 ...1450, 1500 lux	This parameter defines the object value when the right rocker is pressed. This is only visible if "Function = Brightness value transmitter"!
Value (0...65535) Left rocker	0 ...65535	This parameter defines the object value when the left rocker is pressed. This is only visible if "Function = Value transmitter (0...65535)"!
Value (0...65535) Right rocker	0 ...65535	This parameter defines the object value when the right rocker is pressed. This is only visible if "Function = Value transmitter (0...65535)"!

Value adjustment by long button-press	<p>enabled Disabled</p>	<p>If value adjustment by long button-press is enabled, the ETS shows further parameters. Value adjustment begins, when the button is held down for more than 5 s. In this case, the respective status LED flashes as a sign that a new telegram has been transmitted.</p>
Starting value in case of value adjustment	<p>Same as configured value</p> <p>same as value after last adjustment</p> <p>Same as value from communication object</p>	<p>Value adjustment can begin with different starting values. "Same as parameterised value": After each long press, the push-button sensor always starts with the value configured in the ETS. "Same as value after last adjustment": After a long press, the push-button sensor starts with the value transmitted by itself or by another device with this group address as the last value. "Same as value from communication object": After a long press, the push-button sensor starts with the value transmitted by itself or by another device with this group address as the last value. This setting selectable only if "Functionality = Value transmitter (0...65535)!" This parameter is only visible if "Value adjustment by long button-press = enabled"!</p>
Direction of value adjustment	<p>upwards</p> <p>downwards</p> <p>togglng (alternating)</p>	<p>With a long press, the push-button sensor can either vary the values always in the same direction or it stores the direction of the last adjustment and reverses it on the next button-press. This parameter is only visible if "Value adjustment by long button-press = enabled"!</p>
Step width	1 °C	<p>For temperature values, the step width of the adjustment is fixed to 1°C. This parameter is only visible if "Function = Temperature value transmitter" and "Value adjustment by long button-press = enabled"!</p>
Step width	50 lux	<p>For brightness values, the step width of the adjustment is fixed to 50 lux. This parameter is only visible if "Function = Brightness value transmitter" and "Value adjustment by long button-press = enabled"!</p>

Step width	<p>1 2 5 10 20 50 75 100 200 500 750 1000</p>	<p>This parameter sets the step width of the value adjustment for the 2-byte value transmitter.</p> <p>This parameter is only visible if "Function = Value transmitter (0...65535)" and "Value adjustment by long button-press = enabled"!</p>
Time between two telegrams	<p>0.5 sec 1 sec 2 sec 3 sec</p>	<p>This parameter defines the interval at which the push-button sensor transmits new telegrams during a value adjustment.</p> <p>This parameter is only visible if "Value adjustment by long button-press = enabled"!</p>
Value adjustment with overflow	<p>Yes No</p>	<p>If value adjustment is to be effected without overflow (setting "No") and if the push-button sensor reaches the lower limit of the adjustment range (0°C, 0 lux, 0) or the upper limit (40°C, 1500 lux, 65535) during value adjustment, the adjustment will be stopped automatically by the sensor.</p> <p>If the value adjustment with overflow is programmed (setting "Yes") and if the push-button sensor reaches the lower or the upper limit, it will transmit the value of this range limit and then add a pause the duration of which corresponds to two levels. Thereafter, the push-button sensor transmits a telegram with the value of the other range limit and continues the value adjustment in the same direction.</p>
<p><input type="checkbox"/> Rocker 1, scene extension</p>		
Function	<p>Scene extension without storage function</p> <p>Scene extension with storage function</p> <p>Recall of internal scene extension without storage function</p> <p>Recall of internal scene with storage function</p>	<p>This parameter defines the functionality of the extension.</p> <p>If the push-button sensor is used as a scene extension, the scenes can either be stored in one or in several other KNX devices (e.g. light scene push button sensor).</p> <p>During a scene recall or in a storage function, the push-button sensor transmits a telegram with the respective scene number via the extension object</p>

		of the rocker. During the recall of an internal scene, a scene stored internally in the push-button sensor is recalled or stored again. In this case, the sensor transmits no telegram to the bus via a scene extension object. For this setting, the internal scene function must be enabled.
Scene number (1 ... 64) Left rocker	1...64	In accordance with the KNX standard, objects with data type 18.001 "Scene Control" can recall or store up to 64 scenes by their numbers. The parameter defines the scene number to be transmitted when a left button is pressed.
Scene number (1 ... 64) Right rocker	1...64	In accordance with the KNX standard, objects with data type 18.001 "Scene Control" can recall or store up to 64 scenes by their numbers. The parameter defines the scene number to be transmitted when a right button is pressed.
Scene number (1 ... 8) Left rocker	1...8	This parameter defines the number of the internal scene which is recalled or stored when a left button is pressed.
Scene number (1 ... 8) Right rocker	1...8	This parameter defines the number of the internal scene which is recalled or stored when a right button is pressed.
<input type="checkbox"/> Rocker 1, 2-channel operation		
Operation concept	Channel 1 or channel 2 Channel 1 and channel 2	This parameter defines the 2-channel operation concept. If the setting "Channel 1 or channel 2" is selected, the push-button sensor decides dependent on the button-press duration which of the channels will be used. If the setting "Channel 1 and channel 2" is selected, the push-button transmits only the telegram of channel 1 on a short button-press and both telegrams on a sustained button-press.
Function channel 1 (2)	No function Switching (1 bit)	This parameter defines the channel function and specifies which other parameters and which communication object are to be displayed for channel 1

	Value transmitter 0 ... 255 (2). (1-byte)	
	Value transmitter 0 ... 100 % (1-byte)	
	Temperature value transmitter (2 bytes)	
Command of button for channel 1 (2) Left rocker	ON OFF TOGGLE	This parameter defines the object value transmitted to the bus, when the left-hand rocker is pressed. This is only visible if "Function channel 1 (2) = Switching (1 bit)"!
Command of button for channel 1 (2) Right rocker	ON OFF TOGGLE	This parameter defines the object value transmitted to the bus, when the right-hand rocker is pressed. This is only visible if "Function channel 1 (2) = Switching (1 bit)"!
Value of the button for Channel 1 (2) Left rocker (0...255)	0...255	This parameter defines the object value transmitted to the bus, when the left-hand rocker is pressed. It is only visible if "Function channel 1 (2) = Value transmitter 0...255 (1 byte)"!
Value of the button for Channel 1 (2) Right rocker (0...255)	0...255	This parameter defines the object value transmitted to the bus, when the right-hand rocker is pressed. It is only visible if "Function channel 1 (2) = Value transmitter 0...255 (1 byte)"!
Value of the button for Channel 1 (2) Left rocker (0 ... 100 %)	0...100	This parameter defines the object value transmitted to the bus, when the left-hand rocker is pressed. It is only visible if "Function channel 1 (2) = Value transmitter 0...100 % (1-byte)"!
Value of the button for Channel 1 (2) Right rocker (0 ... 100 %)	0...100	This parameter defines the object value transmitted to the bus, when the right-hand rocker is pressed. It is only visible if "Function channel 1 (2) = Value transmitter 0...100 % (1-byte)"!
Temperature value of the button for channel 1 (2) Left rocker (0 ... 40 °C)	0...40	This parameter defines the temperature value transmitted to the bus when the left-hand rocker is pressed. It is only visible if "Function channel 1

		(2) = Temperature value transmitter (2 bytes)!"
Temperature value of the button for channel 1 (2) Right rocker (0 ... 40 °C)	0...40	This parameter defines the temperature value transmitted to the bus when the right-hand rocker is pressed. It is only visible if "Function channel 1 (2) = Temperature value transmitter (2 bytes)!"
Time between channel 1 and channel 2 Left rocker (1 ... 255 x 100 ms)	1...30...255	Depending on the selected operation concept, this parameter defines the interval at which the push-button transmits the telegram for channel 1 and the telegram for channel 2 when the left side of the rocker is pressed.
Time between channel 1 and channel 2 Right rocker (1 ... 255 x 100 ms)	1...30...255	Depending on the selected operation concept, this parameter defines the interval at which the push-button transmits the telegram for channel 1 and the telegram for channel 2 when the right side of the rocker is pressed.
Full-surface operation	enabled Disabled	When the full-surface operation is enabled, the ETS shows the following parameters. Full-surface operation can only be programmed if "Operation concept = Channel 1 or channel 2!"
Function for full-surface operation	Switching Scene recall without storage function Scene recall with storage function	In case of full-surface operation, this parameter defines the function that is to be used. The ETS shows the corresponding communication object and the other parameters. If the push-button sensor is to recall a scene with storage function by full-surface actuation, it will make a distinction between a brief press (less than 1 s), a sustained press (longer than 5 s) and an invalid button-press (between 1 s and 5 s). A brief press recalls the scene, a sustained press stores a scene and an invalid full-surface operation is ignored. This parameter is visible only if "Full-surface actuation = enabled!"
Command for full-surface operation	ON OFF TOGGLE	This parameter defines the value of the transmitted telegram when a full-surface operation has been sensed. "TOGGLE"

changes over the current object value.
This parameter is visible only if "Full-surface actuation = enabled"!

Scene number (1 ... 64) 1, 2, ..., 64

This parameter defines the scene number which is to be transmitted to the bus after a scene recall or during storage of a scene.
This parameter is visible only if "Full-surface actuation = enabled"!

Rockers 2 ... max. 4 see Rocker 1!

4.2.5.2.2 Push-button functions

Description	Values	Comment
<p>☐ ↵ TSM button 1</p> <p>☐ ↵ Button 1, function</p> <p>Function</p>	<p>No function</p> <p>Switching</p> <p>Dimming</p> <p>Venetian blind</p> <p>Value transmitter 1-byte</p> <p>Value transmitter 2-byte</p> <p>Scene extension</p> <p>2-channel operation</p> <p>Controller operation</p> <p>Controller extension</p> <p>Change in the display reading</p>	<p>This parameter defines the basic function of the button. Depending on this setting, the ETS displays different communication objects and parameters for this button.</p>
<p>☐ ↵ Button 1, switching</p> <p>Command on pressing the button</p> <p>Command on releasing the button</p>	<p>No reaction</p> <p>ON</p> <p>OFF</p> <p>TOGGLE</p> <p>No reaction</p> <p>ON</p> <p>OFF</p> <p>TOGGLE</p>	<p>These parameters specify the reaction when the button is pressed or released.</p>
<p>☐ ↵ Button 1, dimming</p> <p>Command on pressing the button</p>	<p>Brighter (ON)</p> <p>Darker (OFF)</p> <p>Brighter / darker (TOGGLE)</p> <p>Brighter (TOGGLE)</p> <p>Darker (TOGGLE)</p>	<p>This parameter defines the reaction when the button is pressed. If the push-button sensor is to toggle on a brief press, the corresponding switching objects of other sensors with the same function must be linked with one another. In the "Brighter/darker (TOGGLE)" setting, the dimming objects must be interlinked as well so that the push-button sensor can send the correct telegram on the next button-press.</p>
<p>Time between switching and dimming (100 ... 50000 x 1 ms)</p>	<p>100 ... 400 ... 50000</p>	<p>This parameter defines how long the button must be pressed for the push-button sensor to transmit a dimming telegram.</p>
<p>Advanced parameters</p>	<p>activated</p> <p>deactivated</p>	<p>When the advanced parameters are activated, the ETS shows the following parameters.</p>

Advanced parameters
activated...

<p>Increase brightness by</p>	<p>1.5 % 3 % 6 % 12.5 % 25 % 50 % 100 %</p>	<p>This parameter sets the relative dimming level when the brightness is increased. On each button-press, the brightness is changed at maximum by the configured step width. Especially with smaller dimming levels it is advisable for the push-button sensor to repeat the dimming telegrams automatically (see "telegram repetition").</p>
<p>Reduce brightness by</p>	<p>1.5 % 3 % 6 % 12.5 % 25 % 50 % 100 %</p>	<p>This parameter sets the relative dimming level when the brightness is reduced. On each button-press, the brightness is changed at maximum by the configured step width. Especially with smaller dimming levels it is advisable for the push-button sensor to repeat the dimming telegrams automatically (see "telegram repetition").</p>
<p>Transmit stop telegram?</p>	<p>Yes No</p>	<p>On "Yes" the push-button sensor transmits a telegram for stopping the dimming process when the rocker is released. When the push-button sensor transmits telegrams for dimming in smaller levels, the stop telegram is generally not needed.</p>
<p>Telegram repeat?</p>	<p>Yes No</p>	<p>This parameter can be used to activate telegram repetition for dimming. With the button held down, the push-button sensor will then transmit the relative dimming telegrams (in the programmed step width) until the button is released.</p>
<p>Time between two telegrams</p>	<p>200 ms 300 ms 400 ms 500 ms 750 ms 1 sec 2 sec</p>	<p>This parameter defines the interval at which the dimming telegrams are automatically repeated in the telegram repetition mode. This parameter is visible only if "Telegram repetition = Yes"!</p>
<p><input type="checkbox"/> Button 1, Venetian blind</p> <p>Command on pressing the button</p>	<p>DOWN UP TOGGLE</p>	<p>This parameter defines the running direction of a drive after a button actuation. If the setting is "TOGGLE", the direction is changed after each long time command. If several push-buttons are to control the same drive, the long time objects of the push-buttons must be</p>

		interlinked for a correct change of the running direction.
Operation concept	<p>short – long – short</p> <p>long – short</p> <p>short – long</p> <p>long – short or short</p>	For Venetian blind control, four different operation concepts can be selected. For these concepts, the ETS shows further parameters.
Time between short-time and long-time command (1 ... 3000 x 100 ms)	1 ... 4 ... 3000	This parameter sets the time after which the long-time operation will be evaluated on pressing the left button of the rocker. This parameter is not visible with "Operation concept = long – short"!
Slat adjusting time (0 ... 3000 x 100 ms)	0 ... 5 ... 3000	Time during which a transmitted long time telegram can be terminated by releasing the left button of the rocker (short time). This function serves to adjust the slats of a blind. This parameter is not visible with "Operation concept = short - long"!
<p>□⇩ Button 1, value transmitter, 1-byte</p> <p>Function</p>	<p>Value transmitter 0...255</p> <p>Value transmitter 0...100 %</p>	A button configured as "Value transmitter 1 byte" permits selecting whether the values to be transmitted are interpreted as integers from 0 to 255 or as a percentage from 0 % to 100 %. The following parameters and their settings depend on this distinction.
Value (0...255)	0...255	This parameter defines the object value when the button is pressed. Visible only if "Function = 0...255"!
Value (0...100 %)	0...100	This parameter defines the object value when the button is pressed. Visible only if "Function = 0...100 %"!
Value adjustment by long button-press	<p>enabled</p> <p>Disabled</p>	<p>If value adjustment by long button-press is enabled, the ETS shows further parameters.</p> <p>Value adjustment begins, when the button is held down for more than 5 s. In this case, the respective status LED flashes as a sign that a new telegram</p>

		has been transmitted.
Starting value in case of value adjustment	<p>Same as configured value</p> <p>same as value after last adjustment</p> <p>Same as value from communication object</p>	<p>Value adjustment can begin with different starting values.</p> <p>"Same as parameterised value": After each long press, the push-button sensor always starts with the value configured in the ETS.</p> <p>"Same as value after last adjustment": After a long press, the push-button sensor starts with the value transmitted by itself or by another device with this group address as the last value.</p> <p>"Same as value from communication object": After a long press, the push-button sensor starts with the value transmitted by itself or by another device with this group address as the last value.</p> <p>This parameter is only visible if "Value adjustment by long button-press = enabled"!</p>
Direction of value adjustment	<p>upwards</p> <p>downwards</p> <p>toggleing (alternating)</p>	<p>With a long press, the push-button sensor can either vary the values always in the same direction or it stores the direction of the last adjustment and reverses it on the next button-press. This parameter is only visible if "Value adjustment by long button-press = enabled"!</p>
Step width (1...15)	1...15	<p>In a value adjustment, the push-button sensor determines the new telegram value from the previous value and the preset step width. If the value falls below the lower limit of the adjustment range (0 or 0 %) or if it exceeds the upper limit (255 or 100%), the sensor adapts the step width of the last step automatically. This parameter is only visible if "Value adjustment by long button-press = enabled"!</p>
Time between two telegrams	<p>0.5 sec</p> <p>1 sec</p> <p>2 sec</p> <p>3 sec</p>	<p>This parameter defines the interval at which the push-button sensor transmits new telegrams during a value adjustment.</p> <p>This parameter is only visible if "Value adjustment by long button-press = enabled"!</p>
Value adjustment with overflow	<p>Yes</p> <p>No</p>	<p>If value adjustment is to be effected without overflow (setting "No") and if the</p>

push-button sensor reaches the lower limit of the adjustment range (0 or 0 %) or the upper limit (255 or 100 %) during value adjustment, the adjustment will be stopped automatically by the sensor. If the value adjustment with overflow is programmed (setting "Yes") and if the push-button sensor reaches the lower or the upper limit, it will transmit the value of this range limit and then add a pause the duration of which corresponds to two levels. Thereafter, the push-button sensor transmits a telegram with the value of the other range limit and continues the value adjustment in the same direction.

□↵ Button 1, value transmitter, 2-byte

Function	Temperature value transmitter Brightness value transmitter Value transmitter (0...65535)	A button configured as "Value transmitter 2 byte" permits selecting whether the values to be transmitted are to be interpreted as temperature values (0 °C to 40 °C), as brightness values (0 lux to 1500 lux) or as integers (0 to 65535). The following parameters and their settings depend on this selection.
Temperature value (0...40 °C)	0... 20 ...40	This parameter defines the object value when the button is pressed. This is only visible if "Function = Temperature value transmitter"!
Brightness value	0, 50,... 300 ...1450, 1500 lux	This parameter defines the object value when the button is pressed. This is only visible if "Function = Brightness value transmitter"!
Value (0...65535)	0 ...65535	This parameter defines the object value when the button is pressed. This is only visible if "Function = Value transmitter (0...65535)"!
Value adjustment by long button-press	enabled Disabled	If value adjustment by long button-press is enabled, the ETS shows further parameters. Value adjustment begins, when the button is held down for more than 5 s. In this case, the respective status LED flashes as a sign that a new telegram has been transmitted.

Starting value in case of value adjustment	<p>Same as configured value</p> <p>same as value after last adjustment</p> <p>Same as value from communication object</p>	<p>Value adjustment can begin with different starting values.</p> <p>"Same as parameterised value": After each long press, the push-button sensor always starts with the value configured in the ETS.</p> <p>"Same as value after last adjustment": After a long press, the push-button sensor starts with the value transmitted by itself or by another device with this group address as the last value.</p> <p>"Same as value from communication object": After a long press, the push-button sensor starts with the value transmitted by itself or by another device with this group address as the last value. This setting selectable only if "Function = Value transmitter (0...65535)"!</p> <p>This parameter is only visible if "Value adjustment by long button-press = enabled"!</p>
Direction of value adjustment	<p>upwards</p> <p>downwards</p> <p>togglng (alternating)</p>	<p>With a long press, the push-button sensor can either vary the values always in the same direction or it stores the direction of the last adjustment and reverses it on the next button-press. This parameter is only visible if "Value adjustment by long button-press = enabled"!</p>
Step width	1 °C	<p>For temperature values, the step width of the adjustment is fixed to 1°C. This parameter is only visible if "Function = Temperature value transmitter" and "Value adjustment by long button-press = enabled"!</p>
Step width	50 lux	<p>For brightness values, the step width of the adjustment is fixed to 50 lux. This parameter is only visible if "Function = Brightness value transmitter" and "Value adjustment by long button-press = enabled"!</p>
Step width	<p>1</p> <p>2</p> <p>5</p> <p>10</p> <p>20</p> <p>50</p> <p>75</p> <p>100</p> <p>200</p>	<p>This parameter sets the step width of the value adjustment for the 2-byte value transmitter.</p> <p>This parameter is only visible if "Function = Temperature value transmitter" and "Value adjustment by long button-press = enabled"!</p>

	<p>500 750 1000</p>	
<p>Time between two telegrams</p>	<p>0.5 sec 1 sec 2 sec 3 sec</p>	<p>This parameter defines the interval at which the push-button sensor transmits new telegrams during a value adjustment. This parameter is only visible if "Value adjustment by long button-press = enabled"!</p>
<p>Value adjustment with overflow</p>	<p>Yes No</p>	<p>If value adjustment is to be effected without overflow (setting "No") and if the push-button sensor reaches the lower limit of the adjustment range (0°C, 0 lux, 0) or the upper limit (40°C, 1500 lux, 65535) during value adjustment, the adjustment will be stopped automatically by the sensor. If the value adjustment with overflow is programmed (setting "Yes") and if the push-button sensor reaches the lower or the upper limit, it will transmit the value of this range limit and then add a pause the duration of which corresponds to two levels. Thereafter, the push-button sensor transmits a telegram with the value of the other range limit and continues the value adjustment in the same direction.</p>
<p>☐ Button 1, scene extension</p>		
<p>Function</p>	<p>Scene extension without storage function</p> <p>Scene extension with storage function</p> <p>Recall of internal scene extension without storage function</p> <p>Recall of internal scene with storage function</p>	<p>This parameter defines the functionality of the extension. If the push-button sensor is used as a scene extension, the scenes can either be stored in one or in several other KNX devices (e.g. light scene push button sensor). During a scene recall or in a storage function, the push-button sensor transmits a telegram with the respective scene number via the extension object of the button. During the recall of an internal scene, a scene stored internally in the push-button sensor is recalled or stored again. In this case, the sensor transmits no telegram to the bus via a scene extension object. For this setting, the internal scene function must be enabled.</p>
<p>Scene number (1 ... 64)</p>	<p>1...64</p>	<p>In accordance with the KNX standard, objects with data type 18.001 "Scene</p>

		Control" can recall or store up to 64 scenes by their numbers. The parameter defines the scene number to be transmitted when the button is pressed.
Scene number (1 ... 8)	1...8	This parameter defines the number of the internal scene which is recalled or stored when a button is pressed.
☐ Button 1, 2-channel operation		
Operation concept	Channel 1 or channel 2 Channel 1 and channel 2	This parameter defines the 2-channel operation concept. If the setting "Channel 1 or channel 2" is selected, the push-button sensor decides dependent on the button-press duration which of the channels will be used. If the setting "Channel 1 and channel 2" is selected, the push-button transmits only the telegram of channel 1 on a short button-press and both telegrams on a sustained button-press.
Function channel 1 (2)	No function Switching (1 bit) Value transmitter 0 ... 255 (1-byte) Value transmitter 0 ... 100 % (1-byte) Temperature value transmitter (2 bytes)	This parameter defines the channel function and specifies which other parameters and which communication object are to be displayed for channel 1 (2).
Command of button for channel 1 (2)	ON OFF TOGGLE	This parameter defines the object value transmitted to the bus when the button is pressed. This is only visible if "Function channel 1 (2) = Switching (1 bit)"!
Value of the button for Channel 1 (2) (0 ... 255)	0...255	This parameter defines the object value transmitted to the bus when the button is pressed. It is only visible if "Function channel 1 (2) = Value transmitter 0...255 (1 byte)"!
Value of the button for Channel 1 (2) (0 ... 100 %)	0...100	This parameter defines the object value transmitted to the bus when the button is pressed. It is only visible if "Function channel 1 (2) = Value transmitter 0...100 % (1 byte)"!

Temperature value of the button for channel 1 (2) (0 ... 40 °C)	0... 20 ...40	This parameter defines the temperature value transmitted to the bus when the button is pressed. It is only visible if "Function channel 1 (2) = Temperature value transmitter (2 bytes)"!
Time between channel 1 and channel 2 (1 ... 255 x 100 ms)	1... 30 ...255	Depending on the selected operation concept, this parameter defines the interval at which the push-button transmits the telegram for channel 1 and the telegram for channel 2 when the button is pressed.
<input type="checkbox"/> Button 1, controller extension		
Function takes effect	Controller extension 1 Controller extension 2	The button function "Controller extension" can either affect Controller extension 1 or 2. The precondition for this is that the selected controller extension is enabled in the parameter node "Room temperature control".
Function	Operating mode switch-over Forced oper. mode switchover Presence button Setpoint shift	A controller extension can optionally switch over the operating mode with normal or high priority, change the presence state or change the current room temperature value. With regard to the setting of this parameter, the ETS shows further parameters.
Operating mode when the following button is pressed	Comfort mode Standby mode Night mode Frost/heat protection mode Comfort mode -> Standby mode -> Comfort mode -> Night mode -> Standby mode -> Night mode -> Comfort mode -> Standby mode -> Night mode ->	If the controller extension is to change over the operating mode of the connected room temperature controller with normal priority, the extension can – when operated – either switch on a defined operating mode or change over between different operating modes. In order for this change to work properly, the controller extension should request the current state of the extension objects after a reset or after re-programming (set parameter under "General" to "Value request from controller extension = Yes"). This parameter is only visible if "Function = operating mode switchover"!

<p>Forced operating mode when the following button is pressed</p>	<p>Auto (Normal operating mode change-over)</p> <p>Comfort mode</p> <p>Standby mode</p> <p>Night mode</p> <p>Frost/heat protection mode</p> <p>Comfort mode -> Standby mode -></p> <p>Comfort mode -> Night mode -></p> <p>Standby mode -> Night mode -></p> <p>Comfort mode -> Standby mode -> Night mode -></p> <p>Auto -> Comfort mode -></p> <p>Auto -> Standby mode -></p> <p>Auto -> Night mode -></p> <p>Auto -> Frost/heat protection mode -></p>	<p>If the controller extension is to change over the operating mode of the connected room temperature controller with high priority, the extension can – when actuated – either enable the change-over with normal priority (auto), switch on a defined operating mode with a high priority or change over between different operating modes.</p> <p>In order for this change to work properly, the controller extension should request the current state of the extension objects after a reset or after re-programming (set parameter under "General" to "Value request from controller extension = Yes"). This parameter is only visible if "Function = forced operating mode switchover"!</p>
<p>Presence function when the following button is pressed</p>	<p>Presence OFF</p> <p>Presence ON</p> <p>Presence TOGGLE</p>	<p>When a button is pressed, the controller extension can switch on or switch off the presence state of the connected room temperature controller in a defined way or the extension can change over between the two states ("Presence TOGGLE"). In order for this change-over to work properly, the controller extension should request the current state of the extension objects after a reset or after re-programming (set parameter under "General" to "Value request from controller extension? = Yes"). This parameter is only visible if "Function = presence button"!</p>
<p>Setpoint shift on pressing the button</p>	<p>Reduce setpoint value (level size)</p>	<p>This parameter defines the direction of the setpoint shift on the extension. For a setpoint value shift, the controller</p>

	<p>Increase setpoint (level size)</p>	<p>extension makes use of the two communication objects "Setpoint shift specification" and "Current setpoint shift". The "Current setpoint shift" communication object informs the extension about the current state of the connected room temperature controller. Based on this value and the respective parameter, the controller extension determines the new level size which it transmits via the "Setpoint shift specification" communication object to the room temperature controller. This parameter is only visible if "Function = Setpoint shift"!</p>
<p>□ Button 1 Controller operation Function takes effect</p>	<p>Controller 1 Controller 2</p>	<p>The button function "Controller operation" can either affect Controller 1 or 2. The precondition for this is that the selected controller is switched on in the parameter node "Room temperature control".</p>
<p>Function</p>	<p>Operating mode switch-over Forced oper. mode switchover Presence button Setpoint shift Fan controller</p>	<p>The "controller operation" function, allows you to optionally switch over the operating mode with normal or high priority, change the presence status, change the current room temperature value or operate the fan controller. With regard to the setting of this parameter, the ETS shows further parameters.</p>
<p>Operating mode when the following button is pressed</p>	<p>Comfort mode Standby mode Night mode Frost/heat protection mode Comfort mode -> Standby mode -> Comfort mode -> Night mode -> Standby mode -> Night mode -> Comfort mode -> Standby mode -></p>	<p>If, by pressing the button, the operating mode of the internal room temperature controller is to change over with normal priority, it is possible with this function either to switch on a defined operating mode – when operated – or to toggle between different operating modes. This parameter is only visible if "Function = operating mode switchover"!</p>

Night mode ->

Forced operating mode when the following button is pressed

Auto
(Normal operating mode change-over)

Comfort mode

Standby mode

Night mode

Frost/heat protection mode

Comfort mode ->
Standby mode ->

Comfort mode ->
Night mode ->

Standby mode ->
Night mode ->

Comfort mode ->
Standby mode ->
Night mode ->

Auto ->
Comfort mode ->

Auto ->
Standby mode ->

Auto ->
Night mode ->

Auto ->
Frost/heat protection mode ->

If, by pressing the button, the operating mode of the internal room temperature controller is to change over with high priority, it is possible with this function either to enable the change-over with normal priority (Auto) – when operated – , to switch on a defined operating mode with high priority or to toggle between different operating modes.

This parameter is only visible if "Function = forced operating mode switchover"!

Presence function when the following button is pressed

Presence OFF

Presence ON

Presence TOGGLE

On pressing a button, the controller can switch on or switch off the presence state of the internal room temperature controller either in a defined way or toggle between the two states ("Presence TOGGLE").

This parameter is only visible if "Function = presence button"!

Setpoint shift on pressing the button

Reduce setpoint value (level size)

Increase setpoint (level size)

This parameter defines the direction of the setpoint shift on the internal room temperature controller. For a setpoint value shift, the controller makes use of the two communication objects "Setpoint shift specification" and "Current setpoint shift".

		<p>The "Current setpoint shift" communication object informs about the current state of the room temperature controller. Based on this value and the respective parameter, the controller determines the new level size which it transmits via the "Setpoint shift specification" communication object to the room temperature controller. This parameter is only visible if "Function = Setpoint shift"!</p>
Function of the fan controller when pressing the button	<p>No function</p> <p>Automatic mode</p> <p>Manual control</p>	<p>With this parameter the button function fan controller can be configured so that it either sets the fan controller to automatic mode or takes over the manual control. Depending on the number of fan levels configured, you increase the fan level in the "manual control" setting.</p>
<p>□↵ Button 1, change in the display reading</p> <p>Button function</p>	<p>Scrolling through display information</p> <p>Recall of display information</p>	<p>This parameter can be used to configure the button function "Display change" in such a way that, on each button press, either one item of display information after another is displayed or a fixed item of display information is recalled. The "Scroll through display information" selection takes the sequence of display information set in the "Display" parameter node into account.</p>
Function for button-press	<p>Scroll to next display function</p> <p>Scroll to previous display function</p>	<p>Each time a button is pressed, the display switches in the designed order. This parameter defines the direction in which the display changes. With "Scroll to next display information", the sequence changes as follows: 1 -> 2 -> 3 -> ... -> 17 -> 1 ->.</p> <p>With "Scroll to previous display information", the sequence changes as follows: 1 -> 17 -> 16 -> ... -> 1 -> 17 ->.</p> <p>This parameter is only visible if the parameter "Button display function" is set to "Scroll through display information".</p>
Function for button-press	<p>Open Display information 1</p> <p>Open Display information 2</p> <p>Open Display information 3</p> <p>Open Display information 4</p>	<p>Each time a button is pressed, the display switches to the display information set here. If this display information is already shown on the display, no change occurs. The display information set here must also be enabled in the "Display" parameter node and be configured.</p>

Open
Display information 5
Open
Display information 6
Open
Display information 7
Open
Display information 8
Open
Display information 9
Open
Display information 10
Open
Display information 11
Open
Display information 12
Open
Display information 13
Open
Display information 14
Open
Display information 15
Open
Display information 16
Open
Display information 17

This parameter is only visible if the parameter "Button function" is set to "Recall display information".

☐ Buttons 2 ... max. 8 see Button 1!

4.2.5.2.3 Functions of the status LED

Description	Values	Comment
□↵ TSM W1 status LED		
□↵ TSM T1 status LED		
Function of left / right status LED	always OFF	Irrespective of the button or rocker function, the status LED is switched off permanently.
	always ON	Irrespective of the button or rocker function, the status LED is switched on permanently.
	Button-press display	The status LED indicates a button actuation. The ON time is set on the parameter page "General" in common for all status LEDs that are configured as actuation displays.
	Telegram acknowledgment	The status LED indicates the transmission of a telegram in 2-channel operation. This setting can only be configured for the button or rocker function "2-channel operation".
	Status display (switching object)	The status LED indicates the state of the communication object "Switching". If the object value is "ON", the status LED is illuminated. If the object value is "OFF" the status LED is switched off. This setting can only be configured for the button or rocker function "Switching" or "Dimming".
	inverted status display (switching object).	The status LED indicates the state of the communication object "Switching". If the object value is "OFF", the status LED is illuminated. If the object value is "ON" the status LED is switched off. This setting can only be configured for the button or rocker function "Switching" or "Dimming".
	Control via separate LED object	The status LED indicates the state of its own, separate 1-bit LED object. This setting causes the additional parameter "Control of the status LED via object value" to be shown.
	Operating mode display (KNX controller)	The status LED indicates the state of a KNX room temperature controller via a separate 1-byte communication object. This setting causes the additional parameter "Status LED ON with" to be shown.
	Controller status indication	The status LED indicates the state of the internal room temperature controller or the controller extension. This setting causes the additional parameter "Status LED ON with" to be shown.

Setpoint value shift display	<p>The status LED indicates the state of a setpoint shift of the controller operation or in case of controller extension operation. This setting causes the additional parameter "Status LED" to be shown.</p> <p>This setting can only be configured in the button function "Controller extension" or "Controller operation" and with the button function "Setpoint shift".</p>
Presence status	<p>The status LED indicates the state of the presence button of the controller operation or in case of controller extension operation. The LED lights up if the presence function is activated. The LED is off if the presence function is inactive.</p> <p>This setting can only be configured in the button function "Controller extension" or "controller operation" and with the button function "Presence button".</p>
Inverted presence status	<p>The status LED indicates the state of the presence button of the controller operation or in case of controller extension operation. The LED lights up if the presence function is inactive. The LED is off if the presence function is activated.</p> <p>This setting can only be configured in the button function "Controller extension" or "controller operation" and with the button function "Presence button".</p>
Comparator without sign (1-byte)	<p>The status LED is activated depending on a comparison. In this configuration there is a separate 1-byte communication object available via which the unsigned reference value (0...255) is received. This setting causes the additional parameter "Status LED ON with" to be shown.</p>
Comparator with sign (1-byte)	<p>The status LED is activated depending on a comparison. In this configuration there is a separate 1-byte communication object available via which the positive or negative reference value (-128...127) is received. This setting causes the additional parameter "Status LED ON with" to be shown.</p>

The display parameters "Possible LED functions" on the parameter pages of the status LEDs show the specific LED functions that can be configured. If LED functions other than the possible ones are configured, the affected status LEDs

will not have any function during subsequent operation of the push-button sensor (always OFF).

The function of the status LED = "Display via separate LED object"...

Control of the status LED via object value

**1 = LED static ON /
0 = LED static OFF**

1 = LED static OFF /
0 = LED static ON

1 = LED flashes /
0 = LED static OFF

1 = LED static OFF /
0 = LED flashes

If the "Function of status LED ..." is set to "Control via separate LED object", then the telegram polarity of the 1-bit object "Status LED" can be specified at this point.

The LED can be switched on or off statically. In addition, the received switching telegram can be evaluated in such a way that the LED flashes.

If the function of status LED = "Operating mode display (KNX controller)"...

Status LED ON with

Automatic mode
Comfort mode
Standby mode
Night mode
Frost/heat protection mode

The values of a communication object with data type 20.102 "HVAC Mode" are defined as follows:

0 = Automatic
1 = Comfort
2 = Standby
3 = Night
4 = Frost/heat protection

The value "Automatic" is used only by the "forced operating mode switchover" objects.

The status LED is illuminated when the object receives the value configured here.

The function of the status LED = "Controller status indication"...

Status LED ON with

**Comfort mode (C)
(R.General)**
Standby mode (S)
(R.General)
Night mode (N) (R.General)
Frost/heat protection mode
(R.General)
Controller disabled
(R.General)
Heating / cooling
Controller inactive

The communication object "KNX controller status" as well as the "Controller status" object of a room temperature controller contain status information. This parameter is used to define which information is to be indicated by the LED.

The controller status can be indicated only if the room temperature controller function or controller extension is enabled (parameter page "General")!

	(deadband operation) (R.General) Frost alarm (R.General) Normal/Forced operating mode (R.General) Comfort mode extension (R.General) Open window (R.General) Additional level active (R.General) dew point alarm Controller fault (KNX compliant) Frost protect. temp. fallen below! (KNX compliant) Heat protection temp. exceeded (KNX compliant)	
If the function of status LED = "Comparator without sign"...		
Status LED ON with	Reference value greater than received value	The status LED indicates whether the configured reference value is greater or less than or equal to the value of the "Status LED" object".
	Reference value less than received value	
	Reference value equal to received value	
Reference value (0 ... 255)	0...255	This parameter defines the reference value to which the value of the "Status LED" object is compared.
If the function of status LED = "Comparator with sign"...		
Status LED ON with	Reference value greater than received value	The status LED indicates whether the configured reference value is greater or less than or equal to the value of the "Status LED" object".
	Reference value less than received value	
	Reference value equal to received value	
Reference value (-128 ... 127)	-128...0...127	This parameter defines the reference value to which the value of the "Status LED" object is compared.
If function of the status LED = "Fan controller display"...		

Status LED	<p>ON, with automatic</p> <p>ON, with manual control, level 0</p> <p>ON, with manual control, uneven level greater than 0</p> <p>ON, with manual control, even level greater than 0</p>	<p>The status LED shows whether the fan controller is in automatic or manual mode. In the status indication of the manual mode, the LED lights up - depending on project design - either if level 0, an uneven level greater than 0 or an even level greater than 0 is active.</p>
<p>With user-defined function and colour configuration and "Colour of all status LEDs" = "Colour selection per status LED"...</p>	<p>Yes No</p>	<p>When user-defined colour settings are used, an automatic colour change can be configured here for the LED functions "Operating mode display", "Controller status", "Setpoint shift" and "Comparator". If the function has been enabled (setting YES), the colour of the corresponding status LED does not depend on the user specification via ETS parameter or communication object (superimposed function). Instead, the device then automatically decides which in colour the status LED should light up, based on the function value. With the setting "No", the colour of the status LED, and optionally a superimposed function, can be configured.</p>
<p>Status LED ON for" / "Status-LED"</p>	<p>Setting depends on the LED function / read-only</p>	<p>The parameter "Status LED ON for" or "Status LED" indicates the colour which is set for an automatic colour change, depending on the function value. This parameter is only visible for an automatic colour change and cannot be changed.</p>
<p>Colour of the status LED</p>	<p>red green blue</p>	<p>If separate colour settings for the status LEDs are required, then this parameter can be used individually to define the desired colour for each status LED. The LED lights up in the configured colour if it is subsequently switched on regularly in operation of the push-button sensor in accordance with the basic configuration "Function of the status LED". This parameter is only visible if the parameter "Colour selection of all status</p>

LEDs" on parameter page "General" is set to "Colour selection per rocker/button".
This parameter is only visible when no automatic colour change is configured.

The following parameter is valid for: Controller status display

Colour of the status LED	<p>OFF = ---, ON = Red</p> <p>OFF = ---, ON = Green</p> <p>OFF = ---, ON = Blue</p> <p>OFF = Red, ON = Green</p> <p>OFF = Green, ON = Red</p> <p>OFF = Red, ON = Blue</p> <p>OFF = Blue, ON = Red</p> <p>OFF = Green, ON = Blue</p> <p>OFF = Blue, ON = Green</p>	<p>If separate colour settings for the status LEDs are required, then this parameter can be used individually to define the desired colour for each status LED. The LED lights up in the configured colour if it is subsequently switched on regularly in operation of the push-button sensor in accordance with the basic configuration "Function of the status LED".</p> <p>This parameter is only visible if the parameter "Colour selection of all status LEDs" on parameter page "General" is set to "Colour selection per rocker/button".</p> <p>This parameter is only visible when no automatic colour change is configured.</p>
Superposed function	<p>enabled</p> <p>Disabled</p>	<p>With separate colour setting it is additionally possible to configure a superposed function separately for each status LED. The superposed function can be used change the colour of a status LED via a communication object during operation of the device. It is also possible here to change the display function. The superposed function of a status LED is enabled when this parameter is configured to "enabled".</p> <p>This parameter is only visible when no automatic colour change is configured.</p>
Colour of the status LED for superposed function	<p>red</p> <p>green</p> <p>blue</p>	<p>If the superposed function is enabled, this parameter can be used to define the desired superposed colour. The LED lights up in the configured colour if the superposed function is later activated in operation of the push button sensor.</p> <p>This parameter is only visible if the parameter "Superposed function" is set to "enabled".</p>
	Control via separate LED object	With the superposed function the status LED indicates the state of a separate

<p>Selection of the superposed LED function</p>	<p>Comparator without sign (1-byte)</p>	<p>1-bit LED object. This setting causes the additional parameter "Control of the status LED via object value" to be shown.</p>
	<p>Comparator with sign (1-byte)</p>	<p>In the superposed function the status LED is activated depending on a comparison. In this configuration there is a separate 1-byte communication object available via which the unsigned reference value (0...255) is received. This setting causes the additional parameter "Superposed function ON with" to be shown.</p>
<p>Control of the status LED via object value</p>	<p>1 = superposed Funct. ON / 0 = superposed Funct. OFF</p> <p>1 = superposed Funct. OFF / 0 = superposed Funct. ON</p> <p>1 = superposed Funct. flashes / 0 = superposed Funct. OFF</p> <p>1 = superposed Funct. OFF / 0 = superposed Funct. flashes</p>	<p>If the "Selection of the superposed LED function" is set to "Control via separate LED object", this parameter can be used to specify the telegram polarity of the "Superposed polarity" 1-bit object of the status LED concerned.</p> <p>The superposed function can be switched on or off statically. In addition, the received switching telegram can be evaluated in such a way that the LED flashes when a superposed function is active.</p>
<p>Superposed function ON when</p>	<p>Reference value greater than received value</p> <p>Reference value less than received value</p> <p>Reference value equal to received value</p>	<p>In the superposed function the status LED indicates whether the configured reference value is greater or less than or equal to the value of the "Superposed value function" object.</p> <p>This parameter is only visible when "Selection of the superposed LED function" = "Comparator without sign" / "Comparator with sign".</p>
<p>Reference value (0 ... 255)</p>	<p>0...255</p>	<p>This parameter defines the reference value to which the value of the "Superposed value function" object is compared.</p> <p>This parameter is only visible when</p>

		"Selection of the superposed LED function" = "Comparator without sign".
Reference value (-128 ... 127)	-128... 0 ...127	This parameter defines the reference value to which the value of the "Superposed value function" object is compared. This parameter is only visible when "Selection of the superposed LED function" = "Comparator with sign".
Source	Controller 1 Controller 2 Controller extension 1 Controller extension 2	The function of the status LED "Fan controller display" can refer to either Controller 1 or 2 or Controller extension 1 or 2. The precondition for this is that the selected controller or selected controller extension is enabled in the parameter node "Room temperature control".
Fan controller	Automatic mode Manual control, level 0 Manual control, uneven level (>0) Manual control, even level (>0)	The status LED indicates the state of a fan controller of the controller operation. This setting causes the additional parameter "Status LED" to be shown. This setting can only be configured in the button function "controller operation" and with the button function "fan controller".

4.2.5.3 Parameter group "Room temperature control"

Description	Values	Comment
<p>□ Room temperature control -> Configuration</p>		
Controller 1		<p>The controller function block integrated in the device can either work as a main controller or, alternatively, as a controller extension. The setting of this parameter has a major impact on the function and on the other parameters and objects displayed in the ETS.</p>
	switched-off	<p>The Controller 1 function block is switched off completely. No room temperature control and controller extension function can be executed by the device.</p>
	Switched-on	<p>The Controller 1 function block works as a main controller. The internal control algorithm is active, meaning that Controller 1 of the device can be used for single-room temperature control.</p>
	Controller extension 1	<p>The Controller 1 function block works as a controller extension. A controller extension itself is not involved in the temperature regulating process. With it, the user can operate the single-room controller, i.e. the main controller from different places in the room. Any number of controller extensions can be controlled by a main controller. In the function as a controller extension, settings relating to the integrated controller are not possible in the menu level.</p>
Controller 2		<p>The controller function block integrated in the second device can either work as a main controller or, alternatively, as a controller extension. The setting of this parameter has a major impact on the function and on the other parameters and objects displayed in the ETS.</p>
	switched-off	<p>The Controller 2 function block is switched off completely. No room temperature control and controller extension function can be executed by the device.</p>
	Switched-on	<p>The Controller 2 function block works as a main controller. The internal control algorithm is active, meaning that Controller 2 of the device can be used</p>

for single-room temperature control.

Controller extension 1

The Controller 2 function block works as a controller extension. A controller extension itself is not involved in the temperature regulating process. With it, the user can operate the single-room controller, i.e. the main controller from different places in the room. Any number of controller extensions can be controlled by a main controller. In the function as a controller extension, settings relating to the integrated controller are not possible in the menu level.

4.2.5.3.1 Room temperature controller

Description	Values	Comment
<p>□ Room temperature control -> Controller general</p> <p>Source, actual temperature</p>		<p>The product database of the device contains three independent blocks for temperature measurement. Up to three temperatures can be determined in parallel, depending on whether the TSM is alone, is combined with a TSEM and/or with a connected remote sensor. Each temperature measurement can be performed by the internal sensor or, optionally, by a received temperature value. Combined temperature recording (internal sensor + received temperature value) can also be configured.</p>
	TSM	<p>This parameter defines with which temperature values Controller <i>n</i> works. For room temperature control, temperature values can be measured either by the TSM, TSEM or a remote sensor or be received via a communication object. The precondition for control with temperature values from the TSM, TSEM or remote sensor is that the set source is enabled and configured on the "Room temperature measurement" parameter page. The "Object" selection for the "Actual temperature" communication object enables which temperature values can be received via the KNX.</p>
	TSEM	
	Remote sensor	
	Object	

Operating mode

	<p>Heating</p> <p>Cooling</p> <p>Heating and cooling</p> <p>Basic and additional heating</p> <p>Basic and additional cooling</p> <p>Basic and additional heating and cooling</p>	<p>The room temperature controller distinguishes between two different operating modes. The operating modes specify whether you want the controller to use its variable to trigger heating systems ("heating" single operating mode) or cooling systems ("cooling" single operating mode). You can also activate mixed operation, with the controller being capable of changing over between "Heating" and "Cooling" either automatically or, alternatively, controlled by a communication object. In addition, you can establish two-level control operation to control an additional heating or cooling unit. For two-level feedback control, separate command values will be calculated as a function of the temperature deviation between the setpoint and the actual value and transmitted to the bus for the basic and additional levels.</p> <p>This parameter specifies the operating mode and, if necessary, enables the additional level(s).</p>
Fan controller available	<p>Yes</p> <p>No</p>	<p>The room temperature control can be supplemented with a fan controller using this parameter. By enabling the fan controller ("Yes" setting), it is possible to control the fan from heating and cooling systems operated by circulating air, such as fan coil units (FanCoil units), depending on the command value calculated in the controller or using manual operation.</p> <p>When the function is enabled additional parameters will appear in the ETS in the "Room temperature control -> Controller general -> Fan controller" as well as additional communication objects. Fan control is not possible with switching 2-point feedback control.</p>
Fan operating mode	<p>Heating</p> <p>Cooling</p> <p>Heating and cooling</p> <p>Basic heating</p> <p>Additional heating</p> <p>Basic cooling</p> <p>Additional cooling</p>	<p>Depending on the operating mode of the room temperature control, as configured in the ETS, various controller command values can be used as the basis for fan control. The "Fan operating mode" parameter specifies which command value of the controller controls the fan controller. With one-level room temperature control, it is possible to select whether the fan is activated during heating and/or during cooling. With two-level room temperature control, it is also possible for the fan controller to be set to the basic level or the additional</p>

	Basic heating and cooling	level during heating and cooling. However, under no circumstances is it possible to use the basic and additional levels simultaneously for a fan controller within an operating mode.
	Basic heating and additional cooling	This basic setting of this parameter depends on the selected controller operating mode.
	Basic cooling and additional heating	
	Additional heating and cooling	
Transmit heating and cooling command values to one common object	Yes No	If the parameter is set to "Yes", the command value will be transmitted on a shared object during heating or cooling. This function is used, if the same heating system is used to cool the room in the summer and used to heat the room in the winter. This parameter is only visible with "heating and cooling" mixed operating mode, if applicable, with additional levels.
Type of heating control (if applicable, for basic and additional stage)	Continuous PI control Switching PI control (PWM) Switching 2-point feedback control (ON/OFF)	Selecting a feedback control algorithm (PI or 2-point) with data format (1 byte or 1 bit) for the heating system
Type of heating (if applicable, for basic and additional level)	Hot water heater (5 K / 150 min) Underfloor heating (5 K / 240 min) Electric heating (4 K / 100 min) Fan convector (4 K / 90 min) Split unit (4 K / 90 min) via control parameter	Adapting the PI algorithm to different heating systems using predefined values for the proportional range and reset time control parameters. With the "Using control parameters" setting, it is possible to set the control parameters in a manner deviating from the predefined values within specific limits. This parameter is only visible if "Type of heating control = Continuous PI control".
Proportional range heating (10 ... 127) * 0.1 K	10... 50 ...127	Separate setting of the "Proportional range" control parameter. This parameter is only visible if "Type of heating = via control parameter" and the heating control type "PI control".
Reset time heating (0 ... 255) * 1 min; 0 = inactive	0... 50 ...255	Separate setting of the "Reset time" control parameter. This parameter is only visible if "Type of heating = via control parameter" and the

		heating control type "PI control".
Bottom hysteresis of the 2-point controller heating (-128 ... -5) * 0.1 K	-128...-5	Definition of bottom hysteresis (switch-on temperatures) of the heating. This parameter is only visible if "Type of heating control = Switching 2-point feedback control (ON/OFF)".
Top hysteresis of the 2-point controller heating (5 ... 127) * 0.1 K	5...127	Definition of top hysteresis (switch-off temperatures) of the heating. This parameter is only visible if "Type of heating control = Switching 2-point feedback control (ON/OFF)".
Type of cooling control (if applicable, for basic and additional stage)	Continuous PI control Switching PI control (PWM) Switching 2-point feedback control (ON/OFF)	Selecting a feedback control algorithm (PI or 2-point) with data format (1 byte or 1 bit) for the cooling system
Type of cooling (if applicable, for basic and additional level)	Cooling ceiling (5 K / 240 min) Electric heating (4 K / 100 min) Fan convector (4 K / 90 min) Split unit (4 K / 90 min) via control parameter	Adapting the PI algorithm to different cooling systems using predefined values for the proportional range and reset time control parameters. With the "Using control parameters" setting, it is possible to set the control parameters in a manner deviating from the predefined values within specific limits. This parameter is only visible if "Type of cooling control = PI control".
Proportional range heating (10 ... 127) * 0.1 K	10... 50 ...127	Separate setting of the "Proportional range" control parameter. This parameter is only visible if "Type of cooling = via control parameter" and the cooling control type "PI control".
Reset time heating (0 ... 255) * 1 min; 0 = inactive	0... 150 ...255	Separate setting of the "Reset time" control parameter. This parameter is only visible if "Type of cooling = via control parameter" and the cooling control type "PI control".
Bottom hysteresis of the 2-point controller heating (-128 ... -5) * 0.1 K	-128...-5	Definition of bottom hysteresis (switch-off temperatures) of the cooling. This parameter is only visible if "Type of cooling control = Switching 2-point feedback control (ON/OFF)".

Top hysteresis of the 2-point controller cooling (5 ... 127) * 0.1 K	5...127	Definition of top hysteresis (switch-on temperatures) of the cooling. This parameter is only visible if "Type of cooling control = Switching 2-point feedback control (ON/OFF)".
Additional stage inhibit object	Yes No	The additional stages can be separately disabled via the bus. The parameter enables the disable object as necessary. This parameter is only visible in two-level heating and cooling operation.
Operating mode switch-over	via value (1 byte) via switching (4 x 1 bit)	In the setting "Via value (1-byte) the change-over of the operating modes via the bus takes place according to the KNX specification via a 1-byte value object. In addition, a higher-ranking forced object is available for this setting. In the setting "Via switching (4 x 1 bit)" the 'classic' change-over of the operating modes via the bus is via four separate 1-bit objects.
Operation mode after reset	Comfort mode Standby mode Night operation Frost/heat protection mode	This parameter specifies which operating mode is set immediately after a device reset.
Frost/heat protection	Automatic frost protection via window status	In addition to the operating mode switchover by the corresponding operating mode switchover object or by room temperature regulator operation on the TSM (button function), the frost/heat protection mode can be activated by a window contact or, alternatively, frost protection can be activated by an automatic temperature control option. This parameter defines the manner in which the higher-priority switchover takes place, compared to the operating mode switchover by an object or button function.
Window status delay (minutes, 0 = inactive)	0 ... 255	You can optionally parameterise a window status delay. This delay can make sense if short ventilation of the room by opening the window is not supposed to cause an operating mode switchover. You can use the "window status delay" parameter to set this delay time between 1 and 255 minutes. The window status will only be changed and thus the frost/heat protection mode activated after this parameterized time

		has elapsed. A setting of "0" will effect the immediate activation of the frost/heat protection mode when the window is open. The window status will be in effect in the heating and in the cooling mode. This parameter is only visible if the parameter "Frost/heat protection" is set to "Via window status".
Automatic frost protection temperature drop	<p>Off</p> <p>0.2 K / min</p> <p>0.3 K / min</p> <p>0.4 K / min</p> <p>0.5 K / min</p> <p>0.6 K / min</p>	You can use the "automatic frost protection temperature drop" parameter to set the maximum temperature drop in K/min for switching over to the frost protection mode. After the time preset by the "frost protection period in automatic mode" parameter has elapsed, the regulator will return into the mode which was set before frost protection. Re-triggering will not be possible.
Frost protection period, automatic mode (minutes)	1 ... 20 ... 255	This parameter defines the length of the frost protection when frost protection is activated automatically.
Output rotation angle (only if "Output of command value" =normal)	<p>Disabled</p> <p>enabled</p>	This parameter is only visible when the operating mode is set to "Heating and cooling", the parameter "Send command value for heating and cooling to a shared object" is set to "YES", the type of control is set to "Continuous PI control" and the parameter "Output command value" is set to "Normal...". It defines whether rotation angle conversion of the Heating and Cooling command value output is to take place or not. If this parameter is enabled, five additional parameters appear, along with the KNX communication object "Rotation angle"
min rotation angle for cooling, (0...255) * 1°	0... 0 ...255	This parameter specifies the minimum size of the rotation angle for cooling.
max rotation angle for cooling, (0...255) * 1°	0... 30 ...255	This parameter specifies the maximum size of the rotation angle for cooling.
Rotation angle for deadband, (0...255) * 1°	0... 45 ...255	This parameter determines the rotation angle at which the deadband is set. Within the deadband, neither heating nor cooling will take place.

min rotation angle for heating, (0...255) * 1°	0... 60 ...255	This parameter specifies the minimum size of the rotation angle for heating. As soon as the rotation angle is greater than the value set here, the system begins heating.
max rotation angle for heating, (0...255) * 1°	0... 90 ...255	This parameter specifies the maximum size of the rotation angle for heating.
□ Room temperature control -> Controller general -> Fan controller		
Number of fan levels	No fan levels 1 fan level 2 fan levels 3 fan levels 4 fan levels 5 fan levels 6 fan levels 7 fan levels 8 fan levels	The fan controller of the room temperature controller supports up to 8 fan level outputs, for which the actually used number of levels (1...8) is set using this parameter.
Fan level change-over via	Switching objects (8 x 1 Bit) Value object (1 byte)	Depending on the data format of the objects of the controlled actuators, the change-over between the fan levels can either take place via up to 8 separate 1-bit objects or, alternatively, via one 1-byte object. The "Fan level change-over via" parameter defines the data format of the controller. With the 1-bit objects, each fan level discreetly receives its own object. With the 1-byte object, the active fan level is expressed by a value ("0" = Fan OFF / "1" = Level 1 / "2" = Level 2 / "3" = Level 3 / etc.).
Fan OFF threshold value -> Level 1, * 1 %	0... 1 ...100	In automatic operation, the command value of the controller is used internally in the device for automatic control of the fan levels. As a transition between the levels, there are threshold values, defined according to the command value of the controller, which can be set here. If the command value exceeds the threshold value of a level, the appropriate level is activated. If the command value sinks below a threshold value, minus the configured hysteresis, then the change-over takes place into the next lowest fan level.
Fan level 1 threshold value -> Level 2, * 1 %	0... 30 ...100	

<p>Fan level 2 threshold value -> Level 3, * 1 %</p>	<p>0...60...100</p>	
<p>Fan level 3 threshold value -> Level 4, * 1 %</p>	<p>0...90...100</p>	
<p>Fan level 4 threshold value -> Level 5, * 1 %</p>	<p>0...100</p>	
<p>Fan level 5 threshold value -> Level 6, * 1 %</p>	<p>0...100</p>	
<p>Fan level 6 threshold value -> Level 7, * 1 %</p>	<p>0...100</p>	
<p>Fan level 7 threshold value -> Level 8, * 1 %</p>	<p>0...100</p>	
<p>Hysteresis between threshold values, *1%</p>	<p>1...3...50</p>	<p>If the command value of the room temperature control has undershot the threshold value minus the hysteresis, the fan controller switches back to the previous level.</p>
<p>Waiting time for level change-over *0.1 s</p>	<p>1...2...255</p>	<p>Due to fan motors' inertia, as a rule there is a limit to how short the time intervals for switching the fan levels can be, i.e. there is a limit to how quickly the fan speed can be varied. If the fan controller is working in automatic mode, the settable "Waiting time on level change-over" is maintained on change-over of the levels.</p>
<p>Level limit (max. fan level)</p>	<p>No level limit Fan level 1 Fan level 2 Fan level 3 Fan level 4 Fan level 5 Fan level 6 Fan level 7 Fan level 8</p>	<p>To reduce the fan noise of a fan coil, the fan level limit can be activated. The level limit reduces the sound emissions by limiting the maximum fan level to a fan level value configured here (limitation level). The limit can be switched on and off using the "Fan, level limit" 1-bit object and thus activated as necessary.</p> <p>The parameter "Level limit" is not checked for plausibility, meaning that an incorrect configuration is possible. For this reason, care should be taken to ensure that there is no limit level in the configuration which is higher than the actual fan levels. If a higher limit level is configured, then the limit has no effect.</p>

Behaviour on forced position	<p>no forced position</p> <p>Fan level 1 Fan level 2 Fan level 3 Fan level 4 Fan level 5 Fan level 6 Fan level 7 Fan level 8 Fan level OFF</p>	<p>The controller provides the option of activating a forced fan position via the bus. With an active forced position, the fan levels can neither be controlled nor switched over in either automatic or manual mode. The fan remains in the forced state until the forced position is removed using the bus. In this manner, it is possible to switch the fan to a locked and controlled state, for example for servicing purposes.</p> <p>As soon as the forced position is activated, the controller jumps to the fan level configured in this parameter without any waiting time. The fan can also be completely switched off.</p>
Object interpretation, automatic/manual fan control	<p>0=Automatic mode, 1=Manual mode</p> <p>1=Automatic mode, 0=Manual mode</p>	<p>The parameter specifies the polarity of the object for the change-over between automatic and manual fan control. Automatic mode is always active after a device reset.</p>
Fan level on change-over to manual	<p>no change</p> <p>Fan level 1 Fan level 2 Fan level 3 Fan level 4 Fan level 5 Fan level 6 Fan level 7 Fan level 8 Fan level OFF</p>	<p>On change-over from automatic operation to manual operation, this parameter then decides whether the fan level most recently set in automatic operation is maintained, the fan is switched off or a defined fan level is set. The parameter "Fan level on change-over to manual" is not checked for plausibility in the ETS, meaning that an incorrect configuration is possible. For this reason, care should be taken to ensure that there is no level in the configuration which is higher than the actual fan levels. If a level which does not exist is to be configured for the change-over to manual control, then the fan controller changes over to the maximum possible level when changing over to manual operation.</p>
Heating fan run-on time, *0.1 s, 0=Inactive	<p>0...255</p>	<p>If the fan is switched-off in automatic or manual operation, it runs on for the time configured at this point, provided that a factor of more than "0" is set. This parameter applies to the controller operating mode "Heating" (if necessary, in the basic and additional levels).</p>
Cooling fan run-on time, *0.1 s, 0=Inactive	<p>0...255</p>	<p>If the fan is switched-off in automatic or manual operation, it runs on for the time configured at this point, provided that a</p>

		factor of more than "0" is set. This parameter applies to the controller operating mode "Cooling" (if necessary, in the basic and additional levels).
Fan protection	Yes No	The fan protection function allows the fan of a fan coil unit, which has not been active for some time, to be temporarily switched to the maximum level. In this way, the controller fan motors can be protected against stiffness. In addition, the fan blades and the heat exchanger of the fan coil unit are protected against dust against dust. If the fan protection is to be used, it must be enabled using the "Yes" setting at this point.
Start-up using level	Fan level OFF Fan level 1 Fan level 2 Fan level 3 Fan level 4 Fan level 5 Fan level 6 Fan level 7 Fan level 8	The fan can, if it was switched off before and should now start up, be switched on at a defined switch-on level. This switch-on level can be any of the available fan levels, and is set using this parameter. The switch-on level is usually one of the higher fan levels of a blower convector. The switch-on level remains active for the "Waiting time on level change-over" configured in the ETS. The parameter "Start-up via level" is not checked for plausibility in the ETS, meaning that an incorrect configuration is possible. For this reason, care should be taken to ensure that there is no switch-on level in the configuration which is higher than the actual fan levels. The fan controller automatically corrects a faulty parameterisation by activating level 1 for the start-up, meaning that the fan starts up normally without a switch-on level.
Command value is 0%, until internal command value is greater than, *1%	1...100	The command value evaluated by the fan controller in automatic operation can be optionally limited by this parameter in the bottom command value range.
Command value is 100%, as soon as internal command value is greater than, *1%	1... 99 ...100	The command value evaluated by the fan controller in Automatic mode can be optionally limited by this parameter in the top command value range.
	0... 100	

Command value offset,
*1%

The command value evaluated by the fan controller in Automatic mode can be optionally raised by the static offset configured here. Should the calculation produce a value of over 100 %, then the command value is limited to the maximum value.

□ Room temperature control -> Controller general -> Command value and status output

Automatic transmission at modification by
(0...100) * 1 %;
0 = inactive

This parameter determines the size of the command value change that will automatically transmit continuous command value telegrams via the command value objects. Thus this parameter only affects command values which are configured to "Continuous PI control" and to the 1 byte additional command value objects of the "Switching PI control (PWM)".

Cycle time of the switching command value
(1...255) * 1 min

This parameter specifies the cycle time for the pulse width modulated command value (PWM). Thus this parameter only affects command values which are configured to "Switching PI control (PWM)".

Cycle time for automatic transmission
(0...255) * 1 min;
0 = inactive

This parameter determines the time interval for the cyclical transmission of the command values via the command value objects. This parameter only affects command values which are configured to "Continuous PI control" or "Switching PI feedback control (PWM)".

Output of the heating variable

Inverted (under current, this means closed)

Normal (under current, this means opened)

At this point, it is possible to specify whether the command value telegram for heating is output normally or in inverted form. This parameter is only visible if the operating mode "Heating" or "Heating and cooling" is configured and not two-level operation.

Output of the command value basic level heating

Inverted (under current, this means closed)

Normal (under current, this means opened)

At this point, it is possible to specify whether the command value telegram for the heating basic level is output normally or in inverted form. This parameter is only visible if the operating mode "Heating" or "Heating and cooling" is configured along with two-level operation.

Output of the heating additional stage variable	<p>Inverted (under current, this means closed)</p> <p>Normal (under current, this means opened)</p>	<p>At this point, it is possible to specify whether the command value telegram for the heating additional level is output normally or in inverted form. This parameter is only visible if the operating mode "Heating" or "Heating and cooling" is configured along with two-level operation.</p>
Output of the cooling variable	<p>Inverted (under current, this means closed)</p> <p>Normal (under current, this means opened)</p>	<p>At this point, it is possible to specify whether the command value telegram for cooling is output normally or in inverted form. This parameter is only visible if the operating mode "Cooling" or "Heating and cooling" is configured and not two-level operation.</p>
Output of the command value basic level cooling	<p>Inverted (under current, this means closed)</p> <p>Normal (under current, this means opened)</p>	<p>At this point, it is possible to specify whether the command value telegram for the cooling basic level is output normally or in inverted form. This parameter is only visible if the operating mode "Cooling" or "Heating and cooling" is configured along with two-level operation.</p>
Output of the cooling additional stage variable	<p>Inverted (under current, this means closed)</p> <p>Normal (under current, this means opened)</p>	<p>At this point, it is possible to specify whether the command value telegram for the cooling additional level is output normally or in inverted form. This parameter is only visible if the operating mode "Cooling" or "Heating and cooling" is configured along with two-level operation.</p>
Command value limit	<p>Deactivated</p> <p>Continuously activated</p> <p>Can be activated via object</p>	<p>The command value limit allows the restriction of calculated command values to the range limits "minimum" and "maximum". The limits are permanently set in the ETS and, if command value limitation is active, can be neither undershot or exceeded during device operation. The "Command value limit" parameter defines the mode of action of the limiting function. The command value limit can either be activated or deactivated using the 1-bit communication object "Command value limit", or be permanently active.</p>

<p>Command value limit after reset</p>	<p>Deactivated Activated</p>	<p>When controlling via the object, it is possible to have the controller activate the command value limit automatically after bus voltage return or an ETS programming operation. This parameter defines the initialisation behaviour here. In the "Deactivated" setting, the command value limit is not automatically activated after a device reset. A "1" telegram must first be received via the "Command value limit" object for the limit to be activated. In the "Activated" setting, the controller activates the command value limit automatically after a device reset. To deactivate the limit a "0" telegram must be received via the "Command value limit" object. The limit can be switched on or off at any time using the object. This parameter is only visible with "Command value limit = can be activated via object"!</p>
<p>Minimum command value for heating (optionally also for basic and additional level)</p>	<p>5%, 10%, 15%, 20%, 25%, 30%, 35%, 40%, 45%, 50%</p>	<p>The "Minimum command value" parameter specifies the lower command value limiting value for heating. With an active command value limit, the set minimum command value is not undershot by command values. If the controller calculates smaller command values, it sets the configured minimum command value. The controller transmits a 0 % command value if no more heating or cooling energy has to be demanded.</p>
<p>Maximum command value for heating (optionally also for basic and additional level)</p>	<p>55%, 60%, 65%, 70%, 75%, 80%, 85%, 90%, 95%, 100%</p>	<p>The "Maximum command value" parameter specifies the upper command value limiting value for heating. With an active command value limit, the set maximum command value is not exceeded. If the controller calculates larger command values, it sets the configured maximum command value.</p>
<p>Minimum command value for cooling (optionally control circuit 1) (optionally also for basic and additional level)</p>	<p>5%, 10%, 15%, 20%, 25%, 30%, 35%, 40%, 45%, 50%</p>	<p>The "Minimum command value" parameter specifies the lower command value limiting value for cooling. With an active command value limit, the set minimum command value is not undershot by command values. If the controller calculates smaller command values, it sets the configured minimum command value. The controller transmits a 0 % command value if no more heating or cooling energy has to be demanded.</p>

<p>Maximum command value for cooling (optionally also for basic and additional level)</p>	<p>55%, 60%, 65%, 70%, 75%, 80%, 85%, 90%, 95%, 100%</p>	<p>The "Maximum command value" parameter specifies the upper command value limiting value for cooling. With an active command value limit, the set maximum command value is not exceeded. If the controller calculates larger command values, it sets the configured maximum command value.</p>
<p>Heating indication</p>	<p>Yes No</p>	<p>Depending on the set operating mode, a separate object can be used to signal whether the controller is currently demanding heating energy and is thus actively heating. The "Yes" setting here enables the message function for heating.</p>
<p>Cooling indication</p>	<p>Yes No</p>	<p>Depending on the set operating mode, a separate object can be used to signal whether the controller is currently demanding cooling energy and is thus actively cooling. The "Yes" setting here enables the message function for cooling.</p>
<p>Controller status</p>	<p>no status KNX compliant Controller general transmit individual state</p>	<p>The controller can output its current operating status. A distinction is made whether the status signal is transmitted to the bus via a 2 byte, via a 1 byte telegram or via a 1 bit telegram. In the "KNX-conformant" setting, various status signals of the controller are output as a collective signal via a 2-byte object. Each bit represents one piece of status information. The controller supports five of these status information items. In the "Controller general" setting, various status signals of the controller are output as a collective signal via an object of 1 byte. Each bit represents one piece of status information. In the setting "Transmit individual status", the controller status is transmitted onto the bus as a single 1 bit status signal. The "Single status" parameter specifies the status information to be transmitted individually.</p>
<p>Single status</p>	<p>Comfort mode Active Standby mode activated Night mode activated</p>	<p>Here, the status information is defined, which is to be transmitted onto the bus as the controller status. This parameter is only visible if the</p>

Frost/heat protection active
 Controller disabled
 Heating / cooling
 Controller inactive
 Frost alarm

parameter "Controller status" is set to "Transmit single status".

Behaviour when
 command value = 100%
 (Clipping mode PI
 control)

keep 100% until setpoint = actual, then 0%

keep 100% as required,
 then adjust downwards

If with a PI control the calculated command value of the controller exceeds the physical limits of the actuator, in other words if the calculated command value is greater than 100%, then the command value is set to the maximum value (100%) and thus limited. With PI control the command value can reach the value "100%" if there is a large deviation of the room temperature from the setpoint temperature or the controller requires a long time to adjust to the setpoint with the heating or cooling energy that is being applied. The controller can evaluate this state in a particular manner and react to it in various ways. This parameter defines the functions of the PI controller when the command value is 100%.

"keep 100% until setpoint = actual, then 0%" setting:

The controller keeps the maximum command value until the room temperature (actual value) reaches the setpoint temperature. After that, it reduces the command value down to 0% all at once (controller reset). The advantage of this control behaviour is that in this way sustainable heating up of undercooled rooms or effective cooling of overheated rooms will be achieved by overshooting the setpoint. The disadvantage is the in some circumstances the overshooting of the room temperature may be found disturbing.

Setting "keep 100% as required, then adjust downwards":

The controller maintains the maximum command value only as long as it is necessary. After that it adjusts the command value downwards according to the PI algorithm. The advantage of this control characteristic is the fact that the room temperature does not exceed the setpoint temperature at all, or only slightly. The disadvantage is that this control principle increases the tendency to oscillate about the setpoint.

□ Room temperature control -> Controller general -> Setpoints

<p>Overwrite setpoints in device after ETS programming operation?</p>	<p>Yes No</p>	<p>The temperature setpoints programmed in the room temperature controller by the ETS during commissioning can be changed via communication objects. This parameter can be used to define whether the setpoints present in the device, which may have been changed subsequently, are overwritten during an ETS programming operation and thus replaced again by the values parameterised in the ETS. If this parameter is on "Yes", then the temperature setpoints are deleted in the device during a programming operation and replaced by the values of the ETS. If this parameter is configured to "No", then setpoints present in the device remain unchanged. The setpoint temperatures entered in the ETS then have no significance.</p>
---	--------------------------	--

<p>Setpoint presetting</p>	<p>Relative (setpoint temperatures from basic setp.) Absolute (independent setpoint temperatures)</p>	<p>It is possible to configure the setpoints for the "Comfort", "Standby" and "Night" modes directly (absolute setpoint presetting) or relatively (derivation from basic setpoint). This parameter defines the way the setpoint temperature is preset. With "Relative": All temperature setpoints are derived from the basic temperature (basic setpoint). With "Absolute": The setpoint temperatures are independent of each other. Different temperature values can be specified for each operating mode and heating/cooling mode.</p>
----------------------------	---	--

<p>Basic temperature after reset (7 ... 40) * 1 °C</p>	<p>7...21...40</p>	<p>This parameter defines the temperature value to be applied as the basic setpoint after commissioning by the ETS. All the temperature setpoints are derived from the basic setpoint.</p>
--	---------------------------	--

<p>Value of the setpoint shift</p>	<p>0.1 K 0.5 K</p>	<p>This parameter defines the value of the setpoint shift. For a setpoint shift to remain in sensible steps when a new setpoint is received by the "Basic setpoint", it is adjusted to the step width to be adjusted. For example, in the case of a step value of 0.5 K for the setpoint shift, a received basic setpoint value is rounded in such a way that it has a 0 or 0.5 after the decimal point. This applies in the same way to step values of 0.1 K.</p>
------------------------------------	------------------------------------	--

Permanently apply change to basic setpoint shift

No
Yes

In addition to the setting of individual temperature setpoints via the ETS, the user is able to shift the basic setpoint within a settable range anytime via local control or via the basic setpoint object, either using the display buttons or with the "Setpoint shift" push button function, if this is configured to a function button of the push button sensor. Whether a basic setpoint shifting only affects the currently active operating mode or whether it influences all other setpoint temperatures of the remaining operating modes is determined by this parameter.

In the "Yes" setting, the shift of the basic setpoint carried out affects all operating modes. The shifting is maintained even after switching-over the operating mode or the heating/cooling mode or readjusting the basic setpoint.

In the "No" setting, the basic setpoint shift carried out is in effect for only as long as the operating mode or heating/cooling mode has not changed or the basic setpoint is maintained. Otherwise the setpoint shift will be reset to "0".

Changing of the basic temperature setpoint value via bus

deactivated
Approve

Here, it is possible to specify if it is possible to change the basic setpoint via the bus. In the "Approve" setting, the "Basic setpoint" object is visible in the ETS.

Accept modification of the basic temperature setpoint value permanently

No
Yes

One has to distinguish between two cases, defined by this parameter, if the basic setpoint has been modified (via local control or via the object): In the "Yes" setting, the controller saves the basic setpoint permanently in the EEPROM. The newly adjusted value will overwrite the basic temperature originally configured via the ETS after a reset! This is the only way to keep the adjusted basic setpoint even after change-over of the operating mode or after a reset.

In the "No" setting, the basic setpoint, which was set on the room temperature controller or received via the object, stays only temporarily active in the current operating mode. In case of a bus voltage failure or following a change-over to another operating mode (e.g.

		Comfort followed by Standby), the basic setpoint set via local control or received via the object will be discarded and replaced by the value which was originally configured in the ETS.
Frost protection setpoint temperature (7...40) * 1 °C	7...40	This parameter specifies the setpoint temperature for frost protection. The parameter is only visible in "Heating" or "Heating and cooling" operating modes (if necessary with additional levels).
Heat protection setpoint temperature (7...45) * 1 °C	7... 35 ...45	This parameter specifies the setpoint temperature for heat protection. The parameter is only visible in "Cooling" or "Heating and cooling" operating modes (if necessary with additional levels).
Dead band position	symmetrical asymmetrical	<p>The comfort setpoint temperatures for "Heating and cooling" operating modes are derived from the basic setpoint in consideration of the adjusted deadband. The deadband (temperature zone for which there is neither heating nor cooling) is the difference between the comfort setpoint temperatures.</p> <p>Symmetrical setting: the deadband preset in the ETS plug-in is divided in two parts at the basic setpoint. The comfort setpoint temperatures are derived directly from the basic setpoint resulting from the half deadband (Basic setpoint - 1/2 deadband = Heating comfort temperature or Basic setpoint + 1/2 deadband = Cooling comfort temperature).</p> <p>Asymmetrical setting: with this setting the comfort setpoint temperature for heating equals the basic setpoint! The preset deadband is effective only from the basic setpoint in the direction of comfort temperature for cooling. Thus the comfort set-temperature for cooling is derived directly from the comfort setpoint for heating.</p> <p>The parameter is only visible in "Heating and cooling" operating modes (if necessary with additional levels).</p>
Deadband between heating and cooling (0...127) * 0.1 K	0... 20 ...127	The comfort setpoint temperatures for heating and cooling are derived from the basic setpoint in consideration of the adjusted deadband. The deadband (temperature zone for which there is

<p>Difference between basic and additional levels (0...127) * 0.1 K</p>	<p>0...20...127</p>	<p>neither heating nor cooling) is the difference between the comfort setpoint temperatures. It is set using this parameter. The parameter is only visible in "Heating and cooling" operating modes (if necessary with additional levels).</p>
<p>Transmission at setpoint temperature change by (0...255) * 0.1 K</p>	<p>0...1...255</p>	<p>Determines the size of the value change required to automatically transmit the current value via the "Setpoint temperature" object. In the "0" setting, the setpoint temperature is not transmitted automatically when there is a change.</p>
<p>Cyclical transmission of setpoint temperature (0...255) * 1 min; 0 = inactive</p>	<p>0...255</p>	<p>This parameter determines whether the setpoint temperature is to be transmitted periodically via the "Setpoint temperature" object. Definition of the cycle time by this parameter In the "0" setting, the setpoint temperature is not transmitted automatically cyclically.</p>
<p>Lower the setpoint temperature during Standby operating mode (heating) (-128...0) * 0.1 K</p>	<p>-128...-20...0</p>	<p>The value by which the standby setpoint temperature for heating is lowered compared to the heating comfort temperature. The parameter is only visible in "Heating" or "Heating and cooling" operating modes (if necessary with additional levels).</p>
<p>Lower the setpoint temperature during Night mode (heating) (-128...0) * 0.1 K</p>	<p>-128...-40...0</p>	<p>The value by which the night setpoint temperature for heating is lowered compared to the heating comfort temperature. The parameter is only visible in "Heating" or "Heating and cooling" operating modes (if necessary with additional levels).</p>

<p>Raise the setpoint temperature during Standby operating mode (cooling) (0...127) * 0.1 K</p>	<p>0...20...127</p>	<p>The value by which the standby setpoint temperature for cooling is lowered compared to the cooling comfort temperature. The parameter is only visible in "Cooling" or "Heating and cooling" operating modes (if necessary with additional levels).</p>
<p>Raise the setpoint temperature during Night mode (cooling) (0...127) * 0.1 K</p>	<p>0...40...127</p>	<p>The value by which the night temperature for cooling is lowered compared to the cooling comfort temperature. The parameter is only visible in "Cooling" or "Heating and cooling" operating modes (if necessary with additional levels).</p>
<p>Setpoint temperature limit in cooling operation</p>	<p>No limit Only difference to outdoor temperature Only max. setpoint temperature Max. setpoint and difference to outdoor temperature</p>	<p>Optionally, the setpoint temperature limit can be enabled here, which is only effective in cooling operation. If necessary, the controller limits the setpoint temperature to specific values and prevents an adjustment beyond the limits. "Only difference to outdoor temperature" setting, the outdoor temperature is monitored and compared to the active setpoint temperature in this setting. The specification of the maximum temperature difference to the outdoor temperature is made using the "Difference to outdoor temperature in cooling mode" parameter. If the outdoor temperature rises above 32 °C, then the controller activates the setpoint temperature limit. It then permanently monitors the outdoor temperature and raises the setpoint temperature so that is beneath the outdoor temperature by the amount configured. Should the outdoor temperature continue rise, the controller raises the setpoint temperature until the required difference to the outdoor temperature is achieved, or, at most, the heat protection temperature. It is then not possible to undershoot the raised setpoint, e.g. by changing the basic setpoint change. The change to the setpoint temperature limit is temporary. It only applies for as long as the outdoor temperature exceeds 32 °C.</p>

"Only max. setpoint temperature" setting: In this setting, no setpoint temperatures are permitted in Cooling mode related to the Comfort, Standby and Night modes, which are greater than the maximum setpoints configured in the ETS. The maximum temperature setpoint is specified by the "Max. setpoint temperature in cooling operation" parameter. With an active limit, no larger setpoint can be set in cooling operation, e.g. by a basic setpoint change or a setpoint shift. However, heat protection is not influenced by the setpoint temperature limit.

"Max. setpoint temperature and difference to outdoor temperature" setting: This setting is a combination of the two above-mentioned settings. In the downward direction, the setpoint temperature is limited by the maximum outdoor temperature difference, whilst in the upward direction, the limit is made by the maximum setpoint. The maximum setpoint temperature has priority over the outdoor temperature difference. This means that the controller keeps on raising the setpoint temperature upwards according to the difference to the outdoor temperature configured in the ETS until the maximum setpoint temperature or the heat protection temperature is exceeded. Then the setpoint is limited to the maximum value.

Activation of the setpoint temperature limit in cooling operation via object

No
Yes

A setpoint limit enabled in the ETS can be activated or deactivated as necessary using a 1-bit object. For this, this parameter can be set to "Yes". In this case, the controller only takes the setpoint limit into account, if it has been enabled via the object "Cooling setpoint temp. limit" ("1" telegram). If the limitation is not enabled ("0" telegram), the cooling setpoint temperatures are not limited.

This parameter is visible only if setpoint temperature monitoring is enabled.

Difference to outdoor temperature in cooling operation

1 K...**6 K**...15 K

This parameter defines the maximum difference between the setpoint temperature in Comfort mode and the outdoor temperature with an active setpoint temperature limit.

This parameter is visible only if setpoint temperature monitoring is enabled.

Max. setpoint temperature in cooling operation	20°C... 26°C ...35°C	However, this is only if the parameter "Setpoint temperature limit in cooling operation" is then set to "Only difference to outdoor temperature" or "Max. setpoint temperature and difference to outdoor temperature".
Change-over between heating and cooling	Automatic Via object (heating/cooling change-over)	In a configured mixed mode it is possible to switch over between heating and cooling. With "Automatic": Depending on the operating mode and the room temperature, the change-over takes place automatically. With "Via object (heating/cooling change-over)": The change-over takes place only via the object "Heating / cooling change-over". With automatic setpoint presetting this parameter is permanently set to "Via object (heating/cooling switch-over)".
Heating / cooling operating mode after a reset	Heating Cooling Operating mode before reset	The preset operating mode for after the return of the bus voltage is specified here. Only visible if "Change-over between heating and cooling = via object".
Automatic heating/cooling transmission switchover	On changing the operating mode On changing the output value	Here, it is possible to specify when a telegram is transmitted automatically onto the bus via the object "Heating / cooling change-over". Only visible if "Change-over between heating and cooling = automatic".
Cyclical transmission heating/cooling switch-over (0...255) * 1 min; 0 = inactive	0...255	This parameter specifies whether the current object status of the "Heating / cooling change-over" object should be output cyclically to the bus on an automatic change-over. The cycle time can be set here. The "0" setting deactivates the periodic transmission of

		the object value. Only visible if "Change-over between heating and cooling = automatic".
Step width of the 4-level setpoint shift	0.5 K 1.0 K 1.5 K 2.0 K	This parameter defines the value of a level of the basic setpoint shift. The basic setpoint can be shifted by up to 4 levels.
Upward adjustment of the basic setpoint temperature (0...10) * 1 K	0 K + 1 K + 2 K + 3 K + 4 K + 5 K + 8 K + 9 K + 10 K	This is used to define the maximum range in which the basic setpoint temperature can be adjusted upwards. This parameter is only visible with relative setpoint presetting!
Downward adjustment of the basic setpoint temperature (0...10) * 1 K	0 K - 1 K - 2 K - 3 K - 4 K - 5 K - 8 K - 9 K - 10 K	This is used to define the maximum range in which the basic setpoint temperature can be adjusted downwards. This parameter is only visible with relative setpoint presetting!
☐ Room temperature control -> Controller functionality		
Presence detection	Presence button Presence detector	In the "Presence button" setting, presence detection takes place using a button on the device or via the presence object (e.g. other push-button sensors). When the presence button is pressed, the comfort extension is activated. In the "Presence detector" setting, presence detection takes place using an external presence detector, coupled to the presence object. Comfort mode is recalled when a presence is detected. Comfort mode remains active until the presence detector ceases to detect movement. In this setting, a presence button on the device has no function.
Length of the comfort extension (0 .. 255) * 1 min; 0 = OFF	0... 30 ...255	When the presence button is pressed, the controller switches to Comfort mode for the length of time specified here. When this time has elapsed, it switches back automatically. In the "0" setting, the comfort extension is switched off, meaning that it cannot be activated from

Switch off controller (dew point operation)	No via bus	Night or Frost/heat protection mode. In this case, the operating mode will not be changed, although the presence function has been activated. This parameter is only visible when presence detection is configured to "Presence button".
Valve protection	No Yes	This parameter enables the "Disable controller" object. If the controller is disabled, there is no feedback control until enabled (command values = 0). An activated controller disable (dew point operation) is shown in the display. Valve protection may be carried out periodically in order to prevent the addressed control valves of the heater or cooling system from becoming calcified or stuck. The "Yes" setting in this parameter activates valve protection. This type of protection is generally started not only for non-active command value outputs, i.e. for outputs which have not requested any heating or cooling energy over the past 24 hours. For these outputs, the controller will periodically set the command value to the maximum value once a day for a duration of approx. 5 minutes.
Underfloor heating temperature limit (Only effective in heating mode!)	not present present	The temperature limit can be activated in the controller in order to protect an underfloor heating system. If the temperature limit is enabled here ("Present" setting), the controller continuously monitors the floor temperature. Should the floor temperature exceed a specific limiting value on heating, the controller immediately switches the command value off, thus switching the heating off and cooling the system. Only when the temperature falls below the limiting value, minus a hysteresis of 1 K, will the controller add the most recently calculated command value. The floor temperature is fed to the controller using a separate object. It should be noted that the temperature limit only affects command values for heating. Thus, the temperature limit requires the controller operating modes "Heating" or "Heating and cooling".

Effect on

Heating, basic level
Heating, additional level

The temperature limit can also be used in a two-level feedback control with basic and additional levels. It must then be specified here to which level the limit shall apply. Either the basic level or to the additional level for heating can be limited.

This parameter can only be set in two-level control operation.

Maximum temperature, 20...**30**...70
underfloor heating
* 1 °C

The maximum limit temperature which the underfloor heating system may reach is specified here. If this temperature is exceeded, the controller switches the underfloor heating system off using the command value. As soon as the floor temperature has fallen 1 K under the limit temperature, the controller switches the command value on again, assuming that this is intended in the control algorithm. The 1 K hysteresis is fixed and cannot be changed.

4.2.5.3.2 Controller extension

Description	Values	Comment
<p>☐ Room temperature control (addition for controller extension)</p>		
Value request from controller extension?	<p>Yes</p> <p>No</p>	<p>To ensure that all the objects are updated correctly, some communication objects of the controller extension can also initialise automatically after a device restart. For this, this parameter can be set to "Yes". The update then takes place after a reset by means of a ValueRead telegram to the room temperature controller. This must answer the request with a ValueResponse telegram.</p>
Operating mode	<p>Heating</p> <p>Cooling</p> <p>Heating and cooling</p>	<p>Besides the operating function, the controller extension also possesses a display function. As on the main controller, various items of status information of the temperature controller can be shown on the device display. As the displayed states and information and also some operating functions are strongly dependent on the parameterisation of the main controller, the controller extension must also be configured and thus match the functions of the main controller.</p> <p>If should be ensured that the settings match those of the main controller. Due to the controller operating mode setting, some parameters may not be visible.</p>
Controller status	<p>no status</p> <p>KNX compliant</p> <p>Controller general</p>	<p>Besides the operating function, the controller extension also possesses a display function. As on the main controller, various items of status information of the temperature controller can be shown on the device display. As the displayed states and information and also some operating functions are strongly dependent on the parameterisation of the main controller, the controller extension must also be configured and thus match the functions of the main controller.</p> <p>If should be ensured that the settings match those of the main controller. A distinction is made whether the status signal is transmitted to the bus via a 2 byte, via a 1 byte telegram or via a 1 bit telegram. In the "KNX-conformant" setting, various status signals of the controller are output as a collective signal via a 2-byte object. Each bit</p>

		represents one piece of status information. The controller supports five of these status information items. In the "Controller general" setting, various status signals of the controller are output as a collective signal via an object of 1 byte. Each bit represents one piece of status information.
Sending command value for heating and cooling to a shared object	Yes No	If the parameter is set to "Yes", the command value will be transmitted on a shared object during heating or cooling. This function is used, if the same heating system is used to cool the room in the summer and used to heat the room in the winter. This parameter is only visible with "heating and cooling" mixed operating mode, if applicable, with additional levels.
Type of heating control	continuous PI control switching PI control (PWM) 2-point feedback control	Selecting a feedback control algorithm (PI or 2-point) with data format (1-byte or 1-bit) for the heating system. This parameter is only visible if the operating mode "Heating" or "Heating and cooling" is configured and when the command values for heating and cooling are transmitted via two separate objects.
Type of cooling control	continuous PI control switching PI control (PWM) 2-point feedback control	Selecting a feedback control algorithm (PI or 2-point) with data format (1-byte or 1-bit) for the cooling system. This parameter is only visible if the operating mode "Cooling" or "Heating and cooling" is configured and when the command values for heating and cooling are transmitted via two separate objects.
Type of control	continuous PI control switching PI control (PWM) 2-point feedback control	Selecting a feedback control algorithm (PI or 2-point) with data format (1 byte or 1 bit). This parameter is only visible if the operating mode "Heating and cooling" is configured and when the command values for heating and cooling are transmitted via two separate objects.
Output of the heating variable	normal (under current, this means opened) inverted (under current, this means closed)	At this point, it is possible to specify whether the command value telegram for heating is output normally or in inverted form. This parameter is only visible if the operating mode "Heating" or "Heating and cooling" is configured and when the command values for heating and cooling are transmitted via

		two separate objects.
Output of the cooling variable	<p>normal (under current, this means opened)</p> <p>inverted (under current, this means closed)</p>	At this point, it is possible to specify whether the command value telegram for cooling is output normally or in inverted form. This parameter is only visible if the operating mode "Cooling" or "Heating and cooling" is configured and when the command values for heating and cooling are transmitted via two separate objects.
Output of the command value	<p>normal (under current, this means opened)</p> <p>inverted (under current, this means closed)</p>	At this point, it is possible to specify whether the command value telegram for cooling is output normally or in inverted form. This parameter is only visible if the operating mode "Heating and cooling" is configured and when the command values for heating and cooling are transmitted via two separate objects.
Step width of the 4-level setpoint shift	<p>0.5 K</p> <p>1.0 K</p> <p>1.5 K</p> <p>2.0 K</p>	This parameter defines the value of a level of the basic setpoint shift. The basic setpoint can be shifted by up to 4 levels.
Fan controller available	<p>Yes</p> <p>No</p>	The controller extension can be supplemented with a fan controller using this parameter. By enabling the fan controller ("Yes" setting), it is possible to control the fan from heating and cooling systems operated by circulating air, such as fan coil units (FanCoil units), depending on the command value calculated in the controller or using manual operation. When the function is enabled, additional parameters will appear in the ETS as well as additional communication objects. Fan control is not possible with switching 2-point feedback control.
Number of fan levels	<p>No fan levels</p> <p>1 fan level</p> <p>2 fan levels</p> <p>3 fan levels</p> <p>4 fan levels</p> <p>5 fan levels</p> <p>6 fan levels</p> <p>7 fan levels</p> <p>8 fan levels</p>	The fan controller of the controller extension supports up to 8 fan level outputs, for which the actually used number of levels (1...8) is set using this parameter.

4.2.5.4 Parameter group "Room temperature measurement"

Description	Values	Comment
<p>The product database of the device contains three independent blocks for temperature measurement. Up to three temperatures can be determined in parallel, depending on whether the TSM is alone, is combined with a TSEM and/or with a connected remote sensor. Each temperature measurement can be performed by the internal sensor or, optionally, by a received temperature value. Combined temperature recording (internal sensor + received temperature value) can also be configured.</p>		
□- TSM		
□- TSEM		
□- Remote sensor		
Room temperature measurement	<p>enabled</p> <p>Disabled</p>	<p>On the parameter pages "TSM", "TSEM" and "Remote sensor", this parameter decides whether the module is used for room temperature measurement. Measurement can take place using the internal sensor of the module/the remote sensor or a temperature value received via KNX, as well as with a combination of both methods. When room temperature measurement is enabled, the parameters and objects are also enabled. The precondition for room temperature measurement using a remote sensor is that a remote sensor is connected to the device.</p>
Temperature detection through	<p>internal temperature sensor</p> <p>received temperature value</p> <p>internal sensor and received temperature value</p>	<p>This parameter specifies which sensor is used for room temperature measurement. With the setting "Internal sensor" only the temperature sensor integrated in the device detects the room temperature. With the setting "Received temperature value", only a KNX/EIB temperature sensor (e.g. controller extension) coupled via the "External temperature" object detects the room temperature. With the setting "Internal sensor and received temperature value", the KNX/EIB temperature sensor (e.g. controller extension) integrated into the device and coupled via the "External temperature" object detects the room temperature.</p>
Determination of measured value from internal / external ratio	<p>10% to 90%</p> <p>20% to 80%</p> <p>30% to 70%</p> <p>40% to 60%</p> <p>50% to 50%</p>	<p>The weighting of the measured temperature value for the internal and external sensors is specified here. That results in an overall value, which will be used for the further interpretation of the</p>

	60% to 40% 70% to 30% 80% to 20% 90% to 10%	room temperature.
Internal sensor calibration (-128...127) * 0.1 K	-128... 13 ...127	Determines the value by which the internal sensor's room temperature value is calibrated. This parameter is only visible when the temperature detection system requires an internal sensor.
External sensor calibration (-128...127) * 0.1 K	-128... 0 ...127	Determines the value by which the external sensor's room temperature value is calibrated. This parameter is only visible when the temperature detection system requires an external sensor.
Scanning time for external sensor (0...255) * 1 min; 0 = inactive	0 ... 255	The polling time for the external sensor's temperature value is specified here. In the "0" setting, the external sensor is not automatically polled by the controller. In this case, the sensor must transmit its temperature value itself.
Transmission when room temperature change by (0..255) * 0.1 K; 0 = No automatic transmission	0 ... 255, 3	Determines the size of the value change of the room temperature after which the current values are automatically transmitted on the bus via the "Actual temperature" object.
Cyclical transmission of room temperature (0...255) * 1 min; 0 = inactive	0 ... 255, 15	This parameter specifies whether and when the determined room temperature is to be periodically output via the "Actual temperature" object.

4.2.5.5 Parameter group "Disabling"

Description	Values	Comment
<p>☐↵ push-button sensor -> Disable</p> <p>Disabling function?</p>	<p>Yes</p> <p>No</p>	<p>With this parameter, the disabling function of the push-button sensor can be centrally activated. If "Yes", the ETS shows further communication object and parameters.</p>
<p>Polarity of disabling object</p>	<p>disable = 1 / enable = 0</p> <p>Disable = 0 / enable = 1</p>	<p>This parameter defines the value of the disabling object at which the disabling function is active.</p>
<p>Button assignment of the buttons for disabling function</p>	<p>all buttons assigned (TSM + TSEM)</p> <p>individual buttons assigned</p>	<p>The "All buttons assigned (TSM + TSEM)" option assigns all the buttons of the TSM and all the buttons of any connected TSEM to the disabling function. The "Individual buttons assigned" option enables the parameter "Disabling button selection". On this parameter page, the decision can be taken separately for each button as to whether this button is subordinate to the disabling function or not.</p>
<p>Reaction of push-button sensor (TSM + TSEM) at start of disabling</p>	<p>No reaction</p> <p>Reaction as button >>X<< when pressed</p> <p>Reaction as button >>X<< when released</p> <p>Reaction as disabling function 1 when pressed</p> <p>Reaction as disabling function 1 when released</p> <p>Reaction as disabling function 2 when pressed</p> <p>Reaction as disabling function 2 when released</p> <p>internal scene recall scene 1</p> <p>internal scene recall scene 2</p> <p>internal scene recall scene 3</p>	<p>Besides disabling of rocker and button functions, the push-button sensor can also and in addition trigger a specific function at the time of activation of the disabling state.</p> <p>This function can... correspond to the function assigned to any of the buttons in the non-disabled state ("Reaction as button >>X<< ..."), be defined on the following parameter pages ("Reaction as disabling function ..."), recall a scene stored internally in the push-button sensor ("Internal scene recall ...").</p>

	internal scene recall scene 4	
	internal scene recall scene 5	
	internal scene recall scene 6	
	internal scene recall scene 7	
	internal scene recall scene 8	
Button >> X <<	Button 1 (TSM) Button 2 (TSM) ... Button 16 (TSEM - if present)	<p>If the push-button sensor is to perform the function of a specific button at the beginning of the disabling state, this button will be selected here.</p> <p>Visible only if "Reaction of push-button sensor at the beginning of the disabling function = Reaction as button >>X<< on pressing / releasing"!</p>
Behaviour during active disabling	no reaction to button-press Reaction to a button-press like...	<p>While disabling is active... all buttons or only individually selected buttons can be disabled ("no function on button-press"), all buttons or only individually selected buttons can be restricted to a specific function ("reaction to button-press as..."). In this case, the ETS shows further parameters.</p>
All assigned left buttons (TSM + TSEM) behave as	Button 1 (TSM) Button 2 (TSM) ... Button 16 (TSEM) Disabling function 1 Disabling function 2	<p>If a specific button function is to be assigned during disabling to all or to individual buttons, this parameter can be used to select the desired button the function of which will then be executed. During disabling, all the buttons with an odd button number behave like the one configured here.</p> <p>The desired functions can either correspond to the function of an existing button or they can be configured as special disabling functions.</p> <p>Visible only if "Behaviour during active disabling = all buttons behave as" or "Behaviour during active disabling = individual buttons behave as"!</p>
	Button 1 (TSM) Button 2 (TSM)	<p>If a specific button function is to be assigned during disabling to all or to</p>

<p>All assigned right buttons (TSM + TSEM) behave as</p>	<p>... Button 16 (TSEM) Disabling function 1 Disabling function 2</p>	<p>individual buttons, this parameter can be used to select the desired button the function of which will then be executed. During disabling, all the buttons with an even button number behave like the one configured here. The desired functions can either correspond to the function of an existing button or they can be configured as special disabling functions. Visible only if "Behaviour during active disabling = all buttons behave as" or "Behaviour during active disabling = individual buttons behave as"!</p>
<p>Reaction of push-button sensor (TSM + TSEM) at the end of disabling</p>	<p>No reaction Reaction as button >>Y<< when pressed Reaction as button >>Y<< when released Reaction as disabling function 1 when pressed Reaction as disabling function 1 when released Reaction as disabling function 2 when pressed Reaction as disabling function 2 when released internal scene recall scene 1 internal scene recall scene 2 internal scene recall scene 3 internal scene recall scene 4 internal scene recall scene 5 internal scene recall scene 6 internal scene recall scene 7 internal scene recall scene 8</p>	<p>Besides disabling of rocker and button functions, the push-button sensor can also trigger a special function immediately at the end of disabling. This function can... correspond to the function assigned to any of the buttons in the non-disabled state ("Reaction as button >>Y<< ..."), be defined on the following parameter pages ("Reaction as disabling function ..."), recall a scene stored internally in the push-button sensor ("Internal scene recall ...").</p>

Button >>Y<<

Button 1
 Button 2
 ...
 Button 16 (TSEM - if present)

If the push-button sensor is to perform the function of a specific button at the end of the disabling state, this button will be selected here.

Only visible if "Reaction of push-button sensor at the end of disabling = Reaction as button >>Y<< on pressing / releasing"!

Disable - Button selection (Only visible with "Button assignment of the buttons for disabling function" = "Individual buttons assigned"!)</p>
</div>
<div data-bbox="138 292 337 334" data-label="Text">
<p>Selection of the buttons for behaviour during disabling</p>
</div>
<div data-bbox="138 338 228 368" data-label="Text">
<p>Button 1? (TSM)</p>
</div>
<div data-bbox="352 338 390 367" data-label="Text">
<p>Yes
 No</p>
</div>
<div data-bbox="138 391 228 420" data-label="Text">
<p>Button 2? (TSM)</p>
</div>
<div data-bbox="352 378 390 406" data-label="Text">
<p>Yes
 No</p>
</div>
<div data-bbox="138 446 162 459" data-label="Text">
<p>...</p>
</div>
<div data-bbox="352 443 390 471" data-label="Text">
<p>Yes
 No</p>
</div>
<div data-bbox="138 469 306 500" data-label="Text">
<p>Button 16? (TSEM - if present)*</p>
</div>
<div data-bbox="588 338 928 394" data-label="Text">
<p>The user can specify for each button separately whether it will be affected by the disabling function during the disabling state.</p>
</div>
<div data-bbox="588 410 936 504" data-label="Text">
<p> *: The number of buttons depends on the configured pushbutton sensor variant! Moreover, the extension module buttons can only be selected here if a corresponding extension module is also connected to the basic device.</p>
</div>
<div data-bbox="138 533 881 575" data-label="Text">
<p><input type="checkbox"/> Disabling function 1 disable / Disabling function 2 disable. With the exception of the controller operation and status LED control, the parameters available for the two disabling functions are the same as those for the button functions.</p>
</div>
<div data-bbox="138 605 918 648" data-label="Text">
<p>The same functions, parameters and settings as in the push-button sensor basic module TSM are available for the push-button sensor extension module TSEM. Thus, the settings in the extension module are independent of the settings in the basic module.</p>
</div>
<hr/>
<div data-bbox="138 951 369 983" data-label="Page-Footer">
<p>Art. No. ..5192KRMTSD
 Art. No. ..5194KRMTSD</p>
</div>
<div data-bbox="769 962 938 981" data-label="Page-Footer">
<p>Page 293 of 310</p>
</div>

4.2.5.6 Parameter group "Scenes"

Description	Values	Comment
<input type="checkbox"/> Scene output 1		
Scene function ?	Yes No	The device can internally handle eight scenes with eight actuator groups. This parameter activates the scene function and the other parameters and communication objects, if needed.
Overwrite scene values during ETS download	Yes No	If the values of the actuator groups that have been changed on site by the used are to be reset to the values preset in the ETS during an application download by the ETS, the setting "Yes" must be chosen. If "No" is selected, the ETS values will not overwrite the scene values stored in the push-button sensor, if any.
Data types scene output 1 ... 8	Switching Value (0 ... 255) Value / position of Venetian blind (0 ... 100%) Scene extension (1...64)	Selection of the data format of the scene output.

Scene output 2 ... 8 (see Scene output 1)

The following parameters can be designed on the parameter pages "Scene 1", "Scene 2," ..., "Scene 8".

<input type="checkbox"/> Scenes		
Name of the scene (max. 40 characters)	Scene 1	This text parameter describes the name of the scene in the ETS. The name entered here is output in the structure view of the parameters, supplementing the previously entered text.
Recall via extension object with scene number	1 ... 64	If the internal scenes are to be recalled via the extension object, a definite number is required for each of them. This parameter serves to specify the extension number of the first scene.

☐ Scene output 1 ... 8 for data type "Switching"

Scene output 1

Switching command **ON**
 OFF

Here, it is possible to predefine the switching command of scene output 1 when scene 1 is recalled via the extension object.
 This parameter is only visible if "Data type (scene output 1) = Switching".

Allow save? **Yes**
 No

If the user is to be given the possibility of changing the value of the scene and of storing it while the system is running, this parameter must be set to "Yes".

Allow transmission? **Yes**
 No

If the state of an actuator group is to remain unchanged during the recall of a scene, this parameter can be set to "No". In this case, the push-button sensor does not transmit a telegram via the scene output concerned during the recall of the scene. The scene output is deactivated for this scene.

Scene 1 **0...1200**
 Transmit delay
 (1 ... 1200 * 100 ms)
 (0 = deactivated)

When the push-button sensor sends the telegrams to the various scene outputs, it can insert a presettable waiting time of 2 min. max. before each telegram. The bus load can be reduced by this. In this way, it is possible to have certain illumination switched on only after the shutters are really closed.
 If no delay is selected ("0" setting), the push-button sensor sends the output telegrams with maximum speed. With this setting it may happen in some cases that the telegram sequence is not compatible with output numbering.

Scene output 2...8 like
 Scene output 1!

☐ Scene output 1 ... 8 for data type "Value (0...255)"

Scene output 1

Scene 1 **0...255**
 Value (0 ... 255)

Here, it is possible to predefine the value of scene output 1 when scene 1 is recalled via the extension object.
 This parameter is only visible if "Data type (scene output 1) = Value (0...255)".

Allow save?

If the user is to be given the possibility of changing the value of the scene and of

	Yes	storing it while the system is running, this parameter must be set to "Yes".
	No	
Allow transmission?	Yes	If the state of an actuator group is to remain unchanged during the recall of a scene, this parameter can be set to "No". In this case, the push-button sensor does not transmit a telegram via the scene output concerned during the recall of the scene. The scene output is deactivated for this scene.
	No	
Scene 1 Transmit delay (1 ... 1200 * 100 ms) (0 = deactivated)	0...1200	When the push-button sensor sends the telegrams to the various scene outputs, it can insert a presettable waiting time of 2 min. max. before each telegram. The bus load can be reduced by this. In this way, it is possible to have certain illumination switched on only after the shutters are really closed. If no delay is selected ("0" setting), the push-button sensor sends the output telegrams with maximum speed. With this setting it may happen in some cases that the telegram sequence is not compatible with output numbering.
Scene output 2...8 like Scene output 1!		
<input type="checkbox"/> Scene output 1 ... 8 for data type "Value / Venetian blind position (0...100%)"		
Scene output 1		
Scene 1 Value / position of Venetian blind (0 ... 100 %)	0...100	Here, it is possible to predefine the value of scene output 1 when scene 1 is recalled via the extension object. This parameter is only visible if "Data type (scene output 1) = Value / Venetian blind (0...100%)".
Allow save?	Yes	If the user is to be given the possibility of changing the value of the scene and of storing it while the system is running, this parameter must be set to "Yes".
	No	
Allow transmission?	Yes	If the state of an actuator group is to remain unchanged during the recall of a scene, this parameter can be set to "No". In this case, the push-button sensor does not transmit a telegram via the scene output concerned during the recall of the scene. The scene output is deactivated for this scene.
	No	

<p>Scene 1 Transmit delay (1 ... 1200 * 100 ms) (0 = deactivated)</p>	<p>0...1200</p>	<p>When the push-button sensor sends the telegrams to the various scene outputs, it can insert a presettable waiting time of 2 min. max. before each telegram. The bus load can be reduced by this. In this way, it is possible to have certain illumination switched on only after the shutters are really closed. If no delay is selected ("0" setting), the push-button sensor sends the output telegrams with maximum speed. With this setting it may happen in some cases that the telegram sequence is not compatible with output numbering.</p>
---	------------------------	--

Scene output 2...8 like
Scene output 1!

Scene output 1 ... 8 for data type "Scene extension (1...64)"

Scene output 1

<p>Scene number</p>	<p>1 ... 64</p>
---------------------	------------------------

Here, it is possible to predefine the scene number of scene output 1 to be recalled when scene 1 is recalled via the extension object.
This parameter is only visible if "Data type (scene output 1) = Scene extension (1...64)".

Allow save?

Yes

No

If the user is to be given the possibility of changing the value of the scene and of storing it while the system is running, this parameter must be set to "Yes".

Allow transmission?

Yes

No

If the state of an actuator group is to remain unchanged during the recall of a scene, this parameter can be set to "No". In this case, the push-button sensor does not transmit a telegram via the scene output concerned during the recall of the scene. The scene output is deactivated for this scene.

<p>Scene 1 Transmit delay (1 ... 1200 * 100 ms) (0 = deactivated)</p>	<p>0...1200</p>
---	------------------------

When the push-button sensor sends the telegrams to the various scene outputs, it can insert a presettable waiting time of 2 min. max. before each telegram. The bus load can be reduced by this. With a sensibly designed transmission delay, it is possible, for example, to switch on the lighting only when the roller shutter is already closed.

If no delay is selected ("0" setting), the push-button sensor sends the output telegrams with maximum speed. With this setting it may happen in some cases that the telegram sequence is not compatible with output numbering.

Scene output 2...8 like
Scene output 1!

4.2.5.7 Parameter group "Alarm"

Description	Values	Comment
<p>□↵ Push-button sensor -> Alarm signalling</p> <p>Alarm signal display</p>	<p>activated</p> <p>deactivated</p>	<p>This parameter can be used to enable alarm signal displaying.</p> <p>When alarm signalling is enabled, the ETS displays further parameters and up to two further communication objects.</p>
<p>Polarity of the alarm signalling object</p>	<p>Alarm when ON and Alarm reset when OFF</p> <p>Alarm when OFF and Alarm reset when ON</p>	<p>The alarm signalling object is used as an input for activating or deactivating alarm signal displaying.</p> <p>If the object value corresponds to the "Alarm" state, all status LEDs and the operation LEDs flash with a frequency of approx. 2 Hz.</p> <p>If the setting is "Alarm when OFF and alarm reset when ON", the object must first be actively written by the bus with "0" to activate the alarm after a reset.</p> <p>An alarm signal is not stored so that the alarm signalling is generally deactivated after a reset or after programming with the ETS.</p>
<p>Reset alarm signalling by a button actuation?</p>	<p>Yes</p> <p>No</p>	<p>If this parameter is set to "Yes", active alarm signal displaying can be deactivated by a button actuation on the push-button sensor.</p> <p>This button function does not cause the configured function of the pressed button to be executed. Only after the next button-press will the configuration of the button be evaluated and a telegram be transmitted to the bus, if applicable.</p> <p>If "No" has been selected, alarm signalling can only be deactivated via the alarm signalling object. A button-press will always execute the configured button function.</p>
<p>Use the alarm acknowledge object?</p>	<p>Yes</p> <p>No</p>	<p>If alarm signalling can be deactivated by a button actuation, this parameter defines whether an additional alarm acknowledge telegram is to be transmitted to the bus via the separate object "Alarm signalling acknowledge" after triggering by this button-press.</p> <p>A telegram can, for instance, be sent via this object to the "Alarm signalling"</p>

objects of other push button sensors in order to reset the alarm status there as well (observe the polarity of the acknowledge object!).

Acknowledge alarm signalling by

OFF telegram
ON telegram

This parameter sets the polarity of the "Alarm signalling acknowledge" object. This parameter presetting depends on the selected polarity of the alarm message object.

4.2.5.8 "Display" parameter group

Description	Values	Comment
□↵ Display		
Backlighting	<p>Always off</p> <p>always On</p> <p>Switch on through button-press</p> <p>Switch on in night mode</p> <p>Switch on through button-press or Night mode</p> <p>Switch on through switching object</p> <p>Switch on through inverted switching object</p> <p>Switch on through button-press or switching object</p> <p>Switch on through button-press or inv. switching object</p> <p>Switch on through value object (0%...100%)</p> <p>Switch on through button-press or value object (0%...100%)</p>	<p>The backlighting can be permanently on or off or alternatively be switched according to events. If the lighting is switched on by pressing a operating area (rocker or button), the device switches the lighting off automatically when the switch-off time configured in the ETS elapses. The switch-off time is retriggered each time a control surface is actuated.</p> <p>If the lighting is to be switched on in the "Night" operating mode, the lighting remains switched on continuously when night mode is active. Switching on by pressing a button or via the operating mode "Night" always takes place using the brightness value configured in the ETS or specified locally in the menu level.</p> <p>When the backlighting is switched by the 1-bit communication object (alternatively to the 1-byte object), the lighting remains switched on continuously according to the switching value (not inverted: "0" = OFF / "1" = ON; inverted: "0" = ON" / "1" = OFF). Here the switch-on brightness is defined by the display brightness value configured in the ETS or specified locally in the menu level.</p> <p>In the case of activation by the value object the lighting is dimmed in accordance with the received value ("1...254") or actuated to the maximum ("255"). The value "0" switches the lighting off completely.</p> <p>Lighting activation by operating a operating area can be combined with switching or dimming via the corresponding objects. In this case the control via the communication objects has a higher priority. The lighting is switched on automatically by pressing a control surface, and is only switched off again when the switch-off time configured in the ETS elapses, if the lighting is to be switched off via the corresponding communication object (object value "OFF" or "0"). Switching on by pressing a button always takes place using the brightness value configured in the ETS or specified locally in the menu level. In addition, the lighting can also be switched or dimmed by the communication objects, independently</p>

		of operation on the device. In this case, the lighting is not switched off automatically when the time has elapsed. The switch-off can then only take place using a switch-off telegram in accordance with the normal or inverted telegram polarity or via a value = "0" It is not possible to switch-off backlighting switched on by operation early using a bus telegram.
Automatic switch-off after	15 sec 30 sec 45 sec 1.0 min 1.5 min ... 1 h	The backlighting of the display is switched off automatically after the time set here, if it has been switched on by a button-press. This parameter is only visible when the backlighting can be switched on by button-press.
Controller night operation (RNST)	1 2 1 or 2 1 and 2	This parameter is only visible when the backlighting is switched on by night operation. In the "1" setting, the operating mode of the first controller decides on the status of the backlighting. In the "2" setting, the operating mode of the second controller decides on the status of the backlighting. In the "1 or 2" setting, the backlighting of the display is switched on as soon as one of the two controllers switches to the Night operating mode. In the "1 and 2" setting, the backlighting of the display is switched on when both controllers are in the Night operating mode.
Information Controller 1 Controller 2	See project design: "Room temperature control" -> "Configuration"	Both parameters provide information about the function to which Controller 1 and Controller 2 are configured. If both controllers are switched off, then the backlighting cannot be switched on by Night operation. The information parameters are only visible when the backlighting is set to "Switch-on through Night operation".
Overwrite brightness during ETS download	Yes No	The brightness of the display is preset to 100 %. The brightness can be optionally changed in the menu level of the TSM or in the parameters of the ETS. In the "Yes" setting, a further parameter is enabled for defining the brightness. In the "No" setting, the brightness of the display can still be changed in the menu

		level. After first commissioning, the brightness is set to 100 %.
Backlighting brightness (%)	5 ... 100	This parameter defines the brightness of the LCD backlighting. The value configured here can be overwritten after commissioning of the device locally in the menu level.
Number of pieces of display information	1 ... 17	In addition to the button function icons, it is possible to use the numeric display to show up to 17 display functions in the display. This means that it is possible to display the setpoint temperature, the actual temperature, the outdoor temperature and any temperatures 1-3. The temperatures can also be displayed in combination with the controller icons. It is possible to configure how much of this information is actually shown in the display using this parameter in the ETS. For each piece of display information, additional parameter nodes are then shown in the ETS.
Recall the display information via object	No recall switching object Value object (1 byte)	This parameter specifies whether a changeover of display information takes place on the display via a communication object. "No recall" setting: There is only a cyclical change of the display information. "Switching object" setting: The parameter "Switching object display information" and the communication object "Recall fixed display information" are enabled. The previously designed display information is shown on the display for the period during which the value of the object is "1". There is no cyclical change of the display information. "Value object" setting: The communication object "Recall variable display information" is enabled. The previously designed display information, corresponding to the value of the object, is shown on the display for the period during which the value of the object is "1", "2", ..., "17". There is no cyclical change of the display information. The cyclical switchover of the display information begins again when the communication object receives a "0" telegram via the KNX.

Switching object display information	Recall display information 1	The communication object "Recall fixed display information" recalls the display information set here when it is written with a "1" telegram.
	Recall display information 2	
	...	
	Recall display information 17	
Cyclical changeover of display information (s)	1... 10 ...60	This parameter specifies after how long a changeover of display information takes place on the display. There is no cyclical change of the display information, if a piece of display information is recalled via the communication object.
Display button function icons	Yes No	In the display, a button function icon can be assigned to each button. This parameter enables the parameter page "Button function icons" for project design of the button function icons. Button function icons are only available in the CD and LS series!
Controller 1 temporary setpoint display for setpoint shift	Yes No	Optionally the setpoint of the respective current operating mode can be shown automatically in the display if a setpoint shift is performed using the buttons of the device ("Setpoint shift" button function). The setpoint temperature is then displayed temporarily for 5 s in °C or °F, and overwrites the normal display (actual temperature, etc.). The setpoint display for a setpoint shift is activated when this parameter is set to "Yes". With the setting "No" the temporary display is inactive, meaning that in case of a setpoint shift only the line graphic of the display is activated, but the temperature value is not also displayed automatically. The temporary setpoint value display is only possible when controller is active with relative setpoint specification!
Controller 2 temporary setpoint display for setpoint shift	Yes No	Optionally the setpoint of the respective current operating mode can be shown automatically in the display if a setpoint shift is performed using the buttons of the device ("Setpoint shift" button function). The setpoint temperature is then displayed temporarily for 5 s in °C or °F, and overwrites the normal display

information.
 "Yes" setting: The display information is recalled in the cyclical changeover.
 "No" setting: The display information is not recalled in the cyclical changeover. It can only be recalled via the communication object.
 For display information item 1, this parameter is permanently set to "Yes". Accordingly, the cyclical changeover of the display information begins with display information item 1.

☐ Display -> Display information -> Display 2, 3, 4, ..., 17 (see Display 1)

☐ Display -> Button function icons -> Icon 1

Icon preview On/Off Graphic in the application program

Segment a **Hidden** The parameter shows Segment a (see graphic in the application program).
 Visible

Segment a **Hidden** The parameter shows Segment b (see graphic in the application program).
 Visible

Icon preview UP/DOWN Graphic in the application program

Segment c **Hidden** The parameter shows Segment c (see graphic in the application program).
 Visible

Segment d **Hidden** The parameter shows Segment d (see graphic in the application program).
 Visible

Icon preview Left/Right Graphic in the application program

Segment e **Hidden** The parameter shows Segment e (see graphic in the application program).
 Visible

Segment f **Hidden** The parameter shows Segment f (see graphic in the application program).
 Visible

Icon preview Increase/Decrease Graphic in the application program

Segment g	Hidden Visible	The parameter shows Segment g (see graphic in the application program).
Segment h	Hidden Visible	The parameter shows Segment h (see graphic in the application program).
Segment i	Hidden Visible	The parameter shows Segment i (see graphic in the application program).

□ Display -> Button function icons -> Icon 2, 3, 4, ..., 8 (see Icon 1)

5 Appendix

5.1 Index

Numerical

3-colour individual control..... 193

A

Accept setpoints permanently..... 131
 actual temperature..... 168
 Adapting the control..... 109
 Additional controller status..... 140
 application program..... 19
 Automatic colour change of the status LED 191
 automatic frost protection..... 120
 Automatic operation of the fan controller 148
 Automatic transmission..... 137

B

Backlighting of the display..... 94
 Basic display..... 21
 Basic setpoint shift..... 131
 Basic settings parameter group..... 208

C

Calibrating..... 167
 Clipping..... 143
 comfort prolongation (controller)..... 119
 Command value limit..... 141
 Command value limiting values..... 152
 Command value objects..... 136
 command value offset..... 152
 control algorithm..... 101
 Control surfaces..... 20
 controller extension..... 157
 Controller operation..... 183
 Controller status..... 138

D

decorative control surfaces..... 19
 Device components..... 8
 dew point mode..... 154
 Display..... 88
 Display information of the display..... 89

E

ETS commissioning..... 43
 ETS project design..... 43

ETS search paths..... 35

F

fan controller..... 146
 Fan level limit..... 151
 Fan protection..... 152
 Forced fan position..... 151

G

General parameter group..... 208

H

Heating/cooling message..... 100

I

Icons of the room temperature controller 88

M

Manual operation of the fan controller 148
 measured value formation..... 167
 menu level..... 22
 Menu level parameter group..... 210

O

operating mode after a reset..... 121
 Operating mode switch-over (controller) 113
 Operating modes (controller)..... 98
 Operating modes (fan controller)..... 148
 Operation mode switch-over (controller extension) 160
 Overlaid function of the status LED..... 191

P

physical address..... 18
 PI control..... 102
 Presence button..... 161
 Presence function (controller)..... 119
 product database..... 43
 pushbutton elements..... 20

R

Rotation angle conversion..... 143

S

Scene definition..... 198

scene recall.....	198
Setpoint shift.....	134,161
Setpoint temperature presetting.....	122
Setpoint temperatures.....	123
standard operating and display function	194
Status LED.....	187
Storing scenes.....	201
Switching PI control.....	102
Switch-on level (fan controller).....	150
T	
Temperature detection.....	167
temporary fan level display.....	197
Temporary setpoint display.....	133
U	
Underfloor heating temperature limit	156
User-defined colour setting of the status LED	191
V	
Valve protection.....	155
W	
window status.....	120

ALBRECHT JUNG GMBH & CO. KG

Volmestraße 1
58579 Schalksmühle
GERMANY

Telefon: +49 2355 806-0
Telefax: +49 2355 806-204
kundencenter@jung.de
www.jung.de