



Product documentation

Universal push-button module, 1-gang
Art. No. 4191 TSM

Universal push-button module, 2-gang
Art. No. 4192 TSM

Universal push-button module, 3-gang
Art. No. 4193 TSM

Universal push-button module, 4-gang
Art. No. 4194 TSM

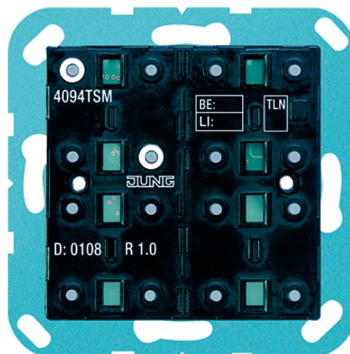

ALBRECHT JUNG GMBH & CO. KG
Volmestraße 1
58579 Schalksmühle
GERMANY

Telefon: +49 2355 806-0
Telefax: +49 2355 806-204
kundencenter@jung.de
www.jung.de

Issue: 09.05.2016
656x0321

Table of Contents

1	Product definition	4
1.1	Product catalogue	4
1.2	Function	4
2	Fitting, electrical connection and operation	6
2.1	Safety instructions	6
2.2	Device components	7
2.3	Fitting and electrical connection	11
2.4	Commissioning	15
2.5	Operation	18
3	Technical data	19
4	Software description	20
4.1	Software specification	20
4.2	Software "Universal TSM 10Bxy3"	21
4.2.1	Scope of functions	21
4.2.2	Software information	23
4.2.3	Object table	24
4.2.4	Functional description	37
4.2.4.1	General settings	37
4.2.4.1.1	Control surfaces	37
4.2.4.1.2	Button configuration	38
4.2.4.1.3	Operation concept and button evaluation	40
4.2.4.1.4	Button arrangement	45
4.2.4.1.5	Operation LED	47
4.2.4.1.6	Transmit delay	48
4.2.4.2	Rockers and push-button functions	49
4.2.4.2.1	"Switching" function	49
4.2.4.2.2	"Dimming" function	50
4.2.4.2.3	"Blind" function	52
4.2.4.2.4	"Value transmitter" function	56
4.2.4.2.5	"Scene extension" function	59
4.2.4.2.6	"2-channel operation" function	60
4.2.4.3	Status LED	63
4.2.4.4	Scene control	67
4.2.4.4.1	Scene definition and scene recall	67
4.2.4.4.2	Storing scenes	70
4.2.4.5	Disabling function	71
4.2.4.5.1	Configuring the disabling function	71
4.2.4.5.2	Three-button press	75
4.2.4.6	Controller extension unit	77
4.2.4.6.1	Connection to room thermostat	77
4.2.4.6.2	Button functions for "Operating mode selection" and "Forced operating mode switch over"	79
4.2.4.6.3	Button function "Presence button"	81

4.2.4.6.4	Button function "Setpoint shift"	82
4.2.4.7	Room temperature measurement	84
4.2.4.8	Alarm signalling	86
4.2.4.9	Delivery state	87
4.2.5	Parameters	88
5	Appendix	134
5.1	Index	134

1 Product definition

1.1 Product catalogue

Product name:	Universal push-button module, 1-gang / Universal push-button module, 2-gang / Universal push-button module, 3-gang / Universal push-button module, 4-gang
Use:	Sensor
Design:	UP (flush-mounting type)
Art. No.	4191 TSM / 4192 TSM / 4193 TSM / 4194 TSM

1.2 Function

When its buttons are pushed, the universal push-button sensor TSM sends telegrams to the KNX/EIB, depending on the ETS parameter settings. These can be, for instance, telegrams for switching or push button control, for dimming or for controlling blinds. It is also possible to program value transmitter functions, such as dimming value transmitters, light scene extensions, temperature value transmitters or brightness value transmitters.

In conjunction with a room temperature controller equipped with a 1-byte object for switching the operating modes the universal push-button sensor TSM can be used as a full-featured controller extension unit. The device can also be used for presence detection or for setpoint shifting purposes.

The universal push-button sensor TSM consists of a number of control surfaces that are designed as squares or rectangles, depending on the variant. The operating concept of an operating area can be configured in the ETS either as a rocker function or alternatively as a button function. With the rocker function, one control surface is divided into two actuation pressure points with the same basic function. In the button function either a control surface is divided into 2 functionally separate actuation pressure points (2 buttons), or a control surface is evaluated as single-area operation (only one button).

If a control surface is used as a single rocker function, then depending on the configuration it is also possible to trigger special function using full-surface operation. With the rocker function and the double-surface button function, the button arrangement can be set either as "vertical" or as "horizontal" for each control surface.

Optionally, the number of control surfaces of each universal push-button sensor TSM can be expanded to include up to 4 additional control surfaces by connecting an extension module to the basic unit. Configuration and commissioning of the extension module is clearly structured and easy to perform using the application program of the basic unit.

The universal push-button sensor TSM has two status LEDs per control surface. These status LEDs can either be switched on or off permanently, or can function as a status indicator for a button or rocker. As an alternative, the LEDs can also be activated via separate communication objects. The LEDs can either indicate the switching status of an object statically or by flashing, signal operating states of room temperature controllers, or indicate results of logical value comparison operations.

When used, an operation LED can either serve as an orientation light (also flashing), or can be activated via a separate communication object. When the push-button sensor is in the programming mode, the operation LED flashes with a frequency of about 8 Hz. The same flashing rate is also used for indicating that a rocker has been actuated by a press on the full surface; in this case, the LED switches back to its configured behaviour when actuation ends. If no or a wrong application has been loaded into the push-button sensor, the operation LED flashes with a frequency of approx. 0.75 Hz to indicate an error and the pushbutton sensor does not work.

The device contains a temperature sensor that measures the room temperature. The determined room temperature can be e.g. evaluated by an room temperature controller as an external temperature value or be displayed by a visualisation.

The push-button sensor universal TSM already has a permanently integrated bus coupling unit, which means that the device can be connected directly to the bus line during commissioning.

2 Fitting, electrical connection and operation

2.1 Safety instructions

Electrical equipment may only be installed and fitted by electrically skilled persons. The applicable accident prevention regulations must be observed.

Failure to observe the instructions may cause damage to the device and result in fire and other hazards.

Make sure during the installation that there is always sufficient insulation between the mains voltage and the bus. A minimum distance of at least 4 mm must be maintained between bus conductors and mains voltage cores.

The device may not be opened or operated outside the technical specifications.

2.2 Device components

Device components of universal push-button sensors TSM

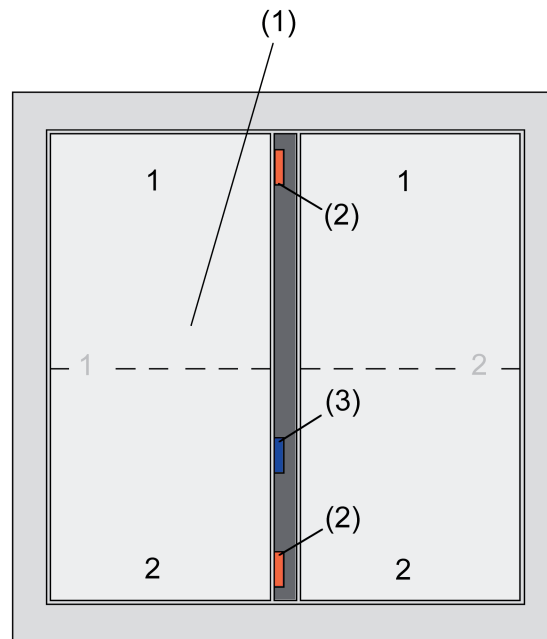

Figure 1: Device components of 1-gang universal push-button sensor TSM

- (1) 1 control surface configurable as rocker 1 or buttons 1...2. With rocker function or double-surface push-button function the button arrangement can be parameterized "top / bottom" or "left / right".
- (2) 2 status LEDs (red)
- (3) 1 operation LED (blue)

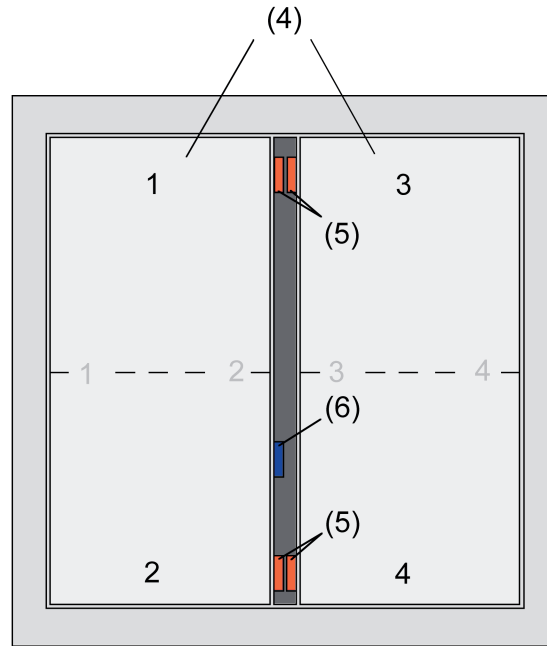

Figure 2: Device components of 2-gang universal push-button sensor TSM

- (4) 2 control surfaces configurable as rockers 1...2 or buttons 1...4. With rocker function or double-surface push-button function the button arrangement can be parameterized "top / bottom" or "left / right".
- (5) 4 status LEDs (red) / two per control surface.
- (6) 1 operation LED (blue)

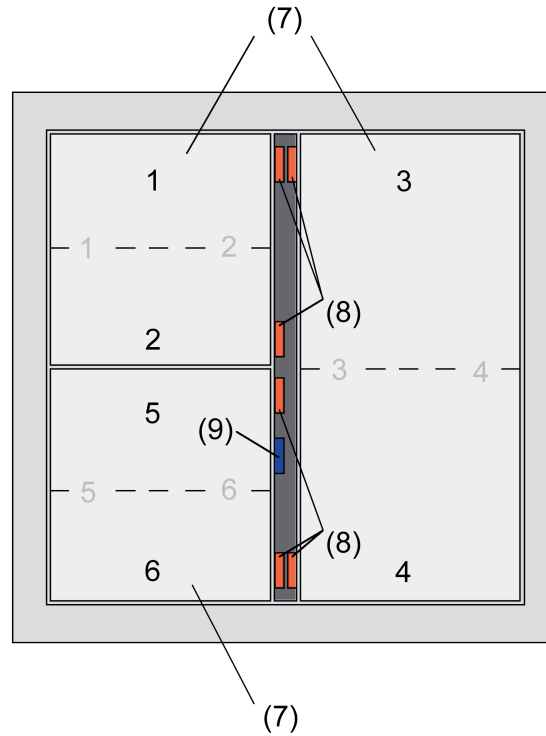

Figure 3: Device components of 3-gang universal push-button sensor TSM

- (7) 3 control surfaces configurable as rockers 1...3 or buttons 1...6. With rocker function or double-surface push-button function the button arrangement can be parameterized "top / bottom" or "left / right".
- (8) 6 status LEDs (red) / two per control surface.
- (9) 1 operation LED (blue)

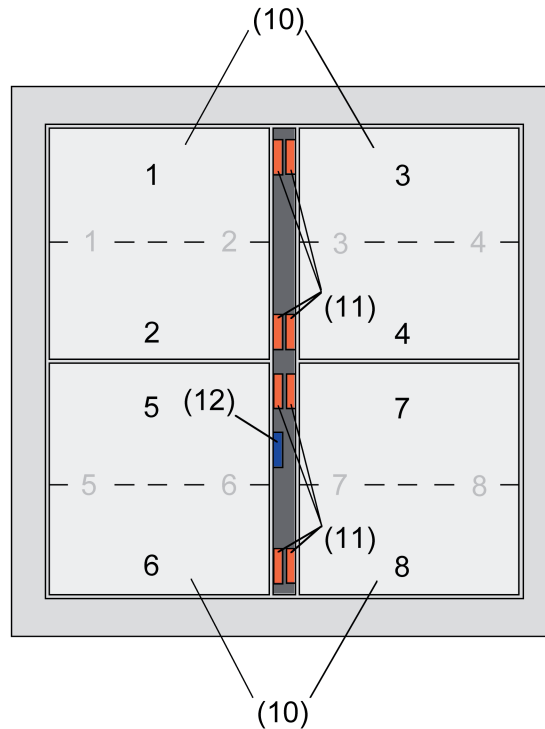

Figure 4: Device components of 4-gang universal push-button sensor TSM

- (10) 4 control surfaces configurable as rockers 1...4 or buttons 1...8. With rocker function or double-surface push-button function the button arrangement can be parameterized "top / bottom" or "left / right".
- (11) 8 status LEDs (red) / two per control surface.
- (12) 1 operation LED (blue)

Dimensions of universal push-button sensors TSM:
 Width (B): 55 mm / Height (H): 55 mm / Depth (D): 20 mm
 Specifications without design frame and covers, without supporting plate.

2.3 Fitting and electrical connection



DANGER!

Electrical shock on contact with live parts in the installation environment.
Electrical shocks can be fatal.

Before working on the device, disconnect the power supply and cover up live parts in the working environment.



DANGER!

Danger of electrical shock!

When mounting with 230 V socket outlets under a common cover there is a danger of electrical shocks in the event of a fault!

Use only the enclosed plastic screws for fastening to the supporting frame!

Snapping on the adapter frame

The CD design requires an adapter frame. The adapter frame must be snapped onto the push-button sensor module before the push-button sensor is connected and fixed to the wall.

- Snap adapter frame (15) in the right orientation from the front onto the push-button sensor module (16) (figure 5). Note marking **TOP**.
- ⓘ If push-button sensor expansion is used, the adapter frame also has to be mounted on the push-button sensor expansion module.

Push-button sensor basic module: assembly and connection

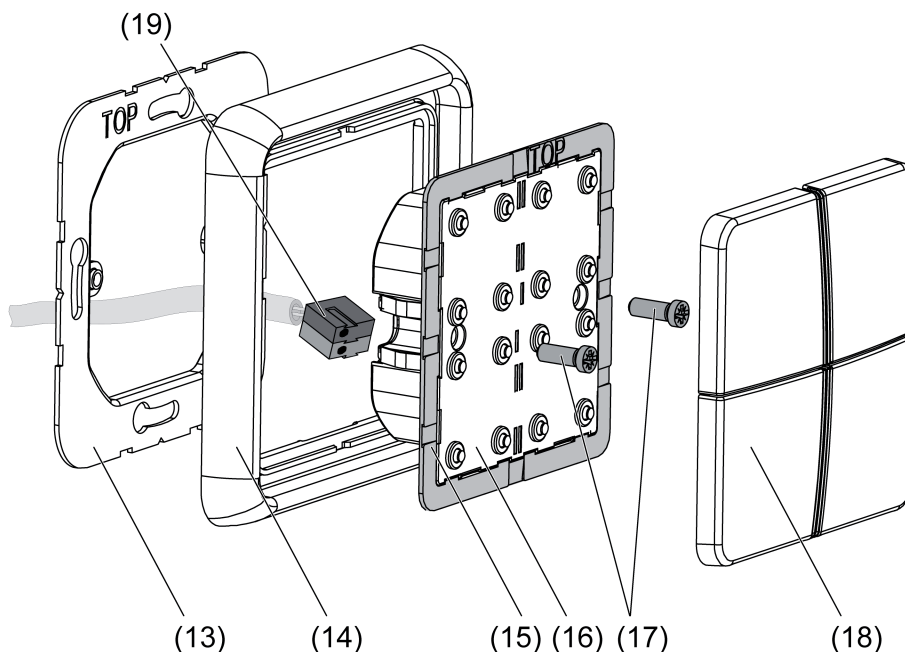

Figure 5: Assembling the push-button sensor basic module

(13) Supporting frame

- (14) Design frame
- (15) Adapter frame (only for the CD design)
- (16) Push-button module
- (17) Fastening screws
- (18) Design control surfaces
- (19) KNX connection terminal

i The installation of the support ring depends on the design used.
Supporting frame side **A** for A design ranges, CD design ranges and FD design.
Supporting frame side **B** for LS design ranges.

- Mount supporting ring (13) in the right orientation on an appliance box. Note marking **TOP**; marking "**A**" or "**B**" in front. Use the supplied box screws.
- Position the decorative frame (14) on the supporting ring.
- Connect the push button module (16) with KNW connection terminal (19), which is connected to the KNX bus cable, to the rear side of the module. Run the connection cable downwards from the push button module and then into the accessory socket from the rear.
- Push the push button module (16) onto the supporting ring (13).
- Fix the push button module (16) to supporting ring using the supplied plastic screws (17). Tighten the plastic screws only lightly.
- Before mounting the control surfaces (18), load the physical address into the device (see chapter 2.4. Commissioning).

Assembling push-button sensor basic module with push-button sensor expansion module and connecting

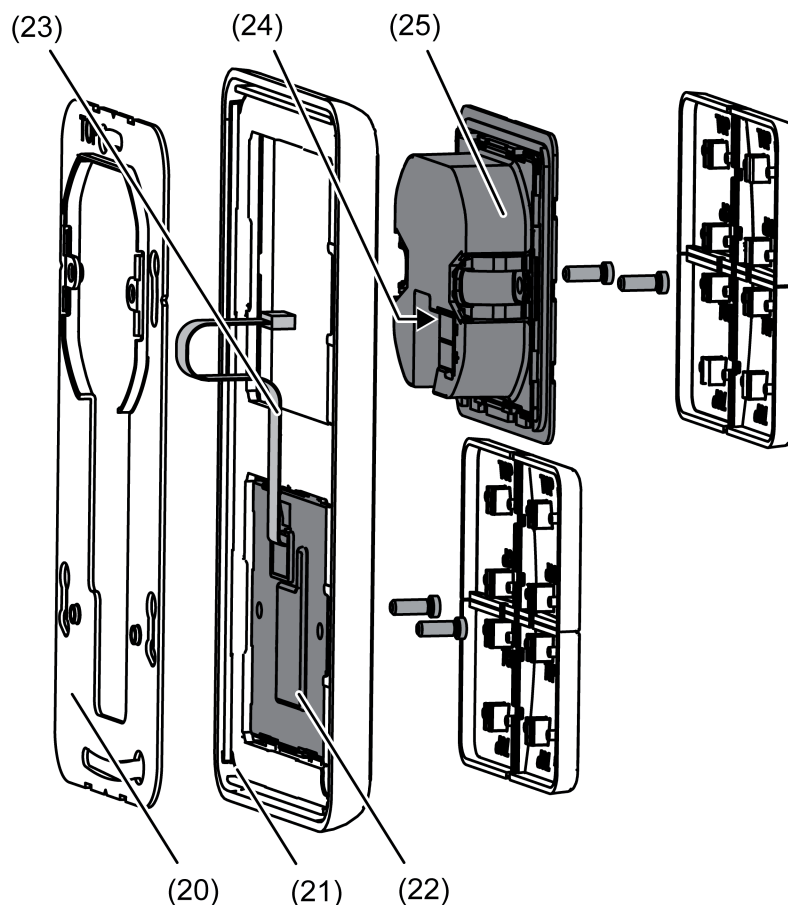

Figure 6: Assembling the push-button sensor expansion module

- (20) Large supporting ring for basic and expansion modules
- (21) Design frame
- (22) Push-button sensor expansion module
- (23) Connecting cable for push-button sensor expansion module with plug
- (24) Connection point in basic module for connecting cable of the expansion module
- (25) Push-button sensor basic module

- i** The installation of the support ring depends on the design used.
 Supporting frame side **A** for A design ranges, CD design ranges and FD design.
 Supporting frame side **B** for LS design ranges.

One push-button sensor expansion module can be connected to each push-button sensor basic module. When assembling a push-button sensor expansion module, the large supporting frame (20) must be fitted (figure 6). The large supporting frame is contained in the scope of supply of the push-button sensor expansion module.

When installing on just a single appliance box, install the basic module with the KNX bus connection in the appliance box and countersink the fixing screws of the expansion module in the wall, for example using $\varnothing 6 \times 10$ mm boreholes. The large supporting ring can be used as a template for this.

The preferred installation orientation for both devices is vertical with the push-button sensor basic module installed on top (figure 6).

- Mount large supporting ring (20) in the right orientation on an appliance box. Note marking **TOP**; marking "**A**" or "**B**" in front. Use the supplied box screws.
- Position the decorative frame (21) on the supporting ring.
- Mount push-button sensor expansion module (22) preferably below. Route connecting cable (23) between supporting ring and intermediate web.
- With the plug of the connecting cable (23) in the right orientation, insert it into the connection point in the basic module (24). When doing so, ensure that the connecting cable is not pinched.
- At the rear of the module, connect push-button sensor module (25) with KNX connecting terminal, which is connected to the KNX bus line. On the push-button sensor basic module, the connecting cable is routed down and out and then to the rear into the appliance box.
- Push the push-button sensor basic module (25) onto the large supporting ring (20).
- Fix push-button module to supporting ring using the supplied plastic screws. Tighten the plastic screws only lightly.
- Before mounting the control surfaces on the push-button sensor basic module, load the physical address into the device (see chapter 2.4. Commissioning).

2.4 Commissioning

After the universal push-button sensor TSM has been connected to the bus and mounted on the wall, it can be put into operation. The commissioning procedure is basically confined to programming with the ETS and attaching the design control surfaces.

Assignment of the physical address



DANGER!

Electrical shock when live parts are touched.

Electrical shocks can be fatal.

Before working on the device, disconnect the power supply and cover up live parts in the working environment.

The universal push-button sensor TSM is equipped with an integrated bus coupling unit. The push-button sensor has no separate programming button or LED. The programming mode is activated by a defined and time-delayed press on the first rocker and signalled by the operation LED. For programming of the physical address, the design control surfaces must not be snapped onto the device.

The physical address is programmed as described below...

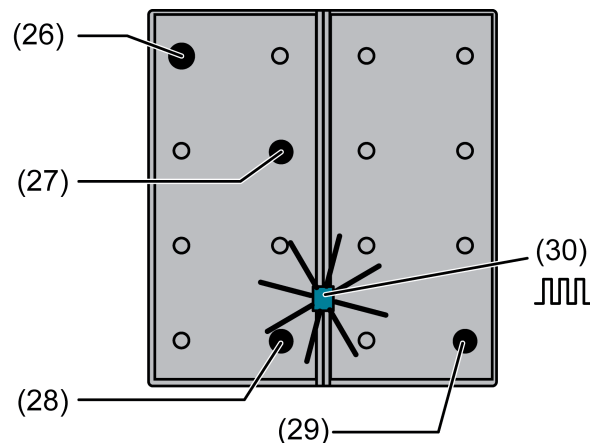

Figure 7: Buttons for activation of the programming mode

- Activate the programming mode. To do this, press and hold push-button at the upper left (26) (figure 7). Then press second push-button at the lower right (27, 28 or 29). The location of the second push-button depends on the push-button sensor variant.

Push-button sensor basic module	Buttons for activating the programming mode
3-gang, 4-gang	(26) + (27)
2-gang	(26) + (28)
1-gang	(26) + (29)

The programming mode is activated. The operation LED (30) flashes quickly (approx. 8 Hz).

- i** Use suitable objects to press the buttons (e.g. a thin screwdriver, ballpoint pen tip, etc.)

- i** In order to exclude the possibility of unintentional activation of programming during subsequent "normal" operation of the control surface, the time between the first and the second button-press must be at least 200 ms long. Simultaneous pressing of both buttons (time between the first and second button-press < 200 ms) does not activate the programming mode!
- i** It should be noted that the operation LED also flashes quickly in the case of a full-surface operation of rocker 1 (see functional description). The difference from quick flashing in programming mode is that with a full-surface operation the rocker of the LED returns to the parameterized basic state when the buttons are released. In programming mode the flashing lasts until the mode is terminated. The state of the LED set using the programming mode always takes hold.
 - Program the physical address with the help of the ETS.
 - The programming mode ends:
 - automatically after application of the physical address
 - by pressing any button
- i** When you wish to activate or deactivate the programming mode for a device that already has a valid programmed application, then it may happen that telegrams are being transmitted to the bus at the moment that the button is actuated. The telegram transmission depends on the parameterized button function.
- i** The expansion module does not receive any physical address of its own. It is activated by the application program loaded in the basic module.

Programming the application program

After that the application has to be programmed into the device using the ETS. The ETS3.0 from version "d" onwards detects automatically whether a valid application has already been programmed into the device before. To reduce the programming time, the ETS3 downloads the whole application only if the device was programmed beforehand with a different application or with no application at all. In all other cases, the ETS makes a time-optimised partial download in which only the modified data are loaded into the device.

Depending on the programming command, the ETS2 programs the application for the push-button either completely or partially for parameters and group addresses. The time-optimised download procedure of the ETS3.0d is not available in this version.

For commissioning purposes, it is recommended to use the ETS3.0 from version "d" onwards.

- i** The expansion module does not receive any physical address of its own. It is activated by the application program loaded in the basic module.

Fitting design control surfaces

The design control surfaces are available as a complete set of buttons. Individual buttons or the complete set of buttons can be replaced using buttons with symbols.

The design control surfaces are not included in the scope of supply of the push-button sensor basic module or the push-button sensor expansion module. They have to be ordered separately depending on the desired design.

The physical address of the push-button sensor basic module must already be programmed in the device.

- Place control surfaces on the push-button sensor basic module in the right orientation and also on the push-button sensor expansion module (if used), and snap in with a short push. Note marking **TOP**.

- i** To make mounting easier, a complete set of buttons is provided with a mounting spider at the factory. This mounting spider is not absolutely necessary for mounting the design control surfaces, so it may be omitted for example when supplementing the button field with symbol buttons.

2.5 Operation

Control surfaces

The universal push-button sensor TSM consists of a number of control surfaces that are designed as squares or rectangles, depending on the variant. The operation concept of a control surface can be configured in the ETS either as a rocker function or alternatively as a push-button function. In the rocker function a control surface is divided into two actuation pressure points with the same basic function. In the push-button function either a control surface is divided into 2 functionally separate actuation pressure points (2 buttons), or a control surface is evaluated as single-surface operation (only one button).

If a control surface is used as a single rocker function, then depending on the configuration it is also possible to trigger special function using full-surface operation.

With the rocker function and the double-surface push-button function, the button arrangement can be set either as "vertical" or as "horizontal" for each control surface.

The number of control rockers depends on the push-button sensor used. Optionally, the number of control surfaces of each universal push-button sensor TSM can be expanded to include up to 4 additional control surfaces by connecting an expansion module to the basic unit. Configuration and commissioning of the expansion module is clearly structured and easy to perform using the application program of the basic unit.

Depending on the function of the rocker or buttons, the two red LEDs beside each rocker may be internally connected with the control function. They may, however, also be used for signalling completely independent functions or be permanently on or off.

The operation LED can also signal the switching state of an object of its own, can flash or be permanently on or off. Besides the functions that can be programmed with the ETS, the operation LED also indicates that the push-button sensor is in the programming mode for commissioning or diagnosis purposes.

Moreover, the universal push-button sensor TSM has functions which are not immediately linked with the rockers or buttons and which must therefore be additionally enabled by the corresponding parameters. These include the thermostat extension function, push-button function disable, the internal scenes and the display of alarm signals.

i Configuration of the control surfaces (button or rocker function and button arrangement) is described in detail in the chapter "Software description"

3 Technical data

General

Protection class	III
Test mark	KNX
Ambient temperature	-5 ... +45 °C
Storage/transport temperature	-25 ... +70 °C

KNX/EIB supply

KNX medium	TP
Commissioning mode	S-mode
Rated voltage KNX	DC 21 ... 32 V SELV
Power consumption KNX	typ. 150 mW
Connection mode KNX	device connection terminal

Internal temperature sensor

Measuring range	-5 ... +45 °C
-----------------	---------------

4 Software description

4.1 Software specification

ETS search paths:	Push-button / Push-button, 1-gang / Universal push-button module, 1-gang Push-button / Push-button, 2-gang / Universal push-button module, 2-gang Push-button / Push-button, 3-gang / Universal push-button module, 3-gang Push-button / Push-button, 4-gang / Universal push-button module, 4-gang
Configuration:	S-mode standard
PEI type:	"00" _{Hex} / "0" _{Dec}
PEI connector:	no connector

No.	Short description	Name	Version	from mask version
1	Multifunctional application universal push-button module TSM 1-gang. 1 control surface on basic module. Can be extended to up to 5 control surfaces using extension module.	Universal TSM 10B113	1.3 for ETS3.0 Version d onwards	705
2	Multifunctional application universal push-button module TSM 2-gang. Up to 2 control surfaces on basic module. Can be extended to up to 6 control surfaces using extension module.	Universal TSM 10B213	1.3 for ETS3.0 Version d onwards	705
3	Multifunctional application universal push-button module TSM 3-gang. Up to 3 control surfaces on basic module. Can be extended to up to 7 control surfaces using extension module.	Universal TSM 10B313	1.3 for ETS3.0 Version d onwards	705
4	Multifunctional application universal push-button module TSM 4-gang. Up to 4 control surfaces on basic module. Can be extended to up to 8 control surfaces using extension module.	Universal TSM 10B413	1.3 for ETS3.0 Version d onwards	705

4.2 Software "Universal TSM 10Bxy3"

4.2.1 Scope of functions

Scope of functions

- Each operating area can either be used as a single rocker or as two independent buttons.
- For button function either double-surface or single-surface principle.
- For rockers or button functions (double-surface), the control surfaces can be subdivided either horizontally or vertically.
- Each rocker can be used for the functions 'switching', 'dimming', 'blind/shutter', '1-byte value transmitter', '2-byte value transmitter' and 'scene extension'.
- Each button can be used for the functions switching, dimming, shutter control, 1-byte value transmitter, 2-byte value transmitter, scene extension and room temperature controller extension value transmitter.
- 2-channel control is possible: each rocker or each button can be set for controlling two independent channels. This means that only one button-press is enough to transmit up to two telegrams to the bus. The channels can be configured independently of one another for the Switching, Value transmitter (1 byte) or Temperature value transmitter (2 bytes) functions.
- For the rocker functions Dimming, Venetian blind (operating concept "Long – Short or Short") and 2-channel operation, full-surface rocker actuation can also be evaluated. With full-surface rocker operation, switching telegrams and scene recall requests can be triggered on the bus in addition to and independently of the configured rocker function.
- The switching function permits the following settings: reaction after pressing and/or releasing, switch on, switch off, and toggle.
- The dimming function permits the following settings: times for short and long actuation, dimming in different levels, telegram repetition on long press, transmission of stop telegram after end of press.
- The shutter control permits the following settings: four different operation concepts with times for short and long press and slat adjustment.
- The 1-byte and 2-byte value transmitter function permits the following settings: selection of the value range (0 ... 100 %, 0 ... 255, 0 ... 65535, 0 ... 1500 lux, 0 ... 40 °C), value on actuation, value change on long button-press with different step widths, times optional overflow when the end of the value range is reached.
- The scene control permits the following settings: Internal storage of eight scenes with eight output channels, recall of internal scenes by means of a presettable scene number, selection of object types for the output channels; for each scene, the storage of the individual output values and the transmission of the output values can be permitted or disabled; the individual channels can be delayed during scene recall; as scene extension 64 scenes can be recalled and stored.
- The controller extension function permits the following settings: operating mode selection with normal and high priority, defined selection of an operating mode, change between different operating modes, change of presence status, setpoint shift.
- Each control surface has two status LEDs in vertical arrangement.
- When a status LED is internally connected with the rocker or the button, it can signal a button-press or the current status of a communication object. The status indication can also be in inverted form.
- When a status LED is not dependent on the rocker or button, it can be permanently on or off, indicate the status of an independent communication object, the operating state of a room temperature controller or the result of a comparison between signed or unsigned 1 byte values.
- The operation LED can be permanently on or off or alternatively be switched via a communication object.
- The rockers or buttons can be disabled via a 1-bit object. The following settings are possible: polarity of the disabling object, behaviour at the beginning and at the end of disabling. During an active disable, all or some of the rockers / buttons can have no function, can perform the function of a selected button or execute one of two presettable disabling functions.

- All LEDs of the push button sensor can flash simultaneously in the event of an alarm. The following settings are possible: Value of alarm signalling object for the states alarm / no alarm, alarm acknowledge by actuation of a button, transmission of the acknowledge signal to other devices.
- Internal temperature sensor for room temperature measurement possible. If required, measurement can be supplemented with an external sensor (configurable measured value formation). Temperature calibration can be configured separately for the internal and external sensors. Automatic transmission of the determined room temperature (cyclically and after change interval).

4.2.2 Software information

ETS project design and commissioning

For project design and commissioning of the device, ETS3.0d or more recent version is required. We recommend using ETS5.

4.2.3 Object table

Number of communication objects:	31 (1x variant) 37 (2x variant) 43 (3x variant) 49 (4x variant) (max. object number 74 - gaps in between)
Number of addresses (max):	120
Number of assignments (max):	120
Dynamic table management	yes
Maximum table length	240

Objects for rocker or button function (basic or module control surfaces):

Function: Switching

Object	Function	Name	Type	DPT	Flag
 ⁰	Switching	Rocker/button 1 ^{1,2}	1-bit	1.xxx	C, W, T, (R) ³

Description 1-bit object for transmission of switching telegrams (ON, OFF).

Function: Dimming

Object	Function	Name	Type	DPT	Flag
 ⁰	Switching	Rocker/button 1 ^{1,2}	1-bit	1.xxx	C, W, T, (R) ³

Description 1-bit object for transmission of switching telegrams (ON, OFF).

Function: Dimming

Object	Function	Name	Type	DPT	Flag
 ¹⁸	Dimming	Rocker/button 1 ^{1,2}	4-bit	3.007	C, W, T, (R) ³

Description 4-bit object for the transmission of relative dimming telegrams.

1: The number of rockers or buttons depends on the planned push-button sensor variant and the push-button sensor extension module. Mixed operation of rocker or button functions in a push-button sensor is possible on the basic module and the extension module.

2: The objects have been described for rocker 1 or button 1 as an example. The objects for the other rockers/buttons and for the module rockers are defined in the same way by shifting the object number and changing the object name.

3: For reading, the R-flag must be set. The last value written to the object via the bus will be read.

Function: Venetian blind

Object	Function	Name	Type	DPT	Flag
 ⁰	Short time operation	Rocker/button 1 ^{1,2}	1-bit	1.007	C, -, T, (R) ₃

Description 1-bit object for the transmission of telegrams with which a Venetian blind or shutter drive motor can be stopped or with which the blind slats can be adjusted by short time operation.

Function: Venetian blind

Object	Function	Name	Type	DPT	Flag
 ¹⁸	Long-time operation	Rocker/button 1 ^{1,2}	1-bit	1.008	C, W, T, (R) ₃

Description 1-bit object for the transmission of telegrams with which a Venetian blind or shutter drive motor can be moved upwards or downwards.

Function: 1-byte value transmitter

Object	Function	Name	Type	DPT	Flag
 ⁰	Value	Rocker/button 1 ^{1,2}	1 byte	5.xxx	C, W, T, (R) ₃

Description 1-byte object for the transmission of values from 0 to 255 (corresponding to values from 0 % to 100 %). If the adjustment of the value is enabled, the object can transmit telegrams cyclically after long actuation with which the value can be reduced or increased by a presettable amount.

Function: 2-byte value transmitter

Object	Function	Name	Type	DPT	Flag
 ⁰	Value	Rocker/button 1 ^{1,2}	2 byte	7.xxx	C, W, T, (R) ₃

Description 2-byte object for the transmission of values from 0 to 65535. If the adjustment of the value is enabled, the object can transmit cyclical telegrams after a long press with which the value can be reduced or increased by an adjustable amount.

1: The number of rockers or buttons depends on the planned push-button sensor variant and the push-button sensor extension module. Mixed operation of rocker or button functions in a push-button sensor is possible on the basic module and the extension module.

2: The objects have been described for rocker 1 or button 1 as an example. The objects for the other rockers/buttons and for the module rockers are defined in the same way by shifting the object number and changing the object name.

3: For reading, the R-flag must be set. The last value written to the object via the bus will be read.

Function: 2-byte value transmitter

Object	Function	Name	Type	DPT	Flag
 ⁰	Temperature value	Rocker/button 1 ^{1,2}	2 byte	9.001	C, W, T, (R) ³

Description 2 -byte object for the transmission of a temperature value from 0 °C to 40 °C. If the adjustment of the value is enabled, the object can transmit telegrams cyclically after a long press with which the value can be reduced or increased by 1 K.

Function: 2-byte value transmitter

Object	Function	Name	Type	DPT	Flag
 ⁰	Brightness value	Rocker/button 1 ^{1,2}	2 byte	9.004	C, W, T, (R) ³

Description 2-byte object for the transmission of a brightness level value from 0 to 1500 lux. If the adjustment of the value is enabled, the object can transmit cyclical telegrams after a long press with which the value can be reduced or increased by 50 lux.

Function: Scene extension

Object	Function	Name	Type	DPT	Flag
 ⁰	Scene extension	Rocker/button 1 ^{1,2}	1 byte	18.001	C, -, T, (R) ₃

Description 1-byte object for recalling or for storing one of 64 scenes max. from a scene push button sensor.

Function: 2-channel operation

Object	Function	Name	Type	DPT	Flag
 ⁰	Channel 1 switching	Rocker/button 1 ^{1,2}	1-bit	1.xxx	C, W, T, (R) ³

Description 1-bit object for the transmission of switching telegrams, if 2-channel operation is activated.

Function: 2-channel operation

Object	Function	Name	Type	DPT	Flag
 ⁰	Channel 1 value	Rocker/button 1 ^{1,2}	1 byte	5.xxx	C, -, T, (R) ₃

Description 1-byte object for the transmission of value telegrams, if 2-channel operation is activated.

1: The number of rockers or buttons depends on the planned push-button sensor variant and the push-button sensor extension module. Mixed operation of rocker or button functions in a push-button sensor is possible on the basic module and the extension module.

2: The objects have been described for rocker 1 or button 1 as an example. The objects for the other rockers/buttons and for the module rockers are defined in the same way by shifting the object number and changing the object name.

3: For reading, the R-flag must be set. The last value written to the object via the bus will be read.

Function: 2-channel operation

Object	Function	Name	Type	DPT	Flag
 ⁰	Channel 1 value	Rocker/button 1 ^{1,2}	2 byte	9.001	C, -, T, (R) ₃

Description 2-byte object for the transmission of value telegrams, if 2-channel operation is activated.

Function: 2-channel operation

Object	Function	Name	Type	DPT	Flag
 ¹⁸	Channel 2 switching	Rocker/button 1 ^{1,2}	1-bit	1.xxx	C, W, T, (R) ₃

Description 1-bit object for the transmission of switching telegrams, if 2-channel operation is activated.

Function: 2-channel operation

Object	Function	Name	Type	DPT	Flag
 ¹⁸	Channel 2 value	Rocker/button 1 ^{1,2}	1 byte	5.xxx	C, -, T, (R) ₃

Description 1-byte object for the transmission of value telegrams, if 2-channel operation is activated.

Function: 2-channel operation

Object	Function	Name	Type	DPT	Flag
 ¹⁸	Channel 2 value	Rocker/button 1 ^{1,2}	2 byte	9.001	C, -, T, (R) ₃

Description 2-byte object for the transmission of value telegrams, if 2-channel operation is activated.

1: The number of rockers or buttons depends on the planned push-button sensor variant and the push-button sensor extension module. Mixed operation of rocker or button functions in a push-button sensor is possible on the basic module and the extension module.

2: The objects have been described for rocker 1 or button 1 as an example. The objects for the other rockers/buttons and for the module rockers are defined in the same way by shifting the object number and changing the object name.

3: For reading, the R-flag must be set. The last value written to the object via the bus will be read.

Objects for full-surface operation with rocker function (with dimming, Venetian blind and 2-channel operation):

Function: Full-surface operation

Object	Function	Name	Type	DPT	Flag
 ¹	Switching	Rocker 1 full-surface operation _{1,}	1-bit	1.xxx	C, W, T, (R) ³

Description 1-bit object for the transmission of switching telegrams (ON, OFF) when there is full-surface operation of a control surface.

Function: Full-surface operation

Object	Function	Name	Type	DPT	Flag
 ¹	Scene extension	Rocker 1 full-surface operation _{1,}	1 byte	18.001	C, -, T, (R) ₃

Description 1-byte object for recalling or for storing one of 64 scenes max. from a scene pushbutton sensor in case of full-surface operation of a control surface.

Objects for status LED:

Function: Status LED in case of rocker function

Object	Function	Name	Type	DPT	Flag
 ³⁶	Status LED top	Rocker 1 ^{1,2}	1-bit	1.xxx	C, W, -, (R) ₃

Description 1-bit object for activation of the status LED.

Function: Status LED in case of rocker function

Object	Function	Name	Type	DPT	Flag
 ³⁶	Status LED top	Rocker 1 ^{1,2}	1 byte	5.xxx, 6.xxx, 20.102	C, W, -, (R) ₃

Description 1-byte object for activation of the status LED.

1: The number of rockers or buttons depends on the planned push-button sensor variant and the push-button sensor extension module. Mixed operation of rocker or button functions in a push-button sensor is possible on the basic module and the extension module.

2: The objects have been described for rocker 1 or button 1 as an example. The objects for the other rockers/buttons and for the module rockers are defined in the same way by shifting the object number and changing the object name.

3: For reading, the R-flag must be set. The last value written to the object via the bus will be read.

Function: Status LED in case of rocker function

Object	Function	Name	Type	DPT	Flag
 ³⁷	Status LED bottom	Rocker 1 ^{1,2}	1-bit	1.xxx	C, W, -, (R) ₃

Description 1-bit object for activation of the status LED.

Function: Status LED in case of rocker function

Object	Function	Name	Type	DPT	Flag
 ³⁷	Status LED bottom	Rocker 1 ^{1,2}	1 byte	5.xxx, 6.xxx, 20.102	C, W, -, (R) ₃

Description 1-byte object for activation of the status LED.

Function: Status LED in case of push button function

Object	Function	Name	Type	DPT	Flag
 ³⁶	Status LED	Button 1 ^{1,2}	1-bit	1.xxx	C, W, -, (R) ₃

Description 1-bit object for activation of the status LED.

Function: Status LED in case of push button function

Object	Function	Name	Type	DPT	Flag
 ³⁶	Status LED	Button 1 ^{1,2}	1 byte	5.xxx, 6.xxx, 20.102	C, W, -, (R) ₃

Description 1-byte object for activation of the status LED.

Objects for disabling functions:

Function: Switching

Object	Function	Name	Type	DPT	Flag
 ^{16, 17}	Switching	Disabling function 1 / 2	1-bit	1.xxx	C, W, T, (R) ₃

Description 1-bit object for transmission of switching telegrams (ON, OFF).

1: The number of rockers or buttons depends on the planned push-button sensor variant and the push-button sensor extension module. Mixed operation of rocker or button functions in a push-button sensor is possible on the basic module and the extension module.

2: The objects have been described for rocker 1 or button 1 as an example. The objects for the other rockers/buttons and for the module rockers are defined in the same way by shifting the object number and changing the object name.

3: For reading, the R-flag must be set. The last value written to the object via the bus will be read.

Function: Dimming

Object	Function	Name	Type	DPT	Flag
 16, 17	Switching	Disabling function 1 / 2	1-bit	1.xxx	C, W, T, (R) ¹

Description 1-bit object for transmission of switching telegrams (ON, OFF).

Function: Dimming

Object	Function	Name	Type	DPT	Flag
 34, 35	Dimming	Disabling function 1 / 2	4-bit	1.007	C, W, T, (R) ¹

Description 4-bit object for the transmission of relative dimming telegrams.

Function: Venetian blind

Object	Function	Name	Type	DPT	Flag
 16, 17	Short time operation	Disabling function 1 / 2	1-bit	1.007	C, -, T, (R) 1

Description 1-bit object for the transmission of telegrams with which a Venetian blind or shutter drive motor can be stopped or with which the blind slats can be adjusted by short time operation.

Function: Venetian blind

Object	Function	Name	Type	DPT	Flag
 34, 35	Long-time operation	Disabling function 1 / 2	1-bit	1.008	C, W, T, (R) ¹

Description 1-bit object for the transmission of telegrams with which a Venetian blind or shutter drive motor can be moved upwards or downwards.

Function: 1-byte value transmitter

Object	Function	Name	Type	DPT	Flag
 16, 17	Value	Disabling function 1 / 2	1 byte	5.xxx	C, W, T, (R) ¹

Description 1-byte object for the transmission of values from 0 to 255 (corresponding to values from 0 % to 100 %). If the adjustment of the value is enabled, the object can transmit telegrams cyclically after long actuation with which the value can be reduced or increased by a presettable amount.

1: For reading, the R-flag must be set. The last value written to the object via the bus will be read.

Function:	2-byte value transmitter				
Object	Function	Name	Type	DPT	Flag
 16, 17	Value	Disabling function 1 / 2	2 byte	7.xxx	C, W, T, (R) ¹
Description	2-byte object for the transmission of values from 0 to 65535. If the adjustment of the value is enabled, the object can transmit cyclical telegrams after a long press with which the value can be reduced or increased by an adjustable amount.				

Function:	2-byte value transmitter				
Object	Function	Name	Type	DPT	Flag
 16, 17	Temperature value	Disabling function 1 / 2	2 byte	9.001	C, W, T, (R) ¹
Description	2 -byte object for the transmission of a temperature value from 0 °C to 40 °C. If the adjustment of the value is enabled, the object can transmit telegrams cyclically after a long press with which the value can be reduced or increased by 1 K.				

Function:	2-byte value transmitter				
Object	Function	Name	Type	DPT	Flag
 16, 17	Brightness value	Disabling function 1 / 2	2 byte	9.004	C, W, T, (R) ¹
Description	2-byte object for the transmission of a brightness level value from 0 to 1500 lux. If the adjustment of the value is enabled, the object can transmit cyclical telegrams after a long press with which the value can be reduced or increased by 50 lux.				

Function:	Scene extension				
Object	Function	Name	Type	DPT	Flag
 16, 17	Scene extension	Disabling function 1 / 2	1 byte	18.001	C, -, T, (R) 1
Description	1-byte object for recalling or for storing one of 64 scenes max. from a scene push button sensor.				

Function:	2-channel operation				
Object	Function	Name	Type	DPT	Flag
 16, 17	Channel 1 switching	Disabling function 1 / 2	1-bit	1.xxx	C, W, T, (R) ¹
Description	1-bit object for the transmission of switching telegrams, if 2-channel operation is activated.				

1: For reading, the R-flag must be set. The last value written to the object via the bus will be read.

Function: 2-channel operation

Object	Function	Name	Type	DPT	Flag
 16, 17	Channel 1 value	Disabling function 1 / 2	1 byte	5.xxx	C, -, T, (R) 1

Description 1-byte object for the transmission of value telegrams, if 2-channel operation is activated.

Function: 2-channel operation

Object	Function	Name	Type	DPT	Flag
 16, 17	Channel 1 value	Disabling function 1 / 2	2 byte	9.001	C, -, T, (R) 1

Description 2-byte object for the transmission of value telegrams, if 2-channel operation is activated.

Function: 2-channel operation

Object	Function	Name	Type	DPT	Flag
 34, 35	Channel 2 switching	Disabling function 1 / 2	1-bit	1.xxx	C, W, T, (R) ¹

Description 1-bit object for the transmission of switching telegrams, if 2-channel operation is activated.

Function: 2-channel operation

Object	Function	Name	Type	DPT	Flag
 34, 35	Channel 2 value	Disabling function 1 / 2	1 byte	5.xxx	C, -, T, (R) 1

Description 1-byte object for the transmission of value telegrams, if 2-channel operation is activated.

Function: 2-channel operation

Object	Function	Name	Type	DPT	Flag
 34, 35	Channel 2 value	Disabling function 1 / 2	2 byte	9.001	C, -, T, (R) 1

Description 2-byte object for the transmission of value telegrams, if 2-channel operation is activated.

1: For reading, the R-flag must be set. The last value written to the object via the bus will be read.

Function: Disabling function

Object	Function	Name	Type	DPT	Flag
 54	Disabling	Button disabling	1-bit	1.001	C, W, -, (R) ₁

Description 1-bit object by means of which the push button sensor can be disabled and enabled again (polarity configurable).

Object for the operation LED:

Function: Operation LED

Object	Function	Name	Type	DPT	Flag
 52	Operation LED	Switching	1-bit	1.001	C, W, -, (R) ₁

Description 1-bit object for switching the operation LED on or off ("1" = switch on; "0" = switch off).

Objects for room temperature measurement

Function: Room temperature measurement

Object	Function	Name	Type	DPT	Flag
 64	Measured room temperature	Room temperature measurement	2 byte	9.001	C, -, T, (R) ₁

Description 2-byte object for the transmission of the room temperature determined by the device. The output value takes the calibrated measured value of the internal temperature sensor into account and, optionally, the calibrated temperature value of the external sensor (after measured value formation).
Possible value range: -99.9 °C to +99.9 °C / Measurement range of internal temperature sensor: -5 °C to +40 °C. The temperature value is always output in the format "°C".

Function: Room temperature measurement

Object	Function	Name	Type	DPT	Flag
 65	External temperature sensor	Room temperature measurement	2 byte	9.001	C, W, T, (R) ₁

Description 2-byte object for coupling an external KNX room temperature sensor or a controller extension. Thus cascading of multiple temperature sensors for room temperature measurement.
Possible range of values: -99.9 °C to +99.9 °C. The temperature value must always be specified in the format "°C".

1: For reading, the R-flag must be set. The last value written to the object via the bus will be read.

Objects for alarm message:

Function: Alarm signal

Object	Function	Name	Type	DPT	Flag
 56	Switching	Alarm signal	1-bit	1.xxx	C, W, -, (R) 1

Description 1-bit object for the reception of an alarm signalling (polarity configurable).

Function: Alarm signal

Object	Function	Name	Type	DPT	Flag
 57	Switching	Alarm message acknowledge	1-bit	1.xxx	C, -, T, (R) 1

Description 1-bit object for transmitting the acknowledgement of an alarm signalling (polarity configurable).

Objects for the controller extension:

Function: Controller extension

Object	Function	Name	Type	DPT	Flag
 58	Operating mode switch-over	Controller extension	1 byte	20.102	C, W, T, (R) ¹

Description 1-byte object for changing over a room temperature controller between the Comfort, Standby, Night and Frost/heat protection operating modes.

Function: Controller extension

Object	Function	Name	Type	DPT	Flag
 59	Forced oper. mode switch-over	Controller extension	1 byte	20.102	C, W, T, (R) ¹

Description 1-byte object for changing over a room temperature controller under forced control between the Automatic, Comfort, Standby, Night and Frost / heat protection operating modes.

Function: Controller extension

Object	Function	Name	Type	DPT	Flag
 60	Presence button	Controller extension	1-bit	1.001	C, W, T, (R) ¹

Description 1-bit object for changing over the presence status of a room temperature controller (polarity configurable)

1: For reading, the R-flag must be set. The last value written to the object via the bus will be read.

Function:	Controller extension				
Object	Function	Name	Type	DPT	Flag
 61	Setpoint shift output	Controller extension	1 byte	6.010	C, -, T, (R) ₁
Description	1-byte object for presetting a basic setpoint shift for a controller. $x \leq 0 \leq y$ (0 = no shift active); integral numbers Value object 62 + 1 (increase level value) Value object 62 - 1 (decrease level value) The possible range of values (x to y) is fixed by the setpoint adjusting range to the 'upper limit' or to the 'lower limit' (configurable) in combination with the level value <u>on the room temperature controller</u> .				

Function:	Controller extension				
Object	Function	Name	Type	DPT	Flag
 62	Setpoint shift input	Controller extension	1 byte	6.010	C, W, -, (R) ₁
Description	1-byte object used by the extension unit for receiving the current setpoint shift of the room temperature controller. $x \leq 0 \leq y$ (0 = no shift active); integral numbers The possible range of values (x to y) is fixed by the setpoint adjusting range to the 'upper limit' or to the 'lower limit' (configurable) in combination with the level value <u>on the room temperature controller</u> .				

Function:	Controller extension				
Object	Function	Name	Type	DPT	Flag
 63	Controller status	Controller extension	1 byte	Not defined	C, W, -, (R) ₁
Description	1-byte object used by the extension unit for receiving the current state of operation of the controller. Status LEDs that can be used to indicate a status independently of a button function can display one of the various information units which are grouped in this byte (bit-oriented evaluation).				

Objects for the scene function:

Function:	Scene function				
Object	Function	Name	Type	DPT	Flag
 66...-73	Switching	Scene output 1 ²	1-bit	1.001	C, W, T, (R) ₁
Description	1-bit objects for controlling up to eight actuator groups (ON, OFF).				

1: For reading, the R-flag must be set. The last value written to the object via the bus will be read.

2: Scene outputs 2 ... 8 see scene output 1, shift of the object number (66 + number of scene output - 1).

Function: Scene function

Object	Function	Name	Type	DPT	Flag
□← ^{66...-73}	Value	Scene output 1 ¹	1 byte	5.001	C, W, T, (R) ²

Description 1-byte objects for controlling up to eight actuator groups (0...255).

Function: Scene function

Object	Function	Name	Type	DPT	Flag
□← ⁷⁴	Extension unit input	Scenes	1 byte	18.001	C, W, -, (R) ₂

Description 1-byte object with which one of the eight internally stored scenes can be recalled or stored again.

1: Scene outputs 2 ... 8 see scene output 1, shift of the object number (66 + number of scene output - 1).

2: For reading, the R-flag must be set. The last value written to the object via the bus will be read.

4.2.4 Functional description

4.2.4.1 General settings

4.2.4.1.1 Control surfaces

Control surfaces

The universal push-button sensor TSM consists of a number of control surfaces that are designed as squares or rectangles, depending on the variant. The operation concept of a control surface can be configured in the ETS either as a rocker function or alternatively as a push-button function. In the rocker function a control surface is divided into two actuation pressure points with the same basic function. In the push-button function either a control surface is divided into 2 functionally separate actuation pressure points (2 buttons), or a control surface is evaluated as single-surface operation (only one button).

If a control surface is used as a single rocker function, then depending on the configuration it is also possible to trigger special function using full-surface operation.

With the rocker function and the double-surface push-button function, the button arrangement can be set either as "vertical" or as "horizontal" for each control surface.

The number of control rockers depends on the push-button sensor used. Optionally, the number of control surfaces of each universal push-button sensor TSM can be expanded to include up to 4 additional control surfaces by connecting an expansion module to the basic unit. Configuration and commissioning of the expansion module is clearly structured and easy to perform using the application program of the basic unit.

Depending on the function of the rocker or buttons, the two red LEDs beside each rocker may be internally connected with the control function. They may, however, also be used for signalling completely independent functions or be permanently on or off.

The operation LED can also signal the switching state of an object of its own, can flash or be permanently on or off. Besides the functions that can be programmed with the ETS, the operation LED also indicates that the push-button sensor is in the programming mode for commissioning or diagnosis purposes.

Moreover, the universal push-button sensor TSM has functions which are not immediately linked with the rockers or buttons and which must therefore be additionally enabled by the corresponding parameters. These include the thermostat extension function, push-button function disable, the internal scenes and the display of alarm signals.

i Some chapters of the functional description makes use of screenshots of the parameter windows. These screenshots are intended to illustrate the parameter settings described in detail. The screenshots were made in the ETS3. In the ETS2, the parameters are listed in the same place. Only the graphic display of the parameter window is different from that in the ETS3.

4.2.4.1.2 Button configuration

Button configuration

During button configuration it is defined whether an expansion module is connected to the universal push-button sensor TSM (basic unit). A push-button sensor expansion module expands the number of control surfaces in addition to the control surfaces of the basic unit, so that up to four rockers or 8 buttons more are available.

Thus for example a 1-gang universal push-button sensor TSM basic unit can be supplemented with a 4-gang expansion module, adding 4 control surfaces for a total of 5. Similarly, a 2-gang basic unit can be expanded with a 4-gang expansion module to 6 control surfaces, etc.

The rockers or buttons of the expansion module are evaluated by the application program of the basic unit. In addition, each control surface of the expansion module has two status LEDs that are also activated by the application program of the basic unit. Consequently, an expansion module does not have any application or bus coupling module of its own, and is configured and put into operation in the ETS via the product database of the basic module. Each basic unit can have only one expansion module connected to it.

Together, a basic unit and an expansion module form the "Push-button sensor unit".

Configuration of the control surfaces of the connected expansion modules is carried out in the ETS on the parameter page "Button configuration".

The button configuration of the basic module is permanently specified by the application program used in the ETS project, and cannot be changed (e.g. 4-gang universal push-button sensor TSM = 4 rockers / buttons 1...8 on the basic unit). In the ETS parameter view the button pairs of the basic module are shown as "present" for the purpose of general information.

If a push-button sensor expansion module is connected, its button pairs must be enabled separately in the ETS. In the ETS parameter view the button pairs of the expansion module are then to be configured as "present".

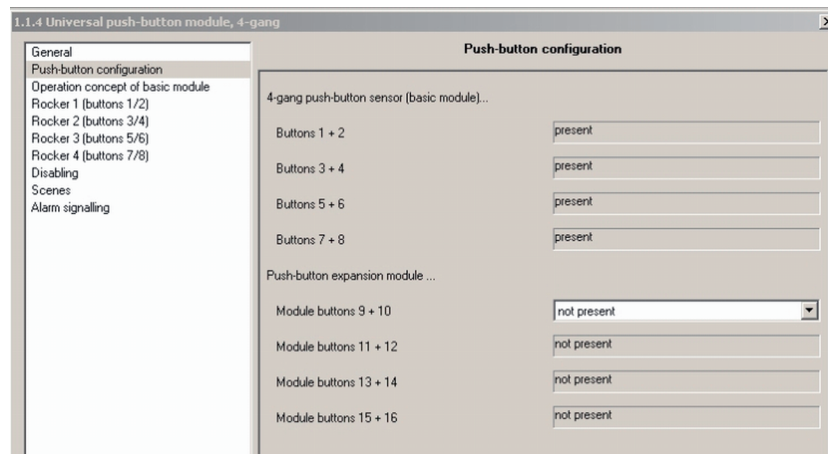

Figure 8: Parameter view for button configuration

The module control surfaces enabled in this manner are displayed and configured in the ETS in the same way as the rockers or buttons of the basic module.

The button numbers of the expansion module depend on the button numbers and therefore the variant of the basic module. In the case of a 4-gang push-button sensor as a basic module, for example, the module buttons 9...16 are created for a 4-gang expansion module. In the case of a

2-gang basic unit, on the other hand, the module buttons 5...12 are created for a 4-gang expansion module, etc.

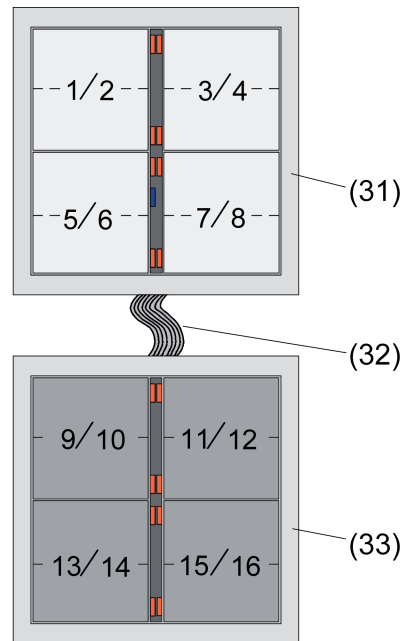

Figure 9: Example of button pair/control surface numbering in connection with a 4-gang module expansion

(31) Push-button sensor basic module (here: 4-gang)

(32) Module connecting cable

(33) Push-button sensor expansion module (here: 4-gang)

4.2.4.1.3 Operation concept and button evaluation

Operation concept and button evaluation

Changeover between rockers and push-button operation of a control surface of the basic or expansion module is performed on the parameter pages "Operation concept of basic module" and "Operation concept of expansion module". The parameter page "Operation concept of expansion module" is only visible if an expansion module has been connected and enabled (see Chapter 1.1 "Button configuration").

The "Operation concept..." parameters specify for each control surface whether the button pair in question is combined into a common rocker function, or alternatively is divided into two separate push-button functions.

The additional parameter pages and the communication objects of the rockers or buttons are then also created and adapted depending on the setting parameterized here.

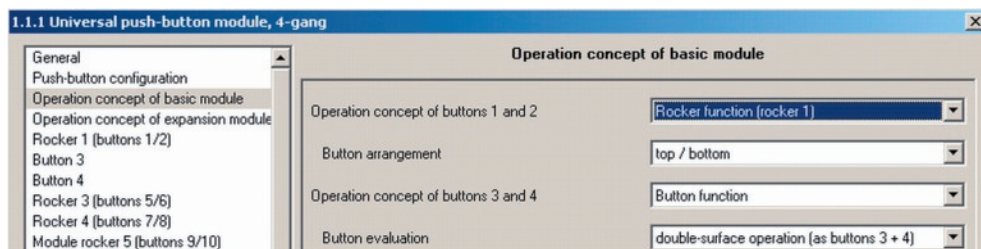

Figure 10: Parameter view for operation concept

- i Pressing several rockers or buttons at the same time will be considered as a wrong operation. The special rocker function "Full-surface operation" is an exception to the above rule. In this case, the programming of the rocker decides whether the operation is a wrong operation or not.

Button pair as rocker function

If a control surface is used as a rocker, both actuation points jointly affect the communication objects that are assigned to the rocker. As a rule, actuation of the two actuation points then result in directly opposite information (e.g. switching: ON - OFF / blind: UP - DOWN). Generally the commands when a button is pressed should be made independently of each other.

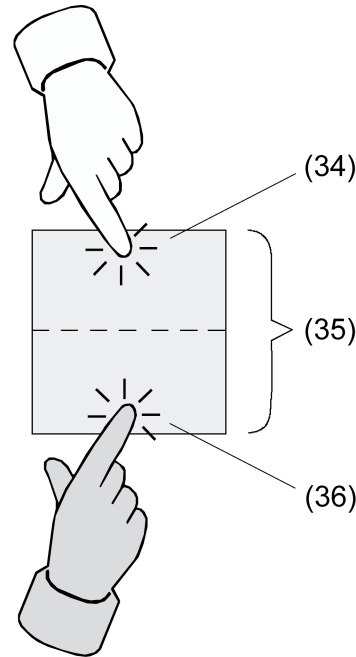

Figure 11: Example for rocker actuation

(34) Control surface as rocker with two actuation points

(35) Actuation point X.1

(36) Actuation point X.2

- i Depending on the button arrangement (see chapter 4.2.4.1.4. Button arrangement) configured in the ETS, the actuation points can be arranged either top / bottom or left / right. The example illustration shows a top / bottom button arrangement.

Full-surface operation with rocker function

Depending on the basic function of a rocker, it is also possible with some settings to use a full-surface actuation with a separate function.

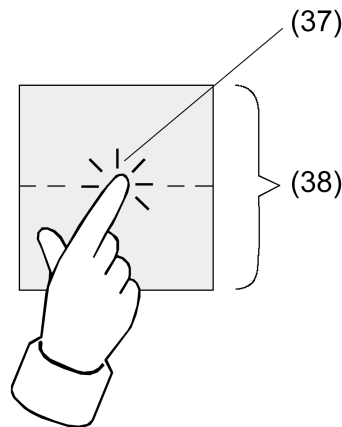

Figure 12: Example of full-surface actuation

(37) Control surface as rocker with full-surface operation

(38) Actuation point for full-surface operation

Button pair as push-button function

In push-button operation, a distinction is made whether the control surface is divided into two separate and functionally independent buttons (double-surface operation), or whether a control surface functions as a single "large" button (single-surface operation).

The parameter "Button evaluation" on the parameter page "Operation concept..." configures either double-surface or single-surface operation for each button pair.

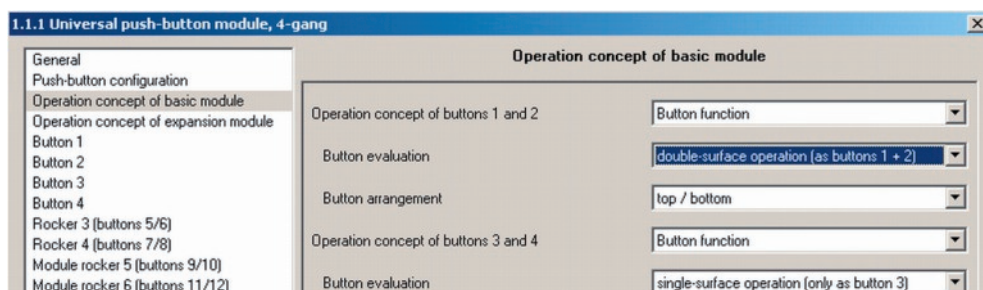

Figure 13: Parameter view for button evaluation

In double-surface operation the buttons are parameterized independently of each other, and can fulfil completely different functions (e.g. switching: TOGGLE – thermostat operating mode: Comfort). Full-surface actuation of a control surface is not possible as a push-button function.

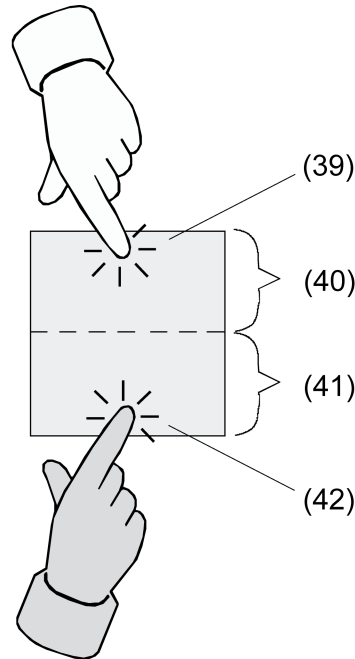

Figure 14: Example of button actuation with double-surface operation

- (39) First part of the control surface as button with a single actuation point
- (40) Second part of the control surface as button with a single actuation point
- (41) Actuation point for button X ($X = 1, 3, 5, \dots$)
- (42) Actuation point for button Y ($Y = 2, 4, 6, \dots$)

i Depending on the button arrangement configured in the ETS (see Chapter 1.3 "Button arrangement", the buttons and thus the actuation points of a control surface can be arranged either top / bottom or left / right for double-surface operation of the buttons. The example illustration shows a top / bottom button arrangement. With single-surface operation the button arrangement cannot be adjusted, because there is only one button per control surface.

In single-surface operation the entire control surface is evaluated only as a single "large" button.

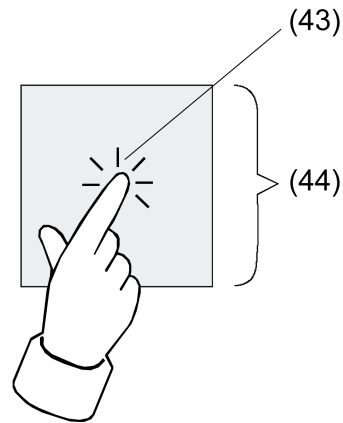

Figure 15: Example of button actuation in single-surface operation

(43) Entire control surface as button with a single actuation point

(44) Actuation point for button X (X = 1, 3, 5, ...)

- i** A control surface is always created in the ETS as a button pair. However, because in single-surface operation only one button functionally exists, the second button of the button pair has no function and is physically not present. During configuration in the ETS it is shown as a "not present" button without any further button parameters. Only the status LED of this button which is physically not used can be configured separately and if needed also activated via its own communication object.
- The physically present button which is to be evaluated in single-surface operation is always created as a button with an uneven button number. If, for example, the first control surface of a push-button sensor is configured to single-surface operation, then button 1 can be configured in the ETS. Button 2 is then the physically not present button without parameters.

4.2.4.1.4 Button arrangement

Button arrangement

On the "Operation concept..." parameter pages, it is possible to set separately for each button pair of a control surface configured in the ETS as a rocker function or as a double-surface push-button function how the buttons are to be arranged on the surface, i.e. where the actuation points are located.

Here the parameter "Button arrangement" specifies the actuation point evaluation.

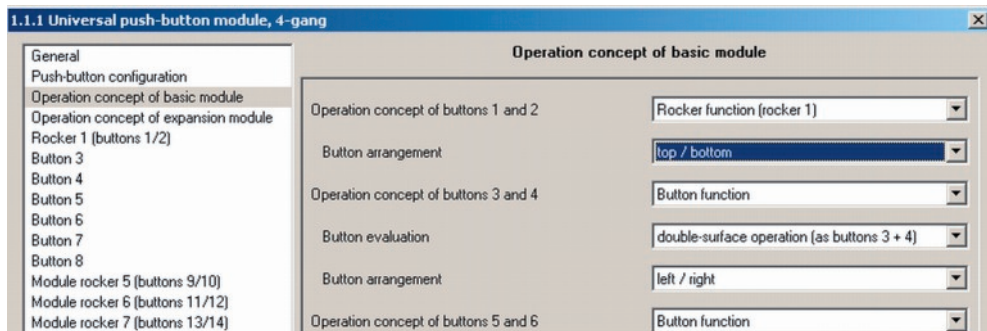

Figure 16: Parameter view for button arrangement

In the default setting the two actuation points of a control surface are arranged vertically (top / bottom) (figure 17). Alternatively the actuation points can be arranged horizontally (left / right) (figure 18).

The illustrations show examples of the button arrangement on a 4-gang universal push-button sensor. The button arrangements on other basic unit variants or on a connected expansion module are similar.

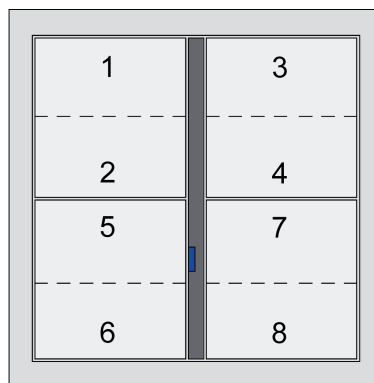

Figure 17: button arrangement "top / bottom"

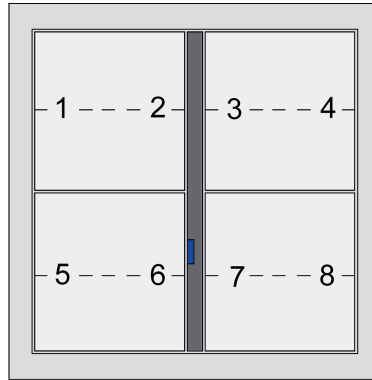

Figure 18: button arrangement "left / right"

It is also possible to combine different button arrangement in the same push-button sensor (figure 19).

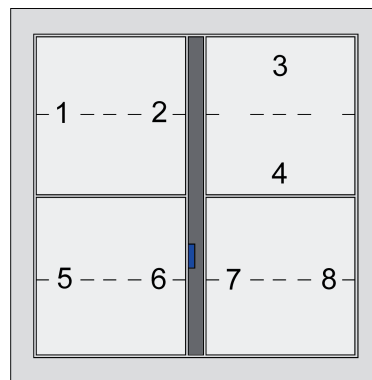

Figure 19: Different button configurations in the same push-button sensor

The configuration can still be changed later on. Assigned group addresses or parameter settings remain unaffected by such changes.

4.2.4.1.5 Operation LED

Operation LED

The blue operation LED of the universal push-button sensor TSM is used for different functions which are in part fixed internal default functions.

- In a non-programmed device (delivery state) or after downloading of a wrong application program, this LED flashes at a slow rate of 0.75 Hz.
- When the push-button sensor is switched over into the programming mode for commissioning or for diagnosis purposes, the LED flashes at a fast rate of about 8 Hz (cf. "Commissioning" in the hardware description of this documentation).
- To confirm the detection of a full-surface press with the rocker function, the LED flashes with 8 Hz, too.

The application software permits selecting parameters for further functions:

- The LED can flash together with all other red status LEDs with a frequency of about 2 Hz, when the communication object for the alarm signalling is active.
- The LED can display the status of a separate communication object in inverted or non-inverted form. Here the operation LED can also be activated as flashing with a frequency of approx. 2 Hz.
- It can be switched on permanently to serve as orientation lighting.
- It can be switched off permanently.
- It can flash continuously at a slow frequency of about 0.75 Hz.

If several of the above states occur at the same time, the priority is as follows:

1. Indication of the programming mode.

The programming mode is cancelled automatically after any actuation.

2. Display of a valid full-surface actuation with the rocker function.

3. Display of an alarm.

The mode of resetting the alarm either automatically by a button-press or by the communication object must be specified in the parameters.

4. The status display for the separate communication object or the permanent states (on, off).

i Only the push-button sensor basic module has an operation LED. There is no operation LED on the expansion module.

4.2.4.1.6 Transmit delay

Transmit delay

After a reset (e.g. after the application program or the physical address is loaded or after the bus voltage is switched on), the push-button sensor for the room thermostat extension unit can transmit telegrams automatically. For the thermostat extension unit the push-button sensor tries by means of read telegrams to request values from the room thermostat in order to update the object states. In the case of room temperature measurement the push-button sensor transmits the current room temperature to the bus after a reset.

If in addition to the push-button sensor there are still other devices installed in the bus which transmit telegrams immediately after a reset, it may be useful to activate the transmit delay for automatically transmitting objects on the "General" page in order to reduce the bus load.

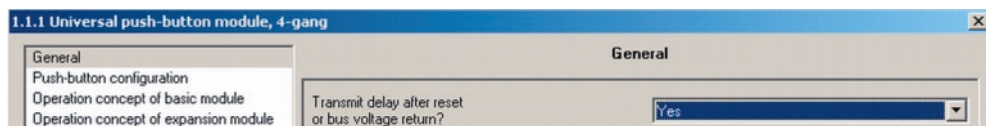

Figure 20: Parameter view for transmit delay

When transmit delay is activated, the push-button sensor determines the value of its individual delay from the device number of its physical address (phys. address: area.line.device number). This value can be about 30 seconds maximum. Without setting a special delay, this principle prevents several universal push-button sensors TSM from trying to transmit telegrams to the bus at the same time.

- i** The transmit delay is not active for the rocker and button functions of the push-button sensor.

4.2.4.2 Rockers and push-button functions

Rockers and push-button function

The following contains descriptions of the various functions that can be configured for each rocker or each button of the push-button sensor. The functions can be parameterized freely and without limitations for both the basic unit and for the push-button sensor expansion module.

4.2.4.2.1 "Switching" function

"Switching" function

For each rocker or each button with the function set to "switching" the ETS indicates a 1-bit communication object. The parameters of the rocker or button permit fixing the value this object is to adopt on pressing and / or on releasing (ON, OFF, TOGGLE – toggling of the object value). No distinction is made between a brief or long press.

The status LEDs can be parameterized independently (see chapter 4.2.4.3. Status LED).

4.2.4.2.2 "Dimming" function

"Dimming" function

For each rocker or each button with the function set to "dimming" the ETS indicates a 1-bit and a 4-bit object. Generally, the push-button sensor sends a switching telegram after a brief press and a dimming telegram after a long press. In the default parameterization, the push-button sensor transmits a telegram for stopping the dimming action after a long press. The time needed by the push-button sensor to detect an actuation as a long actuation can be set in the parameters.

The status LEDs can be parameterized independently (see chapter 4.2.4.3. Status LED).

Single-surface and double-surface operation in the dimming function

In the rocker function, the device is preprogrammed for double-surface operation for the dimming function. This means for example that the push-button sensor transmits a telegram for switching on after a brief press and a telegram for increasing the brightness after a long press on the upper actuation point. Similarly, the push-button sensor transmits a telegram for switching off after a brief press and a telegram for reducing the brightness after a long press on the lower actuation point.

In the separate buttons function, the device is preprogrammed for single-surface actuation for the dimming function. In this mode, the push-button sensor transmits on each brief press ON and OFF telegrams in an alternating pattern ("TOGGLE"). After a long press, the push-button sensor transmits "brighter" and "darker" telegrams in an alternating pattern.

The parameter "Command on pressing the button" or "Command on pressing the rocker" on the parameter pages of the buttons or rockers defines the single-surface or double-surface operation principle for the dimming function.

For the rocker and also for the button function, the command issued on pressing the button or rocker can basically be selected at the user's discretion.

If the actuator can be controlled from several sensors, a faultless single-surface operation requires that the addressed actuator reports its switching state back to the 1-bit object of the button or rocker and that the 4-bit objects of the push-button sensors are interlinked. The push-button sensor would otherwise not be able to detect that the actuator has been addressed from another sensor, in which case it would have to be actuated twice during the next use in order to produce the desired reaction.

Advanced parameters

For the dimming function, the push-button sensor can be programmed with advanced parameters which are hidden in the standard view for greater clarity. If necessary, these advanced parameters can be activated and thus be made accessible.

The advanced parameters can be used to determine whether the push-button sensor is to cover the full adjusting range of the actuator with one dimming telegram continuously ("Increase brightness by 100 %", "Reduce brightness by 100 %") or whether the dimming range is to be divided into several small steps (50 %, 25 %, 12.5 %, 6 %, 3 %, 1.5 %).

In the continuous dimming mode (100%), the push-button sensor transmits a telegram only at the beginning of the long press to start the dimming process and generally a stop telegram after the end of the press. For dimming in small steps it may be useful if the push-button sensor repeats the dimming telegram in case of a sustained press for a presettable time (parameter

"Telegram repetition"). The stop telegram after the end of the press is then not needed.

When the parameters are hidden ("Advanced parameters = deactivated"), the dimming range is set to 100 %, the stop telegram is activated and the telegram repetition is deactivated.

Full-surface operation

When a rocker is used for dimming, the push-button sensor needs some time at the beginning of each operation in order to distinguish between a short and a long operation. When the full-surface operation is enabled, the push-button sensor can make use of this time span to evaluate the otherwise invalid simultaneous actuation of both actuation points.

The push-button sensor detects a full-surface operation of a rocker, if a control surface is depressed over a large area so that both actuation points of the rocker are actuated. When the push-button sensor has detected a valid full-surface actuation, the operation LED flashes fast at a rate of about 8 Hz for the duration of such actuation. The full-surface operation must have been detected before the first telegram has been transmitted by the dimming function (switching or dimming). If this is not so, even a full-surface operation will be interpreted as a wrong operation and not be executed.

A full-surface operation is independent. It has a communication object of its own and can optionally be used for switching (ON, OFF, TOGGLE – toggling of the object value) or for scene recall without or with storage function. In the last case, the full-surface actuation causes a scene to be recalled in less than a second. If the push-button sensor is to send the telegram for storing a scene, the full-surface operation must be maintained for more than five seconds. If the full-surface operation ends between the first and the fifth second, the push-button sensor will not send any telegrams. If the status LEDs of the rocker are used as "button-press indicators", they will light up for three seconds during transmission of the storage telegram.

- i Full-surface operation as described in this chapter cannot be parameterized for the push-button functions. There it is possible to configure the single-surface principle, which also allows a control surface to be depressed at the centre or over a large area.

4.2.4.2.3 "Blind" function

"Blind" function

For each rocker or each button with the function set to "blind" the ETS indicates the two 1-bit objects "STEP operation" and "MOVE operation".

The status LEDs can be parameterized independently (see chapter 4.2.4.3. Status LED).

Operation concept for the blind function

For the control of blind, shutter, awning or similar drives, the push-button sensor supports four operation concepts in which the telegrams are transmitted in different time sequences. The push-button can therefore be used to control a wide variety of drive configurations. The different operation concepts are described in detail in the following chapters.

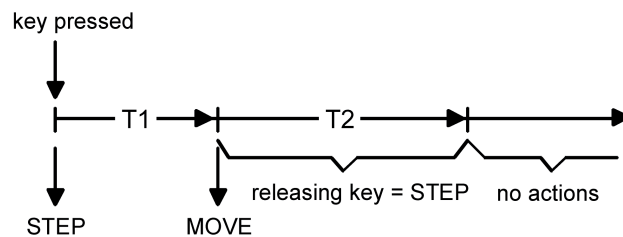

Figure 21: Operation concept "short – long – short"

Operation concept "short – long – short":

In the operation concept "short – long – short", the push-button sensor shows the following behaviour:

- Immediately on pressing the button, the push-button sensor transmits a STEP telegram. Pressing the button stops a running drive and starts time T1 ("time between STEP and MOVE command"). If the button is released within T1, no further telegram will be transmitted. This STEP serves the purpose of stopping a continuous move. The "time between STEP and MOVE command" in the push-button sensor should be selected shorter than the STEP operation of the actuator to prevent a jerky movement of the blind.
- If the button is kept depressed longer than T1, the push-button sensor transmits a MOVE telegram after the end of T1 for starting up the drive and time T2 ("slat adjustment time") is started.
- If the button is released within the slat adjustment time, the push-button sensor sends another STEP telegram. This function is used for adjusting the slats of a blind. The function permits stopping the slats in any position during their rotation. The "slat adjustment time" should be chosen as required by the drive for a complete rotation of the slats. If the slat adjustment time is selected longer than the complete running time of the drive, a push-button function is possible as well. This means that the drive is active only when the button is kept depressed.
- If the button is kept depressed longer than T2, the push-button sensor transmits no further telegram. The drive remains on until the end position is reached.

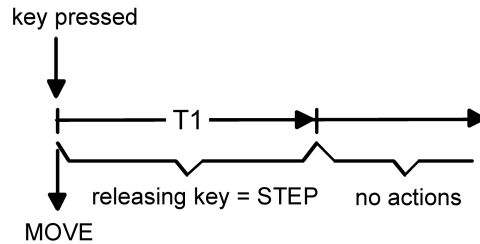

Figure 22: Operation concept "long – short"

Operation concept "long – short":

If the operation concept "long – short" is selected, the push-button sensor shows the following behaviour:

- Immediately on pressing the button, the push-button sensor transmits a MOVE telegram. The drive begins to move and time T1 ("slat adjustment time") is started.
- If the button is released within the slat adjustment time, the push-button sensor transmits a STEP telegram. This function is used for adjusting the slats of a blind. The function permits stopping the slats in any position during their rotation. The "slat adjustment time" should be chosen as required by the drive for a complete rotation of the slats. If the slat adjustment time is selected longer than the complete running time of the drive, a push-button function is possible as well. This means that the drive is active only when the button is kept depressed.
- If the button is kept depressed longer than T1, the push-button sensor transmits no further telegram. The drive remains on until the end position is reached.

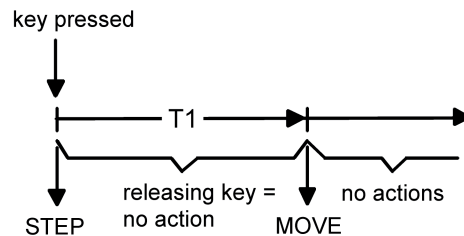

Figure 23: Operation concept "short – long"

Operation concept "short – long"

In the operation concept "short – long", the push-button sensor shows the following behaviour:

- Immediately on pressing the button, the push-button sensor transmits a STEP telegram. Pressing the button stops a running drive and starts time T1 ("time between STEP and MOVE command"). If the button is released within T1, no further telegram will be transmitted. This STEP serves the purpose of stopping a continuous move. The "time between STEP and MOVE command" in the push-button sensor should be selected shorter than the STEP operation of the actuator to prevent a jerky movement of the blind.
- If the button is kept depressed longer than T1, the push-button sensor transmits a MOVE telegram after the end of T1 for starting the drive.
- No further telegram is transmitted when the button is released. The drive remains on until the end position is reached.

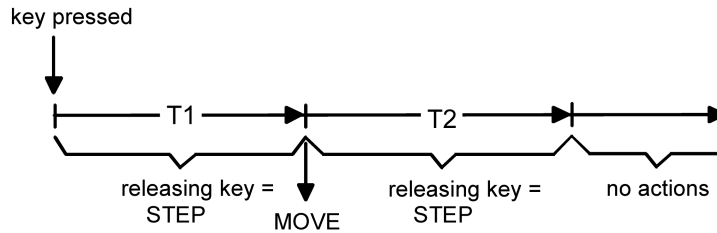

Figure 24: Operation concept "long – short or short"

Operation concept "long – short or short":

In the operation concept "long – short or short", the push-button sensor shows the following behaviour:

- Immediately on pressing the button, the push-button sensor starts time T1 ("time between STEP and MOVE command") and waits. If the button is released again before T1 has elapsed, the push-button sensor transmits a STEP telegram. This telegram can be used to stop a running drive. A stationary drive rotates the slats by one step.
- If the button is kept depressed after T1 has elapsed, the push-button sensor transmits a MOVE telegram and starts time T2 ("slat adjustment time").
- If the button is released within T2, the push-button sensor sends another STEP telegram. This function is used for adjusting the slats of a blind. The function permits stopping the slats in any position during their rotation. The "slat adjustment time" should be chosen as required by the drive for a complete rotation of the slats. If the slat adjustment time is selected longer than the complete running time of the drive, a push-button function is possible as well. This means that the drive is active only when the button is kept depressed.
- If the button is kept depressed longer than T2, the push-button sensor transmits no further telegram. The drive remains on until the end position is reached.

- i** In this operation concept, the push-button sensor will not transmit a telegram immediately after depressing one side of the rocker. This principle permits detecting a full-surface operation when the sensor is configured as a rocker.

Single-surface and double-surface operation in the blind function

As a rocker, the device is preprogrammed for double-surface actuation for the blind function. This means that the push-button sensor transmits a telegram for an upward move after an actuation of the upper actuation point and a telegram for a downward move after an actuation of the lower actuation point.

In the separate buttons function, the device is preprogrammed for single-surface actuation for the blind function. In this case, the push-button sensor alternates between the directions of the MOVE telegram (TOGGLE) on each long actuation of the sensor. Several STEP telegrams in succession have the same direction.

The parameter "Command on pressing the button" or "Command on pressing the rocker" on the parameter pages of the buttons or rockers defines the single-surface or double-surface operation principle for the blind function.

For the button function, the command issued on pressing the button can basically be selected at the user's discretion.

If the actuator can be controlled from several sensors, a faultless single-surface actuation requires that the MOVE objects of the push-button sensors are interlinked. The push-button sensor would otherwise not be able to detect that the actuator has been addressed from

another sensor, in which case it would have to be actuated twice during the next use in order to produce the desired reaction.

Full-surface operation with blind function

When a rocker is programmed for blind operation and if the operation concept "long – short or short" is used, the push-button sensor needs some time at the beginning of each operation in order to distinguish between a short and a long operation. When the full-surface operation is enabled, the push-button sensor can make use of this time span to evaluate the otherwise invalid simultaneous actuation of both actuation points.

The push-button sensor detects a full-surface operation of a rocker, if a control surface is depressed over a large area so that both actuation points of the rocker are actuated. When the push-button sensor has detected a valid full-surface actuation, the operation LED flashes fast at a rate of about 8 Hz for the duration of such actuation. The full-surface operation must have been detected before the first telegram has been transmitted by the blind function (STEP or MOVE). If this is not so, even a full-surface operation will be interpreted as a wrong operation and not be executed.

A full-surface operation is independent. It has a communication object of its own and can optionally be used for switching (ON, OFF, TOGGLE – toggling of the object value) or for scene recall without or with storage function. In the last case, the full-surface actuation causes a scene to be recalled in less than a second. If the push-button sensor is to send the telegram for storing a scene, the full-surface operation must be maintained for more than five seconds. If the full-surface operation ends between the first and the fifth second, the push-button sensor will not send any telegrams. If the status LEDs of the rocker are used as "button-press indicators", they will light up for three seconds during transmission of the storage telegram.

- i** Full-surface operation as described in this chapter cannot be parameterized for the push-button functions. There it is possible to configure the single-surface principle, which also allows a control surface to be depressed at the centre or over a large area.

4.2.4.2.4 "Value transmitter" function

"1-byte value transmitter" and "2-byte value transmitter" functions

For each rocker or each button with the function set to "1-byte value transmitter" or "2-byte value transmitter" the ETS indicates a corresponding object. On the press of a button, the parameterized value or the value last stored internally by a value change (see below) will be transmitted to the bus. In case of the rocker function, different values can be parameterized or varied for both actuation points.

The status LEDs can be parameterized independently (see chapter 4.2.4.3. Status LED).

Value ranges

The "Function" parameter determines the value range used by the push-button.

As a 1-byte value transmitter, the push-button sensor can optionally transmit integers from 0 ... 255 or relative values within a range of 0 ... 100 % (e.g. as dimming value transmitter).

As a 2-byte value transmitter, the push-button sensor can optionally transmit integers from 0 ... 65535, temperature values within a range of 0 ... 40 °C or brightness values from 0 ... 1500 lux.

For each of these ranges, the value that can be transmitted to the bus for each actuation of a rocker or button is parameterizable.

Adjustment by means of long button-press

If the value adjustment feature has been enabled in the ETS, the button must be kept depressed for more than 5 seconds in order to vary the current value of the value transmitter. The value adjustment function continues to be active until the button is released again. In a value adjustment, the push-button sensor distinguishes the following options...

- The "Starting value in case of value adjustment" parameter defines the original starting value for the adjustment. Adjustment can begin from the value parameterized in the ETS, from the final value of the last adjustment cycle or from the current value of the communication object, with the last option not being available for the temperature and brightness value transmitter.
- The parameter "Direction of value adjustment" defines whether the values will always be increased ("upwards"), always reduced ("downwards") or alternately increased and reduced ("toggling").
- For the value transmitters 0 ... 255, 0 ... 100 % and 0 ... 65535, the "Step size" by which the current value is to be changed during the value adjustment can be specified. In case of the temperature and the brightness value transmitter, the step size specifications (1 °C and 50 lux) are fixed.
- The parameter "Time between two telegrams" can be used in conjunction with the step size to define the time required to cycle through the full respective value range. This value defines the time span between two value transmissions.
- When the push-button sensor detects during the value adjustment that the preset step size would result in the limits being exceeded with the next telegram, it adapts the step size once in such a way that the respective limit value is transmitted together with last telegram. Depending on the setting of the parameter "Value adjustment with overflow ?", the push-button sensor stops the adjustment at this instance or inserts a pause consisting of two steps and then continues the adjustment beginning with the other limit value.

Limits of the value ranges of the various value transmitters:

	Function	Lower limit	Upper limit
1-byte value transmitter	0...255	0	255
1-byte value transmitter	0...100 %	0 % (value = 0)	100 % (value = 255)
2-byte value transmitter	0...65535	0	65535
2-byte value transmitter	Temperature value	0 °C	40 °C
2-byte value transmitter	Brightness value	0 lux	1.500 lux

- i** During a value adjustment, the newly adjusted values are only in the volatile RAM memory of the push-button sensor. Therefore, the stored values are replaced by the preset values programmed in the ETS when a reset of the push-button sensor occurs (bus voltage failure or ETS programming).
- i** During a value adjustment, the status LED of the corresponding button is switched off irrespective of parameterization. The status LED will then light up for ca. 250 ms whenever a new value is transmitted.
- i** With the 1-byte value transmitter in the "Value transmitter 0...100 %" function, the step size of the adjustment will also be indicated in "%". If the starting value of the communication object is used, it may happen in this case during value adjustment that the value last received via the object must be rounded and adapted before a new value can be calculated on the basis of the step size and transmitted. Due to the computation procedure used, the new calculation of the value may be slightly inaccurate.

Value adjustment examples

Example parameterization:

- 1-byte value transmitter (all other value transmitters similar)
- function = value transmitter 0...255
- value configured in the ETS (0...255) = 227
- step size (1...10) = 5
- start on value adjustment = same as parameterized value
- direction of value adjustment = switch-over (alternating)
- Time between two telegrams = 0.5 s

Example 1: value adjustment with overflow? = No

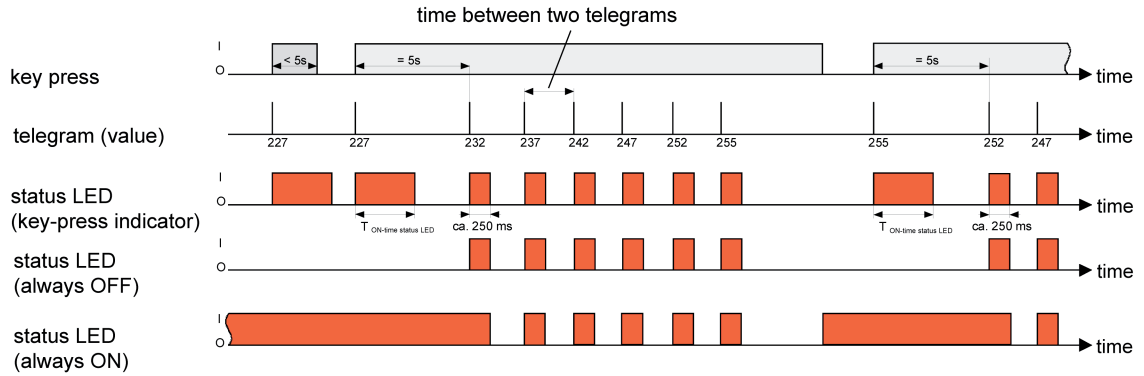

Figure 25: Example of value adjustment without value range overflow

Example 2: value adjustment with overflow? = Yes

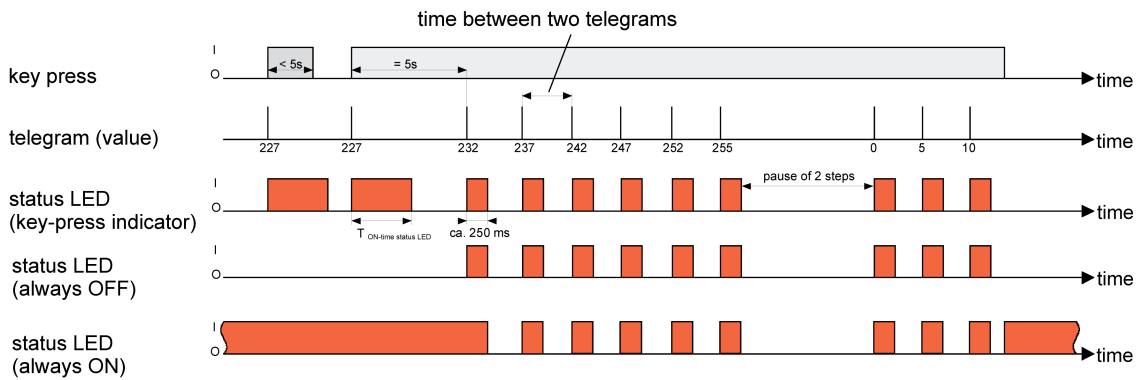

Figure 26: Example of value adjustment with value range overflow

4.2.4.2.5 "Scene extension" function

"Scene extension" function

For each rocker or each button with the function set to "scene extension" the ETS indicates the "Function" parameter which distinguishes between the settings...

- "scene extension without storage function"
- "scene extension with storage function"
- "recall of internal scene without storage function"
- "recall of internal scene extension with storage function".

...unterscheidet.

In the scene extension function, the push-button sensor transmits a preset scene number (1...64) via a separate communication object to the bus after a button-press. This feature permits recalling scenes stored in other devices and also storing them, if the storage function is used.

The recall of an internal scene does not result in a telegram being transmitted to the bus. For this reason, the corresponding communication object is missing. This function can rather be used to recall – and with the storage function also to store – the up to 8 scenes stored internally in the universal push-button sensor TSM.

In the setting "... without storage function", a button-press triggers the simple recall of a scene. If the status LED is parameterized as button-press indicator, it will be switched on for the parameterized ON-time. A long button-press has no further or additional effect.

In the setting "... with storage function", the push-button sensor monitors the length of the actuation. A button-press of less than a second results in a simple recall of the scene as mentioned above. If the status LED is parameterized as button-press indicator, it will be switched on for the parameterized ON-time.

After a button-press of more than five seconds, the push-button sensor generates a storage instruction. In the scene extension function, a storage telegram is in this case transmitted to the bus. If configured for the recall of an internal scene, the sensor will store the internal scene. The internal scene control module of the universal push-button sensor TSM will then request the current scene values for the actuator groups used from the bus (cf. chapter "9 Scene control") An actuation lasting between one and five seconds will be discarded as invalid.

The parameter "Scene number" specifies which of the maximum of 8 internal or 64 external scenes is to be used after a button-press. In case of the rocker function, two different scene numbers can be assigned.

The status LEDs can be parameterized independently (see chapter 4.2.4.3. Status LED).

4.2.4.2.6 "2-channel operation" function

"2-channel operation" function

In some situations it is desirable to control two different functions with a single button-press and to transmit different telegrams, i.e. to operate two function channels at a time. This is possible with the "2-channel operation" function.

For both channels, the parameters "Function channel 1" and "Function channel 2" can be used to determine the communication object types to be used. The following types are available for selection...

- switching (1 bit)
- value transmitter 0 ... 255 (1 byte)
- value transmitter 0 ... 100 % (1 byte)
- temperature value transmitter (2 bytes)

The object value the push-button sensor is to transmit on a button-press can be selected depending on the selected object type. The "Switching (1 bit)" type permits selecting whether an ON or an OFF telegram is to be transmitted or whether the object value is to be switched over (TOGGLE) and transmitted on the press of a button.

The parameterization as "Value transmitter 0 ... 255 (1 byte)" or as "Value transmitter 0 ... 100 % (1 byte)" permits entering the object value freely within a range from 0 to 255 or from 0% to 100%.

The "Temperature value transmitter (2 bytes)" permits selecting a temperature value between 0°C and 40°C.

In this case, the adjustment of the object value on a long button-press is not possible as the determination of the actuation length is needed for the adjustable operation concepts.

Unlike in the other rocker and button functions, the application software assigns the "Telegram acknowledge" function instead of the "Button-press indicator" function to the status LED. In this mode, the status LED lights up for about 250 ms with each telegram transmitted. As an alternative, the status LEDs can be parameterized independently (see chapter 4.2.4.3. Status LED).

Operation concept channel 1 or channel 2

In this operation concept, exactly one telegram will be transmitted on each press of a button.

- On a brief press the push-button sensor transmits the telegram for channel 1.
- On a long press the push-button sensor transmits the telegram for channel 2.

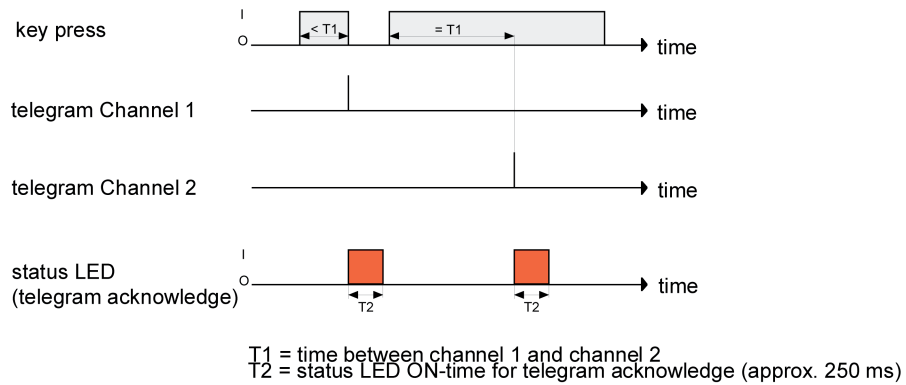

Figure 27: Example of operation concept "Channel 1 or Channel 2"

The time required for distinguishing between a short and a long actuation is defined by the parameter "Time between channel 1 and channel 2". If the button is pressed for less than the parameterized time, only the telegram to channel 1 is transmitted. If the length of the button-press exceeds the time between channel 1 and channel 2, only the telegram to channel 2 will be transmitted. This concept provides the transmission of only one channel. To indicate that a telegram has been transmitted, the status LED lights up for ca. 250 ms in the "Telegram acknowledge" mode.

In this operation concept, the push-button sensor will not transmit a telegram immediately after the rocker has been depressed. This principle permits detecting also a full-surface operation. The settings that are possible with full-surface operation are described below.

Operation concept channel 1 and channel 2

With this operation concept, one or alternatively two telegrams can be transmitted on each button-press.

- On a brief press the push-button sensor transmits the telegram for channel 1.
- A long press causes the push-button sensor to transmit first the telegram for channel 1 and then the telegram for channel 2.

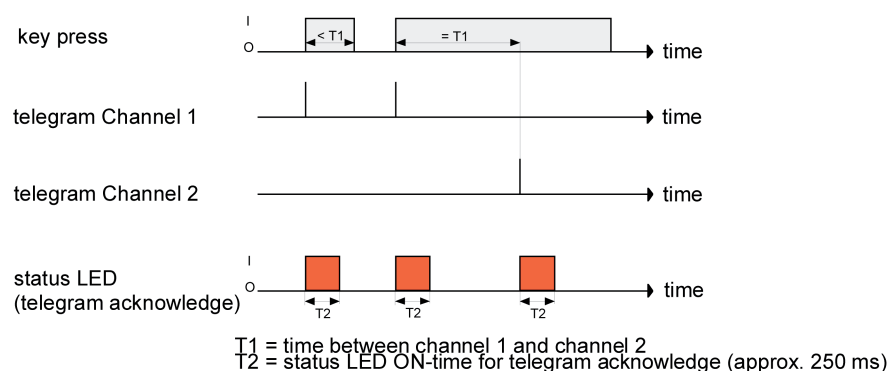

Figure 28: Example of operation concept "Channel 1 and Channel 2"

The time required for distinguishing between a short and a long actuation is defined by the parameter "Time between channel 1 and channel 2". In this operation concept, a button-press sends this telegram immediately to channel 1. If the button is held depressed for the parameterized time, the telegram for the second channel is transmitted as well. If the button is

released before the time has elapsed, no further telegram will be transmitted. This operation concept, too, offers the parameterizable possibility of having the transmission of a telegram signalled by the status LED (setting "Telegram acknowledge").

Full-surface operation with 2-channel operation

When a rocker is programmed for 2-channel operation and if the operation concept "channel 1 or channel 2" is used, the push-button sensor needs some time at the beginning of each operation in order to distinguish between a short and a long operation. When the full-surface operation is enabled, the push-button sensor can make use of this time span to evaluate the otherwise invalid simultaneous actuation of both actuation points.

The push-button sensor detects a full-surface operation of a rocker if a control surface is depressed over a large area so that both actuation points of the rocker are actuated. When the push-button sensor has detected a valid full-surface actuation, the operation LED flashes fast at a rate of about 8 Hz for the duration of such actuation. The full-surface operation must have been detected before the first telegram has been transmitted by the 2-channel function. If this is not so, even a full-surface operation will be interpreted as a wrong operation and not be executed.

4.2.4.3 Status LED

Status LEDs

Each control surface on the push-button sensor basic unit or on the expansion module has two status LEDs. The functions available differ slightly depending on the configuration of the rockers or buttons.

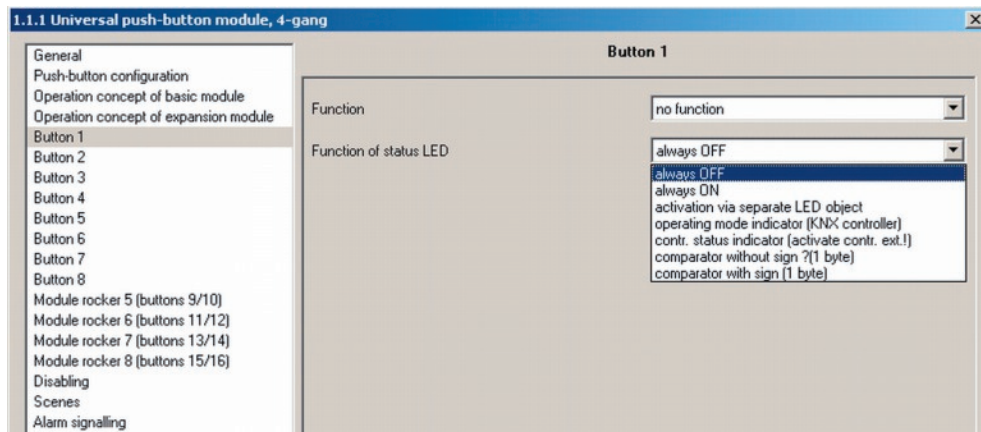

Figure 29: Parameter view for a status LED

Each status LED distinguishes the following options...

- always OFF,
- always ON,
- Activation via separate LED object,
- operating mode indication (KNX controller),
- controller status indicator (activate controller extension!),
- comparator without sign (1 byte),
- comparator with sign (1 byte).

These options are always available even if the buttons have no function assigned.

If a function has been assigned to the rocker or button, the ETS displays moreover the option...

- button-press indicator

...which in the function "2-channel operation" are replaced by...

- telegram acknowledge.

If the rocker or the button is used for switching or dimming, the following options can be selected in addition...

- status indicator (switching object)
- inverted status indicator (switching object).

If a button is used for the operation of a controller extension, the following options can be selected in addition...

- button function active / inactive indicator (only with presence button),
- setpoint value shift indicator (only with setpoint shift).

- i** Besides the functions that can be set separately for each status LED, all status LEDs are also used together with the operation LED for alarm signalling. If this is active, all LEDs of the push-button sensor flash simultaneously. After deactivation of the alarm signalling, all LEDs will immediately return to the state corresponding to their parameterization and communication objects.

Status LED function "always OFF" or "always ON"

A status LED used as button-press indicator is switched on by the sensor each time the corresponding rocker or button is pressed. The parameter "ON-time of status LEDs as actuation indicators" on the parameter page "General" specifies for how long the LED is switched on in common for all status LEDs. The status LED lights up when the rocker or button is pressed even if the telegram is transmitted by the sensor only when the button or rocker is released.

With the function "2-channel operation" the option "button-press indicator" is replaced by "telegram acknowledge". In this case the status LED is illuminated when both channels are transmitted for about 250 ms each.

Function of the status LED "Activation via separate LED object", "Status indicator", and "Inverted status indicator"

Each status LED can indicate the status of a separate LED communication object independently of the rocker or push-button configuration. Here the LED can be switched on or off statically via the received 1 bit object value, or also activated by flashing. Each status LED can indicate the state of a separate LED communication object independently of the rocker or push-button configuration. Here the LED can be switched on or off statically via the 1-bit object value received, or also activated as flashing.

Additionally, the status LEDs can be linked in the rocker or button functions "switching" and "dimming" also with the object used for switching and thus signal the current switching state of the actuator group.

Both for the status indication of the LED object and also for the status indication of the switching object it is possible to indicate or evaluate the inverted object value.

After a reset of the universal push-button sensor TSM or after ETS programming, the value of the LED object is always "OFF".

Function of status LED as "operating mode indicator (KNX controller)"

For switching over between different modes of operation, new room thermostats can make use of two communication objects of the 20.102 "HVAC-Mode" data type. One of these objects can switch over with normal priority between the modes of operation "comfort", "standby", "night", "frost/heat protection". The second object has a higher priority. It permits switching over between "automatic", "comfort", "standby", "night", "frost/heat protection". Automatic means in this case that the object with the lower priority is active.

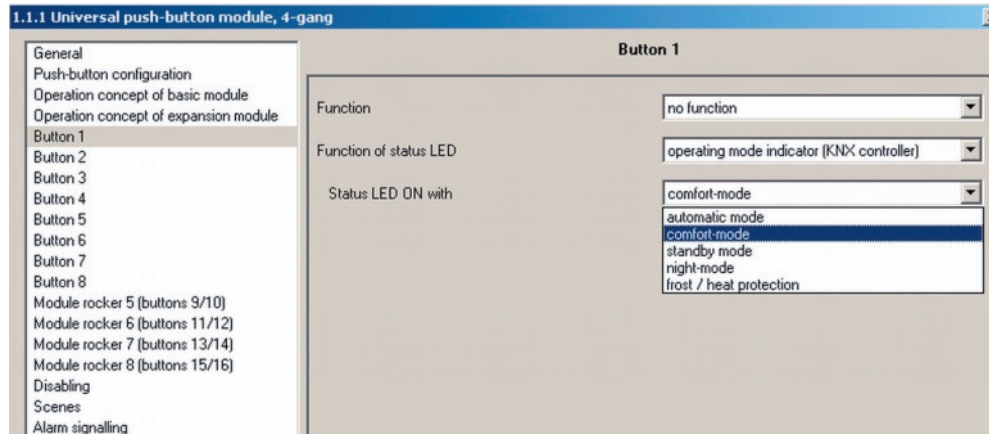

Figure 30: Parameter view for a status LED as an operating mode indication

If a status LED is to indicate the operating mode, the communication object of the status LED must be linked with the matching object of the room thermostat. The desired mode which the LED is to indicate can then be selected with the parameter "Status LED on with". The LED is then lit up when the corresponding mode of operation has been activated at the controller.

After a reset of the universal push-button sensor TSM or after programming with the ETS, the value of the LED object is always "0" (automatic).

Function of status LED as "controller status indicator"



If a status LED is to indicate the status of a room thermostat, the thermostat extension must have been activated on parameter page "General". The status LED is then internally linked directly with the 1-byte object "Controller status" of the controller extension. This object must then be linked via a group address with the corresponding communication object of the controller.

The object "Controller status" groups eight different information units in a bit-oriented way in a byte. For this reason it is important to select in the "Status LED on with" parameter which information is to be indicated, i.e. which bit is to be evaluated.

The following can be selected...

- Bit 0: Comfort-mode
- Bit 1: Standby-mode
- Bit 2: Night-mode
- Bit 3: frost/heat protection
- Bit 4: controller disabled
- Bit 5: heating / cooling (heating = 1 / cooling = 0)
- Bit 6: controller inactive (dead zone operation)
- Bit 7: frost alarm

Description of bit-oriented status messages of the room thermostat (active = ON)

Comfort mode: active if operation mode "comfort  or comfort extension "  or "  is activated.

Standby-mode: active if the "standby " operating mode is activated.

Night-mode: active if the "night " operating mode is activated.

Frost/heat protection: active if the "frost/heat protection " operating mode is activated.

Controller disabled: active if controller disable is activated (dew point mode).

Heating/cooling: active if heating is activated and inactive if cooling is activated. (as a rule inactive with controller disabled.)

Controller inactive: Active with the "heating and cooling" operating mode when the measured room temperature lies within the dead zone. This status information is as a rule always "0" for the individual operating modes "heating" or "cooling"! (inactive if controller is disabled.)

Frost alarm: active if the measured room temperature reaches or drops below + 5 °C.

The communication object "Controller status" of the controller extension updates itself automatically after a reset of the universal push-button sensor TSM or after ETS programming, if the parameter "Value request from controller extension?" on parameter page "General" is set to "Yes". Updating is effected by means of a value read telegram to the room thermostat. The thermostat must answer the request with a value return telegram. If the push-button sensor does not receive the answer, the status LED remains off (object value "0"). In this case, the object must first be actively rewritten by the bus after a reset before a status information can be indicated by the LED.

This is also the case when the parameter "Value request from controller extension" is set to "No".

Function of status LED as "comparator"

The status LED can indicate whether a parameterized reference value is greater than, equal to or less than the 1-byte object value of the status object. This comparator can be used for unsigned (0 ... 255) or for signed integers (-128 ... 127). The data format of the comparison is defined by the function of the status LED.

The status LED lights up only if the comparison is "true".

-  After a reset of the universal push-button sensor TSM or after ETS programming, the value of the LED object is always "0".

4.2.4.4 Scene control

Scene control

The push-button sensor can be used in two different ways as part of a scene control system...

- Each rocker or button can work as a scene extension. This feature makes it possible to recall or to store scenes which may be stored in other devices (see chapter 4.2.4.2.5. "Scene extension" function).
- The push-button can independently store up to eight scenes with eight actuator groups. These internal scenes can be recalled or stored by the rockers or buttons (internal scene recall) and also by the communication object "scene extension".
In the following subsections the internal scene function will be dealt with in greater detail.

4.2.4.4.1 Scene definition and scene recall

Scene definition and scene recall

If the internal scenes are to be used, the parameter "Scene function ?" on parameter page "Scenes" must be set to "Yes". When the scene function is activated, the ETS renames the "Scenes" page "Scene data types"

The matching data types for the eight scene outputs must then be selected and adapted to the actuator groups used. The types "Switching", "Value (0 ... 255)" or "Value / blind position (0 ... 100 %)" can be selected. As a rule, blinds are controlled via two scene outputs. One output controls the blind height and the other one adjusts the slat position.

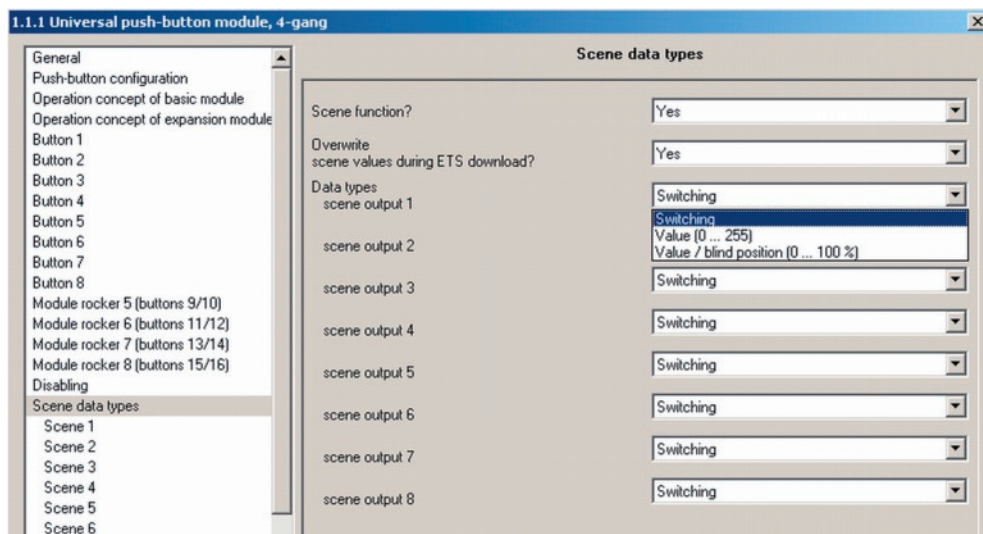

Figure 31: Parameter view for scene definition

The ETS sets the corresponding communication objects and the parameters of the scene commands on the following parameter pages "Scene 1" to "Scene 8".

It is possible that the values for the individual scenes preset by the parameters are modified later on with the storage function (see chapter 4.2.4.4.2. Storing scenes) when the system is in operation. If the application program is then loaded again with the ETS, these locally adapted values will normally be overwritten by the parameters. Due to the fact that it may take considerable efforts to readjust the values for all scenes in the system, the parameter "Overwrite scene values during ETS download?" offers the possibility of retaining the scene

values stored in operation without overwriting them.

The scene parameters can be set on the parameter page of each individual scene ("Scene 1 ... 8"). The setting options are the same for all of the up to 8 scenes.

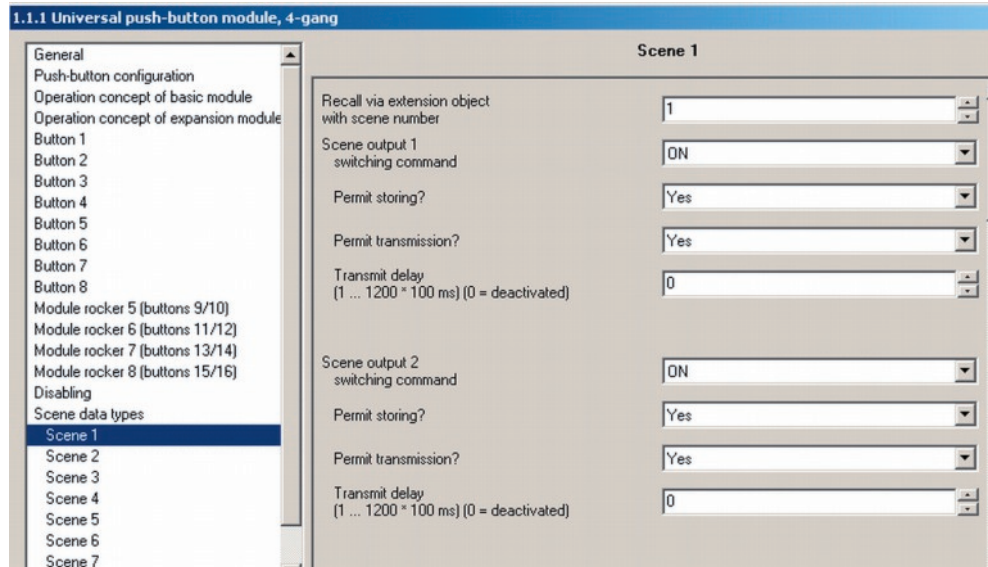

Figure 32: Parameter view for individual scene parameters

These internal scenes can be recalled directly via the rockers or buttons (function "recall internal scene") and also by another bus device via the "Extension input" communication object. This 1-byte communication object supports the evaluation of up to 64 scene numbers. For this reason it must be specified which of the external scene numbers (1 ... 64) is to recall the internal scene (1 ... 8). If the same scene number is listed for several internal scenes, it is always only the first of these scenes that will be activated (scene with the lowest scene number).

In some situations there may be the requirement that a group of actuators is not controlled by all, but only by certain scenes. A classroom, for instance, may require open blinds for the "Welcome" and "Break" scenes, closed blinds in the "PC-presentation" scene and no change in the "Discussion" scene. In this example, the parameter "Permit transmission?" can be set to "No" for the "Discussion" scene. The scene output is then deactivated during the corresponding scene.

The parameter "Transmit delay" permits entering an individual waiting time for each scene output. This transmit delay can be used in different situations...

- When the actuators participating in a scene transmit status messages automatically or when several scene buttons are used to increase the number of channels within the scenes, the recall of a scene may result for a short time in high bus loading. The transmit delay helps to reduce the bus load at the time of scene recall.
- Sometimes, it is desirable that an action is started only after another action has ended. This can be for instance the lighting which is to shut off only after the blinds/shutters have been raised.

The transmit delay can be set separately for each scene output. The transmit delay defines the time between the individual telegrams during a scene recall. The setting specifies how much time must pass after the first scene telegram before the second is transmitted. After transmission of the second scene telegram, the parameterized time must again pass before the third is transmitted and so forth... The transmit delay for the first scene telegram starts immediately after the scene has been recalled.

The transmit delay between telegrams can also be deactivated (setting "0"). The telegrams are then transmitted at the shortest possible time interval. In this case, however, the order of the telegrams transmitted can deviate from the numbering of the scene outputs.

When a new scene recall (also with the same scene number) occurs during a current scene recall - even in consideration of the pertaining transmit delays - the scene processing started first will be aborted and the newly received scene number will be processed. A running scene is also aborted when a scene is being stored!

During a scene recall - even if delayed - the control surfaces of the push-button sensor are operational.

4.2.4.4.2 Storing scenes

Storing scenes

For each output of a scene, the user can define a corresponding scene value in the ETS which is then transmitted to the bus during a scene recall. During the regular operation of the system it may be required to adapt these preset values and to store the adapted values in the universal push-button sensor TSM. This can be ensured by the storage function of the scene control.

The value storage function for the corresponding scene number is enabled with the parameter "Permit storing ?" ("Yes") or disabled ("No"). When the storage function is disabled, the object value of the corresponding output is not sampled during storage.

A scene storage process can be initiated in two different ways...

- by a long press on a rocker or button of a control surface parameterized as "scene extension"
- by a storage telegram to the extension object.

During a storage process, the push-button sensor reads the current object values of the connected actuators. This is effected by means of eight read telegrams (ValueRead) addressed to the devices in the scene which return their own value (ValueResponse) as a reaction to the request. The returned values are received by the push-button sensor and taken over permanently into the scene memory. Per scene output, the push-button sensor waits one second for a response. If no answer is received during this time, the value for this scene output remains unchanged and the push-button sensor scans the next output.

In order to enable the push-button sensor to read the object value of the actuator addressed when a scene is stored, the read flag of the corresponding actuator object must be set. This should be done only for one actuator out of an actuator group so that the value response is unequivocal.

The stored values overwrite those programmed into the push-button sensor with the ETS.

The storage process will always be executed completely by the push-button sensor and cannot be aborted before it has ended. Recalling scenes in the course of a storage process is not possible, the control surfaces of the push-button sensor remaining nevertheless operational.

4.2.4.5 Disabling function

4.2.4.5.1 Configuring the disabling function

Disabling function configuration

With the 1-bit communication object "Button disabling", the control surfaces of the push-button sensor can be partly or completely disabled. During a disable, the rockers or buttons can temporarily execute other functions as well. An active disable applies only to the functions of the rockers or buttons.

An active disable applies only to the functions of the rockers or buttons. The functions of the status LED, scene function and the alarm signalling are not affected by the disabling function. The disabling function and the associated parameters and communication objects are enabled if the parameter "Disabling function ?" is set to "Yes" on the "Disabling" parameter page.

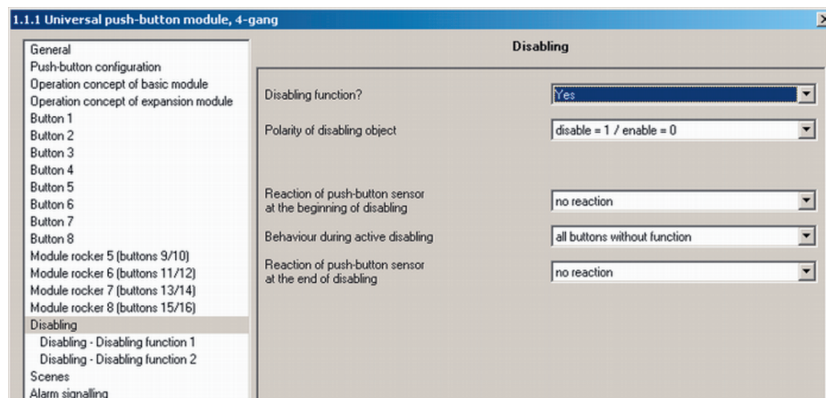

Figure 33: Parameter view for basic configuration of the disabling function.

The polarity of the disabling object is parameterizable. In case of polarity inversion (disabled = 0 / enabled = 1), the disabling function is not activated immediately after a reset or after ETS programming (object value = "0"). There must first be an object update "0" until the disabling function will be activated.

Telegram updates from "0" to "0" or from "1" to "1" on the "button disabling" object remain without effect.

Configuring the reaction at the beginning and end of a disable.

If the disabling function is used, the reaction of the push-button sensor on activation and deactivation of the disabling function can be preset separately in the parameters of the push-button sensor (parameter "Reaction of push-button sensor at the beginning / end of disabling"). In this connection it is irrelevant which of the control surfaces is influenced and possibly also locked by disabling. The push-button sensor always shows the parameterized behaviour.

The disabling function must have been enabled.

- Set the parameter "Reaction of push-button sensor at the beginning / end of disabling" to "no reaction".

The push-button sensor shows no reaction at the beginning and at the end of disabling. The sensor only adopts the state as provided for by the "Behaviour during active disabling".
- Set the parameter "Reaction of push-button sensor at the beginning / end of disabling" to "internal scene recall scene 1 ...8".

The push-button sensor recalls one of the up to 8 internal scenes. Scene storage is not possible.

- Set the parameter "Reaction of push-button sensor at the beginning / end of disabling" to "reaction like button >> X << / >> Y << when pressed / released".

The push-button sensor executes the function assigned to any "target button" in the non-disabled state. Target buttons are control buttons of the push-button sensor which may be configured for rocker or for push-button operation. The target buttons are parameterized separately for the beginning (X) of for the end (Y) of disabling (button X / Y: button 1 to max. button 16). For this purpose, the two buttons of a rocker are considered as two separate buttons.

The action parameterized for the respective target button is executed. If the target button is parameterized in such a way that it has no function or does not transmit a telegram on pressing or releasing of the button, then there is also no reaction to disabling or to re-enabling. If the selected target button is part of a parameterized rocker, the behaviour preset for the respective rocker side (rocker X.1 or X.2) will be used. The telegrams are transmitted to the bus via the required communication object of the target button.

The following table shows all possible telegram reactions of the push-button sensor with respect to the target button function.

Function of >>target button<<	Reaction "like >>target button<< on pressing"	Reaction "like >>target button<< on releasing"
Switching / switch-over	switching telegram	switching telegram
Dimming	switching telegram	no telegram
Blind	move telegram	no telegram
Scene extension	scene recall telegram	no telegram
1-byte value transmitter	value telegram	no telegram
2-byte value transmitter	value telegram	no telegram
temperature value transmitter	temperature value telegram	no telegram
brightness value transmitter	brightness value telegram	no telegram
2-channel operation channel 1: 1 bit object type	switching telegram	no telegram
2-channel operation channel 1: 1 byte object type	value telegram	no telegram
2-channel operation channel 1: 2 byte object type	temperature value telegram	no telegram
Controller extension unit Operating mode selection	operating mode telegram	no telegram
Controller extension unit Presence detection	presence telegram	no telegram

Controller extension unit Setpoint shift	step value telegram	no telegram
No function	no telegram	no telegram

Table 1: Telegram reactions of the push-button sensor with respect to the target button function

- Set the parameter "Reaction of push-button sensor at the beginning / end of disabling" to "reaction like disabling function 1 / 2 when pressed / released".

The push-button sensor executes the function assigned to either of the two "virtual" disabling functions. The disabling functions are internal button functions with independent communication objects and independent parameters. Except for the status LED, the setting possibilities available for disabling function 1 and disabling function 2 are the same as for the buttons.

The respective parameterization of the predefined disabling function will be executed. If no function or no telegram is parameterized in the disabling function on pressing or releasing of a button, then there is also no reaction to disabling or to re-enabling.

Also for this setting Table 1 shows all possible telegram reactions of the push-button sensor depending on the configuration of the disabling function.

The telegrams are transmitted to the bus via the required communication object of the disabling function.

Configuring the reaction during a disable

Irrespective of the behaviour shown by the push-button sensor at the beginning or at the end of disabling, the control buttons can be separately influenced during disabling.

The disabling function must have been enabled.

- Set the parameter "Behaviour during active disabling" to "all buttons without function".

In this case, the push-button sensor is completely disabled during disabling. Pressing a button has no effect. The status LEDs of the disabled buttons are without function (no button-press indication either). Only the "always ON" or "always OFF" state remains unaffected by the disabling function.
- Set the parameter "Behaviour during active disabling" to "all buttons behave like". Also set the parameters "All buttons with even / odd numbers behave during disabling like" to the desired button number, configure module button number or disabling function.

All buttons behave as defined in the parameters for the two specified reference buttons of the push-button sensor. For all control buttons with an even number (2, 4, 6, ...) and for all buttons with an odd number (1, 3, 5, ...) it is possible to program not only different reference buttons, but also identical reference buttons. The two "virtual" disabling functions of the push-button sensor can also be parameterized as a reference button.

The telegrams are transmitted to the bus via the communication objects of the specified reference buttons. The status LEDs of the reference buttons are controlled in conformity with their function. The status LEDs of the disabled buttons are without function (no button-press indication either). Only the "always ON" or "always OFF" state remains unaffected by the disabling function.
- Set the parameter "Behaviour during active disabling" to "individual buttons without function". The buttons that will be disabled are defined on the parameter page "Disable - Button selection" page.

Only the individually specified buttons are locked during disabling. The other control buttons remain unaffected by disabling. The status LEDs of the disabled buttons are without function (no button-press indication either). Only the "always ON" or "always OFF" state remains unaffected by the disabling function.

- Set the parameter "Behaviour during active disabling" to "individual buttons behave like". The buttons that will be disabled are defined on the parameter page "Disable - Button selection" page. Also set the parameters "All buttons with even / odd numbers behave during disabling like" to the desired button number, configure module button number or disabling function.
Only the individually specified buttons behave as defined in the parameters of the two specified reference buttons of the push-button sensor. For all control buttons with an even number (2, 4, 6, ...) and for all buttons with an odd number (1, 3, 5, ...) it is possible to program not only different reference buttons, but also identical reference buttons. The two "virtual" disabling functions of the push-button sensor can also be parameterized as a reference button. The buttons that will be disabled are defined in the parameters on the "Disable - buttons selection" page.
The telegrams are transmitted to the bus via the communication objects of the specified reference buttons. The status LEDs of the reference buttons are controlled in conformity with their function. The status LEDs of the disabled buttons are without function (no button-press indication either). Only the "always ON" or "always OFF" state remains unaffected by the disabling function.

- ❗ If a button evaluation is taking place at the time of activation / deactivation of a disabling function, this function is aborted immediately and with it also the pertaining button function. It is first necessary to release all buttons before a new button function can be executed if so permitted by the state of disabling.

4.2.4.5.2 Three-button press

Three-button press of the disabling function

In the 4-gang universal push-button sensor TSM, an active disable can be released by means of the so-called three-button press. For this purpose, buttons B1, B5 and B8 (figure 34) must be pressed and held down for at least five seconds. The following illustration shows the three-button press depending on the button arrangement configured in the ETS (A: "top / bottom", B: "left / right").

The three-button press can be performed with or without an expansion module attached.

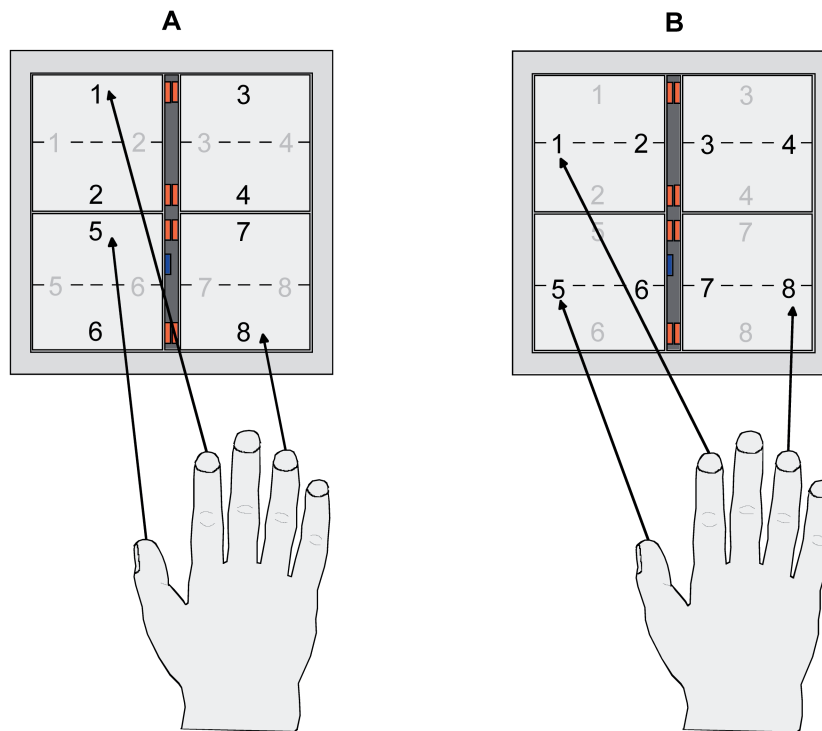

Figure 34: Three-button press taking into account the configured button arrangement.

- i** For re-enabling the push-button operation, all buttons must first be released before a new press can be evaluated. Since the three buttons are generally not pressed at the same time, there is the possibility of a telegram being transmitted if (at least) one of the three buttons has a function assigned to it.
- i** On deactivation of the disabling function by means of the three-button press, the disable object will be updated (disabling inactive) and the new object value actively transmitted to the bus, if the transmit flag of the object is set. In the default state, this flag is cleared.

- i** If the control surfaces for the button pairs 1&2 and 5&6 are configured to push-button function and single-surface operation, then the control surfaces may not be pressed at the centre during a three-button press! In this case the control surfaces must be depressed at the side taking into account the button arrangement, as shown in the above operation examples (figure 34).
- If the control surface for the button pair 7&8 is configured to push-button function and single-surface operation, then it must be noted that button 8, even though it is actually physically not present and it is functionally hidden in the ETS, is nevertheless evaluated in a three-button press, and has to be depressed! To do this, actuate the control surface at the side, while also observing the configured button arrangement.

4.2.4.6 Controller extension unit

4.2.4.6.1 Connection to room thermostat

Connection to room thermostat

For controlling of a KNX/EIB room thermostat, the controller extension function can be activated. The controller extension function is enabled with the parameter "Controller extension" on the "General" page

The controller extension itself is not involved in the regulating process. With it, the user can operate the single-room regulation from different places in the room. It can also be used to adjust central heating control units which are located, for instance, in a distribution box.

Typical KNX/EIB room thermostats generally offer different ways of influencing or visualizing the room temperature regulation...

- Switching over between different modes of operation (e.g. "Comfort", "Night" ...) with different setpoint temperatures assigned to each mode by the thermostat.
- Detecting the presence of a person in a room. The detection may also be combined with a parameterized change of the mode of operation.
- Readjustment of the setpoint temperature in steps which are referred in each case to the parameterized setpoint temperature of the current mode of operation (basic setpoint shift).

The universal push-button sensor TSM permits by means of its control buttons the complete control of a room thermostat by changing the operating mode, by predefining the presence situation or by readjusting the setpoint shift (cf. the following sub-chapters). For this purpose, the buttons of the push-button sensor selected as extension operation buttons must be parameterized for the "Controller extension" function. It should be noted that an extension operation is possible only if one control surface is configured as a button and if the controller extension function has been enabled on the "General" page. In all other cases, the controller extension function is not operational.

In addition, the push-button sensor can – independent of the controller extension function – indicate the state of one or more room thermostats with the status LEDs of the rockers or buttons. This feature permits the indication of modes of operation or the bit-oriented evaluation of different status objects of controllers (see chapter 4.2.4.3. Status LED). In case of the controller extension functions "Setpoint shift" or "Presence function", the status LEDs can also signal the state of the corresponding functions directly.

The controller extension can work properly only if all extension objects are linked with the corresponding objects of the room thermostat (see chapter 4.2.4.3. Status LED). The controller extension with the objects exists only once in the push-button sensor. All button functions parameterized for the controller extension act on the objects belonging to the extension. Several controller extensions can also act on one main controller.

Nu...	Name	Object Function	Length	C	R	W	T	U
58	Controller extension unit	Operating mode selection	1 Byte	C	-	W	T	U
59	Controller extension unit	Forced oper. mode switch-over	1 Byte	C	-	W	T	U
60	Controller extension unit	presence button	1 bit	C	-	W	T	U
61	Controller extension unit	Setpoint shift output	1 Byte	C	-	-	T	-
62	Controller extension unit	Setpoint shift input	1 Byte	C	-	W	T	U
63	Controller extension unit	Controller status	1 Byte	C	-	W	T	U

Figure 35: Communication objects of the controller extension

The communication objects "Operating mode selection", "Forced operating mode switch-over", "Presence button", "Setpoint shift input" and "Controller status" of the controller extension update themselves automatically after a reset of the universal push-button sensor TSM or after ETS programming, if the parameter "Value request from controller extension?" on parameter page "General" is set to "Yes". Updating is effected by means of a ValueRead telegram to the room thermostat. The controller must answer the request with a ValueResponse telegram. If the push-button sensor does not receive all or some of the answers, the affected objects are initialized in the push-button sensor TSM with "0". In this case, the objects must first be actively rewritten by the bus after a reset. This is also the case, when the "Value request from controller extension?" is set to "No".

4.2.4.6.2 Button functions for "Operating mode selection" and "Forced operating mode switch over"

Button functions for "Operating mode selection" and "Forced operating mode switch over"

Changeover of the controller operating mode can be effected in accordance with the standard function block for room thermostats defined in the Konnex handbook with two 1-byte communication objects. The operating mode can be switched over with the normal and with the forced-control object. The "Operating mode selection" object offers a selection between the following operating modes...

- comfort-mode
- standby mode
- night-mode
- frost / heat protection

The "Forced operating mode switch over" communication object has the higher priority. The "Forced operating mode switch over" object permits forced switching between the following modes of operation...

- auto (normal operating mode switch-over)
- comfort-mode
- standby mode
- night-mode
- frost / heat protection

The operating mode transmitted to the bus on a button-press of the controller extension is defined by the parameter "Operating mode on pressing the button". Depending on the parameterized functionality, it is possible that ...

- either one of the above-mentioned modes is activated (single selection) on the press of the button,
- or the device is switched over between two or three modes (multiple selection).

i Notes on multiple selection:

In order to ensure that a switch-over from one mode into another works properly even from different locations, the operating mode objects of the controller and those of all controller extension push-button sensors must be interlinked and have their "Write" flag set. In the objects concerned this flag is set by default

By checking the linked operating mode switch-over object, the controller extension knows which of the possible operating modes is active. Based on this information, the device switches over into the next operating mode in sequence when a button is pressed. In the event that none of the possible operating modes is active, the next operating mode in the sequence is set to "Comfort" mode (in case of "Standby ->Night" to "Standby" mode). As far as switching over between the forced operating modes and "Auto" is concerned, the device switches into the "Auto" operating mode when none of the parameterized operating modes is active.

- i** It is not possible to program a reaction on release of the button. A long button-press is evaluated in the same way as short one and switches into the corresponding mode of operation in so far as this is acceptable for the controller.

- i** If a status LED is to indicate the current mode of operation, the status LED function must be programmed for "Operating mode indication" and its status object be linked with the corresponding group address for operating mode switch-over with normal or high priority (see chapter 4.2.4.3. Status LED).

4.2.4.6.3 Button function "Presence button"

Button function "Presence button"

All buttons with their function set to "Presence button" are internally linked with the "Presence button" object of the controller extension. The parameter "Presence function on pressing the button" defines the object value transmitted to the bus on pressing a button.

In order to ensure that the object value transmitted in the "Presence TOGGLE" setting is always the correct one, the presence object of the room thermostat and the "Presence button" objects of the controller extension push-button sensors must be interlinked and have their "Write" flag set. In the extension objects concerned this flag is set by default.

It is not possible to program a reaction on release of the button. A long button-press is evaluated in the same way as short one and switches into the corresponding mode of operation in so far as this is acceptable for the controller.

The status LED of the presence button can indicate both the presence status (setting "Button function indication active / inactive") and also the actuation of the button. In addition, the usual setting possibilities of the status LED are parameterizable as well (see chapter 4.2.4.3. Status LED).

4.2.4.6.4 Button function "Setpoint shift"

Button function "Setpoint shift"

The setpoint shift is another available function of the controller extension. It makes use of two 1-byte communication objects with data point type 6.010 (integer with sign). This extension function allows shifting of the basic setpoint for the temperature on a room thermostat by actuating a button. Operation of the extension is generally the same as the operation of the main controller.

A button parameterized as a setpoint shifting button reduces or increases the setpoint shift value on each press by one step respectively. The direction of the value adjustment is defined by the parameter "Setpoint shift on pressing the button". Releasing the button and a long press have no other functions.

Communication with the main controller point

In order to enable the universal push-button sensor TSM to effect a setpoint shift in a room thermostat, the controller must have input and output objects for setpoint shifting. In this case, the output object of the controller must be linked with the input object of the extension unit and the input object of the controller must be linked with the output object of the extension via an independent group address.

All objects are of the same data point type and have the same value range. A setpoint shift is interpreted by count values: a shift in positive direction is expressed by positive values whereas a shift in negative direction is represented by negative object values. An object value of "0" means that no setpoint shift has been activated.

Via the "Setpoint value shift input" object of the controller extensions which is linked with the room thermostat, the extensions are enabled to determine the current setpoint shift position. Starting from the value of the communication object, each button-press on an extension will adjust the setpoint in the corresponding direction by one count value step. Each time the setpoint is adjusted, the new shift is transmitted to the room thermostat via the "Setpoint value shift output" object of the controller extension. The controller itself checks the received value for the minimum and maximum temperature limits (see controller documentation) and adjusts the new setpoint shifting if the values are valid. When the new count value is accepted as valid, the controller transfers this value to its output object for setpoint shifting and retransmits the value to the extension as positive feedback.

Due to the standard data point type used as the output and input object of the controller extension and the weighting of the individual stage by the controller itself, each extension unit is able to determine whether a shift took place, in which direction it took place and by how many steps the setpoint was shifted. This requires that the communication objects are connected on all controller extensions and the controller .

The information for the step value as feedback from the controller enables the extension to continue the adjustment anytime at the right point. The extension units can likewise react to a reset of the setpoint shifting function by the controller.

The status LED of a setpoint shifting button can indicate both the setpoint shifting status (setting "Setpoint value shift indicator") and also the actuation of the button. In addition, the usual setting possibilities of the status LED are parameterizable as well (see chapter 4.2.4.3. Status LED).

For setpoint shifting status indication, the controller makes use of the step count value which is transmitted to the extension and evaluated for switching of the status LED. The "Status LED" parameter defines the switching behaviour: The LED can be permanently off and light up only after a shift has been detected (setting "ON, ..."). As an alternative, the LED can be

permanently on and go out only after a shift has been detected (setting "OFF, ..."). It can also be distinguished whether the LED is ON or OFF only if...

- there has been shifting at all
- only a positive shift has been detected,
- only a negative shift has been detected.

4.2.4.7 Room temperature measurement

Temperature detection and measured value formation

The push-button sensor features an integrated temperature sensor. This temperature sensor can be used to measure the ambient temperature and forward it to a room temperature controller via a 2-byte object. Alternatively, the temperature measurement can be supplemented by means of an external sensor. This external temperature sensor is connected to the device via the bus by means of an additional 2-byte communication object (for example an additional push-button sensor or a KNX room thermostat).

The "Temperature detection" parameter on the "Room temperature measurement" parameter page specifies the sensors that are used to detect the room temperature. The following settings are possible...

- "internal temperature sensor"
The temperature sensor integrated in the push-button sensor is activated. Thus, the actual temperature value is determined only locally on the device.

- "internal and external temperature sensor"
With this setting the internal as well as the external temperature sensor is active. The external sensor must either be a KNX room thermostat coupled via the 2-byte object "External temperature sensor" or another bus device with temperature detection.

The room temperature controller can request the current temperature value cyclically. For this the parameter "Request time for external sensors..." must be set to a value > "0". The request interval can be configured within the limits of 1 minute to 255 minutes.

When evaluating the internal and the external sensors, the room temperature is made up from the two measured temperature values. The weighting of the temperature values is defined by the "Creation of measuring value internal against external" parameter.

Depending on the different locations of the sensors or a possible non-uniform heat distribution inside the room, it is thus possible to adjust the actual temperature measurement. Often, those temperature sensors that are subject to negative external influences (for example, unfavourable location because of exposure to sun or heater or door / window directly next to it) are weighted less heavily.

Example: The push-button sensor has been installed next to the entrance door (internal sensor). An additional external temperature sensor has been mounted on an inner wall in the middle of the room below the ceiling.

Internal sensor: 21.5 °C

External sensor: 22.3 °C

Determination of measured value: 30 % to 70 %

$$\rightarrow T_{\text{Result internal}} = T_{\text{internal}} \cdot 0.3 = 6.45 \text{ °C},$$

$$\rightarrow T_{\text{Result external}} = T_{\text{external}} \cdot 0.7 = 15.61 \text{ °C}$$

$$\rightarrow T_{\text{Result actual}} = T_{\text{Result internal}} + T_{\text{Result external}} = \underline{\underline{22.06 \text{ °C}}}$$

Installation location

When choosing the mounting location of the pushbutton sensor, the following points should be considered when using room temperature measurement:

- The device should not be used in multiple combinations, especially together with flush-mounted dimmers.
- Do not install the device in the area of large electrical consumers (avoid heat influences).
- The push button sensor should not be installed in the vicinity of radiators or cooling systems.

- Avoid direct sunlight.
- The installation on the inside of an outside wall might have a negative impact on the temperature measurement.
- The device should be installed at least 30 cm away from doors, windows or ventilation units and at least 1.5 m above the floor.

Temperature calibration of the measurement values

In some cases during room temperature measurement, it may be necessary to adjust the temperature values of the internal and the external sensor. Adjustment becomes necessary, for example, if the temperature measured by the sensors stays permanently below or above the actual temperature in the vicinity of the sensor. To determine the temperature deviation, the actual room temperature should be detected with a reference measurement using a calibrated temperature measuring device.

The parameter "Internal sensor calibration..." and "External sensor calibration..." on the parameter page "Room temperature measurement" can be used to configure the positive (temperature increase, factors: 1 ... 127) or negative (temperature decrease, factors -128... -1) temperature calibration in levels of 0.1 K. Thus, the calibration is made only once statically and is the same for all operating modes of the controller.

- i** The measured value has to be increased, if the value measured by the sensor lies below the actual room temperature. The measured value has to be decreased, if the value measured by the sensor lies above the actual room temperature.
- i** The push-button sensor always transmits the calibrated temperature value to the controller. When determining the room temperature using the internal and external sensor, the two calibrated values are used to calculate the actual value.

Transmission of room temperature

The determined room temperature is transmitted to the bus via the 2-byte object "Measured room temperature". The parameter "Transmission after room temperature change by..." on the "Room temperature measurement" parameter page specifies the change value of the temperature for automatic transmission. Compared with the last measurement, the room temperature must change by at least the configured value for a new temperature value to be transmitted automatically via the object. Possible temperature value changes lie within a range of 0.1 K and 25.5 K. If "0" is selected, the automatic transmission of the room temperature is deactivated.

In addition, the room temperature can be transmitted cyclically. The "Cyclical transmission of the room temperature" parameter determines the cycle time (1 to 255 minutes). The value "0" will deactivate the cyclical transmission.

Setting the "Read" flag on the "Measured room temperature" object makes it possible to read out the current actual value at any time over the bus. It has to be pointed out that with deactivated periodical transmission and deactivated automatic transmission, no more room temperature telegrams will be transmitted in case of a change.

Following the return of bus voltage or reprogramming via the ETS the object value will be updated according to the determined room temperature value and transmitted on the bus. In case a temperature value telegram has not been received from the external sensor via the object "External temperature sensor" when evaluating an external temperature sensor, only the value provided by the internal sensor will be transmitted. For this reason, the external temperature sensor should always transmit the current value after a reset.

4.2.4.8 Alarm signalling

Alarm signalling

The universal push-button sensor TSM permits signalling of an alarm which might be, for instance, a burglar or a fire alarm from a KNX/EIB central alarm unit. An alarm is signalled by all status LEDs and of the operation LED of the push-button sensor flashing synchronously. The alarm can be separately enabled with the parameter "Alarm signal display" on parameter page "Alarm signalling" so that it can be used.

When alarm signalling is enabled, the ETS displays the communication object "Alarm signalling" and further alarm function parameters.

The alarm signalling object is used as an input for activating or deactivating alarm signal displaying. The polarity of this object can be selected. If the object value corresponds to the "Alarm" state, all status LEDs and the operation LEDs always flash at the same time with a frequency of approx. 2 Hz. The basic parameterizations of the LEDs have no significance in the case of an alarm. Only when the alarm signal displaying is deactivated does the LED once again show the originally parameterized behaviour. State changes of the LEDs during an alarm, if they are activated for example via separate LED objects or signal push-button functions, are stored internally and tracked at the end of the alarm.

Apart from the possibility of deactivating an alarm signal via the alarm object, it can also be deactivated locally by a button-press on the push-button sensor itself. The parameter "Reset alarm signalling by a button-press?" defines the button response during an alarm...

- If this parameter is set to "Yes", active alarm signal displaying can be deactivated by a button-press on the push-button sensor. This button-press does not cause the parameterized function of the pressed button to be executed. Only after the next button-press will the parameterization of the button be evaluated and a telegram be transmitted to the bus, if applicable.
- If "No" has been selected, alarm signalling can only be deactivated via the alarm signalling object. A button-press will always directly execute the parameterized button function.

If an alarm signalling can be deactivated by a button-press, the parameter "Acknowledge alarm signalling by" defines whether an additional alarm acknowledge telegram is to be transmitted to the bus via the separate object "Alarm signalling acknowledge" after triggering by this button-press.

Such an acknowledge telegram can, for instance, be sent via a 'listening' group address to the "Alarm signalling" objects of other push-button sensors in order to reset the alarm status there as well. Attention must be paid during resetting of an alarm to the selectable polarity if the acknowledge object.

- i** Notes on the alarm signalling function: If the setting is "Alarm when OFF and alarm reset when ON", the alarm object must be actively written by the bus with "0" to activate the alarm after a reset or after programming with the ETS.
- i** An active alarm signalling is not stored so that the alarm signalling is generally deactivated after a reset or after programming with the ETS.

4.2.4.9 Delivery state

Delivery state and non run-capable application

As long as universal push-button sensor TSM has not yet been programmed with application data by means of the ETS, the blue operation LED flashes at a slow rate (approx. 0.75 Hz). When any of the buttons or rockers is pressed, the pertaining status LED lights up briefly (button-press indication). This condition persists until the application is programmed into the device.

By slow flashing of its operation LED (approx. 0.75 Hz), the push-button sensor can also indicate that a non run-capable application has been programmed into its memory with the ETS. Applications are non run-capable if they are not intended for use with the universal push-button sensor TSM in the ETS product database. Attention must also be paid to the fact that the push-button sensor variant is compatible with the one in the project (e.g. 4-gang version created in the ETS project and also installed).

The operation LED flashes slowly also if the application program of the touch sensor has been removed from the device by the ETS.
In both cases, the push-button sensor is not operational.

4.2.5 Parameters

Description	Values	Comment
<p>☐ General</p>		
Transmit delay after reset or bus voltage return	Yes	<p>After a reset (e.g. after loading of an application program or the physical address or after return of bus voltage), the push-button sensor can automatically transmit telegrams for the room temperature controller extension functions. In case of the controller extension, the push-button sensor attempts to retrieve values from the room temperature controller by means of read telegrams in order to update the object states. In case of the room temperature measurement, the push-button sensor transmits the current room temperature after a reset to the bus. If there are still other bus devices besides the push-button sensor transmitting telegrams immediately after a reset, it may be useful to activate the transmit delay for automatically transmitting objects in order to reduce the bus load.</p> <p>When transmit delay is activated (setting: "Yes"), the push-button sensor computes the time delay from its device ID in the physical address. The sensor then waits 30 seconds maximum before transmitting telegrams.</p>
	No	
Light period of status LED for button-press display	1 sec	<p>This parameter defines the switch-on time the status LED is lit up to indicate actuation. The setting concerns all status LEDs whose function is set to "Button-press display".</p>
	2 sec	
	3 sec	
	4 sec	
	5 sec	
Function of operation LED	always OFF	<p>This parameter defines the function of the operation LED.</p> <p>The operation LED is always off.</p>
	always ON	<p>The operation LED is always on, for instance, as orientation lighting.</p>
	Control via object	<p>The operation LED is controlled by a separate communication object.</p>
	flashing	<p>The operation LED flashes permanently with a frequency of about 0.75 Hz.</p> <p>Besides the function set here, the operation LED can display different</p>

		states by means of other flashing rates. These comprise Programming mode, the confirmation of full-surface actuation or the message that an application has not been loaded.
Control of the operation LED via the object value	<p>1 = LED static ON / 0 = LED static OFF</p> <p>1 = LED static OFF / 0 = LED static ON</p> <p>1 = LED flashes / 0 = LED static OFF</p> <p>1 = LED static OFF / 0 = LED flashes</p>	<p>If the "Function of the operation LED" is set to "Control via object", then the telegram polarity of the 1-bit object "Operation LED" can be specified at this point.</p> <p>The LED can be switched on or off statically. In addition, the received switching telegram can be evaluated in such a way that the LED flashes.</p>
Controller extension	<p>enabled</p> <p>Disabled</p>	<p>This parameter enables the communication objects and the parameter page for the room temperature controller extension. In addition, at least one rocker must be divided into two buttons to permit full use of the controller extension features.</p>
Value request from controller extension?	<p>Yes</p> <p>No</p>	<p>In order to enable the push-button sensor to transmit the correct values after a press on the buttons representing the controller extension, the "Operating mode selection", "Forced operating mode change-over" and "Presence button" communication objects can transmit read requests after a reset.</p>
		<p>i Only visible, if the parameter "Controller extension" is set to "enabled".</p>
Room temperature measurement	<p>Disabled</p> <p>enabled</p>	<p>The device possesses an integrated temperature sensor. Using this temperature sensor, the ambient temperature can be measured in a range between -5 °C and +40 °C and forwarded to the KNX via a 2-byte communication object. The determined temperature can then be processed, for example, by a room temperature controller as an external temperature or be displayed by a visualisation. This parameter enables room temperature measurement as necessary.</p>

☐ Button configuration

Pushbutton sensor expansion module...

If an expansion module is connected to the basic unit, then the module button pairs present on the expansion module must be enabled using this parameter. Module buttons may only be enabled if an expansion module is actually connected to the basic unit!

Module-buttons

Not present

No expansion module button pair is connected.

present

An expansion module, which has the appropriate expansion module button pair, is connected to the basic unit.

☐ Operation concept basic module

Operation concept of buttons 1 and 2

Rocker function (rocker 1)

For each control surface, the user can specify independently whether it is to be used as a rocker with a common basic function or as two different buttons with completely independent functions. Depending on this setting, the ETS displays different communication objects and parameter pages.

(The same parameters are available for the other control surfaces / button pairs of the basic module.)

Button function

Button evaluation

If the operation concept of a control surface is configured as "push-button function", this parameter can be used to specify whether single-area or dual-area operation should be implemented.

(The same parameters are available for the other control surfaces / button pairs of the basic module.)

Single-area operation (only as button 1)

In single-area operation, the entire control surface is evaluated only as a single "large" button. The surface can be depressed at any desired point in order to execute the underlying button function. In this setting, the button with the even button number of the button pair (e.g. button 2) is inactive and physically not present.

Dual-area operation (as buttons 1 + 2)

In dual-area operation, the control surface is divided into two mutually independent buttons.

Button arrangement

left / right

In the rocker function and in the push-button function with double-surface principle, for each control surface the user can independently specify whether it is to be divided horizontally or

(The same parameters are available for the other control surfaces /

top / bottom

button pairs of the basic module.)

vertically. This defines the actuation points of the control surface.

☐-| Operation concept of extension module

Operation concept of buttons X and Y *

Rocker function (Rocker Z) *

For each control surface, the user can specify independently whether it is to be used as a rocker with a common basic function or as two different buttons with completely independent functions. Depending on this setting, the ETS displays different communication objects and parameter pages.

(The same parameters are available for the other control surfaces / button pairs of the extension module.)

Button function

*: X, Y, and Z define the numbers of the module buttons or rocker, and depend on the number of control surfaces of the push-button sensor basic unit. Thus the variant of the basic unit determines the button numbers of the extension module.

Button evaluation

If the operation concept of a control surface is configured as "push-button function", this parameter can be used to specify whether single-area or dual-area operation should be implemented.

(The same parameters are available for the other control surfaces / button pairs of the extension module.)

Single-area operation (only as button X) *

In single-area operation, the entire control surface is evaluated only as a single "large" button. The surface can be depressed at any desired point in order to execute the underlying button function. In this setting, the button with the even button number of the button pair (e.g. button 10) is inactive and physically not present.

dual-area operation (as buttons X + Y) *

In dual-area operation, the control surface is divided into two mutually independent buttons.

Button arrangement

left / right

In the rocker function and in the push-button function with double-surface principle, for each control surface the user can independently specify whether it is to be divided horizontally or vertically. This defines the actuation points of the control surface.

(The same parameters are available for the other control surfaces / button pairs of the extension module.)

top / bottom

☐ Rocker 1 (buttons 1/2) (only if "Function of buttons 1 and 2 = as one rocker (rocker 1)!")

Function	Switching	This parameter is used to define the basic function of the rocker. Depending on this choice, the ETS displays different communication objects and parameters for this rocker.
	Dimming Venetian blind Value transmitter 1-byte Value transmitter 2-byte Scene extension 2-channel operation	

The following parameters are only valid for the rocker function "switching"...

Description	Values	Comment
Command on pressing rocker 1.1	No reaction ON OFF TOGGLE	Depending on the "button arrangement" parameter, these parameters define the reaction that takes place when the top (or left-hand) rocker is pressed or released.
Command on releasing rocker 1.1	No reaction ON OFF TOGGLE	
Command on pressing rocker 1.2	No reaction ON OFF TOGGLE	Depending on the "button arrangement" parameter, these parameters define the reaction that takes place when the bottom (or right-hand) rocker is pressed or released.
Command on releasing rocker 1.2	No reaction ON OFF TOGGLE	

The following parameters are only valid for the rocker function "dimming"...

Description	Values	Comment
Command on pressing rocker 1.1	No reaction Brighter (ON) Darker (OFF) Brighter / darker (TOGGLE) Brighter (TOGGLE) Darker (TOGGLE)	Depending on the "Button arrangement" parameter, this parameter defines the reaction that takes place when the top (or left-hand) rocker is pressed. If the push button sensor is to toggle on a brief press, the corresponding switching objects of other sensors with the same function must be linked with one another. In the "Brighter/darker (TOGGLE)" setting, the dimming objects must be interlinked as well so that the

		push button sensor can send the correct telegram on the next button-press.
Command on pressing rocker 1.2	No reaction Brighter (ON) Darker (OFF) Brighter / darker (TOGGLE) Brighter (TOGGLE) Darker (TOGGLE)	Depending on the "Button arrangement" parameter, this parameter defines the reaction that takes place when the bottom (or right-hand) rocker is pressed. If the push button sensor is to toggle on a brief press, the corresponding switching objects of other sensors with the same function must be linked with one another. In the "Brighter/darker (TOGGLE)" setting, the dimming objects must be interlinked as well so that the push button sensor can send the correct telegram on the next button-press.
Time between switching and dimming, rocker 1.1 (100 ... 50000 x 1 ms)	100 ... 400 ... 50000	This parameter defines how long the top (or left-hand) rocker must be pressed for the pushbutton sensor to send a dimming telegram.
Time between switching and dimming, rocker 1.2 (100 ... 50000 x 1 ms)	100 ... 400 ... 50000	This parameter defines how long the bottom (or right-hand) rocker must be pressed for the pushbutton sensor to send a dimming telegram.
Advanced parameters	Activated Deactivated	When the advanced parameters are activated, the ETS shows the following parameters.
Advanced parameters activated...		
Increase brightness by	1.5 % 3 % 6 % 12.5 % 25 % 50 % 100 %	This parameter sets the relative dimming level when the brightness is increased. On each button-press, the brightness is changed at maximum by the configured step width. Especially with smaller dimming levels it is advisable for the push button sensor to repeat the dimming telegrams automatically (see "telegram repetition").
Reduce brightness by	1.5 % 3 % 6 % 12.5 %	This parameter sets the relative dimming level when the brightness is reduced. On each button-press, the brightness is changed at maximum by

	25 % 50 % 100 %	the configured step width. Especially with smaller dimming levels it is advisable for the push button sensor to repeat the dimming telegrams automatically (see "telegram repetition").
Transmit stop telegram?	Yes No	On "Yes" the push button sensor transmits a telegram for stopping the dimming process when the rocker is released. When the push button sensor transmits telegrams for dimming in smaller levels, the stop telegram is generally not needed.
Telegram repetition?	Yes No	This parameter can be used to activate telegram repetition for dimming. With the button held down, the push button sensor will then transmit the relative dimming telegrams (in the programmed step width) until the button is released.
Time between two telegrams	200 ms 300 ms 400 ms 500 ms 750 ms 1 sec 2 s	This parameter defines the interval at which the dimming telegrams are automatically repeated in the telegram repetition mode. i Visible only if "Telegram repetition = Yes"!
Full-surface operation	enabled Disabled	When the full-surface operation is enabled, the ETS shows the following parameters.
Function for full-surface operation	Switching Scene recall without store function Scene recall with storage function	In case of full-surface operation, this parameter defines the function that is to be used. The ETS shows the corresponding communication object and the other parameters. If the push button sensor is to recall a scene with storage function by full-surface actuation, it will make a distinction between a brief press (less than 1 s), a sustained press (longer than 5 s) and an invalid button-press (between 1 s and 5 s). A brief press recalls the scene, a sustained press stores a scene and an invalid full-surface operation is ignored.

Command for full-surface operation	ON OFF TOGGLE	<p>i Visible only if "Full-surface operation = enabled"!</p> <p>This parameter defines the value of the transmitted telegram when a full-surface operation has been sensed. "TOGGLE" changes over the current object value.</p> <p>i Visible only if "Full-surface operation = enabled"!</p>
Scene number (1 ... 64)	1, 2, ..., 64	<p>This parameter defines the scene number which is to be transmitted to the bus after a scene recall or during storage of a scene.</p> <p>i Visible only if "Full-surface operation = enabled"!</p>

The following parameters are only valid for the rocker function "blind"...

Description	Values	Comment
Command on pressing rocker	Rocker X.1:UP / rocker X.2: DOWN Rocker X.1: DOWN / rocker X.2: UP Rocker X.1: TOGGLE / rocker X.2: TOGGLE	This parameter defines the running direction of a drive after a button-press. If the setting is "TOGGLE", the direction is changed after each long time command. If several push buttons are to control the same drive, the long time objects of the push buttons must be interlinked for a correct change of the running direction.
Operation concept	short – long – short long – short short – long long – short or short	For Venetian blind control, four different operation concepts can be selected. For these concepts, the ETS shows further parameters.
Time between short and long time command rocker 1.1 (1 ... 3000 x 100 ms)	1 ... 4 ... 3000	This parameter sets the time after which the long time operation will be evaluated on pressing the top (or left-hand) button of the rocker.

<p>Time between short and long time command rocker 1.2 (1 ... 3000 x 100 ms)</p>	<p>1 ... 4 ... 3000</p>	<p>i This parameter is not visible with "Operation concept = long – short"!</p>
		<p>This parameter sets the time after which the long time operation will be evaluated on pressing the bottom (or right-hand) button of the rocker.</p>
		<p>i This parameter is not visible with "Operation concept = long – short"!</p>
<p>Slat adjusting time rocker 1.1 (0 ... 3000 x 100 ms)</p>	<p>0 ... 5 ... 3000</p>	<p>Time during which a transmitted long time telegram can be terminated by releasing the top (or left-hand) button of the rocker (short time). This function serves to adjust the slats of a blind.</p>
		<p>i This parameter is not visible with "Operation concept = long – short"!</p>
<p>Slat adjusting time, rocker 1.2 (0 ... 3000 x 100 ms)</p>	<p>0 ... 5 ... 3000</p>	<p>Time during which a transmitted long time telegram can be terminated by releasing the bottom (or right-hand) button of the rocker (short time). This function serves to adjust the slats of a blind.</p>
		<p>i This parameter is not visible with "Operation concept = long – short"!</p>
<p>Full-surface operation</p>	<p>enabled Disabled</p>	<p>When the full-surface operation is enabled, the ETS shows the following parameters.</p>
		<p>i Full-surface operation can only be programmed if "Operation concept = long – short or short"!</p>
<p>Function for full-surface operation</p>	<p>Switching Scene recall without store function</p>	<p>In case of full-surface operation, this parameter defines the function that is to be used. The ETS shows the corresponding communication object and the other parameters. If the push button sensor is to recall a</p>

Scene recall with storage function		<p>scene with storage function by full-surface actuation, it will make a distinction between a brief press (less than 1 s), a sustained press (longer than 5 s) and an invalid button-press (between 1 s and 5 s). A brief press recalls the scene, a sustained press stores a scene and an invalid full-surface operation is ignored.</p> <p>i Visible only if "Full-surface operation = enabled"!</p>
Command for full-surface operation	<p>ON OFF TOGGLE</p>	<p>This parameter defines the value of the transmitted telegram when a full-surface operation has been sensed. "TOGGLE" changes over the current object value.</p> <p>i Visible only if "Full-surface operation = enabled"!</p>
Scene number (1 ... 64)	1, 2, ..., 64	<p>This parameter defines the scene number which is to be transmitted to the bus after a scene recall or during storage of a scene.</p> <p>i Visible only if "Full-surface operation = enabled"!</p>

The following parameters are only valid for the rocker function "1-byte value transmitter"...

Description	Values	Comment
Function	<p>Rocker X.1 / X.2 no function</p> <p>Rocker X.1: 0 ... 255 / Rocker X.2: 0 ... 255</p> <p>Rocker X.1: 0 ... 100 % / Rocker X.2: 0 ... 100 %</p> <p>Rocker X.1: 0 ... 255 / Rocker X.2: no function</p> <p>Rocker X.1: 0 ... 100 % / Rocker X.2: no function</p>	<p>A rocker configured as "Value transmitter 1 byte" permits selecting whether the values to be transmitted are interpreted as integers from 0 to 255 or as a percentage from 0 % to 100 %. The following parameters and their settings depend on this distinction.</p>

	Rocker X.1: no function / Rocker X.2: 0 ... 255	
	Rocker X.1: no function / Rocker X.2: 0 ... 100 %	
Value, rocker 1.1 (0 ... 255)	0...255	Depending on the "Button arrangement" parameter, this parameter defines the object value when the top (or left-hand) rocker is pressed.
		i Visible only if "Function = ... 0...255"!
Value, rocker 1.2 (0 ... 255)	0...255	Depending on the "Button arrangement" parameter, this parameter defines the object value when the bottom (or right-hand) rocker is pressed.
		i Visible only if "Function = ... 0...255"!
Value, rocker 1.1 (0 ... 100 %)	0...100	Depending on the "Button arrangement" parameter, this parameter defines the object value when the top (or left-hand) rocker is pressed.
		i Visible only if "Function = ... 0...100 %"!
Value, rocker 1.2 (0 ... 100 %)	0...100	Depending on the "Button arrangement" parameter, this parameter defines the object value when the bottom (or right-hand) rocker is pressed.
		i Visible only if "Function = ... 0...100 %"!
Value adjustment by long button-press	enabled Disabled	If value adjustment by long button-press is enabled, the ETS shows further parameters. Value adjustment begins, when the button is held down for more than 5 s. In this case, the respective status LED flashes as a sign that a new telegram

		has been transmitted.
Starting value in case of value adjustment	Same as configured value	Value adjustment can begin with different starting values. After each long press, the pushbutton sensor always starts with the value configured in the ETS.
	Same as value after last adjustment	After a long press, the pushbutton sensor starts with the value transmitted by itself or by another device with this group address as the last value.
	Same as value from communication object	After a long press, the pushbutton sensor starts with the value transmitted by itself or by another device with this group address as the last value.
		i Visible only if "Value adjustment by long button-press = enabled"!
Direction of value adjustment	Upwards	With a long press, the push button sensor can either vary the values always in the same direction or it stores the direction of the last adjustment and reverses it on the next button-press.
	Downwards	
	Toggling (alternating)	
		i Visible only if "Value adjustment by long button-press = enabled"!
Step width (1 ... 15)	1...15	In a value adjustment, the pushbutton sensor determines the new telegram value from the previous value and the preset step width. If the value falls below the lower limit of the adjustment range (0 or 0 %) or if it exceeds the upper limit (255 or 100%), the sensor adapts the step width of the last step automatically.
		i Visible only if "Value adjustment by long button-press = enabled"!
Time between two telegrams	0.5 sec	In a value adjustment, the pushbutton sensor determines the new telegram value from the previous value and the preset step width. If the value falls below the lower limit of the adjustment range (0 or 0 %) or if it exceeds the upper limit (255 or 100%), the sensor adapts the
	1 sec	
	2 sec	
	3 sec	

step width of the last step automatically.

i Visible only if "Value adjustment by long button-press = enabled"!

Value adjustment with overflow

Yes

No

If value adjustment is to be effected without overflow (setting "No") and if the pushbutton sensor reaches the lower limit of the adjustment range (0 or 0 %) or the upper limit (255 or 100 %) during value adjustment, the adjustment will be stopped automatically by the sensor. If the value adjustment with overflow is programmed (setting "Yes") and if the push button sensor reaches the lower or the upper limit, it will transmit the value of this range limit and then add a pause the duration of which corresponds to two levels. Thereafter, the push button sensor transmits a telegram with the value of the other range limit and continues the value adjustment in the same direction.

The following parameters are only valid for the rocker function "2-byte value transmitter"...

Description	Values	Comment
Function	Temperature value transmitter	A rocker configured as "Value transmitter 1 byte" permits selecting whether the values to be transmitted are to be interpreted as temperature values (0 °C to 40 °C), as brightness values (0 lux to 1500 lux) or as integers (0 to 65535). The following parameters and their settings depend on this selection.
	Brightness value transmitter	
	Value transmitter (0 ... 65535)	
Temperature value (0 ... 40 °C) Rocker 1.1	0... 20 ...40	Depending on the "Button arrangement" parameter, this parameter defines the object value when the top (or left-hand) rocker is pressed.
	0... 20 ...40	i Visible only if "Function = Temperature value transmitter"!

<p>Temperature value (0 ... 40 °C) Rocker 1.2</p>		<p>Depending on the "Button arrangement" parameter, this parameter defines the object value when the bottom (or right-hand) rocker is pressed.</p> <p>i Visible only if "Function = Temperature value transmitter"!</p>
<p>Brightness value Rocker 1.1</p>	<p>0, 50, ... 300 ... 1450, 1500 lux</p>	<p>Depending on the "Button arrangement" parameter, this parameter defines the object value when the top (or left-hand) rocker is pressed.</p> <p>i Visible only if "Function = Brightness value transmitter"!</p>
<p>Brightness value Rocker 1.2</p>	<p>0, 50, ... 300 ... 1450, 1500 lux</p>	<p>Depending on the "Button arrangement" parameter, this parameter defines the object value when the bottom (or right-hand) rocker is pressed.</p> <p>i Visible only if "Function = Brightness value transmitter"!</p>
<p>Value (0 ... 65535) Rocker 1.1</p>	<p>0 ... 65535</p>	<p>Depending on the "Button arrangement" parameter, this parameter defines the object value when the top (or left-hand) rocker is pressed.</p> <p>i Visible only with "Function = Value transmitter (0 ... 65535)"!</p>
<p>Value (0 ... 65535) Rocker 1.2</p>	<p>0 ... 65535</p>	<p>Depending on the "Button arrangement" parameter, this parameter defines the object value when the bottom (or right-hand) rocker is pressed.</p> <p>i Visible only with "Function = Value transmitter (0 ... 65535)"!</p>
<p>Value adjustment by long button-press</p>	<p>enabled Disabled</p>	<p>If value adjustment by long button-press is enabled, the ETS shows further parameters. Value adjustment begins, when the button is held down for more than 5 s. In</p>

		<p>this case, the respective status LED flashes as a sign that a new telegram has been transmitted.</p>
Starting value in case of value adjustment	<p>Same as configured value</p> <p>Same as value after last adjustment</p> <p>Same as value from communication object *</p>	<p>Value adjustment can begin with different starting values.</p> <p>After each long press, the pushbutton sensor always starts with the value configured in the ETS.</p> <p>After a long press, the pushbutton sensor starts with the value transmitted by itself or by another device with this group address as the last value.</p> <p>After a long press, the pushbutton sensor starts with the value transmitted by itself or by another device with this group address as the last value. *</p>
		<p>i Visible only if "Value adjustment by long button-press = enabled"!</p> <p>i *: This setting can only be selected with "Function = value transmitter (0...65535)"!</p>
Direction of value adjustment	<p>Upwards</p> <p>Downwards</p> <p>Toggling (alternating)</p>	<p>With a long press, the push button sensor can either vary the values always in the same direction or it stores the direction of the last adjustment and reverses it on the next button-press.</p>
		<p>i Visible only if "Value adjustment by long button-press = enabled"!</p>
Step width	1 °C	<p>For temperature values, the step width of the adjustment is fixed to 1°C.</p>
		<p>i Visible only if "Function = Temperature value transmitter" and "Value adjustment by long button-press = enabled"!</p>
Step width	50 lux	<p>For brightness values, the step width of the adjustment is fixed to 50 lux.</p>

		<p>i Visible only if "Function = Brightness value transmitter" and "Value adjustment by long button-press = enabled"!</p>
Step width	1 2 5 10 20 50 75 100 200 500 750 1000	<p>This parameter sets the step width of the value adjustment for the 2-byte value transmitter.</p> <p>i Only visible if "Function = Value transmitter (0 ... 65535)" and "Value adjustment by long button-press = enabled"!</p>
Time between two telegrams	0.5 sec 1 sec 2 sec 3 sec	<p>This parameter defines the interval at which the push button sensor transmits new telegrams during a value adjustment.</p> <p>i Visible only if "Value adjustment by long button-press = enabled"!</p>
Value adjustment with overflow	Yes No	<p>If value adjustment is to be effected without overflow (setting "No") and if the pushbutton sensor reaches the lower limit of the adjustment range (0°C, 0 lux, 0) or the upper limit (40°C, 1500 lux, 65535) during value adjustment, the adjustment will be stopped automatically by the sensor.</p> <p>If the value adjustment with overflow is programmed (setting "Yes") and if the push-button sensor reaches the lower or the upper limit, it will transmit the value of this range limit and then add a pause the duration of which corresponds to two levels. Thereafter, the push button sensor transmits a telegram with the value of the other range limits and continues the value adjustment in the same direction.</p>

The following parameters are only valid for the rocker function "scene extension"...

Description	Values	Comment
Function	<p>Scene extension without storage function</p> <p>Scene extension with storage function</p> <p>Recall of internal scene extension without storage function</p> <p>Recall of internal scene with storage function</p>	<p>This parameter defines the functionality of the extension.</p> <p>If the push button sensor is used as a scene extension, the scenes can either be stored in one or in several other KNX/EIB devices (e.g. light scene push button sensor).</p> <p>During a scene recall or in a storage function, the push button sensor transmits a telegram with the respective scene number via the extension object of the rocker.</p> <p>During the recall of an internal scene, a scene stored internally in the universal pushbutton sensor TSM is recalled or stored again. In this case, the sensor transmits no telegram to the bus via a scene extension object. For this setting, the internal scene function must be enabled.</p>
Scene number (1 ... 64) Rocker 1.1	1...64	In accordance with the KNX standard, objects with data type 18.001 "Scene Control" can recall or store up to 64 scenes by their numbers. The parameter defines the scene number to be transmitted when the top (or left) of the button is pressed.
Scene number (1 ... 64) Rocker 1.2	1...64	In accordance with the KNX standard, objects with data type 18.001 "Scene Control" can recall or store up to 64 scenes by their numbers. The parameter defines the scene number to be transmitted when the bottom (or right) of the button is pressed.
Scene number (1 ... 8) Rocker 1.1	1...8	This parameter defines the number of the internal scene which is recalled or stored when the top (or left) of the button is pressed.
Scene number (1 ... 8) Rocker 1.2	1...8	This parameter defines the number of the internal scene which is recalled or stored when the bottom (or right) of the button is pressed.

The following parameters are only valid for the rocker function "2-channel operation"...

Description	Values	Comment
Operation concept	Channel 1 or channel 2 Channel 1 and channel 2	This parameter defines the 2-channel operation concept. If the setting "Channel 1 or channel 2" is selected, the push button sensor decides dependent on the button-press duration which of the channels will be used. If the setting "Channel 1 and channel 2" is selected, the push button sensor transmits only the telegram of channel 1 on a short button-press and both telegrams on a sustained button-press.
Function channel 1 (2)	No function Switching (1 bit) Value transmitter 0 ... 255 (1-byte) Value transmitter 0 ... 100 % (1-byte) Temperature value transmitter (2 bytes)	This parameter defines the channel function and specifies which other parameters and which communication object are to be displayed for channel 1 (2).
Command of button for channel 1 (2) Rocker 1.1	ON OFF TOGGLE	This parameter defines the object value transmitted to the bus when the top (or left-hand) rocker is pressed. i Only visible if "Function channel 1 (2) = Switching (1 bit)"!
Command of button for channel 1 (2) Rocker 1.2	ON OFF TOGGLE	This parameter defines the object value transmitted to the bus when the bottom (or right-hand) rocker is pressed. i Only visible if "Function channel 1 (2) = Switching (1 bit)"!
Value of the button for Channel 1 (2) Rocker 1.1 (0...255)	0...255	This parameter defines the object value transmitted to the bus when the top (or left-hand) rocker is pressed. i Visible only if "Function channel 1 (2) = value transmitter 0...255 (1 byte)"!
	0...255	This parameter defines the object value transmitted to the bus when the bottom

Value of the button for
Channel 1 (2)
Rocker 1.2 (0...255)

(or right-hand) rocker is pressed.

i Visible only if "Function channel 1 (2) = value transmitter 0...255 (1 byte)"!

Value of the button for **0...100**
Channel 1 (2)
Rocker 1.1 (0 ... 100 %)

This parameter defines the object value transmitted to the bus when the top (or left-hand) rocker is pressed.

i Visible only if "Function channel 1 (2) = value transmitter 0...100 % (1 byte)"!

Value of the button for **0...100**
Channel 1 (2)
Rocker 1.2 (0 ... 100 %)

This parameter defines the object value transmitted to the bus when the bottom (or right-hand) rocker is pressed.

i Visible only if "Function channel 1 (2) = value transmitter 0...100 % (1 byte)"!

Temperature value of the button for channel 1 (2) **0...40**
Rocker 1.1 (0 ... 40 °C)

This parameter defines the temperature value transmitted to the bus when the top (or left-hand) rocker is pressed.

i Visible only if "Function channel 1 (2) = Temperature value transmitter (2 bytes)"!

Temperature value of the button for channel 1 (2) **0...40**
Rocker 1.2 (0 ... 40 °C)

This parameter defines the temperature value transmitted to the bus when the bottom (or right-hand) rocker is pressed.

i Visible only if "Function channel 1 (2) = Temperature value transmitter (2 bytes)"!

Time between channel 1 and channel 2 **0...30...255**
Rocker 1.1
(1 ... 255 x 100 ms)

Depending on the selected operation concept, this parameter defines the interval at which the push-button transmits the telegram for channel 1 and the telegram for channel 2 when the top (or left side) of the rocker is pressed.

<p>Time between channel 1 and channel 2 Rocker 1.2 (1 ... 255 x 100 ms)</p>	<p>0...30...255</p>	<p>Depending on the selected operation concept, this parameter defines the interval at which the push-button transmits the telegram for channel 1 and the telegram for channel 2 when the bottom (or right side) of the rocker is pressed.</p>
<p>Full-surface operation</p>	<p>enabled Disabled</p>	<p>When the full-surface operation is enabled, the ETS shows the following parameters.</p> <p>i Full-surface operation can only be programmed if "Operation concept = Channel 1 or channel 2"!</p>
<p>Function for full-surface operation</p>	<p>Switching Scene recall without store function Scene recall with storage function</p>	<p>In case of full-surface operation, this parameter defines the function that is to be used. The ETS shows the corresponding communication object and the other parameters. If the push button sensor is to recall a scene with storage function by full-surface actuation, it will make a distinction between a brief press (less than 1 s), a sustained press (longer than 5 s) and an invalid button-press (between 1 s and 5 s). A brief press recalls the scene, a sustained press stores a scene and an invalid full-surface operation is ignored.</p> <p>i Visible only if "Full-surface operation = enabled"!</p>
<p>Command for full-surface operation</p>	<p>ON OFF TOGGLE</p>	<p>This parameter defines the value of the transmitted telegram when a full-surface operation has been sensed. "TOGGLE" changes over the current object value.</p> <p>i Visible only if "Full-surface operation = enabled"!</p>
<p>Scene number (1 ... 64)</p>	<p>1, 2, ..., 64</p>	<p>This parameter defines the scene number which is to be transmitted to the</p>

bus after a scene recall or during storage of a scene.

i Visible only if "Full-surface operation = enabled"!

☐ Rockers 2 ... max. 4 see Rocker 1!

☐ Module rockers see rocker 1!

☐ Button 1 (only if "Function of buttons 1 and 2 = as separate buttons"!)

Function	No function Switching Dimming Venetian blind Value transmitter 1-byte 2-byte value transmitter Scene extension 2-channel operation Controller extension *	This parameter defines the basic function of the button. Depending on this setting, the ETS displays different communication objects and parameters for this button.
----------	------------------------------------------------------------------------------------------------------------------------------------------------------------------------------------------	----------------------------------------------------------------------------------------------------------------------------------------------------------------------

*: Must have been enabled under "General"!

The following parameters are only valid for the push-button function "switching"...

Description	Values	Comment
Command on pressing the button	No reaction ON OFF TOGGLE	Depending on the "button arrangement" parameter, these parameters define the reaction that takes place when the button is pressed or released.
Command on releasing the button	No reaction ON OFF TOGGLE	

The following parameters are only valid for the push-button function "dimming"...

Description	Values	Comment
Command on pressing the button	No reaction Brighter (ON) Darker (OFF) Brighter / darker (TOGGLE) Brighter (TOGGLE) Darker (TOGGLE)	This parameter defines the reaction when the button is pressed. If the push button sensor is to toggle on a brief press, the corresponding switching objects of other sensors with the same function must be linked with one another. In the "Brighter/darker (TOGGLE)" setting, the dimming objects must be interlinked as well so that the

push button sensor can send the correct telegram on the next button-press.

Time between switching and dimming
(100 ... 50000 x 1 ms)

100 ... **400** ... 50000

This parameter defines how long the button must be pressed for the push button sensor to transmit a dimming telegram.

Advanced parameters

Activated
Deactivated

When the advanced parameters are activated, the ETS shows the following parameters.

Advanced parameters activated...

Increase brightness by

1.5 %
3 %
6 %
12.5 %
25 %
50 %
100 %

This parameter sets the relative dimming level when the brightness is increased. On each button-press, the brightness is changed at maximum by the configured step width. Especially with smaller dimming levels it is advisable for the push button sensor to repeat the dimming telegrams automatically (see "telegram repetition").

Reduce brightness by

1.5 %
3 %
6 %
12.5 %
25 %
50 %
100 %

This parameter sets the relative dimming level when the brightness is reduced. On each button-press, the brightness is changed at maximum by the configured step width. Especially with smaller dimming levels it is advisable for the push button sensor to repeat the dimming telegrams automatically (see "telegram repetition").

Transmit stop telegram?

Yes
No

On "Yes" the push button sensor transmits a telegram for stopping the dimming process when the rocker is released. When the push button sensor transmits telegrams for dimming in smaller levels, the stop telegram is generally not needed.

Telegram repetition?

Yes
No

This parameter can be used to activate telegram repetition for dimming. With the button held down, the push button sensor will then transmit the relative dimming telegrams (in the programmed step width) until the button is released.

Time between two telegrams	200 ms 300 ms 400 ms 500 ms 750 ms 1 sec 2 s	This parameter defines the interval at which the dimming telegrams are automatically repeated in the telegram repetition mode.
		<input type="checkbox"/> Visible only if "Telegram repetition = Yes"!

The following parameters are only valid for the push-button function "blind"...

Description	Values	Comment
Command on pressing the button	DOWN UP TOGGLE	This parameter defines the running direction of a drive after a button-press. If the setting is "TOGGLE", the direction is changed after each long time command. If several push buttons are to control the same drive, the long time objects of the push buttons must be interlinked for a correct change of the running direction.
Operation concept	short – long – short long – short short – long long – short or short	For Venetian blind control, four different operation concepts can be selected. For these concepts, the ETS shows further parameters.
Time between short-time and long-time command (1 ... 3000 x 100 ms)	1 ... 4 ... 3000	This parameter sets the time after which the long time operation will be evaluated on pressing the top (or left-hand) button of the rocker.
		<input type="checkbox"/> This parameter is not visible with "Operation concept = long – short"!
Slat adjusting time (0 ... 3000 x 100 ms)	0 ... 5 ... 3000	Time during which a transmitted long time telegram can be terminated by releasing the top (or left-hand) button of the rocker (short time). This function serves to adjust the slats of a blind.

i This parameter is not visible with "Operation concept = long – short"!

The following parameters are only valid for the push-button function "1-byte value transmitter"...

Description	Values	Comment
Function	Value transmitter 0 ... 255 Value transmitter 0 ... 100 %	A button configured as "Value transmitter 1 byte" permits selecting whether the values to be transmitted are interpreted as integers from 0 to 255 or as a percentage from 0 % to 100 %. The following parameters and their settings depend on this distinction.
Value (0 ... 255)	0...255	This parameter defines the object value when the button is pressed. i Visible only if "Function = ... 0...255"!
Value (0 ... 100 %)	0...100	This parameter defines the object value when the button is pressed. i Visible only if "Function = ... 0...100 %"!
Value adjustment by long button-press	enabled Disabled	If value adjustment by long button-press is enabled, the ETS shows further parameters. Value adjustment begins, when the button is held down for more than 5 s. In this case, the respective status LED flashes as a sign that a new telegram has been transmitted.
Starting value in case of value adjustment		Value adjustment can begin with different starting values.
	Same as configured value	After each long press, the pushbutton sensor always starts with the value configured in the ETS.
	Same as value after last adjustment	After a long press, the pushbutton sensor starts with the value transmitted

	Same as value from communication object	by itself or by another device with this group address as the last value. After a long press, the pushbutton sensor starts with the value transmitted by itself or by another device with this group address as the last value.
		i Visible only if "Value adjustment by long button-press = enabled"!
Direction of value adjustment	Upwards Downwards Toggling (alternating)	With a long press, the push button sensor can either vary the values always in the same direction or it stores the direction of the last adjustment and reverses it on the next button-press.
		i Visible only if "Value adjustment by long button-press = enabled"!
Step width (1 ... 15)	1...15	In a value adjustment, the pushbutton sensor determines the new telegram value from the previous value and the preset step width. If the value falls below the lower limit of the adjustment range (0 or 0 %) or if it exceeds the upper limit (255 or 100%), the sensor adapts the step width of the last step automatically.
		i Visible only if "Value adjustment by long button-press = enabled"!
Time between two telegrams	0.5 sec 1 sec 2 sec 3 sec	In a value adjustment, the pushbutton sensor determines the new telegram value from the previous value and the preset step width. If the value falls below the lower limit of the adjustment range (0 or 0 %) or if it exceeds the upper limit (255 or 100%), the sensor adapts the step width of the last step automatically.
		i Visible only if "Value adjustment by long button-press = enabled"!
Value adjustment with overflow	Yes No	If value adjustment is to be effected without overflow (setting "No") and if the pushbutton sensor reaches the lower limit of the adjustment range (0 or 0 %)

or the upper limit (255 or 100 %) during value adjustment, the adjustment will be stopped automatically by the sensor. If the value adjustment with overflow is programmed (setting "Yes") and if the push button sensor reaches the lower or the upper limit, it will transmit the value of this range limit and then add a pause the duration of which corresponds to two levels. Thereafter, the push button sensor transmits a telegram with the value of the other range limit and continues the value adjustment in the same direction.

The following parameters are only valid for the push-button function "2-byte value transmitter"...

Description	Values	Comment
Function	<p>Temperature value transmitter</p> <p>Brightness value transmitter</p> <p>Value transmitter (0 ... 65535)</p>	<p>A button configured as "Value transmitter 1 byte" permits selecting whether the values to be transmitted are to be interpreted as temperature values (0 °C to 40 °C), as brightness values (0 lux to 1500 lux) or as integers (0 to 65535). The following parameters and their settings depend on this selection.</p>
Temperature value (0 ... 40 °C)	0... 20 ...40	<p>This parameter defines the object value when the button is pressed.</p> <p>i Visible only if "Function = Temperature value transmitter"!</p>
Brightness value	0, 50, ... 300 ... 1450, 1500 lux	<p>This parameter defines the object value when the button is pressed.</p> <p>i Visible only if "Function = Brightness value transmitter"!</p>
Value (0 ... 65535)	0 ... 65535	<p>This parameter defines the object value when the button is pressed.</p>

		<p>i Visible only with "Function = Value transmitter (0 ... 65535)"!</p>
Value adjustment by long button-press	<p>enabled</p> <p>Disabled</p>	<p>If value adjustment by long button-press is enabled, the ETS shows further parameters. Value adjustment begins, when the button is held down for more than 5 s. In this case, the respective status LED flashes as a sign that a new telegram has been transmitted.</p>
Starting value in case of value adjustment	<p>Same as configured value</p> <p>Same as value after last adjustment</p> <p>Same as value from communication object *</p>	<p>Value adjustment can begin with different starting values.</p> <p>After each long press, the pushbutton sensor always starts with the value configured in the ETS.</p> <p>After a long press, the pushbutton sensor starts with the value transmitted by itself or by another device with this group address as the last value.</p> <p>After a long press, the pushbutton sensor starts with the value transmitted by itself or by another device with this group address as the last value. *</p>
		<p>i Visible only if "Value adjustment by long button-press = enabled"!</p> <p>i *: This setting can only be selected with "Function = value transmitter (0...65535)"!</p>
Direction of value adjustment	<p>Upwards</p> <p>Downwards</p> <p>Toggling (alternating)</p>	<p>With a long press, the push button sensor can either vary the values always in the same direction or it stores the direction of the last adjustment and reverses it on the next button-press.</p>
		<p>i Visible only if "Value adjustment by long button-press = enabled"!</p>
Step width	<p>1 °C</p>	<p>For temperature values, the step width of the adjustment is fixed to 1°C.</p>

		<p>i Visible only if "Function = Temperature value transmitter" and "Value adjustment by long button-press = enabled"!</p>
Step width	50 lux	For brightness values, the step width of the adjustment is fixed to 50 lux.
		<p>i Visible only if "Function = Brightness value transmitter" and "Value adjustment by long button-press = enabled"!</p>
Step width	<p>1 2 5 10 20 50 75 100 200 500 750 1000</p>	<p>This parameter sets the step width of the value adjustment for the 2-byte value transmitter.</p> <p>i Only visible if "Function = Value transmitter (0 ... 65535)" and "Value adjustment by long button-press = enabled"!</p>
Time between two telegrams	<p>0.5 sec 1 sec 2 sec 3 sec</p>	<p>This parameter defines the interval at which the push button sensor transmits new telegrams during a value adjustment.</p> <p>i Visible only if "Value adjustment by long button-press = enabled"!</p>
Value adjustment with overflow	<p>Yes No</p>	<p>If value adjustment is to be effected without overflow (setting "No") and if the pushbutton sensor reaches the lower limit of the adjustment range (0°C, 0 lux, 0) or the upper limit (40°C, 1500 lux, 65535) during value adjustment, the adjustment will be stopped automatically by the sensor.</p> <p>If the value adjustment with overflow is programmed (setting "Yes") and if the push-button sensor reaches the lower or the upper limit, it will transmit the value of this range limit and then add a pause the duration of which corresponds to two levels. Thereafter, the push button sensor transmits a telegram with the</p>

value of the other range limits and continues the value adjustment in the same direction.

The following parameters are only valid for the push-button function "scene extension"...

Description	Values	Comment
Function	<p>Scene extension without storage function</p> <p>Scene extension with storage function</p> <p>Recall of internal scene extension without storage function</p> <p>Recall of internal scene with storage function</p>	<p>This parameter defines the functionality of the extension.</p> <p>If the push button sensor is used as a scene extension, the scenes can either be stored in one or in several other KNX/EIB devices (e.g. light scene push button sensor). During a scene recall or in a storage function, the push button sensor transmits a telegram with the respective scene number via the extension object of the button.</p> <p>During the recall of an internal scene, a scene stored internally in the universal pushbutton sensor TSM is recalled or stored again. In this case, the sensor transmits no telegram to the bus via a scene extension object. For this setting, the internal scene function must be enabled.</p>
Scene number (1 ... 64)	1...64	In accordance with the KNX standard, objects with data type 18.001 "Scene Control" can recall or store up to 64 scenes by their numbers. The parameter defines the scene number to be transmitted when the button is pressed.
Scene number (1 ... 8)	1...8	This parameter defines the number of the internal scene which is recalled or stored when a button is pressed.

The following parameters are only valid for the push-button function "2-channel operation"...

Description	Values	Comment
Operation concept		

	Channel 1 or channel 2 Channel 1 and channel 2	This parameter defines the 2-channel operation concept. If the setting "Channel 1 or channel 2" is selected, the push button sensor decides dependent on the button-press duration which of the channels will be used. If the setting "Channel 1 and channel 2" is selected, the push button sensor transmits only the telegram of channel 1 on a short button-press and both telegrams on a sustained button-press.
Function channel 1 (2)	No function Switching (1 bit) Value transmitter 0 ... 255 (1-byte) Value transmitter 0 ... 100 % (1-byte) Temperature value transmitter (2 bytes)	This parameter defines the channel function and specifies which other parameters and which communication object are to be displayed for channel 1 (2).
Command of button for channel 1 (2)	ON OFF TOGGLE	This parameter defines the object value transmitted to the bus when the button is pressed. i Only visible if "Function channel 1 (2) = Switching (1 bit)"!
Value of the button for Channel 1 (2) (0 ... 255)	0...255	This parameter defines the object value transmitted to the bus when the button is pressed. i Visible only if "Function channel 1 (2) = value transmitter 0...255 (1 byte)"!
Value of the button for Channel 1 (2) (0 ... 100 %)	0...100	This parameter defines the object value transmitted to the bus when the button is pressed. i Visible only if "Function channel 1 (2) = value transmitter 0...100 % (1 byte)"!
Temperature value of the button for channel 1 (2) (0 ... 40 °C)	0...40	This parameter defines the temperature value transmitted to the bus when the button is pressed.

i Visible only if "Function channel 1 (2) = Temperature value transmitter (2 bytes)"!

Time between channel 1 and channel 2
(1 ... 255 x 100 ms)

0...**30**...255

Depending on the selected operation concept, this parameter defines the interval at which the push button transmits the telegram for channel 1 and the telegram for channel 2 when the button is pressed.

The following parameters are only valid for the push-button function "controller extension"...

Description	Values	Comment
Function	Operating mode switchover Forced oper. mode switchover Presence button setpoint shift	A controller extension can optionally switch over the operating mode with normal or high priority, change the presence state or change the current room temperature value. With regard to the setting of this parameter, the ETS shows further parameters.
Operating mode when the following button is pressed	Comfort mode Standby mode Night mode Frost/heat protection mode Comfort mode -> Standby mode -> Comfort mode -> Night mode -> Standby mode -> Night mode -> Comfort mode -> Standby mode -> Night mode ->	If the controller extension is to change over the operating mode of the room temperature controller with normal priority, the extension can – when operated – either switch on a defined operating mode or change over between different operating modes. In order for this change to work properly, the controller extension should request the current state of the extension objects after a reset or after re-programming (set parameter under "General" to "Value request from controller extension = Yes"). i Only visible if "Function = operating mode change-over"!
Forced operating mode when the following button is pressed	Auto (Normal operating mode change-over) Comfort mode	If the controller extension is to change over the operating mode of the room temperature controller with high priority, the extension can – when actuated – either enable the change-over with normal priority (auto), switch on a

	Standby mode	defined operating mode with a high priority or change over between different operating modes.
	Night mode	
	Frost/heat protection mode	In order for this change to work properly, the controller extension should request the current state of the extension objects after a reset or after re-programming (set parameter under "General" to "Value request from controller extension = Yes").
	Comfort mode -> Standby mode ->	
	Comfort mode -> Night mode ->	
	Standby mode -> Night mode ->	i Only visible if "Function = Forced operating mode change-over"!
	Comfort mode -> Standby mode -> Night mode ->	
	Auto -> Comfort mode ->	
	Auto -> Standby mode ->	
Presence function when the following button is pressed	Presence OFF Presence ON Presence TOGGLE	On pressing a key, the controller extension can switch the presence state of the room temperature controller either on or off in a defined way or change over between both states ("Presence TOGGLE"). In order for this change-over to work properly, the controller extension should request the current state of the extension objects after a reset or after re-programming (set parameter under "General" to "Value request from controller extension? = Yes").
With the "Setpoint shift" function...		
Setpoint shift on pressing the button	Reduce setpoint value (level size) Increase setpoint (level size)	This parameter defines the direction of the setpoint shift on the extension. For a setpoint value shift, the controller extension makes use of the two communication objects "Setpoint shift output" and "Setpoint shift input". The "Setpoint shift input" communication object informs the extension about the current state of the room temperature controller. Based on this value and the respective parameter, the controller extension determines the new level size which it transmits via the "Setpoint shift output" communication object to the room temperature controller.

☐↵ Buttons 2 ... max. 8 see Button 1!

☐↵ Module buttons see Button 1!

For each rocker or push-button function, additional parameters are available for the status LED, as described in the following...

Description	Values	Comment
Function of the status LED *	always OFF	Irrespective of the button or rocker function, the status LED is switched off permanently.
*: For the rocker function separate parameters are present and configurable for the upper and lower status LEDs.	always ON	Irrespective of the button or rocker function, the status LED is switched on permanently.
	Button-press display	The status LED indicates a button actuation. The ON time is set on the parameter page "General" in common for all status LEDs that are configured as actuation displays.
	Telegram acknowledgment	The status LED indicates the transmission of a telegram in 2-channel operation. i This setting can only be configured for the button or rocker function "2-channel operation".
	Status display (switching object)	The status LED indicates the state of the communication object "Switching". If the object value is "ON", the status LED is illuminated. If the object value is "OFF" the status LED is switched off.

	<p>i This setting can only be configured for the button or rocker function "Switching" or "Dimming."</p>
inverted status display (switching object).	<p>The status LED indicates the state of the communication object "Switching". If the object value is "OFF", the status LED is illuminated. If the object value is "ON" the status LED is switched off.</p>
	<p>i This setting can only be configured for the button or rocker function "Switching" or "Dimming."</p>
Control via separate LED object	<p>The status LED indicates the state of its own, separate 1-bit LED object. This setting causes the additional parameter "Control of the status LED via object value" to be shown.</p>
Button function active display	<p>The status LED indicates the state of the presence button in case of controller extension operation. The LED lights up if the presence function is activated. The LED is off if the presence function is inactive.</p>
	<p>i This setting can only be configured in the button function "Controller extension" and with the button function "Presence button".</p>
Button function inactive display	<p>The status LED indicates the state of the presence button in case of controller extension operation. The LED lights up if the presence function is inactive. The LED is off if the presence function is activated.</p>
	<p>i This setting can only be configured in the button function "Controller extension" and with the button function "Presence button".</p>
Setpoint value shift display	<p>The status LED indicates the state of a setpoint shift in case of controller extension operation. This setting causes the additional parameter "Status LED" to be shown.</p>

i This setting can only be configured in the button function "Controller extension" and with the button function "Setpoint shift".

Operating mode display (KNX controller)

The status LED indicates the state of a KNX room temperature controller via a separate 1-byte communication object. This setting causes the additional parameter "Status LED ON with" to be shown.

Controller status indication (activate controller extension!)

The status LED indicates the state of the controller extension. This setting causes the additional parameter "Status LED ON with" to be shown.

Comparator without sign (1-byte)

The status LED is activated depending on a comparison. In this configuration there is a separate 1-byte communication object available via which the unsigned reference value (0...255) is received. This setting causes the additional parameter "Status LED ON with" to be shown.

Comparator with sign (1-byte)

The status LED is activated depending on a comparison. In this configuration there is a separate 1-byte communication object available via which the positive or negative reference value (-128...127) is received. This setting causes the additional parameter "Status LED ON with" to be shown.

i The presettings of the parameter "Function of status LED" depend on the configured button or rocker function.

The function of the status LED = "Display via separate LED object"...

Control of the status LED via object value

1 = LED static ON /

0 = LED static OFF

1 = LED static OFF /
0 = LED static ON

1 = LED flashes /
0 = LED static OFF

1 = LED static OFF /

If the "Function of status LED ..." is set to "Control via separate LED object", then the telegram polarity of the 1-bit object "Status LED" can be specified at this point.

The LED can be switched on or off statically. In addition, the received switching telegram can be evaluated in such a way that the LED flashes.

0 = LED flashes

If the function of status LED = "Operating mode display (KNX controller)"...

Status LED ON with

Automatic mode
Comfort mode
 Standby mode
 Night mode
 Frost/heat protection mode

The values of a communication object with data type 20.102 "HVAC Mode" are defined as follows:

0 = Automatic
 1 = Comfort
 2 = Standby
 3 = Night
 4 = Frost/heat protection

The value "Automatic" is used only by the "forced operating mode switchover" objects.

The status LED is illuminated when the object receives the value configured here.

The function of the status LED = "Controller status indication"...

Status LED ON with

Comfort mode
 Standby mode
 Night mode
 Frost/heat protection mode
 Controller disabled
 Heating / cooling
 Controller inactive (deadband operation)
 Frost alarm

The "Controller status" communication object of the controller extension function includes eight bits of information in one byte. This parameter defines which bit is to be indicated by the LED.

i The controller status can be indicated only if the controller extension is enabled (parameter page "General")!

If the function of status LED = "Comparator without sign"...

Status LED ON with

Reference value greater than received value

The status LED indicates whether the configured reference value is greater or less than or equal to the value of the "Status LED" object".

Reference value less than received value

Reference value equal to received value

Reference value (0 ... 255)

0...255

This parameter defines the reference value to which the value of the "Status LED" object is compared.

If the function of status LED = "Comparator with sign" ...

Status LED ON with	<p>Reference value greater than received value</p> <p>Reference value less than received value</p> <p>Reference value equal to received value</p>	<p>The status LED indicates whether the configured reference value is greater or less than or equal to the value of the "Status LED" object".</p>
Reference value (-128 ... 127)	-128... 0 ...127	This parameter defines the reference value to which the value of the "Status LED" object is compared.

Room temperature measurement

Temperature detection through

internal temperature sensor

The "Temperature detection" parameter specifies the sensors to detect the room temperature.

The temperature sensor integrated in the push-button sensor is activated. Thus, the room temperature value is determined only locally on the device.

internal and external temperature sensor

With this setting, the internal temperature sensor is combined with a KNX temperature sensor coupled via the 2-byte object "External temperature sensor". The weighting of the internal and external temperature value can be defined.

Determination of measured value from internal / external ratio

- 10% to 90%
- 20% to 80%
- 30% to 70%
- 40% to 60%
- 50% to 50%**
- 60% to 40%
- 70% to 30%
- 80% to 20%
- 90% to 10%

The weighting of the temperature values of the internal and external sensor is specified here. That results in an overall value, which will be used for the further interpretation of the room temperature. This parameter is only visible with "temperature detection = internal and external sensor".

Internal sensor calibration (-128...127 * 0,1 K)

-128...**0**...127

Some cases may require to calibrate the measured values of the internal sensor. For example, a calibration becomes necessary if the temperature measured by the sensor stays permanently below or above the actual room temperature. To determine the temperature deviation, the actual room temperature should be detected with a reference measurement

		using a suitable temperature measuring device. Using this parameter, it is possible to configure the positive (temperature increase, factors: 1 ... 127) or negative (temperature decrease, factors -128... -1) temperature calibration.
External sensor calibration (-128...127 * 0,1 K)	-128... 0 ...127	Some cases may require to calibrate the measured values of the external sensor. For example, a calibration becomes necessary if the temperature measured by the sensor stays permanently below or above the actual room temperature. To determine the temperature deviation, the actual room temperature should be detected with a reference measurement using a suitable temperature measuring device. Using this parameter, it is possible to configure the positive (temperature increase, factors: 1 ... 127) or negative (temperature decrease, factors -128... -1) temperature calibration.
Scanning time for external sensor (0...255 * 1 minute) (0 = inactive)	0 ...255	The polling time for the external temperature sensor is specified here. In the "0" setting, the temperature value is not automatically polled. In this case, the communication partner (e.g. KNX temperature sensor) must transmit its temperature value itself. This parameter is only visible when the temperature detection system requires an external sensor.
Cyclical transmission of room temperature (0...255 * 1 minute) (0 = inactive)	0 ...255	In addition to transmission on changes, the determined room temperature can be transmitted cyclically. This parameter specifies the cycle time. The value "0" will deactivate the periodical transmission of the room temperature value.
Transmission when room temperature change by (0..255 * +/- 0,1 K) (0 = inactive)	0... 3 ...255	The change value of the temperature for automatic transmission is specified here. Compared with the last measurement, the room temperature must change by at least the configured value for a new temperature value to be transmitted automatically via the object "Measured room temperature". Temperature

		changes between 0.1 K and 25.5 K can be configured. If "0" is selected, the automatic transmission of the room temperature after a value change is deactivated.
□- Disabling		
Disabling function?	Yes No	With this parameter, the disabling function of the push button sensor can be centrally activated. If "Yes", the ETS shows further communication object and parameters.
Polarity of disabling object	Disable = 1 / enable = 0 Disable = 0 / enable = 1	This parameter defines the value of the disabling object at which the disabling function is active.
Reaction of pushbutton sensor at the beginning of the disabling function	No reaction Reaction as button >>X<< when pressed Reaction as button >>X<< when released Reaction as disabling function 1 when pressed Reaction as disabling function 1 when released Reaction as disabling function 2 when pressed Reaction as disabling function 2 when released internal scene recall scene 1 internal scene recall scene 2 internal scene recall scene 3 internal scene recall scene 4 internal scene recall scene 5	Besides disabling of rocker and button functions, the push-button sensor can also and in addition trigger a specific function at the time of activation of the disabling state. This function can... correspond to the function assigned to any of the buttons in the non-disabled state ("Reaction as button >>X<< ..."), be defined on the following parameter pages ("Reaction as disabling function ..."), recall a scene stored internally in the push-button sensor ("Internal scene recall ...").

	internal scene recall scene 6	
	internal scene recall scene 7	
	internal scene recall scene 8	
Button >> X <<	<p>Button 1 Button 2 ... Module button 16 *</p>	<p>If the push-button sensor is to perform the function of a specific button at the beginning of the disabling state, this button will be selected here.</p> <p>Visible only if "Reaction of push-button sensor at the beginning of the disabling function = Reaction as button >>X<< on pressing / releasing"!</p>
		<p>i *: The number of buttons depends on the configured pushbutton sensor variant! Moreover, the module buttons can only be selected here if a corresponding extension module is also connected to the basic unit.</p>
Behaviour during active disabling	<p>all buttons without function</p> <p>all buttons behave as</p> <p>individual buttons without function</p> <p>individual buttons behave as</p>	<p>While disabling is active... all buttons or only individually selected buttons can be disabled ("... no function"), all buttons or only individually selected buttons can be restricted to a specific function ("... behave as"). In this case, the ETS shows further parameters.</p>
All buttons with even numbers behave during disabling as	<p>Button 1 Button 2 ... Module button 16 *</p> <p>Disabling function 1</p> <p>Disabling function 2</p>	<p>If a specific button function is to be assigned during disabling to all or to individual buttons, this parameter can be used to select the desired button the function of which will then be executed. During disabling, all buttons with even numbers (2, 4, 6,...) behave like the one configured here.</p> <p>The desired functions can either correspond to the function of an existing button or they can be configured as special disabling functions.</p>

All buttons with odd numbers behave during disabling as

- Button 1**
- Button 2
- ...
- Module button 16 *
- Disabling function 1
- Disabling function 2

- i** Visible only if "Behaviour during active disabling = all buttons behave as" or "Behaviour during active disabling = individual buttons behave as"!
- i** *: The number of buttons depends on the configured pushbutton sensor variant! Moreover, the module buttons can only be selected here if a corresponding extension module is also connected to the basic unit.

If a specific button function is to be assigned during disabling to all or to individual buttons, this parameter can be used to select the desired button the function of which will then be executed. During disabling, all buttons with odd numbers (1, 3, 5,...) behave like the one configured here. The desired functions can either correspond to the function of an existing button or they can be configured as special disabling functions.

- i** Visible only if "Behaviour during active disabling = all buttons behave as" or "Behaviour during active disabling = individual buttons behave as"!
- i** *: The number of buttons depends on the configured pushbutton sensor variant! Moreover, the module buttons can only be selected here if a corresponding extension module is also connected to the basic unit.

Reaction of pushbutton sensor at the end of disabling

- No reaction**
- Reaction as button >>Y<< when pressed
- Reaction as button >>Y<< when released
- Reaction as disabling function 1 when pressed
- Reaction as disabling function 1 when released

Besides disabling of rocker and button functions, the push-button sensor can also trigger a special function immediately at the end of disabling. This function can... correspond to the function assigned to any of the buttons in the non-disabled state ("Reaction as button >>Y<< ..."), be defined on the following parameter pages ("Reaction as disabling function ..."), recall a scene stored internally in the push-button sensor ("Internal scene recall ...").

Reaction as disabling
function 2 when pressed

Reaction as disabling
function 2 when released

internal scene recall
scene 1

internal scene recall
scene 2

internal scene recall
scene 3

internal scene recall
scene 4

internal scene recall
scene 5

internal scene recall
scene 6

internal scene recall
scene 7

internal scene recall
scene 8

Button >>Y<<

Button 1

Button 2

...

Module button 16 *

If the push-button sensor is to perform the function of a specific button at the end of the disabling state, this button will be selected here.

Only visible if "Reaction of push-button sensor at the end of disabling = Reaction as button >>Y<< on pressing / releasing"!

i *: The number of buttons depends on the configured pushbutton sensor variant! Moreover, the module buttons can only be selected here if a corresponding extension module is also connected to the basic unit.

Disable - Button selection (only visible if "Behaviour during active disabling = individual buttons without function" or "Behaviour during active disabling = individual buttons behave as"!)

Selection of the buttons
for behaviour during
disabling

Button 1?	Yes No	The user can specify for each button separately whether it will be affected by the disabling function during the disabling state.
Button 2?	Yes No	
...		
Module button 16?*	Yes No	i *: The number of buttons depends on the configured pushbutton sensor variant! Moreover, the module buttons can only be selected here if a corresponding extension module is also connected to the basic unit.
<input type="checkbox"/> Disabling function 1 disable / Disabling function 2 disable. With the exception of the status LED control, the parameters available for the two disabling functions are the same as those for the button functions.		
<input type="checkbox"/> Scenes / scene data types (name of parameter page changes with scene function activated).		
Scene function ?	Yes No	The push-button sensor can handle internally eight scenes with eight actuator groups. This parameter activates the scene function and the other parameters and communication objects, if needed.
Overwrite scene values during ETS download	Yes No	If the values of the actuator groups that have been changed on site by the customer are to be reset to the values preset in the ETS during an application download by the ETS, the setting "Yes" must be chosen. If "No" is selected, the ETS values will not overwrite the scene values stored in the push-button sensor, if any.
Data types	Switching	The push-button sensor has an independent communication object for each of the eight actuator groups. With these parameters, the object type can be set separately for each output.
Scene output 1	Value (0 ... 255) Value / position of Venetian blind(0 ... 100 %)	
...		
Scene output 8	Switching Value (0 ... 255) Value / position of Venetian blind(0 ... 100 %)	
<input type="checkbox"/> Scene 1	1...64	

Recall via extension
object with scene
number

If the internal scenes are to be recalled via the extension object, a definite number is required for each of them. This parameter serves to specify the extension number of the first scene.

i If several internal scenes have the same scene number, only the first scene with this number can be called up.

Scene output 1
Switching command

ON
OFF

This parameter can be used to predefine the switching command of the first scene output.

i Only visible if "Data types scene output 1 = switching"!

Scene output 1
Value (0 ... 255)

0...255

This parameter can be used to predefine the value of the first scene output.

i Only visible if "Data types scene output 1 = switching"!

Scene output 1
Value / position of
Venetian blind
(0 ... 100 %)

0...100

This parameter can be used to predefine the value of the first scene output.

i Only visible if "Data types scene output 1 = switching"!

Scene output 1
Allow save?

Yes
No

If the user is to be given the possibility of changing the value of the actuator group (scene output) within this scene and of storing it during regular operation, this parameter must be set to "Yes".

Scene output 1
Allow transmission?

Yes
No

If the state of an actuator group is to remain unchanged during the recall of a scene, this parameter can be set to "No". In this case, the push-button sensor does not transmit a telegram via the scene output concerned during the recall of the scene. The scene output is deactivated for this scene.

<p>Scene output 1 Transmit delay (1 ... 1200 * 100 ms) (0 = deactivated)</p>	<p>0...1200</p>	<p>When the push-button sensor sends the telegrams to the various scene outputs, it can insert a presettable waiting time of 2 min. max. before each telegram.</p> <p>This can be used to reduce bus loading, but also to have certain lamps switched on only after the shutters are really closed.</p> <p>If no delay is selected, the push-button sensor sends the output telegrams with maximum speed. With this setting it may happen in some cases that the telegram sequence is not compatible with output numbering.</p>
<p>Scene outputs 2 ... 8 see scene output 1!</p>		
<p><input type="checkbox"/> Scenes 2 ... 8 see scene 1!</p> <p><input type="checkbox"/> Alarm signalling</p>		
<p>Alarm signal display</p>	<p>activated deactivated</p>	<p>This parameter can be used to enable alarm signal displaying. When alarm signalling is enabled, the ETS displays further parameters and up to two further communication objects.</p>
<p>Polarity of the alarm signalling object</p>	<p>Alarm when ON and Alarm reset when OFF Alarm when OFF and Alarm reset when ON</p>	<p>The alarm signalling object is used as an input for activating or deactivating alarm signal displaying. If the object value corresponds to the "Alarm" state, all status LEDs and the operation LEDs flash with a frequency of approx. 2 Hz.</p> <p>If the setting is "Alarm when OFF and alarm reset when ON", the object must first be actively written by the bus with "0" to activate the alarm after a reset.</p> <p>An alarm signal is not stored so that the alarm signalling is generally deactivated after a reset or after programming with the ETS.</p>
<p>Reset alarm signalling by a button actuation?</p>	<p>Yes No</p>	<p>If this parameter is set to "Yes", active alarm signal displaying can be deactivated by a button actuation on the push-button sensor. This button function does not cause the configured function of the pressed</p>

button to be executed. Only after the next button-press will the configuration of the button be evaluated and a telegram be transmitted to the bus, if applicable.

If "No" has been selected, alarm signalling can only be deactivated via the alarm signalling object. A button-press will always execute the configured button function.

Use the alarm
acknowledge object?

Yes

No

If alarm signalling can be deactivated by a button actuation, this parameter defines whether an additional alarm acknowledge telegram is to be transmitted to the bus via the separate object "Alarm signalling acknowledge" after triggering by this button-press.

A telegram can, for instance, be sent via this object to the "Alarm signalling" objects of other push button sensors in order to reset the alarm status there as well (observe the polarity of the acknowledge object!).

Acknowledge alarm
signalling by

OFF telegram *
ON telegram *

This parameter sets the polarity of the "Alarm signalling acknowledge" object.

i *: The presetting for this parameter depends on the polarity set for the alarm message object.

5 Appendix

5.1 Index

A	
Alarm signalling.....	86
B	
Button arrangement.....	45
Button evaluation.....	40
C	
Control surfaces.....	18,37
Controller extension unit.....	77
Controller extension unit button functions	79
D	
Delivery state.....	87
Device components.....	7
disabling function.....	71
F	
Fitting the control surfaces.....	16
I	
Installation location.....	84
O	
Object for operation LED.....	33
Objects for alarm message.....	34
Objects for controller extension.....	34
Objects for disabling functions.....	29
Objects for full-surface operation.....	28
Objects for scene function.....	35
Objects for status LED.....	28
Operation concept.....	40
Operation LED.....	47
P	
Parameter group "Alarm signalling" ...	124, 132
Parameter group "Button 1".....	108
Parameter group "Disable - Button selection"	129
Parameter group "Disabling".....	126
Parameter group "General".....	88
Parameter group "Operation concept basic module" ...	90-91
Parameter group "Rocker 1 (Button 1/2)"	92
Parameter group "Scene 1"	130
Parameter group "Scene"	130
R	
Rockers and push-button function.....	49
room temperature.....	85
S	
Scene control.....	67
Scene definition.....	67
Scene recall.....	67
Scope of functions.....	21
Snapping on the adapter frame.....	11
Status LED.....	63
Storing scenes.....	70
T	
Temperature calibration.....	85
Temperature detection.....	84
Three-button press.....	75
Transmit delay.....	48

ALBRECHT JUNG GMBH & CO. KG

Volmestraße 1
58579 Schalksmühle
GERMANY

Telefon: +49 2355 806-0
Telefax: +49 2355 806-204
kundencenter@jung.de
www.jung.de