



Product documentation

Standard automatic switch 1.1 m
Art. No. ..3181..

Standard automatic switch 2.2 m
Art. No. ..3281..



ALBRECHT JUNG GMBH & CO. KG
Volmestraße 1
58579 Schalksmühle
GERMANY

Telefon: +49 2355 806-0
Telefax: +49 2355 806-204
kundencenter@jung.de
www.jung.de

Issue: 21.08.2019
6578x320 V3

Table of Contents

1	Product definition	4
1.1	Product catalogue	4
1.2	Function	4
2	Installation, electrical connection and operation	6
2.1	Safety instructions	6
2.2	Device components	7
2.3	Fitting and electrical connection	8
2.4	Commissioning	22
2.5	Operation	23
3	Technical data	25
4	Software description	26
4.1	Software specification	26
4.2	Software "PIR A0331x"	27
4.2.1	Scope of functions	27
4.2.2	Notes on software	28
4.2.3	Object table	29
4.2.3.1	Objects for the sensor	29
4.2.3.2	Objects for function blocks 1...5	30
4.2.3.3	40	40
4.2.4	Functional description	41
4.2.4.1	Global block diagram	41
4.2.4.2	Motion and light sensor	42
4.2.4.2.1	PIR sensor	42
4.2.4.2.2	Brightness sensor	44
4.2.4.2.3	Walking test and display of motion impulses	48
4.2.4.3	Function blocks 1-5 for motion detection	50
4.2.4.3.1	Applications	50
4.2.4.3.2	Application types	55
4.2.4.3.3	Operating mode	59
4.2.4.3.4	Operating mode and local control	61
4.2.4.3.5	Output functions	71
4.2.4.3.6	Sensor assignment	72
4.2.4.3.7	Brightness evaluation	73
4.2.4.3.8	Manual operation	76
4.2.4.3.9	Application examples	78
4.2.4.3.10	Behaviour at the beginning of a detection	85
4.2.4.3.11	Behaviour at the end of a detection	90
4.2.4.3.12	Disabling function	95
4.2.4.3.13	Reset behaviour	97
4.2.4.4	General reset behaviour	99
4.2.4.5	Delivery state	100
4.2.5	Parameters	101

5 Appendix	129
5.1 Index	129

1 Product definition

1.1 Product catalogue

Product name: Standard automatic switch 1.1 m / Standard automatic switch 2.2 m

Use: Physical sensor

Design: FM (flush-mounted)

Art. No. ..3181.. / ..3281..

1.2 Function

Application

The device is equipped with two passive infrared sensors (PIR), a brightness sensor and is used for requirement-orientated control of lighting systems and other electrical consumers. The PIR sensors react to heat motion triggered by people, animals or objects. The brightness sensor measures the ambient brightness to evaluate the set twilight level and switch-off brightness. Depending on the configuration, the device is operated for detecting motion (as a detector) and room surveillance (alert operation). In the application as a detector, the device is normally used to control lighting automatically if people are present. In so doing, the evaluation of movements can be performed according to the ambient brightness (twilight level) or independently of the brightness. In automatic mode, lighting switched on by the detector is only switched off independently of the ambient brightness if no movement is detected in the monitored area. If necessary, in brightness-dependent operation, the ambient brightness can be evaluated continuously even if the lighting is switched on (detector with switch-off brightness). Thus, for example, lighting can be switched off when a defined brightness threshold is exceeded, e.g. by incoming daylight, even if motion continues.

When being used as a detector, the device always works independently of the brightness. Message telegrams signal whether or not people are present in the monitored area. Here, the number of motion impulses can be specified within a monitoring time whereby it is possible to adapt the motion evaluation to individual requirements. A motion is only identified, when the device has detected the set number of motion impulses. This application is appropriate when the device is to be used as a detector for KNX signalling systems.

Motion detection and brightness sensor

The motion detection of the device takes place digitally via 2 PIR sectors with a total detection area of 180°. The sensitivity of the motion detection, which is a gauge for the range of the PIR evaluation, can be configured separately in the ETS for the PIR sectors and can also be adjusted by using an adjuster directly on the device after commissioning.

To determine the ambient brightness, the device possesses a brightness sensor, located behind the lens. The sensor detects the mixed light of its environment composed of artificial light and daylight. Light measurement occurs in the direction the lens is looking. The factory calibration of the device is set in such a way that the brightness is determined at the lens. A coefficient programmed at the factory enables the device to determine the effective brightness in the room. To minimise deviations of the determined brightness at the lens to the room brightness, the brightness measurement can be calibrated individually using the user calibration.

The brightness value determined by the device can be made available to other bus subscribers via an object for the purpose of display or evaluation.

Function block

The device has a function block which is assigned to the two PIR sectors for the purpose of motion evaluation. The function block is fully configurable to the application "Detector", "Detector with switch-off brightness" or "Alert operation". Up to two output communication objects are available, which transmit the switching and control commands to the KNX. Depending on the configured function (switching, staircase function, dimming value transmitter, scene extension, temperature value transmitter, brightness value transmitter, operating mode switchover, switching with forced position), the data format of these objects is defined

separately and adapted to the controllable function units of the KNX system. Extensive parameters allow the function block to be adapted to a wide range of control tasks. Thus, in the ETS, for example, settings are possible for the twilight level (incl. external presetting and Teach) and for time delays (evaluation delay at the beginning and transmission delay at the end of a detection). A disabling function allows demand-oriented disabling of the function block. In addition, manual operation of the controlled KNX actuator and thus, deactivation of the PIR automatic is possible any time. In brightness-independent operation, the function block can - depending on the configured operating mode - determine the time period after a last motion and transmit it to the KNX via a communication object. The transmission of the determined time takes place in the data format "minutes". This function, for example, allows simple monitoring of people's movements in assisted living or in a senior citizens' residence.

Local control

In running device operation, the local operation can be used to switch over the operating mode (OFF / AUTO / ON) of the function block and thus influence the state of the corresponding output directly. This means that, for example, it is possible when activating lighting to deactivate automatic motion and thus permanently switch the light on or off as required.

Operating mode

In the case of the application "Detector" or "Detector with switch-off brightness", an operating mode can be configured in the ETS. The operating mode specifies the function of the motion detection and defines whether or not the beginning and the end of a motion detection is identified automatically. Thus, the operating mode can be configured to "Fully automatic" (Automatic ON, Automatic OFF), to "Semi-automatic I" (Manual ON, Automatic OFF) or "Semi-automatic II" (Automatic ON, Manual OFF). This makes it possible to adjust the motion detection to many applications in private and public areas (e.g. toilet lighting, service lighting, control of ventilation systems).

Application type

The device can be used as single device, main unit or extension in the applications "Detector" or "Detector with switch-off brightness". It is possible to use several devices in a room to extend the detection area by combining a device configured as a main unit with several devices configured as an extension.

Walking test and status LED

The device has a walking test function. The walking test function serves as a guide during the project design and setting of the PIR detection area. The walking test indicates the reaction of the device when detecting motions by means of a blue status LED that is clearly visible behind the sensor window. The walking test can be active immediately after the ETS commissioning. Optionally, the status LED can signal any detected motions even during normal operation.

Installation

The device is attached to a bus coupler 3 (see accessories). Only the combination of this bus coupling unit and the cover results in a functional unit. Plugging the device onto a bus coupling unit 1 or 2 (older generation) is not intended, and as a result the device combination will not function.

2 Installation, electrical connection and operation

2.1 Safety instructions



Electrical devices may only be mounted and connected by electrically skilled persons.

Serious injuries, fire or property damage possible. Please read and follow manual fully.

Do not open device or operate it beyond the technical specification.

Do not press on the sensor window. Device can be damaged.

The device is not suitable for use as a burglar alarm or other alarm.

Caution. Damage to sensors may result due to high thermal radiation. Avoid direct sunlight penetration in the sensor window.

2.2 Device components

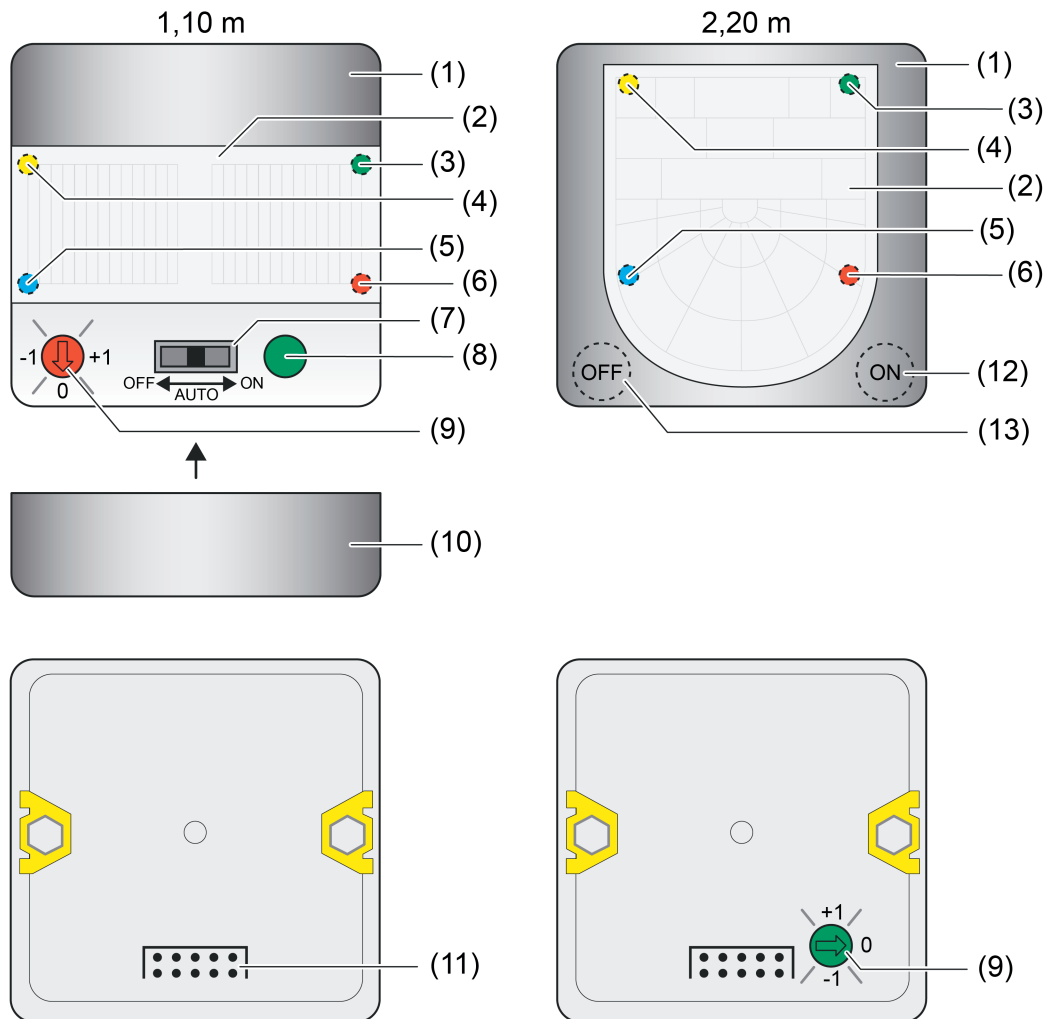

Figure 1: Device components
Top: Front side / Bottom: Rear side

- (1) Design housing
- (2) PIR sensor window with brightness sensor
- (3) LED (green) - Display of "ON" operating mode
- (4) LED (yellow) - Display of "OFF" operating mode
- (5) LED (blue) - Display of "Motion detected" or "Application not loaded"
- (6) LED (red) - Display of "Programming mode"
- (7) Slide switch for local operation (setting of the operating mode)
- (8) Programming button
- (9) Sensitivity adjuster
- (10) Design cover for the slide switch (operating element)
- (11) Pin bar for connection of bus coupler 3 (see accessories)
- (12) "ON" button for operating mode switchover
- (13) "OFF" button for operating mode switchover

2.3 Fitting and electrical connection



DANGER!

Mortal danger of electric shock.

Cover up live parts in the installation environment.

Detection field and range for 1.10 m device variant

The size of the detection area depends on the direction of motion and the adjusted sensitivity. As the distance to the detector increases, the detection density and sensitivity decrease.

4: High sensitivity (parameter/potentiometer "Sensitivity= Level 4")

1: High sensitivity (parameter/potentiometer "Sensitivity= Level 1")

- i** The specifications on the extent of the detection area are general guide values. Discrepancies can occur depending on the installation environment and the intensity of the heat motion.
- i** The basic sensitivity can be reduced in order to minimize faulty switching outdoors (e.g. from wind).

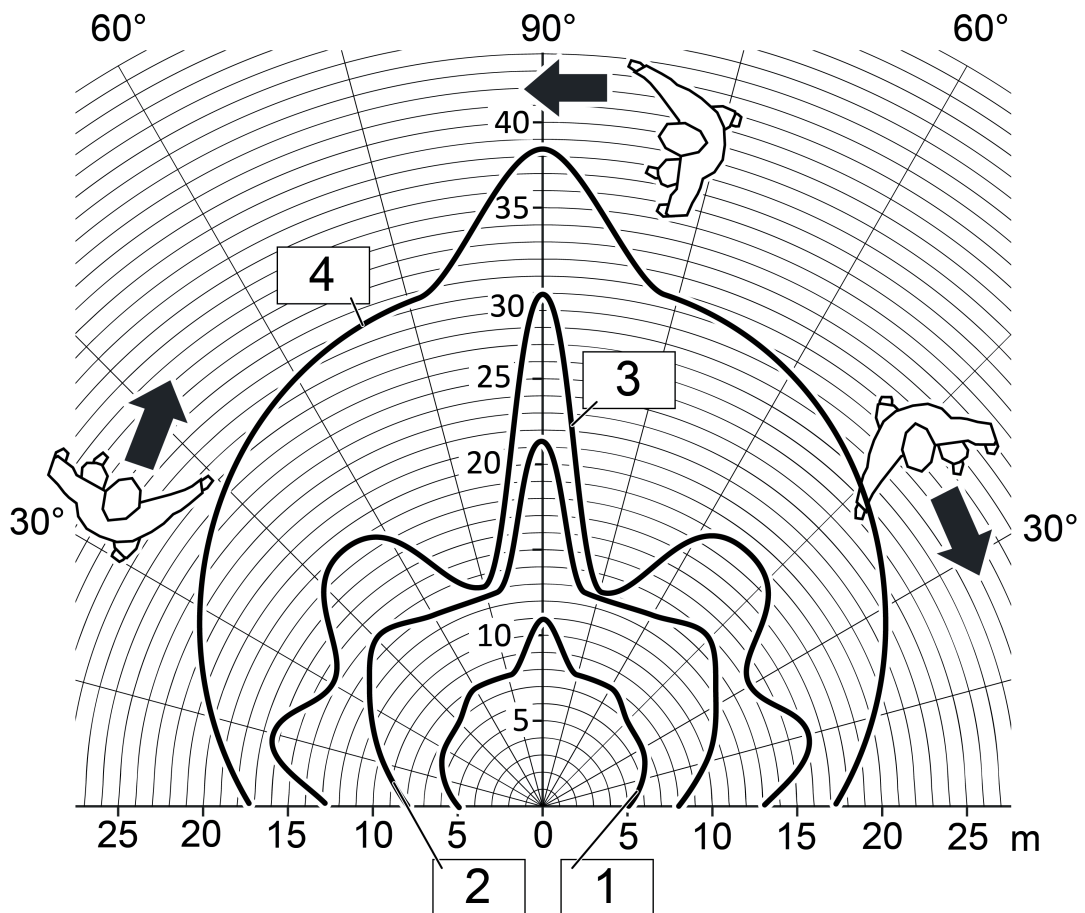

Figure 2: Range with tangential direction of motion

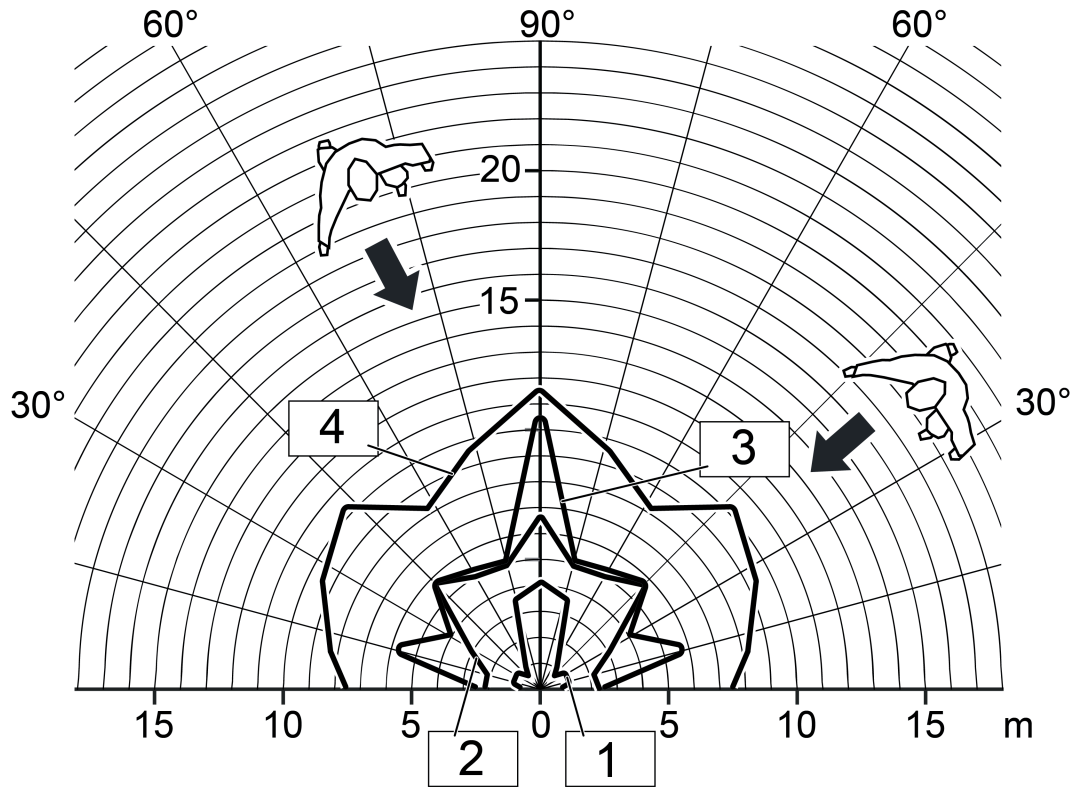

Figure 3: Range with radial direction of motion

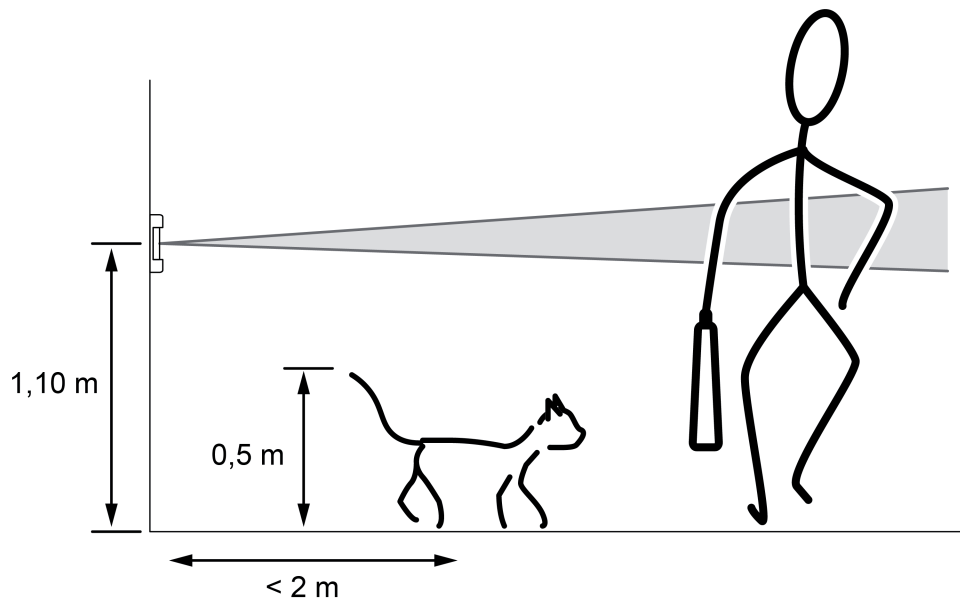

Figure 4: Detection field and mounting height

Detection field and range for 2.20 m device variant

The size of the detection area depends on the direction of motion and the adjusted sensitivity. As the distance to the detector increases, the detection density and sensitivity decrease.

4: High sensitivity (parameter/potentiometer "Sensitivity= Level 4")

1: High sensitivity (parameter/potentiometer "Sensitivity= Level 1")

The 2.20 m variant of the device has been optimised for installation heights at 2.20 m.

Optionally, the device can also be mounted at a height of 1.10 m. Depending on the installation height, there are different ranges in motion detection.

- i** The specifications on the extent of the detection area are general guide values. Discrepancies can occur depending on the installation environment and the intensity of the heat motion.
- i** The basic sensitivity can be reduced in order to minimize faulty switching outdoors (e.g. from wind).

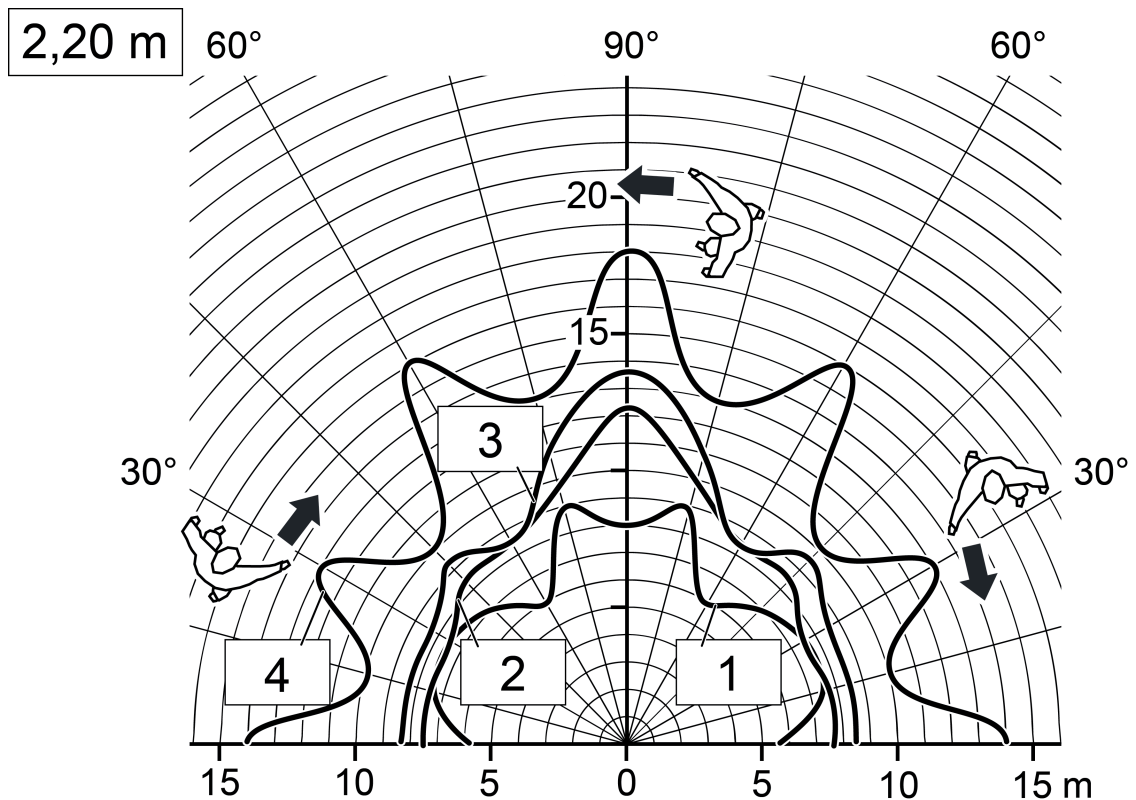

Figure 5: Range with tangential direction of motion, mounting height 2.20 m

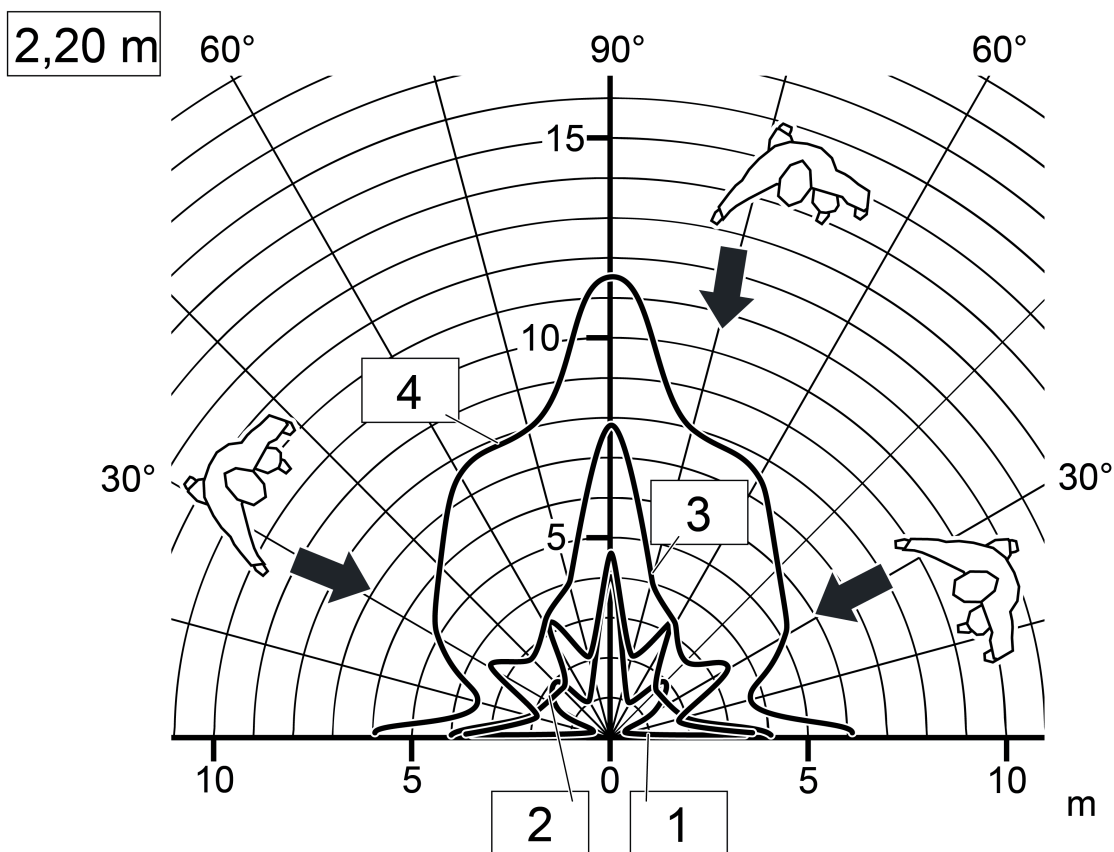

Figure 6: Range with radial direction of motion, mounting height 2.20 m

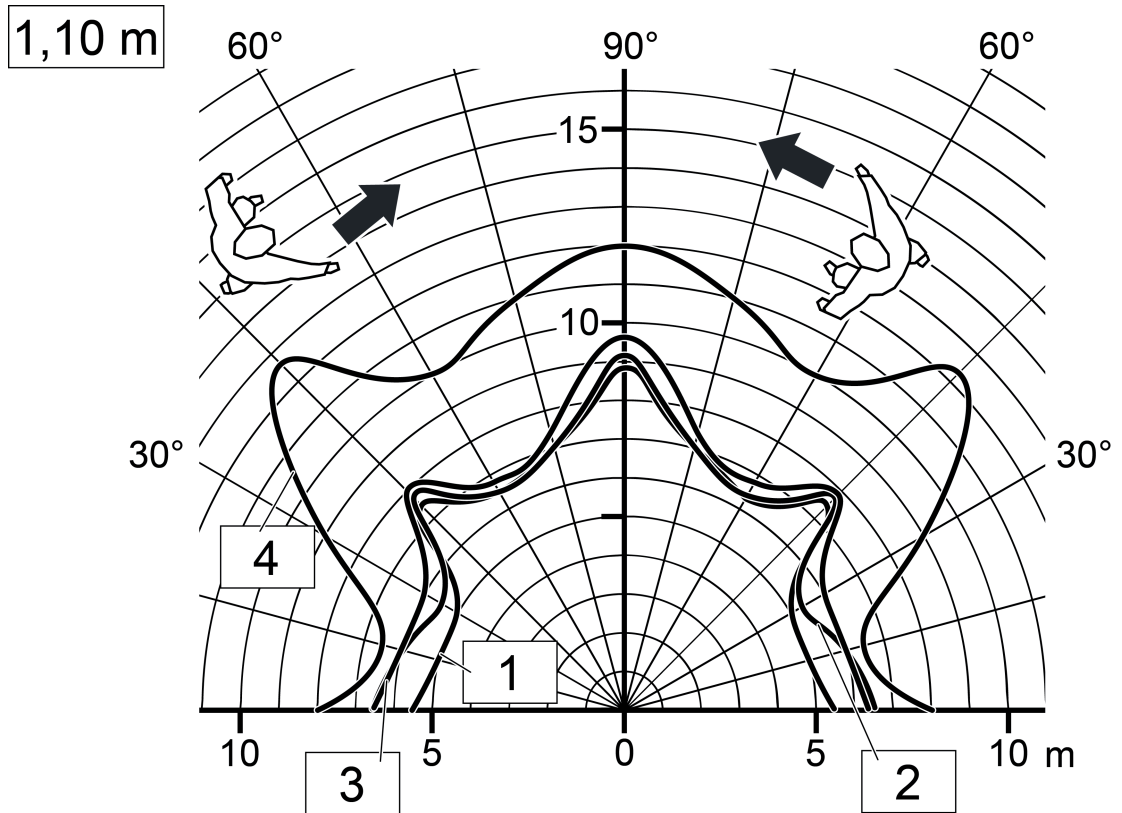

Figure 7: Range with tangential direction of motion, mounting height 1.10 m

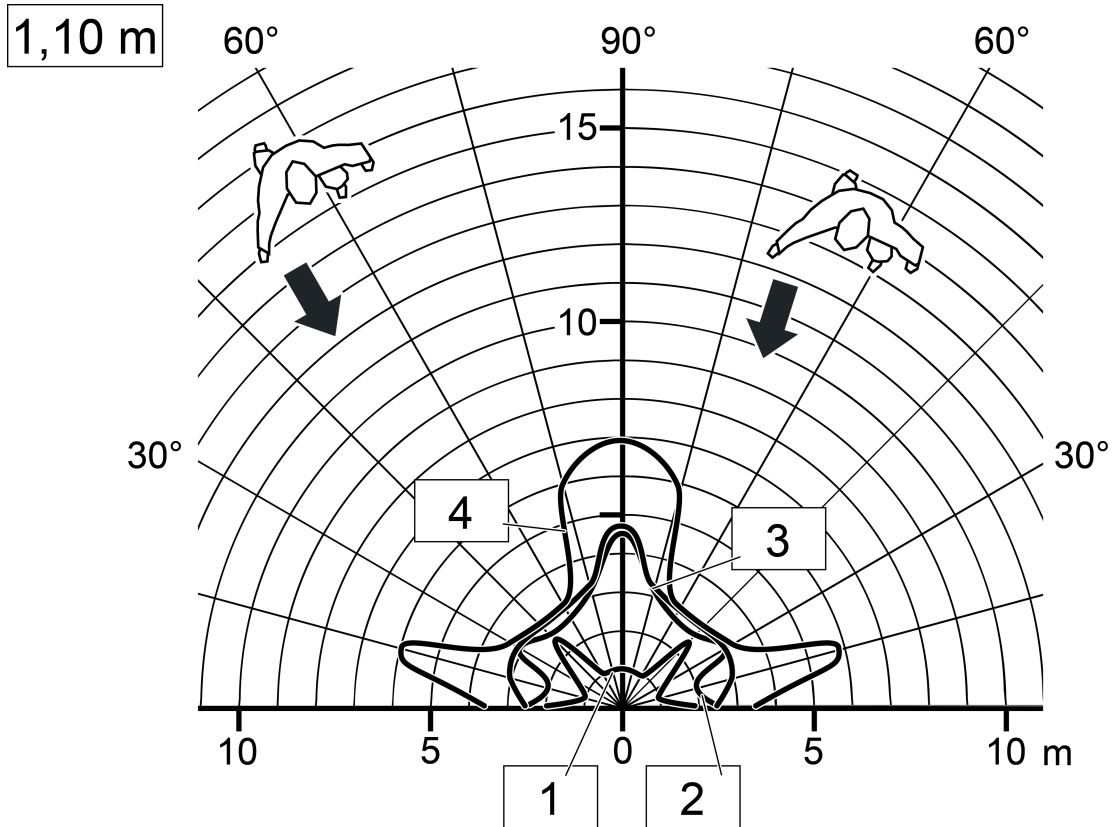

Figure 8: Range with radial direction of motion, mounting height 1.10 m

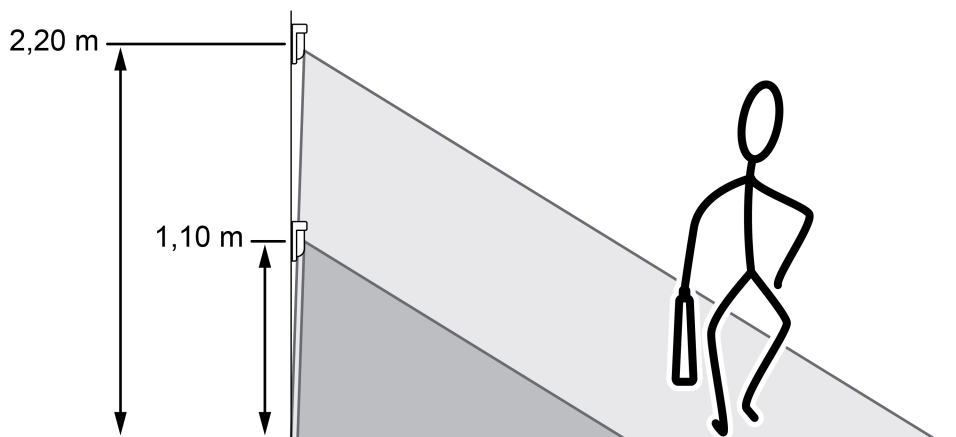

Figure 9: Detection field and mounting height

Selecting installation location

- Select a vibration-free installation location. Vibrations can lead to unwanted switching.
 - Avoid interference sources in the detection area. Interference sources, e.g. heaters, ventilation, air conditioners, and cooling light bulbs can lead to unwanted detections.
- i** To avoid unfavourably influencing the brightness measurement, care must already be taken when mounting the device to ensure that no direct light (sunlight, artificial light) falls onto the lens. Strong reflections can also influence the brightness measurement if they fall directly onto the device lens.

Arrangement of the PIR sectors

The motion detection of the device takes place digitally via 2 PIR sectors with a total detection area of 180°. The PIR sectors A and B are, depending on the device variant, permanently assigned to the lens areas on the left and right.

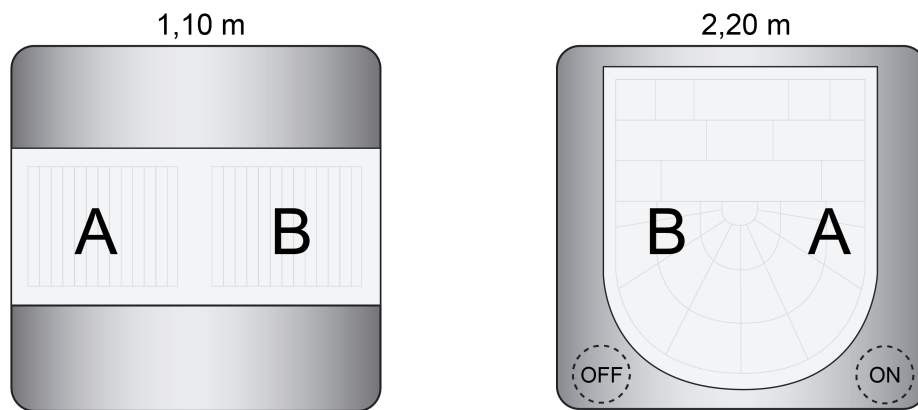

Figure 10: Arrangement of the PIR sectors

Limiting the detection area

The detection area of motion detection can be limited as required. This is possible with the 1.10 m device variant, on the one hand through mounting a panel and, on the other, by switching off a PIR sector in the ETS. With the 2.20 m device variant, the limitation of the detection area is only possible by switching off a PIR sector.

Limitation of the detection area by mounting a panel (only 1.10 m device variant):

The detection angle can be limited to approx. 90° by mounting the supplied panel. Mounting is possible in the left or right subwindow of the sensor range. This immediately deactivates the left or right detection area for motion detection (figure 11).

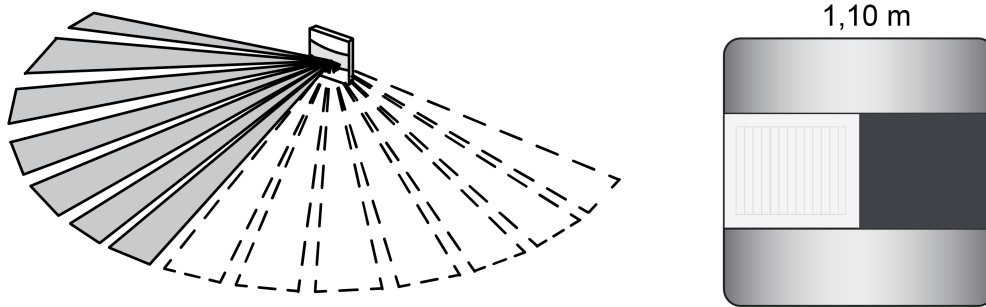

Figure 11: Example of mounted panel in the right sub-area of the sensor window

CD..., LS... ranges:

- Carefully remove the cover from the slide switch.
- Use a screwdriver to remove the design cover of the device carefully (figure 12).
- Mount the cover for the left or right side of the device (figure 13).

A ranges:

- Directly mount the cover from the front on the left or right side of the device (figure 13).

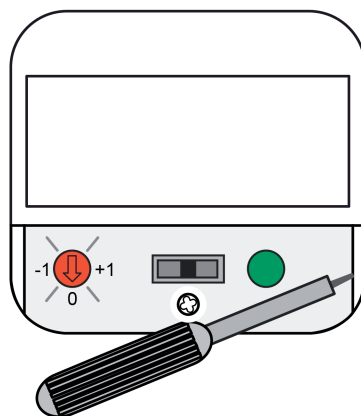

Figure 12: Dismounting of design cover of the device

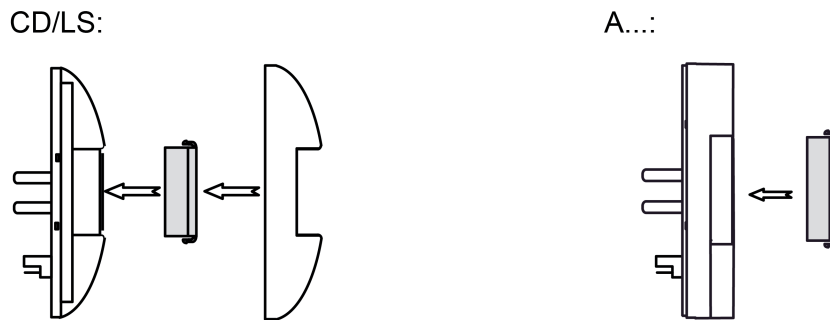

Figure 13: Mounting of panel for CD/LS and A programs to limit the detection range

Limitation of the detection area by switching off a PIR sector
(1.10 m and 2.20 m device variants):

The detection angle can be limited to approx. 100° by switching off a PIR sector.

- Deactivate the PIR sector A or B in the ETS. To do this, set the parameter "Sensitivity of PIR Sector A" or "Sensitivity of PIR Sector B" on the parameter page "Motion and light sensor" to "Sector switched-off".

i Note that the assignment of the PIR sectors A and B differs on the 1.10 m and 2.20 m device variants (see page 14).

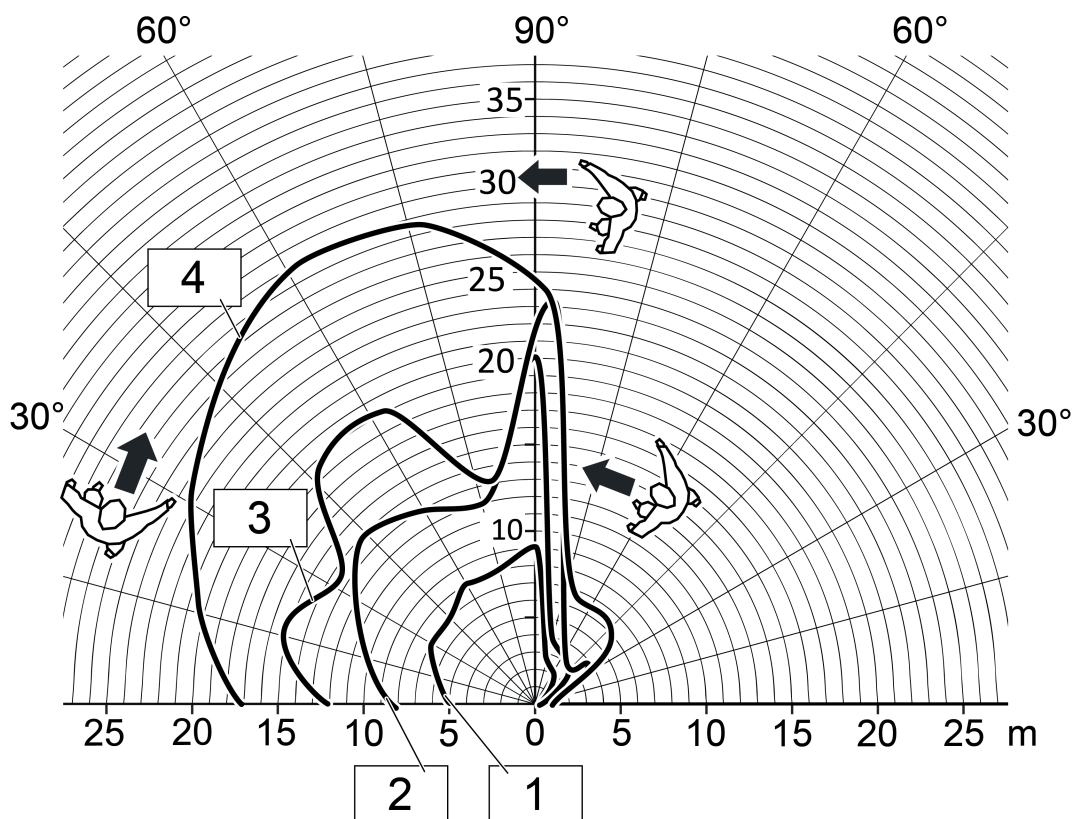

Figure 14: Range with tangential direction of motion, device variant 1.10 m, only one sensor active

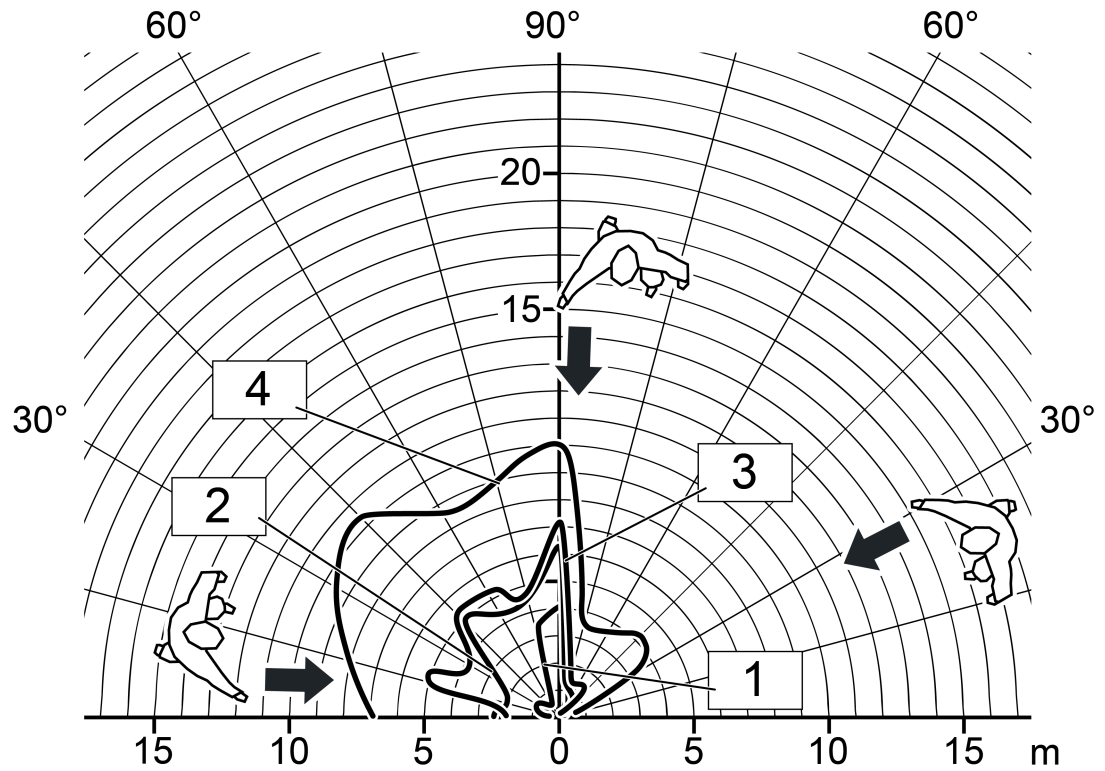

Figure 15: Range with radial direction of motion, device variant 1.10 m, only one sensor active

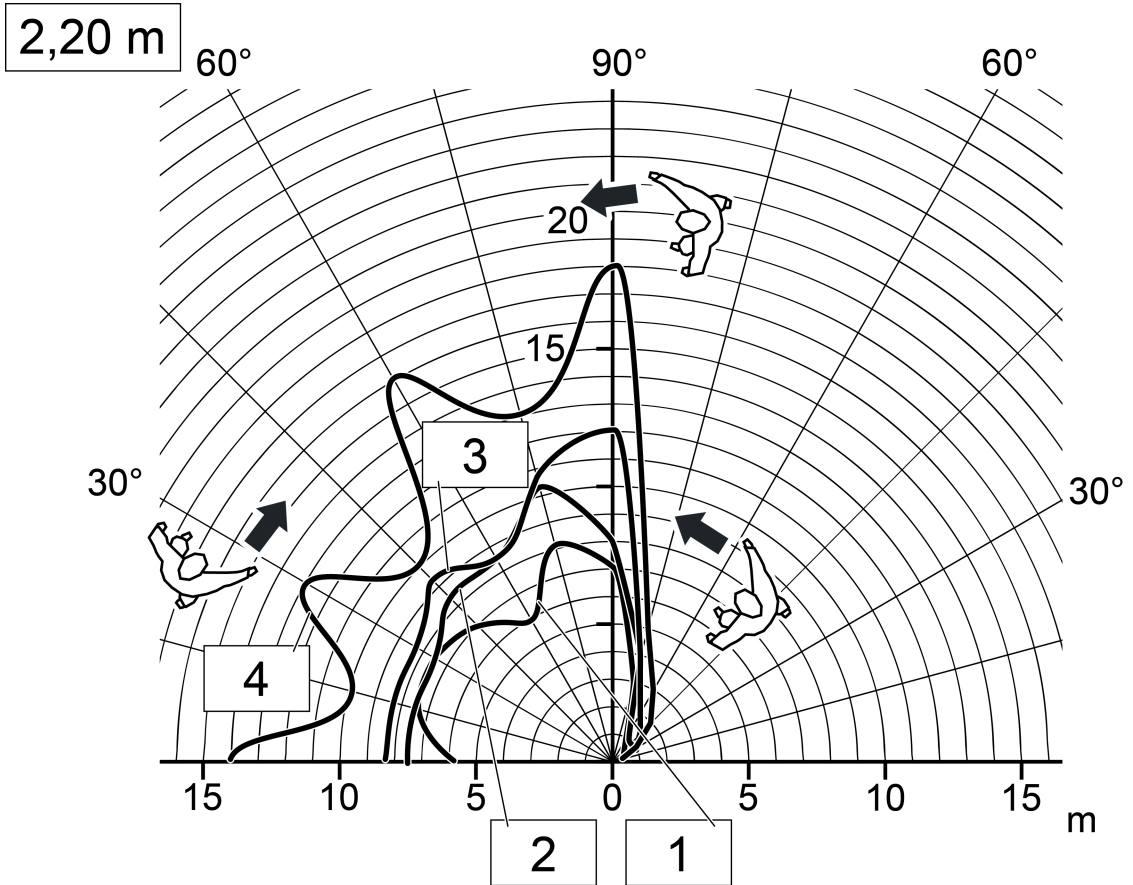

Figure 16: Range with tangential direction of motion, device variant 2.20 m, mounting height 2.20 m, only one sensor active

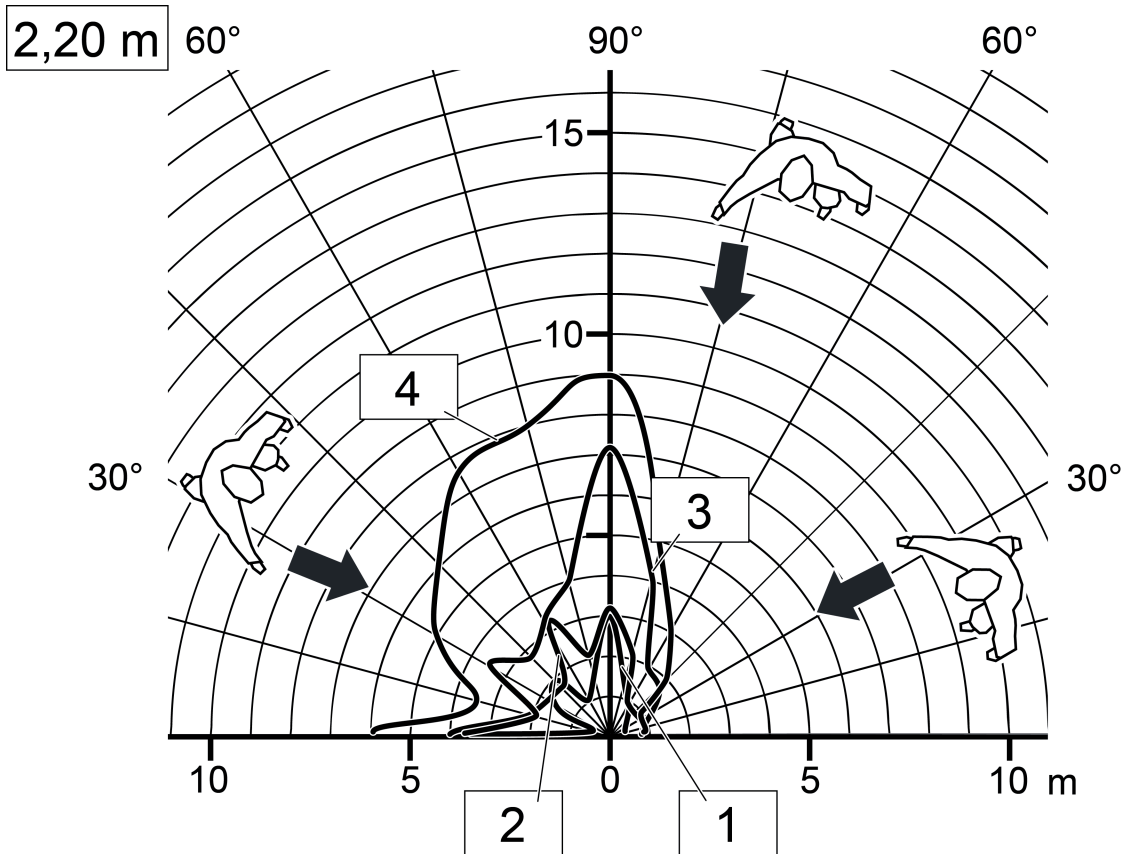

Figure 17: Range with radial direction of motion, device variant 2.20 m, mounting height 2.20 m, only one sensor active

Fitting the device

The device is attached to a bus coupler 3 (see accessories). Only the combination of this bus coupling unit and the cover results in a functional unit.

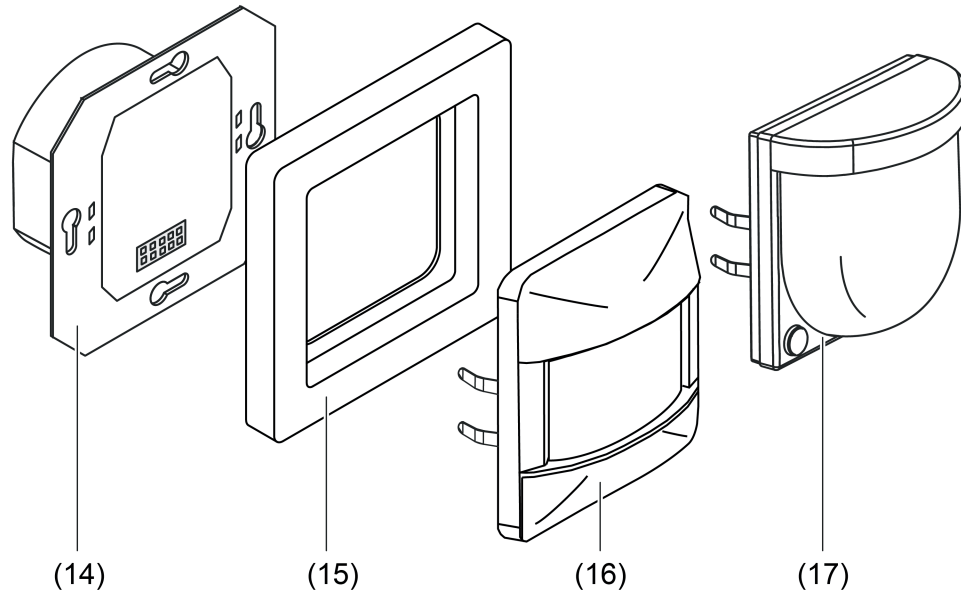

Figure 18: Mounting

- (14) Bus coupler 3
- (15) Design frame
- (16) Cover (variant 1.10 m)
- (17) Cover (variant 2.20 m)

Prerequisite: Bus coupler (14) is mounted in an air-tight appliance box and connected.

- Mount the device (16) or (17) with the design frame (15) in the right position on the bus coupler.
- i** Plugging the device onto a bus coupling unit 1 or 2 (older generation) is not intended, and as a result the device combination will not function.
- i** Only with device variant 2.20 m: Further installation steps are necessary to ensure the degree of protection IP 44 (see Seal set instructions).

Locking the slide switch (only for 1.10 m device variant)

The slide switch can be mechanically locked to the AUTO position as required. Use the provided locking screw for this.

- Carefully remove the design cover (10) from the slide switch (7).
- Move slide switch to AUTO position.
- Screw the locking screw (9) in the hole (18) of the slide switch.
- Carefully reattach the design cover.

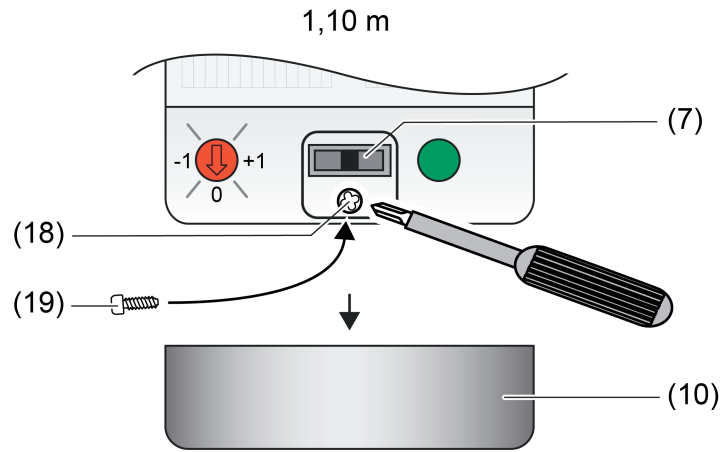

Figure 19: Locking screw

2.4 Commissioning

Programming the physical address and application program

Project design and commissioning of the device using ETS4 (from Version 4.2) or ETS5.

The device must have been connected and ready for use.

An appropriate device must be created and configured in the ETS project.

- Switch on the bus voltage.
- With the 1.10 m device variant: Carefully remove the design cover for the slide switch (10). Press the programming button (8).
With the 2.20 m device variant: Press the ON / AUTO button (12) for approx. 5 seconds.
The red programming LED in the sensor window lights up. The device displays the programming status in this way.
- Program the physical address with the help of the ETS.
The programming LED goes out.
- Load the application program into the device using the ETS.
- Write the physical address on the device or bus coupler label.
- With the 1.10 m device variant: Attach the design cover for the slide switch (10).

i An active programming mode can be deactivated by pressing the programming button (on the 1.10 m device variant) or by pressing the ON or OFF buttons (on the 2.20 m device variant).

Testing the detection area

The device must be mounted and connected and the physical address and application program must be loaded.

i In the case of main unit and extension arrangements, check the detection areas of the devices individually one after the other.

The detection area can be checked with the help of the walking test. The walking test can be activated by the ETS configuration as follows...

- Set the parameter "Walking test after ETS programming" to "activated". Afterwards, load the application program into the device with the aid of the ETS.
After programming, the walking test is activated immediately. The device then works independently of the brightness and signals detected motions via the blue status LED. All PIR sectors are active according to their preset sensitivity.
- Pace off the detection area, paying attention to reliable detection and interference sources.
- Limit detection area if necessary using the push-on cover. Adjust sensitivity with adjuster or change the ETS parameter setting.
- After a successful test, set the parameter "Walking test after ETS programming" to "deactivated". Afterwards, reload the application program into the device with the aid of the ETS.

The walking test is deactivated. The device works according to the configuration.

2.5 Operation

Operating elements on the device

The device possesses local operating elements for setting the operating mode, the sensitivity and activation of the programming mode. With the 1.10 m device variant, the potentiometer for setting the sensitivity and the programming button are accessible when the design cover for the slide switch is removed.

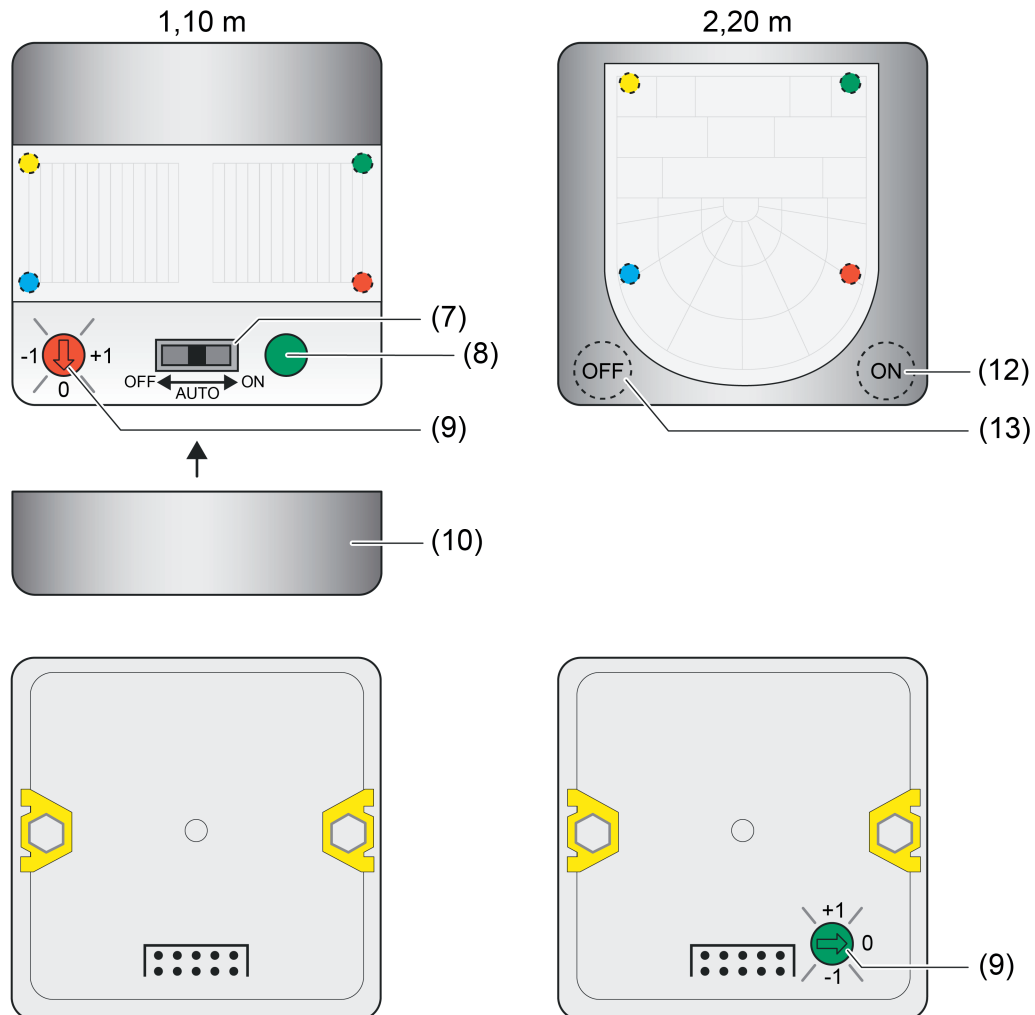

Figure 20: Operating elements on the device

- (7) Slide switch for local operation (setting of the operating mode and activation of the programming mode (see page 22))
- (8) Programming button (red)
- (9) Sensitivity adjuster
- (10) Design cover for the slide switch (operating element)
- (12) "ON" button for operating mode switchover and to activate the programming mode (see page 22)
- (13) "OFF" button for operating mode switchover

The sensitivity of the motion detection, which is a gauge for the range of the PIR evaluation, can be configured separately in the ETS for the both PIR sectors and can also be adjusted directly

on the device after commissioning. For this purpose, the device has the adjuster (9) that makes it possible to change the configured sensitivity setting of all PIR sectors. The sensitivity can be reduced or increased by a maximum of one level using the adjuster (figure 21).

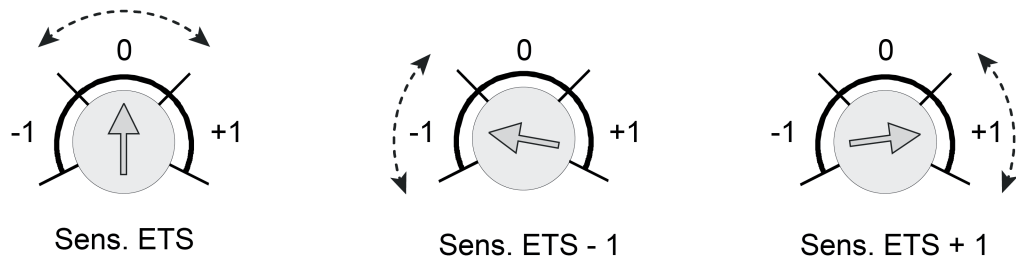

Figure 21: Example of the adjustment ranges of the sensitivity adjuster on the device

It is only possible to adjust the configured sensitivity setting on the device within a range of Level 1 to Level 4 using the adjuster. If the sensitivity of a PIR sector in the ETS has already been adjusted to a limiting value (Level 1 or Level 4), this setting can no longer be adjusted beyond the limiting values. A PIR sector that has been deactivated in the ETS cannot be activated by increasing the sensitivity using the adjuster. Likewise, a deactivation (Level 1 -> sensor deactivated) using the adjuster is not possible.

The sensitivity adjustment of the PIR sectors is applied immediately when the position of the adjuster is changed to another area.

- i The adjuster can be deactivated in the ETS. In this case, an adjustment has no effect.
- i The set sensitivity on the device can be changed at any time by new ETS programming. In the course of this, the device no longer takes the position of the adjuster into account until a new adjustment is made. As a result, the position of the adjuster gives no indication of the actual effective sensitivity.
When presetting the sensitivity, the last action carried out (ETS programming, adjuster on the device) is always relevant.

3 Technical data

General

Protection class	III
Test mark	KNX/EIB
Ambient temperature	
Art. No. ..3181..	-5 ... +45 °C
Art. No. ..3281..	-25 ... +55 °C
Storage/transport temperature	-25 ... +70 °C
Relative humidity	10 ... 100 % (No moisture condensation)

KNX supply

KNX medium	TP
Commissioning mode	S-mode
Current consumption KNX	3 ... 10 mA

Motion detection (device variant 1.10 m)

Installation height	1.10 m
Detection angle (horizontal)	180 °
Detection angle (vertical)	6 °
Detection field	
Tangential movements	approx. 10 x 10 m
Radial movememtns	approx. 9 x 9 m

Motion detection (device variant 2.20 m)

Installation height	1.10 m / 2.20 m
Detection angle	180 °
Detection field	
Tangential movements (mounting at 2.20 m)	approx. 12 x 12 m
Radial movements (mounting at 2.20 m)	approx. 8 x 8 m
Tangential movements (mounting at 1.10 m)	approx. 6 x 6 m
Radial movements (mounting at 1.10 m)	approx. 4 x 4 m

Brightness sensor

Measuring range	approx. 1 ... 1000 lx
Accuracy (1...10 lx)	± 30 %
Accuracy (> 10 lx)	± 20 %
Resolution	1.0 lx

4 Software description

4.1 Software specification

ETS search paths: Phys. sensors / Movement detector / Standard automatic switch
 1.1 m
 Phys. sensors / Movement detector / Standard automatic switch
 2.2 m

PEI connector: Only compatible with bus coupler 3 (from Version "V01")

No.	Short description	Name	Version	from mask version
1	Multifunctional detector application (first series): A function block for motion evaluations.	PIR Standard A03312	1.2 for ETS4 Version 4.2 onwards and ETS5	705

4.2 Software "PIR A0331x"

4.2.1 Scope of functions

- Depending on the configuration, the device is operated for detecting motion (as a detector) and room surveillance (alert operation).
- Optional: Continuous evaluation of the brightness during active motion detection in detection operation. As a result, lighting can be switched off when a defined brightness threshold is exceeded e.g. by incoming daylight.
- Configurable number of motion impulses within a monitoring time in alert operation. A motion is only identified, when the device has detected the set number of motion impulses. This application is appropriate when the device is to be used as a detector for KNX signalling systems.
- The motion detection takes place digitally via 2 PIR sectors with a total detection area of 180°.
- Sensitivity of the motion detection can be configured separately for the PIR sectors in levels. User-guided adjustment of the sensitivity using an adjuster directly on the device. Optional reduction of basic sensitivity for reducing unwanted motion detections in extensive installation environments (large detection radius).
- Integrated brightness sensor for determining the ambient brightness. To minimise deviations of the determined brightness at the lens to the room brightness, the brightness measurement can be calibrated individually using the user calibration.
- The function block is fully configurable to the application "Detector", "Detector with switch-off brightness" or "Alert operation".
- Up to two output communication objects are available for the function block, which transmit the switching and control commands to the KNX. Depending on the configured function (switching, staircase function, dimming value transmitter, scene extension, temperature value transmitter, brightness value transmitter, operating mode switchover, switching with forced position), the data format of these objects is defined separately and adapted to the controllable function units of the KNX system.
- Adaptation of a function block to a wide range of control tasks by means of extensive parameters. Thus, in the ETS, for example, settings are possible for the twilight level (incl. external presetting and Teach) and for time delays (evaluation delay at the beginning and transmission delay at the end of a detection).
- Switchover of the operating mode (OFF / AUTO / ON) through local operation during running operation of the device. This means that, for example, it is possible when activating lighting to deactivate automatic motion and thus permanently switch the light on or off as required.
- Demand-orientated disabling via the KNX.
- Manual operation of the controlled KNX actuator and thus deactivation of the PIR automatic is possible.
- The function block in brightness-independent operation can determine the time period after a last motion and transmit to the KNX via a communication object. This function, for example, allows simple monitoring of people's movements in assisted living or in a senior citizens' residence.
- Operating mode settable for the application "Detector" or "Detector with switch-off brightness". The operating mode specifies the function of the motion detection and defines whether the beginning and the end of a motion detection is identified automatically. Thus, the operating mode can be configured to "Fully automatic" (Automatic ON, Automatic OFF), to "Semi-automatic I" (Manual ON, Automatic OFF) or "Semi-automatic II" (Automatic ON, Manual OFF).
- The device can be used as single device, main unit or extension in the applications "Detector" or "Detector with switch-off brightness". It is possible to use several devices in a room to extend the detection area by combining a device configured as a main unit with several devices configured as an extension.
- Walking test function serves as a guide during the project design and setting of the detection area. The walking test indicates the reaction of the device when detecting motions by means of a blue status LED that is clearly visible behind the sensor window. Optionally, the status LED can signal any detected motions even during normal operation.

4.2.2 Notes on software

ETS project design and commissioning

For project design and commissioning of the device, ETS4 from Version 4.2 onwards or ETS5 is required. We recommend using ETS5.

No product database is available for ETS2 and ETS3.

Unloading the application program and non-executable application

After the application program has been unloaded by the ETS, the blue status flashes slowly (approx. 0.75 Hz). In this case, the device does not react anymore to motions or bus telegrams. Local operation also has no effect. The delivery state described cannot be restored by unloading with the ETS.

The device also indicates by slow flashing of the blue status LED that a wrong application has been programmed into its memory using the ETS. Applications are non-executable even if they are intended for use in the ETS product database but must not be combined with the selected device hardware. In this case, too, the device is without function.

It should generally be ensured that the device hardware used matches the ETS configured device.

4.2.3 Object table

4.2.3.1 Objects for the sensor





Function:	Motion detection				
Object	Function	Name	Type	DPT	Flag
 ⁰	Interlock PIR sensor	Motion detection - Input	1-bit	1,001	C, W, -, -
Description	1-bit object with which the PIR sensor can be locked after an active motion detection operation (lighting OFF) so that the device does not identify any motion due to the cooling light bulb. The telegram polarity and lockout time are configurable. An ongoing lockout time is restarted upon receiving a new telegram for the lockout.				

Function:	Brightness sensor				
Object	Function	Name	Type	DPT	Flag
 ¹	Measured brightness value	Brightness sensor - Output	2 bytes	9,004	C, -, T, R
Description	2-byte object that can transmit the brightness value of the room determined by the internal brightness sensor of the device to the bus. The device can transmit the brightness value actively and/or cyclically for a configured brightness change. It is also possible to only provide the brightness value passively and to transmit this on request (parameter-dependent).				

Function:	Brightness sensor				
Object	Function	Name	Type	DPT	Flag
 ²	Sensor calibration	Brightness sensor - Input	2 bytes	9,004	C, W, -, -
Description	2-byte object that can supply an external brightness reference value to the device during the sensor calibration. During calibration, the device assigns the measured value specified via this object to the current, measured brightness value (brightness on the light guide) whereby the measured value curve is adapted in the device.				

4.2.3.2 Objects for function blocks 1...5

Objects for output functions

Function:	Function block				
Object	Function	Name	Type	DPT	Flag
 ³	Switching	FB1 - Output 1	1-bit	1.001	C, -, T, -
Description	1-bit object via which the first output of the function block outputs the switching commands to the KNX actuator (e.g. switch actuator) at the start or end of a detection. The telegram polarity can be configured. This object is only visible if the function of the output is configured to "switching".				
Function:	Function block				
Object	Function	Name	Type	DPT	Flag
 ³	Switching staircase	FB1 - Output 1	1-bit	1.010	C, -, T, -
Description	1-bit object via which the first output of the function block outputs the switching commands to the KNX actuator (e.g. switch actuator) at the start or end of a detection. The run-on-time elapses in the actuator. The telegram polarity is thus defined ("1" at the beginning of a detection, "0" at the end of a detection). This object is only visible if the function of the output is configured to "Staircase function".				
Function:	Function block				
Object	Function	Name	Type	DPT	Flag
 ³	Forced position	FB1 - Output 1	2-bit	2.001	C, -, T, -
Description	2-bit object via which the first output of the function block outputs the priority control commands with high priority to the KNX actuator (e.g. switch actuator) at the start or end of a detection. The telegram polarity can be configured. This object is only visible if the function of the output is configured to "switching with priority control".				
Function:	Function block				
Object	Function	Name	Type	DPT	Flag
 ³	Dimming value	FB1 - Output 1	1 bytes	5.001	C, -, T, -
Description	1-byte object via which the first output of the function block outputs the dimming commands to the KNX actuator (e.g. dimming actuator) at the start or end of a detection. The dimming values are configurable. This object is only visible if the function of the output is configured to "dimming value transmitter".				

Function:	Function block				
Object	Function	Name	Type	DPT	Flag
 ³	Scene extension	FB1 - Output 1	1 bytes	18.001	C, -, T, -
Description	1-byte object via which the first output of the function block outputs a scene number to the KNX actuator (e.g. dimming actuator) at the start or end of a detection for the purpose of a scene recall. The scene number can be configured. This object is only visible if the function of the output is configured to "light scene extension".				

Function:	Function block				
Object	Function	Name	Type	DPT	Flag
 ³	Temperature value	FB1 - Output 1	2 bytes	9.001	C, -, T, -
Description	2-byte object via which the first output of the function block outputs preconfigured temperature values to a KNX actuator or sensor (e.g. room temperature controller) at the start or end of a detection. The temperature values can be configured. This object is only visible if the function of the output is configured to "temperature value transmitter".				

Function:	Function block				
Object	Function	Name	Type	DPT	Flag
 ³	Brightness value	FB1 - Output 1	2 bytes	9.004	C, -, T, -
Description	2-byte object via which the first output of the function block outputs preconfigured brightness values to a KNX actuator or sensor (e.g. external constant light controller) at the start or end of a detection. The brightness values can be configured. This object is only visible if the function of the output is configured to "brightness value transmitter".				

Function:	Function block				
Object	Function	Name	Type	DPT	Flag
 ³	Operating mode	FB1 - Output 1	1 bytes	20.102	C, -, T, -
Description	1-byte object via which the first output of the function block outputs a command for the operating mode switchover to the KNX actuator or sensor (e.g. room temperature controller) at the start or end of a detection. The operating mode can be configured. This object is only visible if the function of the output is configured to "operating mode room temperature controller".				

 Function: Function block

Object	Function	Name	Type	DPT	Flag
 4	Switching	FB1 - Output 2	1-bit	1.001	C, -, T, -

Description 1-bit object via which the second output of the function block outputs the switching commands to the KNX actuator (e.g. switch actuator) at the start or end of a detection. The telegram polarity can be configured.
This object is only visible if the function of the output is configured to "switching".

 Function: Function block

Object	Function	Name	Type	DPT	Flag
 4	Switching staircase	FB1 - Output 2	1-bit	1.010	C, -, T, -

Description 1-bit object via which the second output of the function block outputs the switching commands to the KNX actuator (e.g. switch actuator) at the start or end of a detection. The run-on-time elapses in the actuator. The telegram polarity is thus defined ("1" at the beginning of a detection, "0" at the end of a detection).
This object is only visible if the function of the output is configured to "Staircase function".

 Function: Function block

Object	Function	Name	Type	DPT	Flag
 4	Forced position	FB1 - Output 1	2-bit	2.001	C, -, T, -

Description 2-bit object via which the second output of the function block outputs the priority control commands with high priority to the KNX actuator (e.g. switch actuator) at the start or end of a detection. The telegram polarity can be configured.
This object is only visible if the function of the output is configured to "switching with priority control".

 Function: Function block

Object	Function	Name	Type	DPT	Flag
 4	Dimming value	FB1 - Output 2	1 bytes	5.001	C, -, T, -

Description 1-byte object via which the first output of the function block outputs the dimming commands to the KNX actuator (e.g. dimming actuator) at the start or end of a detection. The dimming values are configurable.
This object is only visible if the function of the output is configured to "dimming value transmitter".

Function:	Function block				
Object	Function	Name	Type	DPT	Flag
 4	Scene extension	FB1 - Output 2	1 bytes	18.001	C, -, T, -
Description	1-byte object via which the second output of the function block outputs a scene number to the KNX actuator (e.g. dimming actuator) at the start or end of a detection for the purpose of a scene recall. The scene number can be configured. This object is only visible if the function of the output is configured to "light scene extension".				

Function:	Function block				
Object	Function	Name	Type	DPT	Flag
 4	Temperature value	FB1 - Output 2	2 bytes	9.001	C, -, T, -
Description	2-byte object via which the second output of the function block outputs preconfigured temperature values to a KNX actuator or sensor (e.g. room temperature controller) at the start or end of a detection. The temperature values can be configured. This object is only visible if the function of the output is configured to "temperature value transmitter".				

Function:	Function block				
Object	Function	Name	Type	DPT	Flag
 4	Brightness value	FB1 - Output 2	2 bytes	9.004	C, -, T, -
Description	2-byte object via which the second output of the function block outputs preconfigured brightness values to a KNX actuator or sensor (e.g. external constant light controller) at the start or end of a detection. The brightness values can be configured. This object is only visible if the function of the output is configured to "brightness value transmitter".				

Function:	Function block				
Object	Function	Name	Type	DPT	Flag
 4	Operating mode	FB1 - Output 2	1 bytes	20.102	C, -, T, -
Description	1-byte object via which the second output of the function block outputs a command for the operating mode switchover to the KNX actuator or sensor (e.g. room temperature controller) at the start or end of a detection. The operating mode can be configured. This object is only visible if the function of the output is configured to "operating mode room temperature controller".				

Objects for twilight level control

Function: Twilight level

Object	Function	Name	Type	DPT	Flag
 ⁵	Presetting twilight level	FB1 - Input	2 bytes	9.004	C, W, -, -

Description: 2-byte object for presetting an external twilight level value (1...1,000 Lux). The twilight level value received via the object remains unchanged until a new presetting (external twilight level or teach-in function). Even a bus voltage failure will not reset the twilight level value received via the KNX. This object is only visible if the twilight level evaluation is brightness-dependent and the external twilight level presetting is enabled.

Function: Twilight level

Object	Function	Name	Type	DPT	Flag
 ⁶	Teach twilight level	FB1 - Input	1-bit	1.001	C, W, -, -

Description: 1-bit object for triggering a Teach operation for learning a twilight level value. With the Teach function, the effective brightness value is applied instantly by transmitting a corresponding telegram to this object as a new twilight level value. The telegram polarity can be configured. This object is only visible if the twilight level evaluation is brightness-dependent and the Teach function for the twilight level presetting is enabled.

Function: Twilight level

Object	Function	Name	Type	DPT	Flag
 ⁷	Active twilight level	FB1 - Feedback output	2 bytes	9.004	C, -, (T), (R)

Description: 2-byte object for the feedback of the active twilight level value of the function block. This object can optionally act as an active signalling object or passive status object (read out object). As an active signalling object, the current twilight level brightness value is transmitted once to the KNX on each change of the twilight level, after ETS programming or after bus voltage return (optionally delayed). This object is only visible if the twilight level evaluation is brightness-dependent.

Function:	Twilight level				
Object	Function	Name	Type	DPT	Flag
 ⁸	Deactivation of twilight level	FB1 - Input / Output	1-bit	1.003	C, W, T, -
Description	<p>1-bit object for activating and deactivating the twilight level in single devices, main units and extensions. It is possible to switch the twilight level evaluation off and on again during ongoing operation of the device via this object. When using main units and extensions, the use of this object is fundamental in order to be able to switch the main units to brightness-independent operation for output functions that are unlike the 1-bit data format. Thus, a distinction must be made between the application types when projecting the object.</p> <p>Application type "single device": The object is an input. A "1" telegram deactivates the twilight level. A "0" telegram re-enables the twilight function evaluation.</p> <p>Application type "Main unit": The object is an input and output. Use as input: A "1" telegram deactivates the twilight level. A "0" telegram re-enables the twilight function evaluation. Use as output: The main unit controls the switch-over of the twilight level evaluation of the extension(s) via this output depending on its own twilight level evaluation. Combined use of the object as input and output: If the main unit is switched over to brightness-independent operation (use as input), the object does not control the twilight level evaluation of the extension(s) anymore (output function deactivated). No telegrams are then transmitted automatically anymore from the main unit until it is switched back to brightness-dependent operation! To ensure that the main unit and extension(s) function correctly during switch-over of the main unit to brightness-independent operation, the extension(s) must also be switched over simultaneously to brightness-independent operation via this object.</p> <p>Application type "extension": The object is an input. A "1" telegram deactivates the twilight level. A "0" telegram re-enables the twilight function evaluation.</p>				

Motion detector with switch-off brightness

Function:	Switch-off brightness				
Object	Function	Name	Type	DPT	Flag
 ⁹	Switch-off brightness Teach	FB1 - Input	1-bit	1.001	C, W, -, -
Description	<p>1-bit object for triggering a Teach operation for learning the switch-off brightness. With the Teach function, the effective brightness value is applied instantly by transmitting a corresponding telegram to this object as new switch-off brightness. The telegram polarity can be configured. This object is only visible if the application is configured to "Detector with switch-off brightness" and the Teach function is enabled for the switch-off brightness.</p>				

Objects for the brightness value

Function: Brightness value

Object	Function	Name	Type	DPT	Flag
 ¹⁰	External brightness sensor	FB1 - Input	2 bytes	9.004	C, W, -, -

Description: 2-byte object for receiving an external brightness value. This makes it possible to carry out the twilight level evaluation independently of the installation location of the device (e.g. provision of an external brightness value via a more favourably installed extension). This object is only visible if the brightness value of a function block is to be detected externally.

Function: Brightness value

Object	Function	Name	Type	DPT	Flag
 ¹¹	Active brightness value	FB1 - Feedback output	2 bytes	9.004	C, -, -, R

Description: 2-byte object for the passive feedback of the active brightness value of a function block.

Objects for the motion evaluation

Function: Motion evaluation

Object	Function	Name	Type	DPT	Flag
 ¹²	External motion	FB1 - Input	1-bit	1.010	C, W, -, -

Description

1-bit object for receiving an external motion signal for single devices and main units ("1" = motion present, "0" irrelevant). An external 1-bit motion detection can be supplied to the device via this object, which originates from a pushbutton in the room, for example. This allows the user to control the connected KNX actuator by means of a simulated motion signal even without a motion detection in the detection area of the device. The evaluation of the external motion signal is possible brightness-dependent or brightness-independent (configurable).

In the case of main unit and extension arrangements, the main units receive the cyclical motion telegrams of the extensions via this object (it must be linked with the objects "motion" of the extensions).

In the application type "extension", it is not possible to supply external motion detections to the device for implementing a manual operation (e.g. by means of a pushbutton). This is only possible on a main unit. In the case of extensions, the object "External motion" performs another task. In this case, the twilight level is deactivated and activated in the extensions via this object. The cyclical ON telegrams of the main unit are received. These telegrams are not evaluated as motion, however, but are used for the switch-over of the twilight level evaluation. During the receipt of the cyclical ON telegram, the twilight level evaluation is deactivated. If the ON telegrams of the main unit are absent during the run-on-time, the extensions reactivate the twilight level evaluation. The receipt of an "OFF telegram" results in the direct activation of the twilight level evaluation (brightness dependent operation) in the extensions.

Function: Motion evaluation

Object	Function	Name	Type	DPT	Flag
 ¹³	Movement	FB1 - Output	1-bit	1.010	C, -, T, -

Description

1-bit object for transmitting a motion detection to the main unit (cyclical "1" = motion present, "0" = not transmitted). This object is only available for extensions.

Object for the additional transmission delay

Function: Additional transmission delay

Object	Function	Name	Type	DPT	Flag
 ¹⁴	Factor add. transmission delay	FB1 - Input	1 bytes	5.010	C, W, -, -

Description 1-byte object, the value of which extends the configured additional transmission delay (effective additional transmission delay = received factor x configured time).
This object is only visible if the additional transmission delay is configured discreetly according to a parameter in the ETS and the time extension is enabled.

Object for manual operation

Function: Manual operation

Object	Function	Name	Type	DPT	Flag
 ¹⁵	Lighting manual ON/OFF	FB1 - Input	1-bit	1.001	C, W, -, -

Description 1-bit object for manual control (switch on / switch off) of the activated KNX actuator (e.g. lighting). A manual operation is detected by the device via this object and processed according to the configuration of the operating mode. During manual control, the automatic is deactivated ("1" = ON / reaction as at the beginning of a detection, "0" = OFF / as at the end of a detection).

Object for the disabling function

Function: Disabling function

Object	Function	Name	Type	DPT	Flag
 ¹⁶	Disabling	FB1 - Input	1-bit	1.003	C, W, -, R

Description 1-bit object for activation and deactivation of the disabling function (telegram polarity configurable).

Object for transmitting the time after the last motion

Function: Time after last motion

Object	Function	Name	Type	DPT	Flag
 ¹⁷	Time after last motion	FB1 - Input	2 bytes	7.006	C, -, T, -

Description 2-byte object containing the current counter status of the measurement of the time period after the last identified motion in the data format "minutes". This object can act as an active signalling object, or alternatively, as a passive status object. As an active signalling object, the device transmits the current counter status cyclically to the KNX. The cycle time can be configured in the ETS. During an active motion or ongoing standard delay, the counter value is always "0". If the current counter status has reached the maximum value "65,535", the device keeps this value until reset by a new motion detection of the counter.
This object is only visible in brightness-independent operation and only if the function is enabled in the ETS.

Function:	Operating mode				
Object	Function	Name	Type	DPT	Flag
 125	Operating mode	FB1 - Output	1 bytes	Non-DPT	C, -, T, R
Description	<p>1-byte object for transmitting the current operating mode (e.g. to network main devices and extensions). This object means that individual devices or main devices are able to forward the active operating mode to other bus devices. By evaluating this information, extensions are able, for example, to detect which operating mode is active in the main device and to activate LED displays.</p> <p>0 = AUTO 1 = ON 2 = OFF 3...255 = not used</p>				

Function:	Operating mode				
Object	Function	Name	Type	DPT	Flag
 126	Operating mode	FB1 - Input	1 bytes	Non-DPT	C, W, T, -
Description	<p>1-byte object for switching over the operating mode (e.g. to network main devices and extensions). This object makes it possible to specify the operating mode of individual devices or main devices immediately through a value command. This object is usually used by suitable PIR extensions to set the operating mode in a main device.</p> <p>0 = AUTO 1 = ON 2 = OFF 3...255 = no reaction</p>				

Function:	Operating mode				
Object	Function	Name	Type	DPT	Flag
 131	Local control disabling	FB1 - Input	1-bit	1.003	C, W, -, -
Description	<p>1-bit object for activation and deactivation of the disabling function for local operation of the operating mode switchover (telegram polarity configurable). This object is only visible if the disabling function is enabled.</p>				

4.2.4 Functional description

4.2.4.1 Global block diagram

The device contains various functional units that perform a variety of tasks and have various integrated and external interfaces in the form of sensors and KNX communication objects. Various control tasks can be performed in the KNX system by connection of a KNX actuator and sensor to the objects or by combination of the functional units among each other.

The device has the following functional units...

- Functional unit "Detector"
Contains a function block (FB) which can be configured to the application "Detector", "Detector with switch-off brightness" or "Alert operation".
- Functional unit "Motion and light sensor"
This unit evaluates and processes the signals of the motion and brightness sensors of the device. The prepared signals are made available to the function block and can additionally be made available to other bus devices via objects as well.
- Function unit "Operating mode switchover"
This functional unit evaluates the operating elements of local operation to switch over the operating mode (ON / AUTO / OFF) of the function block and activates the LED display of the operating modes.

The individual functional units are described in detail in the following chapters of the software description.

4.2.4.2 Motion and light sensor

4.2.4.2.1 PIR sensor

Motion detection

The motion detection of the device takes place extremely sensitively via 2 digital PIR sectors with a total detection area of 180°. The sensitivity of the motion detection, which is a gauge for the range of the PIR evaluation, can be configured separately in the ETS for the PIR sectors and can also be adjusted by using an adjuster directly on the device after commissioning. The two PIR sectors are fixedly assigned to the function block of the device.

An adjuster on the device makes it possible to change the configured sensitivity setting of all PIR sectors. The sensitivity can thereby be reduced or increased by a maximum of one level.

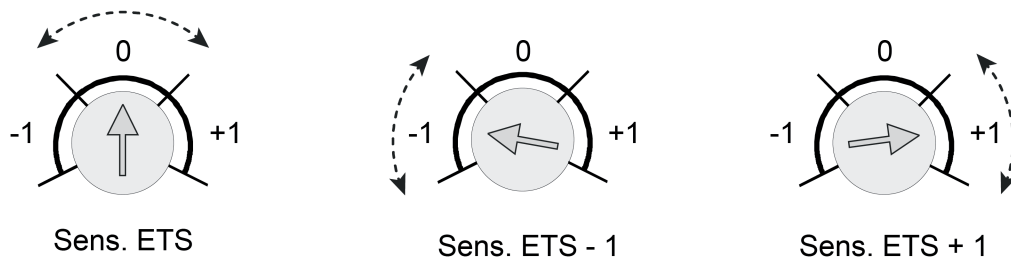

Figure 22: Example of the adjustment ranges of the sensitivity adjuster on the device

- i** The set sensitivity on the device can be changed at any time by new ETS programming. In the course of this, the device no longer takes the position of the adjuster into account until a new adjustment is made. As a result, the position of the adjuster gives no indication of the actual effective sensitivity. When presetting the sensitivity, the last action carried out (ETS programming or adjuster on the device) is always relevant.

The digital signal evaluation of all PIR sensors can also be influenced in terms of sensitivity. It is possible here to optionally reduce the basic sensitivity in order to reduce or even fully suppress unwanted motion detections in extensive installation environments (large detection radius) in parts. The signal evaluation of interfering signals in the outer detection area (e.g. air movements) can be influenced in particular - depending on their intensity - so that they no longer result in a motion detection. The detection of body heat motions or other motions in the immediate proximity of the device is not significantly affected, however, owing to a reduced basic sensitivity.

The "low" setting of the parameter "basic sensitivity of all PIR sectors" on the parameter page "Motion and light sensor" reduces the basic sensitivity globally to a dimension defined by the manufacturer. This takes place quite independently of the individual default sensitivity of the individual PIR sectors or user setting on the device. Even at low basic sensitivity, the sensitivity of individual PIR sectors can still be configured and influenced as described.

We generally recommend setting the basic sensitivity to "high". It should only be reduced if undesirable false triggers frequently occur in the long-distance range, particularly for large detection areas.

Interlock of the motion detection

When the luminaires activated by the device are in the detection field, the switching on and off of the luminaires can result in motion detection due to changing thermal radiation. To prevent this inaccuracy, the switching status of the luminaires must be guided to the 1-bit object "Interlock PIR sensor". When a corresponding status telegram is received, the motion detection is disabled for a configurable lockout time, so that no motion is detected due to the changing

thermal radiation. An ongoing lockout time is restarted upon receiving a new corresponding status telegram.

4.2.4.2.2 Brightness sensor

Brightness measurement

To determine the ambient brightness, the device possesses a brightness sensor, located behind the lens. The sensor detects the mixed light of its environment composed of artificial light and daylight. Light measurement occurs in the direction the lens is looking. The factory calibration of the device is set in such a way that the brightness is determined at the lens. A coefficient programmed at the factory enables the device to determine the effective brightness in the room. To minimise deviations of the determined brightness at the lens to the room brightness, the brightness measurement can be calibrated individually using the user calibration.

The brightness value determined by the device can be made available to the function blocks of the device (via the configuration) and also the KNX system via the 2 byte-communication object "Measured brightness value". The device can transmit the brightness value actively and/or cyclically for a configured brightness change. It is also possible to only provide the brightness value passively and to transmit this on request.

Calibration function

The measured brightness at the internal device sensor is dependent on the ambient brightness at the mounting location of the device. For this reason, the device directly derives the ambient brightness from its own brightness measured value using a calibration factor. In the as-delivered state, this factor is set to "1" (sensor measured value = ambient brightness = Ideal measurement characteristic). This already makes an adjustment to many installation environments possible.

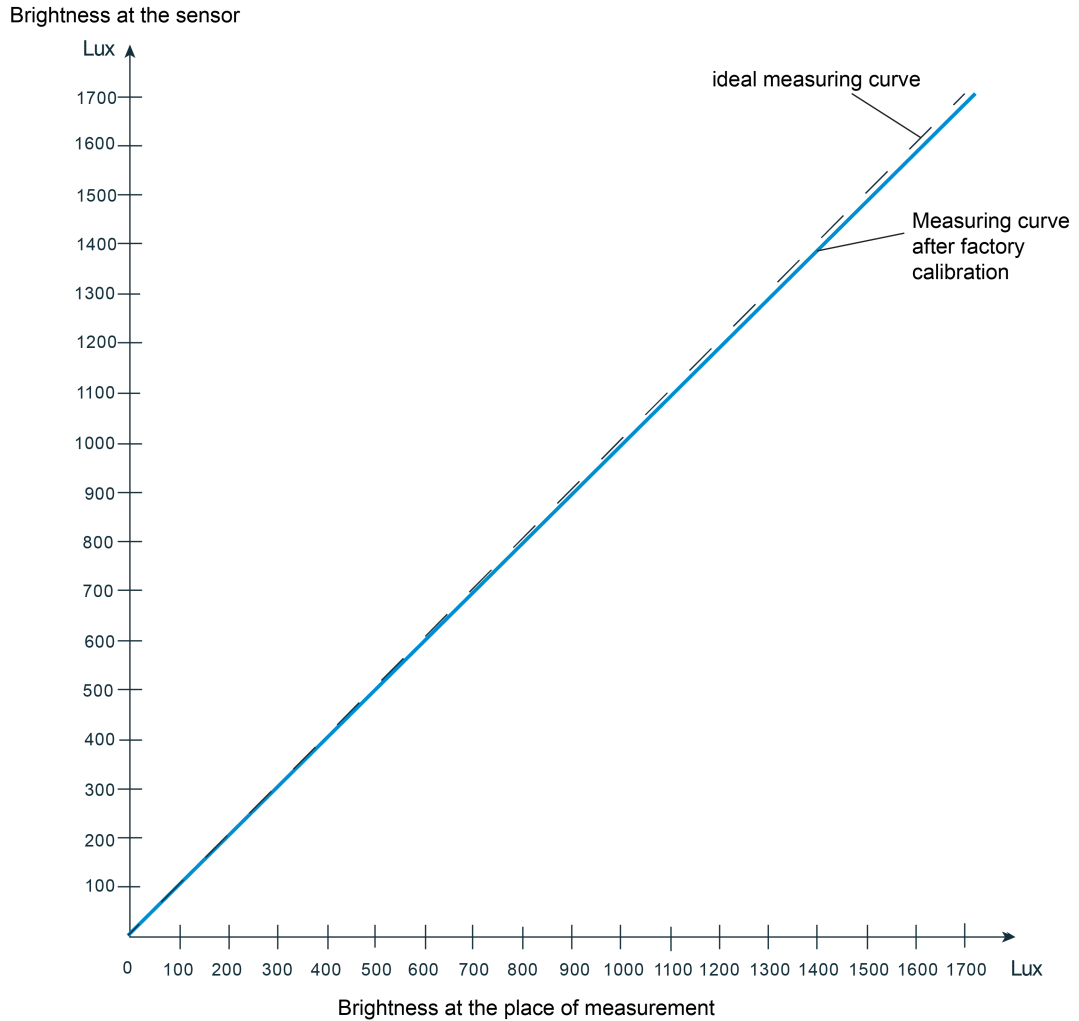

Figure 23: Measurement characteristic after factory calibration (sensor measured value = ambient brightness = Ideal measurement characteristic)

In some installation environments, it could be that the mounting location of the device is unsuitable, with regard to a brightness measurement. The factory calibration is then not ideal and leads to incorrect measured values. To compensate deviations in the measured brightness to the real ambient brightness in such cases, the brightness measurement can be calibrated using a calibration function (adjustment of the calibration factor) and thus be matched to a changed brightness situation and made ideal. During calibration, an externally preset brightness reference value is assigned to the currently measured sensor brightness. This presetting is made via the 2-byte communication object "Brightness sensor - Sensor calibration input". The sensor calibration in the ETS must be activated on the parameter page "Motion and light sensor" by the parameter of the same name so that this object can be visible and subsequent calibration possible. For this purpose, this parameter must be set from "factory calibration" to "calibration by telegram".

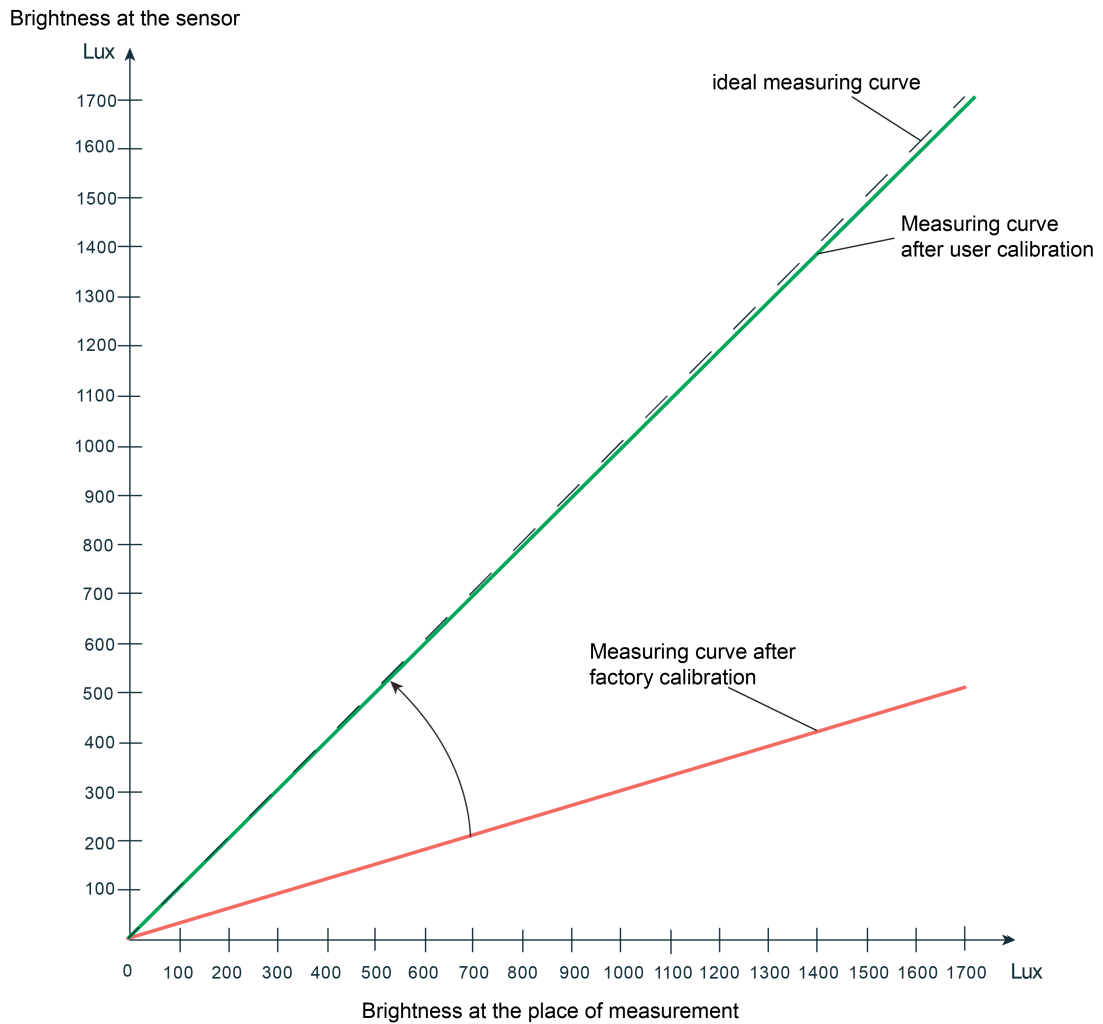

Figure 24: Measurement characteristic after user calibration (correction of the sensor measured value to the ambient brightness = ideal measurement characteristic)

Whether or not a subsequent user calibration is necessary can be determined purely subjectively or by reference measurement. A user calibration should be performed if the twilight level evaluation can be evaluated subjectively as "not adequate" by persons present. Alternatively, it is possible to determine whether subsequent calibration is necessary immediately after commissioning by reading out the brightness value determined by the device during factory calibration via the object "Measured brightness value". Here, the read-out brightness value must be compared with the measured value of a suitable brightness meter (calibrated luxmeter). If the deviation between the brightness values is too great, a user calibration should be performed. During the comparison measurement, several measurements should be made at various points in the vicinity of the mounting location. The individual measurement results must then be averaged and compared with the measured value of the device.

The following steps must be carried out for a user calibration...

- Set the brightness level in the room as desired.

- Then, transmit the ambient brightness that was measured several times and averaged - with the aid of the ETS, for example - to the object "Brightness sensor - sensor calibration input". As a result, the device assigns the predefined measured value to the currently measured brightness value, whereby the measured value characteristic is adapted in the device.

A user calibration is permanently saved in the device and is also not lost if there is a bus voltage failure or an ETS programming operation.

With "Calibration by telegram": The device will not evaluate any brightness after the first commissioning until a user calibration has been carried out. In this case, all function blocks with brightness-dependent movement control have no function until a calibration has been carried out properly. The brightness value tracked via the object "Measured brightness value" can be influenced by the parameter "Behaviour in case calibration not carried out" in the event of a calibration not yet carried out. Depending on the setting, the device will either transmit no brightness value (value "0" in the object) or the value "7FFF" (hexadecimal) to indicate an invalid brightness measured value.

- i** A new user calibration can be performed at any time during device operation. Any user calibration previously carried out is replaced with a new calibration. A user calibration can be reset to factory calibration at any time using the parameter "Sensor calibration".

4.2.4.2.3 Walking test and display of motion impulses

The device has a walking test function. The walking test function serves as a guide during the project design and setting of the PIR detection area. The walking test indicates the reaction of the device when detecting motions by means of a blue status LED that is clearly visible behind the sensor window. The walking test can be active immediately after the ETS commissioning. Optionally, the status LED can signal any detected motions even during normal operation.

Characteristics of the device in the walking test

The device has the following characteristics during an active walking test...

- The motion detection always takes place brightness-independent.
- All PIR sectors are active (according to the set sensitivities).
- When a motion is detected, a blue status LED in the sensor window is activated for the duration of the motion impulse. At the same time, the motion signals of the two sectors are combined.
- No transmission delay is started at the end of a detected motion.
- The function block is not processed (no telegrams are transmitted)
- There is no main unit and extension arrangement. The device works autonomously.
- The parameters "Behaviour after bus voltage return" and "Behaviour after ETS programming" and the disabling function of the function block are not evaluated.
- i** An ongoing transmission delay after bus voltage return is deactivated during activation of the walking test function. This is then no longer active, even during deactivation of the walking test function.
- i** If the walking test is activated when the "ON" or "OFF" operating mode is active, then the operating mode is automatically switched over to "AUTO". The last set states of the outputs of the function blocks are maintained during the walking test. When the walking test is deactivated, function block then works normally again, according to the "AUTO" operating mode.

Activation and deactivation via ETS parameter

To activate the walking test via the ETS configuration, the parameter "Walking test after ETS programming" must be set to "activated" on the parameter page "Motion and light sensor". After subsequently programming the application program in the ETS, the walking test is then activated automatically.

It is possible to deactivate a walking test with the aid of the ETS by resetting the aforementioned parameter to "deactivated" and reprogramming the application program.

Display of motion impulses

The blue status LED is activated by the walking test. Optionally, the status LED can signal any detected motions even during normal operation. The parameter "Display of motion impulses via walking test LED" enables this function with the setting "with active walking test and in normal operation". The signalling enables the start and duration of the motion detection to be visualized by the device at any time.

Example application: Used to detect the failure of a luminaire.

- i** The status LED displays detected motions of all PIR sectors brightness-independent.

- i** The blue Status LED and the brightness sensor to measure ambient brightness are located together behind the PIR sensor window. As a result, the brightness measurement of the device in operation can be adversely affected by the LED. For this reason, it is not possible to assign the internal brightness sensor to the function block for the application types "Single device" and "Main unit" if the blue Walking test LED signals movements in normal operation. In this case, only the allocation of an external KNX brightness sensor is possible. With the "Extension" application type, only the internal brightness sensor is assigned to a function block. With continually faulty brightness detection at the extension, the blue Status LED should be configured, so that it only displays movement during a walking test.

4.2.4.3 Function blocks 1-5 for motion detection

4.2.4.3.1 Applications

The device contains a function block (FB) which can be configured to the application "Detector", "Detector with switch-off brightness" or "Alert operation". Up to two output communication objects are available for the function block, which transmit the switching and control commands to the KNX. Depending on the configured function (switching, staircase function, dimming value transmitter, scene extension, temperature value transmitter, brightness value transmitter, operating mode switchover, switching with forced position), the data format of these objects is defined separately and adapted to the controllable function units of the KNX system.

On the parameter page "FB1 - General", the application of a function block (detector, detector with switch-off brightness, detector) can be configured by the parameter of the same name. This parameter - just like the parameter "application type" and "operating mode" - should be configured to the necessary setting at the very start of the device configuration, since all other function block parameters and objects depend on the above parameters.

The different applications of the function block are described in detail in the following chapters.

Application Ceiling detector

In the application as a detector, the device is normally used to control lighting automatically if people are present. In so doing, the evaluation of movements can be performed according to the ambient brightness (twilight level) or independently of the brightness. In automatic mode, lighting switched on by the detector is only switched off independently of the ambient brightness if no movement is detected in the monitored area.

In the detector function, the function block detects motions and transmits the telegram configured at the beginning of a detection to the bus whenever the measured brightness value is below the set twilight level. At the beginning of a detection, the telegram can be transmitted after a delay (evaluation delay).

If the telegram was transmitted at the beginning of a detection, the device works independently of the brightness. If no more motions are detected, the device transmits the configured telegram to the bus at the end of the detection once the total transmission delay (standard delay 10 s + additional transmission delay) has elapsed.

- i** Regardless of a motion detection, the light can be switched on and off even if the detector is disabled, during a manual operation (external motion) and on bus voltage return.

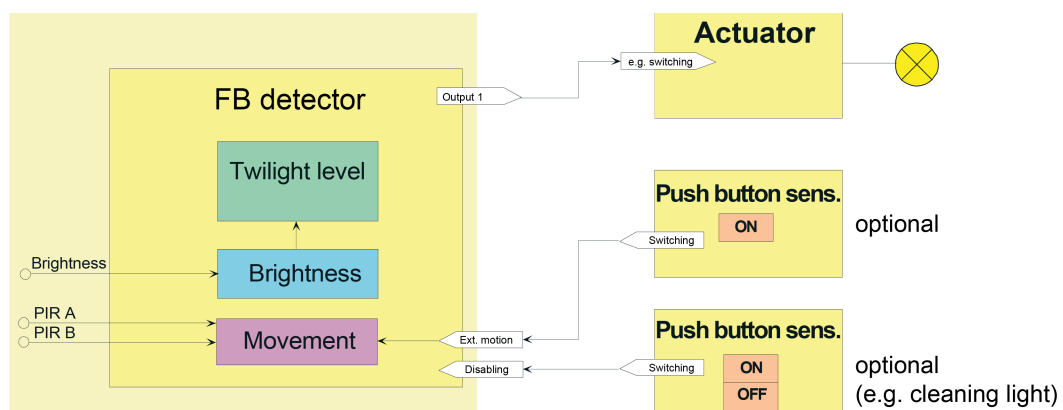

Figure 25: Application example of the application detector

The brightness level, whereupon motion impulses are transmitted by the detector if this level is fallen below, is defined by the twilight level. The twilight level is configured in the ETS and can be changed optionally by a Teach function or by external bus presetting. If the determined brightness falls below the twilight value, the detector switches on the artificial light via the KNX

actuator when a motion is detected. The brightness range above the twilight level characterizes the brightness of a room in which the illumination is sufficiently bright and thus no more artificial light has to be switched on. If the ambient brightness is within this range and the device detects a motion, no additional artificial light is then switched on. If the twilight level is configured to "brightness-independent", the artificial light is always switched on when a motion is detected without monitoring the ambient brightness.

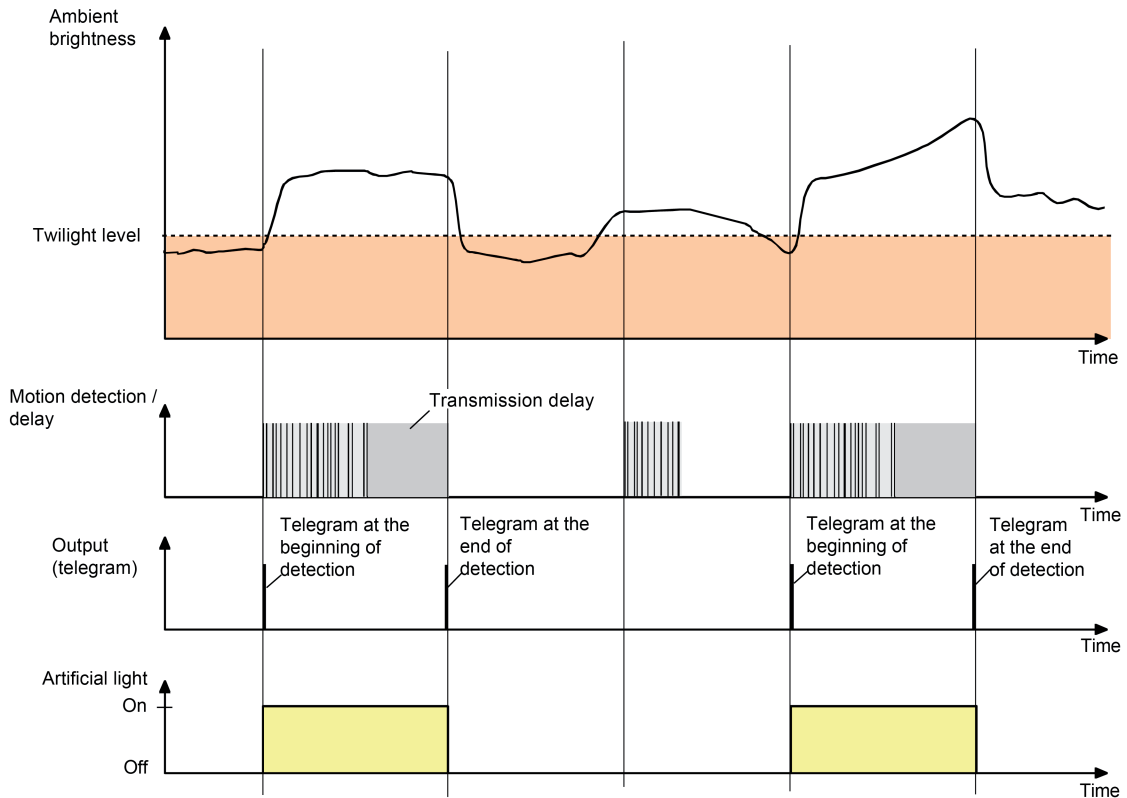

Figure 26: Brightness and motion evaluation with the detector

Application motion detector with switch-off brightness

The application "Detector with switch-off brightness" is normally used in areas where people spend longer periods of time (e.g. kitchen, bathroom/toilet...) for controlling the lighting or heating/ventilation. A detector with switch-off brightness evaluates the ambient brightness continuously, even when the lighting is switched on. Thus, for example, lighting can be switched off when a defined brightness threshold is exceeded, e.g. by incoming daylight, even if motion continues.

If the measured brightness exceeds a defined switch-off threshold (switch-off brightness), the lighting is switched off after a configurable delay has elapsed even during active motion detection.

- i** Regardless of a motion detection, the light can be switched on and off even if the detector is disabled, during a manual operation (external motion) and on bus voltage return.

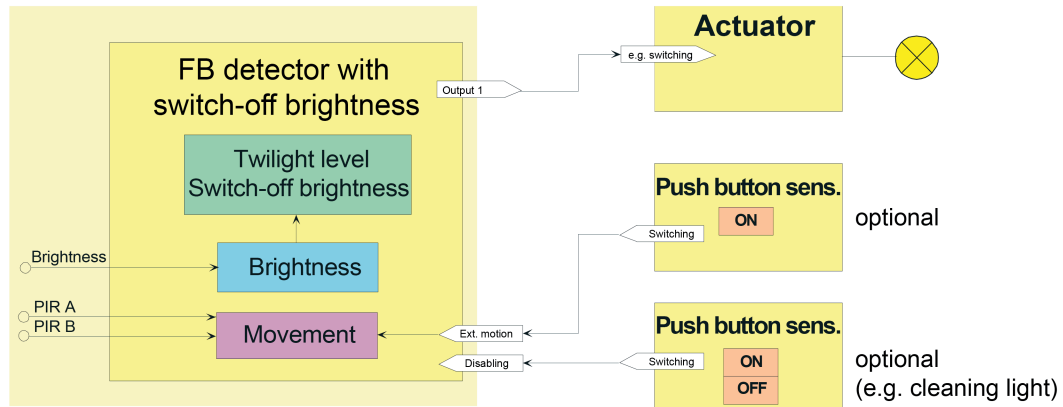

Figure 27: Application example of the application Detector with switch-off brightness

A detector with switch-off brightness detects the presence of people and transmits the configured telegram at the beginning of a detection whenever the determined brightness value is below the set twilight level. The twilight level is configured in the ETS and can be changed optionally by a Teach function or by external bus presetting. The telegram can also be transmitted after a delay (evaluation delay) at the beginning of a detection. If no movements are detected any more during the further course of the motion detection, the device transmits the configured telegram to the bus once the set total transmission delay (standard delay 10 s + additional transmission delay) has elapsed.

If the measured ambient brightness continuously exceeds the set switch-off brightness during active motion detection, motion detection will be terminated either after the transmission delay has elapsed or after a separately configurable switch-off delay and the configured telegram transmitted at the end of detection.

- Transmission delay after reaching the switch-off brightness = "As additional transmission delay":
After the switch-off brightness has been exceeded, no further movements are evaluated. This means that the transmit delay is also not retriggered. After the transmission delay has elapsed, motion detection is terminated and the configured telegram is transmitted at the end of detection.
- Transmission delay after reaching the switch-off brightness = "Switch-off delay":
The configured switch-off delay is started after the switch-off brightness has been exceeded. Detected movements continue to be evaluated and retrigger the transmission delay. The end of detection then occurs after the configured switch-off delay has elapsed, assuming movements continue to be detected, or after the additional transmission delay has elapsed, if no more movements are detected.
The switch-off delay is used for the debouncing of brief light reflexes and prevents faulty switching of the lighting.

i If, before the end of detection, the switch-off brightness is fallen below again, any detected movements trigger the transmission delay again normally and any switch-off delay currently running is terminated.

The range between twilight level and switch-off brightness characterises the brightness in the room to which the detector should adjust. If the ambient brightness is within this range and the device detects a new motion, no lighting is switched on.

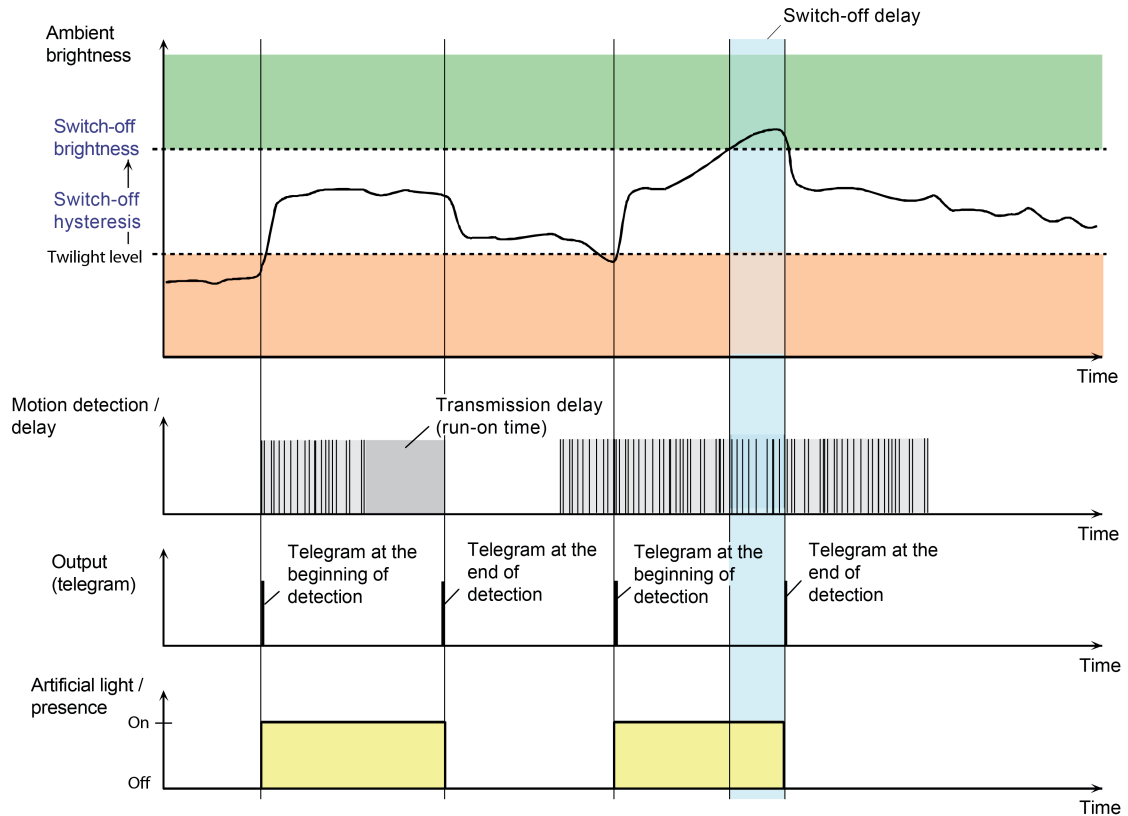

Figure 28: Brightness and motion evaluation with the detector with switch-off brightness

Application Detector

When being used in alert operation, the device always works brightness-independently. Message telegrams signal whether or not people are present in the monitored area. Here, the number of motion impulses can be specified within a monitoring time whereby it is possible to adapt the motion evaluation to individual requirements. A motion is only identified, when the device has detected the set number of motion impulses. This application is appropriate when the device is to be used as a detector for KNX signalling systems.

In alert operation, the device reacts less sensitively to detected motions since a message telegram is only transmitted via the output object after repeatedly polling the motion signal. The configurable number of motion impulses that can occur within a selectable monitoring period is the criterion for triggering a message telegram. A message telegram can be output at the beginning or end of an identified motion.

- i** The alert operation only works as a single device and if necessary transmits a telegram to a central via the output object after detecting and evaluating the motion. The extension inputs or outputs are deactivated in alert operation.

The diagram illustrated below shows the behaviour of the function block in the application Detector. In the example, the number of motion impulses was set to "4".

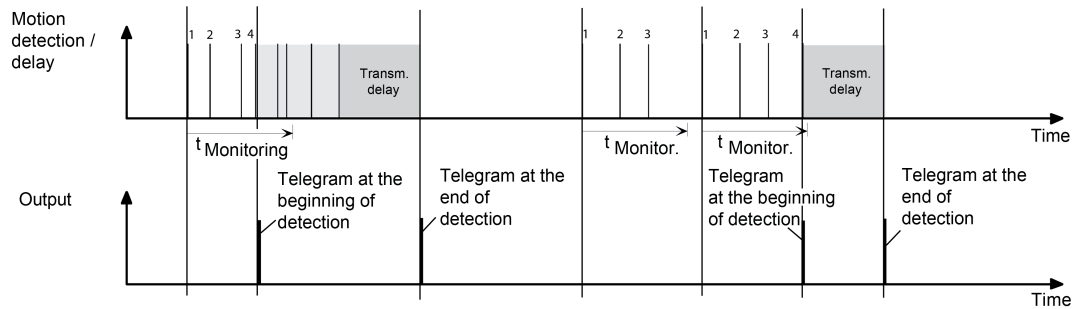

Figure 29: Motion evaluation with the detector

After detection of the fourth motion impulse in the monitoring period ($t_{\text{monitoring}}$), the message telegram "at the beginning of the detection" is transmitted and the transmission delay is started. Further motion impulses within the transmission delay induce the retriggering of the transmission delay. In the absence of motion signals and after the transmission delay has elapsed, the message telegram "at the end of the detection" is transmitted. If less than 4 motion impulses are detected within the monitoring period, no message telegram is triggered. After the monitoring period has elapsed, the next motion impulse is the first of a new monitoring period. When a detection begins (start of the transmission delay), the monitoring period is stopped and reset. The monitoring is restarted again with the first motion impulse after the transmission delay has elapsed.

The following functions are preset on the detector...

- Twilight level: brightness-independent
- Outputs: only output 1
- Teach function: disabled
- Evaluation delay at the beginning of the detection: no
- Cyclical transmission during a detection: possible
- Triggering of a telegram when retriggering: possible
- Additional transmission delay at the end of a detection: possible
- Time extension for additional transmission delay at the end of a detection: not possible
- Disabling function: possible (disabling behaviour preset)
- Extensions inputs and outputs: deactivated

4.2.4.3.2 Application types

The device can be used as single device, main unit or extension in the applications "Detector" or "Detector with switch-off brightness". It is possible to use several devices in a room to extend the detection area by combining a device configured as a main unit with several devices configured as an extension.

The application type of the function block is configured in the ETS by the parameter of the same name on the parameter page "FB1 - General". This parameter - just like the parameters "Application" and "Operating mode" - should be configured to the necessary setting at the very start of the device configuration, since all the other function block parameters and objects depend on the above parameters.

A combination of main units and extensions is possible solely with "Universal" devices "Jung ceiling detector / presence detector Universal (3361-1)" and "Jung Universal automatic switch (3181-1 / 3281-1)" and with the "Standard" device variants "Jung presence detector Standard (3361)" and "Jung Standard automatic switch (3181 / 3281)"! If other devices are used in main unit and extension operation, functional restrictions or malfunctions can be expected!

The different application types are described below.

i In the application "detector", the device only works as a single device.

Application type "single device"

With this application type, the device works independently. A main unit and extension arrangement with other devices is not possible.

Optionally, an external 1-bit motion detection can be supplied to the device, which originates from a pushbutton in the room, for example. This allows the user to control the connected KNX actuator even without a motion detection in the detection area of the device. The evaluation of the external motion signal is possible brightness-dependent or brightness-independent.

The 1-bit object input "Lighting manual ON/OFF" is available as a further option. The activated KNX actuator can be switched on and also switched off again independent of motion via this input.

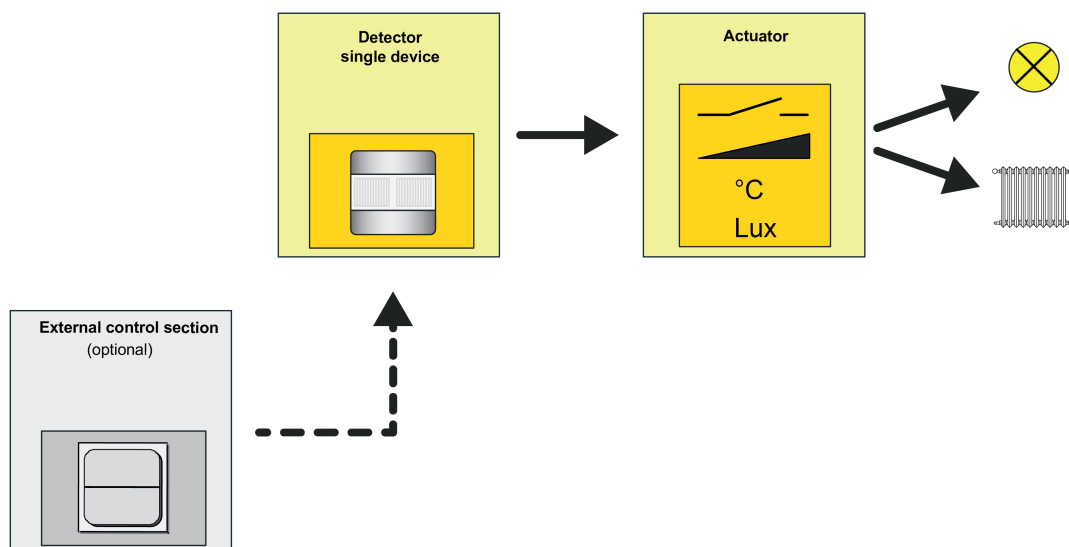

Figure 30: Application type "single device"

Application type "Main unit"

A main unit is used as a central unit in combination with one or more detectors configured as extensions. The combined main unit and extension(s) execute the motion detection coherently and thus allow any desired extension of the detection area. The extensions combined with the main unit transmit their motion signal to the object "External motion" of the main unit via the same group address.

The twilight level evaluation can be made separately in main unit and extension(s) or centrally in the main unit. The twilight level evaluation can be deactivated in the main unit and extension(s) for brightness-independent controls such as temperature value transmitter applications, room temperature controller operating mode switch-overs or ventilation controls. The evaluation of the switch-off brightness (for the "Detector with switch-off brightness") always takes place centrally in the main unit. The actuator is controlled exclusively by the main unit. A combination of several main units (affecting the same KNX actuator) is not possible.

With this application type, too, it is possible again to optionally supply the device - parallel to the extensions via the same group address to the object "External motion" - with an external 1-bit motion detection that can be evaluated - depending on the configuration of the twilight level evaluation - in a brightness-dependent or brightness-independent fashion. If user-guided and motion-independent control is required, the manual operating function of the device ("Lighting manual ON/OFF") should be used.

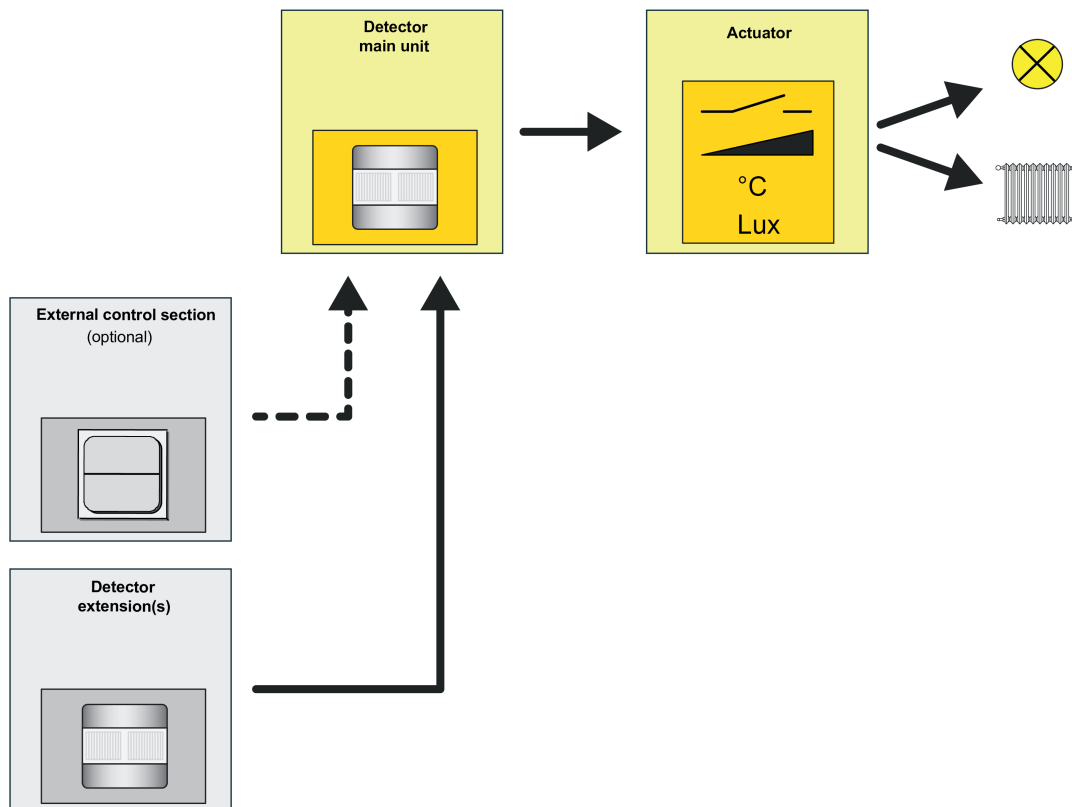

Figure 31: Application type "Main unit"

Application type "Extension"

An extension is a subscriber of a combination of several detectors that coherently execute the motion detection as well as optionally the twilight level evaluation. The extension transmits only one motion detection to one main unit. An extension therefore does not directly control an actuator.

An extension can subject the motion detection to the evaluation of its own twilight level, or alternatively, can work brightness-independently. If the brightness evaluation is activated in the extension, the twilight level must be deactivated by the main unit when switching on the lighting (brightness-independent operation if the lighting is switched on). This takes place - regardless of the data format of the actuator output objects of the main unit - via the object "Deactivation of twilight level" which must be linked to the object of the main unit of the same name. The twilight level evaluation can be deactivated in the main unit and extension(s) for brightness-independent controls such as temperature value transmitter applications, room temperature controller operating mode switch-overs or ventilation controls.

- i** The evaluation of the switch-off brightness (for the "Detector with switch-off brightness") always takes place centrally in the main unit.

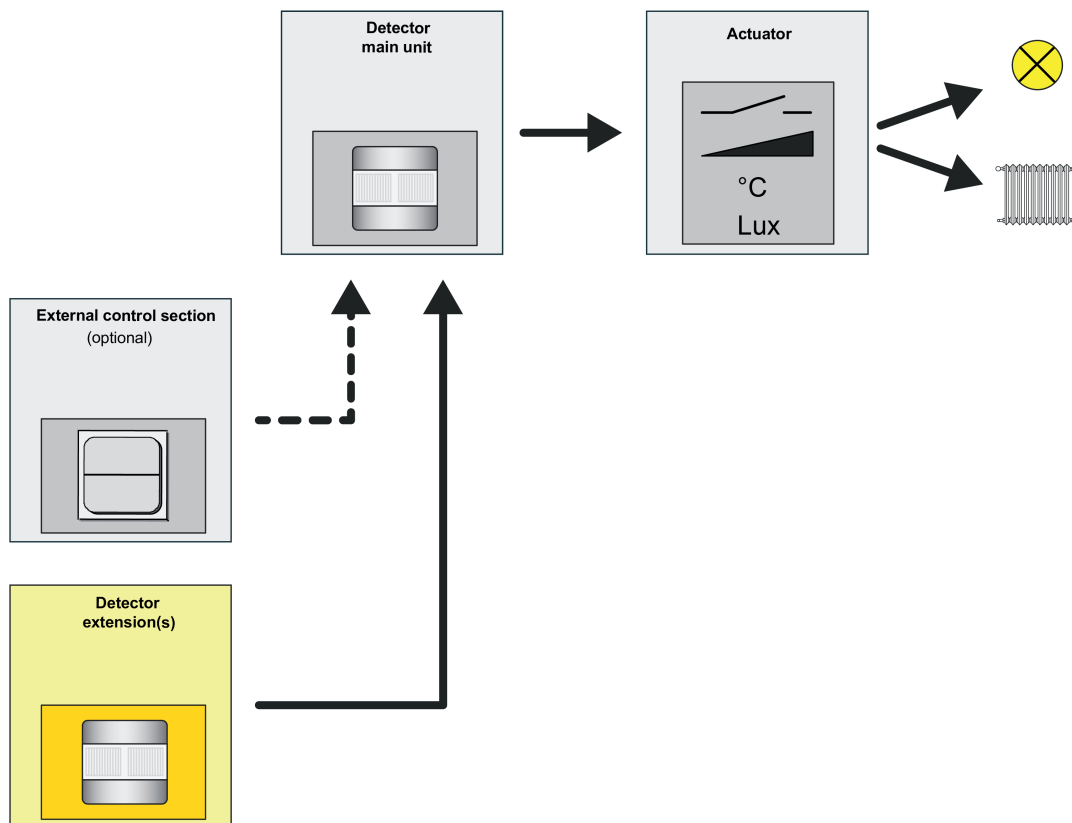

Figure 32: Application type "Extension"

During an active motion detection, the extension transmits motion telegrams cyclically to the main unit via the object "Motion". The cycle time t_1 is configurable in the extension on the parameter page "FB1 - Beginning of detection". All extensions must be configured to the same time. The cycle time must be adjusted to the transmission delay (standard delay 10 seconds + additional transmission delay) of the main unit. Within the transmission delay, there must be at least one motion telegram during a continuous motion. To ensure reliable motion evaluation, the cycle time should be slightly less than half of the transmission delay. In the standard configuration, the cycle time is set to 9 seconds. This ensures reliable motion evaluation by the extensions even without additional transmission delay in the main unit. In the case of long transmission delays, it is recommendable to also adapt the cycle time as described in order to reduce the bus load due to the extension motion telegrams. The transmission delay t_2 (active time of the motion evaluation) is preset to 6 seconds in extension operation.

- i** When retriggering (new motion within the transmission delay), no motion telegram is transmitted.

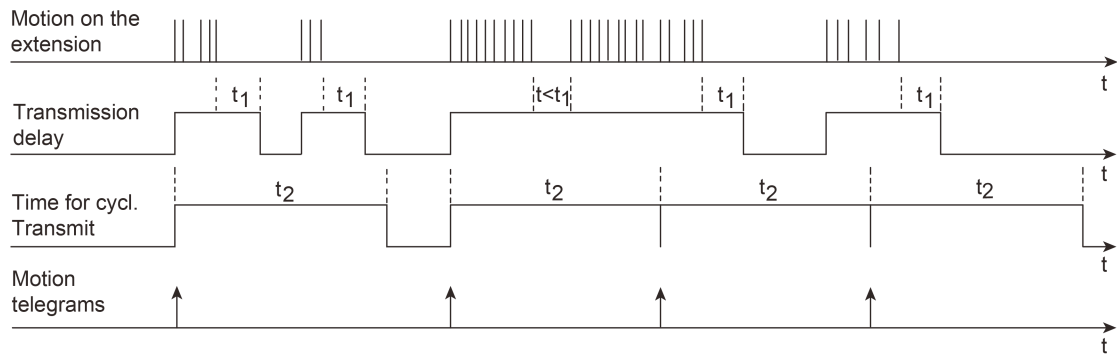

Figure 33: Motion signals of an extension

In this application type, it is not possible to supply external motion detections to the device for implementing a manual operation (e.g. by means of a pushbutton). This is only possible on a main unit.

4.2.4.3.3 Operating mode

In the case of function blocks with the application "Detector" or "Detector with switch-off brightness", the operating mode can be configured in the ETS. The operating mode specifies the function of the motion detection and defines whether or not the beginning and the end of a motion detection is identified automatically. Thus, the operating mode can be configured to "Fully automatic" (Automatic ON, Automatic OFF), to "Semi-automatic I" (Manual ON, Automatic OFF) or "Semi-automatic II" (Automatic ON, Manual OFF). This makes it possible to adjust the motion detection to many applications in private and public areas (e.g. toilet lighting, service lighting, control of ventilation systems).

Fully automatic (Auto ON, Auto OFF)

In this operating mode, the outputs of a function block are activated automatically by the motion detection and brightness evaluation. Manual activation of the device is not necessary.

An additional manual operation can take place via the following KNX objects if required...

- "External motion":
This object makes it possible to generate a motion impulse via an external KNX sensor (e.g. pushbutton) with the application types "single device" or "main unit". An extension transmits motion signals in a main unit / extension combination to this input. Similarly, however, it is possible to transmit a 1-bit motion impulse to this object via another KNX sensor in order to trigger the motion detection of a function block. The subsequent evaluation of "real" PIR motion signals and the processing of the delay times then takes place according to the normal pattern.
In the application type "extension", it is not possible to transmit extension signals to the object "external motion". Here, the object for the twilight level switch-over in staircase functions is used. Further information can be found in application examples.
- "Lighting manual ON/OFF":
This object can be used directly for the manual operation e.g. via a pushbutton. An ON telegram is evaluated as a brightness-dependent motion detection, whereby the telegrams are always transmitted to the outputs at the beginning of the detection and the transmission delay is started. An OFF telegram transmitted to this object during a current motion detection results in the cancellation of the motion evaluation and termination of the transmission delay, including transmission of the telegrams at the end of the motion. The function block is then in the basic state and ready for a new motion detection. Further information can be found in the chapter entitled "Manual operation".
- "Disabling":
This object is used for activating and deactivating the disabling function. This makes it possible to disable the function block and initiate a corresponding action by force (e.g. lighting permanently ON due to cleaning lighting). The normal operation of the function block is only possible again after enabling the disabling function.

Semi-automatic I (manual ON, Auto OFF)

In this operating mode, an ON telegram must first be transmitted to the object "Lighting manual ON/OFF" before a motion (including ext. motion) is detected and evaluated. At the same time, the ON telegram starts the first motion detection including the transmission delay. The end of the detection is identified automatically or initiated by an OFF telegram to the object Lighting manual ON/OFF". Afterwards, a manual ON telegram is required again, in order to evaluate a new motion.

Semi-automatic II (Auto ON, Manual OFF)

In this operating mode, a detection is identified automatically as in the operating mode "Fully automatic". After detection of a motion and output of the telegrams for "beginning of a detection", no transmission delay is started. Thus, the end of the detection can only be achieved by an OFF telegram to the object Lighting manual ON/OFF". The function block is then ready again for a new motion evaluation.

4.2.4.3.4 Operating mode and local control

Local control

The 1.10 m automatic switch possesses a slide switch beneath the PIR sensor window for local operation. With the 2.20 m automatic switch, local operation is possible using two separate push-buttons on the left and right, next to the PIR optics. In running device operation, the operating mode (OFF / AUTO / ON) of the function block can be switched over using the slide switch or the separated push-buttons, thus influencing the state of the corresponding output directly. This means that, for example, it is possible when activating lighting to deactivate automatic motion and thus permanently switch the light on or off as required.

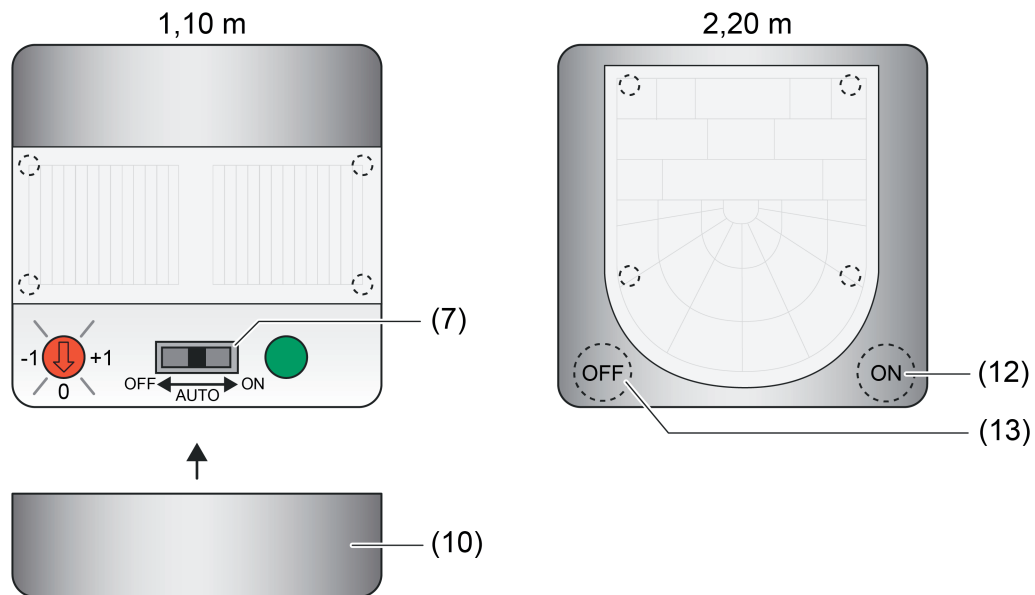

Figure 34: Arrangement of the operating elements for local operation (operating mode switchover)

- (7) Slide switch for local operation (setting of the operating mode)
- (10) Design cover for the slide switch (operating element)
- (12) "ON / AUTO" button for operating mode switchover
- (13) "OFF / AUTO" button for operating mode switchover

- i** Local operation only influences function block!
- i** All local operations for function block are inactive when the function block is deactivated by the disabling function. After enabling, the function block is always in the operating mode "AUTO".

The functions of the individual operating modes are explained below.

- "ON" operating mode - user-guided switch-on
By activating this operating mode, automatic operation is finished and the function block is locked. At the beginning of the detection, the configured telegrams are sent via the outputs and the device is switched over to brightness-independent operation.

- "Operating mode" **AUTO** - Activate automatic operation
If this operating mode is set, locking is cancelled and automatic operation activated without sending a telegram to the bus. The device then waits for motions.
Note: If the status "ON" was active previously, the telegrams at the end of the detection are only transmitted after a new motion detection has been terminated. If no motion is subsequently detected after activation of the automatic operation, the actuator status of the operating mode "ON" (e.g. lighting = ON) is preserved until a new motion is detected.
- "Operating mode" **OFF** - Switch off user-guided
By activating this operating mode, automatic operation is finished and the function block is locked. At the end of the detection, the configured telegrams are sent via the outputs and the device is switched over to brightness-dependent operation if the twilight level evaluation is configured to brightness-dependent.
- i After bus voltage return, the active operating mode is dependent on the parameter "Behaviour on bus voltage return" of the function block. In the setting "State as before bus voltage failure", the operating mode that existed before bus voltage failure is adopted. In all other settings, the operating mode "AUTO" is always active after bus voltage return.
- i The most recently specified operating modes "ON" or "OFF" remain intact when the disabling function of local operation is activated.
- i If the walking test is activated when the "ON" or "OFF" operating mode is specified, then the operating mode is switched back to "AUTO". However, the state of the outputs of the function block remain intact. When the walking test is deactivated, the function block then works normally again, according to the "AUTO" operating mode.

The operating mode of the function block can either be set through local operation directly on the device or via KNX communication objects (see "External operating mode switchover" below). The last specification or operation directly specifies the operating mode to be set and thus the active operating mode (the last command wins). There is no special priority when processing the operating mode switchover.

The parameter "Function of local operation" on the parameter page "FB1 - Operating mode / local operation" specifies which operating modes can be set through an operation on the device.

- Setting "1 / AUTO / 0":
The slide switch (1.10 m variant) and the "ON" and "OFF" buttons (2.20 m variant) are fully functional. The operating modes "ON", "AUTO" and "OFF" can be set as required.
In so doing, note that the switch position in the 1.10 m variant is not always a measure for the active operating mode. Operation of the device via the communication object can override the specification of the slide switch if the KNX operation takes place after a movement of the slide switch. The subsequent tables show which operating mode is set, depending on the last operation or specification.

Current switch position	Current operating mode	Switch adjustment	Resulting operating mode
AUTO	AUTO	-> OFF	OFF
AUTO	ON	-> OFF	OFF
AUTO	OFF	-> OFF	OFF
AUTO	AUTO	-> ON	ON
AUTO	ON	-> ON	ON
AUTO	OFF	-> ON	ON
ON	AUTO	-> AUTO	AUTO
ON	ON	-> AUTO	AUTO
ON	OFF	-> AUTO	AUTO
ON	AUTO	-> OFF	OFF
ON	ON	-> OFF	OFF
ON	OFF	-> OFF	OFF
OFF	AUTO	-> AUTO	AUTO
OFF	ON	-> AUTO	AUTO
OFF	OFF	-> AUTO	AUTO
OFF	AUTO	-> ON	ON
OFF	ON	-> ON	ON
OFF	OFF	-> ON	ON

Local operation with slide switch (1.10 m variant) for "1 / AUTO / 0"

Current operating mode	Button actuation	Resulting operating mode
AUTO	ON / AUTO	ON
ON	ON / AUTO	AUTO
OFF	ON / AUTO	AUTO
AUTO	OFF / AUTO	OFF
ON	OFF / AUTO	AUTO
OFF	OFF / AUTO	AUTO

Local operation with push-button (2.20 m variant) for "1 / AUTO / 0"

- Setting "1 / AUTO / -":
 The slide switch (1.10 m variant) has no function in the "OFF" position. The "ON" and "AUTO" positions are evaluated. In the same way, the "OFF" button (2.20 m variant) has no function during an operating mode switchover. Only the "ON" button functions.
 In so doing, note that the switch position in the 1.10 m variant is not always a measure for the active operating mode. Operation of the device via the communication object can override the specification of the slide switch if the KNX operation takes place after a movement of the slide switch. The subsequent tables show which operating mode is set, depending on the last operation or specification.

Current switch position	Current operating mode	Switch adjustment	Resulting operating mode
AUTO	AUTO	-> OFF	AUTO
AUTO	ON	-> OFF	ON
AUTO	OFF	-> OFF	OFF
AUTO	AUTO	-> ON	ON
AUTO	ON	-> ON	ON
AUTO	OFF	-> ON	ON
ON	AUTO	-> AUTO	AUTO
ON	ON	-> AUTO	AUTO
ON	OFF	-> AUTO	AUTO
ON	AUTO	-> OFF	AUTO
ON	ON	-> OFF	ON
ON	OFF	-> OFF	OFF
OFF	AUTO	-> AUTO	AUTO
OFF	ON	-> AUTO	AUTO
OFF	OFF	-> AUTO	AUTO
OFF	AUTO	-> ON	ON
OFF	ON	-> ON	ON
OFF	OFF	-> ON	ON

Local operation with slide switch (1.10 m variant) for "1 / AUTO / -"

Current operating mode	Button actuation	Resulting operating mode
AUTO	ON / AUTO	ON
ON	ON / AUTO	AUTO
OFF	ON / AUTO	AUTO
AUTO	OFF / AUTO	AUTO
ON	OFF / AUTO	ON
OFF	OFF / AUTO	OFF

Local operation with push-button (2.20 m variant) for "1 / AUTO / -"

- Setting "- / AUTO / 0":
The slide switch (1.10 m variant) has no function in the "ON" position. The "OFF" and "AUTO" positions are evaluated. In the same way, the "ON" button (2.20 m variant) has no function. Only the "OFF" button has no function.
In so doing, note that the switch position in the 1.10 m variant is not always a measure for the active operating mode. Operation of the device via the communication object can override the specification of the slide switch if the KNX operation takes place after a movement of the slide switch. The subsequent tables show which operating mode is set, depending on the last operation or specification.

Current switch position	Current operating mode	Switch adjustment	Resulting operating mode
AUTO	AUTO	-> OFF	OFF
AUTO	ON	-> OFF	OFF
AUTO	OFF	-> OFF	OFF
AUTO	AUTO	-> ON	AUTO
AUTO	ON	-> ON	ON
AUTO	OFF	-> ON	OFF
ON	AUTO	-> AUTO	AUTO
ON	ON	-> AUTO	AUTO
ON	OFF	-> AUTO	AUTO
ON	AUTO	-> OFF	OFF
ON	ON	-> OFF	OFF
ON	OFF	-> OFF	OFF
OFF	AUTO	-> AUTO	AUTO
OFF	ON	-> AUTO	AUTO
OFF	OFF	-> AUTO	AUTO
OFF	AUTO	-> ON	AUTO
OFF	ON	-> ON	ON
OFF	OFF	-> ON	OFF

Local operation with slide switch (1.10 m variant) for "- / AUTO / 0"

Current operating mode	Button actuation	Resulting operating mode
AUTO	ON / AUTO	AUTO
ON	ON / AUTO	ON
OFF	ON / AUTO	OFF
AUTO	OFF / AUTO	OFF
ON	OFF / AUTO	AUTO
OFF	OFF / AUTO	AUTO

Local operation with push-button (2.20 m variant) for "- / AUTO / 0"

- i** With operation using the slide switch (1.10 m variant): After bus voltage return, after an ETS programming operation or after the device is attached to a bus coupler, the current switch position is not evaluated. The operating mode is then set with the parameter "Behaviour after bus voltage return" of the function block. For this reason, the set operating mode may deviate from the switch position after a device reset. This switch position is only then evaluated on the first operation following the reset.
- i** In the case of operation using the slide switch (1.10 m variant): If the slide switch is adjusted quickly (within approx. 200 ms), e.g. from "ON" to "OFF", via the "AUTO" position, the device only evaluates the end position (i.e. "OFF"). The "AUTO" switch position is then not evaluated. The same applies to an adjustment from "OFF" to "ON". Only with a slow adjustment (switch position change > approx. 200 ms) is the "AUTO" operating mode evaluated.

- i** With operation via the push-buttons (2.20 m variant): The switchover of the operating mode only occurs if the buttons are released again within 1 second. Otherwise, there is no evaluation of the operation.
- i** Local operation affects the application types "Single device" and "Main unit" on the device itself. In the "Extension" application type, an appropriate operation can be transmitted to the main unit via the object "FB1 - Operating mode output" (see "External operating mode switchover" and "Application examples for operating mode switchover" further down).
- i** If the walking test is activated when the "ON" or "OFF" operating mode is active, then the operating mode is automatically switched over to "AUTO". The last set states of the outputs of the function blocks are maintained during the walking test. When the walking test is deactivated, function block then works normally again, according to the "AUTO" operating mode.

External operating mode switchover

For the application types "Single device" and "Main unit", the operating mode switchover for the function block can also take place via KNX communication objects. This means that it is possible, for example, for extensions to specify the operating mode of a main unit.

The 1-byte object "FB1 - Input operating mode" makes it possible to specify the operating mode of individual devices or main devices immediately through a value command. This object is usually used by suitable PIR extensions to set the operating mode in a main device. In the same way, single devices or main units are able, via the 1-byte object "FB1 - Output operating mode" to forward the active operating mode to other bus devices. By evaluating this information, extensions are able, for example, to detect which operating mode is active in the main device and to activate LED displays (see "LED display for operating mode" further down). Even on other KNX devices (e.g. pushbuttons with value comparators for the status LED), the feedback information can be used to activate status displays, allowing the operating situation of the detectors to be evaluated or read off at remote points.

The following table shows the required data values for the appropriate operating mode to be set.

Value	Operating mode
0	AUTO
1	ON
2	OFF
3...255	not used (no reaction)

Data values for specification of an operating mode through the 1-byte object

- i** So that, with a combination of main units and extensions, an information exchange between the devices is possible via the KNX, also allowing fault-free operation, the 1-byte input and output objects for operating mode switchover must be correctly linked via two separate group addresses (main unit output -> extension input & extension output -> main unit input / see also "Application examples for operating mode switchover" below).
- i** The operating mode of the function block can not only be set via the communication object, but also, as necessary, through local operation directly on the device. The last specification or operation directly specifies the operating mode to be set and thus the active operating mode (the last command wins). There is no special priority when processing the operating mode switchover.

- i** When deactivating the function block using the disabling function, the operating mode specifications are lost. The function block then switches to the "AUTO" operating mode. An output of this operating mode via the object "FB1 - Operating mode output" is only possible if the operating mode "ON" or "OFF" was active before the function block was deactivated. By lifting the disabling function, the function block remains in the "AUTO" operating mode until a new specification or operation. Output via the object "FB1 - Operating mode output" does not then occur as there is no change in the operating mode.
- i** A single device or a main unit only transmits a telegram to update other bus devices via the communication object "FB1 - Operating mode output" if the object state and thus the operating mode changes or if the device has experienced a reset (after bus voltage return, after an ETS programming operation, after attachment to a bus coupler). After a device reset, an extension polls the operating mode from the main unit via the object "FB1 - Operating mode input" through a read telegram (Value Read), so that the LED displays can be activated correctly.
- i** The parameter "Function of local operation" has no influence on an activation via the communication objects (1-byte).
- i** We recommend combining the external operating mode switchover with the LED status display of the detector, to give the user feedback during an operation and thus to display the active operating mode safely.

Disabling function

It is possible to deactivate local operation to switch over the operating mode using a separate disabling function. The disabling function can be used if the parameter "Use disabling function for local operation?" on the parameter page "FB1 - Operating mode / local operation" is configured to "Yes". The disabling function is then activated and deactivated via the communication object "Disable local operation" in which the telegram polarity is configurable. During active disabling, local operation of the operating mode is completely deactivated.

- i** The disabling function has no influence on an external operating mode switchover via the 1-byte or 1-bit communication objects. In consequence, the operating mode can also be influenced from outside when the disabling function is active.
- i** In the 2.20 m device variant, a long press of the "ON / AUTO" button can activate or deactivate the programming mode. Activation or deactivation of the programming mode continues to be possible, even if there is an active disabling function of the local operation.

The "state of the disabling function after bus voltage return" can be configured in the ETS. The following settings are possible...

- "deactivated":
After bus voltage return, local operation is ready for operation immediately.
- "activated":
After bus voltage return, local operation is disabled immediately.
- "State as before bus voltage failure":
The current state of the disabling function will be stored in case of bus voltage failure. After bus voltage return, the device tracks the saved disabling state (active or inactive).

The "state of the disabling function after ETS programming" can also be configured in the ETS. The following settings are possible here...

- "deactivated":
After an ETS programming operation, local operation is ready for operation immediately.
- "activated":
After an ETS programming operation, local operation is disabled immediately.

- i** After the device is attached to a bus coupler, the disabling function of the local operation is deactivated immediately.
- i** The last operating mode specification remains intact when the disabling function of the local operation is activated.

LED display of active operating mode

There are 4 LEDs positioned behind the PIR lens, signalling the operating state of the device. If necessary, an active "ON" operating mode can be displayed for the function block by a green LED (3) and an active "OFF" operating mode by a yellow LED (4) (figure 35). Whether the operating modes are displayed by the LEDs is configured separately for "ON" and "OFF" in the ETS using the "Display of 'ON' operating mode" and "Display of 'OFF' operating mode" on the parameter page "FB1 - Operating mode / Local operation".

In the "Single device" or "Main unit" application types, the green or yellow LED directly displays the operating mode active in the device. An extension derives the current operating mode from the 1-byte object "FB1 - Operating mode input". For this display function to be executed correctly at an extension, this object must be linked with the 1-byte object "FB1 - Operating mode output" of the main unit (see "Application examples for operating mode switchover" further down). In consequence, extensions can also signal the active operating mode via the LED display.

We recommend always using the LED display during an operating mode switchover (local operation or external switchover), to give the user feedback during an operation and thus to display the active operating mode safely.

- i** Besides the yellow and green LED for displaying the active operating mode for the function block, the blue LED (5) signals a movement in the walking test or normal operation or an unloaded application. The red LED (6) signals an active programming mode. These additional display functions are not influenced by the LED display of the operating mode.

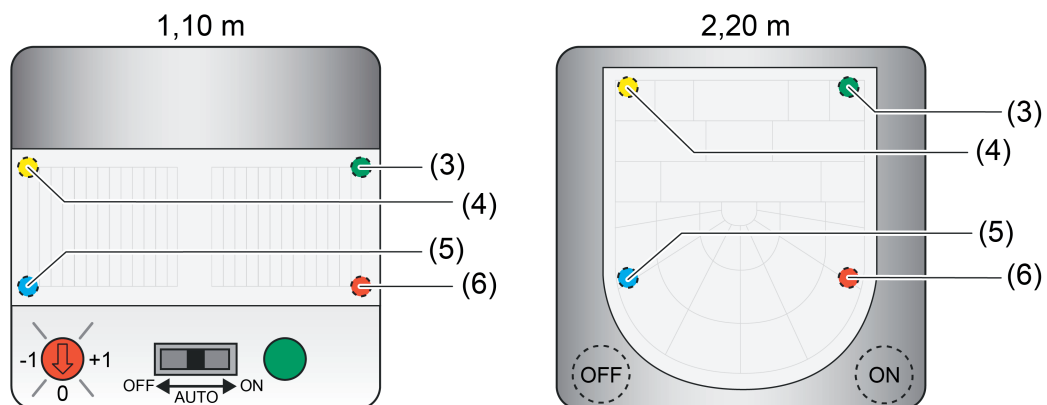

Figure 35: Arrangement of the LEDs to display the operating states

- (3) LED (green) - Display of "ON" operating mode
- (4) LED (yellow) - Display of "OFF" operating mode
- (5) LED (blue) - Display of "Motion detected" or "Application not loaded"
- (6) LED (red) - Display of "Programming mode"

Active operating mode	LED "ON" (green)	LED "OFF" (yellow)
-----------------------	------------------	--------------------

AUTO	OFF	OFF
ON	ON	OFF
OFF	OFF	ON

LED display to signal the active operating mode

- i** When deactivating the function block using the disabling function, the operating mode specification is lost. The function block then switches to the "AUTO" operating mode and the LED displays are switched off. Telegrams via the status objects are only transmitted if, before the function block is deactivated, the operating mode "ON" or "OFF" was active and the state thus changes.
- i** After a device reset, an extension polls the operating mode from the main unit via the object "FB1 - Operating mode input" through a read telegram (Value Read), so that the LED displays can be activated correctly.

Application example for operating mode change-over

Main unit and extension operation with operating mode switchover and display (1 main unit / 2 extensions)

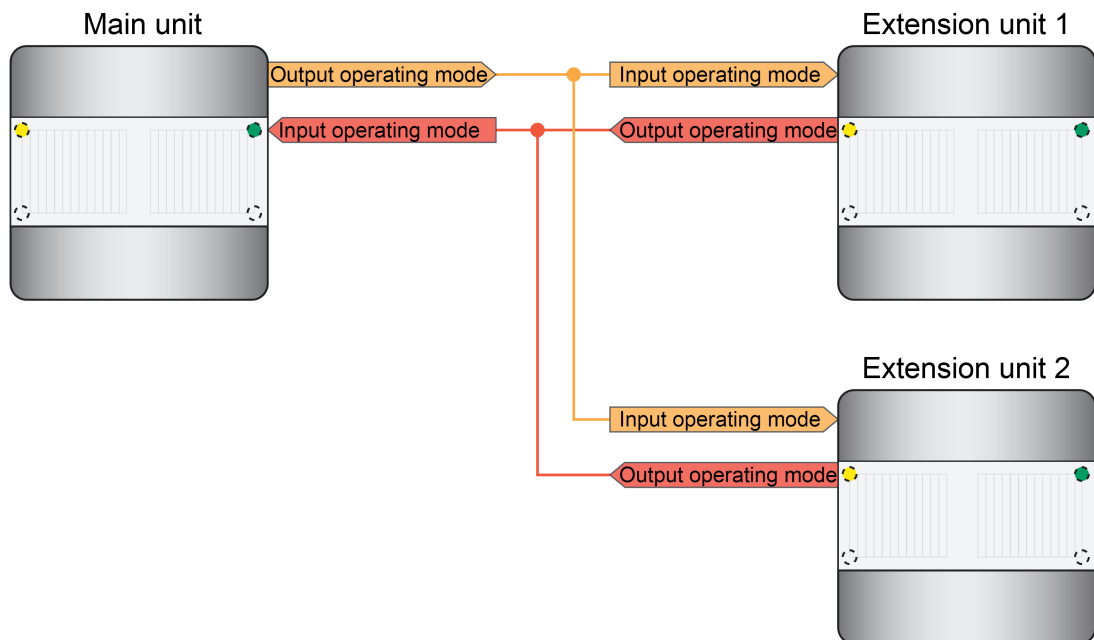

Figure 36: Example of the linking of a main unit with two extensions for operating mode switchover and display

Application case 1: "ON" operating mode specification via extension.

Starting situation: At the time of operation, the system is in the "AUTO" operating mode.

- Extension 1: Local operation, "ON" operating mode.
Extension 1 transmits the "ON" operating mode to the main unit.
- Main unit switches to the "ON" operating mode.
"ON" LED (green) on the main unit is switched on.
Main unit transmits telegrams at the beginning of detection.

Main unit transmits the "ON" operating mode to the extensions.

- Extensions receive the operating mode "ON".
Extensions switch the "ON" LED (green) on.

Application case 2: "AUTO" operating mode specification via extension.

Starting situation: At the time of operation, the system is in the "ON" operating mode.

- Extension 1: Local operation, "AUTO" operating mode.
Extension 1 transmits the "AUTO" operating mode to the main unit.
- Main unit switches to the "AUTO" operating mode.
"ON" LED (green) on the main unit is switched off.
Main unit transmits the "AUTO" operating mode to the extensions.
- Extensions receive the operating mode "AUTO".
Extensions switch the "ON" LED (green) off.

Application case 3: "OFF" operating mode specification via extension.

Starting situation: At the time of operation, the system is in the "AUTO" operating mode.

- Extension 1: Local operation, "OFF" operating mode.
Extension 1 transmits the "OFF" operating mode to the main unit.
- Main unit switches to the "OFF" operating mode.
"OFF" LED (yellow) on the main unit is switched on.
Main unit transmits telegrams at the end of detection.
Main unit transmits the "OFF" operating mode to the extensions.
- Extensions receive the operating mode "OFF".
Extensions switch the "OFF" LED (yellow) on.

Application case 4: "AUTO" operating mode specification via extension.

Starting situation: At the time of operation, the system is in the "OFF" operating mode.

- Extension 1: Local operation, "AUTO" operating mode.
Extension 1 transmits the "AUTO" operating mode to the main unit.
- Main unit switches to the "AUTO" operating mode.
"OFF" LED (yellow) on the main unit is switched off.
Main unit transmits the "AUTO" operating mode to the extensions.
- Extensions receive the operating mode "AUTO".
Extensions switch the "OFF" LED (yellow) off.

4.2.4.3.5 Output functions

Up to two output communication objects are available in the function block via which the switching and control commands are transmitted on the bus to the KNX actuator, e.g. lighting system, room temperature control. Depending on the configured function (switching, staircase function, dimming value transmitter, scene extension, temperature value transmitter, brightness value transmitter, operating mode switchover, switching with forced position), the data format of these objects is defined separately and adapted to the controllable function units of the KNX system.

The functions of the outputs are defined separately on the parameter page "FB1 - General". Depending on the configuration, the available communication objects and output parameters adapt to the parameter pages FB1 - output 1" and "FB1 - output 2". The following functions can be configured...

- "no function":
The output is deactivated. There is no separate output communication object available.
- "Switching":
1-bit switching telegrams (ON / OFF) can be output. Example application: Switching lighting.
- "Staircase function":
1-bit switching telegrams (ON, OFF) are output cyclically in order to trigger the run-on-time in the activated KNX actuator. Example application: Switching staircase lighting
- "Switching with forced position":
2-bit switching telegrams can be output for the forced position of an actuator channel in accordance with DPT 2.001. This makes it possible to set switching states with a higher priority (ON, OFF). Example application: Switching lighting by forced control (cleaning lighting, service light).
- "Dimming value transmitter":
1-byte brightness value telegrams in accordance with DPT 5.001 (0...100 %) can be output. Example application: Dimming lighting.
- "Light scene extension":
1-byte telegrams in accordance with DPT 18.001 (1...64) can be output for the scene recall. Example application: Recall actuator scenes (e.g. TV lighting).
- "Temperature value transmitter":
2-byte temperature value telegrams in accordance with DPT 9.001 (0...+40 °C configurable in 1 °C-increments) can be output. Example application: Preset temperature setpoints.
- "Brightness value transmitter":
2-byte brightness value telegrams in accordance with DPT 9.004 (0...2,000 Lux configurable in 50-Lux increments) can be output. Example application: Preset lighting setpoints.
- "Operating mode room temperature controller":
1-byte telegrams for switching over the operating mode of a KNX room temperature controller in accordance with DPT 20.102 (comfort, standby, night, frost/heat protection, automatic operation) can be output. Example application: Influence room temperature control.

- i In the application type "extension", no output functions are available. Therefore, these are then only configurable in the main unit.
- i In the application "detector", only output 1 is active and preset to the detector function (1-bit switching telegrams).

4.2.4.3.6 Sensor assignment

Assignment of the brightness sensor

To determine the ambient brightness, the device possesses a brightness sensor, located behind the lens. The sensor detects the mixed light of its environment composed of artificial light and daylight. Light measurement occurs in the direction the lens is looking. The brightness value determined by this internal sensor can be supplied to the function block internally for the twilight level evaluation. Optionally, an external 2-byte brightness value in accordance with DPT 9.004 can also be made available to the function block via the bus. This makes it possible to carry out the twilight level evaluation independently of the installation location of the device (e.g. provision of an external brightness value via a more favourably installed extension). In special cases, it is possible to link the determined brightness value of the internal sensor to an external brightness value. In this way, the light measurement of the function block can take place at 2 locations. At the same time, both sensor values are weighted for determining the effective brightness value. The "weighting of the brightness values internal to external" can be configured statically in the ETS.

The parameter "detection of the brightness value by" on the parameter page "FB1 - Sensor assignment" defines which sensors are used for the brightness evaluation of the function block.

- i** The brightness value determined by the internal sensor can be supplied to other KNX bus subscribers via the object "Measured brightness value".
- i** In "external" or "internal and external" brightness value detection: In brightness-dependent motion evaluation, a current brightness value must first be present after a device reset before the function block can work properly. The function block works brightness-independently until a valid brightness value has been received externally! During a weighted brightness value evaluation from an internal and external brightness value, at least one value (internal or external) must be present. No weighting is made as long as only the brightness value of one source is present, but instead the brightness value available is perceived as the effective brightness. If a user calibration of the internal brightness sensor is configured, this must first be executed correctly beforehand so that the internal sensor provides valid brightness values.

4.2.4.3.7 Brightness evaluation

Twilight level evaluation

During the motion detection in the application "detector", the evaluation of the twilight level can take place brightness-independently or brightness-dependently. In the brightness-independent evaluation, no brightness value is taken into account during the processing of a motion. Each motion then triggers a new detection process in the idle state. This configuration, for instance, is interesting for lighting-independent applications (e.g. motion detection for room temperature controls).

In the brightness-dependent evaluation, the measured brightness value in relation to the effective twilight level is taken into account for processing a motion detection. The function block then only detects motions when the measured brightness value is below the set twilight level. This configuration is normally used to control lighting systems in corridors or rooms with some levels of daylight.

The twilight level is preset in the ETS by the parameter of the same name and can be changed by an external twilight level value (via object) or with the Text function in state of operation and thus adapted to the user's needs.

- i** With the "Detector with switch-off brightness", the twilight level is always evaluated according to the brightness.
- i** In the application "detector", the motion detection always works brightness-independently.
- i** In the application "Detector with switch-off brightness", the brightness continues to be evaluated when the lighting is switched on even during active motion detection. If the measured brightness exceeds a defined switch-off threshold derived from the effective twilight level, the lighting is switched off after a configurable delay has elapsed even during an active motion detection operation.

Feedback of active twilight level

The feedback of the twilight level effectively set in the function block is possible via the 2-byte object "Active twilight level" in accordance with DPT 9.004. This object can optionally act as an active signalling object or passive status object. As an active signalling object, the current twilight level brightness value is transmitted once to the bus on each change of the twilight level, after ETS programming or after bus voltage return (optionally delayed).

External twilight level presetting

The currently set twilight level can be reset in accordance with DPT 9.004 in the range 1...1,000 Lux by transmitting a 2-byte brightness value to the object "Twilight level presetting". This object is configurable if the parameter "object 'presetting twilight level'" is set to "enabled" on the parameter page "FB1 - brightness evaluation". The twilight level value received via the object remains unchanged until a new presetting (external twilight level or teach-in function). Even a bus voltage failure will not reset the twilight level value received via the bus. ETS programming resets the twilight level automatically to the ETS presettings if this is intended in the configuration (see below).

- i** The disabling function has no effect on the external twilight level presetting.

Teach function

Another option for the user-guided twilight level adjustment is the Teach function. With the Teach function, the effective brightness value is applied instantly by transmitting a corresponding telegram to the 1-bit object "Teach twilight level" as a new twilight level value. Taught-in brightness values are limited to the measuring range 1...1,000 Lux. This object is configurable if the parameter "Use Teach function?" on the parameter page "FB1 - brightness

evaluation" is set to "yes".

The polarity of a Teach telegram is configurable by the parameter "Polarity for object 'Teach twilight level'". Depending on the configuration, it is possible to reset to the configured twilight level upon receiving the opposite object value (Teach inactive). The twilight level previously learned will be lost in the process. If, however, the Teach polarity is configured to "1"- and "0"-active, it is no longer possible to reset to the configured twilight level via this object during ongoing operation of the device! The new twilight level set with the Teach function remains unchanged until a new presetting (external twilight level or teach-in function). Even a bus voltage failure will not reset the new twilight level value. ETS programming resets the twilight level automatically to the ETS presettings if this is intended in the configuration (see below).

i The disabling function has no effect on the Teach function.

Twilight level with external motion detector

With the application types "single device" and "main unit" an external motion signal can be transmitted to the device (with "single device" e.g. from a pushbutton as trigger of a motion detector / with "main unit" from the extensions). If the twilight level evaluation is configured to "brightness-dependent", the evaluation of the external motion detections can be influenced. The parameter "Evaluation of the twilight level with external motion telegram" (with a single device) or "Evaluation of the twilight level" (with a main unit) on the parameter page "FB1 - brightness evaluation" defines the behaviour on receipt of a motion telegram.

Setting options with a main unit...

- "only in the main unit":
External motion signals are ignored by the main unit if the brightness is above the twilight level.
- "in main unit and extension":
External motion signals are always evaluated by the main unit even if the brightness is above the twilight level.

Setting options with a single device.

- yes (brightness dependent operation)
External motion signals are ignored if the brightness is above the twilight level.
- no (brightness independent operation)
External motion signals are always evaluated even if the brightness is above the twilight level.

i During a brightness-independent twilight level evaluation, the external motion detections in a single device or main unit are always evaluated.

i In the application type "extension", it is not possible to supply external motion detections to the device for implementing a manual operation (e.g. by means of a pushbutton). This is then only possible on the main unit.

Twilight level with ETS programming

The parameter "Overwrite twilight level in device for ETS-download?" determines whether an actively set and active twilight level value by previous external object presetting or by Teach is overwritten automatically by the twilight level configured in the ETS during ETS programming. If the setting is "yes", the last value preset externally or by Teach and still active is replaced by the ETS presetting. If the setting is "no", the last twilight level preset externally or by Teach still remains active even after ETS programming.

- i** If the parameter "Overwrite twilight level in device for ETS-download?" is set to "no" and no external presetting has been made yet - if provided for in the configuration - via the 2-byte object or by Teach after the first ETS commissioning, the device always works with the value configured in the ETS. The ETS parameter only becomes invalid within the above configuration after an external presetting or after a Teach.

Switch-over of the twilight level evaluation in brightness-independent operation

It is possible to switch the twilight level evaluation off and on again via the 1-bit object "Deactivation of twilight level" during ongoing operation of the device. When using main units and extensions, the use of this object is fundamental in order to be able to switch the main units to brightness-independent operation for output functions that are unlike the 1-bit data format. Thus, a distinction must be made between the application types when projecting the object.

- Application type "single device":
The object "Deactivation of twilight level" is an input. A "1" telegram deactivates the twilight level. A "0" telegram re-enables the twilight function evaluation.
After switching over to brightness-independent operation via the object, the application does not switch over again automatically to brightness-dependent operation at the end of a motion detection as would be the case in brightness-independent operation.
- Application type "Main unit":
The object "Deactivation of twilight level" is an input and output.
Use as input: A "1" telegram deactivates the twilight level. A "0" telegram re-enables the twilight function evaluation. After switching over to brightness-independent operation via the object, the application does not switch over again automatically to brightness-dependent operation at the end of a motion detection as would be the case in brightness-independent operation.
Use as output: The main unit controls the switch-over of the twilight level evaluation of the extension(s) via this output depending on its own twilight level evaluation. The application examples in this documentation show this more precisely.
Combined use of the object as input and output: If the main unit is switched over to brightness-independent operation (use as input), the object "Deactivation of twilight level" does not control the twilight level evaluation of the extension(s) anymore (output function deactivated). No telegrams are then transmitted automatically anymore from the main unit until it is switched back to brightness-dependent operation! To ensure that the main unit and extension(s) function correctly during switch-over of the main unit to brightness-independent operation, the extension(s) must also be switched over simultaneously to brightness-independent operation via the object "Deactivation of twilight level".
- Application type "Extension":
The object "Deactivation of twilight level" is an input. A "1" telegram deactivates the twilight level. A "0" telegram re-enables the twilight function evaluation.

4.2.4.3.8 Manual operation

The actuator activated by the device can always be operated manually via a KNX pushbutton as well. Since these manual operations cannot be detected by the device, undesirable effects may result in brightness-dependent detection operation.

Example: No motion is detected by manually switched-on lighting because the twilight level is permanently exceeded. As a result, no automatic switch-off by the device takes place either. To prevent this problem, the function blocks in the application types "single device" or "main unit" for manual, external operation provide the 1-bit object "Lighting manual ON/OFF". A manual operation via this object is detected by the device and processed accordingly.

Manual operation in the "Detector" and "Detector with switch-off brightness" application.

The function of the manual operation is dependent on the configured operating mode...

- Operating mode "Fully automatic (Auto ON, Auto OFF)":
ON telegram to the object "Lighting manual ON/OFF" -> Output 1 and 2 - if configured - transmit the configured telegrams brightness-independent for "beginning of detection" (transmission is forced, an evaluation delay is not taken into account). Additionally, a current motion is simulated thus starting the configured transmission delay. The function block now works like after a detected motion.
Special detector behaviour: If no further motion is detected, the device transmits the configured telegrams at the "end of the detection" via outputs 1 and 2 after the transmission delay has elapsed (automatic switch-off). New motion detections retrigger the transmission delay.
Special behaviour of detector with switch-off brightness: If no further motion is detected, the device transmits the configured telegrams at the "end of the detection" via outputs 1 and 2 after the transmission delay has elapsed. New motion detections retrigger the transmission delay. If the switch-off brightness is permanently exceeded when a motion is present, the device transmits the configured telegrams at the "end of the detection" via the outputs 1 and 2 after the configured switch-off delay.

ON telegram to the object "Lighting manual ON/OFF" -> Output 1 and 2 - if configured - always transmit the configured telegrams brightness-independent at the "end of the detection". An active motion detection is deleted. After the configured lockout time, the function block is then ready for a new motion detection.

- Operating mode "semi-automatic I (manual ON, Auto OFF)":
ON telegram to the object "Lighting manual ON/OFF" -> Output 1 and 2 - if configured - transmit the configured telegrams brightness-independent for "beginning of detection" (transmission is forced, an evaluation delay is not taken into account). Additionally, a current motion is simulated thus starting the configured transmission delay. Motion detection is enabled. The function block now works like after a detected motion. If no further motion is detected, the device transmits the configured telegrams at the "end of the detection" via outputs 1 and 2 after the transmission delay has elapsed (automatic switch-off). New motion detections retrigger the transmission delay.
Special behaviour of detector with switch-off brightness: If the switch-off brightness is permanently exceeded when a motion is present, the device transmits the configured telegrams at the "end of the detection" via the outputs 1 and 2 after the configured switch-off delay. After the end of the motion detection (telegrams were transmitted at the end of the detection), motion detection is disabled.

ON telegram to the object "Lighting manual ON/OFF" -> Output 1 and 2 - if configured - always transmit the configured telegrams brightness-independent at the "end of the detection". An active motion detection is deleted and disabled. The function block must first be activated via an ON telegram to the object "Lighting manual ON/OFF" for a new motion detection.

- Operating mode "semi-automatic II (Auto ON, manual OFF)":
ON telegram to the object "Lighting manual ON/OFF" -> Output 1 and 2 - if configured - transmit the configured telegrams brightness-independent for "beginning of detection" (transmission is forced, an evaluation delay is not taken into account). Additionally, a current motion is simulated, but the transmission delay is not started in this operating mode! To complete the current motion detection and transmit the telegrams at the "end of the detection" via the outputs 1 and 2, an OFF telegram must be transmitted to the object "Lighting manual ON/OFF".

ON telegram to the object "Lighting manual ON/OFF" -> Output 1 and 2 - if configured - always transmit the configured telegrams brightness-independent at the "end of the detection". An active motion detection is deleted. After the configured lockout time, the function block is then ready for a new motion detection.

4.2.4.3.9 Application examples

Single device for lighting control with external motion detection

Application example:

Pushbutton on the entrance door of a storage room outside the detection field of the device. When entering the room, the lighting should be switched on user-guided even before the PIR detection area is entered.

Alternative application:

Central switch-on of the lighting devices in an office building in the case of service or cleaning. Automatic switch-off if there are no more motion detections.

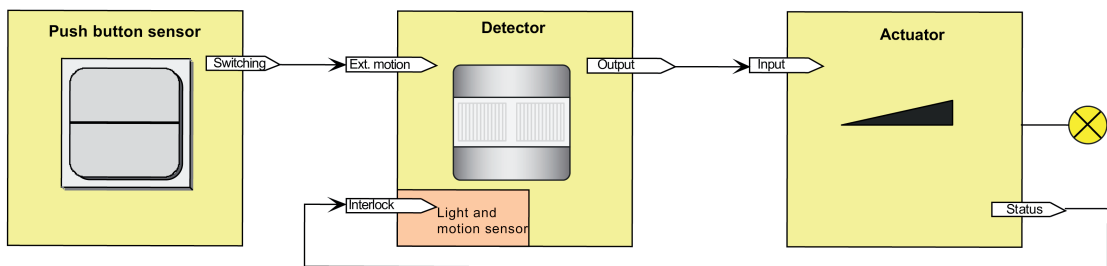

Figure 37: Application example of single device with external motion detection

Depending on the parameter setting "Evaluation of the twilight level with external motion telegram", the signal of the pushbutton is evaluated brightness-dependently (evaluation of the configured twilight level) or brightness-independently. In both cases, the switched-on lighting is switched off again automatically at the end of the motion detection (with appropriate configuration).

Main unit and extension arrangement for lighting control without twilight level evaluation

Application example:

Lighting is to be activated in a room without daylight.

Configuration Main unit:

Evaluation of twilight level = brightness-independent

Configuration Extension:

Evaluation of twilight level = brightness-independent

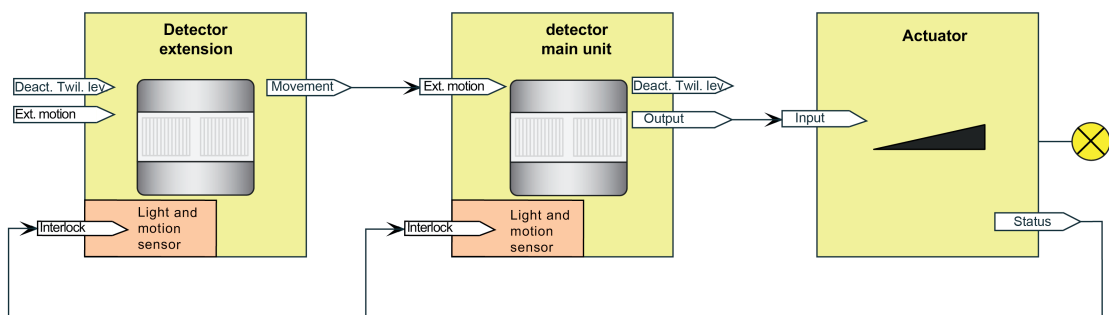

Figure 38: Application example of main unit and extension without twilight level evaluation

The system is configured so that no twilight level evaluation takes place. Consequently, each motion detection of the main unit and extension always results in a telegram output or

retriggering of the transmission delay in the main unit.

Main unit and extension arrangement for lighting control with twilight level evaluation in the main unit

Application example:

Detector main unit with one or more detector extensions in a passageway area with daylight. The main unit is mounted optimally so that the daylight can be detected reliably via the brightness sensor of the device. The main unit is mounted optimally so that the daylight can be detected reliably via the brightness sensor of the device. A brightness evaluation on the extensions is not necessary.

Configuration Main unit:

Evaluation of twilight level = brightness-dependent

Evaluation of the twilight level only in the main unit

Configuration Extension:

Evaluation of twilight level = brightness-independent

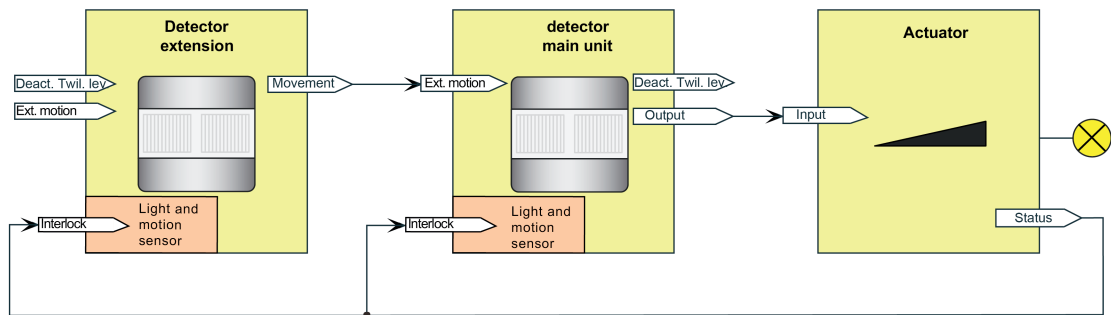

Figure 39: Application example of main unit and extension with twilight level evaluation in the main unit

The system is configured so that the brightness in the room is only detected at the location of the main unit and compared with the twilight level set there. The brightness conditions on the extensions are irrelevant for the control of the lighting conditions. The external motion detection is subject to the twilight level evaluation of the main unit. If it is bright enough on the main unit, motion telegrams of the extensions are discarded. Ideally, the extensions work brightness-independently.

Main unit and extension arrangement for lighting control with twilight level evaluation in the main unit and in all extensions.

Application example:

Detector main unit with one or more detector extensions in a staircase or large storage room with various daylight conditions. The devices are mounted on different floors or in different room areas and detect the daylight condition independently of each other.

Configuration Main unit:

Evaluation of twilight level = brightness-dependent

Evaluation of the twilight level in main unit and extension

Configuration Extension:

Evaluation of twilight level = brightness-dependent

The system is configured so that motion as well as brightness are detected and evaluated at every location (main unit and extensions). The distributed brightness measurement and brightness evaluation is used for controlling the lighting conditions. The motion detectors of the extensions are not subject explicitly to the twilight level evaluation of the main unit only. Thus, each motion telegram results in the triggering of a telegram at the beginning of the detection or in the retriggering of the transmission delay.

In this application example, the twilight level must be controlled between the main unit and extensions. After detection of a motion (regardless of the position) and the resultant switching on of the lighting, the twilight level evaluation must take place brightness-independently until the additional transmission delay has elapsed in the main unit and in all extensions. This ensures that longer-lasting motion processes can still be detected further on by all extensions whereby the retriggering of the transmission delay can take place in the main unit. For this purpose, the main unit must set the twilight levels to "brightness-independent" in the extensions at the beginning of a detection and reset them to "brightness-dependent" after the additional transmission delay has elapsed.

The control of the twilight levels in the extensions must take place differently depending on the configured output function. This is shown by the following application examples...

Example of Output Function "Switching" (KNX Master Slave Solution 1)

In this example, the twilight level evaluation of the extensions is deactivated and activated by the switching output telegram of the main unit. The objects "Deactivation of twilight level" of the extensions can be linked to the same group address as the object "Output x - switching" of the main unit.

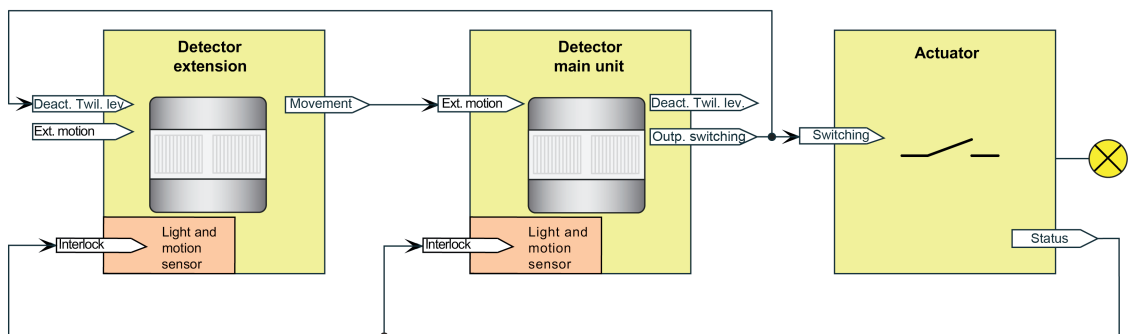

Figure 40: Application example with twilight level evaluation in the main unit and extensions for the data format "Switching"

Case A - Motion is detected by the main unit:

Beginning of the detection: After a motion is detected by the main unit, it transmits an ON telegram to the switch actuator if the twilight level is fallen below so that the lighting is switched on. All extensions receive this ON telegram on their input "Deactivation of twilight level" whereby the extensions switch over to the brightness-independent motion detection and are thus able to detect artificial light if it is now switched on in their own detection area.

End of the detection: After the additional transmission delay has elapsed in the main unit, it transmits an OFF telegram to the switch actuator so that the lighting is switched off. All extensions receive this OFF telegram on the input "Deactivation of twilight level" whereby they switch over again to brightness-dependent motion detection.

Case B - Motion is detected by an extension:

Beginning of the detection: After a motion is detected by an extension, it transmits motion telegrams cyclically to the main unit via the object "Motion" if the twilight level is fallen below. The main unit evaluates the external motion and transmits an ON telegram to the switch actuator so that the lighting is switched on. All extensions receive this ON telegram on their input "Deactivation of twilight level" whereby all extensions switch over to the brightness-independent motion detection and are thus able to detect artificial light if it is now switched on in their own detection area.

End of the detection: If no motion is detected anymore by an extension within its own detection area, the device concerned no longer transmits any motion telegrams to the main unit. As soon as each of the extensions no longer detect motion, motion telegrams are completely absent. The main unit detects the absence of the external motion telegrams and starts the additional transmission delay. After the additional transmission delay has elapsed, the main unit transmits an OFF telegram to the switch actuator, whereby the lighting is switched off. All extensions receive this OFF telegram on the input "Deactivation of twilight level" whereby they switch over again to brightness-dependent motion detection.

Case C - Interlock of the motion evaluation:

When switching off the lighting, it is necessary to interlock the PIR sensor for a certain period of time. It is necessary to prevent incorrect motion detection as a result of thermal change from switching the lamps on and off. The connection of the 1-bit switching status feedback object of the switch actuator (in the case of several activated actuators, only one actuator should ever transmit the status) with the objects "Interlock PIR sensor" of the main unit and extensions serves to activate the lockout time when switching the lighting on or off. The connected actuator must transmit its status actively on change.

Option: If no switching status feedback object is present on the switch actuator, the output object "Switching" of the main unit must be connected with the interlock objects.

Example of output functions "Switching", "Switching with forced position", "Dimming value transmitter", "Light scene extension" and "Brightness value transmitter" (general solution for the lighting control)

In this example, the twilight level evaluation of the extensions is deactivated and activated by the main unit via the object "Deactivation of twilight level". This data format-independent universal solution is not only restricted to the output function Switching. A separate group address must be used for the twilight level control.

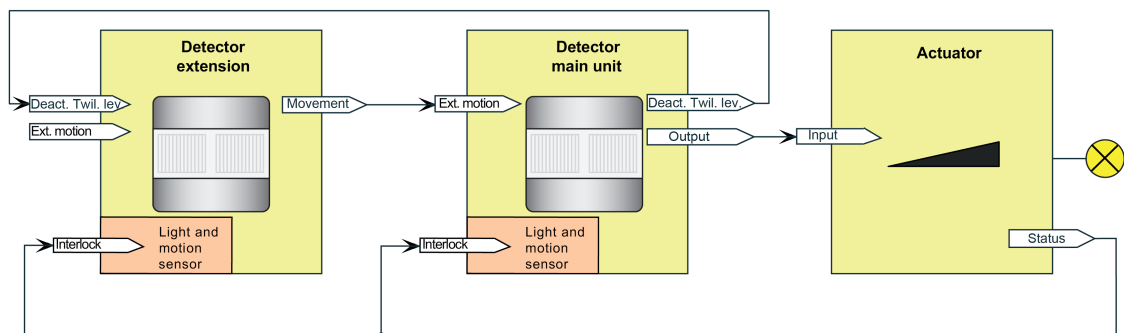

Figure 41: Application example with twilight level evaluation in the main unit and extensions
Universal solution for all data formats

Case A - Motion is detected by the main unit:

Beginning of the detection: After a motion is detected by the main unit, it transmits an ON telegram to the switch actuator via the output object if the twilight level is fallen below so that the lighting is switched on. Additionally, the main unit transmits an ON telegram to all extensions via the object "Deactivation of twilight level" whereby these switch over to the brightness-independent motion detection and are thus able to detect artificial light if it is now switched on in their own detection area.

End of the detection: After the additional transmission delay has elapsed in the main unit, it transmits an OFF telegram to the switch actuator via the output object so that the lighting is switched off. Additionally, it transmits an OFF telegram to all extensions via the object "Deactivation of twilight level", whereby they switch over again to brightness-dependent motion detection.

Case B - Motion is detected by an extension:

Beginning of the detection: After a motion is detected by an extension, it transmits motion telegrams cyclically to the main unit via the object "Motion" if the twilight level is fallen below.

The main unit evaluates the external motion and transmits an ON telegram to the switch actuator via the output object so that the lighting is switched on. Additionally, the main unit transmits an ON telegram to all extensions via the object "Deactivation of twilight level" whereby these switch over to the brightness-independent motion detection and are thus able to detect artificial light if it is now switched on in their own detection area.

End of the detection: If no motion is detected anymore by an extension within its own detection area, the device concerned no longer transmits any motion telegrams to the main unit. As soon as each of the extensions no longer detect motion, motion telegrams are completely absent.

The main unit detects the absence of the external motion telegrams and starts the additional transmission delay. After the additional transmission delay has elapsed, the main unit transmits an OFF telegram to the switch actuator via the output object, whereby the lighting is switched off. Additionally, the main unit transmits an OFF telegram to all extensions via the object "Deactivation of twilight level", whereby they switch over again to brightness-dependent motion detection.

Case C - Interlock of the motion evaluation:

When switching off the lighting, it is necessary to interlock the PIR sensor for a certain period of time. It is necessary to prevent incorrect motion detection as a result of thermal change from switching the lamps on and off. For this purpose, the activated actuators must have a 1-bit switching status feedback object. The connection of the switching status feedback object of the actuator (in the case of several activated actuators, only one actuator should ever transmit the status) with the objects "Interlock PIR sensor" of the main unit and extensions serves to activate the lockout time when switching the lighting on or off. The connected actuator must transmit its status actively on change.

- i** The main unit transmits the telegrams via the object "Deactivation of twilight level" even if the twilight level evaluation is set to brightness-independent.

Example of Output Function "Staircase function" (KNX Master Slave Solution 2)

In the Staircase function, the run-on time (staircase time) of the lighting is configured in the KNX actuator. In this case, the main unit transmits ON telegrams cyclically to the actuator to switch on the lighting for the duration of the motion. If no motion is detected anymore, the main unit transmits no more telegrams to the actuator. In the absence of the ON telegrams, the run-on-time in the actuator is no longer retriggered. After the run-on time has elapsed, the actuator switches off the lighting again.

Even with the output function "staircase function", the twilight level must be controlled between main unit and extension(s). This takes place differently to the previous application examples of other output functions. The twilight level is deactivated and activated in the extension(s) via the object "External motion" whereby the cyclical ON telegrams of the main unit are received. These telegrams are not evaluated as motion, however, but are used for the switch-over of the twilight level evaluation. During the receipt of the cyclical ON telegram, the twilight level evaluation is deactivated. If the ON telegrams of the main unit are absent during the run-on-time, the extensions reactivate the twilight level evaluation. Thus, it is necessary for the extensions to be informed about the actuator run-on time.

For this purpose, the extensions must be configured to the same run-on-time as the actuator. This is possible in each extension, firstly by setting the parameter "Main unit 'staircase function' with run-on time in the actuator?" on the parameter page - "FBx - End of detection" to "yes" and then configuring the parameter "Additional transmission delay" to the necessary run-on-time". Each ON telegram of the main unit retriggers the run-on-time in the extensions.

- i** The configured "additional transmission delay" in the main unit and extensions must be identical and match the run-on time in the actuator so that the twilight level control functions error-free. No "Adaptive additional transmission delay" and no time extension should be configured in the main unit.
- i** The receipt of an "OFF telegram" via the object "External motion" results in the direct activation of the twilight level evaluation (brightness dependent operation) in the extensions.

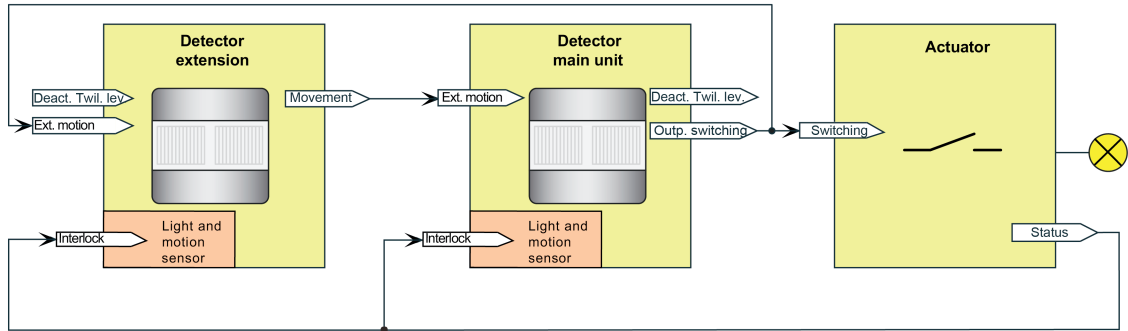

Figure 42: Application example with twilight level evaluation in the main unit and extensions for output function "Staircase function"

Case A - Motion is detected by the main unit:

Beginning of the detection: After a motion is detected by the main unit, it transmits ON telegrams cyclically (cycle time = parameter "Time for cyclical transmission") to the switch actuator via the output object if the twilight level is fallen below so that the lighting is switched on. All extensions also receive these ON telegrams on their input "External motion" whereby these switch over to the brightness-independent motion detection and are thus able to detect artificial light if it is now switched on in their own detection area.

End of the detection: Once the transmission delay has elapsed after the last detected motion, the main unit transmits no ON telegram to the switch actuator anymore so that the lighting is switched off (transmission delay = run-on time of the actuator). In the absence of motion detections in the form of ON telegrams, the extensions change back to brightness-dependent motion detection again.

Case B - Motion is detected by an extension:

Beginning of the detection: After a motion is detected by an extension, it transmits motion telegrams cyclically to the main unit via the object "Motion" if the twilight level is fallen below. The main unit evaluates the external motion and transmits ON telegrams cyclically to the switch actuator via the output object so that the lighting is switched on. All extensions also receive these ON telegrams on their input "External motion" whereby these switch over to the brightness-independent motion detection and are thus able to detect artificial light if it is now switched on in their own detection area.

End of the detection: If no motion is detected anymore by an extension within its own detection area, the device concerned no longer transmits any motion telegrams to the main unit. As soon as each of the extensions no longer detect motion, motion telegrams are completely absent. The main unit detects the absence of the external evaluation telegrams once the configured transmission delay has elapsed after the last detected motion detection and transmits no ON telegram to the switch actuator anymore so that the lighting is switched off after the staircase time in the actuator has elapsed (transmission delay = run-on time of the actuator). In the absence of motion detections in the form of ON telegrams, the extensions change back to brightness-dependent motion detection again.

Case C - Interlock of the motion evaluation:

When switching off the lighting, it is necessary to interlock the PIR sensor for a certain period of time. It is necessary to prevent incorrect motion detection as a result of thermal change from switching the lamps on and off. For this purpose, the activated actuators must have a 1-bit switching status feedback object. The connection of the switching status feedback object of the actuator (in the case of several activated actuators, only one actuator should ever transmit the status) with the objects "Interlock PIR sensor" of the main unit and extensions serves to activate the lockout time when switching the lighting on or off. The connected actuator must transmit its status actively on change.

Main unit and extension arrangement for controlling lighting-independent systems without twilight level evaluation

Application example:

In the lighting-independent output functions, the motion detection in the main units and extensions is normally brightness-independent. Detector main unit with one or more detector extensions in an office with different daylight conditions. The devices detect the daylight condition independently of each another.

Configuration Main unit:

Evaluation of twilight level = brightness-independent

Evaluation of the twilight level in main unit and extension

Configuration Extension:

Evaluation of twilight level = brightness-independent

The system is configured so that motion as well as brightness are detected and evaluated at every location (main unit and extensions). The distributed brightness measurement and brightness evaluation is used for controlling lighting-independent systems (e.g. room temperature control -> operating mode switchover, setpoint presetting). The motion detectors of the extensions are not subject explicitly to the twilight level evaluation of the main unit only. Thus, each motion telegram results in the triggering of a telegram at the beginning of the detection or in the retriggering of the transmission delay.

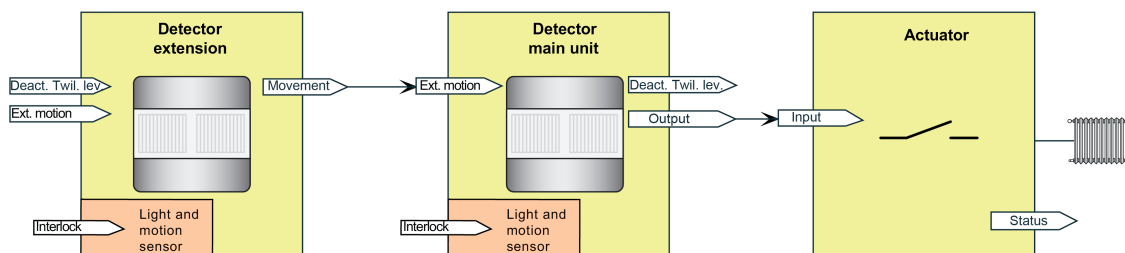

Figure 43: Application example without twilight level evaluation in the main unit and extensions for output functions "temperature value transmitter" and "operating mode room temperature controller"

Case A - Motion is detected by the main unit:

Beginning of the detection: After the main unit detects a motion, it transmits the telegram to the controller or actuator at the beginning of the detection and triggers actions accordingly (e.g. comfort mode, raised setpoint).

End of the detection: After the additional transmission delay has elapsed in the main unit, it transmits the telegram to the controller or actuator at the end of the detection and retriggers actions (e.g. standby mode, lowered setpoint).

Case B - Motion is detected by an extension:

Beginning of the detection: After a motion is detected by the extension, it transmits motion telegrams cyclically to the main unit via the object "Motion". This detects the external motion and transmits the telegram to the controller or actuator at the beginning of the detection and triggers actions accordingly (e.g. comfort mode, raised setpoint).

End of the detection: If no motion is detected anymore by an extension within its own detection area, the device concerned no longer transmits any motion telegrams to the main unit. As soon as each of the extensions no longer detect motion, motion telegrams are completely absent. The main unit detects the absence of the external motion telegrams and starts the additional transmission delay. After the additional transmission delay has elapsed, the main unit transmits the telegram to the controller or actuator at the end of the detection and triggers actions (e.g. standby mode, lowered setpoint).

4.2.4.3.10 Behaviour at the beginning of a detection

Total motion

A total motion is defined as the time period from the start of the first detection impulse of the PIR sensor (Beginning of the detection) plus the total delay, which is also frequently called run-on-time. The total delay consists of the standard delay (10 seconds) that is always present, which starts immediately after the last active motion signal, and the additional transmission delay that is configurable in the ETS and can optionally be extended via bus telegram. If configured in the ETS, an evaluation delay at the beginning of the detection can be set in order to ignore brief motions.

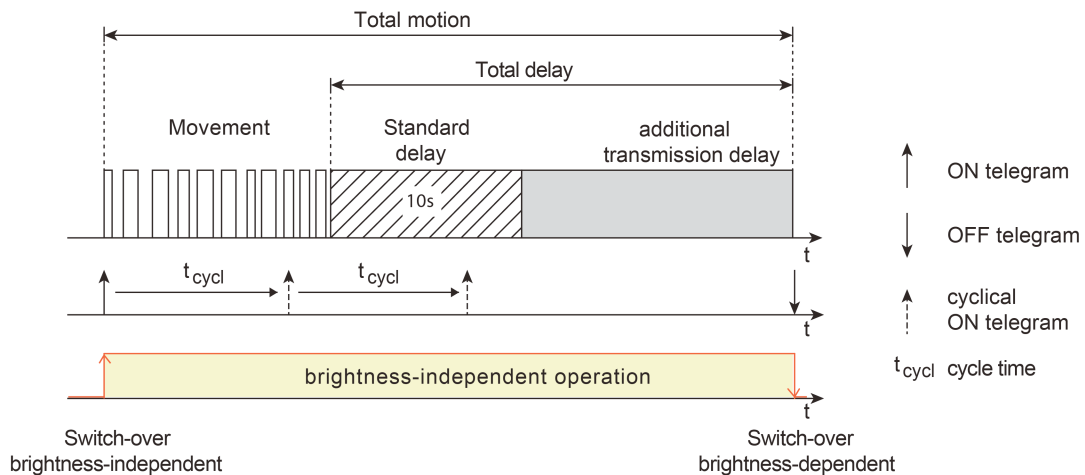

Figure 44: Total motion with motion detection, standard delay and additional transmission delay

Telegrams can be transmitted at the beginning, during and at the end of a motion detection. During a motion detection, the function block concerned is always in brightness-dependent operation in relation to the twilight level. Thus, regardless of the ambient brightness and provided that the switch-off brightness (only with "Detector with switch-off brightness") was not exceeded, the total delay is retriggered for each new motion detection.

It should be noted that the function block is always switched over to brightness-dependent operation at the end of a detection if the twilight level is not set to brightness-independent. Thus, special care should be taken since no motion detections will take place anymore if the ambient brightness is constantly above the twilight level at the end of the detection due to a switched-on light.

Telegram output during a motion detection

The behaviour of outputs 1 and 2 during detection of a motion, depending on the configured output function, can be configured separately. In the ETS on the parameter pages of the outputs, it is possible to define for each output whether a new telegram should be transmitted to the bus at the beginning of a new motion detection. The corresponding commands (e.g. switching commands or brightness values) are then configurable depending on the set function. If a telegram should be transmitted at the beginning of a detection, the cyclical transmission during the ongoing motion detection or triggering of a telegram can be configured optionally when retriggering (see below).

The evaluation delay can be configured to prevent the transmission of telegrams for brief motion detections. This makes it possible to transmit the telegrams from output 1 and 2 only during a long longer-lasting motion.

During a motion detection, the cyclical transmission or triggering of a telegram when retriggering can be configured alternatively together...

- **Cyclical transmission:**
 Setting the parameter "Cyclical transmission during the detection?" to "yes", activates the cyclical telegram output during a motion detection. The cyclical output only occurs during detected heat motions and within the standard delay. During an active additional transmission delay, no cyclical transmission takes place.
 If the device detects a new motion again (retriggering) during an ongoing additional transmission delay, the standard delay is restarted and the cyclical telegram output is either resumed (if the last cycle time has not yet elapsed after the previous telegram), or restarted by immediate transmission (if the last cycle time has already elapsed).
 The parameter "time for cyclical transmission" defines the time interval of the telegrams.

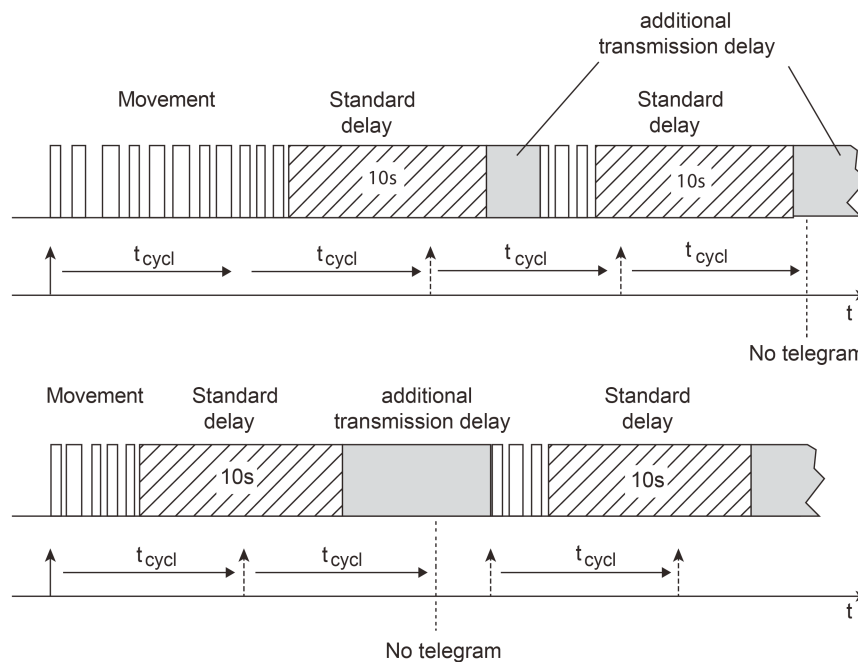

Figure 45: Cyclical transmission during a motion detection

- **Triggering of a telegram when retriggering:**
 If the cyclical transmission is not activated, an output can repeat the telegram at the beginning of the transmission when retriggering. Retriggering takes place when the device detects a new motion during an ongoing additional transmission delay. No telegram is transmitted when retriggering during the standard delay!
 The triggering of a telegram when retriggering is activated in the ETS by the parameter of the same name.

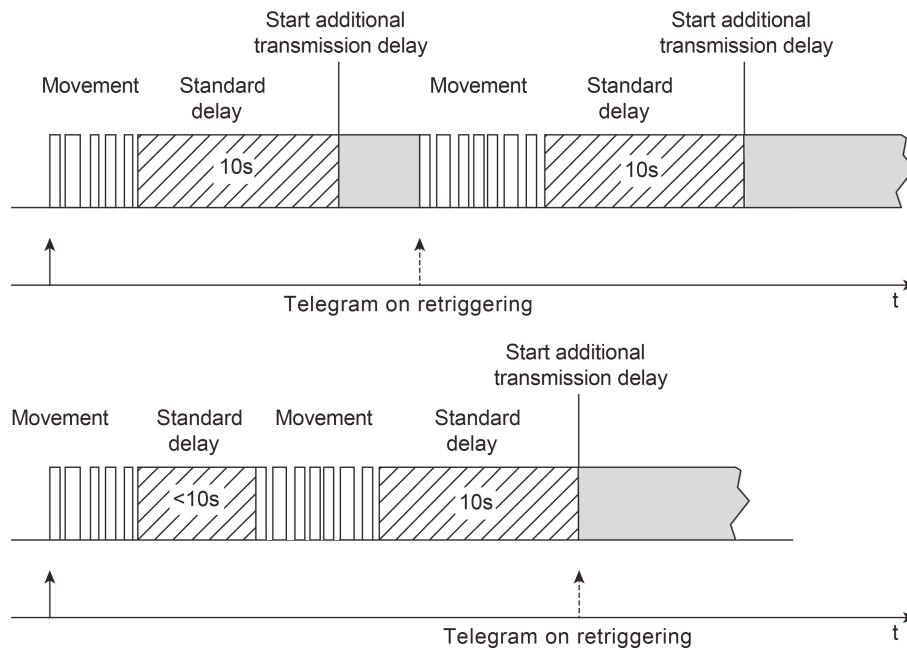

Figure 46: Triggering of a telegram when retriggering

Evaluation delay

The evaluation delay at the beginning of a motion detection ensures that no reaction to just a brief motion (e.g. when quickly striding through a room) takes place. The motion is only processed during a longer-lasting detection and - if configured - the telegram is transmitted at the beginning of the detection. During the detection of the first motion impulse of a new motion, the configured delay time of the transmission delay is initially started. After the delay time has elapsed, a check takes place within a time frame of 30 seconds to determine whether a motion is still present. If an ongoing motion is detected within this monitoring time, the telegram is then transmitted at the beginning of the detection and the transmission delay (possibly retriggering + standard delay 10 s + additional transmission delay) is started.

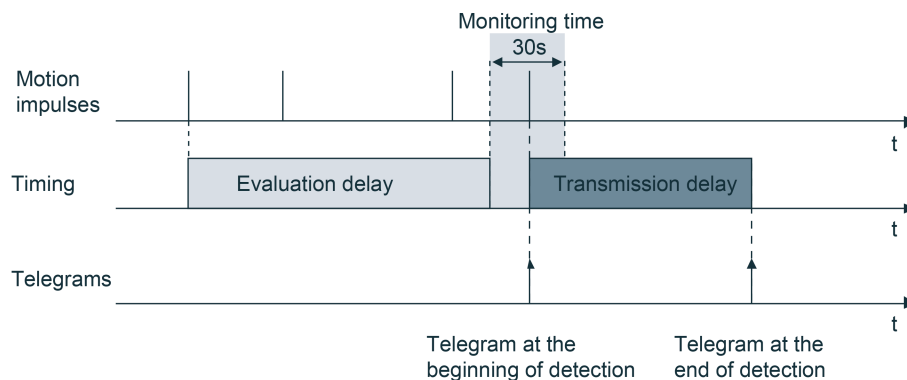

Figure 47: Evaluation delay with ongoing motion

If no motion is detected anymore within the monitoring time, the device transmits no telegram and does not start the standard delay and additional transmission delay either. A newly detected motion after that restarts the evaluation delay.

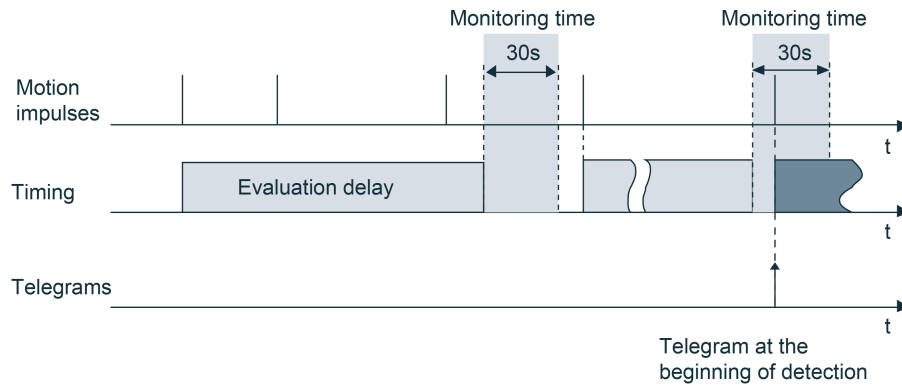

Figure 48: Evaluation delay with only brief motion

- i** The evaluation delay always affects both outputs together as well as external motion detectors.
- i** An evaluation delay is not possible in the operating mode "semi-automatic I (manual ON, Auto OFF)" and in alert operation.

Motion evaluation in alert operation

In the application "detector" the number of motion impulses can be specified within a monitoring time, whereby it is possible to adapt the motion evaluation to individual requirements. In alert operation, the device reacts less sensitively to detected motions since a message telegram is only transmitted via the output object after repeatedly polling the motion signal. The configurable number of motion impulses that can occur within a selectable monitoring period is the criterion for triggering a message telegram. A message telegram can be output at the beginning or end of an identified motion.

The diagram below shows the behaviour of a function block in the application detector. In the example, the number of motion impulses was set to "4".

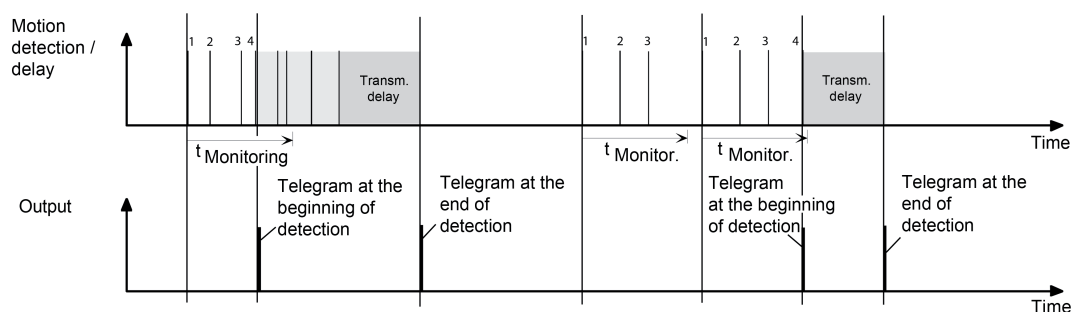

Figure 49: Motion evaluation with the detector

After detection of the fourth motion impulse in the monitoring period ($t_{\text{monitoring}}$), the message telegram "at the beginning of the detection" is transmitted and the transmission delay is started. Further motion impulses within the transmission delay induce the retriggering of the transmission delay. In the absence of motion signals and after the transmission delay has

elapsed, the message telegram "at the end of the detection" is transmitted.

If less than 4 motion impulses are detected within the monitoring period, no message telegram is triggered. After the monitoring period has elapsed, the next motion impulse is the first of a new monitoring period. When a detection begins (start of the transmission delay), the monitoring period is stopped and reset. The monitoring is restarted again with the first motion impulse after the transmission delay has elapsed.

- i A cyclical telegram repetition or the triggering of a telegram when retriggering during an active motion detection is also possible in alert operation.

4.2.4.3.11 Behaviour at the end of a detection

Telegram output at the end of the detection

Just like at the beginning of a detection, a telegram output can be configured for the end of a detection according to the output functions for the outputs 1 and 2. The end of a detection is identified when motion signals are absent and after the total transmission delay elapses (standard delay 10 seconds + additional transmission delay) or when a configured switch-off brightness is exceeded permanently (only with "Detector with switch-off brightness").

Additional transmission delay

A total motion always ends after the standard delay and additional transmission delay elapses. The standard delay time is preset to 10 seconds. The additional transmission delay is added to this time.

The additional transmission delay can either be set discretely by parameter in the ETS, or alternatively, calculated by the device by means of self-learning. The parameter "Type of additional transmission delay" on the parameter page "FBx - End of detection" defines how the additional transmission delay is determined...

- Setting "by parameter":

The additional transmission delay is configured in the ETS. Optionally, the time defined there can be extended by a 1-byte factor received via the bus. This makes it possible to dynamically adapt the additional transmission delay user-defined via the bus.

The time extension is possible when the parameter "Time extension for additional transmission delay" is set to "Factor via object". In this case, the device evaluates the value of the object "Factor additional transmission delay" (DPT 5.010) and calculates the additional transmission delay (received factor x configured time).

A newly received factor is first applied actively after a restart or when retriggering the transmission delay. Thus, the time of an ongoing transmission delay is not influenced immediately by a newly received factor. If the function block is inactive when a new factor is received (e.g. disabling function active, deactivated by the function block switch-over, walking test active), the value received is evaluated later during activation of the function block. After ETS programming or after bus voltage return, the device always works with the factor "1" (-> additional transmission delay = parameter value) until an object value is received.

- Setting "adaptive":
With this setting, the device determines the additional transmission delay independently, depending on the frequency of the motion impulses within a range defined by the user. The adaptive adjustment should be selected if the objectives and tasks listed below are to be fulfilled using the device (optimization strategies)...

- Increased user comfort & lamp protection: A high level of user comfort can be achieved if constant switching off and on again is avoided. The maximum transmission delay possible guarantees the best comfort here. An adaptive additional transmission delay makes it possible for the device to incorporate recurring motion signals into the calculation of the transmission delay during a motion evaluation and thus prevent the lighting from being switched off too early. If light bulbs are frequently switched off and on again, this often additionally reduces their service life. The maximum transmission delay possible guarantees long service life of the light bulbs.

- Energy efficiency: It is always possible to control the lighting or load in an energy-efficient manner when the switch-on time, which is directly is proportional to the consumed energy, can be minimized adequately. The device is able to identify recurring brief motion detections, while keeping the delay-time to a minimum without any loss in comfort.

The device always calculates the additional transmission delay dynamically during an adaptive adjustment. In this case, no constant value can be derived by the user. In reality, the additional transmission delay is adjusted constantly and attuned to the frequency of the motion signals. While doing so, the device only extends the time during a motion evaluation. The delay is only reduced internally if no motion evaluation takes place.

The limits of the dynamic time adjustment can be configured in the ETS. In the case of adaptive adjustment, the parameters "minimum additional transmission delay" and "maximum additional transmission delay" are provided for this purpose. The self-learning behaviour can either be forced more in the direction of user-comfort / lamp protection or energy efficiency by means of a specific parameter setting of the minimum and maximum value. The dynamic range selected for these optimization strategies should be as narrow as possible. If the user or installation engineer does not want to or cannot do this, the dynamic range should alternatively be defined as wide as possible. In the optimization that is then fully automatic, the device can adapt optimally to the current motion pattern.

Applicable for the total delay: $T_{min.} \leq T_{dyn.} \leq T_{max.}$
 $T_{min.}$ = Standard delay (10 s) + "Minimum additional transmission delay"
 $T_{max.}$ = Standard delay (10 s) + "Maximum additional transmission delay"
 $T_{dyn.}$ = dynamically determined additional transmission delay

The table below shows how the limits of the minimum and maximum values should be selected depending on the desired optimization strategy...

Optimization strategy	Minimum additional transmission delay	Maximum additional transmission delay	Dynamic range
User comfort / Lamp protection	high	high	narrow
Energy efficiency	low	low	narrow
none (fully automatic adjustment)	low	high	wide

Parameter setting for the different optimization strategies

The device has an early switch-off detector during the adaptive adjustment of the additional transmission delay. In this process, the device evaluates the time interval between the end of a previous detection (OFF) and the beginning of a new motion evaluation (ON). If the time between switch OFF and switch ON again is shorter than 10 seconds, the transmission delay

last calculated is evaluated as "too short to calculate". In this case, the device extends the transmission delay immediately to prevent a repeated early switch-off.

Optionally, the device can evaluate a brief presence during adaptive adjustment of the additional transmission delay. Brief presence detection is an interesting option, for example, for preventing immediate activation of a long run-on-time when the motion area is entered briefly (e.g. just quickly taking the office key from the desk). The device identifies whether or not a detected motion is brief by means of the defined time in the ETS parameter "time window recognition of a brief presence". This parameter is only visible if the parameter "Evaluation of brief presence" is set to "yes" on the parameter page - "FBx - End of detection". The brief presence evaluation is then activated as well.

Upon the first motion signal of the new motion, the device starts the configured time window. Motions within the time window are evaluated as brief presence. If additional motions also continue to occur after the time window has elapsed, the device discards the brief presence and works normally with the determined additional transmission delay. If, however, no motions occur anymore beyond the configured time window, the device assumes a brief presence and merely starts the "minimum additional transmission delay".

- i** The "minimum additional transmission delay" configured in the ETS should be at least three times as long as the configured time window for the brief presence so that a brief presence can be evaluated reliably.
- i** The brief presence detection, if activated in the ETS, is processed in parallel to the self-learning of the additional transmission delay and does not influence the process and value of the adaptive time calculation. If a brief presence is detected, this is given one-time priority over the self-learning, i.e. the device processes the brief presence and ends the motion detection early.
- i** The brief presence detection will not take effect in the event of a new motion after an early switch-off has been identified.

Switch-off brightness (only with "Detector with switch-off brightness")

The switch-off brightness (only with the application types single device and main unit) is defined for brightness-dependent operation via the parameter "Hysteresis for switch-off brightness" on the parameter page - "FBx - End of detection". The switch-off brightness is calculated as follows:

Switch-off brightness = effective twilight level + switch-off hysteresis (in Lux).

If the measured ambient brightness continuously exceeds the set switch-off brightness during active motion detection, motion detection will be terminated either after the transmission delay has elapsed or after a separately configurable switch-off delay and the configured telegram transmitted at the end of detection. The parameter "Transmission delay upon reaching the switch-off brightness" determines the type of delay time in this case.

The delay upon reaching or exceeding the switch-off brightness is used for the debouncing of brief light reflexes and prevents faulty switching of the lighting.

If the switch-off brightness is fallen below again before the delay has elapsed, the device then cancels the switch-off process. Detected motions then retrigger the transmission delay.

Teach function for switch-off brightness

The teach function makes it possible to preset the switch-off brightness externally. This function can be used by the ETS in parallel to the presetting of the switch-off brightness and allows for user-guided adjustment of the switch-off brightness to the light bulb used. With the Teach function, the currently measured brightness value is applied instantly by transmitting a corresponding telegram to the 1-bit object "Teach switch-off brightness" as a new switch-off brightness. This object is configurable if the parameter "Teach function for switch-off brightness" is set to "enabled" on the parameter page "FBx - End of detection". The polarity of a Teach telegram is configurable by the parameter "Teach operating mode". Depending on the configuration, it is possible to reset to the configured switch-off brightness upon receiving the opposite object value (Teach inactive). The switch-off brightness previously learned will be lost in the process. If, however, the Teach operating mode is configured to "1"- and "0"-active, it is

not possible anymore to reset to the configured switch-off brightness via this object during ongoing operation of the device! The new switch-off brightness set with the Teach function remains unchanged until a new Teach process. Even a bus voltage failure will not reset the new switch-off brightness.

- i** The Teach function sets an absolute brightness as switch-off brightness. When the twilight level changes, the switch-off brightness set via the Teach function remains unchanged in contrast with the configured switch-off hysteresis. If the configured switch-off hysteresis is active, the resulting switch-off brightness (twilight level + switch-off hysteresis) changes according to the twilight level set.
- i** If the Teach function learns a switch-off brightness that is too low, this will cause a light swing during operation (the lighting is switched on and off permanently). This will also happen if the switch-off brightness is below the twilight level. The same applies if after setting the switch-off brightness, the twilight level is adjusted in such a way that the interval between the twilight level and switch-off brightness is too low.
- i** The disabling function has no effect on the Teach function.

The parameter "Overwrite switch-off brightness in device for ETS-Download?" determines whether a switch-off brightness preset by Teach is overwritten automatically by the switch-off brightness configured in the ETS during ETS programming. If the setting is "yes", the last switch-off brightness preset by Teach and still active is replaced by the ETS presetting. If the setting is "no", the last switch-off value preset by Teach still remains active even after ETS programming.

- i** If the parameter "Overwrite switch-off brightness in device for ETS-Download?" is set to "no" and no Teach has taken place yet - if provided for in the configuration - , the device always works with the ETS configured value. The ETS parameter in the above configuration only becomes invalid after a Teach.

Measurement time period after last motion

In the "Detector" applications, in brightness-independent operation, a function block can - depending on the configured operating mode - determine the time period after a last motion and transmit it to the bus via a communication object. This function, for example, allows simple monitoring of people's movements in assisted living or in a senior citizens' residence. The function is activated if the parameter "Measurement of time interval after the end of the last motion" is set to "activated" on the parameter page "FBx - End of detection".

If the function is enabled, the device starts the timer immediately after a motion detection (motion signal + standard delay). The current counter value is tracked in the 2-byte communication object "Time after last motion" in the data format "minutes" in accordance with DPT 7.006. This object can act as an active signalling object, or alternatively, as a passive status object. As an active signalling object, the device transmits the current counter status cyclically to the bus. The cycle time can be configured in the ETS.

During an active motion or ongoing standard delay, the counter value is always "0".

When the device detects a new motion, it resets the current counter status immediately to "0". In the case of an actively transmitting signalling object, it should be noted that the current counter status will only be transmitted again after the cycle time has elapsed. If the current counter status has reached the maximum value "65,535", the device keeps this value until reset by a new motion detection of the counter.

During the new startup of the function block (e.g. after ETS programming, after bus voltage return, after a function block switch-over. during the deactivation of the disabling function, after a walking test), the counter is always reset. Additionally, the value "0" is transmitted and the time restarted for the cyclical transmission during active transmission of the signalling object.

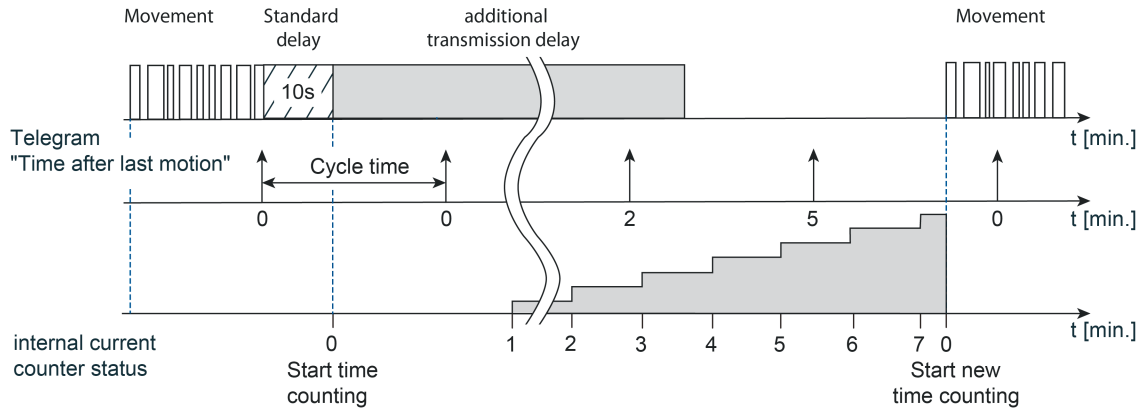

Figure 50: Measurement of the time period after last motion

- i** If the twilight level evaluation is configured to "brightness-dependent", the operating mode is configured to "Semi-automatic II (manual ON, Auto OFF)", or the "Detector with switch-off brightness" application is set, the device cannot evaluate the time interval after the last motion. In these cases, the function is not configurable.

4.2.4.3.12 Disabling function

Disabling function for the autonomous operation of a function block

A function block can be disabled and enabled via a disabling function. A disabled function block has no function. The disabling function is activated and deactivated via the object "FBx - Disable input" in which the telegram polarity is configurable. It is also possible to activate the disabling function after bus voltage return or after ETS programming.

As soon as the device receives a disabling telegram, the disabling function is activated immediately. As a result of this, an active motion detection is stopped without transmitting the telegram at the end of the detection,

Behaviour at the beginning of the disabling function

A telegram can be transmitted separately at the beginning of the disabling function via each output (according to the configured function) for the application types "single device" and "main unit". The parameter "Behaviour at the beginning of the disabling function" on the parameter page "FBx - Disable" defines whether a telegram is transmitted.

In the application "Alert operation" or in the application type "Extension", a telegram output is not provided for at the beginning of the disabling function. Here, the function block is merely interlocked.

On activation of the disabling function, ongoing transmission delays and switch-off delays are stopped and reset. The current state (motion active/inactive) of the motion detection is frozen and saved (see "Behaviour at the end of the disabling function").

Behaviour during the disabling function

During an active disable, no motion detection and telegram output takes place via the outputs. External motion telegrams from extensions and telegrams for the manual operation are ignored.

The following functions are not influenced by the disabling function and continue to be active...

- Teach function for changing the twilight level,
- Presetting of the twilight level via the object "Pressing twilight level",
- Presetting of a factor for the additional transmission delay via the object "Factor additional transmission delay".

Repeated disabling telegrams (disabling function active after disabling function active) received during an active disable cause the device to execute the disabling reaction again (repeat of the configured behaviour at the beginning of the disabling function).

Behaviour at the end of the disabling function

The "Behaviour at the end of the disabling function" is configurable by the parameter of the same name as follows...

- Setting "enable and send no telegram":
The motion state is set to "no motion" (transmission delay not active). No telegrams are transmitted.
This setting is unalterably active in the application type "extension" or in the application "detector".
- Setting "enable and reaction as at end of a detection":
At the end of the disabling function, the behaviour at the "end of a detection" configured in the ETS is executed for each output (including telegram output) in order to restore the basic state of the actuator. The motion state is set to "no motion" (transmission delay active). After the configured lockout time has elapsed, the function block is then ready again - if the actuator activates the lockout - for a new motion detection.

- Setting "enable and reaction as at beginning of a detection":
At the end of the disabling function, the behaviour for "beginning of a detection" configured in the ETS, is executed for each output. For this purpose, a motion detection is simulated (including beginning of the transmission delay) whereby the telegrams are transmitted at the beginning of a detection. If no further motion is detected, the device processes the end of the detection after the transmission delay has elapsed (automatic switch-over to the basic state).
 - Setting "enable and state as before the disabling function":
To restore the state to how it was before the disabling function, the stored state of the motion detection is evaluated (see "Behaviour at the beginning of the disabling function"). The output then reacts as follows...
Motion state was "no motion" -> Behaviour as "enable and reaction as at end of a detection".
Motion state was "Motion present" -> Behaviour as "enable and reaction as at beginning of a detection".
- i** If a disabling function is not activated, the receipt of an enabling telegram is discarded and does not trigger the behaviour at the end of the disabling function.
- i** In brightness-dependent motion detection, attention must be paid to the state of the lighting at the end of the disabling function. If the lighting is on, a motion detection might not be possible again anymore (the function block no longer responds). The lighting can then still only be switched off manually.

4.2.4.3.13 Reset behaviour

Behaviour after bus voltage return

After bus voltage return, various states of operation (possibly with telegram output) can be adopted for the application types "single device" and "main unit". The behaviour of the function block is defined by the parameter "Behaviour after bus voltage return" on the parameter page "FB1 - General". The following settings are possible...

- Setting "no reaction":
The function block switches to basic state (no motion, transmission delay inactive, disabling function inactive). No telegram output takes place.
- i In brightness-dependent motion detection, attention must be paid to the state of the lighting after bus voltage return. If the lighting is on, a motion detection might not be possible (the function block does not respond). Here, the lighting must first be switched off manually.
- Setting "Disabling function active":
With this setting the function block is set to the disabling state after bus voltage return. If a telegram output is configured at the beginning of the disabling function, these telegrams are then transmitted. The basic state (no motion, transmission delay inactive, disabling function inactive) is set as previous state for the disabling function.
- Setting "State as at the beginning of a detection":
With this setting, the state changes to that of an active motion detection after bus voltage return (an evaluation delay is not processed). The processing of the motion detection is only subject to the configured twilight level evaluation. In brightness-independent detection, the configured telegrams are transmitted at the beginning of the detection and the transmission delay started. In brightness-dependent detection, the configured telegrams are transmitted at the beginning of the detection, the transmission delay started and brightness-independent motion detection switched-over to only if the brightness values are below the twilight level. If no further motion is then detected, the device processes the end of the detection after the transmission delay has elapsed.
- Setting "state as before bus voltage failure":
With this setting, the state of the function block is adopted again as it was before bus voltage failure. At the same time, a function block in case of bus voltage failure might have had the following states whereby the reactions described are executed...
 - State before bus voltage failure = no motion, transmission delay inactive -> behaviour as with "no reaction"
 - State before bus voltage failure = disabling function active -> behaviour as with "disabling function active"
 - State before bus voltage failure = active motion detection (transmission delay active) -> To restore the state of an active motion detection, the configured telegrams are transmitted at the beginning of the detection, the transmission delay restarted and brightness-independent motion detection switched-over to. If no motion is then detected, the device processes the end of the detection after the transmission delay has elapsed. An active switch-off delay (for "Detector with switch-off brightness") before bus voltage failure is not restarted automatically, but only when the switch-off threshold is exceeded again.

The "behaviour after bus voltage return" configured in the ETS is not executed if the function block is not active (e.g. by the walking test) or the "Behaviour after ETS programming operation" is executed.

Behaviour after ETS programming

In the application types "single device" and "main unit", various states of operation (possibly with telegram output) can be adopted after ETS programming. The behaviour of the function block is defined by the parameter "Behaviour after ETS programming operation" on the parameter page "FB1 - General". The following settings are possible...

- Setting "no reaction":
The function block switches to basic state (no motion, transmission delay inactive, disabling function inactive). No telegram output takes place.
- i In brightness-dependent motion detection, attention must be paid to the state of the lighting after bus voltage return. If the lighting is on, a motion detection might not be possible (the function block does not respond). Here, the lighting must first be switched off manually.
- Setting "Disabling function active":
With this setting the function block is set to the disabling state after ETS programming. If a telegram output is configured at the beginning of the disabling function, these telegrams are then transmitted. The basic state (no motion, transmission delay inactive, disabling function inactive) is set as previous state for the disabling function.
- Setting "State as at the beginning of a detection":
With this setting, the state changes to that of an active motion detection after ETS programming (an evaluation delay is not processed). The processing of the motion detection is only subject to the configured twilight level evaluation. In brightness-independent detection, the configured telegrams are transmitted at the beginning of the detection and the transmission delay started. In brightness-dependent detection, the configured telegrams are transmitted at the beginning of the detection, the transmission delay started and brightness-independent motion detection switched-over to only if the brightness values are below the twilight level. If no further motion is then detected, the device processes the end of the detection after the transmission delay has elapsed.

The "behaviour after ETS programming operation" configured in the ETS is not executed if the function block is not active (e.g. by the walking test).

4.2.4.4 General reset behaviour

The device - depending on configuration - has various feedback objects. These objects can be configured as "actively transmitting" so that a feedback telegram can be transmitted automatically to the bus when the state changes. These objects then transmit the current object value constantly even after bus voltage return in order to initialize other bus subscribers. A high telegram load can result after bus voltage return, particularly in large KNX systems with many sensors. To counteract such an overload, a transmission delay after bus voltage return is configurable with this device. This transmission delay only takes effect for automatically transmitting objects of the device after bus voltage return and is configured by the parameter "delay after bus voltage return" on the parameter page "General". It is recommended to configure different delay times in the individual sensors so that the devices do not transmit at the same time.

- i** The delay is not active after ETS programming. In this case, the actively transmitting objects transmit their status immediately once the device has been restarted after the reset.

The functional units of the device (e.g. function block for motion evaluation) can be set by configuration to a defined behaviour after bus voltage return or after ETS programming. For this purpose, the parameters "Behaviour after bus voltage return" and "Behaviour after ETS programming" are provided, which are available - depending on the functional unit - on the associated parameter pages.

The disabling functions can also be active automatically after bus voltage return depending on requirements. For this purpose, some disabling functions have their own parameters. Alternatively, disabling functions for defining the behaviour after bus voltage return or after ETS programming are influenced via the aforementioned parameters.

4.2.4.5 Delivery state

In the unprogrammed delivery state, the device behaves passively. It transmits no telegrams to the bus when a motion is detected. With local operation (ON / AUTO / OFF), the state of the green and yellow LEDs changes. However, this has no further impact on the device. As soon as the device has been programmed in the ETS, it is ready for operation.

4.2.5 Parameters

Description	Values	Comment
<p>☐ General</p>		
Selection of device variant	<p>1.10 m 2.20 m</p>	<p>The ETS application program is suitable for the configuration and commissioning of the "1.10 m" and "2.20 m" device variants. The variants primarily differ in the design of the PIR lens and also in the activation of the programming mode. This parameter defines which device variant is used in the ETS project.</p>
<p>Delay after bus voltage return Minutes (0...59)</p>	<p>0...59</p>	<p>The device - depending on configuration - has various feedback objects. These objects can be configured as "actively transmitting" so that a feedback telegram can be transmitted automatically to the bus when the state changes. These objects then transmit the current object value constantly even after bus voltage return in order to initialize other bus subscribers. A high telegram load can result after bus voltage return, particularly in large KNX systems with many sensors. To counteract such an overload, a transmission delay after bus voltage return is configurable here. This transmission delay only takes effect for automatically transmitting objects of the device after bus voltage return. It is recommended to configure different delay times in the individual sensors so that the devices do not transmit at the same time. The delay is not active after ETS programming. In this case, the actively transmitting objects transmit their status immediately once the device has been restarted after the reset. Setting the delay time minutes.</p>
<p>Seconds (0...59)</p>	<p>0...17...59</p>	<p>Setting the delay time seconds.</p>
<p>Time slot for activating the programming mode (0 = activation always possible)</p>	<p>(0...15...59 minutes)</p>	<p>The time slot for activating the programming mode after a device reset (ETS programming operation, bus voltage recovery or plugging the device onto the bus coupler) can be parameterized at this point. The programming mode can only be activated after a device reset within the configured time slot! If the time slot has been exceeded, new actuations of the slide button for more than 5 seconds are</p>

Sensitivity PIR sector A	Sensor switched-off Level 1 Level 2 Level 3 Level 4	The sensitivity of the motion detection, which is a gauge for the range of the PIR evaluation, can be configured here for the PIR sector A. The configuration can be adjusted directly on the device using the adjuster after commissioning.
Sensitivity PIR sector B	Sensor switched-off Level 1 Level 2 Level 3 Level 4	The sensitivity of the motion detection, which is a gauge for the range of the PIR evaluation, can be configured here for the PIR sector B. The configuration can be adjusted directly on the device using the adjuster after commissioning.
Adjuster for sensitivity of PIR sectors A-B	deactivated activated	The adjuster on the device makes it possible to change the configured sensitivity setting of <u>all</u> PIR sectors. The sensitivity can thereby be reduced or increased by a maximum of one level. This parameter enables the adjuster. With the parameter setting "deactivated", the adjuster is without function.
Interlock of all PIR- sectors by external telegram when	OFF ON ON and OFF	When the luminaires activated by the device are in the detection field, the switching on and off of the luminaires can result in motion detection due to changing thermal radiation. To prevent this inaccuracy, the switching status of the luminaires must be guided to the 1-bit object "Interlock PIR sensor". When a corresponding status telegram is received, the motion detection is disabled for a configurable lockout time, so that no motion is detected due to the changing thermal radiation. An ongoing lockout time is restarted upon receiving a new corresponding status telegram. This parameter defines the polarity of the telegrams that induce the interlocking of the PIR sectors.
Lockout time Seconds (0...59)	0... 3 ...59	This parameter defines the lockout time of the PIR sensor. The time is started by a telegram to the object "Interlock of PIR sensor" according to the polarity defined by the parameter "Interlock of all PIR-sectors by external telegram when".
Transmitting the brightness value	on change cyclical	The brightness value determined by the device can be made available to the KNX system via the 2 byte-communication object "Measured

	on change and cyclical only on read request	brightness value". The device can transmit the brightness value actively and/or cyclically for a configured brightness change. It is also possible to only provide the brightness value passively and to transmit this on request. This parameter determines the transmission behaviour.
Transmit on brightness change by (5...200 Lux)	5 Lux... 20 Lux ...200 Lux in 5-Lux increments	This parameter defines the value by which the brightness value determined by the device must change so that this can be transmitted automatically to the bus. This parameter is only visible with the setting "transmission of the brightness value = on change" or "transmission of the brightness value = on change and cyclical".
Time for cyclical transmission Minutes (0...59)	0... 3 ...59	This parameter defines the time interval between two telegrams for the cyclical transmission of the brightness value. Setting the cycle time minutes.
Seconds (0...59)	0 ...59	Setting the cycle time seconds. These parameters are only visible with the setting "transmission of the brightness value = cyclical" or "transmission of the brightness value = on change and cyclical".
Sensor calibration	Factory calibration Calibration by telegram	To determine the ambient brightness, the device possesses a brightness sensor, located behind the lens. The sensor detects the mixed light of its environment composed of artificial light and daylight. Light measurement occurs in the direction the lens is looking. The factory calibration of the device is set in such a way that the brightness is determined at the lens. In some installation environments, it could be that the mounting location of the device is unsuitable, with regard to a brightness measurement. The factory calibration is then not ideal and leads to incorrect measured values. To compensate deviations in the measured brightness to the real ambient brightness in such cases, the brightness measurement can be calibrated using a calibration function (adjustment of the calibration factor) and thus be matched to a changed brightness situation and made ideal (setting: "Calibration through telegram"). During calibration, an

Behaviour in the event of a calibration not carried out	Do not transmit brightness value	externally preset brightness reference value is assigned to the currently measured sensor brightness. This presetting is made via the 2-byte communication object "Sensor calibration".
	transmit invalid brightness value (\$7FFF)	If the parameter "sensor calibration" is set to "calibration by telegram", the device will not evaluate any brightness until a user calibration has been carried out! In this case, all function blocks will therefore have no function until a calibration has been carried out properly. The brightness value tracked via the object "Measured brightness value" can be influenced by this parameter in the event of a calibration not yet carried out. Depending on the setting, the device will either transmit no brightness value (value "0" in the object) or the value "7FFF" (hexadecimal) to indicate an invalid brightness measured value.
Walking test after ETS programming	deactivated activated	The device has a walking test function. The walking test function serves as a guide during the project design and setting of the PIR detection area. The walking test indicates the reaction of the device when detecting motions by means of a blue status LED that is clearly visible behind the sensor window. The walking test can be active immediately after the ETS commissioning. To activate the walking test via the ETS configuration, this parameter must be set to "activated". After subsequently programming the application program in the ETS, the walking test is then activated automatically. It is possible to deactivate a walking test with the aid of the ETS by resetting this parameter to "deactivated" and reprogramming the application program.
Display of motion impulses via walking test LED	only with active walking test with active walking test and in normal operation	The blue status LED is activated by the walking test. Optionally, the status LED can signal detected motions even in normal operation by configuring this parameter to the setting "with active walking test and in normal operation". The signalling enables the start and duration of the motion detection to be visualized by the device at any time. With the setting "only with active walking

test" the status LED is only activated during motion detections in the walking test.

□ FB1 - General

Application	<p>Motion detector</p> <p>Motion detector with switch-off brightness</p> <p>Detector</p>	<p>Definition of the function block application.</p> <p>This parameter - just like the parameter "application type" and "operating mode" - should be configured to the necessary setting at the very start of the device configuration, since all other function block parameters and objects depend on the above parameters.</p>
Application type	<p>Single device</p> <p>Main device</p> <p>Extension</p>	<p>Definition of the function block application type. It is possible to use several devices in a room to extend the detection area by combining a device configured as a main unit with several devices configured as an extension. A single device always works autonomously. In the application "detector", the application type is preset to "single device".</p> <p>This parameter - just like the parameter "application" and "operating mode" - should be configured to the necessary setting at the very start of the device configuration, since all other function block parameters and objects depend on the above parameters.</p>
Operating mode	<p>Fully automatic (Auto ON, Auto OFF)</p> <p>Semi-automatic I (manual ON, Auto OFF)</p>	<p>In the case of the application "Detector" or "Detector with switch-off brightness", the operating mode can be configured in the ETS. The operating mode specifies the function of the motion detection and defines whether or not the beginning and the end of a motion detection is identified automatically. This makes it possible to adjust the motion detection to many applications in private and public areas (e.g. toilet lighting, service lighting, control of ventilation systems).</p> <p>In this operating mode, the outputs of the function block are activated automatically by the motion detection and brightness evaluation. Manual activation of the device is not necessary.</p> <p>In this operating mode, an ON telegram must first be transmitted to the object "Lighting manual ON/OFF" before a motion (including ext. motion) is detected and evaluated. At the same</p>

Semi-automatic II (Auto ON, Manual OFF)	<p>time, the ON telegram starts the first motion detection including the transmission delay. The end of the detection is identified automatically or initiated by an OFF telegram to the object Lighting manual ON/OFF". Afterwards, a manual ON telegram is required again, in order to evaluate a new motion.</p>
	<p>In this operating mode, a detection is identified automatically as in the operating mode "Fully automatic". After detection of a motion and output of the telegrams for "beginning of a detection", no transmission delay is started. Thus, the end of the detection can only be achieved by an OFF telegram to the object Lighting manual ON/OFF". The function block is then ready again for a new motion evaluation.</p>
	<p>This parameter - just like the parameter "application" and "application type" - should be configured to the necessary setting at the very start of the device configuration, since all other function block parameters and objects depend on the above parameters.</p>
Behaviour after bus voltage return	<p>After bus voltage return, various states of operation (possibly with telegram output) can be adopted for the application types "single device" and "main unit". The behaviour of the function block is defined by this parameter.</p>
no reaction	<p>The function block switches to basic state (no motion, transmission delay inactive, disabling function inactive). No telegram output takes place.</p>
Disabling function active	<p>With this setting the function block is set to the disabling state after bus voltage return. If a telegram output is configured at the beginning of the disabling function, these telegrams are then transmitted. The basic state (no motion, transmission delay inactive, disabling function inactive) is set as previous state for the disabling function.</p>
state as at the beginning of a detection	<p>With this setting, the state changes to that of an active motion detection after bus voltage return (an evaluation delay is not processed). The processing of the motion detection is only subject to the configured twilight level evaluation. In brightness-independent detection, the configured telegrams are transmitted at the beginning of the detection and the</p>

	<p>transmission delay started. In brightness-dependent detection, the configured telegrams are transmitted at the beginning of the detection, the transmission delay started and brightness-independent motion detection switched-over to only if the brightness values are below the twilight level. If no further motion is then detected, the device processes the end of the detection after the transmission delay has elapsed.</p>
<p>State as before bus voltage failure</p>	<p>With this setting, the state of the function block is adopted again as it was before bus voltage failure.</p> <p>The behaviour configured here is not executed if the function block is not active (e.g. by function block switch-over, walking test) or the "Behaviour after ETS programming operation" is executed.</p>
<p>Behaviour after ETS programming</p>	<p>In the application types "single device" and "main unit", various states of operation (possibly with telegram output) can be adopted after ETS programming. The behaviour of a function block is defined by this parameter.</p>
<p>no reaction</p>	<p>The function block switches to basic state (no motion, transmission delay inactive, disabling function inactive). No telegram output takes place.</p>
<p>Disabling function active</p>	<p>With this setting the function block is set to the disabling state after ETS programming. If a telegram output is configured at the beginning of the disabling function, these telegrams are then transmitted. The basic state (no motion, transmission delay inactive, disabling function inactive) is set as previous state for the disabling function.</p>
<p>state as at the beginning of a detection</p>	<p>With this setting, the state changes to that of an active motion detection after ETS programming (an evaluation delay is not processed). The processing of the motion detection is only subject to the configured twilight level evaluation. In brightness-independent detection, the configured telegrams are transmitted at the beginning of the detection and the transmission delay started. In brightness-dependent detection, the configured telegrams are transmitted at the beginning of the detection, the transmission delay started and brightness-independent motion detection switched-over to only if the</p>

		brightness values are below the twilight level. If no further motion is then detected, the device processes the end of the detection after the transmission delay has elapsed.
Function output 1		Up to two output communication objects are available in the function block via which the switching and control commands are transmitted on the bus to the KNX actuator, e.g. lighting system, room temperature control. The data format of the object of output 1 is defined depending on the function configured here and adapted to the controllable function units of the KNX system.
	No function	The output is deactivated. There is no separate output communication object available.
	Switching	1-bit switching telegrams (ON / OFF) can be output. Example application: Switching lighting.
	Staircase function	1-bit switching telegrams (ON, OFF) are output cyclically in order to trigger the run-on-time in the activated KNX actuator. Example application: Switching staircase lighting
	Switching with forced position	2-bit switching telegrams can be output for the forced position of an actuator channel in accordance with DPT 2.001. This makes it possible to set switching states with a higher priority (ON, OFF). Example application: Switching lighting by forced control (cleaning lighting, service light).
	Dimming value transmitter	1-byte brightness value telegrams in accordance with DPT 5.001 (0...100 %) can be output. Example application: Dimming lighting.
	Light scene extension	1-byte telegrams in accordance with DPT 18.001 (1...64) can be output for the scene recall. Example application: Recall actuator scenes (e.g. TV lighting).
	Temperature value transmitter	2-byte temperature value telegrams in accordance with DPT 9.001 (0...+40 °C configurable in 1 °C-increments) can be output. Example application: Preset temperature setpoints.
	Brightness value transmitter	2-byte brightness value telegrams in accordance with DPT 9.004 (0...2,000 Lux configurable in 50-Lux increments) can be output. Example application: Preset lighting setpoints.

	<p>Operating mode room temperature controller</p>	<p>1-byte telegrams for switching over the operating mode of a KNX room temperature controller in accordance with DPT 20.102 (comfort, standby, night, frost/heat protection, automatic operation) can be output. Example application: Influence room temperature control.</p> <p>In the application type "extension", no output functions are available. Therefore, these are then only configurable in the main unit. In the application "detector", the output 1 preset to the detector function (1-bit switching telegrams).</p>
<p>Function output 2</p>		<p>Up to two output communication objects are available in the function block via which the switching and control commands are transmitted on the bus to the KNX actuator, e.g. lighting system, room temperature control. The data format of the object of output 2 is defined depending on the function configured here and adapted to the controllable function units of the KNX system.</p>
	<p>No function</p>	<p>The output is deactivated. There is no separate output communication object available.</p>
	<p>Switching</p>	<p>1-bit switching telegrams (ON / OFF) can be output. Example application: Switching lighting.</p>
	<p>Staircase function</p>	<p>1-bit switching telegrams (ON, OFF) are output cyclically in order to trigger the run-on-time in the activated KNX actuator. Example application: Switching staircase lighting</p>
	<p>Switching with forced position</p>	<p>2-bit switching telegrams can be output for the forced position of an actuator channel in accordance with DPT 2.001. This makes it possible to set switching states with a higher priority (ON, OFF). Example application: Switching lighting by forced control (cleaning lighting, service light).</p>
	<p>Dimming value transmitter</p>	<p>1-byte brightness value telegrams in accordance with DPT 5.001 (0...100 %) can be output. Example application: Dimming lighting.</p>
	<p>Light scene extension</p>	<p>1-byte telegrams in accordance with DPT 18.001 (1...64) can be output for the scene recall. Example application: Recall actuator scenes (e.g. TV lighting).</p>

Temperature value transmitter	2-byte temperature value telegrams in accordance with DPT 9.001 (0...+40 °C configurable in 1 °C-increments) can be output. Example application: Preset temperature setpoints.
Brightness value transmitter	2-byte brightness value telegrams in accordance with DPT 9.004 (0...2,000 Lux configurable in 50-Lux increments) can be output. Example application: Preset lighting setpoints.
Operating mode room temperature controller	1-byte telegrams for switching over the operating mode of a KNX room temperature controller in accordance with DPT 20.102 (comfort, standby, night, frost/heat protection, automatic operation) can be output. Example application: Influence room temperature control.

In the application type "extension", no output functions are available. Therefore, these are then only configurable in the main unit. In the application "detector", the output 2 cannot be configured.

□↵ FB1 - Operating mode / local control

Specification of disabled
operating mode through **enabled**
local control

The device possesses operating elements for local operation. Thus, in running device operation, the operating mode (OFF / AUTO / ON) of the first function block can be switched over, thus influencing the state of the corresponding output directly. This means that, for example, it possible when activating lighting to deactivate automatic motion and thus permanently switch the light on or off as required. In the "Enabled" setting, this parameter activates the operating elements. When "Disabled", local operation of the operating mode is not possible. The operating elements are then disabled.

Function of local control

1 / AUTO / 0

This parameter specifies which operating modes can be set through an operation on the device.

The operating elements are fully functional. The operating modes "ON", "AUTO" and "OFF" can be set as required.

1 / AUTO / -

The operating element for the "OFF" operating mode has no function. Only the operating elements for "ON" and "AUTO" are evaluated.

	- / AUTO / 0	The operating element for the "ON" operating mode has no function. Only the operating elements for "OFF" and "AUTO" are evaluated.
Use disabling function for local operation?	yes no	It is possible to deactivate local operation to switch over the operating mode using a separate disabling function. The disabling function is then activated and deactivated via the communication object "Disable local operation". During active disabling, local operation of the operating mode is completely deactivated.
Polarity of disable object	0 = enable / 1 = disable 0 = disable / 1 = enable	The polarity of the disabling object is defined here.
State of the disabling function after bus voltage return	deactivated activated State as before bus voltage failure	The "state of the disabling function after bus voltage return" can be configured in the ETS. After bus voltage return, local operation is ready for operation immediately. After bus voltage return, local operation is disabled immediately. The current state of the disabling function will be stored in case of bus voltage failure. After bus voltage return, the device tracks the saved disabling state (active or inactive).
State of the disabling function after ETS programming	deactivated activated	The "state of the disabling function after ETS programming" can also be configured in the ETS. After an ETS programming operation, local operation is ready for operation immediately. After an ETS programming operation, local operation is disabled immediately.
Display of "ON" operating mode	deactivated activated	In the "Single device" or "Main unit" application types, the green LED, located behind the PIR sensor window, can display the active "ON" operating

mode. This parameter enables the display function.

Display of "OFF" operating mode

deactivated
activated

In the "Single device" or "Main unit" application types, the yellow LED, located behind the PIR sensor window, can display the active "OFF" operating mode. This parameter enables the display function.

□ FB1 - Sensor assignment

Detection of the brightness value by

Internal sensor
External sensor (object)
Internal and external sensor (combined value)

To determine the ambient brightness, the device possesses a brightness sensor, located behind the lens. The sensor detects the mixed light of its environment composed of artificial light and daylight. Light measurement occurs in the direction the lens is looking. The brightness value determined by this internal sensor can be supplied to the function block internally for the twilight level evaluation.

Optionally, an external 2-byte brightness value in accordance with DPT 9.004 can also be made available to the function block via the bus. This makes it possible to carry out the twilight level evaluation independently of the installation location of the device (e.g. provision of an external brightness value via a more favourably installed extension).

In special cases, it is possible to link the determined brightness value of the internal sensor to an external brightness value. In this way, the light measurement of the function block can take place at 2 locations. At the same time, both sensor values are weighted for determining the effective brightness value.

This parameter defines which sensors are used for the brightness evaluation of a function block.

i The blue Status LED and the brightness sensor to measure ambient brightness are located together behind the PIR sensor window. As a result, the brightness measurement of the device in operation can be adversely affected by the LED. For this reason, it is not possible to assign the internal brightness sensor to a function block for the application types "Single device" and "Main unit" if the blue Walking test LED signals movements in normal operation. In this case, only the allocation of an external KNX brightness sensor is possible.
 With the "Extension" application type, only the internal brightness sensor is assigned to the function block. With continually faulty brightness detection at the extension, the blue Status LED should be configured, so that it only displays movement during a walking test.

Weighting of the brightness values internal to external

- 95% to 5%
- 90% to 10%
- 85% to 15%
- 80% to 20%
- 75% to 25%
- 70% to 30%
- 65% to 35%
- 60% to 40%
- 55% to 45%
- 50% to 50%**
- 45% to 55%
- 40% to 60%
- 35% to 65%
- 30% to 70%
- 25% to 75%
- 20% to 80%
- 15% to 85%
- 10% to 90%
- 5% to 95%

This parameter defines the weighting of the brightness measured values from the internal sensor to the external sensor. The parameter is only visible if the brightness value is detected by means of a combined value from an internal and external sensor.

FB1 - Brightness evaluation

Evaluation of the twilight level ?

- yes (brightness dependent operation)**
- no (brightness independent operation)

During the motion detection in the application "detector", the evaluation of the twilight level can take place brightness-independently or brightness-dependently. In the brightness-independent evaluation, no brightness value is taken into account during the processing of a motion. Each motion then triggers a new detection process in

the idle state. This configuration, for instance, is interesting for lighting-independent applications. In the brightness-dependent evaluation, the measured brightness value in relation to the effective twilight level is taken into account for processing a motion detection. The function block then only detects motions when the measured brightness value is below the set twilight level. This configuration is normally used to control lighting systems in corridors or rooms with some levels of daylight. With the "Detector with switch-off brightness", the twilight level is always evaluated according to the brightness. In the application "detector", the motion detection always works brightness-independently.

The following parameters are only available with brightness-dependent motion detection...

Twilight level (1...1,000 Lux) 1...**50**...1,000

The twilight level is preset by this parameter. This value can optionally be changed by an external twilight level value (via object) or with the Text function in state of operation and thus adapted to the user's needs. An additional setting is possible for the function block 1 via the IR remote control (accessory).

Overwrite twilight level in device for ETS-download? **yes**
no

This parameter determines whether an actively set and active twilight level value by previous external object presetting or by Teach is overwritten automatically by the twilight level configured in the ETS during ETS programming. If the setting is "yes", the last value preset externally or by Teach and still active is replaced by the ETS presetting. If the setting is "no", the last twilight level preset externally or by Teach still remains active even after ETS programming. If this parameter is set to "no" and no external presetting has been made yet - if provided for in the configuration - via the 2-byte object or by Teach after the first ETS commissioning, the device always works with the ETS configured

Object "Presetting twilight level"	<p>disabled</p> <p>enabled</p>	<p>value. The ETS parameter only becomes invalid within the above configuration after an external presetting or after a Teach.</p>
Feedback "Active twilight level"	<p>active signalling object</p> <p>passive status object</p>	<p>The feedback of the twilight level effectively set in the function block is possible via the 2-byte object "Active twilight level" in accordance with DPT 9.004. This object can optionally act as an active signalling object or passive status object (object is readable). As an active signalling object, the current twilight level brightness value is transmitted once to the bus on each change of the twilight level, after ETS programming or after bus voltage return (optionally delayed).</p>
Evaluation of the twilight level	<p>only in the main unit</p> <p>in main unit and extension</p>	<p>With the application types "single device" and "main unit" an external motion signal can be transmitted to the device. If the twilight level evaluation is configured to "brightness-dependent", the evaluation of the external motion detections can be influenced. This parameter defines the behaviour on receipt of a motion telegram on the main unit.</p> <p>External motion signals are ignored by the main unit if the brightness is above the twilight level.</p> <p>External motion signals are always evaluated by the main unit even if the brightness is above the twilight level.</p> <p>This parameter is only visible with the application type "Main unit".</p>

Evaluation of the twilight level with external motion telegram

With the application types "single device" and "main unit" an external motion signal can be transmitted to the device. If the twilight level evaluation is configured to "brightness-dependent", the evaluation of the external motion detections can be influenced. This parameter defines the behaviour on receipt of a motion telegram on as single device.

yes (brightness dependent operation)

External motion signals are ignored if the brightness is above the twilight level.

no (brightness independent operation)

External motion signals are always evaluated even if the brightness is above the twilight level.

This parameter is only visible with the application type "single device".

Use Teach function ? **yes**

With the Teach function, the effective brightness value is applied instantly by transmitting a corresponding telegram to the 1-bit object "Teach twilight level" as a new twilight level value. Taught-in brightness values are limited to the measuring range 1...1,000 Lux. The object is configurable if this parameter is set to "yes".

no

Polarity for object "Teach twilight level"

0 = inactive / 1 = active

The polarity of a Teach telegram is configurable by this parameter. Depending on the configuration, it is possible to reset to the configured twilight level upon receiving the opposite object value (Teach inactive). The twilight level previously learned will be lost in the process. If, however, the Teach polarity is configured to "1"- and "0"-active, it is no longer possible to reset to the configured twilight level via this object during ongoing operation of the device!

0 = active / 1 = inactive

0 = active / 1 = active

This parameter is visible only if the teach function is enabled.

FB1 - Beginning of detection

Use evaluation delay? **yes**

This parameter enables the evaluation delay. The evaluation delay at the beginning of a motion detection ensures that no reaction to just a brief motion (e.g. when quickly striding through a room) takes place. The motion is only processed during a longer-lasting

no

<p>Additional transmission delay Minutes (0...59)</p>	<p>Seconds (0...59) 0...30...59</p>	<p>This parameter defines the additional transmission delay. Setting the additional transmission delay minutes.</p>
		<p>Setting the additional transmission delay seconds.</p>
		<p>This parameter is only visible if the additional transmission delay is to be preset via parameter.</p>
<p>Time extension for additional transmission delay</p>	<p>no extension Factor via object</p>	<p>Optionally, the time defined in the ETS can be extended by a 1-byte factor received via the bus. This makes it possible to dynamically adapt the additional transmission delay user-defined via the bus. The time extension is possible when this parameter is set to "Factor via object". In this case, the device evaluates the value of the object "Factor additional transmission delay" (DPT 5.010) and calculates the additional transmission delay (received factor x configured time). A newly received factor is first applied actively after a restart or when retriggering the transmission delay. Thus, the time of an ongoing transmission delay is not influenced immediately by a newly received factor. If the function block is inactive when a new factor is received (e.g. disabling function active, deactivated by the function block switch-over, walking test active), the value received is evaluated later during activation of the function block. After ETS programming or after bus voltage return, the device always works with the factor "1" (-> additional transmission delay = parameter value) until an object value is received.</p>
<p>Hysteresis for switch-off brightness (10...800 Lux)</p>	<p>10...300...800</p>	<p>The switch-off brightness with "Detector with switch-off brightness" (only with the application types single device and main unit) is preset for brightness-dependent operation via this parameter. The switch-off brightness is calculated as follows: Switch-off brightness = effective twilight level + switch-off hysteresis (in Lux). If the measured brightness exceeds the set switch-off brightness during an active motion detection, no further motions are evaluated. The device then transmits the configured telegram at the end of the detection after the effective transmission delay, or alternatively, after</p>

Teach function for switch-off brightness	<p>disabled</p> <p>enabled</p>	<p>a separately configurable switch-off delay (see parameter "Transmission delay upon reaching the switch-off brightness").</p> <p>With the Teach function, the effective brightness value is applied instantly by transmitting a corresponding telegram to the 1-bit object "Teach switch-off brightness" as a new switch-off brightness. The object is configurable if this parameter is set to "enabled".</p>
Overwrite switch-off brightness in device for ETS-Download?	<p>yes</p> <p>no</p>	<p>This parameter determines whether a switch-off brightness preset to active by Teach and which is active is overwritten automatically by the switch-off brightness configured in the ETS during ETS programming. If the setting is "yes", the last switch-off brightness preset by Teach and still active is replaced by the ETS presetting. If the setting is "no", the last switch-off value preset externally or by Teach still remains active even after ETS programming.</p> <p>If this parameter is set to "no" and no Teach has taken place yet - if provided for in the configuration - , the device always works with the ETS configured value. The ETS parameter in the above configuration only becomes invalid after a Teach.</p> <p>This parameter is visible only if the teach function is enabled.</p>
Teach operating mode	<p>0 = inactive / 1 = active</p> <p>0 = active / 1 = inactive</p> <p>0 = active / 1 = active</p>	<p>The polarity of a Teach telegram is configurable by this parameter. Depending on the configuration, it is possible to reset to the configured switch-off brightness upon receiving the opposite object value (Teach inactive). The switch-off brightness previously learned will be lost in the process. If, however, the Teach polarity is configured to "1"- and "0"-active, it is not possible anymore to reset to the configured switch-off brightness via this object during ongoing operation of the device!</p> <p>This parameter is visible only if the teach function is enabled.</p>
Transmission delay after reaching the switch-off brightness		<p>This parameter determines the type of delay time if the measured brightness reaches or exceeds the set switch-off brightness during an active motion detection. The delay upon reaching or</p>

		<p>exceeding the switch-off brightness is used for the debouncing of brief light reflexes and prevents faulty switching of the lighting. If the switch-off brightness is fallen below again before the delay has elapsed, the device then cancels the switch-off process. Detected motions then retrigger the transmission delay.</p>
	like additional transmission delay	<p>The delay time is defined by the effective additional transmission delay. No further settings are necessary.</p>
	Switch-off delay	<p>The delay time can be configured as a separate switch-off delay in the ETS (see parameter "Time for switch-off delay").</p>
Time for switch-off delay Minutes (0...59)	0... 5 ...59	<p>This parameter defines the switch-off delay. Setting the switch-off delay minutes.</p>
Seconds (0...59)	0 ...59	<p>Setting the switch-off delay seconds.</p>
		<p>These parameters are only visible if the switch-off delay is to be started after reaching or exceeding the switch-off brightness.</p>
Measurement of the time period after end of the last motion	deactivated activated	<p>In the "Detector" operating modes, in brightness-independent operation, a function block can - depending on the configured operating mode - determine the time period after a last motion and transmit it to the bus via a communication object. This function, for example, allows simple monitoring of people's movements in assisted living or in a senior citizens' residence. The function is activated if this parameter is set to "activated".</p>
Feedback "Time after last motion"	active signalling object passive status object	<p>The current counter value for measuring the time period after the end of the last motion is tracked in the 2-byte communication object "Time after last motion" in the data format "minutes" in accordance with DPT 7.006. This object can act as an active signalling object, or alternatively, as a passive status object. This parameter is only visible if the time measurement is enabled.</p>
Cycle time for automatic transmission Hours (0...59)	0 ...59	<p>As an active signalling object, the object "Time after last motion" transmits the current counter status cyclically to the bus. The cycle time can be configured</p>

Minutes (10...59)	10...59	here. Setting the cycle time hours. Setting the cycle time minutes. These parameters are only visible if the time measurement is enabled and the object is actively transmitting.
<input type="checkbox"/> FB1 - Output 1 Send telegram at the beginning of the detection?	yes no	Here, it is defined whether a telegram is transmitted via the output object at the beginning of a detection.
Telegram at the beginning of the detection	ON telegram OFF telegram	This parameter defines the telegram at the beginning of the detection for the output function "Switching". This parameter is only visible if a telegram should be transmitted at the beginning of a detection.
Telegram at the beginning of the detection	ON telegram	In the staircase function, an ON telegram is always transmitted at the beginning of the detection. This parameter is only visible if the output function is configured to "Staircase function" and a telegram should be transmitted at the beginning of a detection.
Forced position at the beginning of the detection	Forced position active, ON Forced position active, OFF Forced position inactive	This parameter defines the telegram at the beginning of the detection for the output function "Switching with forced position". This parameter is only visible if a telegram should be transmitted at the beginning of a detection.
Dimming value at the beginning of the detection (0...100 %)	0...100	This parameter defines the telegram at the beginning of the detection for the output function "Dimming value transmitter". This parameter is only visible if a telegram should be transmitted at the beginning of a detection.
Light scene number at the beginning of the detection (1...64)	1...64	This parameter defines the telegram at the beginning of the detection for the output function "Light scene extension". This parameter is only visible if a telegram should be transmitted at the beginning of a detection.

<p>Temperature value at the beginning of the detection</p>	<p>0 °C...23 °C...40 °C in 1 °C increments</p>	<p>This parameter defines the telegram at the beginning of the detection for the output function "Temperature value transmitter". This parameter is only visible if a telegram should be transmitted at the beginning of a detection.</p>
<p>Brightness value at the beginning of the detection</p>	<p>0 Lux...1,000 Lux... 2,000 lux in 50-Lux increments</p>	<p>This parameter defines the telegram at the beginning of the detection for the output function "Brightness value transmitter". This parameter is only visible if a telegram should be transmitted at the beginning of a detection.</p>
<p>Operating mode at the beginning of the detection</p>	<p>Auto Comfort Standby Night Frost/heat protection</p>	<p>This parameter defines the telegram at the beginning of the detection for the output function "Operating mode room temperature controller". This parameter is only visible if a telegram should be transmitted at the beginning of a detection.</p>
<p>Cyclical transmission during the detection?</p>	<p>yes no</p>	<p>Setting this parameter to "yes" activates the cyclical telegram output during a motion detection. The cyclical output only occurs during detected heat motions and within the standard delay. During an active additional transmission delay, no cyclical transmission takes place. If the device detects a new motion again (retriggering) during an ongoing additional transmission delay, the standard delay is restarted and the cyclical telegram output is either resumed (if the last cycle time has not yet elapsed after the previous telegram), or restarted by immediate transmission (if the last cycle time has already elapsed).</p>
<p>Time for cyclical transmission Minutes (0...59) Seconds (0...59)</p>	<p>0...59 0...10...59</p>	<p>The time for the cyclical transmission is defined here. Setting the cycle time minutes. Setting the cycle time seconds.</p> <p>These parameters are only visible if the transmission should be cyclical during a motion detection and the standard</p>

		delay.
Triggering of a telegram when retriggering?	yes no	If the cyclical transmission is not activated, an output can repeat the telegram at the beginning of the transmission when retriggering. Retriggering takes place when the device detects a new motion during an ongoing additional transmission delay. No telegram is transmitted when retriggering during the standard delay! This parameter enables the triggering of a telegram when retriggering? (setting "yes"). This parameter is only visible if the transmission should not be cyclical during a motion detection and the standard delay.
Send telegram at the end of the detection?	yes no	Here, you it can be defined whether a telegram is transmitted via the output object at the end of a detection.
Telegram at the end of the detection	ON telegram OFF telegram	This parameter defines the telegram at the end of the detection for the output function "Switching". This parameter is only visible if a telegram should be transmitted at the end of a detection.
Telegram at the end of the detection	OFF telegram	In the staircase function, an ON telegram is always transmitted at the end of the detection. This parameter is only visible if the output function is configured to "Staircase function" and a telegram should be transmitted at the end of a detection.
Forced position at the end of the detection	Forced position active, ON Forced position active, OFF Forced position inactive	This parameter defines the telegram at the end of the detection for the output function "Switching with forced position". This parameter is only visible if a telegram should be transmitted at the end of a detection.
Dimming value at the end of the detection (0...100 %)	0...100	This parameter defines the telegram at the end of the detection for the output function "Dimming value transmitter". This parameter is only visible if a telegram should be transmitted at the end of a detection.

<p>Light scene number at the end of the detection (1...64)</p>	<p>1...64</p>	<p>This parameter defines the telegram at the end of the detection for the output function "light scene extension". This parameter is only visible if a telegram should be transmitted at the end of a detection.</p>
<p>Temperature value at the end of the detection</p>	<p>0 °C...21 °C...40 °C in 1 °C increments</p>	<p>This parameter defines the telegram at the end of the detection for the output function "Temperature value transmitter". This parameter is only visible if a telegram should be transmitted at the end of a detection.</p>
<p>Brightness value at the end of the detection</p>	<p>0 Lux...750 Lux... 2,000 lux in 50-Lux increments</p>	<p>This parameter defines the telegram at the end of the detection for the output function "Brightness value transmitter". This parameter is only visible if a telegram should be transmitted at the end of a detection.</p>
<p>Operating mode at the end of the detection</p>	<p>Auto Comfort Standby Night Frost/heat protection</p>	<p>This parameter defines the telegram at the end of the detection for the output function "Operating mode room temperature controller". This parameter is only visible if a telegram should be transmitted at the end of a detection.</p>
<p><input type="checkbox"/> FB1 - Output 2 - See output 1! <input type="checkbox"/> FB1 - Disable</p>	<p>0 = enable / 1 = disable</p> <p>0 = disable / 1 = enable</p>	<p>This parameter defines the polarity of the disabling object.</p>
<p>Behaviour at the beginning of the disabling function</p>		<p>A telegram can be transmitted separately at the beginning of the disabling function via each output (according to the configured function) for the application types "single device" and "main unit". This parameter defines whether a telegram is transmitted. In the application "Alert operation" or in the application type "Extension", a telegram output is not provided for at the</p>

beginning of the disabling function. Here, the function block is merely interlocked. On activation of the disabling function, ongoing transmission delays and switch-off delays are stopped and reset. The current state (motion active/inactive) of the motion detection is frozen and saved.

disable and send no telegram

At the start of the disabling function, the function block is interlocked. No telegram is transmitted.

disable and send telegram

At the start of the disabling function, the function block is interlocked. A telegram is transmitted according to configuration (see following parameter).

The following parameters "...at the beginning of the disabling function" are - if configured -available separately for the output 1 and 2.

Telegram at the beginning of the disabling function

ON telegram
OFF telegram

This parameter defines the telegram at the beginning of the disabling function for the output function "Switching" and "Staircase function". This parameter is only visible if a telegram should be transmitted at the beginning of a the disabling function.

Forced position at the beginning of the disabling function

Forced position active, ON
Forced position active, OFF
Forced position inactive

This parameter defines the telegram at the beginning of the disabling function for the output function "Switching with forced position". This parameter is only visible if a telegram should be transmitted at the beginning of a the disabling function.

Dimming value at the beginning of the disabling function (0...100 %)

0...100

This parameter defines the telegram at the beginning of the disabling function for the output function "Dimming value transmitter". This parameter is only visible if a telegram should be transmitted at the beginning of a the disabling function.

Light scene number at the beginning of the

1...64

This parameter defines the telegram at the beginning of the disabling function

disabling function (1...64)		for the output function "Light scene extension". This parameter is only visible if a telegram should be transmitted at the beginning of a the disabling function.
Temperature value at the beginning of the disabling function	0 °C... 21 °C ...40 °C in 1 °C increments	This parameter defines the telegram at the beginning of the disabling function for the output function "Temperature value transmitter". This parameter is only visible if a telegram should be transmitted at the beginning of a the disabling function.
Brightness value at the beginning of the disabling function	0 Lux... 750 Lux ... 2,000 lux in 50-Lux increments	This parameter defines the telegram at the beginning of the disabling function for the output function "Brightness value transmitter". This parameter is only visible if a telegram should be transmitted at the beginning of a the disabling function.
Operating mode at the beginning of the disabling function	Auto Comfort Standby Night Frost/heat protection	This parameter defines the telegram at the beginning of the disabling function for the output function "Operating mode room temperature controller". This parameter is only visible if a telegram should be transmitted at the beginning of a the disabling function.
Behaviour at the end of the disabling function	enable and send no telegram enable and reaction as at end of a detection enable and reaction as at the start of a detection	This parameter defines the behaviour of all outputs at the end of the disabling function. The motion state is set to "no motion" (transmission delay not active). No telegrams are transmitted. This setting is unalterably active in the application type "extension" or in the application "detector". At the end of the disabling function, the behaviour at the "end of a detection" configured in the ETS is executed for each output (including telegram output) in order to restore the basic state of the actuator. The motion state is set to "no motion" (transmission delay active). After the configured lockout time has elapsed, the function block is then ready again - if the actuator activates the lockout - for a new motion detection. At the end of the disabling function, the behaviour for "beginning of a detection"

configured in the ETS, is executed for each output. For this purpose, a motion detection is simulated (including beginning of the transmission delay) whereby the telegrams are transmitted at the beginning of a detection. If no further motion is detected, the device processes the end of the detection after the transmission delay has elapsed (automatic switch-over to the basic state).

enable and state as before
the disabling function

To restore the state to how it was before the disabling function, the stored state of the motion detection at the beginning of the disabling function is evaluated. The output then reacts as follows...
Motion state was "no motion" -> Behaviour as "enable and reaction as at end of a detection".
Motion state was "Motion/presence present" -> Behaviour as "enable and reaction as at beginning of a detection".

5 Appendix

5.1 Index

A	
Additional transmission delay.....	90
after last motion.....	93
alert operation.....	88
application program.....	22
application type.....	55
B	
basic sensitivity.....	42
Beginning of the detection.....	85
Behaviour after bus voltage return.....	97
Behaviour after ETS programming.....	98
Brightness measurement.....	44
brightness sensor.....	72
C	
Calibration function.....	44
Ceiling detector.....	50
D	
Detector.....	53
E	
end of the detection.....	90
ETS	28
ETS search paths.....	26
Evaluation delay.....	87
Extension.....	56
F	
Factory calibration.....	44
I	
Interlock.....	42
L	
local operation.....	61
M	
Main unit.....	56
manual operation.....	76
Motion detection.....	42
motion detector with switch-off	51
brightness	
P	
physical address.....	22
S	
single device.....	55
slide switch.....	61
Staircase function.....	82
Switch-off brightness.....	92
T	
Total motion.....	85
Twilight level evaluation.....	73
W	
walking test.....	22,48
walking test.....	22,48

ALBRECHT JUNG GMBH & CO. KG

Volmestraße 1
58579 Schalksmühle
GERMANY

Telefon: +49 2355 806-0
Telefax: +49 2355 806-204
kundencenter@jung.de
www.jung.de