



Product documentation

KNX RF radio transmitter module 1-gang
Art. No. ..5071 RF TSM

KNX RF radio transmitter module 2-gang
Art. No. ..5072 RF TSM

KNX RF radio transmitter module 3-gang
Art. No. ..5073 RF TSM

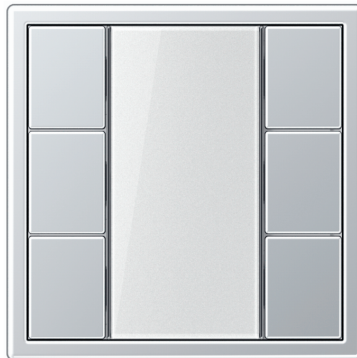

ALBRECHT JUNG GMBH & CO. KG
Volmestraße 1
58579 Schalksmühle
GERMANY

Telefon: +49 2355 806-0
Telefax: +49 2355 806-204
kundencenter@jung.de
www.jung.de

Issue: 31.07.2019
6614x320 V2

Table of Contents

1	Product definition	3
1.1	Product catalogue	3
1.2	Function	3
1.3	Accessories	4
2	Installation, electrical connection and operation	5
2.1	Safety instructions	5
2.2	Battery safety instructions	6
2.2.1	Disposal of batteries	6
2.3	Device components	7
2.4	Mounting	8
2.5	Commissioning	10
2.6	Operation	12
3	Technical data	13
4	Software description	14
4.1	Software specification	14
4.2	Software "KNX RF radio transmitter module"	16
4.2.1	Scope of functions	16
4.2.2	Notes on software	17
4.2.3	Object table	18
4.2.4	Functional description	21
4.2.4.1	Display functions	21
4.2.4.2	Rockers and button functions	27
4.2.4.2.1	Function "Switching"	27
4.2.4.2.2	Function "Dimming"	30
4.2.4.2.3	Function "Venetian blind"	32
4.2.4.2.4	Function "Value transmitter 1 byte"	34
4.2.4.2.5	Function "Value transmitter 2 byte"	36
4.2.4.2.6	Function "Scene extension"	38
4.2.4.3	Room temperature measurement	41
4.2.4.4	Delivery state	43
4.2.5	Parameters	44
5	Appendix	54
5.1	Application basics	54
5.1.1	Basic physical principles	54
6	Index	62

1 Product definition

1.1 Product catalogue

Product name: RF radio transmitter module 1-gang / RF radio transmitter module 2-gang / RF radio transmitter module 3-gang / RF radio transmitter module 4-gang

Use: Sensor

Design: Mobile

Art. No. ..5071 RF TSM / ..5072 RF TSM / ..5073 RF TSM / ..5074 RF TSM

1.2 Function

If the application program is loaded and, depending on the parameter settings, the KNX RF radio transmitter module sends wireless KNX telegrams when its buttons are pressed. These can be, for instance, telegrams for switching or push button control, for dimming or for controlling blinds. It is also possible to program value transmitter functions (dimming value transmitters and light scene extensions).

Depending on the device variant, the KNX RF radio transmitter module consists of a number of operating areas that are designed as squares or rectangles. Two operating areas lying next to each other are operated like a rocker with two buttons (left and right of use). The function of such a rocker can be configured individually in the ETS. Each rocker has its own KNX communication objects and can therefore actuate KNX actuator groups separately.

The device possesses an button-press display using an LED (colour red). This makes it possible to indicate successful operation and transmission processes. In addition, the radio transmitter module possesses an LED for each rocker as a status display (colour green). The bidirectional communication makes it possible to indicate temporarily states of the KNX actuators immediately after an operation by means of this LED. For this purpose, the device has separate status communication objects.

The activation or status evaluation of cabled KNX systems (Medium TP) can be implemented using an media coupler, which is available as an accessory. Additionally or alternatively, suitable KNX RF actuators can be activated and evaluated directly by the KNX RF radio transmitter module.

After the last operation, the KNX RF radio transmitter module automatically switches to energy-saving mode after a specified time has elapsed. In energy-saving mode, all LEDs remain switched off. During operation, the energy saving mode is exited. The device then executes the programmed button commands.

The device contains a temperature sensor that measures the room temperature cyclically. The determined room temperature can be e.g. evaluated by an room temperature controller as an external temperature value or be displayed by a visualisation.

Device commissioning takes place using the ETS of version 5 or higher. The radio transmitter module does not have a separate programming button or LED. Programming mode is activated by a defined and time-delayed press of the buttons top left and bottom right and signalled by the red actuation LED.

The radio range of the KNX RF radio transmitter module depends on various external circumstances. The range can be optimised by selecting a suitable operating location (communication to the receiver with as few obstacles as possible).

The device corresponds to the directive 2014/53/EU.

1.3 Accessories

Cover kit 1-gang

Cover kit 2-gang

Cover kit 3-gang

Cover kit 4-gang

KNX RF radio converter

Art. No. ..501TSA..

Art. No. ..502TSA..

Art. No. ..503TSA..

Art. No. ..504TSA..

Art. No. MK100RF

2 Installation, electrical connection and operation

2.1 Safety instructions

Electrical equipment may only be installed and fitted by electrically skilled persons. The applicable accident prevention regulations must be observed.

Failure to observe the instructions may cause damage to the device and result in fire and other hazards.

The radio communication takes place via a non-exclusively available transmission path, and is therefore not suitable for safety-related applications, such as emergency stop and emergency call.

2.2 Battery safety instructions

This device or its accessories are supplied with batteries in the form of button cells.

DANGER! Batteries can be swallowed. This can lead directly to death by suffocation. Dangerous substances may cause severe internal burns leading to death within 2 hours. Keep new and used batteries away from children.

Do not use devices if the battery compartment does not close securely and keep away from children.

If you suspect that a battery has been swallowed or is in any orifice of the body, seek immediate medical attention.

WARNING! Improper handling of batteries can result in explosion, fire or chemical burn due to leakage.

Do not heat or throw batteries into fire.

Do not reverse polarity, short-circuit or recharge batteries.

Do not deform or disassemble batteries.

Replace batteries only with an identical or equivalent type.

Remove empty batteries immediately and dispose of in an environmentally friendly manner.

2.2.1 Disposal of batteries



Remove empty batteries immediately and dispose of in an environmentally friendly manner. Do not throw batteries into household waste. Consult your local authorities about environmentally friendly disposal. According to statutory provisions, the end consumer is obligated to return used batteries.

2.3 Device components

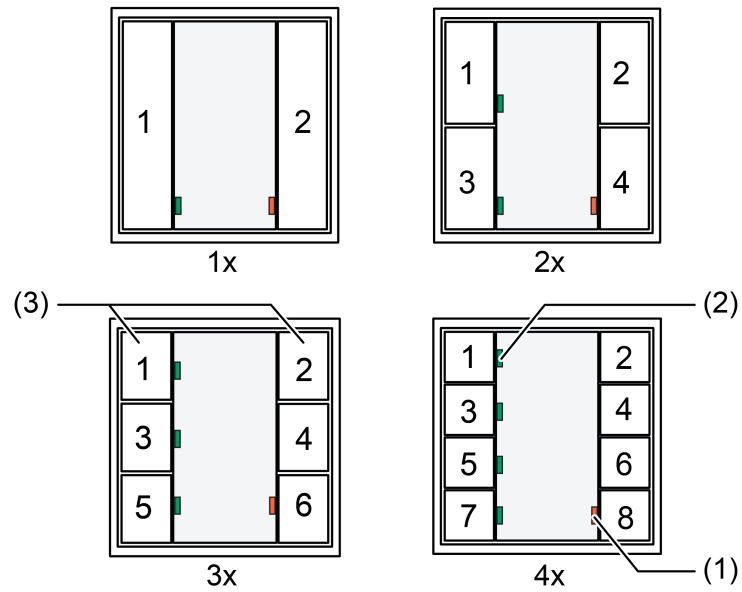

Figure 1: Device components

- (1) LED for send / button-press display (red)
- (2) Status LED (green)
(for each rocker 1 LED)
- (3) Operating areas (buttons left and right form one rocker)

2.4 Mounting

Fitting the device

To ensure good transmission quality, keep a sufficient distance from possible interference sources, e.g., metallic surfaces, microwave ovens, Hi-Fi and TV sets, ballasts or transformers.

- i** Before mounting, insert the battery (see page 10) and perform commissioning (see page 10-11).

Screw mounting

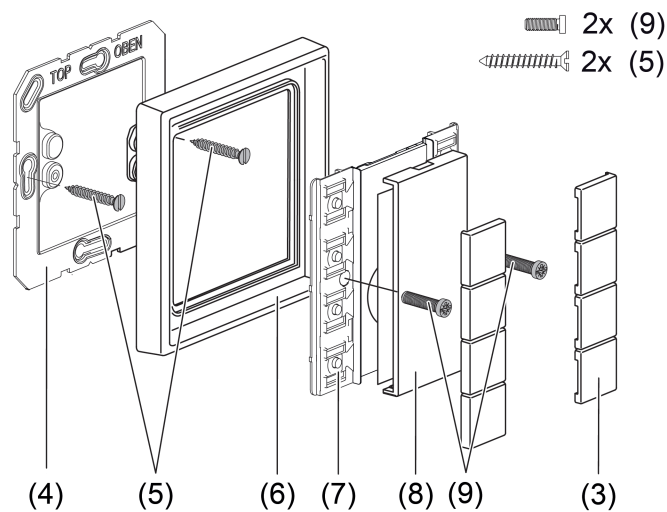

Figure 2

- (3) Operating areas
- (4) Base plate
- (5) Fastening screws for the base plate
- (6) Design frame
- (7) Wall transmitter module
- (8) Cover
- (9) Fastening screws for the wall transmitter module

The operating areas (3) are available as a complete set of buttons.

- Screw the base plate (4) to an even surface with the fastening screws (5) or stick it. The **TOP/OBEN** label has to be at the top.
- Attach design-frame (6) to the base plate.
- Screw the wall transmitter module (7) to the base plate with the fastening screws (9).

- i** Screwing the screws too tightly could impair functions of the wall transmitter.

- Place operating areas (3) on the KNX RF radio transmitter module in the right orientation and snap in with a short push.

Glue mounting

Use the supplied adhesive pad to glue the radio transmitter module directly to an even surface, e.g. glass.

The operating areas (3) are available as a complete set of buttons.

To be able to fasten the wall transmitter safely, the substrate must be flat and free of dust and grease.

- Remove the rear, unpunched film of the enclosed adhesive pad.
- Align the adhesive pad, stick it to the surface and smooth it out. Remove air bubbles.
- Remove the two inner segments of the front film.
- Align the base plate to the external punching and stick it on.

- i** In the case of multiple combinations, the abutting sides of the adhesive pads must be cut along the external punching using a ruler and a cutter (figure 3).

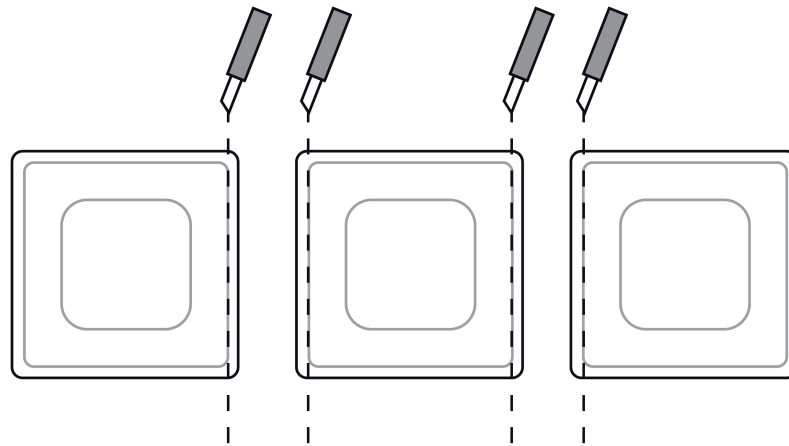

Figure 3: Cutting the adhesive pads for multiple combinations

- i** If necessary, after mounting the wall transmitter in the CD program, carefully remove the excess adhesive film in the corners.
- Attach design-frame (6) to the base plate.
- Screw the wall transmitter module (7) to the base plate with the fastening screws (9).
- i** Screwing the screws too tightly could impair functions of the wall transmitter.
- Place operating areas (3) on the KNX RF radio transmitter module in the right orientation and snap in with a short push.

2.5 Commissioning

Inserting the battery

- i** Obey the battery safety instructions.
 - Carefully remove cover (8) from wall transmitter (figure 2).
 - Keep contacts of batteries and device free of grease.
 - Apply battery to the positive contact of the battery holder. Observe polarity: the positive pole of the battery must be at the top.
 - Press gently on battery to snap it in.
 - Snap on the cover (8).

The wall transmitter is ready for operation.

Programming the addresses and application program

Project design and commissioning with ETS5 or a more recent version.

An appropriate device must be created and configured in the ETS project.

The KNX RF radio transmitter module does not have a separate programming button or LED. Programming mode is activated by a defined and time-delayed press of the upper left and lower right of the pushbutton.

The physical address is programmed as described below...

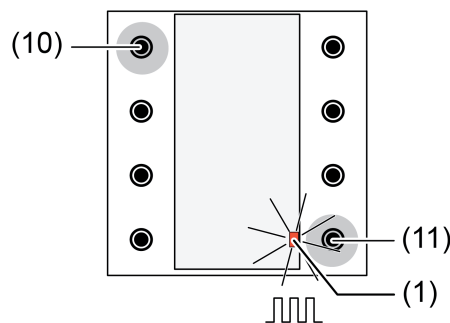

Figure 4: Buttons for activating Programming mode

- Press the button at the top left (10) and keep it depressed. Then (within 200 ms) press the button at the bottom right (11).
The acknowledgement/transmission LED (1) flashes rapidly.
 - Load the physical address into the device. The ETS also automatically loads the domain address of the RF line into the device.
The acknowledgement/transmission LED returns to its previous state – off, on, or flashing slowly.
- i** An active programming mode without access by the ETS is automatically terminated after 1 minute.

- i** When programming the repeater via RF: For the programming of the physical address and the domain address to be carried out and completed correctly, the domain address of the RF line must match the domain address of the RF communication interface (e.g. KNX USB RF data interface or media coupler)! Otherwise, communication errors can be expected. The domain address of the KNX RF USB data interface used by the ETS is configured in the general connection settings of the ETS. In an ETS project, the domain address of an RF line or a media coupler is configured in the line properties (separate for each RF line).

 - Write the physical address and domain address on the device label.
 - Fitting the operating areas
 - Load the application program into the device using the ETS.
- i** After the last operation or general programming of the physical address, the device automatically switches to energy-saving mode after a short time. In energy saving mode, the LEDs remains switched off. If the device is in energy-saving mode, this mode must be actively terminated, before the application program can be programmed by the ETS. This can be done by pressing a button or the programming button. Alternatively, the application program can be programmed into the device together with the addresses.
- i** For devices which have been used for a longer period: Before ETS programming operations, replace the battery with a new, unused one.
- i** If the device does not contain an application program, or the wrong application program (e.g. unloaded application program), then the send/actuation LED (1) flashes slowly for 3 seconds after a button-press.

2.6 Operation

Operating and display functions

Depending on the device variant, the KNX RF radio transmitter module consists of a number of operating areas that are designed as squares or rectangles. Two operating areas lying next to each other are operated like a rocker with two buttons (left and right of use). The function of such a rocker can be configured individually in the ETS. Each rocker has its own KNX communication objects and can therefore actuate KNX actuator groups separately. The function of a rocker can be configured individually to "Switching", "Dimming", "Venetian Blind", "Value transmitter 1-byte" and "Scene extension" and can thus be adjusted flexibly to the operating requirements.

For more detailed information on the operating functions, please refer to the chapter "Software Description" of this documentation (see page 27).

The device possesses an button-press display using an LED (colour red). This makes it possible to indicate successful operation and transmission processes. In addition, the KNX RF radio transmitter module possesses an LED for each rocker as a status display (colour green). The bidirectional communication makes it possible to indicate temporarily states of the KNX actuators immediately after an operation by means of this LED. For this purpose, the device has separate status communication objects.

For more detailed information on the function of the LED display, please also refer to the chapter "Software Description" of this documentation (see page 21).

Invalid operation

If a button is pressed for a time longer than defined by the ETS parameter "Time window for operation..." (available separately for each button), then the device will evaluate this operation as invalid to prevent wear on the battery. The operation is ended correctly (e.g. by sending a Stop telegram during a dimming operation). The device then returns to energy-saving mode immediately. Only a new button-press wakes up the device again.

The device also evaluates the simultaneous pressing of multiple buttons as a wrong operation. If only one button is pressed, the device will execute the configured operating command. If, when the button is held down, a further button is pressed, then the device will not execute any new operating commands. It is first necessary to release all buttons before new commands can be triggered. The same applies if no button is pressed and, in this state, it is as if multiple buttons have been pressed simultaneously. An operating command is only sent as soon as only one button is clearly detected as having been pressed.

- i** If two (or more) buttons are pressed consecutively, then the device only ends the button command executed by the first button-press, assuming that other telegrams are to be executed (e.g. Venetian blind function), when all the buttons have been released.

Battery display

When a button is pressed, the device checks the battery. If a weak or discharged battery is detected, then, after a button actuation, the red send/actuation LED will flash for a period of approx. 3 seconds at a frequency of approx. 0.75 Hz. In the case of such a display, replace the battery with a new one as soon as possible (see page 10).

- i** The battery display is activated as an alternative to the button-press display after a button-press. Battery display also occurs when the function of the red send and actuation LED is configured as "Always OFF".

3 Technical data

General

Test mark	KNX
Rated voltage	DC 3 V
Battery type	1×Lithium CR 2450N
Receiver category	2
Ambient temperature	-5 ... +45 °C
Degree of protection	IP 20
Relative humidity	max. 80 % (No moisture condensation)

KNX

KNX medium	RF1.R
Commissioning mode	S-mode
Radio frequency	868.0 ... 868.6 MHz
Transmission capacity	max. 20 mW
Transmitting range in free field	typ. 100 m

Internal temperature sensor

Measuring range	-5 ... +45 °C
-----------------	---------------

4 Software description

4.1 Software specification

ETS search paths: - Radio / Radio transmitter modules / RF radio transmitter module 1-gang
 - Radio / Radio transmitter modules / RF radio transmitter module 2-gang
 - Radio / Radio transmitter modules / RF radio transmitter module 3-gang
 - Radio / Radio transmitter modules / RF radio transmitter module 4-gang

Configuration: S-mode standard

Application for KNX RF radio transmitter module 1-gang:

No.	Short description	Name	Version	from mask version
1	Application with 1 operating rocker and an LED as a button-press and status display.	RF radio transmitter module 1-gang D11111	1.1 from ETS5	27B0

Application for KNX RF radio transmitter module 2-gang:

No.	Short description	Name	Version	from mask version
1	Application with 2 operating rockers and LED as a button-press and status display.	RF radio transmitter module 2-gang D11211	1.1 from ETS5	27B0

Application for KNX RF radio transmitter module 3-gang:

No.	Short description	Name	Version	from mask version
1	Application with 3 operating rockers and LED as a button-press and status display.	RF radio transmitter module 3-gang D11311	1.1 from ETS5	27B0

Application for KNX RF radio transmitter module 4-gang:

No.	Short description	Name	Version	from mask version
1	Application with 4 operating rockers and LED as an actuation and status display.	RF radio transmitter module 4-gang D11411	1.1 from ETS5	27B0

4.2 Software "KNX RF radio transmitter module"

4.2.1 Scope of functions

Scope of functions

General:

- Actuation signalling and send display via a red LED. Status displays via a separate LED for each rocker.
- The LED light period can be configured.
- Status display optionally via separate 1-bit status communication objects.
- Send/actuation display can be switched off.

"Switching" function:

- Rocker or button function
- Command on pressing and releasing the buttons can be configured (ON, OFF, TOGGLE, no reaction).

"Dimming" function:

- Rocker function
- Command on pressing the rocker (left and right button) can be configured (brighter - ON, darker - OFF).
- Time between switching and dimming can be set.

Function "Venetian blind":

- Rocker function
- Command on pressing the rocker (left and right button) can be configured (UP, DOWN, TOGGLE).
- Time between short and long time commands and slat adjusting time can be set.

"Value transmitter" and "Scene extension" functions:

- Rocker function
- Command on pressing the rocker (left and right button) can be configured (1 byte values 0...255 or 0...100% / 2 byte temperature or brightness values or values 0...65535 / scene numbers).
- Storage function possible with scene extension.

Function "Room temperature measurement":

- Internal temperature sensor for cyclical room temperature measurement (cycle time parameterizable).
- Temperature calibration can be configured for the temperature sensor.
- Automatic transmission of the last determined room temperature (cyclically and after change interval).

4.2.2 Notes on software

Activation and status evaluation

The activation or status evaluation of cabled KNX systems (Medium TP) can be implemented using an media coupler, which is available as an accessory. Additionally or alternatively, suitable KNX RF actuators can be activated and evaluated directly by the KNX RF radio transmitter module.

After the last operation, the device automatically switches to energy-saving mode after a specified time has elapsed. In energy-saving mode, all LEDs remain switched off. During operation, the energy saving mode is exited. The device then executes the programmed button commands.

4.2.3 Object table

Number of communication objects:	Depends on the device variant and the set function. 4-gang max. 13 3-gang max. 10 2-gang max. 7 1-gang max. 4
Number of addresses (max):	100
Number of assignments (max):	100

Objects for "switching"

Function:	Switching				
Object	Function	Name	Type	DPT	Flag
 1, 3, 5, 7	Switching	Rocker 1-4 ¹	1-bit	1.xxx	C, W, T, A
Description	1-bit object for transmission of switching telegrams (ON, OFF).				

Objects for "dimming"

Function:	Switching				
Object	Function	Name	Type	DPT	Flag
 1, 3, 5, 7	Switching	Rocker 1-4 ¹	1-bit	1.xxx	C, W, T, A
Description	1-bit object for transmission of switching telegrams (ON, OFF).				

Function:	Dimming				
Object	Function	Name	Type	DPT	Flag
 9, 11, 13, 15	Dimming	Rocker 1-4 ¹	4-bit	3.007	C, W, T, A
Description	4-bit object for the transmission of relative dimming telegrams (dim brighter, dim darker).				

Objects for "Venetian blind"

Function:	Venetian blind				
Object	Function	Name	Type	DPT	Flag
 1, 3, 5, 7	Short time operation	Rocker 1-4 ¹	1-bit	1.007	C, -, T, A
Description	1-bit object for the transmission of telegrams with which a Venetian blind or shutter drive motor can be stopped or with which the blind slats can be adjusted by short time operation.				

1: The number of rockers or buttons depends on the planned device variant.

Function: Venetian blind

Object	Function	Name	Type	DPT	Flag
 9, 11, 13, 15	Long-time operation	Rocker 1-4 ¹	1-bit	1.008	C, W, T, A

Description 1-bit object for the transmission of telegrams with which a Venetian blind or shutter drive motor can be moved upwards or downwards.

Objects for "1 byte value transmitter"

Function: 1-byte value transmitter

Object	Function	Name	Type	DPT	Flag
 1, 3, 5, 7	Value	Rocker 1-4 ¹	1 byte	5.001, 5.010	C, -, T, A

Description 1-byte object for the transmission of values from 0 to 255 (corresponding to values from 0 % to 100 %).

Objects for "2 byte value transmitter"

Function: Temperature value transmitter

Object	Function	Name	Type	DPT	Flag
 1, 3, 5, 7	Temperature value	Rocker 1-4 ¹	2 byte	9.001	C, -, T, A

Description 2-byte object for the transmission of temperature values in the range between 0 and 40 °C.

Function: Brightness value transmitter

Object	Function	Name	Type	DPT	Flag
 1, 3, 5, 7	Brightness value	Rocker 1-4 ¹	2 byte	9.004	C, -, T, A

Description 2-byte object for the transmission of brightness values in the range between 0 and 1,500 Lux.

Function: 2-byte value transmitter

Object	Function	Name	Type	DPT	Flag
 1, 3, 5, 7	Value	Rocker 1-4 ¹	2 byte	7.001	C, -, T, A

Description 2-byte object for the transmission of values in the range between 0 and 65,535.

1: The number of rockers or buttons depends on the planned device variant.

Objects for "scene extension"

Function: Scene extension

Object	Function	Name	Type	DPT	Flag
 1, 3, 5, 7	Scene extension	Rocker 1-4 ¹	1 byte	18.001	C, -, T, A

Description: 1-byte object for recalling or for storing one of max. 64 scenes on an actuator, scene controller or scene push-button sensor.

Objects for "Status indication"

Function: Status indication

Object	Function	Name	Type	DPT	Flag
 17, 18, 19, 20	Switching	Rocker 1-4 status ₁	1-bit	1.xxx	C, W, -, A

Description: 1-bit object for activation of the status LED (polarity and status evaluation can be configured).

Object for "Room temperature measurement"

Function: Room temperature measurement

Object	Function	Name	Type	DPT	Flag
 ²⁵	Measured temperature	Room temperature measurement	2 byte	9.001	C, -, T, -

Description: 2-byte object for the transmission of the room temperature measured by the device. The output value takes the configured value for calibration into account. Measuring range of internal temperature sensor: - 5 °C ... + 40 °C
The temperature value is always output in the format "°C".

1: The number of rockers or buttons depends on the planned device variant.

4.2.4 Functional description

4.2.4.1 Display functions

Operation and status display

The device possesses a button actuation and status display which uses multiple LEDs. Actuation signalling and the send display take place via a red LED. Status displays occur via a separate green LED for each rocker. This makes it possible to indicate successful operation and sending processes directly on the device. The bidirectional communication makes it possible to indicate temporarily states of the KNX actuators immediately after an operation by means of the green LEDs. For this purpose, the device has separate status communication objects.

The operating and display concept intends two phases of the LED display. In the first display phase, the user is given feedback on the button-press using the red send / button-press display. Then, there is always a pause of 0.5 s, during which all LEDs are switched off. Then there is the second display phase, in which the green status LED of a rocker function displays a received actuator status - with the scene extension function with memory function - the triggering of a memory telegram is signalled. In addition, transmission errors can be displayed.

- **First display phase:**

If a button is pressed, the red button-press display is activated for the illumination length set in the ETS. The display goes out after the set time has elapsed. A longer button actuation (e.g. during dimming) or the release of the button has no further influence on the button-press display.

The send operation is monitored by the device during the first display phase. If a transmission error was detected (e.g. radio interference, communication object does not have a group address), then, in the second display phase, the red LED flashes to indicate a transmission error. The send operation is then cancelled.

The red send and actuation display can be optionally switched off. In the "Always OFF" setting, the parameter "Function of the red send and actuation LED" on the "General" parameter page means that there is no button-press display for any of the operating buttons. This deactivates the first display phase. However, the signalling of a transmission error in the second display phase and the display of a weak or void battery still functions. The display pause also remains active after the first phase, meaning that an actuator status is displayed at least 0.5 seconds after a button-press.
- **Second display phase:**

In the second display phase, the ON/OFF feedback of an actuator can be displayed. For this, each operating rocker has separate 1-bit LED communication objects. Any 1-bit feedback functions of the activated KNX actuators can be connected to these status objects. The parameters "Status display function" on the "Status" parameter pages of each operating rocker define whether the status display is used. In the "Always OFF" setting, the status function of the appropriate rocker, and thus the second display phase, is deactivated. In the "LED Object..." settings, the status object of a rocker is available. When selecting the setting, it is also possible to define which object status is displayed by the LED of the actuated button (ON / OFF).

Just as in the first display phase, the green LEDs for the status display light up for the illumination period generally set in the ETS.

If, during the first display phase, a transmission error was identified (telegram of the operating function could not be sent), then the green LEDs do not display an actuator status in the second display phase. In this case, the error is signalled by the red LED slowly flashing for 3 seconds (figure 11).

- i** In the "Switching" function, the operating concept can be configured as "Rocker function" or alternatively as "Push-button function". With a button function, each operating area can possess one status object (left button, right button). This means that different actuator feedback can be signalled. However, it should be ensured that both status objects activate the same status LED. The display functions of both buttons of an operating area do not override each other. A new button-press always interrupts an executed display function immediately (figure 10). Also, with the rocker function, only one status object is available for two operating area lying next to each other.
- i** The status display function is functionally dependent on the telegram sequence of the configured operating function (Switching, Dimming, Venetian blind...). The "Rocker and button functions" chapter of this documentation describes the functional dependencies in more detail (see page 27).

In the second display phase of the LED, it is possible to signal the status of an actuator channel (figure 5) as a single status. With the display of a single status, the ON or OFF status is signalled by the illumination of the LED. The "Status display function" parameter on the "Status" parameter pages specifies which status of the 1-bit feedback should be displayed.

Due to the energy-saving operation of the transmitter, the actuator feedback must be received in a defined time window after the button operation. This time is defined individually for each rocker by the parameter "Time window for status display" (1...120 s). With each telegram that the device sends successfully on a button actuation, the time window configured in the ETS for the status display is retriggered (figure 6).

After the time has elapsed, the transmitter switches back to energy-saving mode. Feedback telegrams arriving at the device outside the defined time window for the status display are not evaluated by the LED.

- i** During an open time window, the device remains ready to receive, even telegrams coming from the ETS. This means that any button-press can open a time window for an ETS programming operation.

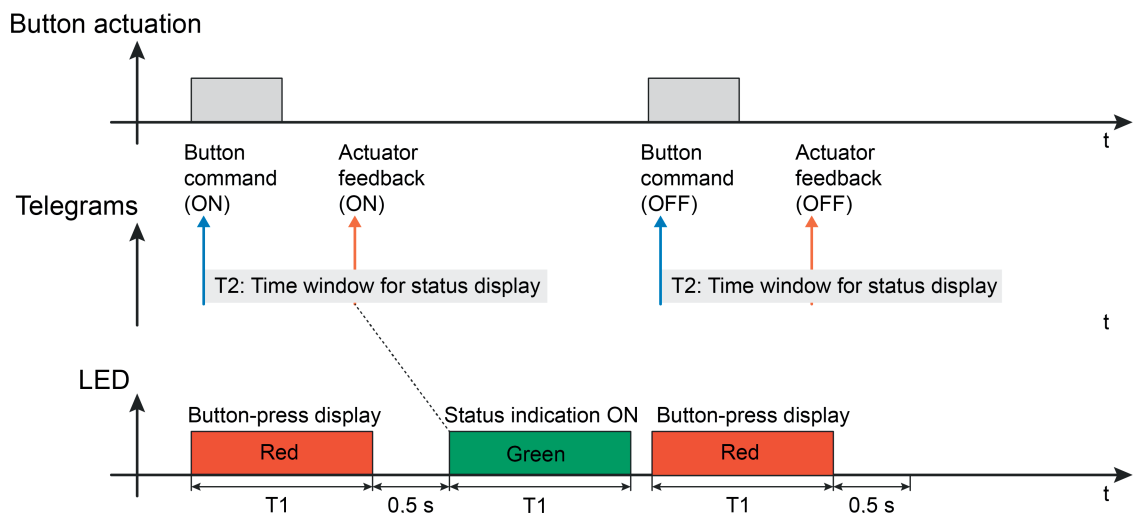

Figure 5: Example of a two-level actuation and status display
Status display state "ON" through green LED

T1 Time according to the parameter "Lighting time of all LEDs" (global for all operating rockers)

T2 Time according to the parameter "Time window for actuator feedback" (separate for each button)

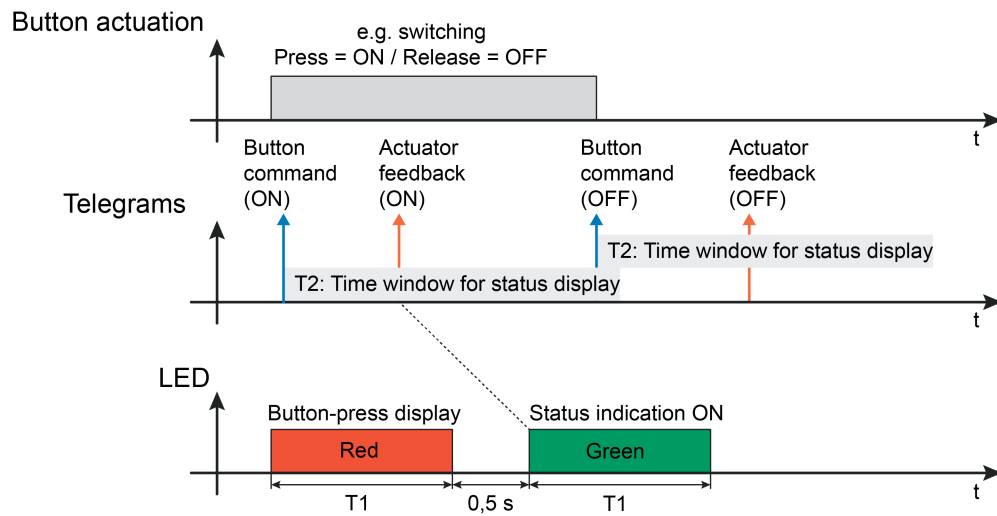

Figure 6: Example of a two-level actuation and status display for actuator feedback
New time window for status display through multiple operating telegrams

Each telegram that the transmitter has triggered through continued operation will always trigger a new time window for status display. The device terminates a status display of the first time window executed by the LED if, during this time, new actuator feedback is received in the second time window (figure 7).

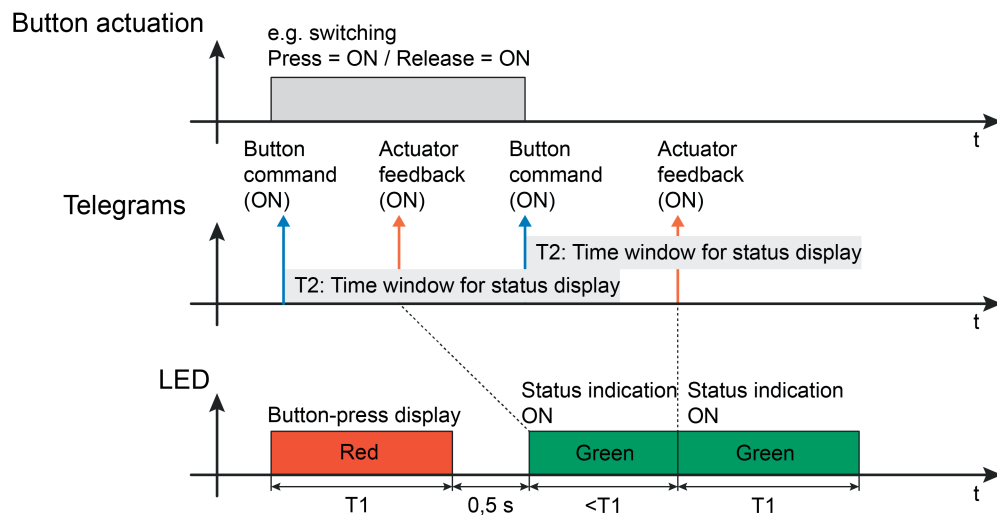

Figure 7: Example of a two-level actuation and status display for actuator feedback
Interruption of the first status display through the actuator status in the new time window

The parameters "Terminate time window for status display after first actuator feedback ?" on the "Status" parameter pages define whether, within a time window for status display, only the first actuator feedback is evaluated and has an LED display or whether additional feedback

telegrams will be displayed during the same time period. In the "No" setting, all the feedback is evaluated within the specified time window. Any received feedback telegram will trigger the status display according to the configured polarity (ON and/or OFF), according to the defined colour (figure 8).

In the "Yes" setting, only the first actuator status telegram received by the transmitter in the time window of the status display is displayed. At the same time, the transmitter ends the time window. As a result, any further status telegrams are ignored (figure 9).

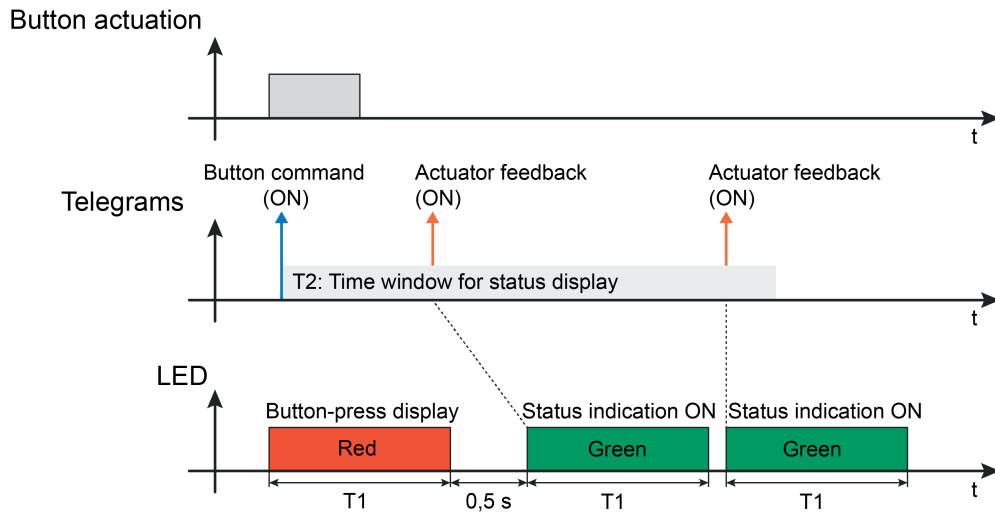

Figure 8: Example of a two-level actuation and status display for actuator feedback
Reception of two actuator status messages in time window permitted

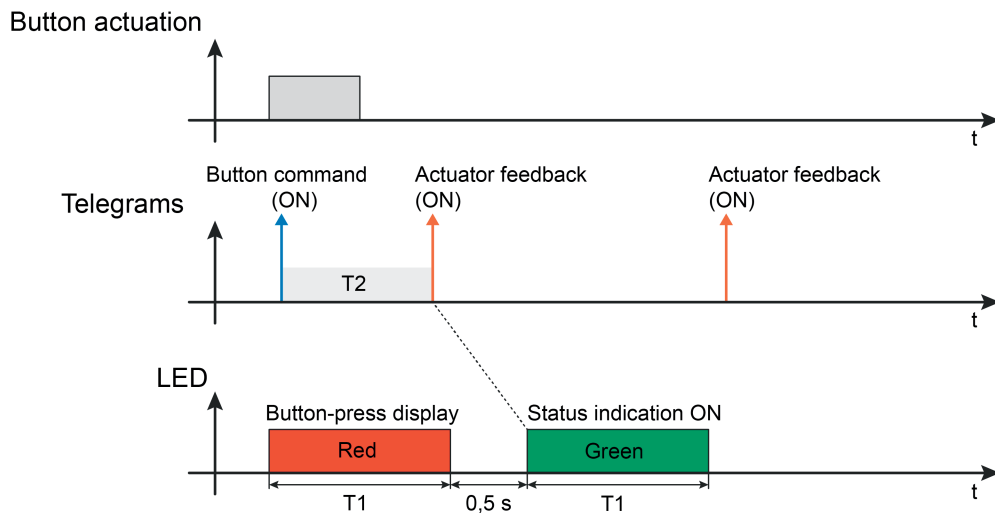

Figure 9: Example of a two-level actuation and status display for actuator feedback
Reception of two actuator status messages in time window not permitted

The status functions of the operating rockers always only control the LED of the affected rocker. A new button actuation of the same (most recently pressed) button of the rocker or any other

button will interrupt the executed display function immediately and at any time (figure 10). Cancellation can also occur if no status has been signalled for the started display function.

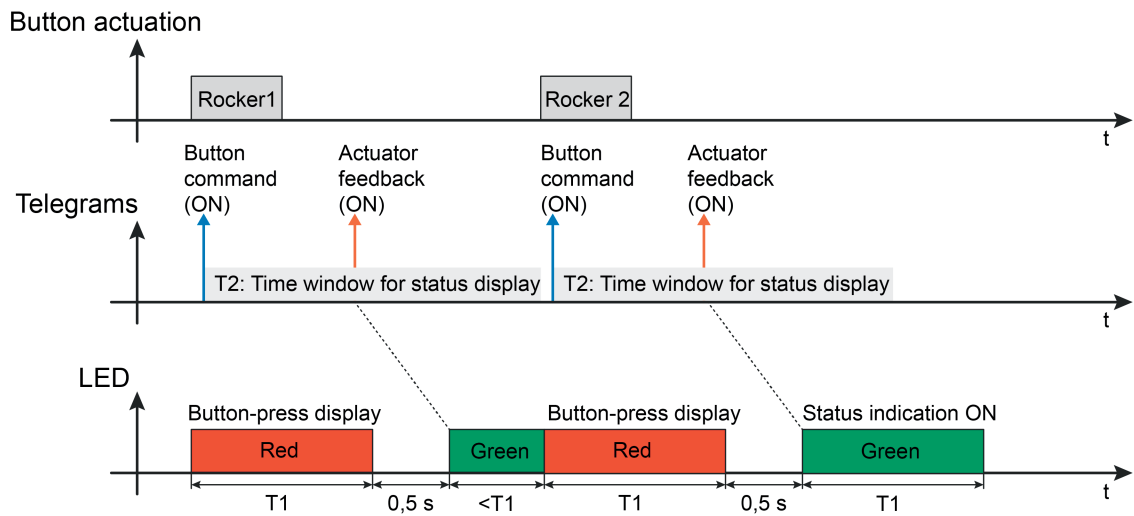

Figure 10: Example of a two-level actuation and status display
Interruption of the display function through new button actuation

Display of transmission errors

The red LED of the device displays a transmission error. The send operation of a telegram is monitored by the device after a button-press. If the device was unable to send a radio telegram 5 seconds after the button-press (e.g. radio fault, communication object has no group address), then the send / actuation LED will display an error by flashing red slowly for 3 seconds. All the other display functions (actuator status) are then suppressed.

The display of a transmission error also takes place when the function of the red send and actuation LED is switched off (parameter "Function of the red send and actuation LED?" set to "Always OFF").

Immediately after a button actuation, the red LED displays an actuation, if enabled in the parameters. This also occurs if a transmission error is detected later on.

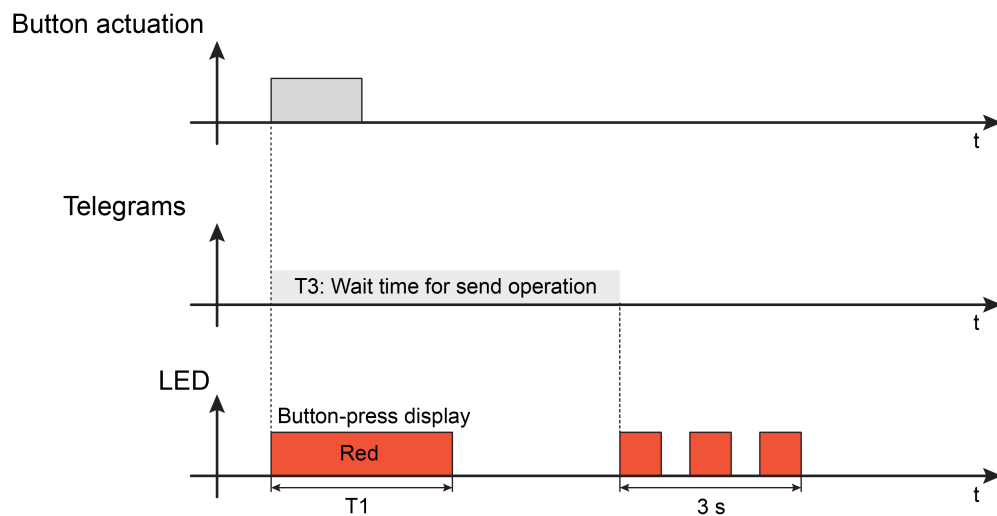

Figure 11: LED display in the case of a transmission error

T3 Wait time for send operation (permanently set to 5 seconds)

Battery display

When a button is pressed, the device checks the battery. If a weak or discharged battery is detected, then, after a button actuation, the red send / button-press display will flash for a period of approx. 3 seconds at a frequency of approx. 0.75 Hz. In the case of such a display, replace the battery with a new one as soon as possible (see chapter 2.5. Commissioning).

- i** A configured status display (second display phase) is not influenced by the battery display.
- i** The battery display is activated as an alternative to the button-press display after a button-press. Battery display also occurs when the function of the red send and actuation LED is configured as "Always OFF".

4.2.4.2 Rockers and button functions

The following section contains descriptions of the various operating functions that can be configured individually for each rocker. The display functions using the LEDs of the device are also influenced by the operating functions, which is why, in the following chapters, the function-specific LED functions are also described.

4.2.4.2.1 Function "Switching"

Depending on the device variant, the KNX RF radio transmitter module consists of operating areas that are designed as squares or rectangles. The operating concept of an operating area can be configured in the "Switching" function in the ETS either as a rocker function or alternatively as a button function.

- Rocker function:
If a button pair is used as a rocker, both buttons jointly affect the communication object assigned to the rocker. This can cause an actuator channel to be activated. Usually, pressing both sides of the rocker on the left or right can lead to directly opposite commands (e.g. switching: left ON - right OFF). Generally, the commands when the left and right rockers are pressed or released should be defined independently of each other.
- Button function:
With a button function, operating areas lying next to each other affect separate communication objects, independently of one another. As a result, two actuator channels can be activated.

When using the rocker and button function, it is possible to define through the use of the parameter "Command on pressing the rocker / button" or "Command on releasing the rocker / button" which switching command sends the appropriate communication object. This means that a simple switching function (ON, OFF, TOGGLE) can be implemented, as can ON/OFF buttons (e.g. bell push-button function - press button ON, release button OFF). No distinction is made between a brief or long actuation in the "Switching" function.

The device possesses a button actuation and status display which uses multiple LEDs. Actuation signalling and the send display take place via a red LED. Status displays occur via a separate green LED for each rocker. This makes it possible to indicate successful operation and sending processes directly on the device. The bidirectional communication makes it possible to indicate temporarily states of the KNX actuators immediately after an operation by means of the green LEDs. For this purpose, the device has separate status communication objects. If the LED status function of a rocker is being used, then the pressing and releasing of a button has an impact on the evaluation of the status information. If a telegram is only sent when a button is pressed, the transmitter only activates a time window for status display (figure 12). If the device sends a telegram on pressing and releasing, then the time window for status display is triggered twice. This means that, in the thus extended time, the device can receive status telegrams of the actuators as a reaction to the different operating specifications and display them (figure 13).

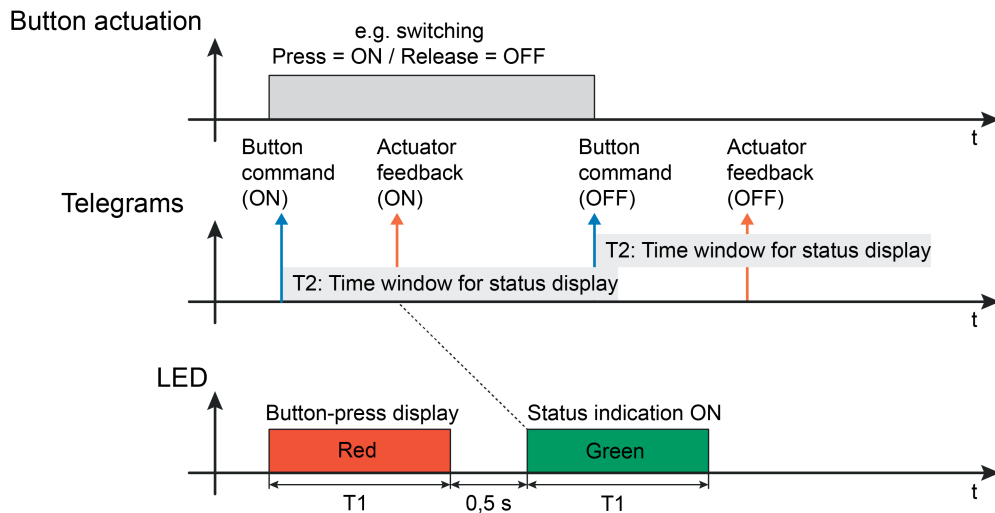

Figure 12: Example of a status display with the operating function "Switching" Telegram on pressing the button

- T1 Time according to the parameter "Lighting time of all LEDs" (global for all operating rockers)
- T2 Time according to the parameter "Time window for actuator feedback" (separate for each button)

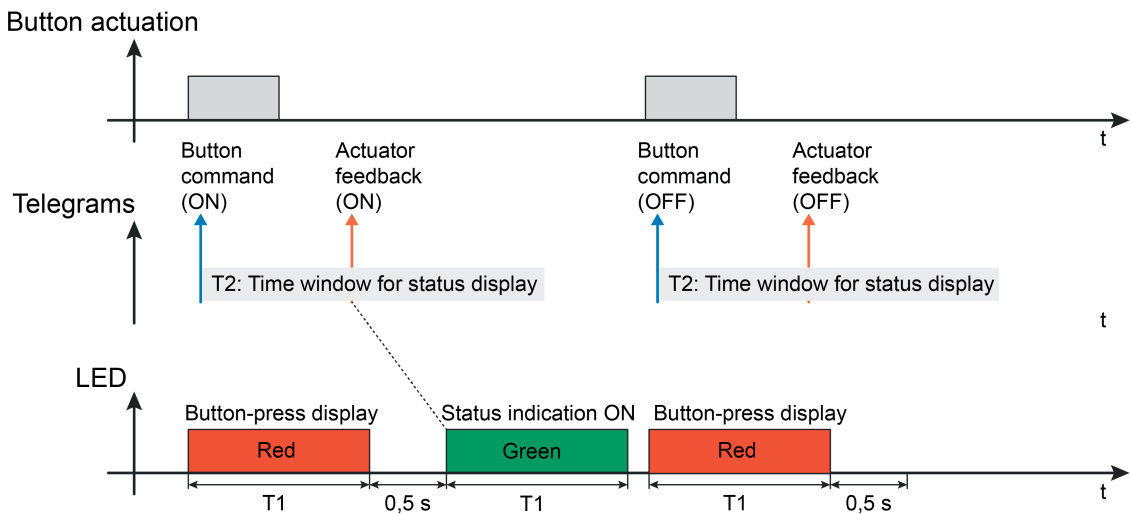

Figure 13: Example of a status display with the operating function "Switching" Telegram on pressing and releasing the button

- i** With the button function and dual-area operation, operating areas lying next to each other can possess two status objects (left button, right button). This means that different actuator feedback can be signalled. However, it should be ensured that both status objects activate the same status LED. The display functions of both buttons of an operating area do not override each other. A new button-press always interrupts an executed display function immediately. Also, with the rocker function, only one status object is available.

- i** Refer to the chapter "Display functions" of this documentation for application principles and supplementary information on the LED display (see chapter 4.2.4.1. Display functions).

4.2.4.2.2 Function "Dimming"

For each rocker with the function set to "Dimming", the ETS indicates a 1-bit object and a 4-bit object. Generally, the device transmits a switching telegram after a brief press and a dimming telegram after a long press. A telegram for stopping the dimming process is always sent when releasing the push-button after a long press. The length of time the button operation must last until it is detected as a long actuation can be set using the parameters "Time between switching and dimming".

The parameters "Command on pressing rocker..." define the operating command output on a short and long button-press ("Brighter (ON)", "Darker (OFF)"). Here, any command can be assigned to the left or right button of the rocker.

In dimming mode, the device transmits a telegram at the beginning of an actuation in order to start the dimming process (dimming step width 100%). A stop telegram is triggered at the end of operation. No telegram repetition occurs.

The device possesses a button actuation and status display which uses multiple LEDs. Actuation signalling and the send display take place via a red LED. Status displays occur via a separate green LED for each rocker. This makes it possible to indicate successful operation and sending processes directly on the device. The bidirectional communication makes it possible to indicate temporarily states of the KNX actuators immediately after an operation by means of the green LEDs. For this purpose, the device has separate status communication objects. If the LED status function of a rocker is being used, then the short and long operation of a button have different impacts on the evaluation of the status information. With a short button actuation (Switching), only a time window is triggered for status display (figure 14). With a longer operation (Dimming), two time windows are activated, to be able to react to status changes after the Stop telegram (figure 15), should status changes occur.

- i** Ideally, the 1-bit feedback object of the switching status of KNX dimming actuators is linked to the status object of the transmitter. The time window for the status display should, ideally, be at least as long as the dimming operation from the OFF status up to the maximum brightness.

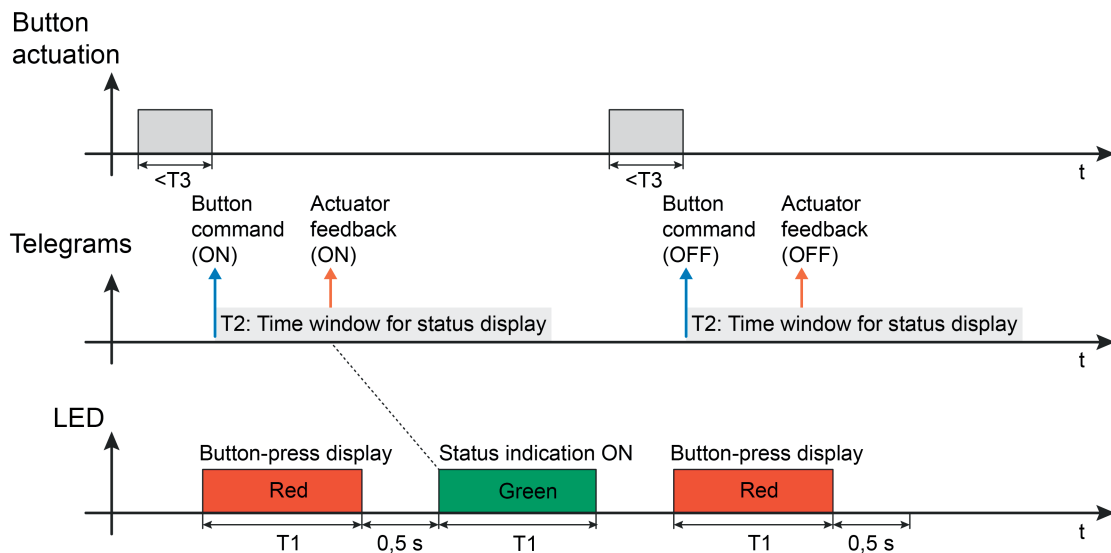

Figure 14: Example of a status display with the operating function "Dimming" with a short button-press

T1 Time according to the parameter "Lighting time of all LEDs" (global for all operating rockers)

- T2 Time according to the parameter "Time window for actuator feedback" (separate for each button)
- T3 Time between switching and dimming

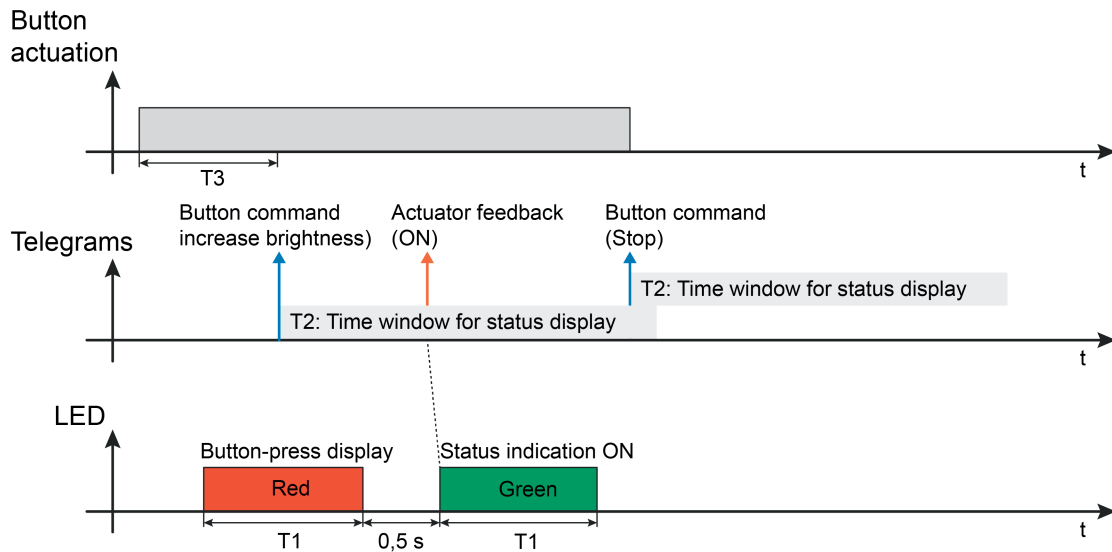

Figure 15: Example of a status display with the operating function "Dimming" with a long button-press

- i** Refer to the chapter "Display functions" of this documentation for application principles and supplementary information on the LED display (see chapter 4.2.4.1. Display functions).

4.2.4.2.3 Function "Venetian blind"

For each rocker with the function set to "Venetian blind", the ETS indicates the two 1-bit objects "Short-time operation" and "Long-time operation". For the control of Venetian blind, roller shutter, awning or similar drives, the device supports the operating concept "Long - short or short", in which the telegrams are transmitted with variable time sequences.

Figure 16: Operation concept "long – short or short"

When a button is pressed, the device shows the following behaviour:

- Immediately on pressing the button, the transmitter starts time T3 ("Time between short-time and long-time command") and waits. If the button is released again before T3 has elapsed, the device transmits a short-time telegram (STEP). This telegram can be used to stop a running drive. A stationary drive rotates the slats by one level.
- If the button is kept depressed after T3 has elapsed, the device transmits a long-time telegram (MOVE) and starts time T4 ("Slat adjusting time").
- If the button is released within T4, the device sends another short time telegram. This function is used for adjusting the slats of a blind. The function permits stopping the slats in any position during their rotation.
The "slat adjusting time" should be chosen as required by the drive for a complete rotation of the slats. If the "slat adjusting time" is selected longer than the complete travelling time of the drive, a pushbutton function is possible as well. This means that the drive is active only when the button is kept depressed.
- If the button is kept depressed for longer than T4, the device transmits no further telegram. The drive remains on until the end position is reached.

The parameters "Command on pressing rocker..." define the operating command output on a short and long button-press ("DOWN", "UP", "TOGGLE"). Here, any command can be assigned to the left or right button of the rocker.

The device possesses a button actuation and status display which uses multiple LEDs. Actuation signalling and the send display take place via a red LED. Status displays occur via a separate green LED for each rocker. This makes it possible to indicate successful operation and sending processes directly on the device. The bidirectional communication makes it possible to indicate temporarily states of the KNX actuators immediately after an operation by means of the green LEDs. For this purpose, the device has separate status communication objects. If the LED status function of a rocker is being used, then the short and long operation of a button have different impacts on the evaluation of the status information. With a short button actuation (only STEP), only a time window is triggered for status display (figure 17). With a longer operation (MOVE plus STEP during the slat adjusting time), two time windows are optionally activated to be able to react to status changes after the STEP telegram (figure 18), should status changes occur.

- i** Ideally, the 1-bit feedback object of the drive movement of KNX Venetian blind or roller shutter actuators is linked to the status object of the transmitter (drive movement = ON, no drive movement / stop = OFF). In order to display the actuator feedback "ON" and "OFF" securely, the time window for the status display should be at least as long as the blind/shutter movement of the drive from the lower to the upper end position. Here, it should be noted that long-time windows have a negative influence on the lifespan of the battery. If the "ON" status (drive movement is being executed) is to be displayed as a status, then the time windows for status display can be made shorter (approx. 3...5 seconds).

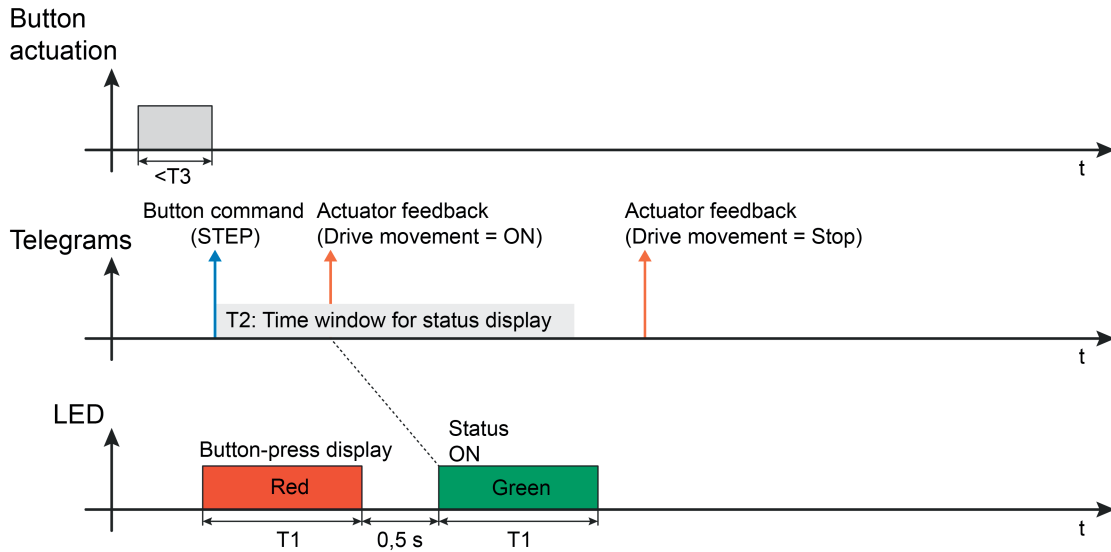

Figure 17: Example of a status display with the operating function "Venetian blind" with a short button-press

- T1 Time according to the parameter "Lighting time of all LEDs" (global for all operating rockers)
- T2 Time according to the parameter "Time window for actuator feedback" (separate for each button)
- T3 Time between short-time and long-time command

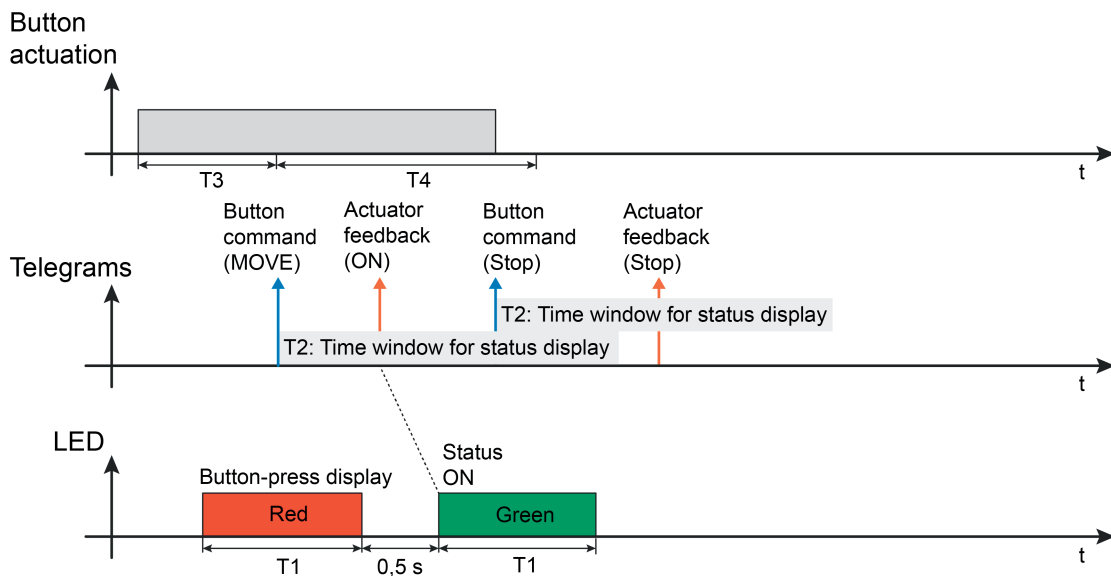

Figure 18: Example of a status display with the operating function "Venetian blind" with a long button-press

- T4 Slat adjusting time
- i** Refer to the chapter "Display functions" of this documentation for application principles and supplementary information on the LED display (see chapter 4.2.4.1. Display functions).

4.2.4.2.4 Function "Value transmitter 1 byte"

If the rocker function is configured to "Value transmitter 1 byte", then the ETS will display a 1-byte object. On pressing a button, the configured value is transmitted to the bus. It is possible to configure different values for both buttons of a rocker.

The "Function" parameter determines which value transmitter data format is to be used. The device can optionally transmit integers from 0...255 or relative values within a range of 0...100% (e.g. as dimming value transmitter).

Function	DPT	Value range
Value transmitter 0...255	5.010	0...255
Value transmitter 0...100 %	5.001	0 %...100 %

Data formats of the different 1-byte value transmitters

The device possesses a button actuation and status display which uses multiple LEDs. Actuation signalling and the send display take place via a red LED. Status displays occur via a separate green LED for each rocker. This makes it possible to indicate successful operation and sending processes directly on the device. The bidirectional communication makes it possible to indicate temporarily states of the KNX actuators immediately after an operation by means of the green LEDs. For this purpose, the device has separate status communication objects.

If the LED status function of a rocker is being used, then only the pressing of a button has an impact on the evaluation of the status information with the value transmitter. With a button actuation, the transmitter activates the time window for the status display (figure 19).

- i** Ideally, the 1-bit feedback object of the switching status of, for example, KNX dimming actuators is linked to the status object of the transmitter. The time window for the status display should, ideally, be at least as long as the dimming operation from the OFF status up to the maximum brightness, so that it is possible to react to all the brightness value changes. With other value transmitter applications (e.g. limit value specifications), it is usually possible to do without a status display.

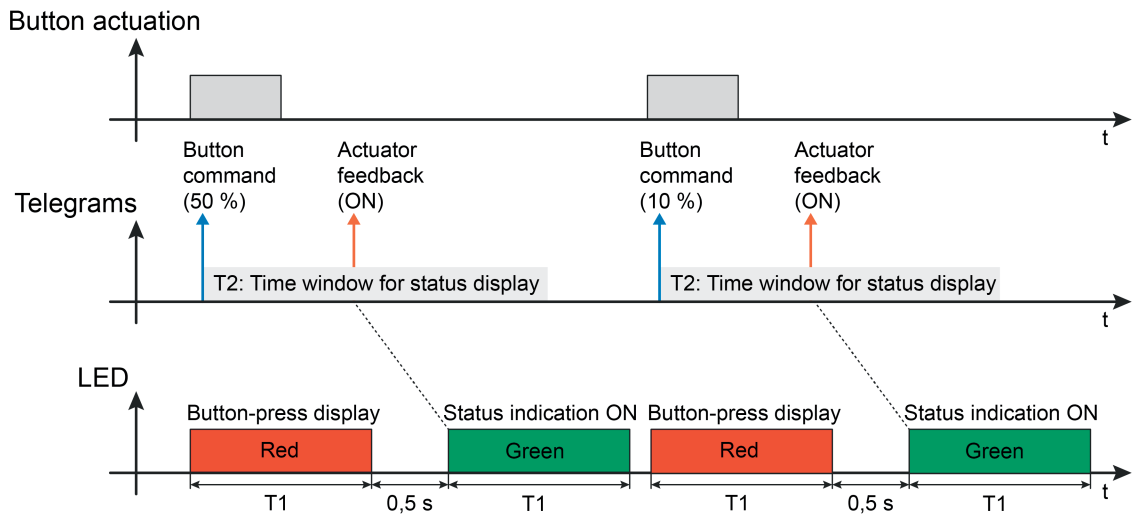

Figure 19: Example of a status display with the operating function "Value transmitter 1-byte" Telegram on pressing the button

- T1 Time according to the parameter "Lighting time of all LEDs" (global for all operating rockers)
- T2 Time according to the parameter "Time window for actuator feedback" (separate for each button)
- i** Refer to the chapter "Display functions" of this documentation for application principles and supplementary information on the LED display (see chapter 4.2.4.1. Display functions).

4.2.4.2.5 Function "Value transmitter 2 byte"

If the rocker function is configured to "Value transmitter 2 byte", then the ETS will display a 2-byte object. On pressing a button, the configured value is transmitted to the bus. It is possible to configure different values for both buttons of a rocker.

The "Function" parameter determines which value transmitter data format is to be used. As a 2-byte value transmitter, the device can optionally transmit integers from 0 ... 65535, temperature values within a range of 0 ... 40 °C or brightness values from 0 ... 1500 lux.

Function	DPT	Value range	Parameterizable step width
Temperature value transmitter	9.001	0 °C ... 40 °C	1 °C
Brightness value transmitter	9.004	0 lux ... 1,500 lux	50 lux
Value transmitter (0...65535)	7.001	0 ... 65,535	1

Data formats of the different 2-byte value transmitters

The device possesses a button actuation and status display which uses multiple LEDs. Actuation signalling and the send display take place via a red LED. Status displays occur via a separate green LED for each rocker. This makes it possible to indicate successful operation and sending processes directly on the device. The bidirectional communication makes it possible to indicate temporarily states of the KNX actuators immediately after an operation by means of the green LEDs. For this purpose, the device has separate status communication objects.

If the LED status function of a rocker is being used, then only the pressing of a button has an impact on the evaluation of the status information with the value transmitter. With a button actuation, the transmitter activates the time window for the status display (figure 20).

- i** It depends on the application, which actuator feedback is used as a status indicator. At a temperature transmitter for example, the active heating message of room temperature controller can be evaluated as 1-bit status information (if supported by the controller). The time window for the status display should, ideally, be at least as long as the time for calculating new control values by the controller (usually 30 seconds). With other value transmitter applications (e.g. limit value specifications), it is usually possible to do without a status display.

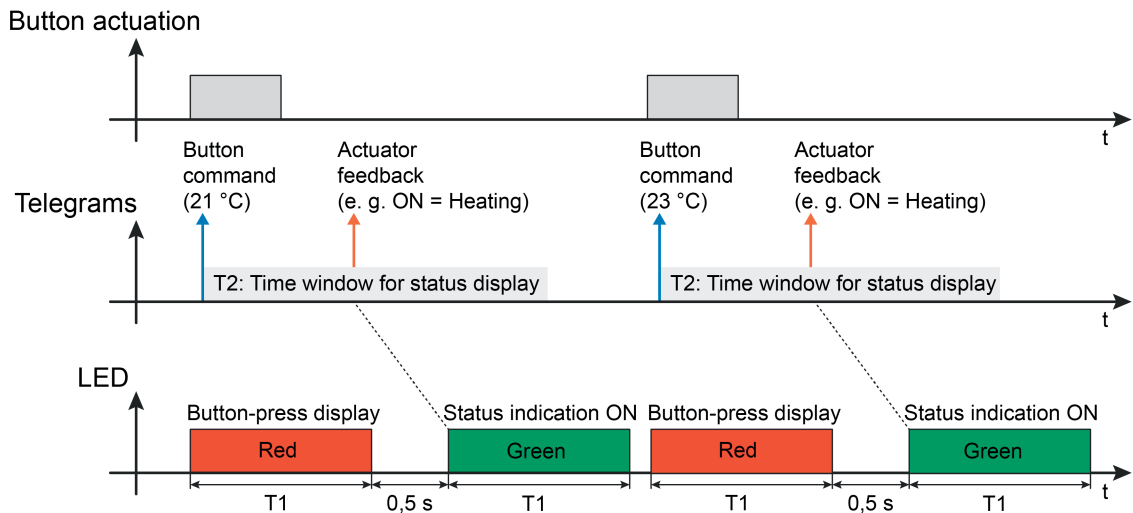

Figure 20: Example of a status display with the operating function "Value transmitter 2-byte" Telegram on pressing the button

- T1 Time according to the parameter "Lighting time of all LEDs" (global for all operating rockers)
 - T2 Time according to the parameter "Time window for actuator feedback" (separate for each button)
- i** Refer to the chapter "Display functions" of this documentation for application principles and supplementary information on the LED display (see chapter 4.2.4.1. Display functions).

4.2.4.2.6 Function "Scene extension"

With the rocker function set to "Scene extension", which possesses a 1-byte communication object according to the KNX data point type 18.001, the ETS shows the "Function" parameter which distinguishes between the following settings...

- "Scene extension without storage function"
- "Scene extension with storage function"

In the scene extension function, the device transmits a preset scene number (1...64) via a communication object to the bus after a button-press. This feature permits recalling scenes stored in other devices and also storing them, if the storage function is used.

In the setting "... without storage function", a button-press triggers the simple recall of a scene. A long button-press has no further effect.

In the setting "... with storage function", the length of the actuation is monitored. A button actuation of less than a second results in a simple recall of the scene as mentioned above. After a button actuation of more than five seconds, the device generates a storage instruction. In so doing, a storage telegram is transmitted.

An operation lasting between one and five seconds will be discarded as invalid.

The "Scene number" parameters specify which of the maximum of 64 external scenes is to be activated after a button-press. For a rocker, your own scene numbers can be assigned to each button.

The device possesses a button actuation and status display which uses multiple LEDs.

Actuation signalling and the send display take place via a red LED. Status displays occur via a separate green LED for each rocker. This makes it possible to indicate successful operation and sending processes directly on the device. The bidirectional communication makes it possible to indicate temporarily states of the KNX actuators immediately after an operation by means of the green LEDs. For this purpose, the device has separate status communication objects. In the Scene extension operating function, it is also possible to configure telegram acknowledgement. In this case, successfully sent scene storage telegrams are signalled by the LED.

If the LED status display is used for the scene extension without a storage function, then brief operation of a button has an impact on the evaluation of the actuator feedback. With a short button actuation (scene recall), only a time window is triggered for status display (figure 21). With the scene extension with storage function, the time window for the status display is only activated when the storage telegram has been sent (figure 22). This means that, after the storage command has been sent, a reaction can be given to actuator feedback. The LED can then, for example, signal a successful storage command if such actuator feedback is available. With the LED function "Telegram acknowledgement", the status LED of the appropriate button lights up after the successful sending of a storage telegram for a period of 3 seconds (figure 23). Telegram acknowledgement does not take place if the storage telegram could not be sent. The illumination length of this display function is defined and thus cannot be changed.

- i** If the status display is used, ideally the 1-bit feedback object of the switching status of KNX switching or dimming actuators is linked to the status object of the transmitter.
- i** Telegram acknowledgement can only be designed for the scene extension with memory function.

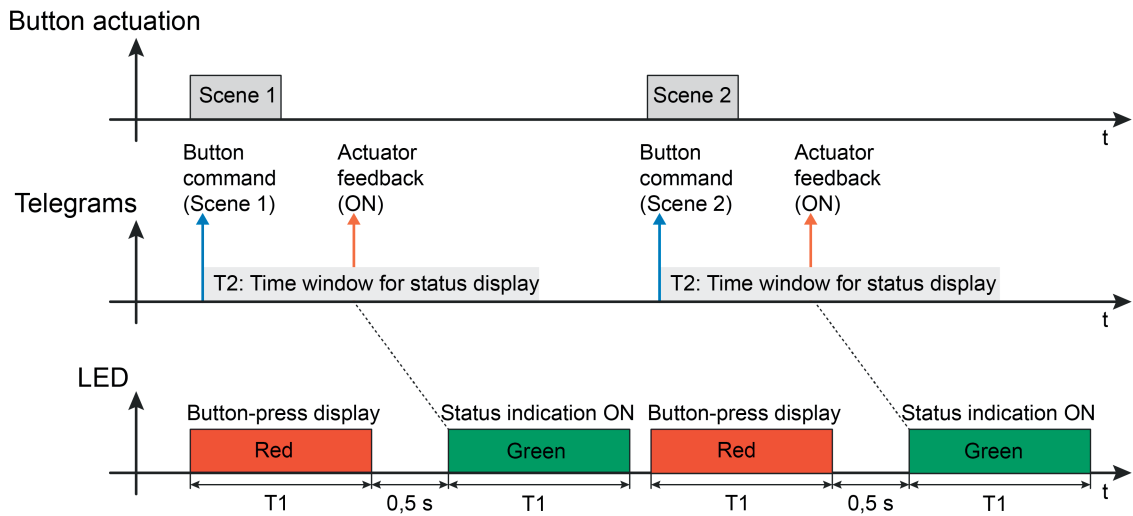

Figure 21: Example of a status display with the operating function "Scene extension"
Scene extension without storage function

- T1 Time according to the parameter "Lighting time of all LEDs" (global for all operating rockers)
- T2 Time according to the parameter "Time window for actuator feedback" (separate for each button)

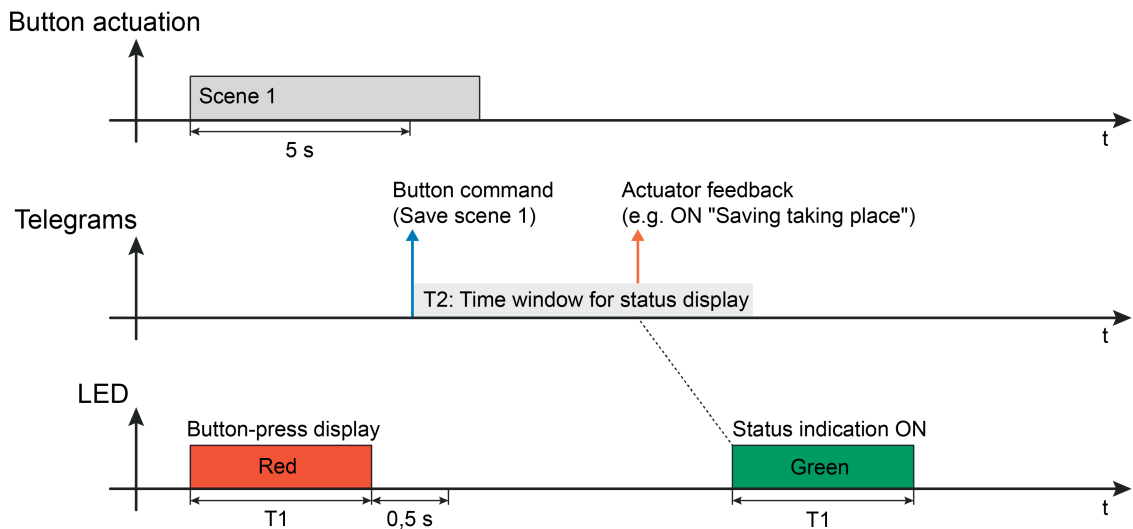

Figure 22: Example of a status display with the operating function "Scene extension"
Scene extension with memory function and status display

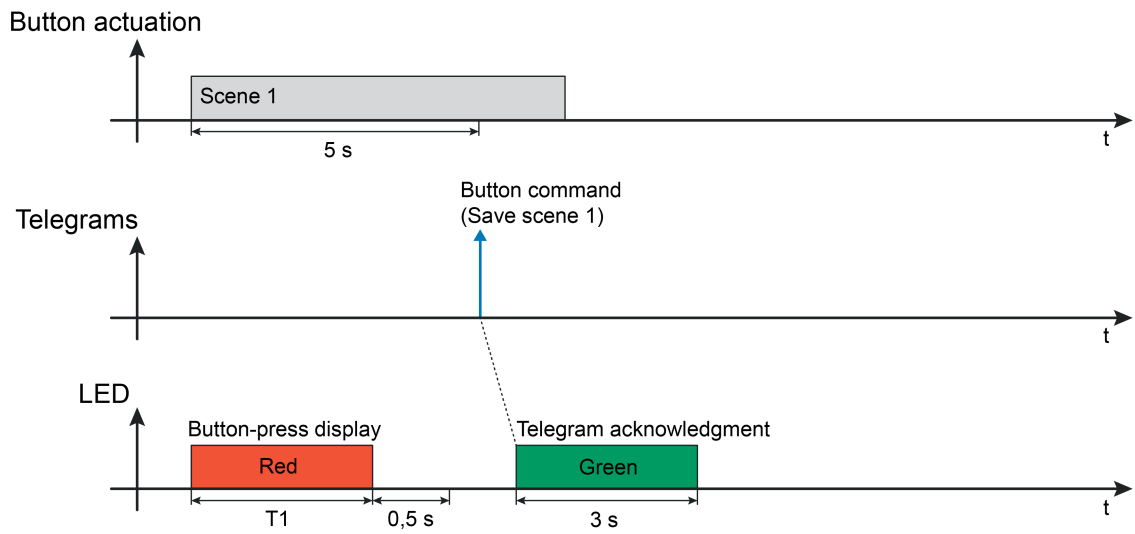

Figure 23: Example of an LED display with the operating function "Scene extension"
Scene extension with memory function and telegram acknowledgement

4.2.4.3 Room temperature measurement

Temperature detection

The KNX RF radio transmitter module possesses an integrated temperature sensor. Using this temperature sensor, the ambient temperature can be measured in a range between -5 °C and 40 °C and forwarded to the KNX via a 2-byte communication object. The determined temperature can then be processed, for example, by a room temperature controller as an external temperature or be displayed by a visualisation.

To be able to use the room temperature measurement, it must have been enabled on the parameter page "General" with the parameter "Room temperature measurement". After enabling the parameter page "Room temperature measurement" is visible. Further adjustments can be made for temperature measurement on this page.

The KNX RF radio transmitter module measures the room temperature cyclically, if the function is enabled. The parameter "Time for cyclical room temperature measurement" defines the measuring interval. The device interrupts the power saving mode for each temperature measurement automatically. Immediately after the measurement, the device returns to the power saving mode if no other operation or status display is performed.

The measured temperature value will be stored in a non-volatile memory of the device. The transmission criteria configured in the ETS defines whether and when the last measured temperature value is transmitted to the KNX (see page 42).

The temperature measurement runs completely autonomously. Actuations or time windows for status displays do not influence the measurement interval of the room temperature.

- i** Since the device interrupts the power saving mode when function is enabled, battery life is reduced by the room temperature measurement. It is recommended to configure the "Time for cyclical room temperature measurement" not shorter than 10 minutes. The battery life will be favorably influenced when the measuring interval is prolonged.
- i** After an ETS programming or after inserting the battery, the KNX RF radio transmitter module always immediately performs a temperature measurement and updates the temperature value. Depending on the configured transmission criteria, a telegram is transmitted then possibly.

Installation location

When choosing the mounting location of the KNX RF radio transmitter module, the following points should be considered when using room temperature measurement:

- The device should not be used in multiple combinations, especially together with flush-mounted dimmers.
 - Do not install the device in the area of large electrical consumers (avoid heat influences).
 - The push button sensor should not be installed in the vicinity of radiators or cooling systems.
 - Avoid direct sunlight.
 - The installation on the inside of an outside wall might have a negative impact on the temperature measurement.
 - The device should be installed at least 30 cm away from doors, windows or ventilation units and at least 1.5 m above the floor.
- i** The indications given as to the proposed installation location for RF devices have to be observed additionally .

Temperature calibration of the measurement values

Some cases in the course of temperature measurement may require to calibrate the measured values of the temperature sensor. For example, a calibration becomes necessary if the temperature measured by the sensor stays permanently below or above the actual room temperature. To determine the temperature deviation, the actual room temperature should be detected with a reference measurement using a suitable temperature measuring device.

Using the parameter "Internal sensor calibration" on the parameter page "Room temperature measurement", it is possible to configure the positive (temperature increase, factors: 1 ... 127) or negative (temperature decrease, factors -128... -1) temperature calibration in levels of 0.1 K. Thus, the calibration is made only statically and is the same for all measured values.

- i** The measured value has to be increased, if the value measured by the sensor lies below the actual room temperature. The measured value has to be decreased, if the value measured by the sensor lies above the actual room temperature.
- i** The KNX RF radio transmitter module always transmits the calibrated temperature value to the KNX..

Transmission of room temperature

The determined room temperature is transmitted to the KNX via the 2-byte object "Measured room temperature". The parameter "Transmission after room temperature change by..." on the "Room temperature measurement" parameter page specifies the change value of the temperature for automatic transmission. Compared with the last measurement, the room temperature must change by at least the configured value for a new temperature value to be transmitted automatically via the object. Temperature changes between 0.1 K and 25.5 K can be configured. If "0" is selected, the automatic transmission of the room temperature after a value change is deactivated.

- i** The KNX RF radio transmitter module evaluates temperature changes only at each temperature measurement according to the configured measurement interval. So there can be an automatic transmission in accordance with temperature change only when a new temperature measurement is taking place.

In addition, the determined room temperature can be transmitted cyclically. The "Cyclical transmission of the room temperature" parameter determines the cycle time (1 to 255 minutes). The value "0" will deactivate the periodical transmission of the room temperature value. The latest determined room temperature according to the configured measurement interval will be cyclically transmitted. Cyclical transmission itself causes no temperature measurement.

- i** The device interrupts the power saving mode for the cyclical transmission automatically. Consequently short cycle times reduce the battery life. Immediately after transmission of the temperature value, the device returns to the power saving mode if no other operation or status display and no temperature measurement is performed. It is recommended to configure the "Cyclical transmission of the room temperature" minimum on the same value as the time of the configured measurement interval and not shorter than 10 minutes. The battery life will be favorably influenced when the cycle time is prolonged. Cyclical transmission of room temperature runs completely autonomously. Actuations or time windows for status displays do not influence the transmission interval of the room temperature.

4.2.4.4 Delivery state

In the delivery state, the device does not function. No radio telegram is transmitted when a button is pressed. After a button actuation, the red send/actuation LED flashes slowly for 3 seconds. In addition, the LED flashes rapidly to indicate the programming state, provided that it is activated.

4.2.5 Parameters

Description	Values	Comment
<input type="checkbox"/> General		
Illumination length of all LEDs	1 sec 2 sec 3 sec 4 sec 5 sec	This defines the switch-on time of the LED for an actuation and status display.
Function of the red send and actuation LED	always OFF ON for configured illumination length	The red send and actuation display can be optionally switched off. In the "Always OFF" setting, this parameter means that there is no actuation display for any of the operating buttons. This deactivates the first display phase. However, the signalling of a transmission error or an empty battery remains active. The display pause also remains active after the first phase, meaning that an actuator status is displayed at least 0.5 seconds after a button actuation.
Room temperature measurement	disabled enabled	The device possesses an integrated temperature sensor. Using this temperature sensor, the ambient temperature can be measured in a range between -5 °C and 40 °C and forwarded to the KNX via a 2-byte communication object. The determined temperature can then be processed, for example, by a room temperature controller as an external temperature or be displayed by a visualisation. This parameter enables room temperature measurement as necessary.
<input type="checkbox"/> Room temperature measurement		
Internal sensor calibration	-128... 0 ...127 * 0.1 K	Some cases may require to calibrate the measured values of the temperature sensor. For example, a calibration becomes necessary if the temperature measured by the sensor stays permanently below or above the actual room temperature. To determine the temperature deviation, the actual room temperature should be detected with a reference measurement using a suitable temperature measuring device.

		Using this parameter, it is possible to configure the positive (temperature increase, factors: 1 ... 127) or negative (temperature decrease, factors -128... -1) temperature calibration.
Time for cyclical room temperature measurement	1... 10 ...255 * 1 minute	The device measures the room temperature cyclically, if the function is enabled. The parameter "Time for cyclical room temperature measurement" defines the measuring interval. The device interrupts the power saving mode for each temperature measurement automatically. Immediately after the measurement, the device returns to the power saving mode if no other operation or status display is performed. The measured temperature value will be stored in a non-volatile memory of the device. The transmission criteria configured in the ETS (see parameters "Cyclical transmission of room temperature" and "Transmission after room temperature change by") defines whether and when the last measured temperature value is transmitted to the KNX
Cyclical transmission of room temperature (0 = inactive)	0... 30 ...255 * 1 minute	In addition to transmission on changes, the determined room temperature can be transmitted cyclically. This parameter specifies the cycle time. The value "0" will deactivate the periodical transmission of the room temperature value. The latest determined room temperature according to the configured measurement interval (parameter "Time for cyclical room temperature measurement") will be cyclically transmitted. Cyclical transmission itself causes no temperature measurement.
Transmission when room temperature change by (0 = inactive)	0... 3 ...255 * +/-0.1 K	The change value of the temperature for automatic transmission is specified here. Compared with the last measurement, the room temperature must change by at least the configured value for a new temperature value to be transmitted automatically via the object "Measured room temperature". Temperature changes between 0.1 K and 25.5 K can be configured. If "0" is

selected, the automatic transmission of the room temperature after a value change is deactivated.

☐ Rocker x - Function

Function

- No function
- Switching**
- Dimming
- Venetian blind
- 1-byte value transmitter
- 2-byte value transmitter
- Scene extension

This parameter is used to define the operating function of the rocker.

These parameters are only visible for the function "Switching"...

Operation concept

Button function

With a button function, operating areas lying next to each other affect separate communication objects, independently of one another. As a result, two actuator channels can be activated.

Rocker function

If a button pair is used as a rocker, both buttons jointly affect the communication object assigned to the rocker. This can cause an actuator channel to be activated. Usually, pressing both sides of the rocker on the left or right can lead to directly opposite commands (e.g. switching: left ON - right OFF). Generally, the commands when the left and right rockers are pressed or released should be defined independently of each other.

Command on pressing left rocker

No function

These parameters specify the reaction when the left rocker is pressed or released.

ON

OFF

TOGGLE

Command on releasing left rocker

No function

ON

OFF

TOGGLE

Command on pressing right rocker	No function ON OFF TOGGLE	These parameters specify the reaction when the right rocker is pressed or released.
----------------------------------	---	---

Command on releasing right rocker	No function ON OFF TOGGLE
-----------------------------------	---

These parameters are only visible for the function "Dimming"...

Command on pressing left rocker	brighter (ON) darker (OFF)	This parameter defines the reaction when the left rocker is pressed.
---------------------------------	--------------------------------------	--

Command on pressing right rocker	brighter (ON) darker (OFF)	This parameter defines the reaction when the right rocker is pressed.
----------------------------------	--------------------------------------	---

Time between switching and dimming, left rocker (100...3000 x 1 ms)	100... 400 ...3000	This parameter defines for how long the left rocker must be pressed for the device to send a dimming telegram.
---	---------------------------	--

Time between switching and dimming, right rocker (100...3000 x 1 ms)	100... 400 ...3000	This parameter defines for how long the right rocker must be pressed for the device to send a dimming telegram.
--	---------------------------	---

These parameters are only visible for the function "Venetian blind"...

Command on pressing left rocker	DOWN UP TOGGLE	This parameter defines the running direction of a drive after a button actuation on the left side of the rocker. If the setting is "TOGGLE", the direction is changed after each long time command. If several transmitters are to control the same drive, the long-time objects of the devices must be interlinked for a correct
---------------------------------	-----------------------------	---

		change of the running direction.
Command on pressing right rocker	DOWN UP TOGGLE	This parameter defines the running direction of a drive after a button actuation on the right side of the rocker. If the setting is "TOGGLE", the direction is changed after each long time command. If several transmitters are to control the same drive, the long-time objects of the devices must be interlinked for a correct change of the running direction.
Time between short and long time command left rocker (1...30 x 100 ms)	1... 4 ...30	This parameter sets the time after which the long-time operation will be evaluated on pressing the left button of the rocker.
Time between short and long time command right rocker (1...30 x 100 ms)	1... 4 ...30	This parameter sets the time after which the long-time operation will be evaluated on pressing the right button of the rocker.
Slat adjusting time left rocker (0...30 x 100 ms)	0... 5 ... 30	Time during which a transmitted long time telegram can be terminated by releasing the left button of the rocker (short time). This function serves to adjust the slats of a blind.
Slat adjusting time right rocker (0...30 x 100 ms)	0... 5 ... 30	Time during which a transmitted long time telegram can be terminated by releasing the right button of the rocker (short time). This function serves to adjust the slats of a blind.
These parameters are only visible for the function "Value transmitter 1-byte"...		
Function	Value transmitter 0...255 Value transmitter 0...100 %	A rocker configured as "Value transmitter 1 byte" permits selecting whether the values to be transmitted are interpreted as integers from 0 to 255 or as a percentage from 0 % to 100 %. The following parameters and their settings depend on this distinction.
Value left rocker	0... 255	Defines the value when the left side of the rocker is pressed. Only for "Function = Value transmitter

		0...255"!
Value right rocker	0...255	Defines the value when the right side of the rocker is pressed. Only for "Function = Value transmitter 0...255"!
Value left rocker	0...100	Defines the value when the left side of the rocker is pressed. Only for "Function = Value transmitter 0...100%"!
Value right rocker	0...100	Defines the value when the right side of the rocker is pressed. Only for "Function = Value transmitter 0...100%"!

These parameters are only visible for the function "Value transmitter 2-byte"...

Function	Temperature value transmitter Brightness value transmitter Value transmitter (0...65535)	This parameter defines the data format of the 2-byte value transmitter..
Temperature value left rocker	0...20...40 °C	Defines the temperature value when the left side of the rocker is pressed. Visible only if "Function = Temperature value transmitter"!
Temperature value right rocker	0...20...40 °C	Defines the temperature value when the right side of the rocker is pressed. Visible only if "Function = Temperature value transmitter"!
Brightness value left rocker	0 lux, 50 lux, 100 lux, ..., 300 lux , ..., 1,4560 lux, 1,500 lux	Defines the brightness value when the left side of the rocker is pressed. Visible only if "Function = Brightness value transmitter"!
Brightness value right rocker	0 lux, 50 lux, 100 lux, ..., 300 lux , ..., 1,4560 lux, 1,500 lux	Defines the brightness value when the right side of the rocker is pressed. Visible only if "Function = Brightness value transmitter"!

Value left rocker	0... 65535	Defines the value when the left side of the rocker is pressed. Only for "Function = Value transmitter (0...65535)"!
Value right rocker	0...65535	Defines the value when the right side of the rocker is pressed. Only for "Function = Value transmitter (0...65535)"!

These parameters are only visible for the function "Scene extension"...

Function	Scene extension without storage function Scene extension with storage function	With a rocker configured as a "Scene extension", there is the option of choosing whether only scenes are loaded or whether a storage function is possible.
Scene number left rocker	1...64	Defines the scene number when the left side of the rocker is pressed.
Scene number right rocker	1... 2 ...64	Defines the scene number when the right side of the rocker is pressed.

These parameters are visible for all functions...

Time window for operation left rocker (0 = Continuous operation permitted) (0...250 s)	0... 30 ...250	If the left button of the rocker remains pressed for longer than the time defined by this parameter, then, to save the battery, the device evaluates the operation as invalid. The operation is ended correctly (e.g. by sending a Stop telegram during a dimming operation). The device then returns to energy-saving mode immediately. Only a new button actuation wakes up the device again.
Time window for operation right rocker (0 = Continuous operation permitted) (0...250 s)	0... 30 ...250	If the right button of the rocker remains pressed for longer than the time defined by this parameter, then, to save the battery, the device evaluates the operation as invalid. The operation is ended correctly (e.g. by sending a Stop telegram during a dimming operation). The device then returns to energy-saving mode immediately. Only a new button actuation wakes up the device again.

telegram during a dimming operation). The device then returns to energy-saving mode immediately. Only a new button-press wakes up the device again.

□| Rocker x - Status
Status display function

The device possesses a button actuation and status display which uses multiple LEDs. Actuation signalling and the send display take place via a red LED. Status displays occur via a separate green LED for each rocker. This makes it possible to indicate successful operation and sending processes directly on the device. The bidirectional communication makes it possible to indicate temporarily states of the KNX actuators immediately after an operation by means of the green LEDs. For this purpose, the device has separate status communication objects. The operating and display concept intends two phases of the LED display. In the first display phase, the user is given feedback on the button-press. Then, there is always a pause of 0.5 s, during which the LEDs are switched off. Then there is the second display phase, in which the status LED of a rocker displays a received actuator status or - with the Scene extension function with memory function - the triggering of a memory telegram is signalled.

always OFF

In the "Always OFF" setting, the status function of the appropriate rocker, and thus the second display phase, is deactivated.

Telegram acknowledgment

With this LED function, the LED of the actuated rocker lights up after the successful sending of a storage telegram for a period of 3 seconds. Telegram acknowledgement does not take place if the storage telegram could not be sent. This setting is only available with the operating function "Scene extension".

LED object (display of ON status only with green LED)

In this setting, the 1-bit status object is available. This means that, after an operation, switching status feedback of an actuator can be displayed in the second display phase of the LED. Only the ON status is evaluated as a single status and displayed by the LED lighting up.

	LED object inverted (display of OFF status only with green LED)	In this setting, the 1-bit status object is available. This means that, after an operation, switching status feedback of an actuator can be displayed in the second display phase of the LED. Only the OFF status is evaluated as a single status and displayed by the LED lighting up.
Time window for status display of the actuator feedback left rocker (1...120 s)	1... 3 ...120	Due to the energy-saving operation of the transmitter, the actuator feedback must be received in a defined time window after the button operation. This time is defined individually for the left side of the rocker by this parameter. Each telegram that the device sends successfully on a button-press retriggers the time window configured here for the status display. After the time has elapsed, the transmitter switches back to energy-saving mode. Feedback telegrams arriving at the device outside the defined time window for the status display are not evaluated by the LED.
Time window for status display of the actuator feedback right rocker (1...120 s)	1... 3 ...120	Due to the energy-saving operation of the transmitter, the actuator feedback must be received in a defined time window after the button operation. This time is defined individually for the right side of the rocker by this parameter. Each telegram that the device sends successfully on a button-press retriggers the time window configured here for the status display. After the time has elapsed, the transmitter switches back to energy-saving mode. Feedback telegrams arriving at the device outside the defined time window for the status display are not evaluated by the LED.
Terminate time window for status display after first actuator feedback ?	yes no	This parameter defines whether, within a time window for status display, only the first actuator feedback is evaluated and has an LED display or whether additional feedback telegrams will be displayed during the same time period. In the "No" setting, all the feedback is evaluated within the specified time window. Any received feedback telegram will trigger the status display according to the configured polarity (ON or OFF). In the "Yes" setting, only the first actuator status telegram received by the transmitter in the time window of the status display is displayed. At the same

time, the transmitter ends the time window. As a result, any further status telegrams are ignored.

5 Appendix

5.1 Application basics

5.1.1 Basic physical principles

Electromagnetic wave

Radio waves are waves of coupled electrical and magnetic fields (figure 24). Electromagnetic waves are emitted by antennas into the surrounding area as free progressive waves. They do not require a special medium for radiation. In a vacuum, radio waves radiate at the speed of light. The radiation is always slower in other media. Like light, electromagnetic waves are subject to deflection, refraction, reflection, polarisation and interference.

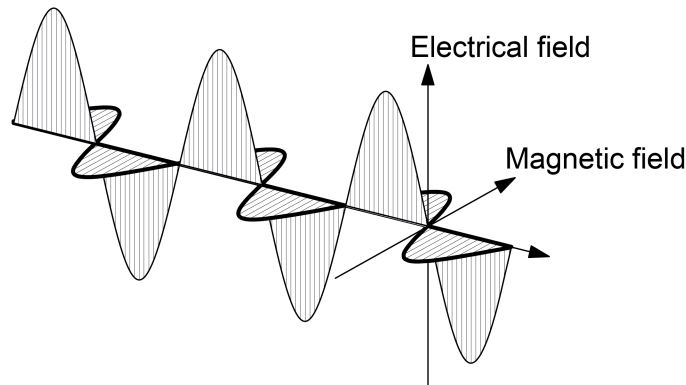

Figure 24: Model of an electromagnetic wave in an open space

Electromagnetic waves radiate out in a straight line in every direction. If multiple electromagnetic waves meet, then they will be superimposed. With KNX RF, the radio signals come from almost every direction (through the positioning of the transmitters and due to reflections). If KNX RF radio waves are superimposed, then noise is created (signal with an unspecific frequency spectrum) in the communication channel, which can no longer be understood by any KNX RF receiver. This can cause transmitted information to be lost. Therefore, when planning a KNX RF environment, various specifications must be taken into account. The chapter "Building structure and RF topology" in this documentation provides more detailed information on this.

Information transmission with radio signals

An electromagnetic wave of a constant amplitude and frequency does not yet carry any information. To make this possible, the transmitter must change the amplitude or the frequency of the wave continuously according to an agreed method and the carrier signal must modulate the information in this manner. With KNX RF, the modulation type "Frequency key shifting" (FSK = engl. Frequency Shift Keying) is used (figure 25). Frequency key shifting is a variant of frequency modulation (FM) and suitable for the transmission of digital information. Two time-coded signals of a different frequency are transmitted, in order to inform the receiver of the

logical states "0" and "1". Frequency key shifting is impervious to interference. Even major transmission losses in signal amplitude do not have a negative effect on the demodulation of the transmitted information.

For KNX RF, the data rate is 16.384 kBit/s. Manchester encoding is used to apply the "0" and "1" information to the radio signal. This allows very easy synchronisation of the transmitter and receiver.

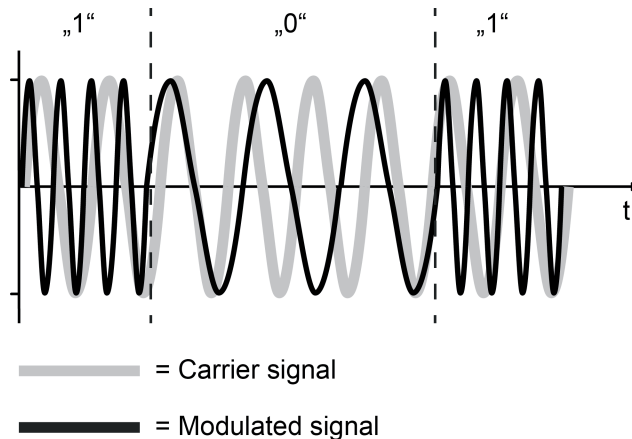

Figure 25: Frequency key shifting as a modulation method (FSK = Frequency Shift Keying)

Radiation and attenuation of radio signals in buildings

Radio waves with a frequency used for KNX RF can penetrate ceilings or walls in a building. Depending on the mass (thickness) and conductivity (metallic component, humidity), this is connected with a greater or lesser energy loss. This loss of transmission energy is also called attenuation (ratio of transmitted and received radio radiation power).

Radio signals are attenuated by various influences on their journey between the transmitter and receiver. The precondition for comprehension between the transmitter and receiver is, of course, that the radio signals of the transmitter still have sufficient energy on reaching the receiver for the receiver to be able to evaluate the signals.

Almost ideal radiation conditions for electromagnetic radio signals exist in the free-field. The term "Free-field" refers to a free area, in which radio waves can radiate out more or less unhindered and interference effects from structures or obstacles have no influence. If walls and ceilings must be penetrated on the transmission path, then the attenuation - and thus the radio range - is primarily dependent upon the number, type and consistency of the construction materials to be penetrated and on the effective wall and ceiling thicknesses. Part of the incidental radio radiation is reflected on the limit areas and a further part is absorbed. Moist materials, as is found in new buildings or recently renovated rooms (newly-papered or plastered) attenuate electromagnetic radio waves to a greater extent.

Material (dry)	Material thickness	Transmission
Wood, plaster, plasterboard *, glass **	< 30 cm	90...100 %
Brick, chipboard plates	< 30 cm	65...95 %
Reinforced concrete	< 30 cm	10...70 %
Metal grid	< 1 mm	0...10 %
Metal, aluminium cladding	< 1 mm	0 %

- *: no metallic stand
- ** : without metallisation or wire inlay, no leaded glass

Take the attenuation factors of a building into account when selecting the mounting locations of KNX RF devices (hand-held transmitters, radio wall transmitters, media couplers). Take into account too that each KNX RF device is both a transmitter and a receiver on account of the bidirectionality (e.g. hand-held transmitters with or without LED status display and media couplers are transmitters and receivers in the same way).







-  Position of transmitters (e.g. hand-held transmitter, pushbutton sensor)
-  In reception field
-  Not located favourably in reception field
-  Not in reception field
-  Attenuated signal path

Figure 26: Attenuation of the radio signal in buildings through walls and ceilings
 Example 1: "Edge position of the transmitter" (simplified depiction)

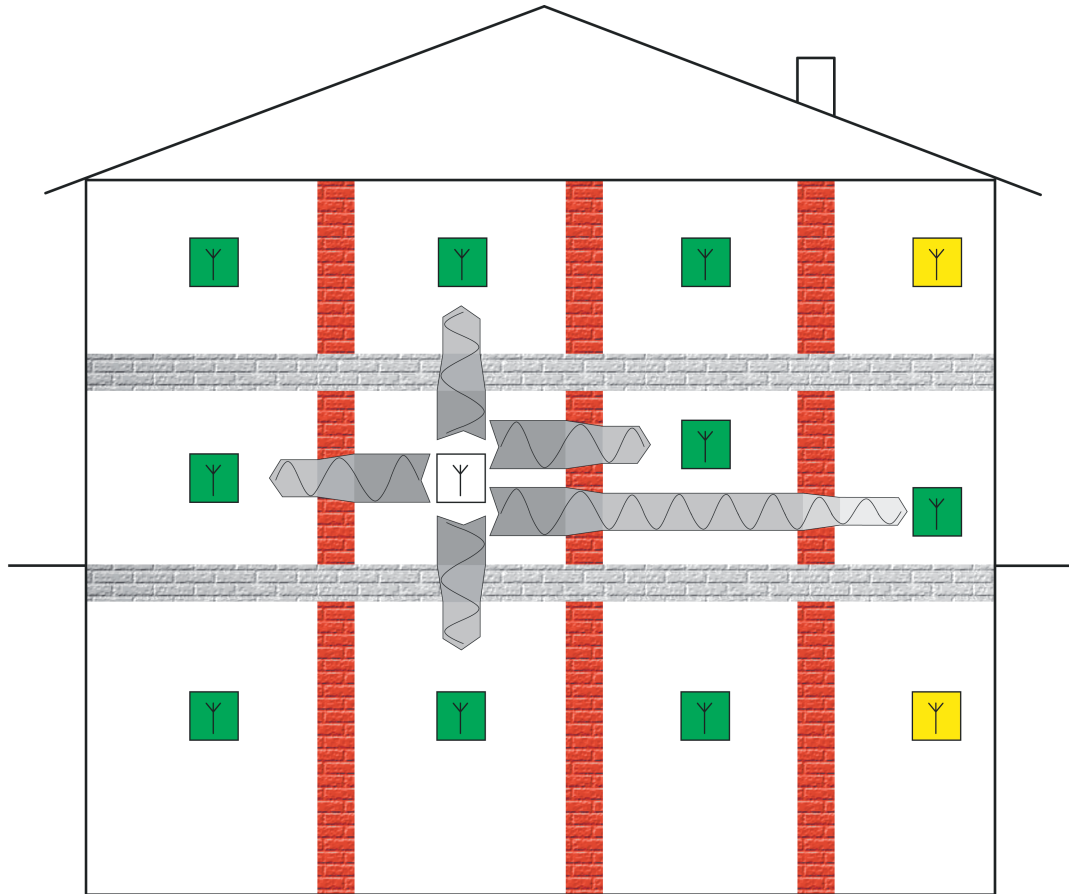

Figure 27: Attenuation of the radio signal in buildings through walls and ceilings
Example 2: "Central position of the transmitter" (simplified depiction)

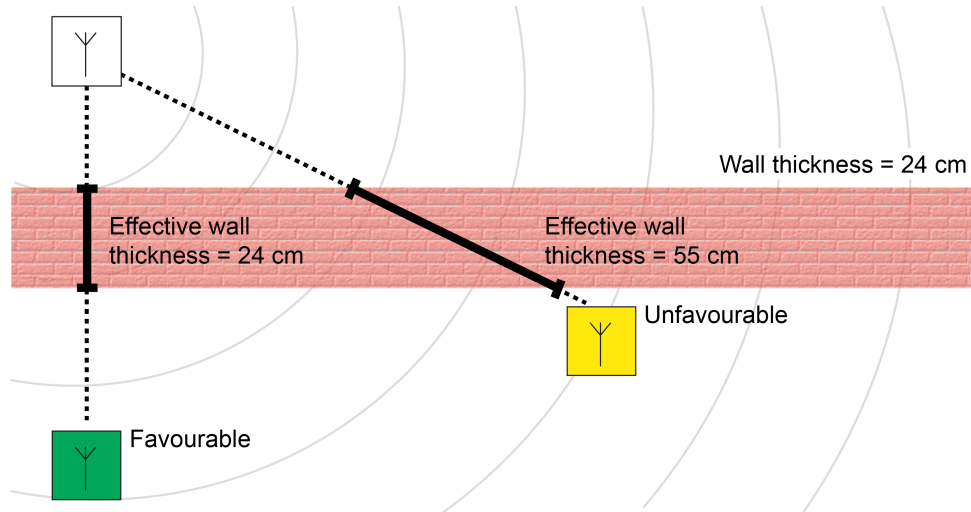

Figure 28: Attenuation through effective wall or ceiling thickness

- i** Care is required when a building is equipped with shielding materials to reduce electromagnetic waves. Flush-mounted appliance boxes with a conductive coating are not usually suitable for radio products. Special shielding plasters and plasterboard protection plates, into which conductive fibres are worked, reduce the permeability of radio waves by up to 95%. The same applies to stands, into which high level of metallic components (e.g. supporting parts, metallised insulation material) are integrated.
- i** Due to the wide range of influences, it is difficult to evaluate radio sections in buildings. Eventually a manufacturer of radio products - also of other systems such as Wi-Fi - cannot make any binding statement on the range of radio transmission in buildings. For this reason, the free-field range is always stated, which refers to an uninterrupted radiation of the radio waves and optimally aligned antennas. Provided that there are no special measures for shielding in buildings, this means that targeted radio transmission should be possible.

Additional attenuation in a building or in a more or less free field (outdoors) is created when the antenna of the transmitter or receiver is mounted at a low ground height. KNX RF radio sensors and actuators should therefore be mounted as far from the ground as possible. The mounting of a transmitter or receiver in the ground (e.g. in a suitable installation box) should be avoided, particularly outdoors. The radio range would be restricted to such an extent that radio transmission would scarcely be possible.

- i** We recommend installing KNX radio wall transmitters at a standard mounting height of 1.05...1.50 m.

Electrically conductive materials cannot be penetrated by electromagnetic waves. Metallic components of buildings, e.g. furniture or steel reinforcement rods in concrete (figure 29), but also metallic design frames or design parts with metallic coatings thus have a shielding effect. Metallic shieldings can also be used consciously to keep an area free of radio waves.

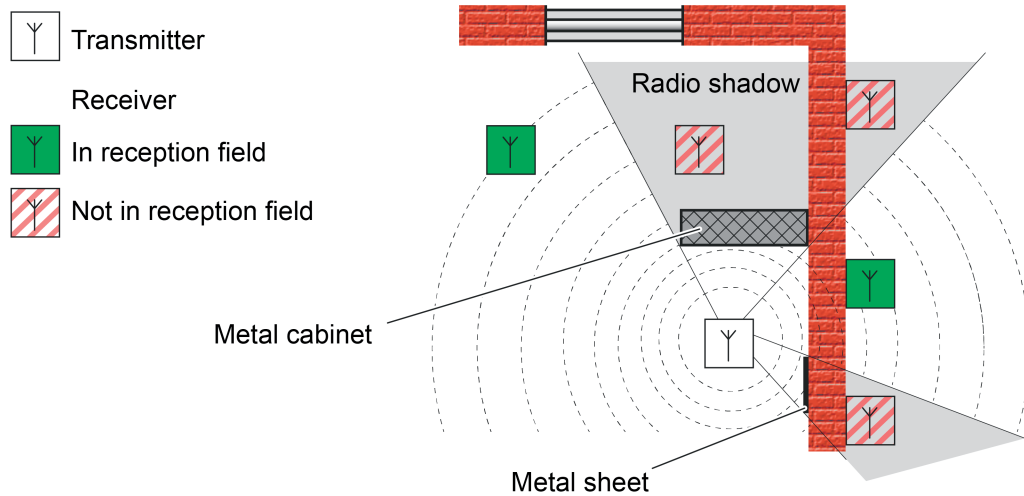

Figure 29: Radio shadow in a building due to metallic parts (idealised)

Radio waves reach the receiver both directly (through the air) and also via diversions (multiple route radiation). Such diversions are created by reflections of the radio waves at boundary layers to other materials, e.g. on the surfaces of walls or ceilings. Radio waves of an identical source are at the receiver with a differing phase location. In many cases, the reflected radio power is too small to influence the direct path of the radio wave in any significant way. A receiver can then receive the signal of the transmitter without any interference (figure 30).

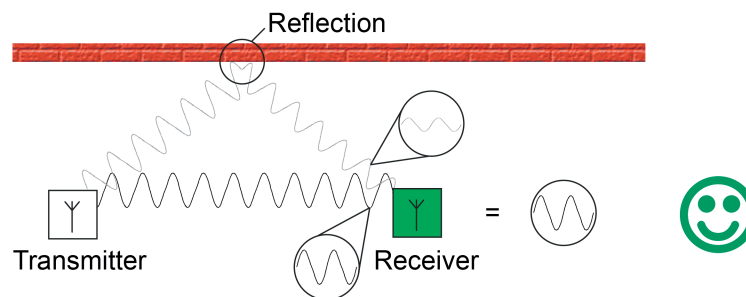

Figure 30: Interference has no effect on the receiver

However, in the worst case, the waves received directly and via reflection are superimposed unfavourably at the target location, creating a signal which receivers can no longer evaluate reliably (figure 31). Positive and negative superposition of radio waves pointing the same way is also termed interference.

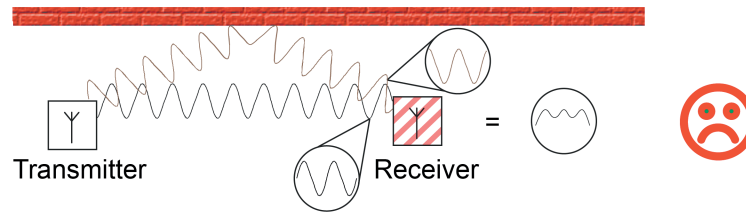

Figure 31: Interference at the receiver prevents reception

Effects from reflections can also be used positively in a building. If possible, RF devices, or their transmission and reception antennas, can be installed horizontally or vertically in the same alignment, as the radio wave also swings in the appropriate direction (polarisation). If antennas are aligned in different ways, then the signal available at the receiver is weakened and thus the maximum radio range is reduced. The weakening of the signal can be of such magnitude that a receiver can no longer receive any output radiated directly from the transmitter. However, in practical terms, reflections may cause a rotation of the polarisation direction, meaning that the reflected signal reaches the receiver in a weakened form and can also be understood there (figure 32).

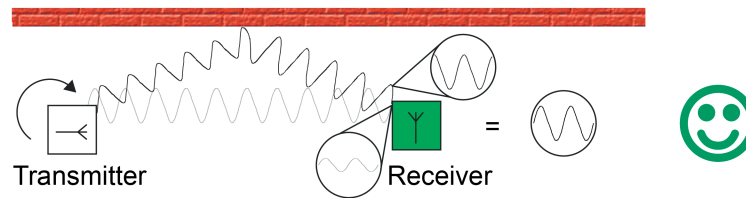

Figure 32: Reflection allows reception through a change of polarisation

In practice, reflection and interference effects can frequently be changed or used beneficially through a slight change in the installation location or the installation environment.

- i** With KNX radio wall transmitters, only vertical mounting of the device on walls or objects ensures the alignment of the internal antenna. If all the radio wall transmitters are mounted in the same way, then, in consequence, all their antennas are aligned to one another.

Influence of KNX RF on the human body

For many decades, radio waves have been used intensively for radio and global communication. In particular, the new communication media for wireless telephony (UMTS, LTE, DECT) and network communication (Wi-Fi, Bluetooth) are now being used widely in homes and in industry. However, other electrical devices radiate electromagnetic waves, e.g. microwave ovens.

The use of radio waves is regulated by the state. The assignment of frequency ranges and the specification of limit values ensure that there are no health impacts for people and different radio services do not influence one another. In particular, with regard to the number of electrical applications, wireless computer networks, mobile radio telephones and radio services, it must be established that the radio load of multiple KNX RF installations in parallel remains negligible.

Selecting installation location

If possible, the mounting locations of KNX RF devices must be evaluated during the planning of the electrical installation. Concrete ceilings with metal reinforcements attenuate radio radiation to a greater extent than wooden ceilings. The same applies for mineral plasters or hollow walls on the basis of a metallic stand. Room use should also - if known - be taken into account, because a living room in an existing building offers fewer obstacles to radio radiation than an office with metallic cabinets.

A KNX RF media coupler should ideally be positioned in the centre of an RF installation (domain) to allow low-loss and thus interference-free communication with all the corresponding RF devices. The housing of the media coupler is compact, meaning that it can be installed simply in standard flush-mounted appliance boxes (ideally in cavity walls) or surface-mounted appliance boxes (e.g. in suspended ceiling constructions).

General rules on the mounting of KNX RF devices (transmitters, receivers and media couplers).

- Avoid shadows, reflections, extinguishing of radio signals as far as possible. For this, note the structural conditions (supporting metallic parts, metal reinforcements, metallic wall and ceiling panelling, metal-coated panes of glass / heat protection glazing).
 - Do not mount the transmitter and receiver near the earth or ground.
 - Align unmoveable devices to each other as identically as possible, so that the internal transmission and reception antennas are polarised identically.
 - Position the antenna of the media couplers so that they are as straight (stretched out, unkinked) or as circular as possible in the box.
 - Ensure a distance to larger metallic surfaces, e.g. doors, frames, aluminium shutters, ceiling panelling, distribution cabinets, insulating films, ventilation grilles, is maintained.
 - Ensure the penetrations of walls and ceilings are as short as possible.
 - Do not place KNX RF devices in small metallic distributors or appliance boxes.
 - Maintain a distance to electromagnetic interference, e.g. electronic ballasts, motors, Tronic transformers, microwaves.
 - Maintain a distance to other radio sources, e.g. wireless telephones, radio headphones, WiFi routers.
- i** During mounting, particularly of media couplers, ensure that the devices are accessible after this.

6 Index

B			
Battery display.....	26		
C			
communication objects.....	18		
D			
delivery state.....	43		
Device components.....	7		
Dimming.....	30		
domain address.....	10		
E			
Electromagnetic wave.....	54		
ETS search paths.....	14		
G			
Glue mounting.....	9		
I			
Information transmission.....	54		
Installation location.....	41		
interference.....	59		
L			
Load the physical address.....	10		
M			
modulation type.....	54-55		
multiple route radiation.....	59		
R			
reflection.....	59		
S			
Scene extension.....	38		
Screw mounting.....	8		
Switching.....	27		
T			
Temperature calibration.....	42		
Temperature detection.....	41		
transmission error.....	25		
V			
Value transmitter 1 byte.....	34		
Value transmitter 2 byte.....	36		
		Venetian blind.....	32

ALBRECHT JUNG GMBH & CO. KG

Volmestraße 1
58579 Schalksmühle
GERMANY

Telefon: +49 2355 806-0
Telefax: +49 2355 806-204
kundencenter@jung.de
www.jung.de