

## Operating instructions

### 1 Safety instructions



Electrical devices may only be mounted and connected by electrically skilled persons.

Serious injuries, fire or property damage possible. Please read and follow manual fully.

The device may not be opened or operated outside the technical specifications.

Danger of electric shock. Device is not suitable for disconnection from supply voltage. The load is not electrically isolated from the mains even when the output is switched off.

Danger of electric shock. Make sure during the installation that there is always sufficient insulation between the mains voltage and the bus. A minimum distance of at least 4 mm must be maintained between bus conductors and mains voltage cores.

Danger of electric shock on the KNX installation. Do not connect any external voltage to the inputs. The device might be damaged, and the SELV potential on the KNX bus line will no longer be available.

Fire hazard. For operation with inductive transformers, each transformer must be fused on the primary side in accordance with the manufacturer's instructions. Only safety transformers according to EN 61558-2-6 may be used.

Risk of destruction of the dimmer and load if the set operating mode and load type do not match. Set the correct dimming principle before connecting or exchanging the load.

These instructions are an integral part of the product, and must remain with the end customer.

### 2 Device components

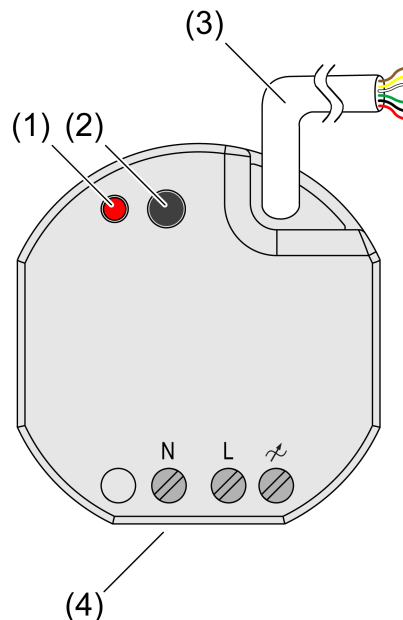

Figure 1: Device components

- (1) Programming LED
- (2) Programming button
- (3) Control cable (KNX connection and extension inputs)
- (4) Load connection (dimming output)

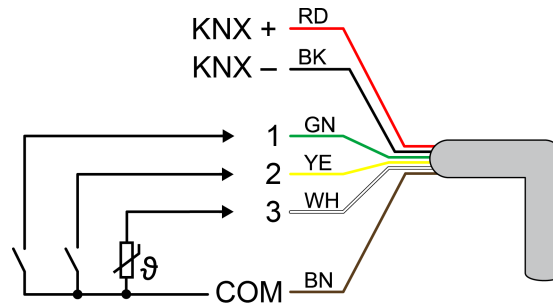

Figure 2: Connection assignment of control cable (example)

red (RD)	KNX +
black (BK)	KNX -
green (GN)	Input 1 (push-button, switch, contact, dew/leakage sensor)
yellow (YE)	Input 2 (push-button, switch, contact, dew/leakage sensor)
white (WH)	Input 3 (push-button, switch, contact, dew/leakage sensor, NTC temperature sensor)
brown (BN)	COM inputs 1...3

### 3 Function

#### System information

This device is a product of the KNX system and complies with the KNX directives. Detailed technical knowledge obtained in KNX training courses is a prerequisite to proper understanding.

The function of this device depends upon the software. Detailed information on loadable software and attainable functionality as well as the software itself can be obtained from the manufacturer's product database.

The device can be updated. Firmware can be easily updated with the Jung ETS Service App (additional software).

The device is KNX Data Secure capable. KNX Data Secure offers protection against manipulation in building automation and can be configured in the ETS project. Detailed specialist knowledge is required. A device certificate, which is attached to the device, is required for safe commissioning. During mounting, the certificate must be removed from the device and stored securely.

Planning, installation and commissioning of the device are carried out with the aid of the ETS, version 5.7.3 and above.

#### Intended use

- Operating in KNX systems
- Switching and dimming of lighting
- Reading in switching states of installation switches or push-buttons and other potential-free contacts at inputs 1...3
- Signal evaluation of dew and leakage sensors at inputs 1...3 (see accessory).
- Acquisition of temperature values via NTC temperature sensor at input 3 (see accessories)
- Mounting in appliance boxes according to DIN 49073

#### Product characteristics

- Outputs can be operated via KNX telegrams or extension inputs
- Three extension inputs for connecting potential-free contacts or dew/leakage sensors. NTC temperature sensor can be connected to input 3.
- Supply via KNX, no additional power supply necessary
- KNX Data Secure compatible

- Updateable with Jung ETS Service App

#### Dimming operation characteristics

- Automatic or manual selection of the dimming principle suitable for the load
- Protected against no-load, short-circuit and overheating
- Signal in the event of a short-circuit
- Feedback of the switching position and the dimming value
- Parameterisable switch-on and dimming behaviour
- Time functions: switch-on delay, switch-off delay, staircase lighting timer with run-on time
- Light scene operation
- Operating hours counter
- Mains failure longer than approx. 5 seconds leads to switch-off of the dimming actuator. Depending on the parameter setting, the connected load is calibrated after resumption of power supply.
- Power extension possible by means of power boosters.

**i** Delivery state: Operation of the output via extension inputs 1 and 2 possible with existing supply via KNX.

**i** Flickering of the connected lamps due to undershoot of the specified minimum load or through centralised pulses from the power stations. This does not represent any defect in the device.

#### Characteristics extension inputs

- Switching operating function
- Dimming operating function (incl. colour temperature dimming)
- Shutter/Venetian blinds operating function
- Value transmitter operating function (1-byte, 2-byte, 3-byte and 6-byte incl. RGBW and colour temperature presets)
- Scene extension operating function
- 2-channel operation operating function
- Controller extension operating function
- Disabling functions
- Debounce time adjustable

#### Logic function characteristics

- logic gates
- Transformer (conversion)
- Disabling element
- comparator
- Limit value switch

## 4 Information for electrically skilled persons



### **DANGER!**

**Mortal danger of electric shock.**

**Disconnect the device. Cover up live parts.**

## 4.1 Fitting and electrical connection



### DANGER!

When connecting the bus/extensions and mains voltage wires in a shared appliance box, the KNX bus line may come into contact with the mains voltage.

This endangers the safety of the entire KNX installation. People at remote devices may also receive an electric shock.

Do not place bus/extensions and mains voltage terminals in a shared connection compartment. Use an appliance box with a fixed partition wall or separate appliance boxes.

### Connecting and fitting the device

In secure operation (preconditions):

- Secure commissioning is activated in the ETS.
- Device certificate entered/scanned or added to the ETS project. A high resolution camera should be used to scan the QR code.
- Document all passwords and keep them safe.

Mounting in suitable appliance box (recommendation: electronic device box with partition). Observe cable routing and spacing (Figure 3)!

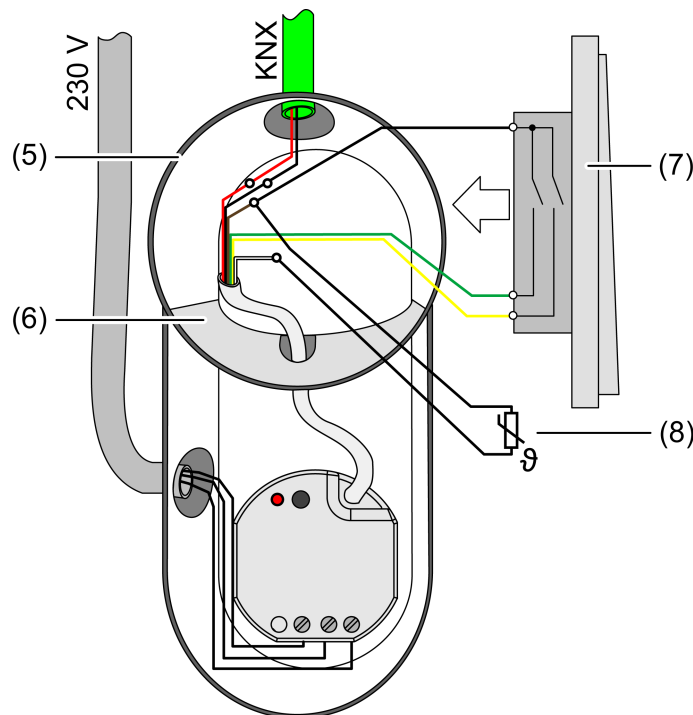

Figure 3: Mounting example in electronic device box with partition wall, series push-button and NTC temperature sensor

- (5) Appliance box
- (6) Partition
- (7) potential-free contacts (e.g. series push-button)
- (8) NTC temperature sensor (optional)

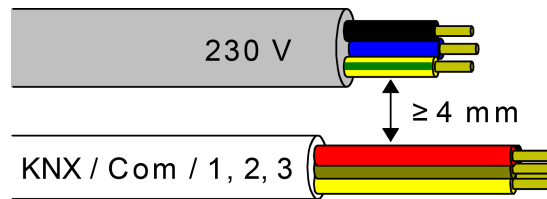

Figure 4: Cable spacing

Minimum spacing between the mains voltage and bus/extension wires: 4 mm (Figure 4)

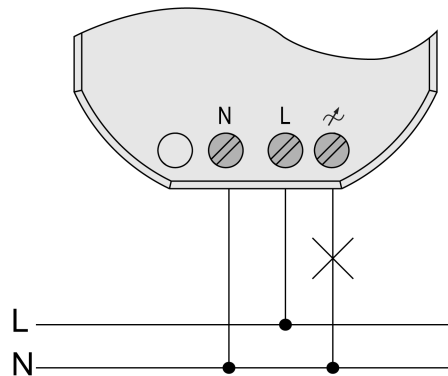

Figure 5: Connection of load

Observe ambient temperature. Ensure adequate cooling.

- Connect the device to KNX with the correct polarity.
- Connect load as shown in the connection example (Figure 5).
- If required, connect potential-free contacts or dew/leakage sensors to inputs 1...3, or NTC temperature sensors to input 3 (Figure 2).
- Install the device in the appliance box.
- In secure operation: The device certificate must be removed from the device and stored securely.

**i** The COM reference potential must not be connected together with COM connections of other devices!

## 4.2 Commissioning

### Commissioning the device

In the as-delivered state, the actuator is passive, i.e. no telegrams are transmitted to the KNX. The output is set to the universal dimming principle with automatic recognition of the load type. Control of the output is possible via inputs 1 and 2, provided the bus voltage is switched on. Input 3 has no function.

#### Function of Inputs in the as-delivered state

Input	Push-button (NO contact)	Function
1	Press briefly (< 0.4 s)	switch on
1	Press for a long time (> 0.4 s)	Increase brightness
2	Press briefly (< 0.4 s)	switch off
2	Press for a long time (> 0.4 s)	Reduce brightness
3	---	---

## Universal dimming actuator, 1-gang

The device can be programmed and put into operation via the ETS. The physical address is preset to 15.15.255

Moreover the device has been configured at the factory with the following characteristics...

- Behaviour in case of bus voltage failure: no reaction
- Behaviour in case of bus voltage return: brightness before bus voltage failure

### Load physical address and application program

- Parameterize correct dimming principle for the connected load.
- Press the programming button.  
The programming LED lights up.
- Load physical address and application program using the ETS.

### Safe-state mode

The safe state mode stops the execution of the loaded application program.

- i** Only the system software of the device is still functional. ETS diagnosis functions and programming of the device are possible.

### Activating the safe-state mode

- Switch off the bus voltage or disconnect the device from the KNX.
- Wait about 10 s.
- Press and hold down the programming button.
- Switch on the bus voltage or connect the device to KNX. Release the programming button only after the programming LED starts flashing slowly.  
The safe-state mode is activated.

With a new brief press of the programming button, the programming mode can be switched on and off as usual also in the safe-state mode. If Programming mode is active, the programming LED stops flashing.

### Deactivating safe-state mode

- Switch off bus voltage (wait approx. 10 s) or carry out ETS programming.

### Master reset

The master reset restores the basic device setting (physical address 15.15.255, firmware remains in place). The device must then be recommissioned with the ETS.

During secure operation: A master reset deactivates device security. The device can then be recommissioned with the device certificate.

### Performing a master reset

Precondition: The safe-state mode is activated.

- Press and hold down the programming button for > 5 s.  
The programming LED flashes quickly.

The device performs a master reset, restarts and is ready for operation again after approx. 5 s.

### Restoring the device to factory settings

Devices can be reset to factory settings with the Jung ETS Service App. This function uses the firmware contained in the device that was active at the time of delivery (delivery state). Restoring the factory settings causes the devices to lose their physical address and configuration.

## 5 Technical data

### Ambient conditions

Rated voltage

AC 230 V~

Universal dimming actuator, 1-gang

Mains frequency	50 / 60 Hz
Power loss	max. 1.5 W
Standby power	approx. 0.2 W
Ambient temperature	-5 ... +45 °C
Storage/transport temperature	-25 ... +70 °C
Dimensions (W × H × D)	48 x 50 x 28 mm

**KNX**

KNX medium	TP256
Commissioning mode	S-mode
Rated voltage KNX	DC 21 ... 32 V SELV
Current consumption KNX	5 ... 18 mA
Connection mode KNX	Connection terminal on control cable

**Output**

Connection mode	Screw terminals
Rated voltage	AC 230 / 240 V ~

Connected load depends on the connected lamps and set load type: (Figure 6) and (Figure 7)

ETS parameter load type

**UNI**

universal (with automatic calibration procedure)



conv. transformer (inductive / leading edge phase control)



LED (leading edge phase control)



electr. transformer (capacitive / trailing edge phase control)



LED (trailing edge phase control)











	 LED	 LED	 LED
<b>25 °C</b>			
	W	W	VA
UNI	1 ... 32	20 ... 100	20 ... 100
	1 ... 32	—	20 ... 100
LED 	1 ... 32	20 ... 100	—
	1 ... 200	20 ... 200	—
LED 	1 ... 200	20 ... 200	—
<b>45 °C</b>			
	W	W	VA
UNI	1 ... 25	20 ... 100	20 ... 100
	1 ... 25	—	20 ... 100
LED 	1 ... 25	20 ... 100	—
	1 ... 200	20 ... 200	—
LED 	1 ... 200	20 ... 200	—

Figure 6: Connected load LED lamps

25 °C			
	W	W	VA
UNI	20 ... 230	20 ... 210	20 ... 210
	20 ... 210	—	20 ... 210
LED	20 ... 210	20 ... 210	—
	20 ... 230	20 ... 230	—
LED	20 ... 230	20 ... 230	—
45 °C			
	W	W	VA
UNI	20 ... 210	20 ... 160	20 ... 160
	20 ... 160	—	20 ... 160
LED	20 ... 160	20 ... 160	—
	20 ... 210	20 ... 210	—
LED	20 ... 210	20 ... 210	—

Figure 7: Connected load conventional lamps

### Power reduction

when installed in wooden or dry construction walls	-15%
when installed in multiple combinations	-20%

### Clampable conductor cross-section

single stranded	0.5 ... 4 mm <sup>2</sup>
Finely stranded without conductor sleeve	0.5 ... 4 mm <sup>2</sup>
Finely stranded with conductor sleeve	0.5 ... 2.5 mm <sup>2</sup>
Connection torque screw terminals	Max. 0.8 Nm
inputs	
Control cable (preterminated)	YY6x0.6
Input type	Potential-free
Number	3
Total length of extension unit cable	max. 10 m
Cable type (preferably)	J-Y(St)Y
Poll voltage, extension inputs	approx. 5 V

## 6 Troubleshooting

### Connected LED lamps or compact fluorescent lamps switch off in the lowest dimming position or flicker

The set minimum brightness is too low.  
Increase minimum brightness.

### Connected LED lamps or compact fluorescent lamps flicker

Cause 1: Lamps are not dimmable.

Check manufacturer's instructions.  
Exchange lamps for another type.

Cause 2: Dimming principle and lamps do not optimally match.

For HV-LED: Check operation in another dimming principle, reduce connected load as well if necessary.

For LV-LED: Check the lamp operating device and replace as necessary.



With the "Universal" setting: Define the dimming principle manually.

### **Connected HV-LED lamps or compact fluorescent lamps in the lowest dimming position are too bright; dimming range is too small**

Cause 1: The set minimum brightness is too high.

Reduce minimum brightness.

Cause 2: HV-LED trailing edge phase control dimming principle does not optimally match the connected lamps.

Check operation in the "HV-LED leading edge phase control" setting, reduce connected load as well if necessary.

Exchange lamps for another type.

### **Output has switched off.**

Cause 1: overheating protection has tripped.

Disconnect output from mains, switch off associated circuit breakers.

HV-LED trailing edge phase control: Reduce the connected load. Exchange lamps for another type.

HV-LED leading edge phase control: Reduce the connected load. Check the operation in the "HV-LED trailing edge phase control" setting. Exchange lamps for another type.

Let device cool down for at least 15 minutes. Check installation situation, ensure cooling, e.g. provide distance from surrounding devices.

Cause 2: Surge protection has triggered.

HV-LED trailing edge phase control: Check the operation in the "HV-LED leading edge phase control" setting, reduce the connected load as well if necessary.

Exchange lamps for another type.

**i** The response of the surge protection can be signalled by sending a short-circuit telegram or can be determined by polling the "short-circuit" communication object.

Cause 3: short-circuit in output circuit

Disconnect the output from the mains supply.

Eliminate short-circuit.

Switch on mains voltage again. Switch the affected output off and on again.

**i** When a short-circuit occurs the affected output switches off. Automatic restart when short-circuit is eliminated within 100 ms (inductive load) or 7 seconds (capacitive or ohmic load). After that lasting switch-off.

**i** When a short-circuit occurs during the calibration process, the load calibrates itself again after the short-circuit is eliminated.

Cause 4: load failure.

Check load, replace light bulb. For inductive transformers, check primary fuse and replace if necessary.

### **Output cannot be operated.**

Cause 1: Output is disabled.

Cancel disabling.

Cause 2: Application software missing or faulty.

Check programming and correct.

### **Output off and not possible to switch on**

Cause 1: bus voltage failure.

Check bus voltage.

### **Luminaires flicker or buzz, proper dimming not possible, device buzzes**

Cause: wrong dimming principle set

Installation or commissioning error. Disconnect device and luminaire, switch off circuit breaker.

Check installation and correct.

If the wrong dimming principle has been preselected: Set correct dimming principle.

If dimming actuator calibrates itself incorrectly, e.g. with highly inductive mains or long load cables: preselect correct dimming principle with commissioning.

### **LED lamp is dimly lit when dimmer is switched off**

Cause: LED lamp is not optimally suited for this dimmer.

Use a compensation module, see accessories.

Use another type of LED lamp or an LED lamp of another manufacturer.

## **7 Accessories**

External sensor	FF7.8
Condensation sensor	BTS01
Leakage sensor	LES01

## **8 Warranty**

The warranty is provided in accordance with statutory requirements via the specialist trade.

### **ALBRECHT JUNG GMBH & CO. KG**

Volmestraße 1

58579 Schalksmühle

GERMANY

Telefon: +49 2355 806-0

Telefax: +49 2355 806-204

kundencenter@jung.de

www.jung.de