

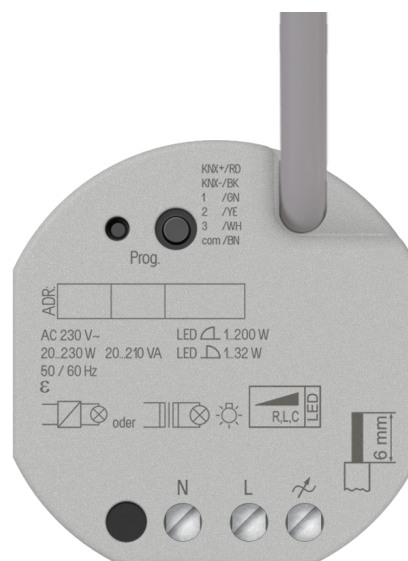

## Product documentation

Universal dimming actuator, 1-gang  
Art. no. 390011SU



**ALBRECHT JUNG GMBH & CO. KG**  
Volmestraße 1  
58579 Schalksmühle  
GERMANY

Telefon: +49 2355 806-0  
Telefax: +49 2355 806-204  
kundencenter@jung.de  
www.jung.de

## Table of Contents

<b>1</b>	<b>Information on the product</b> .....	<b>6</b>
1.1	Product catalogue .....	6
1.2	Function .....	6
1.3	Device components .....	7
1.4	Technical data.....	8
1.5	Accessories.....	10
<b>2</b>	<b>Safety instructions</b> .....	<b>11</b>
<b>3</b>	<b>Fitting and electrical connection</b> .....	<b>12</b>
<b>4</b>	<b>Troubleshooting</b> .....	<b>15</b>
<b>5</b>	<b>Commissioning</b> .....	<b>18</b>
<b>6</b>	<b>Application programs</b> .....	<b>20</b>
<b>7</b>	<b>Scope of functions</b> .....	<b>21</b>
<b>8</b>	<b>Notes on software</b> .....	<b>23</b>
<b>9</b>	<b>Dimming output</b> .....	<b>24</b>
9.1	Name of the dimming output.....	24
9.1.1	Name of the dimming output parameter .....	25
9.2	Defining load type .....	26
9.2.1	Load type parameter .....	29
9.3	Operation with universal power booster.....	30
9.3.1	Parameter operation with universal power booster (OLD) .....	31
9.4	Dimming characteristic.....	32
9.4.1	Parameter Dimming characteristic .....	38
9.5	Brightness range.....	40
9.5.1	Brightness range parameter .....	43
9.6	Switching / dimming behaviour .....	44
9.6.1	Switching/dimming behaviour parameters.....	46
9.6.2	Switching/dimming behaviour objects .....	48
9.7	Central functions .....	49
9.7.1	General central functions parameter .....	51
9.7.2	Central functions objects .....	53
9.8	Times .....	54
9.8.1	General times parameter .....	54
9.9	Reset and initialisation behaviour .....	55
9.9.1	Reset and initialisation behaviour parameter .....	58
9.10	Channel-oriented feedback.....	60

9.10.1	Switching status feedback .....	60
9.10.2	Brightness value feedback .....	63
9.10.3	Short-circuit feedback .....	65
9.10.4	Overload/mains voltage failure feedback .....	66
9.10.5	Load type feedback .....	67
9.10.6	Feedback telegrams parameter .....	69
9.10.7	Feedback objects .....	73
9.11	Time delays .....	75
9.11.1	Time delays parameters .....	76
9.12	Switch-on/switch-off behaviour .....	77
9.12.1	Soft ON/OFF function .....	77
9.12.2	Automatic switch-off .....	78
9.12.3	Switch-on/switch-off behaviour parameter .....	81
9.13	Scene function .....	83
9.13.1	Scene function parameters .....	87
9.13.2	Scene function objects .....	91
9.14	Staircase function .....	92
9.14.1	Staircase function parameters .....	103
9.14.2	Staircase function objects .....	107
9.15	Logic operation function .....	108
9.15.1	Logic operation function parameters .....	110
9.15.2	Logic operation function objects .....	111
9.16	Operating hours counter .....	112
9.16.1	Operating hours counter parameters .....	117
9.16.2	Operating hours counter objects .....	120
9.17	Disabling function/forced position .....	122
9.17.1	Disabling function/forced position parameter .....	126
9.17.2	Disabling function and forced position objects .....	131
<b>10</b>	<b>Inputs .....</b>	<b>132</b>
10.1	General settings .....	132
10.1.1	Configuration inputs parameters .....	136
10.2	Switching .....	138
10.2.1	Switching parameters .....	138
10.2.2	Switching objects .....	139
10.3	Dimming .....	140
10.3.1	Dimming of brightness .....	141
10.3.2	Dimming of colour temperature .....	141
10.3.3	Dimming of brightness and colour temperature .....	142

10.3.4	Dimming parameters .....	143
10.3.5	Dimming objects .....	147
10.4	Venetian blind .....	148
10.4.1	Shutter/blind parameters .....	152
10.4.2	Shutter/blinds objects .....	154
10.5	Value transmitter .....	155
10.5.1	1-byte value transmitter .....	158
10.5.2	2-byte value transmitter .....	158
10.5.3	3-byte value transmitter .....	159
10.5.4	6-byte value transmitter .....	162
10.5.5	Value transmitter parameters .....	163
10.5.6	Value transmitter objects .....	171
10.6	Scene extension .....	176
10.6.1	Scene extension parameters .....	177
10.6.2	Scene extension objects .....	177
10.7	2-channel operation .....	178
10.7.1	2-channel operation parameters .....	180
10.7.2	2-channel operation objects .....	186
10.8	Controller extension .....	193
10.8.1	Operating mode switchover .....	194
10.8.2	Presence function .....	195
10.8.3	Setpoint shift .....	196
10.8.4	Controller extension parameters .....	198
10.8.5	Controller extension objects .....	201
10.9	Temperature measurement .....	203
10.9.1	Temperature measurement parameters .....	206
10.9.2	Temperature measurement objects .....	208
10.10	Disabling functions .....	209
10.10.1	Disabling functions parameters .....	213
10.10.2	Disabling functions objects .....	216
<b>11</b>	<b>Logic functions .....</b>	<b>217</b>
11.1	Logic functions parameters .....	218
11.2	Logic gates .....	220
11.2.1	Logic gate parameters .....	222
11.2.2	Logic gates objects .....	225
11.3	Converter (1 bit -> 1 byte) .....	227
11.3.1	Converter parameters .....	228
11.3.2	Converter objects .....	230

11.4	Disabling element [Filtering/Time].....	231
11.4.1	Disabling element parameters.....	233
11.4.2	Disabling element objects.....	237
11.5	Comparator.....	238
11.5.1	Comparator parameters .....	240
11.5.2	Comparator objects .....	242
11.6	Limit value switch.....	245
11.6.1	Limit value switch parameters .....	247
11.6.2	Limit value switch objects .....	249
<b>12</b>	<b>Delivery state .....</b>	<b>252</b>

## 1 Information on the product

### 1.1 Product catalogue

Product name: Universal dimming actuator, 1-gang

Use: Actuator

Design: FM

Order no. 390011SU

### 1.2 Function

The universal dimming actuator works according to the leading edge phase control or trailing edge phase control dimming principle and makes switching and dimming of incandescent lamps, HV halogen lamps and LV halogen lamps possible by means of conventional transformers and Tronic transformers, and dimmable HV LEDs and LV LEDs by means of electronic or conventional transformers.

The characteristic of the connected load - provided that the load is supported - can be automatically measured and the appropriate dimming procedure can be set. Alternatively, it is possible to predefine the dimming procedure using the ETS configuration. This procedure is necessary for loads that do not enable automatic calibration. One dimming output is available.

The device permits the feedback of the switching and brightness statuses of the connected load to the KNX. Moreover, a short-circuit and load failure can be signalled to the KNX.

Conventional push-buttons, switches or other potential-free contacts can be connected to the three input contacts of the control cable. In the factory setting, the output can be switched and dimmed with push-buttons on input 1 and 2. This feature permits fast checking of connected loads for proper functioning.

The function features that are adjustable by means of the ETS include, for example, separately configurable brightness ranges, extended feedback functions, a disabling function, or alternatively, a forced position function, a logic operation function, separately adjustable dimming behaviour, soft dimming functions, time delays and a stair-case function with pre-warning before switching off the lighting.

Furthermore, the dimming output can be integrated in up to 64 scenes with various brightness values. Moreover, the brightness value of the dimming output in case of bus voltage failure or bus voltage return and after ETS programming, can be preset.

The switch-on times of the dimming output can be detected and evaluated by operating hours counters.

In addition to dimming operation, the device has 8 internal logic functions. Using these functions, logic gates (e.g. AND, OR, exclusive AND, exclusive OR, each with up to 4 inputs) can be set up and thus switching and status information can be linked and evaluated. Alternatively, a 1-bit to 1-byte converter and a disabling element with filter and time functions can be configured for each logic function. As a further option,

comparators or limit value switches with hysteresis can be set as a logic function. The logic functions have their own KNX communication objects and can process telegrams of the actuator or of other bus devices.

The device can be updated. Firmware can be easily updated with the Jung ETS Service App (additional software).

The device is KNX Data Secure capable. KNX Data Secure offers protection against manipulation in building automation and can be configured in the ETS project. Detailed specialist knowledge is required. A device certificate, which is attached to the device, is required for safe commissioning. During mounting, the certificate must be removed from the device and stored securely.

Planning, installation and commissioning of the device are carried out with the aid of the ETS, version 5.7.3 and above or of the ETS6.

The device electronics are supplied exclusively from the bus voltage. The device is designed for installation in suitable flush-mounted appliance boxes (recommendation: electronic device box with partition).

### 1.3 Device components

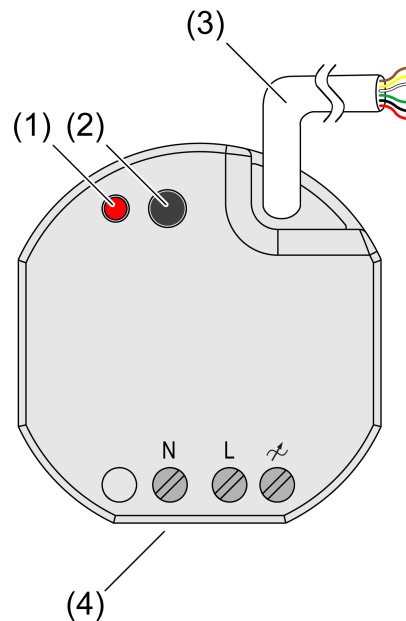

Image 1: Device components

- (1) Programming LED
- (2) Programming button
- (3) Control cable (KNX connection and extension inputs)
- (4) Load connection (dimming output)

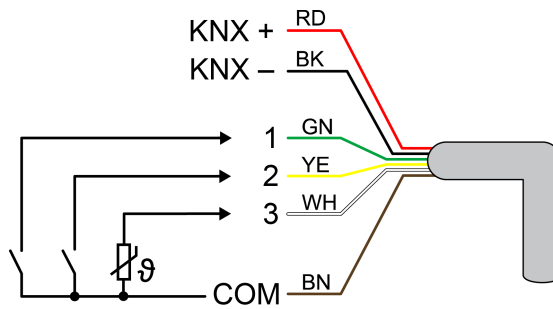

Image 2: Connection assignment of control cable (example)

red (RD)	KNX +
black (BK)	KNX -
green (GN)	Input 1 (push-button, switch, contact, dew/leakage sensor)
yellow (YE)	Input 2 (push-button, switch, contact, dew/leakage sensor)
white (WH)	Input 3 (push-button, switch, contact, dew/leakage sensor, NTC temperature sensor)
brown (BN)	COM inputs 1...3

## 1.4 Technical data

### Ambient conditions

Rated voltage	AC 230 V~
Mains frequency	50 / 60 Hz
Power loss	max. 1.5 W
Standby power	approx. 0.2 W
Ambient temperature	-5 ... +45 °C
Storage/transport temperature	-25 ... +70 °C
Dimensions (W × H × D)	48 x 50 x 28 mm

### KNX

KNX medium	TP256
Commissioning mode	S-mode
Rated voltage KNX	DC 21 ... 32 V SELV
Current consumption KNX	5 ... 18 mA
Connection mode KNX	Connection terminal on control cable

### Output

Connection mode	Screw terminals
Rated voltage	AC 230 / 240 V ~





Connected load depends on the connected lamps and set load type: (see figure 3) and (see figure 4)

ETS parameter load type

### UNI

universal (with automatic calibration procedure)



	conv. transformer (inductive / leading edge phase control)
LED 	LED (leading edge phase control)
	electr. transformer (capacitive / trailing edge phase control)
LED 	LED (trailing edge phase control)











	 LED	 LED	 LED
25 °C			
	W	W	VA
UNI	1 ... 32	20 ... 100	20 ... 100
	1 ... 32	—	20 ... 100
LED 	1 ... 32	20 ... 100	—
	1 ... 200	20 ... 200	—
LED 	1 ... 200	20 ... 200	—
45 °C			
	W	W	VA
UNI	1 ... 25	20 ... 100	20 ... 100
	1 ... 25	—	20 ... 100
LED 	1 ... 25	20 ... 100	—
	1 ... 200	20 ... 200	—
LED 	1 ... 200	20 ... 200	—

Image 3: Connected load LED lamps













	 		
25 °C			
	W	W	VA
UNI	20 ... 230	20 ... 210	20 ... 210
	20 ... 210	—	20 ... 210
LED 	20 ... 210	20 ... 210	—
	20 ... 230	20 ... 230	—
LED 	20 ... 230	20 ... 230	—
45 °C			
	W	W	VA
UNI	20 ... 210	20 ... 160	20 ... 160
	20 ... 160	—	20 ... 160
LED 	20 ... 160	20 ... 160	—
	20 ... 210	20 ... 210	—
LED 	20 ... 210	20 ... 210	—

Image 4: Connected load conventional lamps

### Power reduction

when installed in wooden or dry construction walls

-15%

when installed in multiple combinations

-20%

<b>Clampable conductor cross-section</b>	
single stranded	0.5 ... 4 mm <sup>2</sup>
Finely stranded without conductor sleeve	0.5 ... 4 mm <sup>2</sup>
Finely stranded with conductor sleeve	0.5 ... 2.5 mm <sup>2</sup>
Connection torque screw terminals	Max. 0.8 Nm
<b>Inputs</b>	
Control cable (preterminated)	YY6x0.6
Input type	Potential-free
Number	3
Total length of extension device cable	max. 10 m
Cable type (preferably)	J-Y(St)Y
Poll voltage, extension inputs	approx. 5 V

## 1.5 Accessories

External sensor	FF7.8
Condensation sensor	BTS01
Leakage sensor	LES01

## 2 Safety instructions



Electrical devices may only be mounted and connected by electrically skilled persons.

Serious injuries, fire or property damage possible. Please read and follow manual fully.

The device may not be opened or operated outside the technical specifications.

Danger of electric shock. Device is not suitable for disconnection from supply voltage. The load is not electrically isolated from the mains even when the output is switched off.

Danger of electric shock. Make sure during the installation that there is always sufficient insulation between the mains voltage and the bus. A minimum distance of at least 4 mm must be maintained between bus conductors and mains voltage cores.

Danger of electric shock on the KNX installation. Do not connect any external voltage to the inputs. The device might be damaged, and the SELV potential on the KNX bus line will no longer be available.

Fire hazard. For operation with inductive transformers, each transformer must be fused on the primary side in accordance with the manufacturer's instructions. Only safety transformers according to EN 61558-2-6 may be used.

The device must not be used in connection with consumers that could lead to danger to life or limb or damage to property, e.g. heaters or electrical machines.

Risk of destruction of the dimmer and load if the set operating mode and load type do not match. Set the correct dimming principle before connecting or exchanging the load.

These instructions are an integral part of the product, and must remain with the end customer.

### 3 Fitting and electrical connection

---



#### **DANGER!**

Mortal danger of electric shock.

Disconnect the device. Cover up live parts.

---



#### **DANGER!**

When connecting the bus/extensions and mains voltage wires in a shared appliance box, the KNX bus line may come into contact with the mains voltage.

This endangers the safety of the entire KNX installation. People at remote devices may also receive an electric shock.

Do not place bus/extensions and mains voltage terminals in a shared connection compartment. Use an appliance box with a fixed partition wall or separate appliance boxes.

---

#### **Connecting and fitting the device**

In secure operation (preconditions):

- Secure commissioning is activated in the ETS.
- Device certificate entered/scanned or added to the ETS project. A high resolution camera should be used to scan the QR code.
- Document all passwords and keep them safe.

Mounting in suitable appliance box (recommendation: electronic device box with partition). Observe cable routing and spacing (see figure 5)!

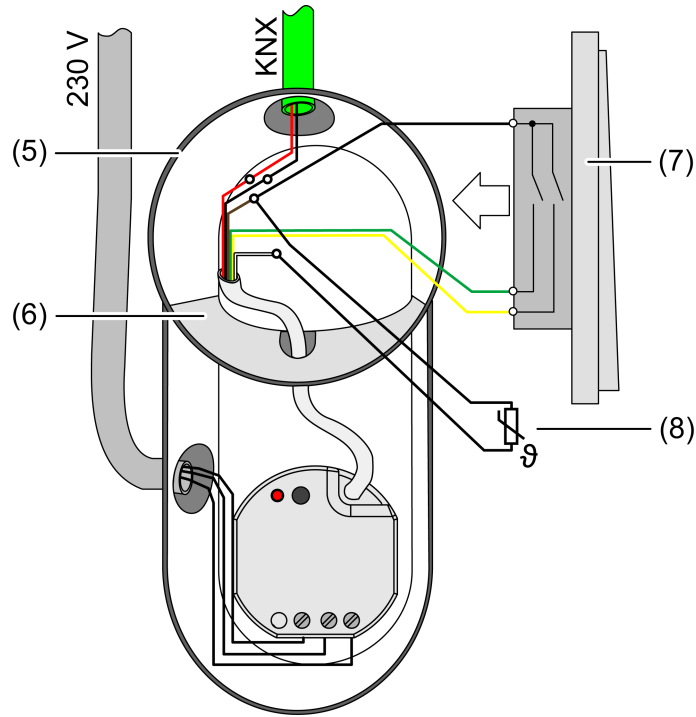

Image 5: Mounting example in electronic device box with partition wall, series push-button and NTC temperature sensor

- (5) Appliance box
- (6) Partition
- (7) potential-free contacts (e.g. series push-button)
- (8) NTC temperature sensor (optional)

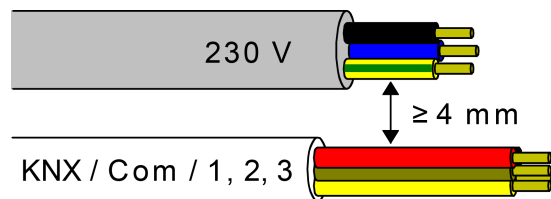

Image 6: Cable spacing

Minimum spacing between the mains voltage and bus/extension wires: 4 mm (see figure 6)

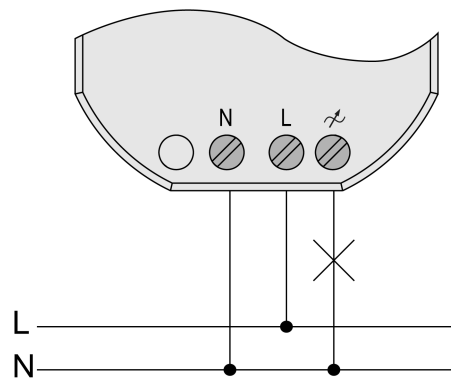

Image 7: Connection of load

Observe ambient temperature. Ensure adequate cooling.

- Connect the device to KNX with the correct polarity.
- Connect load as shown in the connection example (see figure 7).
- If required, connect potential-free contacts or dew/leakage sensors to inputs 1...3, or NTC temperature sensors to input 3 (see figure 2).
- Install the device in the appliance box.
- In secure operation: The device certificate must be removed from the device and stored securely.

**i** The COM reference potential must not be connected together with COM connections of other devices!

**i** Only use the dew/leakage sensors and NTC temperature sensors listed in the accessories. Functional errors may occur with other sensors.

## 4 Troubleshooting

### **Connected LED lamps or compact fluorescent lamps switch off in the lowest dimming position or flicker**

The set minimum brightness is too low.

Increase minimum brightness.

### **Connected LED lamps or compact fluorescent lamps flicker**

Cause 1: Lamps are not dimmable.

Check manufacturer's instructions.

Exchange lamps for another type.

Cause 2: Dimming principle and lamps do not optimally match.

For HV-LED: Check operation in another dimming principle, reduce connected load as well if necessary.

For LV-LED: Check the lamp operating device and replace as necessary.

With the "Universal" setting: Define the dimming principle manually.

### **Connected HV-LED lamps or compact fluorescent lamps in the lowest dimming position are too bright; dimming range is too small**

Cause 1: The set minimum brightness is too high.

Reduce minimum brightness.

Cause 2: HV-LED trailing edge phase control dimming principle does not optimally match the connected lamps.

Check operation in the "HV-LED leading edge phase control" setting, reduce connected load as well if necessary.

Exchange lamps for another type.

### **Output has switched off.**

Cause 1: overheating protection has tripped.

Disconnect output from mains, switch off associated circuit breakers.

HV-LED trailing edge phase control: Reduce the connected load. Exchange lamps for another type.

HV-LED leading edge phase control: Reduce the connected load. Check the operation in the "HV-LED trailing edge phase control" setting. Exchange lamps for another type.

Let device cool down for at least 15 minutes. Check installation situation, ensure cooling, e.g. provide distance from surrounding devices.

Cause 2: Overvoltage protection has triggered.

HV-LED trailing edge phase control: Check the operation in the "HV-LED leading edge phase control" setting, reduce the connected load as well if necessary.

Exchange lamps for another type.

- i** The response of the surge protection can be signalled by sending a short-circuit telegram or can be determined by polling the "short-circuit" communication object.

Cause 3: short-circuit in output circuit

Disconnect the output from the mains supply.

Eliminate short-circuit.

Switch on mains voltage again. Switch the affected output off and on again.

- i** When a short-circuit occurs the affected output switches off. Automatic restart when short-circuit is eliminated within 100 ms (inductive load) or 7 seconds (capacitive or ohmic load). After that lasting switch-off.
- i** When a short-circuit occurs during the calibration process, the load calibrates itself again after the short-circuit is eliminated.

Cause 4: load failure.

Check load, replace light bulb. For inductive transformers, check primary fuse and replace if necessary.

### **Output cannot be operated.**

Cause 1: Output is disabled.

Cancel disabling.

Cause 2: Application software missing or faulty.

Check programming and correct.

### **Output off and not possible to switch on**

Cause 1: bus voltage failure.

Check bus voltage.

### **Luminaires flicker or buzz, proper dimming not possible, device buzzes**

Cause: wrong dimming principle set

Installation or commissioning error. Disconnect device and luminaire, switch off circuit breaker.

Check installation and correct.

If the wrong dimming principle has been preselected: Set correct dimming principle.

If dimming actuator calibrates itself incorrectly, e.g. with highly inductive mains or long load cables: preselect correct dimming principle with commissioning.

### **LED lamp is dimly lit when dimmer is switched off**

Cause: LED lamp is not optimally suited for this dimmer.



Use a compensation module, see accessories.

Use another type of LED lamp or an LED lamp of another manufacturer.

## 5 Commissioning

### Commissioning the device

In the as-delivered state, the actuator is passive, i.e. no telegrams are transmitted to the KNX. The output is set to the universal dimming principle with automatic recognition of the load type. Control of the output is possible via inputs 1 and 2, provided the bus voltage is switched on. Input 3 has no function.

Input	Push-button (NO contact)	Function
1	Press briefly (< 0.4 s)	switch on
1	Press for a long time (> 0.4 s)	Increase brightness
2	Press briefly (< 0.4 s)	switch off
2	Press for a long time (> 0.4 s)	Reduce brightness
3	---	---

Table 1: Function of Inputs in the as-delivered state

The device can be programmed and put into operation via the ETS. The physical address is preset to 15.15.255

Moreover the device has been configured at the factory with the following characteristics...

- Behaviour in case of bus voltage failure: no reaction
- Behaviour in case of bus voltage return: brightness before bus voltage failure

### Load physical address and application program

- Parameterize correct dimming principle for the connected load.
- Press the programming button.  
The programming LED lights up.
- Load physical address and application program using the ETS.

### Safe-state mode

The safe state mode stops the execution of the loaded application program.

- i** Only the system software of the device is still functional. ETS diagnosis functions and programming of the device are possible.

### Activating the safe-state mode

- Switch off the bus voltage or disconnect the device from the KNX.
- Wait about 10 s.
- Press and hold down the programming button.

- Switch on the bus voltage or connect the device to KNX. Release the programming button only after the programming LED starts flashing slowly.

The safe-state mode is activated.

With a new brief press of the programming button, the programming mode can be switched on and off as usual also in the safe-state mode. If Programming mode is active, the programming LED stops flashing.

### **Deactivating safe-state mode**

- Switch off bus voltage (wait approx. 10 s) or carry out ETS programming.

### **Master reset**

The master reset restores the basic device setting (physical address 15.15.255, firmware remains in place). The device must then be recommissioned with the ETS.

During secure operation: A master reset deactivates device security. The device can then be recommissioned with the device certificate.

### **Performing a master reset**

Precondition: The safe-state mode is activated.

- Press and hold down the programming button for > 5 s.

The programming LED flashes quickly.

The device performs a master reset, restarts and is ready for operation again after approx. 5 s.

### **Restoring the device to factory settings**

Devices can be reset to factory settings with the Jung ETS Service App. This function uses the firmware contained in the device that was active at the time of delivery (delivery state). Restoring the factory settings causes the devices to lose their physical address and configuration.

**6 Application programs**

ETS search paths: Illumination / Dimmer / LED universal dimming actuator, 4-gang

Name Dimming, inputs 3031x2

Version: 1.2  
for ETS5 from Version 5.7.3 onwards and ETS6

2.2  
Dedicated application for secure operation.  
for ETS5 from Version 5.7.3 onwards and ETS6

from mask version SystemB (07B0)

Summarized de- Multifunctional dimming application with inputs and logic func-  
scription tions. KNX Data Secure capable.

## 7 Scope of functions

### General

- KNX Data Secure capable.
- Three inputs for connecting potential-free switches, push-buttons or contacts (e.g. magnetic contacts). Signal evaluation of dew and leakage sensors at inputs 1...3 and acquisition of temperature values via NTC temperature sensor at input 3 (accessory) possible.
- If required, effect of inputs 1 and 2 in the application for switches, push-buttons or contacts internally on the dimming output. With internal action, inputs 1 and 2 directly operate the dimming output in a defined configuration. In the delivery state, operation of the dimming output is possible via input 1 (Brighter) and input 2 (Darker).
- Up to 8 independent logic functions for the implementation of simple or complex logic operations.
- Actively transmitting feedback or status messages can be delayed globally after bus voltage return or after ETS programming.
- Updateable with Jung ETS Service App

### Dimming output

- Switching and dimming of the dimming output.
- Central control function with up to 6 switching objects, 6 dimming objects and 6 value objects and collective feedback.
- Switching feedback mode: Active (transmitting after changes or cyclically to the bus) or passive (object readout) feedback function.
- Reaction in case of bus voltage failure and bus voltage return as well as after ETS programming is adjustable.
- Logic function for the output.
- Disabling function can be parameterized for the output. Alternatively, forced position function is configurable for the output.
- Timing functions (switch-on delay, switch-off delay, staircase lighting timer, also with pre-warning function)
- Incorporation into light moods: up to 64 internal scenes parameterizable.
- Operating hours counter can be activated for the output.
- Input monitoring for cyclical updating of the switching object with safety position.

### Inputs

- Depending on the ETS parameterisation in the application for switches, push-buttons or contacts, the inputs 1 and 2 either act internally on the dimming output or alternatively also separately on the KNX. Input 3 always acts on the KNX if required.

- Individually adjustable functions for the inputs with effect on the KNX (switching, dimming, venetian blind, value transmitter, scene extension, 2-channel operation, controller extension, no function).
- Switching: Command adjustable when closing and opening the contact (no reaction, ON, OFF, TOGGLE). Presetting of the behaviour after bus voltage return possible.
- Dimming: Dimming of brightness and / or colour temperature. Command when closing the contact, time between switching and dimming, dimming in different steps, telegram repetition in case of long signal at the input and sending of a stop telegram at the end of the dimming process can be configured. Presetting of the behaviour after bus voltage return possible.
- Venetian blind: Command when closing the contact and operating concept parameterisable. Times for short and long signal at input and slat adjustment adjustable. Presetting of the behaviour after bus voltage return possible.
- Value transmitter: Functionality as 1 byte, 2 byte, 3 byte or 6 byte value transmitter incl. colour temperature and colour value transmitter possible. Individually configurable values. Optionally, a value adjustment is possible with a long signal at the input (not with the 6-byte value transmitter) and the specification of the behaviour after bus voltage recovery.
- Scene extension: The operating mode (with or without storage function) and the scene number is adjustable.
- 2-channel operation: When closing the contact at the input, up to two telegrams can be sent out on the KNX. Operating concept adjustable (channel 1 only or channel 2 / both channels). The functioning of the channels (1-bit, 1-byte, 2-byte, 3-byte, 6-byte) can be configured separately.
- Controller extension: The function (operating mode selection, forced operating mode switch-over, presence function and setpoint shift) is adjustable.
- Disabling of all or individual inputs possible via a 1-bit object. Polarity of the disabling object, behaviour at the beginning and end of disabling and behaviour during an active disabling can be set.

### Logic functions

- The device has 8 internal logic functions in addition to the dimming operation.
- Logic gates (e.g. AND, OR, exclusive AND, exclusive OR, each with up to 4 inputs).
- 1-bit to 1-byte converter with input filter, disabling object and presetting of the output values.
- Disabling element with filter and time functions and disabling object.
- Comparator for values with 9 different input data formats and many comparison operations.
- Limit switch with hysteresis with upper and lower threshold for 9 different input data formats. Incl. presetting of the 1-bit output values.
- The logic functions have their own KNX communication objects and can process telegrams of the actuator or of other bus devices.

## 8 Notes on software

### Unloading the application program

When using the dedicated application for secure operation: The application programme can be unloaded by the ETS. In this case, the device has no function on the part of KNX. However, the internal control of the dimming output via the inputs is then possible.

When using the application for conventional operation: The application programme can be unloaded by the ETS. In this case, the device has no function on the part of KNX. The internal control of the dimming output via the inputs is then no longer possible.

### ETS project design and commissioning

For project design and commissioning of the device, ETS5 from Version 5.7.3 onwards or ETS6 is required. Project designing and commissioning of the device using ETS2, ETS3 or ET4 is not possible.

## 9 Dimming output

### 9.1 Name of the dimming output

You can optionally assign a name for the dimming output. The name should clarify the use of the output (e.g. "living room wall lamp", "bathroom ceiling lamp"). The name is only used in the ETS in the text of the parameter pages and communication objects.



### 9.1.1 Name of the dimming output parameter

Dimming output 1 -> DO1 - General

Name of the dimming output	Free text
<p>The text entered in this parameter is applied to the name of the communication objects and is used to label the dimming output in the ETS parameter window (e.g. "living room wall lamp", "bathroom ceiling lamp").</p> <p>The text is not programmed in the device.</p>	

## 9.2 Defining load type

---



### CAUTION!

Risk of destruction if the preset dimming principle and connected load do not match.  
The dimmer and load may be destroyed.  
Before changing the dimming principle, observe load type.  
Before changing the load type, make sure that the dimming principle is correct.  
Before changing the load type, disconnect the load circuit concerned. Check parameter settings and adjust if necessary.

---



### CAUTION!

Danger of destruction from mixed loads.  
The dimmer and load may be destroyed.  
Do not connect capacitive loads, e.g. electronic transformers, and inductive loads, e.g. inductive transformers, together on the same dimmer output.  
Do not connect inductive transformers together with HV LED lamps or compact fluorescent lamps on the same dimmer output.

---

The device works according to the leading edge phase control or trailing edge phase control dimming principle and makes switching and dimming of incandescent lamps, HV halogen lamps and LV halogen lamps, compact fluorescent lamps as well as HV LEDs and LV LEDs possible by means of conventional transformers and Tronic transformers. The characteristic of the connected load can automatically be measured and the appropriate dimming procedure can be set. Alternatively, the dimming procedure can be predefined by a parameter in the ETS without calibration taking place. This procedure is necessary for loads that do not enable automatic calibration.

- i** When selecting the appropriate dimming principle, the specifications of the lamp manufacturer and/or transformer manufacturer should generally be observed.
  - Set the parameter to "universal (with calibration procedure)".

The dimming output calibrates itself universally to the connected load type. After programming with the ETS, after bus voltage return or after switching on the mains voltage supply of a load output, the actuator calibrates itself automatically to the connected load. The calibration procedure becomes noticeable during ohmic loads by a brief flicker and lasts up to 10 seconds depending on the network conditions.
- i** This setting must not be selected for loads that do not enable automatic calibration. In this case, a suitable dimming principle must be preselected (see following settings).
  - Set the parameter to "electronic transformer (capacitive / phase cut-off)".

The dimming output is preset to trailing edge phase control principle. There is no automatic calibration of the load type. Ohmic loads, electronic transformers or LV-LEDs (via Tronic transformers) can be connected to the output.

- Set the parameter to "conventional transformer (inductive/leading edge phase control)".

The dimming output is preset to leading edge phase control principle. There is no automatic calibration of the load type. Conventional transformers or LV-LEDs (via conv. transformers) can be connected to the output.

- Set the parameter to "LED (Phase cut-off)". The dimming output is preset to an optimized trailing edge phase control principle.

There is no automatic calibration of the load type. HV LED or compact fluorescent lamps optimized for this dimming principle can be connected to the output.

- Set the parameter to "LED (Phase cut-on)".

The dimming output is preset to an optimized leading edge phase control principle. There is no automatic calibration of the load type. HV LED or compact fluorescent lamps optimized for this dimming principle can be connected to the output. Conventional transformers cannot be connected to the output.

**i** In the as-delivered state of the device, the dimming principle is set to "universal".

**i** When changing the load type on the output, the dimming principle must also be changed if necessary!

Recommendation for the configuration of the dimming principle with HV-LED lamps:

It is recommended to set the "Type of connected load" in the ETS to "universal" (this dimming principle also corresponds to the as-delivered state of the dimming actuator). If automatic calibration of the load does not work or produces insufficient dimming results, it is recommended to operate HV LED lamps preferably in the load type "LED trailing edge phase control", regardless of the manufacturer's specification. The advantage of this setting lies in the fact that the dimming output can provide the maximum LED nominal load (see technical data). This is often not possible in leading edge phase control principle. Only configure the type of load in the ETS to "LED leading edge phase control" if the operation of the connected LED lamps in the trailing edge phase control principle is not satisfactory (e.g. dimming range is too small).

Protection functions (over-voltage switch-off) ensure that the device is not destroyed if the connected LED lamps are controlled in a dimming principle that the manufacturer has not designed them for.

Problem resolution with HV-LED lamps:

Possible problems during operation of HV LED lamps and their remedial measures are demonstrated in the following.

Parameter setting "LED trailing edge phase control" ->

Problems:

- Dimming range too small
- Minimum brightness too high
- Lamps flicker
- Output switches off due to overvoltage

Remedy: Check operation in the leading edge phase control, reduce connected load as well if necessary, exchange lamps for another type.

Parameter setting "LED leading edge phase control" ->

Problems:

- Lamps flicker
- Dimmer actuator overheats (output switches off due to overtemperature)
- Dimmer actuator hums

Remedy: Reduce connected load, check operation in the trailing edge phase control, exchange lamps for another type.

### 9.2.1 Load type parameter

Dimming output 1 -> DO1 - General

Load type	<p><b>universal (with automatic calibration procedure)</b></p> <p>electr. transformer (capacitive / trailing edge phase control)</p> <p>conv. transformer (inductive / leading edge phase control)</p> <p>LED (trailing edge phase control)</p> <p>LED (leading edge phase control)</p>
-----------	---

The dimming principle of the dimming output is specified here.

**universal (with automatic calibration procedure):** The dimming output calibrates itself universally to the connected load type. After programming with the ETS, after bus voltage return (without mains voltage) or after switching on the mains voltage supply of a load output, the actuator calibrates itself automatically to the connected load. The calibration procedure becomes noticeable during ohmic loads by a brief flicker and lasts up to 10 seconds depending on the network conditions.

**Electronic transformer (capacitive/trailing edge phase control):** The dimming output is preset to the trailing edge phase control principle. There is no automatic calibration of the load type. Ohmic loads or electronic transformers can be connected to the output.

**Conventional transformer (inductive/leading edge phase control):** The dimming output is preset to the leading edge phase control principle. There is no automatic calibration of the load type. Conventional transformers can be connected to the output.

**LED (trailing edge phase control):** The dimming output is preset to an optimized trailing edge phase control principle. There is no automatic calibration of the load type. HV LED or compact fluorescent lamps optimized for this dimming principle can be connected to the output.

**LED (leading edge phase control):** The dimming output is preset to an optimized leading edge phase control principle. There is no automatic calibration of the load type. HV LED or compact fluorescent lamps optimized for this dimming principle can be connected to the output.

### 9.3 Operation with universal power booster

To increase the connected load, power boosters can be connected to the device.

- i** Power extension possible by means of our own power boosters.
- i** Choose power boosters that are suitable for the dimmer and load! For additional information, please always refer to the instructions for the power extensions in question.
- i** Visible brightness differences between the lighting on a dimmer actuator output without power booster and a dimming actuator with power booster are possible.
- i** When using conventional power boosters for leading edge phase control or trailing edge phase control principle (NV or TRONIC power boosters) it is not normally necessary to adapt the output signal of the dimmer actuator.
- i** Older universal power boosters (article no. ULZ1215REG), which are not designed for operation with LEDs, supply themselves with energy directly via components of the dimming actuator's output signal (no neutral conductor connection available). To ensure failure-free operation, the dimmer actuator output signal must be adapted in such a way that a certain amount of residual phase angle still remains (residual cut-on or off) for the highest dimming position. This residual phase angle must be large enough to enable universal power boosters to supply themselves with energy. When connecting the current Amplifier LED, article. no. ULZ1755REG, this adjustment is not necessary.
- Deactivate the parameter "Operation with universal power booster (OLD)".  
No universal power booster (article no. ULZ1215REG) is connected to the dimming output. In the highest dimming position (100 % brightness value), the smallest possible residual phase angle is set on the dimmer output. As a result, the connected lighting is set to the maximum lighting level technically possible.
- Activate the parameter "Operation with universal power booster (OLD)".  
At least one universal power booster (article no. ULZ1215REG) is connected to the dimming output. In the highest dimming position (100 % brightness value), a residual phase angle necessary for universal power boosters is set on the dimmer output. The output signal cut-on or cut-off in this way corresponds to a resulting brightness of approx. 90 % compared to an identically constructed dimming actuator without a power booster. The dimming actuator rescales the adjustable brightness range automatically for the output so that a presetting and feedback within a range of 0...100% is still possible.

**9.3.1 Parameter operation with universal power booster (OLD)**

Dimming output 1 -> DO1 - General

Operation with universal power booster (OLD)	Checkbox (yes / no)
<p>If the output power is increased by means of older universal power boosters (article no. ULZ1215REG), the output configuration of the dimming actuator must be adapted here. The dimming actuator adapts the output signal automatically for using universal power boosters based on the setting of this parameter. When connecting the current Amplifier LED, article. no. ULZ1755REG, this adjustment is not necessary.</p>	

## 9.4 Dimming characteristic

The human eye is adapted to natural daylight. As a result, it works in a very wide range of brightness from twilight in the early morning and late evening to bright daylight at noon. In the lower brightness area the eye is clearly more sensitive than in the upper area.

When dimming simple lamps, the electrical power is uniformly converted into a luminous flux that is emitted into the surrounding room. This luminous flux results in illuminance that can be measured with a luxmeter. If the lamp emits 50% of its maximum luminous flux, it already appears as intense brightness to the eye. When the luminous flux of the lamp rises to 75%, illuminance increases by the same amount. However, the eye perceives this change much weaker.

When different current lamp types are dimmed, luminous flux and subjective perceptions of brightness can vary considerably. For this reason, the dimming actuator offers several options for adjusting the dimming characteristics as required.

- If the lighting is regularly controlled via percentage presetting of the dimming value, the suitability of the dimming characteristic in the value range should be checked as a priority.
- If the lighting is dimmed manually via the 4-bit object, the dimming characteristic can be adjusted in the time range.

### Dimming characteristic curve in the value range

Six characteristic curves are available for adapting to different luminaires, which the dimming actuator can use to convert the percentage input value from the KNX (DPT 5.001) to the output value of the dimming output. The following table shows the differences in the characteristic curves.

KNX value	KNX value [%]	logarithmic function [%] (1)	root function [%] (2)	linear function [%] (3)	quadratic function [%] (4)	cubic function [%] (5)	exponential function [%] (6)
0	0	0	0	0	0	0	0
1	0.4	0	6	0.4	0	0	0
10	4	42	20	4	0	0	0
25	10	58	31	10	1	0	0
50	20	71	44	20	3	1	0
80	32	79	56	32	10	3	0
100	40	83	63	40	15	6	0
125	50	87	70	50	24	12	0
150	60	90	77	60	35	20	1
175	70	93	83	70	47	32	2.4
200	80	96	88	80	62	48	8
225	90	98	94	90	78	69	25



KNX value	KNX value [%]	logarithmic function [%] (1)	root function [%] (2)	linear function [%] (3)	quadratic function [%] (4)	cubic function [%] (5)	exponential function [%] (6)
255	100	100	100	100	100	100	100

Table 2: Dimming characteristics in the value range

The connected luminaires convert the dimmed output voltage into a luminous flux that is emitted into the room. This luminous flux is different for each type of lamp. The subjective brightness perception of the human eye differs from the illuminance that can be measured.

The following diagrams present a comparison for a lamp type of the measured illuminance and the brightness perceived for the dimming characteristics that can be set in the ETS. Because the properties of different lamp types deviate from one another, the most suitable dimming characteristic must be determined locally if necessary. If an existing lamp is replaced by a lamp of a different type, it may be useful to change the dimming characteristic.

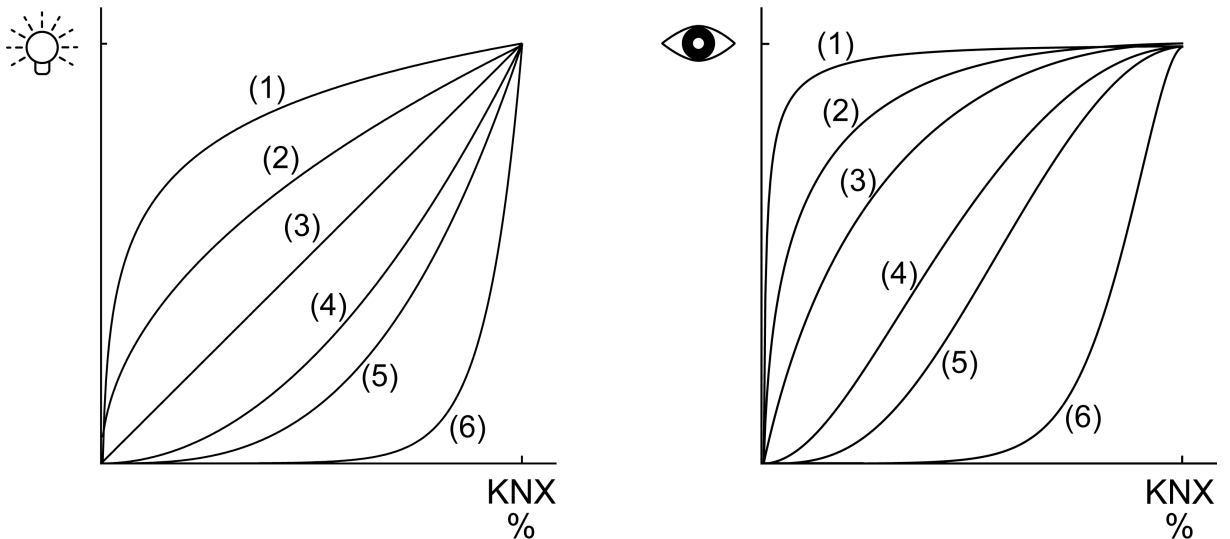

Image 8: Dimming characteristics in the value range

**Setting the dimming characteristic in the value range**

In the as-delivered state, the linear dimming characteristic is set in the value range. If the dimming behaviour is not satisfactory, particularly in the lower dimming range, the dimming behaviour may be improved by selecting a different dimming characteristic. The adjustment of the dimming characteristic is related to the adjustment of the lower brightness limit and the maximum brightness.

The 1-byte brightness value communication object is connected to a group address. The maximum brightness is set to 100%. When a brightness value is received, the value is jumped to.

- Check/set the lower brightness limit.
- Gradually increase the brightness value and evaluate the brightness change.
- If the brightness change in the lower range is too strong, select a flatter characteristic curve.

- If the brightness change in the lower range is too weak, select a steeper characteristic curve.
- For maximum brightness, select the brightness value from which no change is visible in the upper range.

The dimming characteristic is set in the value range.

**i** If dimming operation cannot be set properly with the dimming characteristics in the value range, check the load type or replace the lamp with another type.

### Dimming characteristic curve in the time range

In the case of the dimming actuator, the technically dimmable brightness range (basic brightness ... 100 %) is subdivided into 255 dimming increments (8-bit brightness value: 1...255 / 0 = switched off). In the as-delivered state of the actuator, the dimming increment times, i.e. the dimming times between 2 of 255 dimming increments, are set to the identical length. This results in a linear characteristic curve over the entire brightness range.

The dimmable brightness range is limited at the upper limit by the maximum brightness configured in the ETS. The lower brightness range is either defined by the basic brightness ("level 1", "level 2" to "level 8" -> "1%") or alternatively, by the minimum brightness. The dimming characteristics shown in the following diagrams distinguish these configurations and illustrate the resulting real dimming time of a dimming procedure.

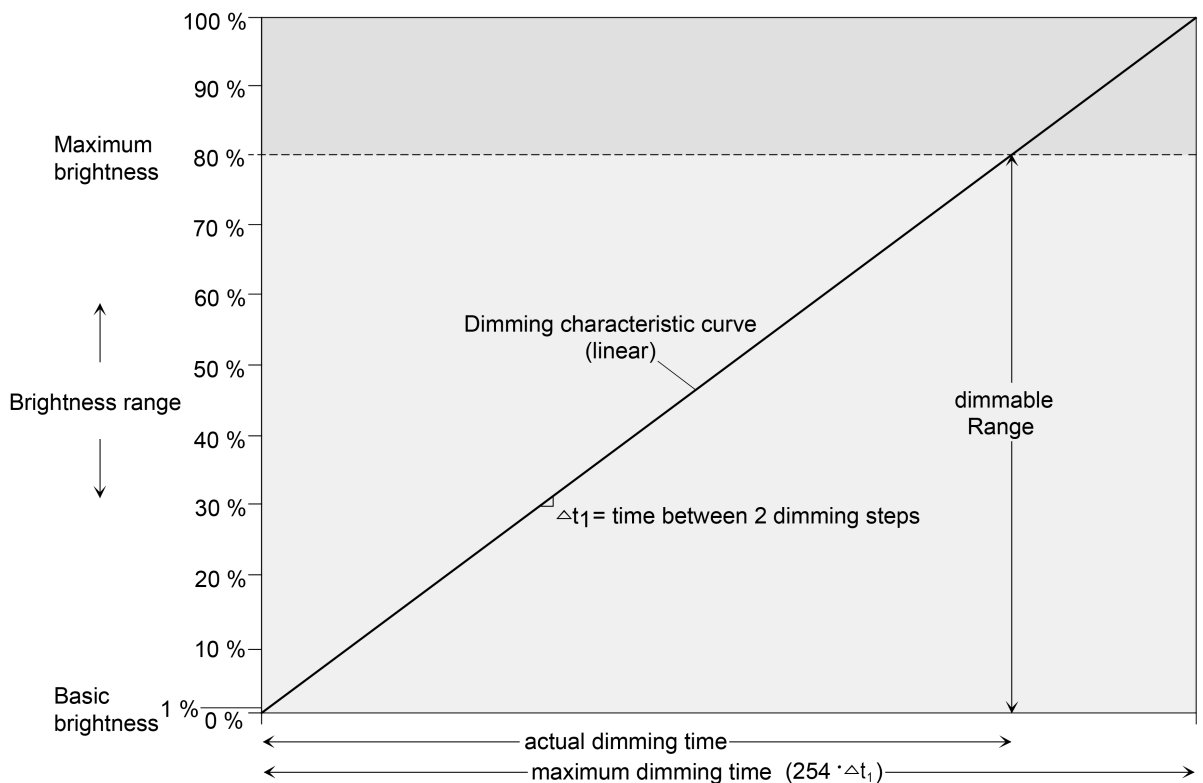

Image 9: Linear dimming characteristic as an example with basic brightness and maximum brightness

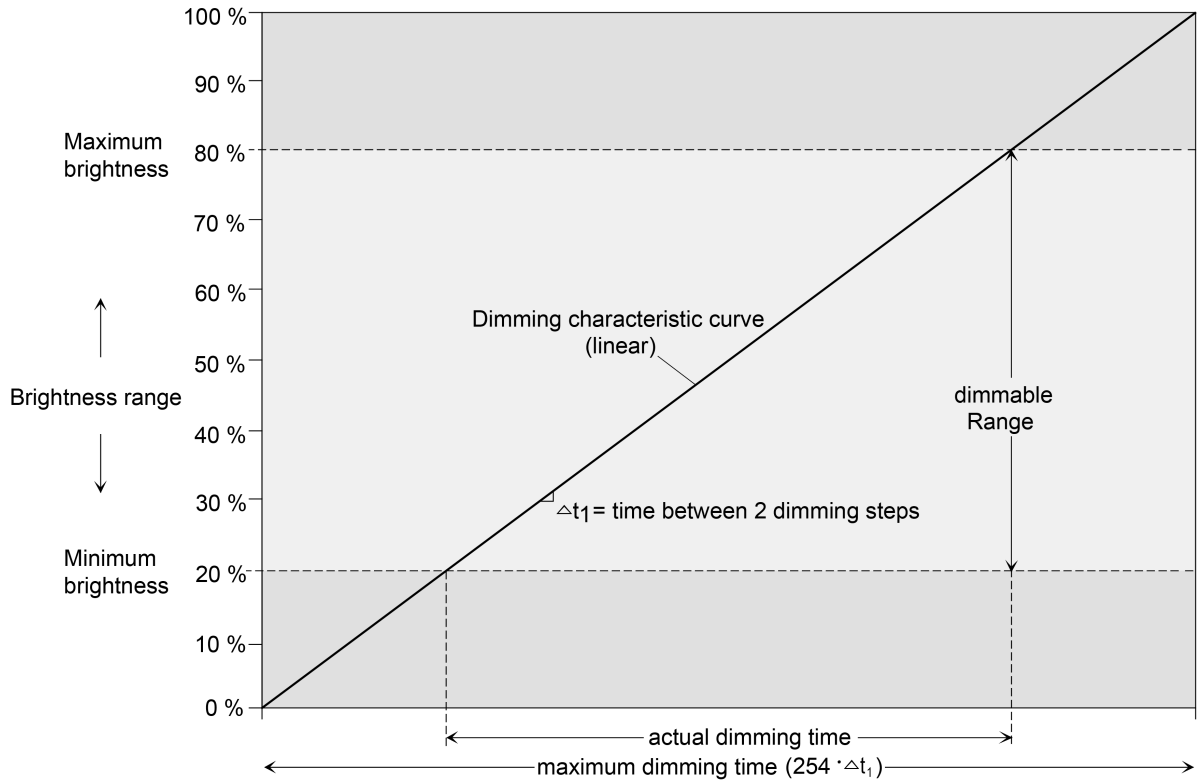

Image 10: Linear characteristic dimming curve as an example with minimum brightness > 0 % and maximum brightness

In some practical applications, a linear dimming characteristic is not optimal. Hence, the actuator in the ETS alternatively permits a user-defined adjustment of the dimming progress. In this way, for example, brightness changes can be adjusted to the brightness sensitivity of the human eye when dimming by subdividing the brightness range in up to 5 sections with different dimming increment times.

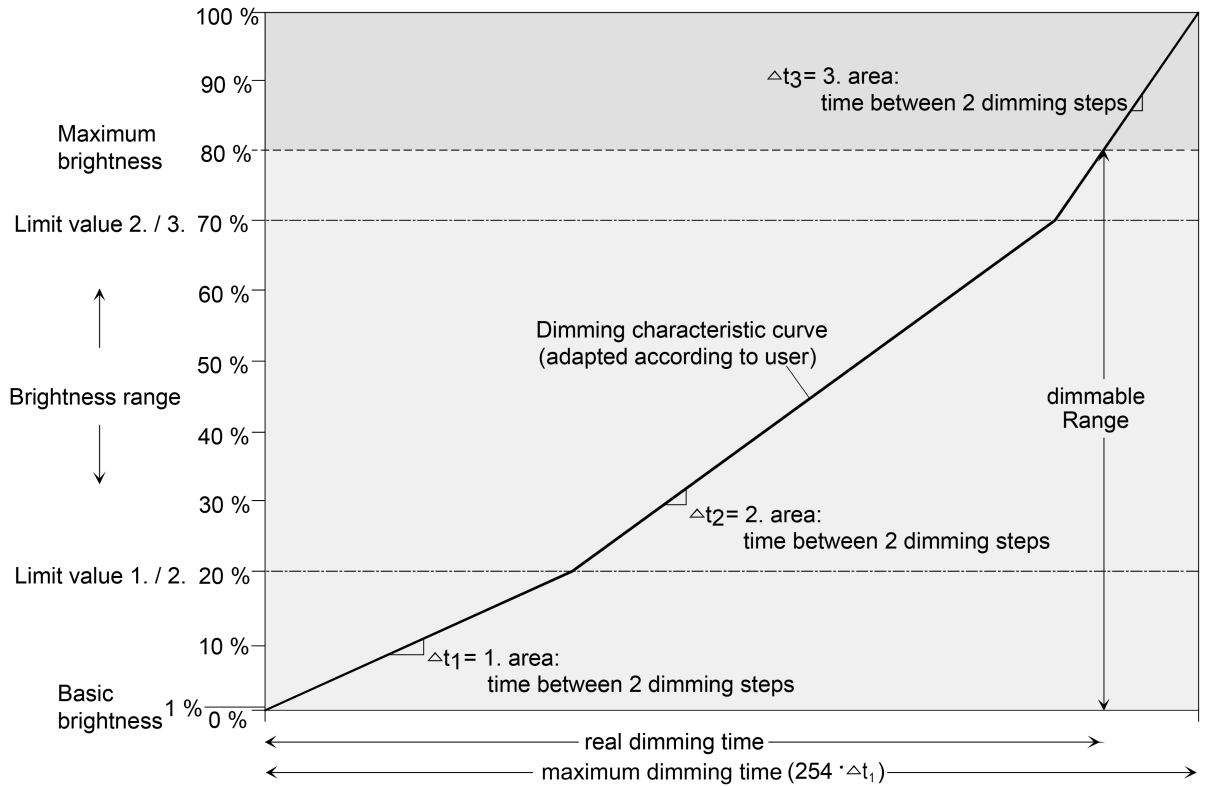

Image 11: User-defined dimming characteristic as an example with basic brightness and maximum brightness

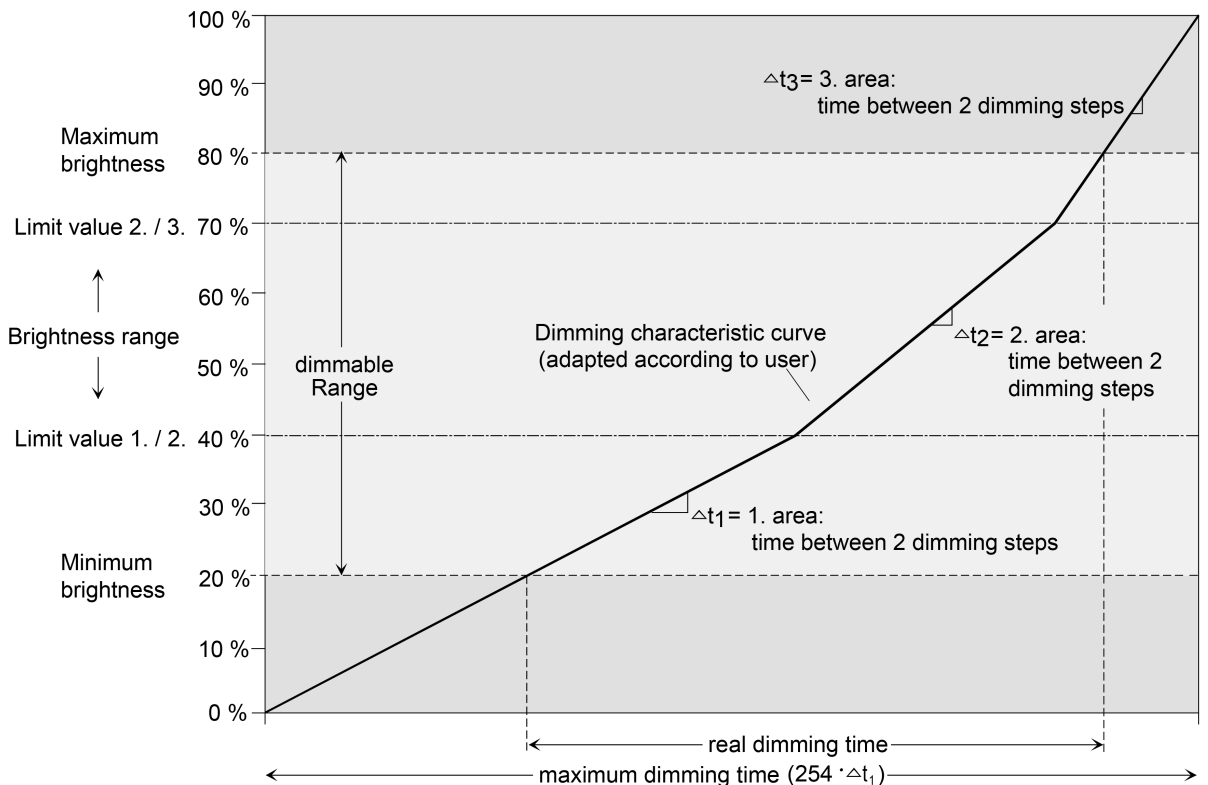

Image 12: User-defined dimming characteristic as an example with minimum brightness and

### Setting the dimming characteristic in the time range

- Set the parameter "Characteristic curve in the time range" on the parameter page "DO1 - dimming characteristic" to "Linear function".  
A linear dimming characteristic curve is set. A time between two dimming increments can also be configured for the entire brightness range in the ETS.
- Set the parameter "Characteristic curve in the time range" on the parameter page "DO1 - dimming characteristic" to "User-defined (y ranges)" (y = 2...5).  
A user-defined dimmer characteristic curve is set. Up to 4 limiting values and 5 times between two dimming increments can be defined for the definition of the brightness sections.

The dimming increment speed is identical for a relative dimming procedure or for the dimming of an absolute brightness value (not fading) and can be set in the ETS in the characteristic parameters.

The parameter "Characteristic curve" in the time range is set to "Linear".

- Set the parameter "time between two dimming increments " on parameter page "DO1 - dimming characteristic" to the necessary dimming increment time.  
During every relative or absolute dimming procedure, the entire brightness range is dimmed with the configured dimming increment speed.

The parameter "characteristic curve" is set to "user-defined".

- First define the brightness limit values. For this purpose, set the parameter "until brightness limiting value" of the various ranges on the parameter page "DO1 - dimming characteristic" to the necessary section limits.

In the configuration of the limiting value, care must be taken to ensure that the maximum brightness is not exceeded, or if necessary, the configured minimum brightness is not undershot.

The dimmable brightness range is divided into up to 5 sections. In the following, the dimming increment speeds for these three areas can be set separately.

- Set the parameter "Time between two dimming increments " on the parameter page "DO1 - dimming characteristic" to the necessary dimming increment time for each section.  
The dimming characteristic is defined ready. Each of the up to 5 sections is dimmed at the specified dimming increment speed.

### 9.4.1 Parameter Dimming characteristic

Dimming output 1 -> DO1 - General -> Dimming characteristic

Characteristic curve in the time range	<b>linear function</b> User-defined (2 ranges) User-defined (3 ranges) User-defined (4 ranges) User-defined (5 ranges)
--	--

The dimming characteristic curve of the dimming output in time domain can be set here. The lamp used can thus be adapted to the brightness sensitivity of the human eye.

Linear function: The brightness curve of basic brightness (decimal brightness value "1") up to 100% (decimal brightness value "255") is linear.

User-defined (... ranges): The brightness curve between basic brightness/minimum brightness and maximum brightness can be adapted individually. For this purpose, the brightness range is subdivided in up to 5 sections. Each section can be configured with an independent dimming speed.

Range ...	1 ... 25 ... 255 ms
Time between two dimming increments	

At this point, the dimming step speed (time between two dimming values) of the respective partial range is set.

With a linear characteristic curve there is only range 1.

Range ...	Basic brightness
until brightness limiting value	5 %
	10 %
	...
	<b>100 %</b>

The brightness limiting value is configured here. This limiting value defines the boundary between the first and second section.

With a linear characteristic curve, the limit value is fixed at 100 %.

<p>Characteristic curve in the value range</p>	<p><b>linear function</b>  exponential function  cubic function  quadratic function  root function  logarithmic function</p>
<p>Setting the characteristic curve in the value range allows the 256 dimming steps possible on KNX to be adapted to the perception of the human eye. If this parameter is changed, the curve of the characteristic curve is shown in the diagram below.  The selection of the characteristic curve depends on the connected lamp.</p>	

## 9.5 Brightness range

The brightness range, adjustable by switching or dimming procedures, can be limited by defining a lower and upper brightness value. The lower brightness value is either defined by the basic brightness, or alternatively, by the minimum brightness. The upper brightness value is always characterised by the maximum brightness. The maximum brightness adjustable in the ETS is never exceeded under any circumstances in the switched-on operating state of a dimming output. Neither when switching on nor when dimming. The maximum brightness value can be reduced for energy saving reasons, for example. In combination with some power boosters, it may also be necessary to reduce the maximum brightness (please observe the documentation of the power boosters and notes in the chapter in this documentation!). Furthermore, the brightness value, which should be set whenever switching on via the "switching" or "central switching" object or by manual operation on the dimming output, can be predefined. This switch-on brightness must always be between the upper and lower brightness limit value of the dimming range. The adjustable characteristics of the lower brightness value in the ETS differ as follows...

- Definition of the lower brightness limit with basic brightness (see figure 13):  
The "Basic brightness" parameter on the parameter page "DO1 – General" predefines the lower brightness threshold by adapting to the luminaires.

The basic brightness can be set to one of 8 step values and is a gauge for the minimum adjustable residual phase angle of the output signal in relation to the decimal brightness values "1", "2" and "3" (percentage: ~0.4 ... 1 %). The basic brightness can be undershot only by switching off. The configurable basic brightness enables the dimming signal to be adjusted in the smallest possible dimming position of the luminaire used. The basic brightness should be set to a step value at which the lamp at the smallest brightness value will still light up at an adequate level of brightness so that it is detected as switched on.

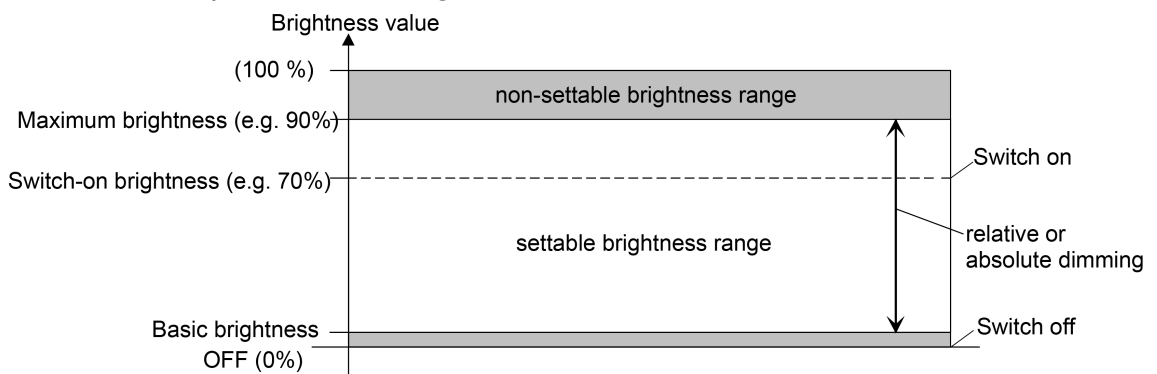

Image 13: Example of a brightness range with basic brightness

- Definition of the lower brightness limit with minimum brightness (see figure 14):  
The "Minimum brightness" parameter of the parameter page "DO1 – General" predefines a lower brightness threshold in the percentage range 1 % ... 100 % (decimal "3" ... "255") in stages. The minimum brightness cannot be undershot in any switched-on operating state of the dimming output. An undershot is only possible by switching off.



The brightness of the controlled lamps can be adapted individually – even to the brightness sensitivity of the human eye - by using the minimum brightness.

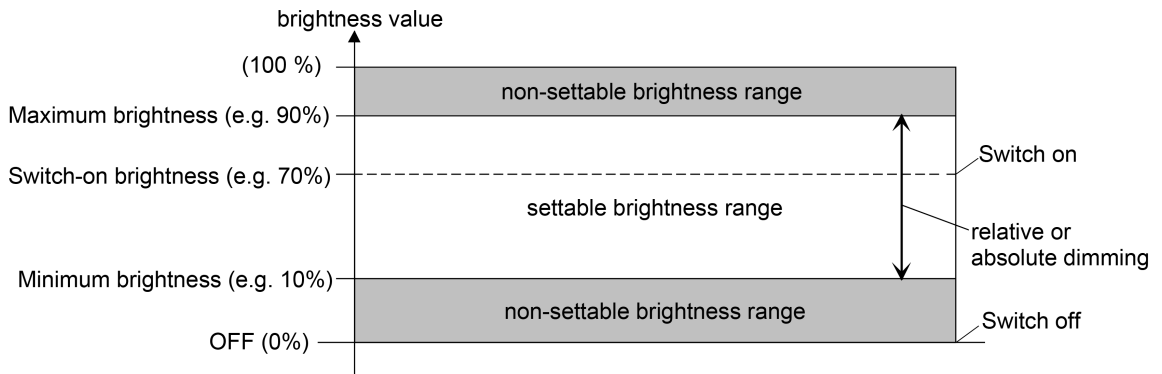

Image 14: Example of a brightness range with minimum brightness

### Adjusting basic brightness

The basic brightness can be set.

The parameter "Lower brightness limit" is set to "as basic brightness".

- Set the "Basic brightness" parameter to the required level value.  
The set level value is a gauge for the smallest adjustable residual phase angle of the output signal and therefore cannot be undershot in any switched-on operating state of the dimming output.
- i** The parameter should be set in such a way that the lamp will still light up at the lowest dimmer setting.
- i** When operating a universal power booster on the dimmer output (see parameter "Operation with universal power booster (OLD)", "Level 1" can be set, but has no effect. If the parameter should be set to level 1 in this case, the device executes level 2 as basic brightness.

### Setting the minimum brightness

The minimum brightness can be set.

The parameter "Lower brightness limit" is set to "as minimum brightness".

- Set the "Minimum brightness" parameter to the required brightness value.  
The set brightness is not undershot in any switched-on operating state.
- i** The ETS does not check all configured brightness values of the output during the editing of the minimum brightness (e.g. switch-on brightness, scene values)! If values that are smaller than the configured minimum brightness are predefined by the ETS configuration, the actuator sets the minimum brightness as brightness value later during operation. The same holds true if the actuator receives values via the brightness object during operation, which undershoots the minimum brightness.

## Setting the maximum brightness

The maximum brightness can be set.

- Set the "Maximum brightness" parameter on parameter page "DO1 - General" to the required brightness value.

The set brightness is not undershot in any switched-on operating state of the dimming output.

- i** The ETS does not check all configured brightness values of the output during the editing of the maximum brightness (e.g. switch-on brightness, scene values)! If values that are greater than the configured maximum brightness are predefined by the ETS configuration, the actuator sets the maximum brightness as brightness value later during operation. The same holds true if the actuator receives values via the brightness object during operation, which exceed the maximum brightness.
- i** When extending the power of a dimming output from our company by means of universal power boosters, the maximum brightness (ETS parameter) must be reduced to 90 % at most!

### 9.5.1 Brightness range parameter

Dimming output 1 -> DO1 - General -> Brightness range

Lower brightness limit	<p>as <b>basic brightness</b> as minimum brightness</p>
<p>The brightness range, adjustable by switching or dimming procedures, can be limited by defining a lower and upper brightness value.</p> <p>The lower brightness value is either defined by the basic brightness, or alternatively, by the minimum brightness. The upper brightness value is always characterised by the maximum brightness. The maximum brightness adjustable in the ETS is never exceeded under any circumstances in the switched-on operating state of a dimming output. Neither when switching on nor when dimming.</p> <p>This parameter defines whether the adjustable brightness range at the lower limit will be limited by the basic brightness or by a minimum brightness.</p>	
Basic brightness	<p>Level 1 <b>Level 2</b> Level 3 ... Level 8</p>
<p>The step value set here is a gauge for the minimum adjustable residual phase angle of the output signal and is set to the decimal brightness values "1", "2" and "3".</p> <p>The step value cannot be undershot in any switched-on operating state of the dimming output.</p> <p>This parameter is only visible if the "Lower brightness limit" is set to "Basic brightness".</p>	
Minimum brightness	<p>1 % 5 % 10 % ... 100 %</p>
<p>The brightness set here is not undershot in any switched-on operating state.</p> <p>This parameter is only visible if the "Lower brightness limit" is set to "Minimum brightness".</p>	
Maximum brightness	<p>1 % 5 % 10 % ... <b>100 %</b></p>
<p>The brightness set here is not undershot in any switched-on operating state.</p>	

## 9.6 Switching / dimming behaviour

### Switch-on brightness

The switch-on brightness can be set for dimming output.

- Set the "Switch-on brightness" parameter on parameter page "DO1 - General" to the required brightness value.

The set brightness is set after receipt of an ON telegram via the "Switching" communication object or by switching on by the manual operation on the dimming output. Furthermore, the configured switch-on brightness is set with the "activated" polarity after receipt of a central telegram.

- Alternatively, set the parameter "Switch-on brightness" to "Memory value (brightness before switching off last time)".

When switching on, the active and internally saved brightness value prior to switching off last time is set (via the "switching" or "central switching" object). After programming with the ETS, the value is predefined to maximum brightness. A bus voltage failure, however, does not delete the memory value.

- i** If the configured switch-on brightness is greater than the configured maximum brightness, the actuator sets the maximum brightness as the new brightness value for the dimming output when switching on (minimum brightness < switch-on brightness < maximum brightness).

- i** A memory value is also then saved internally by a switch-off telegram if the bus-controlled switch-off is overridden, for example, by a disable or forced position function or by a manual operation. In this case, the internally tracked brightness value is saved as memory value.

- i** If no soft ON function is activated, the brightness value is jumped to when switching on. Once a soft ON function is activated, the switch-on brightness is dimmed according to the dimming speed for the soft ON function.

### Behaviour when receiving a brightness value

The dimming behaviour for the absolute dimming can be set in the ETS for the dimming output via the "Brightness value" object.

- Set the parameter "On receipt of a brightness value" on the parameter page "DO1 - General" to "dim".

Once a new brightness value is received, it is set by means of the configured dimming increment time based on the predefined dimming characteristic.

- Set the parameter "dimming behaviour after receipt of a brightness value" to "jump to".

As soon as a new brightness value is received it will be instantly jumped to.

- Set the parameter "dimming behaviour after receipt of a brightness value" to "fading". In addition, on the parameter "Time for brightness value via fading", define the necessary fading time for dimming the scene brightness value.

Newly received brightness values will be dimmed. The dim fading is activated. The fading time defines the duration of the dimming procedure required to reach the new brightness value. The brightness value of the dimming output on which the dimming starts and the configured dimming characteristic have no significance. The dimming procedure thus always requires the exact pre-defined time when specifying a new brightness value.

- i** Brightness values can also be set by a disabling or forced position function. Absolute dimming can also be activated, even in case of bus voltage failure, after bus or mains voltage return or after programming with the ETS, by specifying brightness values. In the case of these absolute dimming functions, the brightness values are always instantly jumped to. During a scene recall, the dimming behaviour can be configured separately.

### Dimming up in the switched-off state

A relative dimming process can be triggered by the 4-bit "dimming" communication object or by a long button-press at the extension input. The data format of the "dimming" object complies with the KNX standard DPT "3.007", which means that the dimming direction and relative dimming increments can be predefined in the dimming telegram or dimming procedures can also be stopped. A relative dimming process is executed via the object until the configured basic minimum or maximum brightness of the dimming output is set, the dimming value reaches the dimming increment predefined in the telegram or a stop telegram is received. A relative dimming process allows a brightness value to be changed constantly and always starts from the brightness that is set stationary or dynamically at the time of the incoming dimming telegram.

A relative dimming telegram can also switch on the dimming output if this is in the "OFF" state. In some applications, it may be necessary, however, for a switched off dimming output to remain off until a relative dimming telegram is received. This is interesting when using light scenes, for instance: Several dimming outputs are set to a defined brightness value via a light scene. Other outputs are switched off by the scene. Only the brightness of outputs not switched off by the scene recall should be changed by dimming up afterwards. Here, it is necessary for dimming outputs not to react to a relative dimming operation and thus not to switch on.

The parameter "With relative dimming up in the switched-off state" defines whether or not the dimming output in the "OFF" state reacts to a relative dimming telegram. This also applies to a long operation at an extension input.

- Set the parameter to "Switch on output".  
The dimming output always reacts to a relative dimming telegram and executes a dimming process. In the "OFF" state, the output switches on with a "dim up" telegram.
- Set the parameter to "No reaction".  
The dimming output only reacts to a relative dimming telegram when it is switched on. In the "OFF" state, the output ignores a "dim up" telegram.

### 9.6.1 Switching/dimming behaviour parameters

Dimming output 1 -> DO1 - General -> Switching/dimming behaviour

Switch-on brightness	Basic brightness 5% 10% ... <b>100%</b> Memory value (brightness before last switch-off)
<p>This parameter specifies the brightness value, which should be set whenever switching on via the "switching" or "central switching" object or by extension operation on the dimming output. The switch-on brightness must always be between the upper and lower brightness limit value of the dimming range.</p> <p>The selection of "basic brightness" is not necessary when using a minimum brightness.</p> <p>In the "Memory value" setting, the active and internally saved brightness value prior to switching off last time is set when switching on (via the "switching" or "central switching" object).</p>	
On receipt of a brightness value	jumping to <b>dimming to</b> fading
<p>A parameter is used here to define whether a brightness value received via the bus is instantly jumped to (absolute dimming), or whether the brightness is dimmed to via the set dimming characteristic. Fading is also possible as an alternative. When fading, the received brightness value is reached in the exact configured fading time irrespective of the dimming characteristic and irrespective of which brightness value the dimming procedure was started at. Thus, for example, several dimming outputs can be set to the same brightness at the same time.</p>	
Time for brightness value via fading	0 ... 20 ... 240 s
<p>The fading time is set here if fading is predefined in the dimming behaviour. A dimming procedure via fading lasts for the exact configured time. If "0" is set, the brightness value is jumped to directly.</p>	

With relative dimming up in the switched-off state	<b>Switch on output</b> no reaction
<p>This parameter defines whether or not a dimming output in the "OFF" state reacts to a relative dimming telegram.</p> <p>Switch on output: The dimming output always reacts to a relative dimming telegram and executes a dimming process. In the "OFF" state, the output switches on with a "dim up" telegram.</p> <p>No reaction: The dimming output only reacts to a relative dimming telegram when it is switched on. In the "OFF" state, the output ignores a "dim up" telegram.</p>	

### 9.6.2 Switching/dimming behaviour objects

Object no.	Function	Name	Type	DPT	Flag
31	Switching	Dimming 1 (...) - Input	1-bit	1,001	C, -,W, -, U
1-bit object for switching the dimming output on or off ("1" = switch on; "0" = switch off).					
Object no.	Function	Name	Type	DPT	Flag
32	Switching feedback	Dimming 1 (...) - Output	1-bit	1,001	C, R, -, T, A
1-bit object for feedback signalling of the switching state ("1" = on / "0" = off) to the bus.					
Object no.	Function	Name	Type	DPT	Flag
34	Dimming	Dimming 1 (...) - Input	4-bit	3,007	C, -,W, -, U
4-bit object for relative dimming of a dimming channel.					
Object no.	Function	Name	Type	DPT	Flag
35	brightness value	Dimming 1 (...) - Input	1 bytes	5,001	C, -,W, -, U
1-byte object for predefining an absolute dimming value (brightness value 0...255) from the bus.					



## 9.7 Central functions

The actuator offers the possibility of connecting the dimming output with up to 6 central functions. Like the dimming output, each central function has a 1-bit object, a 4-bit object and a 1-byte object. The behaviour during the control of the output via the central functions can be set to "Switching & dimming" or alternatively to "Permanent" (Switching with priority).

Central function = "Switching & dimming":

This function is comparable to various central group addresses that are linked to the "Switching" object, "Dimming" object and "Brightness value" object of the dimming output. The last command received (ON or OFF, dimming or brightness value) is executed. The polarity of the switching telegram can be configured as inverted if necessary.

The parameter "With relative dimming up in the switched-off state" defines whether or not the dimming output in the "OFF" state reacts to a relative dimming telegram of the central "Dimming" object.

Central function = "Permanent":

The dimming output is controlled according to the parameterised command (ON or OFF) and locked during central control. The "Dimming" object and "Brightness value" object of the central function is not evaluated by the dimming output. This means that no other central function with the "Switching & dimming" function can control the locked output. Controls via normal switching objects are possible. If the output is assigned to several permanent central functions, the parameterised command decides on the priority of the central function. A "permanent OFF" has a higher priority than a "permanent ON" and thus is preferably executed. Activating a central function "permanent OFF" deactivates other assigned functions for the output with the setting "permanent ON".

### Example of permanent central functions

The output is assigned to central function 1 "switching", central function 2 "permanent OFF" and central function 3 "permanent ON". Central functions 2 and 3 are initially deactivated.

When a central telegram = "activate" on central function 3 is received, the output switches on. In this state, it can no longer be controlled by central function 1, since a simple "switching" has a lower priority. When a central telegram = "activate" on central function 2 is received, the output switches off immediately. Central function 3 is thus deactivated automatically. Only when central functions 2 and 3 are deactivated can the output be controlled again by central function 1.

- i** After bus voltage return, all central functions are inactive. No central functions are saved in the event of a bus voltage failure.

In the case of control via a central function, the transmission of the feedback signals of the switching status and the brightness value can be delayed for the output. This setting is only effective if the objects of the respective feedback are set as active signal objects.

## Disconnect central functions

- Activate the central functions on the parameter page "General -> Central functions" with the parameter "Central functions".  
The central objects become visible in the ETS. Names can optionally be assigned for the central functions. The names should illustrate the use of the individual central functions (e.g. "All ON", "Central OFF"). The names are only used in the ETS in the text of the central functions and central objects.

## Assign dimming output to the central functions

The dimming output can be assigned to the central functions.

The central functions must be enabled on the parameter page "General -> Central functions".

- Set the parameter "Function and polarity of the central object" on the parameter pages "Dimming output1 -> DO1 -General" to the desired function.  
The output is assigned to the central function. It can be influenced centrally.
- i** The state newly set by the central functions is tracked in the feedback objects and also transmitted to the bus, if these are actively transmitting.

### 9.7.1 General central functions parameter

General -> Central functions

Central functions	Checkbox (yes / no)
<p>If the parameter is activated, the 6 central functions of the dimming output and thus the objects "Switching central function ..." are switching input", "Central function ... dimming input" and "Central function ... brightness value input" are enabled. An assignment of the dimming output to the central functions is only possible if the function is enabled.</p>	

Name of the central functions	Free text
<p>Names can optionally be assigned for the central functions. The names should illustrate the use of the individual central functions (e.g. "All ON", "Central OFF"). The names are only used in the ETS in the text of the central functions and central objects.</p>	

Dimming output 1 -> DO1 - General

Delay for feedbacks	Checkbox (yes / no)
<p>The states of the switching status feedback and brightness value feedback can be transmitted to the KNX with a delay in the case of control with a central function.</p>	

Delay time	<p>0 ... 59 min 0 ... 5 ... 59 s</p>
<p>These parameters define the delay for switching status feedback and brightness value feedback for control with a central function. These parameters are only available if the delay for feedback signals is activated.</p>	

Central function X assignment (X = 1 ... 6)	Checkbox (yes / no)
<p>These parameters assign the additional functions to the dimming output. These parameters are only visible when central functions are enabled.</p>	

Function and polarity central objects	<b>Switching (1 = ON / 0 = OFF) &amp; dimming</b> Switching (0 = ON / 1 = OFF) & dimming Permanent ON (switching: 1 = active / 0 = inactive) Permanent OFF (switching: 1 = active / 0 = inactive)
<p>The function and polarity of the central function is selected here.</p> <p>Switching (1 = ON/0 = OFF) &amp; dimming: The last command received (ON or OFF) or dimming is executed. The polarity of the central telegram for switching is preset: 1 = ON/0 = OFF</p> <p>Switching (0 = ON/1 = OFF) &amp; dimming: The last command received (ON or OFF) or dimming is executed. The polarity of the central telegram for switching is preset: 0 = ON/1 = OFF</p> <p>Permanent ON (1 = active / 0 = inactive): The dimming output is switched on and locked during central control. The "Dimming" object and "Brightness value" object of the central function is not evaluated by the dimming outputs assigned.</p> <p>Permanent OFF (1 = active / 0 = inactive): The dimming output is switched off and locked during central control. The "Dimming" object and "Brightness value" object of the central function is not evaluated by the dimming outputs assigned.</p> <p>If an output is assigned to several permanent central functions, the parameterised command decides on the priority of the central function. A "permanent OFF" has a higher priority than a "permanent ON" and thus is preferably executed. With permanent function, the polarity of the central telegram is always fixed: 1 = activate permanent control / 0 = deactivate permanent control.</p> <p>These parameters are only visible when central functions are enabled and assigned.</p>	
With relative dimming up in the switched-off state	<b>Switch on output</b> no reaction
<p>This parameter defines whether or not a dimming output in the "OFF" state reacts to a relative dimming telegram.</p> <p>Switch on output: The dimming output always reacts to a relative dimming telegram and executes a dimming process. In the "OFF" state, the output switches on with a "dim up" telegram.</p> <p>No reaction: The dimming output only reacts to a relative dimming telegram when it is switched on. In the "OFF" state, the output ignores a "dim up" telegram.</p> <p>This parameter is only visible with the switching &amp; dimming settings.</p>	

### 9.7.2 Central functions objects

Object no.	Function	Name	Type	DPT	Flag
5, 8, 11, 14, 17, 20	Switching	Central function ... (...) - Input	1-bit	1,001	C, (R), W, -, A
1-bit object for switching the dimming output on or off ("1" = switch on; "0" = switch off).					
Object no.	Function	Name	Type	DPT	Flag
6, 9, 12, 15, 18, 21	Dimming	Central function ... (...) - Input	4-bit	3,007	C, (R), W, -, A
4-bit object for relative dimming of the dimming output.					
Object no.	Function	Name	Type	DPT	Flag
7, 10, 13, 16, 19, 22	brightness value	Central function ... (...) - Input	1 bytes	5,001	C, (R), W, -, A
1-byte object for predefining an absolute dimming value (brightness value 0...255) from the bus.					

## 9.8 Times

### Delay after bus voltage return

To reduce telegram traffic on the KNX bus line after bus voltage activation (bus reset), after connection of the device to the bus line or after an ETS programming operation, it is possible to delay all actively transmitted status or feedback telegrams of the switching function. For this purpose, delay can be specified (parameter "Delay after bus voltage return" on parameter page "General"). Only after the configured time elapses are feedback telegrams for initialisation transmitted to the KNX. Which of the telegrams is actually delayed can be set for each output and status function separately.

- i** The delay has no effect on the behaviour of the output. Only the bus telegrams for status or feedback are delayed. The output can also be controlled during the delay after bus voltage return.
- i** A setting of "0" for the delay after bus voltage return deactivates the delaying function altogether. In this case, any messages, if actively transmitted, will be transmitted to the KNX without any delay.

### Time for flashing of the disabling function

A disabling function can be activated for the output as an additional function . With this disabling function it is possible to have the output flash at the start or end of disabling.

#### 9.8.1 General times parameter

General -> Times

Delay after bus voltage return	0 ... 59 min 0 ... 17 ... 59 s
To reduce telegram traffic on the bus line after bus voltage activation (bus reset), after connection of the device to the bus line or after programming with the ETS, it is possible to delay all active feedback telegrams of the actuator. The parameter specifies in this case a delay valid for all devices. Only after the time configured here has elapsed are feedback telegrams for initialisation transmitted to the bus.	
Time for flashing of the disabling function	1 s, 2 s, 5 s, 10 s
At the start and end of the "disable" supplementary function, the dimming output can flash. The flash cycle time is set here.	

## 9.9 Reset and initialisation behaviour

### Response after a device reset

The switching state or the brightness value of the dimming output after a bus voltage failure, bus or mains voltage return or after an ETS programming operation can be set separately.

### Presetting the behaviour after ETS programming

The parameter "After ETS programming operation" can be preset on the parameter page "DO1 - General". This parameter can be used to configure the brightness behaviour of the dimming output, irrespective of the behaviour after bus voltage return.

- Set parameter to a brightness value.  
The dimming output is set to the predefined brightness value. It is important that the configured value does not undershoot the set minimum brightness (if present) or exceed the maximum brightness.
  - Set the parameter to "Switch off".  
The dimming output is switched off after a programming in the ETS.
  - Set the parameter to "no reaction".  
After an ETS programming operation, the dimming output shows no response and remains in the switching brightness state currently selected or is switched off.
  - Set the parameter to "as with bus voltage return".  
After an ETS programming operation, the dimming output evaluates the setting of the parameter "After bus voltage return" and sets the status defined there.
- i** The configured behaviour will be executed after every application or parameter download by the ETS. A simple download of the physical address alone or partial programming of only the group addresses has the effect that this parameter is disregarded and that the configured "Behaviour after bus or mains voltage return" will be executed instead.
- i** The actuator briefly initialises after each ETS programming operation. If the dimming output is configured to "universal" the output calibrates itself to the load. The calibration procedure becomes noticeable during ohmic loads by a brief flicker and lasts up to 10 seconds depending on the network conditions.
- i** A switching state and brightness value set after an ETS programming cycle is added to the feedback objects. Actively transmitting feedback objects also only first transmit after an ETS programming cycle when the initialisation has finished and, if necessary, the "delay time after bus voltage return" has elapsed.
- i** In the "no reaction" setting: After the programming operation, a brief switch-off occurs during the initialisation phase of the actuator. Afterwards, the brightness value that was active before is then reset again.

- i** After an ETS programming operation, the disabling functions and the forced-positions are always deactivated. The brightness values and forced position objects saved in case of the bus voltage failure are deleted.

**Setting the behaviour in case of bus voltage failure**

The parameter "After bus voltage failure" can be preset on the parameter page "DO1 - "General". This parameter can be used to configure the brightness behaviour of the dimming output, irrespective of the behaviour after bus voltage return.

- Set parameter to a brightness value.  
The dimming output is set to the predefined brightness value. It is important that the configured value does not undershoot the set minimum brightness (if present) or exceed the maximum brightness.
- Set the parameter to "Switch off".  
The dimming output is switched off in the case of bus voltage failure.
- Set the parameter to "no reaction".  
In case of bus voltage failure, the dimming output shows no reaction and remains in the currently set brightness state or is switched off.

- i** Active disabling functions or forced position functions are cancelled and remain inactive until they are reactivated.

- i** In the event of bus voltage failure, the current status of the forced position is also saved so that it can be readjusted when the bus voltage returns (depending on the parameterisation of the forced position functions).

- i** In case of a bus voltage failure, the current brightness value of the dimming output is permanently saved internally so that this brightness value can be reset after bus voltage return if this is configured in the ETS. The data is stored before the configured reaction for bus voltage failures takes place and only if the bus voltage has been available before without interruption for at least 20 seconds after the last reset (storage capacitors sufficiently charged for storage purposes). In all other cases nothing is stored (brightness value = "0").

**Setting the behaviour after bus voltage return**

The parameter "Behaviour after bus voltage return" can be preset on parameter page "DO1 - General".

- Set parameter to a brightness value.  
The dimming output is set to the predefined brightness value. It is important that the configured value does not undershoot the set minimum brightness (if present) or exceed the maximum brightness.
- Set the parameter to "Switch off".  
The dimming output is switched off on bus voltage return.
- Set parameter to "brightness before bus voltage failure".



After bus voltage return, the brightness value last set before bus voltage failure and internally stored in case of bus voltage failure will be tracked.

- Set the parameter to "no reaction".

On bus voltage return, the dimming output shows no reaction and remains in the brightness state currently selected or is switched off.

- i** In all settings: When the bus voltage is switched on, the brightness value is set to "0 %" if no mains voltage is switched on at the time of bus voltage return on the load output.
- i** Setting "Brightness before bus voltage failure": An ETS programming operation of the application or the parameter resets the stored switching state to "OFF - 0".
- i** In the "No reaction" setting: On return of bus voltage with permanently switched on mains voltage, the dimming output shows no response and remains in the brightness state last selected
- i** The actuator briefly initialises after switching on the mains voltage each time. If the dimming output is configured to "universal" the output calibrates itself to the load. The calibration procedure becomes noticeable during ohmic loads by a brief flicker and lasts up to 10 seconds depending on the network conditions.
- i** A switching state and brightness value set after bus voltage return is tracked in the feedback objects. Actively transmitting feedback objects first transmit, however, after bus or mains voltage return when the initialisation of the actuator has finished, and if necessary the "delay time after bus voltage return" has elapsed.
- i** In the case of forced position as supplementary function: The communication object of the forced position can be initialised separately after bus voltage return. This has an effect on the reaction of the dimming output when the forced position is activated. The configured "behaviour in the case of bus or mains voltage return" will only be executed if no forced position on bus voltage return is activated!
- i** In the case of enabling function as supplementary function: Active disabling function is always inactive after bus voltage return.

### 9.9.1 Reset and initialisation behaviour parameter

Dimming output 1 -> DO1 - General -> Reset behaviour

After ETS programming operation	brightness value switch off <b>no reaction</b> as with bus voltage return
---------------------------------	--

The actuator permits setting the brightness value for the dimming outout after programming with the ETS.

Brightness value: The output produces the brightness value defined with the following parameter.

Switch off: After an ETS programming procedure the output is switched off.

No reaction: After an ETS programming operation, the actuator retains the current brightness value.

like after bus voltage return: After an ETS programming operation, the actuator behaves as specified in the parameter "After bus voltage return".

brightness value	Basic brightness 5% 10% ... <b>100%</b>
------------------	---

This parameter defines the brightness value to be set after an ETS programming operation. The value must always be between the upper and lower brightness limit value of the dimming range.

The selection of "basic brightness" is not necessary when using a minimum brightness.

This parameter is only visible with the "Brightness value" setting.

In case of bus voltage failure	brightness value switch off <b>no reaction</b>
--------------------------------	--

The actuator permits setting the brightness value for the dimming channel in case of bus voltage failure.

Brightness value: The output produces the brightness value defined with the following parameter.

Switch-off: The output is switched off in case of bus voltage failure.

No reaction: In case of bus voltage failure, the actuator retains the current brightness value.

brightness value	Basic brightness 5% 10% ... <b>100%</b>
<p>This parameter defines the brightness value to be set in case of bus voltage failure. The value must always be between the upper and lower brightness limit value of the dimming range.</p> <p>The selection of "basic brightness" is not necessary when using a minimum brightness.</p> <p>This parameter is only visible with the "Brightness value" setting.</p>	

After bus voltage return	brightness value switch off <b>Brightness before bus voltage failure</b> no reaction activating staircase function
<p>The actuator allows the brightness value to be set for the dimming output after bus voltage return.</p> <p>Brightness value: The output produces the brightness value defined with the following parameter.</p> <p>Switch off: The output is switched off after bus voltage return.</p> <p>Brightness before bus voltage failure: After bus voltage return, the actuator restores the brightness value last stored in case of bus voltage failure.</p> <p>No reaction: On bus voltage return, the actuator retains the current brightness value.</p> <p>Activate staircase function: The staircase function is – irrespective of the "Switching" object - activated after bus voltage return. This setting is only available when the staircase function is enabled.</p>	

brightness value	Basic brightness 5% 10% ... <b>100%</b>
<p>This parameter defines the brightness value to be set after bus voltage return. The value must always be between the upper and lower brightness limit value of the dimming range.</p> <p>The selection of "basic brightness" is not necessary when using a minimum brightness.</p> <p>This parameter is only visible with the "Brightness value" setting.</p>	

## 9.10 Channel-oriented feedback

The actuator can track the current switching state and brightness value of the dimming output, the type of the connected load and any possible error states via separate feedback objects and can also transmit them to the bus, if the bus voltage is on. The following feedback objects can be enabled independently of each other ...

- Feedback switching status (1 bit)
- Feedback brightness value (1 byte)
- Short-circuit feedback (1 bit)
- Overload/mains voltage failure feedback (1 bit)
- Load type feedback (2 objects, 1 byte)

The actuator calculates the object value of the feedback objects during each switching or dimming procedure. The actuator tracks the switching state or brightness value and updates the feedback objects even when the dimming output is activated scene function.

### 9.10.1 Switching status feedback

The switching status feedback object is updated internally after the following events ...

- Immediately after switching on the dimming output (if necessary, first after a switch-on delay has elapsed and at the beginning of a soft ON dimming procedure / also after a staircase function).
- After switching off the dimming output (if necessary, first after a run-on-time has elapsed and at the end of a soft OFF dimming procedure / also after a staircase function).
- Immediately after switching off by means of the automatic switch-off function.
- At the beginning of a dimming procedure when dimming on (relatively high dimming or brightness value = 1...100 %) the dimming output.
- At the end of a dimming procedure when dimming off (brightness value = 0 %) the dimming output.
- Only when the switching state changes (therefore not for dimming procedures that do not change the switching state e.g. from 10 % to 50 % brightness).
- During updating of the switching state from "ON" to "ON" when the dimming output is already switched on.
- During updating of the switching state from "OFF" to "OFF" when the dimming output is already switched off.
- Always at the start or end of a disabling or forced position function (only if the switching state changes as a result).
- Always after bus voltage return, in the case of mains voltage failure ("OFF") or at the end of any ETS programming process (if necessary also delayed and after calibration of the load).

## Activate switching status feedback

The switching status feedback can be used as an active message object or as a passive status object. As an active message object, the switching status feedback information is also directly transmitted to the KNX whenever the feedback value is updated. As a passive status object, there is no telegram transmission after an update. In this case, the object value must be read out. The ETS automatically sets the object communication flags required for proper functioning.

The parameter "Switching status" can be set on the parameter page "Dimming output 1 -> DO1 - General -> Feedback". Feedback takes place via the "Switching feedback" object.

Precondition:

The feedbacks must be enabled on parameter page "Dimming output 1 -> DO1 - General -> Enabled functions".

- Set the parameter to "Feedback is active signalling object".  
A switching status is transmitted as soon as it is updated. An automatic telegram transmission of the feedback takes place after bus voltage return or after programming with the ETS.
  - Set the parameter to "Feedback is passive status object".  
A switching status will be transmitted in response only if the feedback object is read out from by the KNX. No automatic telegram transmission of the feedback takes place after bus voltage return or after programming with the ETS.
  - Set the parameter to "no reaction".  
The switching status feedback of the affected dimming output is deactivated.
- i** Feedback of the current switching status via the "switching" object is not possible.

## Set update of "Switching feedback"

In the ETS, you can specify when the actuator should update the feedback value for the switching status (object "Switching feedback") in case of an actively transmitting communication object. The object value updated by the actuator is then signalled actively to the KNX.

The parameter "Updating of the object value" can be set on the parameter page "Dimming output 1 -> DO1 - General -> Feedback".

Precondition:

The feedbacks must be enabled on parameter page "Dimming output 1 -> DO1 - General -> Enabled functions". In addition, the switching status feedback must be configured to actively transmitting.

- Set the parameter to "after each update object 'Switching'/'Central'".  
The actuator updates the feedback value in the object once a new telegram is received on the input objects "Switching" or "Central switching" or the switching state changes internally (e.g. through a time function). With an actively transmitting feedback object, a new telegram is also then actively transmitted

to the KNX each time. The telegram value of the feedback does not necessarily have to change in the process. Hence, a corresponding switching status feedback is also generated on the "Switching" object such as in the case of cyclical telegrams for example.

- Set the parameter to "Only if the feedback value changes".

The actuator only updates the feedback value in the object if the telegram value (e.g. "OFF" to "ON") also changes or the switching state changes internally (e.g. through a time function). If the telegram value of the feedback does not change (e.g. in the case of cyclical telegrams to the "Switching" object with the same telegram value), the actuator does not transmit any feedback. Consequently, with an actively transmitting feedback object, no telegram with the same content will be transmitted repeatedly either.

This setting is recommendable, for instance, if the "Switching" and "Switching feedback" objects are linked to an identical group address. This is often the case when activating by means of light scene push-button sensors (recall and storage function).

### **Setting switching status feedback on bus voltage return or after programming with the ETS**

If used as active message object, the switching status feedback information is transmitted to the KNX after bus voltage return or after programming with the ETS. In these cases, the feedback can be time-delayed with the time delay being set globally on the "General - Dimming output" parameter page

- Activate the parameter "Delay after bus voltage return" on the parameter page "Dimming output 1 -> DO1 - General -> Feedbacks".

The switching status telegram will be transmitted with a delay after bus voltage return or after programming with the ETS. No feedback telegram is transmitted during a running delay, even if the switching state changes during this delay.

- Deactivate the parameter.

The switching status telegram is transmitted immediately after bus voltage return or after an ETS programming operation.

### **Setting cyclical transmission of the switching status feedback telegram**

The switching status feedback telegrams can, if active, also be transmitted cyclically, in addition to the transmission after updating.

- Activate the parameter "Cyclical sending" on the parameter page "Dimming output 1 -> DO1 - General -> Feedbacks".

Cyclical transmission is activated. The cycle time for the switching status feedback can be configured for the parameter "Time for cyclical transmission".

- Deactivate the parameter.

Cyclical transmission is deactivated so that the feedback is transmitted to the KNX only when updated by the actuator.

## 9.10.2 Brightness value feedback

The brightness value feedback object is updated internally after the following events ...

- At the end of a relative (4-bit) or absolute (1-byte) dimming procedure.
- After switching on the dimming output, if the switch-on brightness is set (if necessary, first after a switch-on delay has elapsed and at the end of a soft ON dimming procedure / also after a staircase function).
- After switching off the dimming output (if necessary, first after a run-on-time has elapsed and at the end of a soft OFF dimming procedure / also after a staircase function).
- Immediately after switching off by means of the automatic switch-off function.
- Only if the brightness value changes (if a brightness value specification under-shoots the minimum brightness as a result of relative or absolute dimming from outside or exceeds the maximum brightness, the actuator does not update a brightness value feedback according to the minimum brightness or maximum brightness).
- Always at the start or end of a disabling or forced position function (only if the brightness value changes as a result).
- Always after bus voltage return, in the case of mains voltage failure ("0") or at the end of any ETS programming process (if necessary, also delayed and after calibration of the load)

**i** In the case of enabling function as supplementary function: A 'flashing' dimming output is always signalled back as "switched on" and with switch-on brightness.

### Activate brightness value feedback

The brightness value feedback can be used as an active message object or as a passive status object. As an active signalling object, the brightness value feedback is also directly transmitted to the KNX for each update of the feedback value. As a passive status object, there is no telegram transmission after an update. In this case, the object value must be read out. The ETS automatically sets the object communication flags required for proper functioning.

The parameter "Brightness value" can be set on the parameter page "Dimming output 1 -> DO1 - General -> Feedback". Feedback takes place via the "Brightness value feedback" object.

Precondition:

The feedbacks must be enabled on parameter page "Dimming output 1 -> DO1 - General -> Enabled functions".

- Set the parameter to "Feedback is active signalling object".  
A brightness value is transmitted once this is updated. An automatic telegram transmission of the feedback takes place after bus voltage return or after programming with the ETS.
- Set the parameter to "Feedback is passive status object".

A brightness value is transmitted in response only if the feedback object is read out by the KNX. No automatic telegram transmission of the feedback takes place after bus voltage return or after programming with the ETS.

- Set the parameter to "no reaction".

The brightness value feedback of the affected dimming output is deactivated.

### Setting the update of the "Brightness value feedback"

In the ETS you can specify when the actuator should update the feedback value for the brightness value ("Brightness value feedback" object) in case of an actively transmitting communication object. The object value updated by the actuator is then signalled actively to the KNX.

The parameter "Updating of the object value" can be set on the parameter page "Dimming output 1 -> DO1 - General -> Feedback".

Precondition:

The feedbacks must be enabled on parameter page "Dimming output 1 -> DO1 - General -> Enabled functions". In addition, the brightness value feedback must be configured to actively transmitting.

- Set the parameter to "after each update 'Brightness value'/'Central brightness value' object".

The actuator updates the feedback value in the object once a new telegram is received on the input objects "Brightness value" or "Central brightness value" or the brightness value changes internally (e.g. through a time function). With an actively transmitting feedback object, a new telegram is also then actively transmitted to the KNX each time. The telegram value of the feedback does not necessarily have to change in the process. Hence, a corresponding brightness value feedback is also generated on the "brightness value feedback" object such as in the case of cyclical telegrams for example.

- Set the parameter to "Only if the feedback value changes".

The actuator only updates the feedback value in the object if the telegram value (e.g. "1 %" to "2 %") also changes or the brightness value changes internally (e.g. through a time function). If the telegram value of the feedback does not change (e.g. in the case of cyclical telegrams to the "Brightness value" object with the same telegram value), the actuator does not transmit any feedback. Consequently, with an actively transmitting feedback object, no telegram with the same content will be transmitted repeatedly either.

This setting is recommendable, for instance, if the "brightness value" and "brightness value feedback" objects are linked to an identical group address. This is often the case when activating by means of light scene push-button sensors (recall and storage function).



### Setting feedback for bus voltage return or ETS programming

If used as active signalling object, the brightness value feedback states are transmitted to the KNX after bus voltage return or after ETS programming. In these cases, the feedback can be time-delayed with the time delay being set globally on the "General - Dimming output" parameter page

- Activate the parameter "Delay after bus voltage return" on the parameter page "General dimming output".

The brightness value feedback is transmitted with a delay after bus voltage return or after an ETS programming operation. No feedback telegram is transmitted during a running delay, even if the brightness value changes during this delay.

- Deactivate the parameter.

The brightness value feedback is transmitted immediately after bus voltage return or after an ETS programming operation.

### Setting cyclical transmission of the brightness value feedback

The brightness value feedback telegrams can, if active, also be transmitted cyclically, in addition to transmission after updating.

- Activate the parameter "Cyclical sending" on the parameter page "Dimming output 1 -> DO1 - General -> Feedbacks".

Cyclical transmission is activated. The cycle time for the brightness value feedback can be configured separately for the parameter "Time for cyclical transmission".

- Deactivate the parameter.

Cyclical transmission is deactivated so that the feedback is transmitted to the KNX only when updated by the actuator.

## 9.10.3 Short-circuit feedback

The short-circuit status feedback object is updated after the following events ...

- As soon as a short-circuit has been detected (after 7 seconds for trailing edge phase control, after 100 milliseconds for leading edge phase control), the message "Short circuit - 1" is displayed.
- This is always done on bus voltage return, in case of mains voltage failure on the load or at the end of an ETS programming operation (if necessary also delayed and after calibration of the load).

**i** Here, it is described how a short-circuit message is enabled and how the telegram transmission of this message behaves. The chapter "Troubleshooting" (siehe Kapitel "Troubleshooting" ▶ Page 15) describes in detail how to eliminate a fault.

### Activating short-circuit feedback

The short-circuit feedback is an active signalling object. The short-circuit feedback is also directly transmitted to the KNX whenever the feedback value is updated. The parameter "Short-circuit" can be set on the parameter page "Dimming output 1 -> DO1 - General -> Feedback". Feedback takes place via the "Short-circuit feedback" object.

Precondition:

The feedbacks must be enabled on parameter page "Dimming output 1 -> DO1 - General -> Enabled functions".

- Enable the parameter "Short-circuit".

The short-circuit feedback is transmitted once this is updated. An automatic telegram transmission of the feedback takes place after bus voltage return or after programming with the ETS.

### Setting short-circuit feedback for bus voltage return or ETS programming

The short-circuit feedback states are transmitted to the KNX after bus voltage return or after an ETS programming operation. The feedback can be time-delayed with the time delay being set globally on the "General - Dimming output" parameter page

- Activate the parameter "Delay after bus voltage return" on the parameter page "Dimming output 1 -> DO1 - General -> Feedbacks".

The short-circuit feedback is transmitted with a delay after bus voltage return or after an ETS programming operation. No feedback is transmitted during a delay, even if the state changes during this delay.

- Deactivate the parameter.

The short-circuit feedback is transmitted immediately after bus voltage return or after an ETS programming operation.

## 9.10.4 Overload/mains voltage failure feedback

The overload/mains voltage failure feedback object is updated after the following events ...

- As soon as a failure of the mains voltage supply of the load output has been detected, the message "Overload/mains voltage failure present - 1" is displayed.
- As soon as a return of the mains voltage supply of the load output has been detected, the message "No overload/no mains voltage failure present - 0" is displayed.
- As soon as the overtemperature protection switches off the output due to an overload, the message "Overload/mains voltage failure present - 1" is displayed.
- As soon as the overtemperature protection has been reset automatically or manually after sufficient cooling, the message "No overload/no mains voltage failure present - 0" is displayed.

- i** Here, it is described how an overload/mains voltage failure message is enabled and how the telegram transmission of this message behaves. The chapter "Troubleshooting" (siehe Kapitel "Troubleshooting" ▶ Page 15) describes in detail how to eliminate a fault.

### Activating overload/mains voltage failure feedback

The overload/mains voltage failure feedback is an active signalling object. The overload/mains voltage failure feedback is also directly transmitted to the KNX whenever the feedback value is updated. The parameter "Overload / mains voltage failure" can be set on the parameter page "Dimming output 1 -> DO1 - General -> Feedback". Feedback takes place via the "Overload/mains voltage failure feedback" object.

Precondition:

The feedbacks must be enabled on parameter page "Dimming output 1 -> DO1 - General -> Enabled functions".

- Enable the parameter "Overload/mains voltage failure".

The overload/mains voltage failure feedback is transmitted once this is updated. An automatic telegram transmission of the feedback takes place after bus voltage return or after programming with the ETS.

### Setting overload/mains voltage failure feedback for bus voltage return or ETS programming

The overload/mains voltage failure feedback states are transmitted to the KNX after bus voltage return or after an ETS programming operation. The feedback can be time-delayed with the time delay being set globally on the "General - Dimming output" parameter page

- Activate the parameter "Delay after bus voltage return" on the parameter page "Dimming output 1 -> DO1 - General -> Feedbacks".

The overload/mains voltage failure feedback states are transmitted with a delay after bus voltage return or after an ETS programming operation. No feedback is transmitted during a delay, even if the state changes during this delay.

- Deactivate the parameter.

The overload/mains voltage failure feedback is transmitted immediately after bus voltage return or after an ETS programming operation.

## 9.10.5 Load type feedback

The actuator has the option of reporting the current load type. The data format of the load type feedback can be configured in the ETS (KNX-compliant or extended).

The load type feedback objects are updated after the following events ...

- always on bus voltage return,
- on mains voltage return on the load,

- at the end of an ETS programming operation.

### **Activate load type feedback**

The load type feedback is an active signalling object. The load type feedback is also directly transmitted to the KNX whenever the feedback value is updated. The parameter "Feedback load type" can be set on the parameter page "Dimming output 1 -> DO1 - General -> Feedback". Feedback takes place via one of the "Load type feedback" objects.

Precondition:

The feedbacks must be enabled on parameter page "Dimming output 1 -> DO1 - General -> Enabled functions".

- Enable the parameter "Load type".
- Set the "Type of feedback" parameter.

The load type feedback is transmitted once this is updated. An automatic telegram transmission of the feedback takes place after mains voltage return to a load output, bus voltage return or after an ETS programming operation.

### 9.10.6 Feedback telegrams parameter

Dimming output 1 -> DO1 - General -> Enabled functions

Feedback	Checkbox (yes / no)
This parameter can be used to disable or to enable the feedback functions.	

Dimming output 1 -> DO1 - General -> Feedbacks

switching status	no feedback <b>feedback is active signalling object</b> feedback is passive status object
------------------	---

The current switching state of the dimming output can be reported separately back to the KNX.

no feedback: The switching status feedback of the affected dimming output is deactivated.

Feedback is active signalling object: A switching status is transmitted as soon as it is updated. An automatic telegram transmission of the feedback takes place after bus voltage return or after programming with the ETS.

Feedback is passive status object: A switching status will be transmitted in response only if the feedback object is read out by the KNX. No automatic telegram transmission of the feedback takes place after bus voltage return or after programming with the ETS.

Updating of the object value	after each update object "Switching"/"Central" <b>only if the feedback value changes</b>
------------------------------	---

Here, you can specify when the actuator should update the feedback value for the switching status (object "Switching feedback") in case of an actively transmitting communication object. The object value updated by the actuator is then signalled actively to the KNX.

This parameter is only visible in case of an actively transmitting feedback.

after each update object "Switching"/"Central": The actuator updates the feedback value in the object once a new telegram is received on the input objects "Switching" or "Central switching" or the switching state changes internally (e.g. through a time function). With an actively transmitting feedback object, a new telegram is also then actively transmitted to the KNX each time. The telegram value of the feedback does not necessarily have to change in the process. Hence, a corresponding switching status feedback is also generated on the "Switching" object such as in the case of cyclical telegrams for example.

only if the feedback value changes: The actuator only updates the feedback value in the object if the telegram value (e.g. "OFF" to "ON") also changes or the switching state changes internally (e.g. through a time function). If the telegram value of the feedback does not change (e.g. in the case of cyclical telegrams to the "Switching" object with the same telegram value), the actuator does not transmit any feedback. Consequently, with an actively transmitting feedback object, no telegram with the same content will be transmitted repeatedly either.

Delay after bus voltage return	Checkbox (yes / no)
<p>The states of the switching status feedback can be transmitted to the KNX with a delay after bus voltage return or after an ETS programming operation. The activated parameter causes a delay on bus voltage return. The delay time is configured on the parameter page "General".</p> <p>This parameter is only visible in case of an actively transmitting feedback.</p>	
Cyclical transmission	Checkbox (yes / no)
<p>The switching status feedback telegrams can, if actively transmitting, also be transmitted cyclically, in addition to the transmission after updating.</p> <p>This parameter is only visible in case of an actively transmitting feedback.</p> <p>Parameter activated: Cyclical transmission is activated.</p> <p>Parameter deactivated: Cyclical transmission is deactivated so that the feedback is transmitted to the KNX only when updated by the actuator.</p>	
brightness value	no feedback <b>feedback is active signalling object</b> feedback is passive status object
<p>The current brightness value of the dimming output can be reported back separately to the KNX.</p> <p>no feedback: The brightness value feedback of the affected dimming output is deactivated.</p> <p>Feedback is active signalling object: The brightness value is transmitted as soon as it is updated. An automatic telegram transmission of the feedback takes place after bus voltage return or after programming with the ETS.</p> <p>Feedback is passive status object: The brightness value will be transmitted in response only if the feedback object is read out by the KNX. No automatic telegram transmission of the feedback takes place after bus voltage return or after programming with the ETS.</p>	

Updating of the object value	after each update "Brightness value"/"Central brightness value" object <b>only if the feedback value changes</b>
<p>Here, you can specify when the actuator should update the feedback value for the switching status (object "Brightness value feedback") in case of an actively transmitting communication object. The object value updated by the actuator is then signalled actively to the KNX.</p> <p>This parameter is only visible in case of an actively transmitting feedback.</p> <p>after each update "Brightness value"/"Central brightness value" object: The actuator updates the feedback value in the object once a new telegram is received on the "Brightness value" or "Central brightness value" input objects or once the value changes internally (e.g. due to a dimming function). With an actively transmitting feedback object, a new telegram is also then actively transmitted to the KNX each time. The telegram value of the feedback does not necessarily have to change in the process. Hence, a corresponding brightness value feedback is also generated on the "brightness value" object such as in the case of cyclical telegrams for example.</p> <p>only if the feedback value changes: The actuator only updates the feedback value in the object if the brightness value also changes or the switching state changes internally (e.g. through a time function). If the telegram value of the feedback does not change (e.g. in the case of cyclical telegrams to the "Brightness value" object with the same telegram value), the actuator does not transmit any feedback. Consequently, with an actively transmitting feedback object, no telegram with the same content will be transmitted repeatedly either.</p>	
Delay after bus voltage return	Checkbox (yes / no)
<p>The states of the brightness value feedback can be transmitted to the KNX with a delay after bus voltage return or after an ETS programming operation. The activated parameter causes a delay on bus voltage return. The delay time is configured on the parameter page "General".</p> <p>This parameter is only visible in case of an actively transmitting feedback.</p>	
Cyclical transmission	Checkbox (yes / no)
<p>The brightness value feedback telegrams can, if active, also be transmitted cyclically, in addition to transmission after updating.</p> <p>This parameter is only visible in case of an actively transmitting feedback.</p> <p>Parameter activated: Cyclical transmission is activated.</p> <p>Parameter deactivated: Cyclical transmission is deactivated so that the feedback is transmitted to the KNX only when updated by the actuator.</p>	
Time for cyclical transmission	0...23 h 0 ... 2 ... 59 min 0 ... 59 s
<p>These parameters define the time for cyclic transmission of switching status feedback and brightness value feedback.</p> <p>Setting the cycle time. These parameters are only available if cyclic transmission is activated for the switching status or brightness value.</p>	

Short-circuit	Checkbox (yes / no)
This parameter enables the short-circuit feedback object.	
Delay after bus voltage return	Checkbox (yes / no)
The states of the short-circuit feedback can be transmitted to the KNX with a delay after bus voltage return or after an ETS programming operation. The activated parameter causes a delay on bus voltage return. The delay time is configured on the parameter page "General".	
Overload / mains voltage failure	Checkbox (yes / no)
This parameter enables the overload/mains voltage failure feedback object.	
Delay after bus voltage return	Checkbox (yes / no)
The states of the overload/mains voltage failure feedback can be transmitted to the KNX with a delay after bus voltage return or after an ETS programming operation. The activated parameter causes a delay on bus voltage return. The delay time is configured on the parameter page "General".	
Load type	Checkbox (yes / no)
For each dimming output, the actuator has the option of reporting the current load type. This parameter enables the load type feedback.	
Type of feedback	<b>standard (KNX compliant)</b> extended
<p>The data format of the load type feedback is specified here.</p> <p>Standard (KNX-compliant): The load type feedback takes place in the standardised data format according to DPT 20.610.</p> <p>Extended: The feedback of the load type is bit-oriented: "0" = undefined (no calibration possible because of missing mains voltage / short circuit) / "1" = trailing edge phase control (set by parameter) / "2" = leading edge phase control (set by parameter) / "3" = universal, calibrated to capacitive or resistive load / "4" = universal, calibrated to inductive load / "5" ... "255" not used</p>	



### 9.10.7 Feedback objects

Object no.	Function	Name	Type	DPT	Flag
32	Switching feedback	Dimming 1 (...) - Output	1-bit	1,001	C, R, -, T, A
1-bit object for feedback signalling of the switching state ("1" = on / "0" = off) to the bus.					
Object no.	Function	Name	Type	DPT	Flag
36	Feedback brightness value	Dimming 1 (...) - Output	1 bytes	5,001	C, R, -, T, A
1-byte object for feedback signalling of an absolute dimming value (brightness value 0...255) to the bus.					
Object no.	Function	Name	Type	DPT	Flag
191	Feedback load type (KNX compliant)	Dimming 1 (...) - Output	1 bytes	20,610	C, R, -, T, A
1-byte object for signalling the current load type to the bus. "0" = undefined "1" = leading edge phase control "2" = trailing edge phase control "3" ... "255" not used The object is only available if the parameter "Type of feedback" is set to "Standard (KNX-compliant)".					
Object no.	Function	Name	Type	DPT	Flag
192	Feedback load type (extended)	Dimming 1 (...) - Output	1 bytes		C, R, -, T, A
1-byte object for signalling the current load type to the bus. "0" = undefined (no calibration possible because mains voltage absent / short-circuit) "1" = trailing edge phase control (set by parameter) "2" = leading edge phase control (set by parameter) "3" = universal, adjusted to capacitive or ohmic load "4" = universal, adjusted to inductive load "5" ... "255" not used The object is only available if the parameter "Type of feedback" is set to "Extended".					
Object no.	Function	Name	Type	DPT	Flag
193	Feedback short-circuit	Dimming 1 (...) - Output	1-bit	1,005	C, R, -, T, A
1-bit object for signalling a short-circuit in relation to the dimming output ("1" = short-circuit present/"0" = short-circuit not present).					

Object no.	Function	Name	Type	DPT	Flag
194	Feedback overload / mains voltage failure	Dimming 1 (...) - Output	1-bit	1,005	C, R, -, T, A
<p>1-bit object for signalling an overload or mains voltage failure in relation to the dimming output ("1" = overload/mains voltage failure present/"0" = overload/mains voltage failure not present)</p>					

## 9.11 Time delays

Up to two time functions can be preset for the dimming output, independently of each other. The time functions affect the communication objects "Switching" or "Central switching" only (if at least one of the central functions is activated for the output concerned) and delay the object value received depending on the telegram polarity.

- i** At the end of a disabling function or forced position function, the switching state received during the function or set before the function can be tracked. Residual times of time functions are also tracked if these had not yet fully elapsed at the time of the reactivation or forced control.
- i** The time delays do not influence the staircase function if this is enabled.
- i** A time delay still in progress will be fully aborted by a reset of the actuator (bus voltage failure or ETS programming).

### Activating switch-on delay

The switch-on delay can be activated in the ETS for the dimming output.

Precondition:

The time delays must be enabled on parameter page "Dimming output 1 -> DO1 - General -> Enabled functions".

- Set the parameter "Selection of time delay" to "Switch-on delay" or to "Switch-on delay and switch-off delay". Configure the desired switch-on delay.  
The switch-on delay is enabled. After reception of an ON telegram via the "switching" or "central switching" object, the configurable time is started. Another ON-telegram triggers the time only when the parameter "Switch-on delay retriggerable" is activated. An OFF-telegram received during the ON-delay will end the delay and sets the switching status to "OFF".

### Activating switch-off delay

The switch-off delay can be activated in the ETS for the dimming output.

Precondition:

The time delays must be enabled on parameter page "Dimming output 1 -> DO1 - General -> Enabled functions".

- Set the parameter "Selection of time delay" to "Switch-off delay" or to "Switch-on delay and switch-off delay". Configure the desired switch-off delay.  
The switch-off delay is enabled. After reception of an OFF telegram via the "switching" or "central switching" object, the configurable time is started. Another OFF-telegram triggers the time only when the parameter "switch-off delay retriggerable" is activated. An ON-telegram received during the OFF-delay will end the delay and sets the switching status to "ON".

### 9.11.1 Time delays parameters

Dimming output 1 -> DO1 - General -> Enabled functions

Time delays	Checkbox (yes / no)
This parameter can be used to disable or to enable the time delays. The parameter is deactivated if cyclical monitoring is enabled.	

Dimming output 1 -> DO1 - General -> Time delays

Selection of time delay	<b>no time delay</b>  Switch-on delay Switch-off delay ON delay and OFF delay
The communication objects "Switching" or "Central switching" can be evaluated after a time delay. By this setting the desired function of the time delay is selected and the additional parameters of the delay enabled.	

Switch-on delay	0...59 min 0...10...59
This parameter is used for setting the duration of the switch-on delay.	

Switch-on delay retriggerable	Checkbox (yes / no)
A switch-on delay still in progress can be retriggered by another "ON" telegram (parameter activated). Alternatively, the retriggering time (parameter deactivated) can be suppressed. The parameters for the switch-on delay are only visible if switch-on delay or switch-on and switch-off delay are activated.	

Switch-off delay	0...59 min 0...10...59
This parameter is used for setting the duration of the switch-off delay.	

Switch-off delay retriggerable	Checkbox (yes / no)
A switch-off delay still in progress can be retriggered (parameter activated) by another "OFF" telegram. Alternatively, the retriggering time (parameter deactivated) can be suppressed. The parameters for the switch-off delay are only visible if switch-on delay or switch-on and switch-off delay are activated.	

## 9.12 Switch-on/switch-off behaviour

### 9.12.1 Soft ON/OFF function

The soft-functions permit the dimming output to be switched on or off at reduced speed when a switching command is received via the "Switching" or "Central switching" communication objects.

If the soft ON function is activated, a dimming procedure is executed until the switch-on brightness when switching on. This also occurs if the dimming output is already switched on to a brightness value smaller than switch-on brightness. Likewise, with the soft OFF function, a dimming procedure is executed to 0 % brightness after receipt of an OFF telegram (see figure 15).

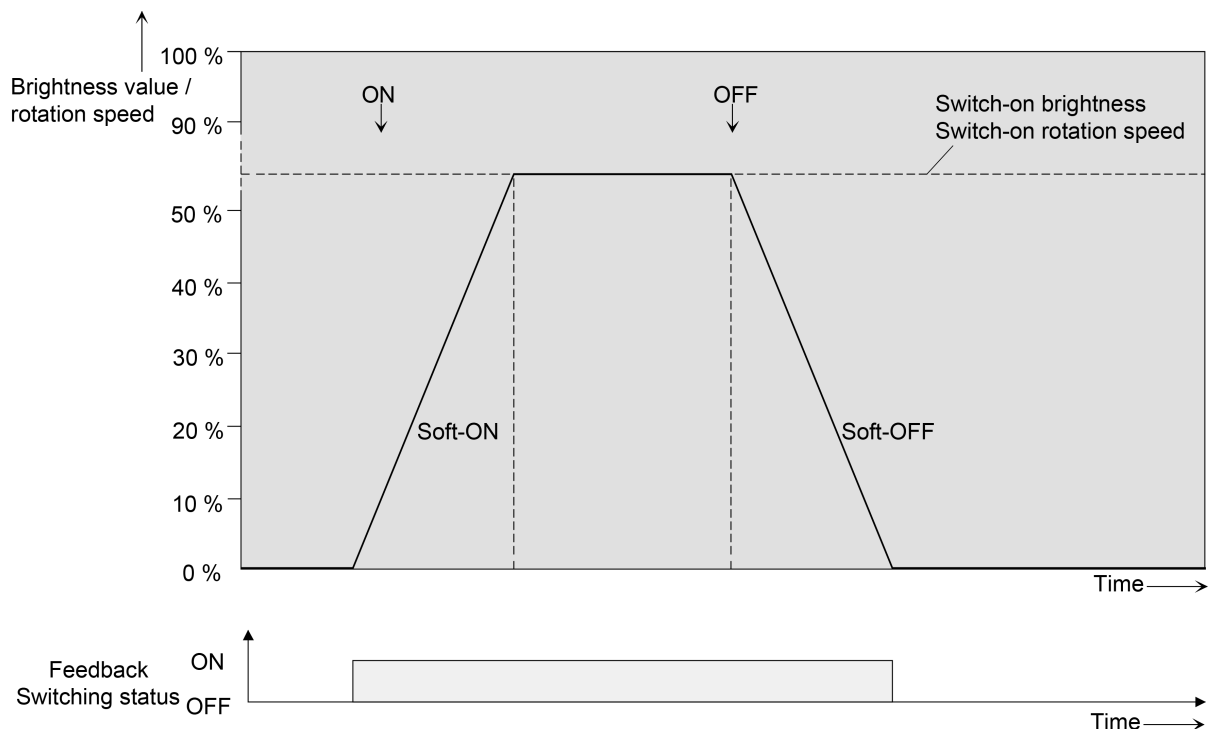

Image 15: Dimming behaviour of the soft ON/OFF functions (as an example)

The dimming speeds can be configured separately in the ETS for the soft ON and soft OFF function. The relative dimming increment time between 2 of 255 dimming increments is configured directly.

The soft ON or soft OFF functions are not retriggerable by the receipt of further switching telegrams while maintaining the switching status. The soft functions can be activated and configured separately in the ETS.

The soft functions also have effects on the switching edges of the staircase function.

- i** A dimming output disabled via the bus can also flash for the disabling function depending on the ETS configuration. Dimming is not executed with the soft functions during ON and OFF flashing.

#### Enabling and setting soft ON function

The soft ON function can be set for the dimming output in the ETS.

The switch-on/switch-off behaviour must be enabled on parameter page "Dimming output 1 -> DO1 - General -> Enabled functions".

- Set the parameter "Soft ON function ?" on parameter page "Dimming output 1 -> DO1 - General -> Enabled functions".

The soft ON function is enabled. The parameter for the time between 2 dimming increments of the soft ON function becomes visible.

- Configure the parameter "Time for dimming increment soft ON" to the required dimming increment time.

### **Enabling and setting soft OFF function**

The soft ON function can be set for the dimming output in the ETS.

The switch-on/switch-off behaviour must be enabled on parameter page "Dimming output 1 -> DO1 - General -> Enabled functions".

- Enable the parameter "Soft OFF function" on parameter page "Dimming output 1 -> DO1 - General -> Switch-on/switch-off behaviour".

The soft OFF function is enabled. The parameter for the time between 2 dimming increments of the soft OFF function becomes visible.

- Configure the parameter "Time for dimming increment soft OFF" to the required dimming increment time.

## **9.12.2 Automatic switch-off**

The switch-off function permits automatic switching of the dimming output after a brightness value was dimmed or jumped to and this new brightness value is below a switch-off brightness set in the ETS. A time delay can be configured optionally up to switching off.

The switch-off function is activated after reaching a constant brightness value, i.e. after a completed dimming procedure.

The automatic switch-off function, for example, not only makes it possible to set the lighting to basic brightness but to switch off as well by means of relative dimming. A further application, for example, is time-controlled "Good night switch-off" of a dimmed children's room lighting.

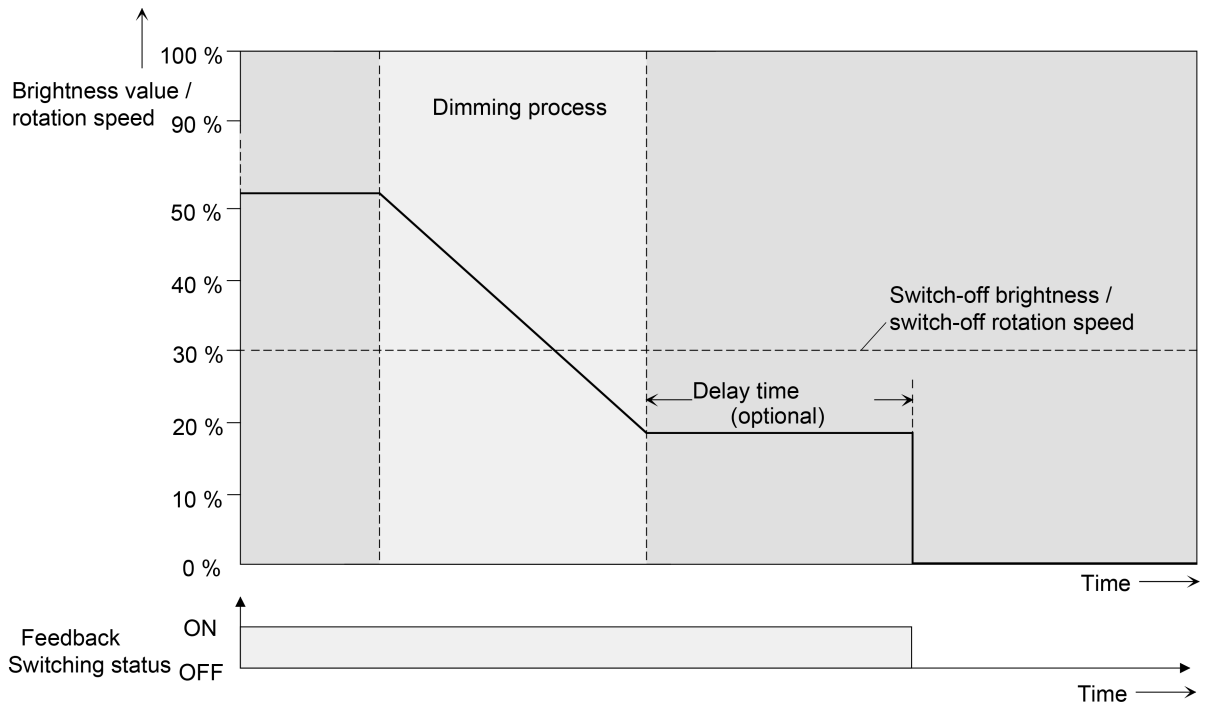

Image 16: Dimming and switching behaviour of the automatic switch-off function

- i** Switching off always takes place without soft OFF function, i.e. jumping.
- i** The switch-off brightness in the dimmable brightness range can be set between basic and maximum brightness or minimum and maximum brightness. The switch-off function is always active if the switch-off brightness is configured to maximum brightness and the maximum brightness is randomly undershot.
- i** The feedback objects for switching state and brightness value are updated by the automatic switch-off function after switching off.

The automatic switch-off can firstly be activated by a dimming procedure initiated via the 4-bit ("dimming") or 1-byte ("brightness value") communication object. Secondly, the automatic switch-off can also be activated if the dimming output is switched on (switch-on brightness < switch-off brightness) or a brightness is set by programming with the ETS or by a bus voltage failure or by bus / mains voltage return. The automatic switch-on can also be activated during a scene recall.

It should be noted that the disabling function or forced position function overrides the switch-off function. If the switch-off function is overridden, the actuator terminates the evaluation of the switch-off brightness.

### Enabling automatic switch-off function

The automatic switch-off function can be set for the dimming output in the ETS.

The switch-on/switch-off behaviour must be enabled on parameter page "Dimming output 1 -> DO1 - General -> Enabled functions".

- Enable the parameter "Automatic switch-off" on parameter page "Dimming output 1 -> DO1 - General -> Switch-on/switch-off behaviour".

The automatic switch-off function is enabled and activated. Additional parameters become visible.

### Setting the switch-off brightness

The switch-off brightness must be defined for the switch-off function. The switch-off brightness is set for the dimming output in the ETS.

The switch-off function must be enabled in the ETS.

- Set the parameter "Switch off if brightness value is smaller than" on parameter page "Dimming output 1 -> DO1 - General -> Switch-on/switch-off behaviour" to the required brightness value.

Once a dimming procedure causes a value to fall below the parameterized switch-off brightness and once the brightness has been set to constant, the dimming output switches off or alternatively starts the delay until switching off.

- i** It should be noted that the configured value for the switch-off brightness is greater than any configured minimum brightness and less than the set maximum brightness (minimum brightness < switch-off brightness < maximum brightness)!
- i** Using the staircase function with pre-warning/continuous lighting: The reduced brightness of the pre-warning or continuous lighting does not start the switch-off function after reaching or undershooting the switch-off brightness!

### Setting the delay of the switch-off function

A delay can be activated before the switch-off function switches-off automatically after undershooting the switch-off brightness at the end of a dimming procedure.

The switch-off function must be enabled in the ETS.

- Configure the parameter "Delay time" on the parameter page "Dimming output 1 -> DO1 - General -> Switch-on-/Switch-off behaviour" to the required delay time.

Once a dimming procedure causes a value to fall below the parameterized switch-off brightness and once the brightness has been set to constant, the actuator triggers the delay time. The dimming channel concerned switches off for good once the delay time has elapsed. The delay time can be re-triggered by further dimming procedures.



### 9.12.3 Switch-on/switch-off behaviour parameter

Dimming output 1 -> DO1 - General -> Enabled functions

Switch-on/switch-off behaviour	Checkbox (yes / no)
Setting the switch-on/switch-off behaviour can be disabled and enabled here.	

Dimming output 1 -> DO1 - General -> Switch-on/switch-off behaviour

Soft ON function	Checkbox (yes / no)
The soft ON function permits slower switch-on of the dimming output. If this function is activated, a dimming operation to the switch-on brightness is executed after receiving a switch-on telegram via the "Switching" or "Central switching" object.	

Time between two dimming increments	0...59 s 10... 990 ms
These parameters set the soft ON function for the dimming increment time.	

Soft OFF function	Checkbox (yes / no)
The soft OFF function permits slower switch-off of the dimming output. If this function is activated, a dimming operation to the brightness "0%" is executed after receiving a switch-off telegram via the "Switching" or "Central switching" object.	

Time between two dimming increments	0...59 s 10... 990 ms
These parameters set the soft OFF function for the dimming increment time.	

Automatic switch-off	Checkbox (yes / no)
The automatic switch-off function of the dimming output can be activated here. If this function is activated, the connect load will switch off completely when a configurable brightness is undershot at the end of a dimming procedure, and if necessary, after a delay time has elapsed.	

Switch-off if brightness value smaller than	5%, 10% ... 100%
This parameter defines the brightness, which, if undershot, will cause the dimming output to be switched off at the end of a dimming procedure, or if necessary, after a delay time has elapsed. This parameter is only visible if the switch-off function is activated.	

Delay until switch-off	Checkbox (yes / no)
Here you can activate a delay for the automatic switch-off function of the dimming output. If activated, the delay time can be set.	

Delay time	<p>0... 23 h</p> <p>0...59 min</p> <p>0...<b>30</b>...59</p>
<p>This parameter sets the delay time of the switch-off function. If the switch-off brightness is undershot at the end of a dimming procedure, the dimming output is switched off after the time set here has elapsed.</p> <p>The parameters for the time delay are visible only if the switch-off function is enabled.</p>	

## 9.13 Scene function

Up to 64 scenes can be programmed and scene values stored for the dimming output. The scene values are recalled or stored via a separate scene extension object. The data point type of the extension object permits addressing of all 64 scenes.

The scene function must be enabled on parameter page "Dimming output 1 -> DO1 - General -> Enabling functions" in order for the required communication objects and parameters (on the parameter page "Dimming output 1 -> DO1 - General -> Scenes") to be visible.

The scene configuration selected in the parameterization decides whether the number of scenes is either variable (1 ... 64) or alternatively fixed to the maximum (64).

- Scene configuration = "variable (1 ... 64 scenes)"  
With this setting, the number of scenes used can be selected anywhere in the range 1 to 64. The parameter "Number of scenes" decides how many scenes are visible for the output in the ETS and can therefore be used. It is possible to specify which scene number (1 ... 64) controls each scene.
- Scene configuration = "fixed (64 scenes)"  
With this setting, all scenes are always visible and can therefore be used. The scenes are controlled via permanently assigned scene numbers (1 ... 64) (scene number 1 -> scene 1, scene number 2 -> scene 2 ...). If necessary, individual scenes can be deactivated.

The scene function can be combined together with other functions of the dimming output, whereby the last received or preset state is always executed: Telegrams to the "Switching", "Dimming" or "Brightness value" objects, a scene recall or scene storage telegram at the time of an active staircase function aborts the staircase time prematurely and presets the brightness state according to the received object value (delays are also taken into account) or scene value. Similarly, the state of the dimming output, which was preset by the "Switching", "Dimming" or "Brightness value" objects or by a scene recall, can be overridden by a staircase function.

### Presetting a scene recall delay

Each scene recall of a dimming output can optionally also be delayed. With this feature, dynamic scene sequences can be configured if several scene outputs are combined with cyclical scene telegrams.

#### Precondition

The scene function must be enabled on parameter page "Dimming output 1 -> DO1 - General -> Enabled functions".

- Activate the parameter "Delay scene recall" on parameter page "Dimming output 1 -> DO1 - General -> Scenes".

The delay time is now activated and can be configured separately. The delay only influences the scene recall of the dimming output. The delay time is started on arrival of a recall telegram. The corresponding scene will be recalled and the brightness value set on the dimmer output only after this time has elapsed.

- i** Each scene recall telegram restarts the delay time and retriggers it. If a new scene recall telegram is received while a delay is active (scene recall not yet executed), the old (and not yet recalled scene) will be rejected and only the scene last received executed.
- i** The scene recall delay has no influence on the storage of scene values. A scene storage telegram within a scene recall delay terminates the delay and thus the scene recall.

### Presetting the behaviour during ETS programming

During storage of a scene, the brightness values are permanently stored internally in the device. To prevent the stored values from being replaced during ETS programming of the application or of the parameters by the originally programmed scene brightness values, the actuator can inhibit overwriting of brightness values. As an alternative, the original values can be reloaded into the device during each programming run of the ETS.

#### Precondition

The scene function must be enabled on parameter page "Dimming output 1 -> DO1 - General -> Enabled functions".

- Activate the parameter "Overwrite values stored in the device during the ETS programming operation" on parameter page "Dimming output 1 -> DO1 - General -> Scenes".

During each ETS programming of the application or of the parameters, the scene brightness values parameterized in the ETS for the dimming output will be programmed into the actuator. Any scene brightness values stored in the device by means of a storage function will be overwritten.

- Deactivate the parameter "Overwrite values stored in the device during the ETS programming operation".

Scene brightness values stored in the device by means of a storage function will be maintained. If no scene brightness values have been stored, the brightness values last programmed in the ETS remain valid.

- i** When the actuator is commissioned for the first time, this parameter should be activated so that the brightness values are initialised to valid scene brightness values.

### Setting scene numbers and scene switching states

The presetting of the scene number depends on the selected scene configuration. With variable configuration the scene number (1...64) with which the scene is addressed, i.e. recalled or stored, must be determined for each scene of the output. With a fixed scene configuration, the number of a scene is preset invariably. The data point type of the scene extension object permits addressing of up to 64 scenes max.

In addition to specifying the scene number, it is necessary to define which brightness value should be set on the dimming output during a scene recall.

**Precondition**

The scene function must be enabled on parameter page "Dimming output 1 -> DO1 - General -> Enabled functions".

- Only with variable scene configuration. On the parameter page "Dimming output 1 -> DO1 - General -> Scenes" set the parameter "Scene number" for each scene to the numbers with which the scenes are to be addressed.

A scene can be addressed with the configured scene number. A setting of "0" deactivates the corresponding scene so that neither recalling nor storage is possible.

- Only with fixed scene configuration. On the parameter page "Dimming output 1 -> DO1 - General -> -> Scenes" select or deselect the parameter "Scene active" if necessary.

Only selected scenes can be used. A deselected scene is deactivated and cannot be recalled or stored via the scene extension.

**i** If with variable scene configuration the same scene number is configured for several scenes, only the scene with the lowest sequential number will be addressed. The other scenes will be ignored in this case.

- Set the parameter "Brightness value" on parameter page "Dimming output 1 -> DO1 - General -> Scenes" for each scene to the desired brightness value.

During a scene recall, the parameterized brightness value is recalled and set on the dimming output.

**i** The parameterized brightness value is adopted in the actuator during programming with the ETS only if the parameter "Overwrite values stored in the device during ETS download" is activated.

**Presetting storage behaviour**

The brightness value set for the dimming output can be stored internally via the extension object on receipt of a scene storage telegram. In this case, the brightness value can be influenced before the storage by all functions of the dimming output, provided that the individual functions have been enabled (e.g. also the disabling function, forced position function etc.).

**Precondition**

The scene function must be enabled on parameter page "Dimming output 1 -> DO1 - General -> Enabled functions".

- Activate the parameter "Storage function" on parameter page "Dimming output 1 -> DO1 - General -> Scenes" for each scene.

The storage function is activated for the scene in question. On reception of a storage telegram via the "Scene extension" object, the current brightness value will be internally stored.

- Deactivate the parameter "storage function" for each scene.

The storage function is deactivated for the scene in question. A storage telegram received via the "scene extension" object will be rejected.

## Configure extended scene recall

The extended scene recall allows polling up to 64 scenes of the dimming output in sequence. Here, scene recall takes place via the 1-bit communication object "Extended scene recall". Each ON telegram received via this object recalls the next of the available scenes in the configuration. Each OFF telegram received recalls the previous scene.

With the extended scene recall, the actuator always recalls the neighbouring scene - starting with the scene most recently recalled via the extended recall. It is irrelevant whether the scene is active on the appropriate dimming output (scene number = "1...64" or scene active) or inactive (scene number = "0" or scene inactive). If an inactive scene is recalled via the extended scene recall, the dimming output will not react.

Only the scenes available in the scene configuration can be selected via the extended scene recall (with "variable" defined by the parameter "number of scenes", with "fixed" always all 64 scenes). After a reset (bus voltage return, ETS programming operation), an ON or OFF telegram always recalls scene 1 first.

**i** Recall of a scene via the 1-byte extension object does not influence the scene sequence of the extended scene recall. The two recall functions work independently of each other.

- Activate the parameter "Extended scene recall" on parameter page "Dimming output 1 -> DO1 - General -> Scenes".

The object "Extended scene recall" is available. Each ON telegram recalls the next scene. Each OFF telegram recalls the previous scene.

- Deactivate the parameter "Use extended scene recall".

The extended scene recall is deactivated. A scene recall can only take place via the 1-byte scene extension object.

The extended scene recall can take place with or without an overflow at the scene limits. An overflow occurs when the last scene of the selected configuration is reached when counting up or scene 1 when counting down and an additional telegram in the last counting direction is received by the actuator. The overflow behaviour is defined in the ETS.

- Activate the parameter "with overflow".

After reaching the last scene of the selected configuration, a further ON telegram of the overflow is executed and scene 1 is recalled. Similarly, after reaching scene 1, the overflow is executed by further OFF telegram and the last scene of the selected configuration is recalled.

- Deactivate the parameter "With overflow".

A scene overflow is not possible. After reaching the last scene of the selected configuration, further ON telegrams of the extended scene recall are ignored. In the same way, the actuator ignores further OFF telegrams if scene 1 was recalled last.

### 9.13.1 Scene function parameters

Dimming output 1 -> DO1 - General -> Enabled functions

Scene function	Checkbox (yes / no)
This parameter can be used disable or to enable the scene function. The parameter is deactivated if cyclical monitoring is enabled.	

Dimming output 1 -> DO1 - General -> Scenes

Delay scene recall	Checkbox (yes / no)
A scene is recalled via the scene extension object. If required, the scene recall can be delayed on reception of a recall telegram (parameter activated). The recall is alternatively made immediately on reception of the telegram (parameter deactivated)	

Delay time	0...59 min 0...10...59 s
These parameters specify the duration of the scene delay time.	

On scene request	Jumping to brightness value <b>Dimming to brightness value via dimming increm. time</b> Dimming brightness value via fading
When recalling a scene, the configured or stored scene value is set for the dimming output. This parameter setting can define whether the brightness value can be instantly jumped to or dimmed to or is set via fading. When fading, the brightness value to be set is reached in the exact configured fading time irrespective of the dimming characteristic of an output and irrespective of which brightness value the dimming procedure was started at. Thus, for example, several dimming outputs can be set to the same brightness at the same time.	

Dimming increment time	0 ... 5... 255 ms
Setting of the dimming increment time if the brightness value of a scene should be dimmed. This parameter is visible only if the parameter "Behaviour when recalling a scene" is set to "Dim to brightness value via dimming increment time".	

Time for brightness value via fading	0 ... 2 ... 240 s
Setting of the fading time if the brightness value of a scene should be dimmed to via fading. This parameter is visible only if the parameter "behaviour when recalling a scene" is set to "dim to brightness value via fading".	

Visual feedback for storage function	Checkbox (yes / no)
<p>Optionally, a visual feedback via the dimming output can be signaled when executing a storage command. The output flashes once as feedback in the configured flashing time.</p> <p>Parameter activated: When a storage function is executed, the visual feedback is activated immediately. The output switches to the opposite switching state for the duration of the configured flashing time and then back to the saved scene command.</p> <p>Parameter deactivated: When storing a scene, the visual feedback is not executed. The actuator adopts the current state of the output without special feedback.</p>	
Flashing time (0...10)	0...5...10
<p>The flashing time in which the visual feedback is to be executed is set here.</p> <p>This parameter is only visible when visual feedback is used.</p>	
Overwrite values stored in the device during the ETS programming operation	Checkbox (yes / no)
<p>During storage of a scene, the scene values (current states of the dimming outputs concerned) are stored internally in the device. To prevent the stored values from being replaced during ETS programming by the originally programmed scene values, the actuator can inhibit overwriting of the scene values (parameter deactivated). As an alternative, the original values can be reloaded into the device during each programming run of the ETS (parameter activated).</p>	
Use extended scene recall	Checkbox (yes / no)
<p>The extended scene recall allows polling up to 64 scenes of the dimming output in sequence. Here, scene recall takes place via the 1-bit communication object "Extended scene recall". Each ON telegram received via this object recalls the next scene. Each OFF telegram received recalls the previous scene.</p> <p>This parameter enables extended scene recall, if required.</p>	
With overflow	Checkbox (yes / no)
<p>The extended scene recall can take place with or without an overflow at the scene limits. An overflow occurs when the last scene of the selected configuration is reached when counting up or scene 1 when counting down and an additional telegram in the last counting direction is received by the actuator.</p> <p>Parameter activated: After reaching the last scene of the selected configuration, a further ON telegram of the overflow is executed and scene 1 is recalled. Similarly, after reaching scene 1, the overflow is executed by further OFF telegram and the last scene of the selected configuration is recalled.</p> <p>Parameter deactivated: A scene overflow is not possible. After reaching the last scene of the selected configuration, further ON telegrams of the extended scene recall are ignored. In the same way, the actuator ignores further OFF telegrams if scene 1 was recalled last.</p> <p>This parameter is only visible when the extended scene recall is used.</p>	



Scene configuration	variable (1...64 scenes) fixed (64 scenes)
<p>The scene configuration selected here decides whether the number of scenes is either variable (1 ... 64) or alternatively fixed to the maximum (64).</p> <p>variable (1...64 scenes): With this setting, the number of scenes used can be selected anywhere in the range 1 to 64. The parameter "Number of scenes" decides how many scenes are visible for the switching output in the ETS and can therefore be used. It is possible to specify which scene number (1 ... 64) controls each scene.</p> <p>fixed (64 scenes): With this setting, all scenes are always visible and can therefore be used. The scenes are controlled via permanently assigned scene numbers (1 ... 64) (scene number 1 -&gt; scene 1, scene number 2 -&gt; scene 2 ...). If necessary, individual scenes can be deactivated.</p>	
Number of scenes (1...64)	1...10...64
<p>This parameter is only available with variable scene configuration and defines how many scenes are visible for the dimming output in the ETS and can therefore be used.</p>	
Scene number	0...1*...64 *: The predefined scene number is dependent on the scene (1...64).
<p>With variable scene configuration, the number of scenes used can be selected anywhere in the range 1 to 64. It is then possible to preset which scene number (1 ... 64) controls each scene.</p> <p>A setting of "0" deactivates the corresponding scene so that neither recalling nor storage is possible. If the same scene number is configured for several scenes, only the scene with the lowest sequential number will be addressed. The other scenes will be ignored in this case.</p> <p>This parameter is only available with variable scene configuration.</p>	
Scene active	Checkbox (yes / no)
<p>With a fixed scene configuration, individual scenes can be activated or deactivated. Only activated scenes can be used. A deactivated scene cannot be recalled or stored via the scene extension.</p> <p>This parameter is only available with fixed scene configuration.</p>	
brightness value	switch off Basic brightness 5 % ... 100 %
<p>This parameter is used for configuring the value which is set when the scene is recalled.</p>	

Memory function	Checkbox (yes / no)
<p>If the parameter is activated, the storage function of the scene is enabled. The current switching state can then be stored internally via the extension object on receipt of a storage telegram. If the parameter is deactivated, the storage telegrams are rejected.</p>	

**9.13.2 Scene function objects**

Object no.	Function	Name	Type	DPT	Flag
38	Scene extension	Dimming 1 ... - Input	1 bytes	18,001	C, (R), W, -, A

1-byte object for polling or saving a scene.

Object no.	Function	Name	Type	DPT	Flag
37	Extended scene recall	Dimming 1 ... - Input	1-bit	1,001	C, (R), W, -, A

1-bit object for extended scene recall. Each ON telegram received recalls the next scene of the dimming output in sequence. Each OFF telegram received recalls the previous scene.

After a reset (bus voltage return, ETS programming operation), an ON or OFF telegram always recalls scene 1 first.

## 9.14 Staircase function

The staircase function can be used for implementing time-controlled lighting of a staircase or for function-related applications. The staircase function must be enabled in the ETS on parameter page "Dimming output 1 -> DO1 - General -> Enabled functions" in order for the required communication objects and parameters to be visible.

The staircase function is activated via the communication object "Staircase function start / stop" and is independent of the "switching" object of the dimming output. In this way, parallel operation of time and normal control is possible, whereby the command last received is always executed: A telegram to the "switching" object or a scene recall at the time of an active staircase function aborts the staircase time prematurely and presets the switching state according to the received object value (the time delays are also taken into account) or scene value. Likewise, the switching state of the "switching" object can be overridden by a staircase function.

Time-independent continuous light switching can also be implemented in combination with a disabling function because the disabling function has a higher priority and overrides the switching state of the staircase function.

The staircase function can also be extended by means of a supplementary function. At the same time, it is possible to activate a time extension. The "time extension" permits retriggering of an activated staircase via the object "Staircase function Start / Stop"  $n$  times. Alternatively, the "time preset via the bus" can be set. With this supplementary function, the configured staircase time can be multiplied by a factor received via the bus, thus it can be adapted dynamically.

Furthermore, an extension of the staircase function can be implemented by means of a separate switch-on delay and pre-warning function. The pre-warning should, according to DIN 18015-2, warn any person still on the staircase that the light will soon be switched off. As an alternative to the pre-warning at the end of the staircase time, the actuator can activate reduced continuous lighting. In this way, for example, long, dark hallways can have permanent basic lighting.

### Specifying switch-on behaviour of the staircase function

An ON telegram to the "Staircase function start/stop" object activates the staircase time ( $T_{ON}$ ), the duration of which is defined by the parameters "Staircase time". In addition, a switch-on delay ( $T_{Delay}$ ) can be activated (see "presetting switch-on delay of the staircase function"). At the end of the staircase time, the output switches off or activates optionally the pre-warning time ( $T_{Prewarn}$ ) of the pre-warning function (see "presetting pre-warning function of the staircase function"). Taking into account any possible switch-on delay and pre-warning function, this gives rise to the switch-on behaviour of the staircase function as shown in the following diagram.

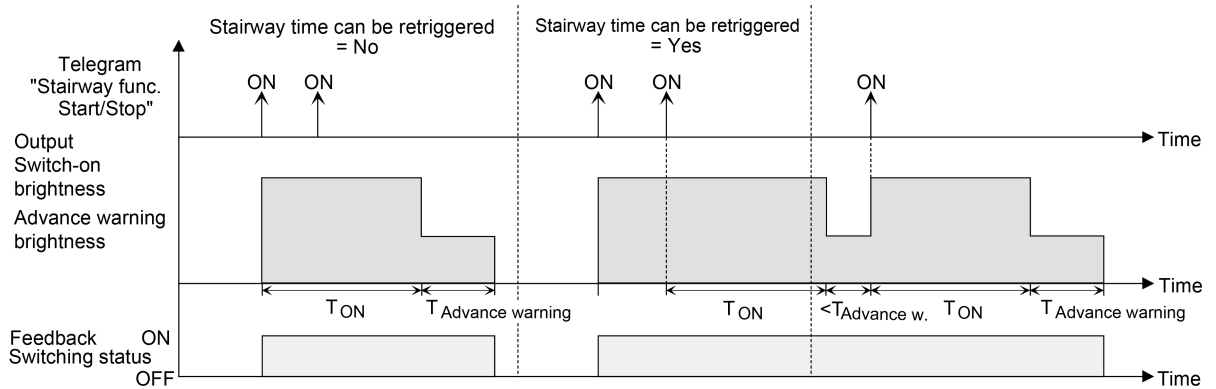

Image 17: Switch-on behaviour of the staircase function without soft functions

In addition, switching on can be influenced by the soft functions of the actuator. Taking into account any soft ON and soft OFF function, this gives rise to a modified switch-on behaviour of the staircase function.

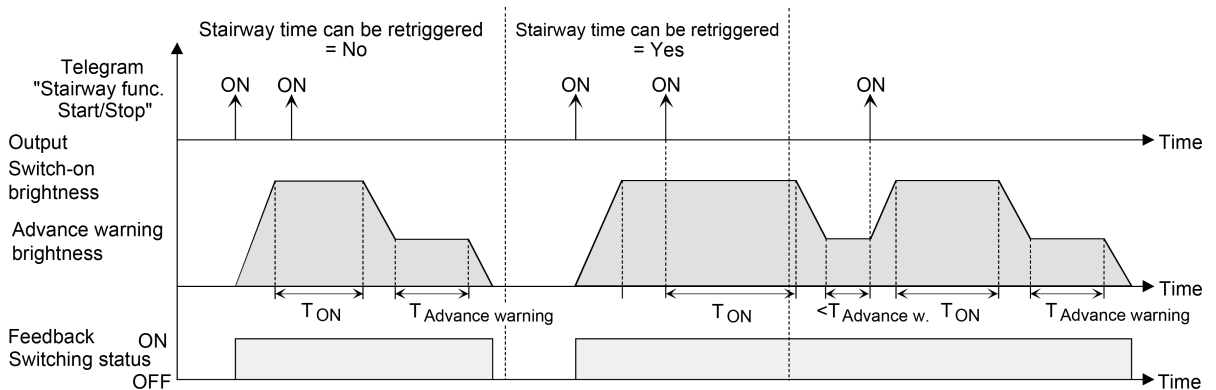

Image 18: Switch-on behaviour of the staircase function with soft functions (as an example with minimum brightness = 0 %)

The parameter "Staircase time retriggerable" specifies whether the staircase time can be retriggered.

Precondition:

The staircase function must have been enabled on parameter page "Dimming output 1 -> DO1 - General -> Enabled functions".

- In the "staircase time" parameter on parameter page "Dimming output 1 -> DO1 - General -> Staircase function", configure the necessary switch-on time of the staircase function.
  - Activate parameter "Staircase time retriggerable".  
Every ON telegram received during the ON phase of the staircase time retriggers the staircase time completely.
  - Deactivate parameter "Staircase time retriggerable".  
ON telegrams received during the pre-warning time are rejected. The staircase time is not retriggered.
- i** An ON telegram received during the pre-warning time always retriggers the staircase time independently of the parameter "Staircase time retriggerable".

- i** When the supplementary function "Time extension" is preset, the parameter "Staircase time retriggerable" cannot be adjusted. In this case, it is permanently deactivated.

### Specifying switch-off behaviour of the staircase function

In the case of a staircase function, the reaction to an OFF telegram can also be configured on the object "staircase function start/stop". At the end of the staircase time, the dimming output always shows the reaction "At the end of the staircase time" configured in the ETS, without the receipt of an OFF telegram. At the same time, the output can switch off, optionally activate the pre-warning time ( $T_{\text{Prewarn}}$ ) of the pre-warning function or dim to the reduced continuous lighting (application: e.g. long, dark hallways). If, on the other hand, the dimming output receives an OFF telegram via the object "Staircase function start/stop", the actuator evaluates the parameter "Reaction to an OFF-telegram". In this case, the output can react immediately to the OFF telegram and end the staircase time prematurely. Alternatively, the OFF telegram can be ignored. Taking into account any possible pre-warning function, this gives rise to the example switch-off behaviour of the staircase function.

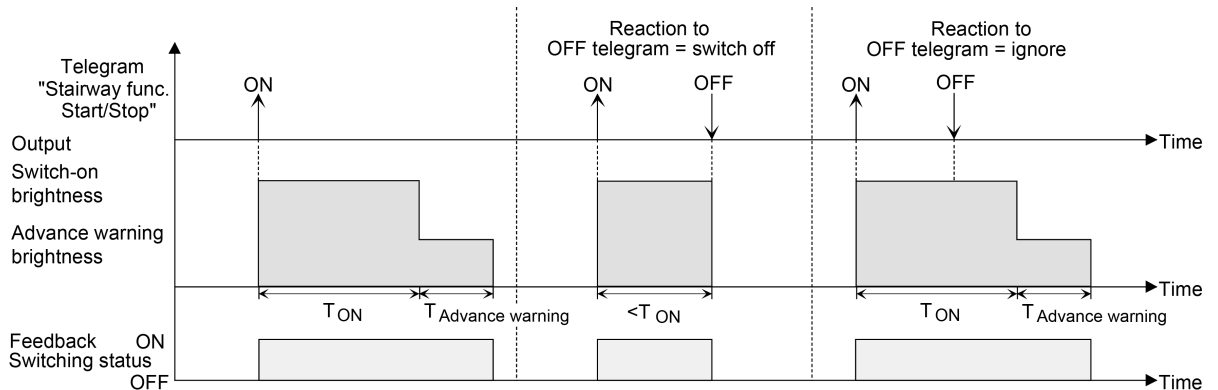

Image 19: Switch-off behaviour of the staircase function without soft functions

In addition, the switch-off can be influenced by the soft functions of the actuator. Taking into account any soft ON and soft OFF function, this gives rise to a modified switch-off behaviour of the staircase function.

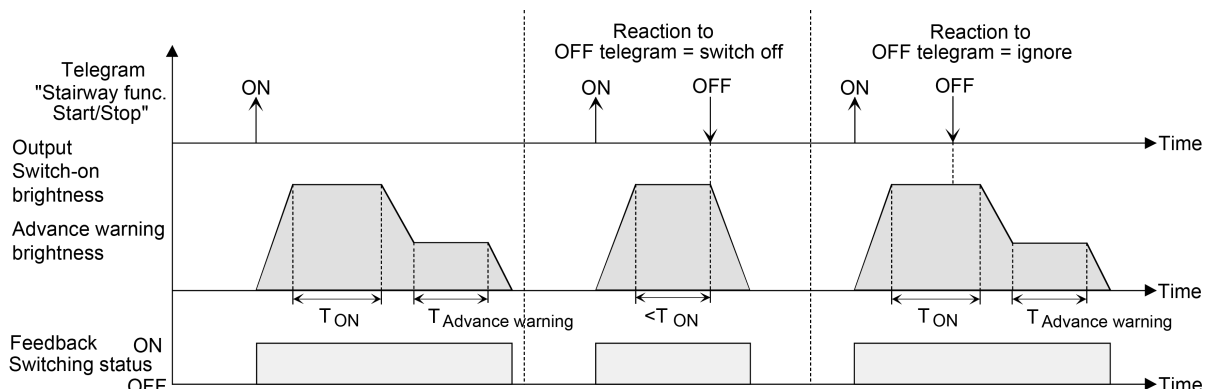

Image 20: Switch-off behaviour of the staircase function with soft functions (as an example with minimum brightness = 0 %)

The parameter "reaction to OFF-telegram" defines whether the staircase time ( $T_{\text{ON}}$ ) of the staircase function can be aborted prematurely.

Precondition:

The staircase function must have been enabled on parameter page "Dimming output 1 -> DO1 - General -> Enabled functions".

- Set parameter "Reaction to OFF-telegram" to "switch off".

As soon as an OFF telegram is received via the object "Staircase function start/stop" during the ON phase of the staircase time, the output switches off immediately. If the staircase time is stopped prematurely by such a telegram, there is no pre-warning, i.e. the pre-warning time is not started. It is also not dimmed to a reduced continuous lighting. It is also possible to switch off prematurely during a dimming procedure of a soft function or during a pre-warning or reduced continuous lighting.

- Set parameter "Reaction to OFF-telegram" to ignore".

OFF telegrams received during the ON phase of the staircase time are rejected. The staircase time will be executed completely to the end with pre-warning if necessary.

**i** With the supplementary function "time preset via the bus", the staircase time of the staircase function can also be started by the reception of a new time factor. In this case, received "0" factors are interpreted as an OFF telegram. Here too, the parameter "Reaction to OFF telegram" is evaluated so that a staircase time can be cancelled early.

**i** The parameter "Reaction to OFF telegram" does not influence the reception and the evaluation of OFF telegrams via the "Switching" object.

### Setting the switch-on delay of the staircase function

An ON telegram for activation of the staircase function can also be evaluated with a time delay. This switch-on delay can be activated separately for the staircase function and has no influence on the configurable time delays for the object "switching".

Precondition:

The staircase function must have been enabled on parameter page "Dimming output 1 -> DO1 - General -> Enabled functions".

- Deactivate the parameter "Switch-on delay" on parameter page "Dimming output 1 -> DO1 - General -> Staircase function".

The switch-on delay is deactivated. After reception of an ON telegram on the object "Staircase function start/stop", the staircase time is activated immediately and the output switched on.

- Activate the parameter "switch-on delay".

The switch-on delay for the staircase function is enabled. The desired switch-on delay time can be specified. After reception of an ON telegram on the object "Staircase function start/stop", the switch-on delay is started. Another ON-telegram triggers the time only when the parameter "Switch-on delay retriggerable" is activated. The staircase time is activated and the output is switched on only after the time delay has elapsed.

- i** An OFF telegram via the object "Staircase function start/stop" during the switch-on delay only terminates the delay if the parameter "Reaction to OFF-telegram" is set to "switch off". Otherwise, the OFF telegram is ignored.
- i** When the supplementary function "Time extension" is preset, the parameter "Switch-on delay retriggerable" cannot be adjusted. In this case, it is permanently deactivated.

### Setting the pre-warning function of the staircase function

At the end of the switch-on time of the staircase function, the actuator for the dimming output shows the reaction "At the end of the staircase time" configured in the ETS. The output can be set to switch off immediately, alternatively to dim to the reduced continuous lighting (application: e.g. long, dark hallways) or to execute the pre-warning function. If the parameter is configured to "activate pre-warning time", the pre-warning time ( $T_{\text{Prewarn}}$ ) and pre-warning brightness can be configured in the ETS.

The pre-warning should, according to DIN 18015-2, warn persons still on the staircase that the light will soon be switched off. As a pre-warning, the dimming output can be set to a pre-warning brightness before the channel switches off permanently. The pre-warning brightness is normally reduced in the brightness value compared to the switch-on brightness. The pre-warning time is added to the staircase time ( $T_{\text{ON}}$ ). The pre-warning time influences the value of the feedback object so that the value "OFF" (in the case of non-inverted transmission) is first tracked after the pre-warning time in the object has elapsed.

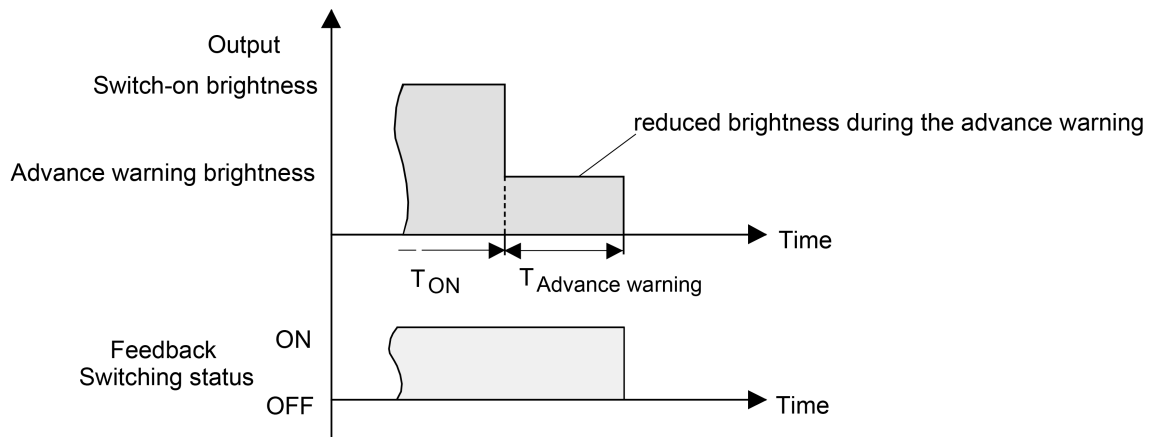

Image 21: The pre-warning function of the staircase function without soft OFF function

Additionally, the pre-warning function can also be extended by the soft OFF function. Taking into account any soft OFF function, this gives rise to a modified switch-off behaviour of the staircase function after the pre-warning has elapsed.



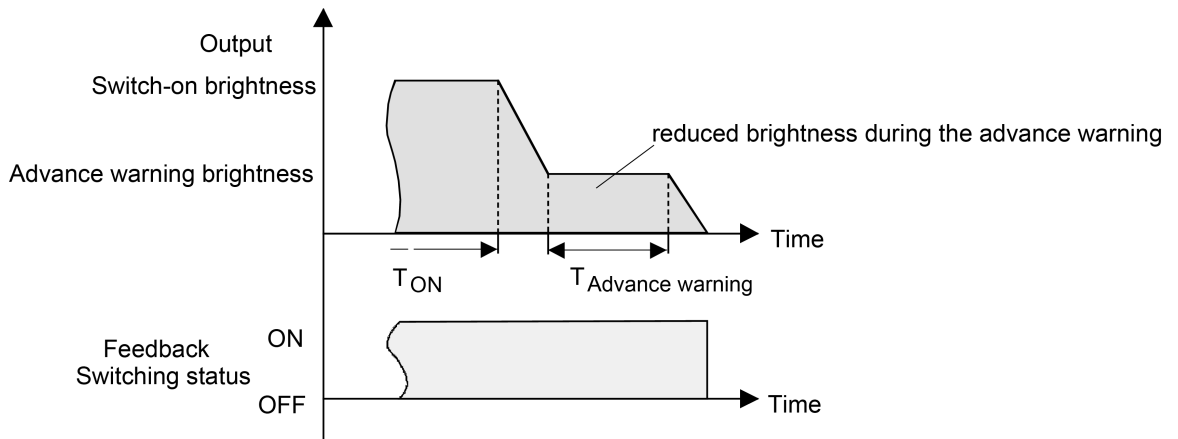

Image 22: The pre-warning function of the staircase function with soft OFF function (as an example with minimum brightness = 0%)

**Precondition:**

The staircase function must have been enabled on parameter page "Dimming output 1 -> DO1 - General -> Enabled functions".

- Set the parameter "At the end of the staircase time" on the parameter page "Dimming output 1 -> DO1 - General -> Staircase function" to "Activate pre-warning time".

The pre-warning function is enabled. The desired pre-warning time ( $T_{Prewarn}$ ) can be preset.

- Set the parameter "Reduced brightness" to the desired value.

During the pre-warning time, the dimming output is set to the configured brightness value.

- i** The configured value for the reduced brightness must be greater than or equal to the minimum brightness (if configured) or less than or equal to the maximum brightness!
- i** An ON telegram to the object "Staircase function start/stop" while a pre-warning function is still in progress stops the pre-warning time and always starts (independently of the parameter "Staircase time retriggerable ?") the staircase time anew. Even during the pre-warning time, the parameter "reaction to OFF telegram" is evaluated so that a pre-warning in progress can be terminated early by switching off.
- i** An ON telegram to the object "Staircase function start/stop" while a pre-warning function is still in progress stops the pre-warning time and always starts (independently of the parameter "Staircase time retriggerable ?") the staircase time anew. Even during the pre-warning time, the parameter "reaction to OFF telegram" is evaluated so that a pre-warning in progress can be terminated early by switching off.
- i** Using the automatic switch-off function: The reduced brightness of the pre-warning does not start the switch-off function after reaching or undershooting the switch-off brightness!

### Setting continuous lighting of the staircase function

At the end of the switch-on time of the staircase function, the actuator for the dimming output shows the "reaction at the end of the staircase time" configured in the ETS. The output can be set to switch off immediately, alternatively to execute a pre-warning function, or to dim to reduced continuous lighting. The reduction of the lighting to continuous lighting after the staircase time has elapsed is appropriate, for example, if a certain degree of artificial light should be switched on permanently in long, dark hallways. Switching to switch-on brightness by activating the staircase function normally takes place by additional presence detectors or motion detectors when people are present in the hallway.

If the parameter "Reaction at the end of the staircase time" is configured to "activate reduced continuous lighting", the brightness for the continuous lighting can be configured in the ETS. The continuous brightness is normally reduced in the brightness value compared to the switch-on brightness.

The continuous lighting remains permanently active after the staircase time has elapsed. Only when an ON telegram is received again via the object "Staircase function start/stop" does the actuator switch back to the switch-on brightness and start counting the staircase time again. The receipt of an OFF telegram via the object "staircase function start/stop" only switches the continuous lighting off if the parameter "Reaction to OFF-telegram" is configured to "switch off".

- i** A dimming output can always be switched on and off via the "switching" object independently of the staircase function. Consequently, continuous lighting will also be overridden if telegrams arrive on the actuator via the "switching" object. If permanent continuous lighting is desired, which cannot be influenced by the "switching" object nor by the object of the staircase function, the disabling function of the actuator should be used.

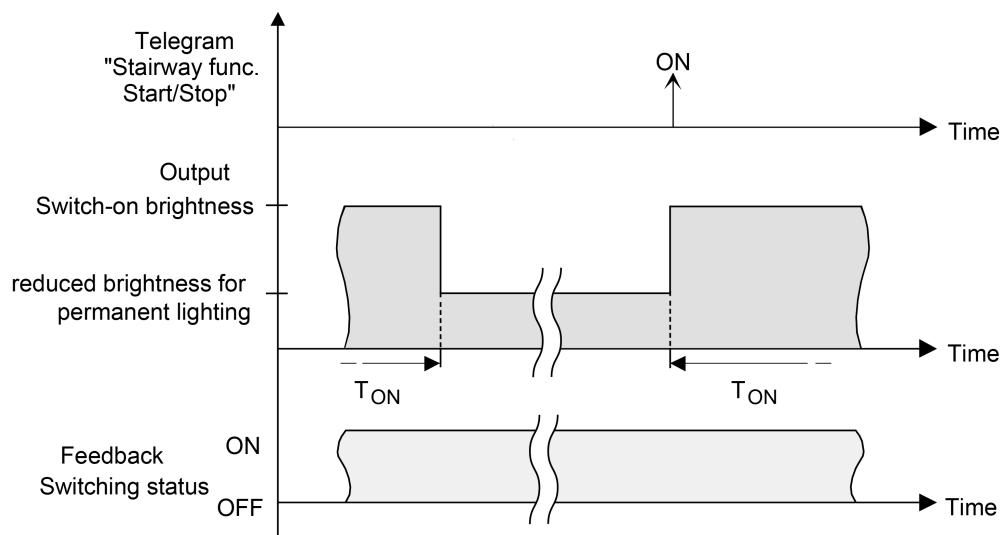

Image 23: The continuous lighting of the staircase function without soft functions

Additionally, the continuous lighting can also be extended by the soft function. Taking into account any soft ON and soft OFF function, this gives rise to modified continuous lighting behaviour of the staircase function.

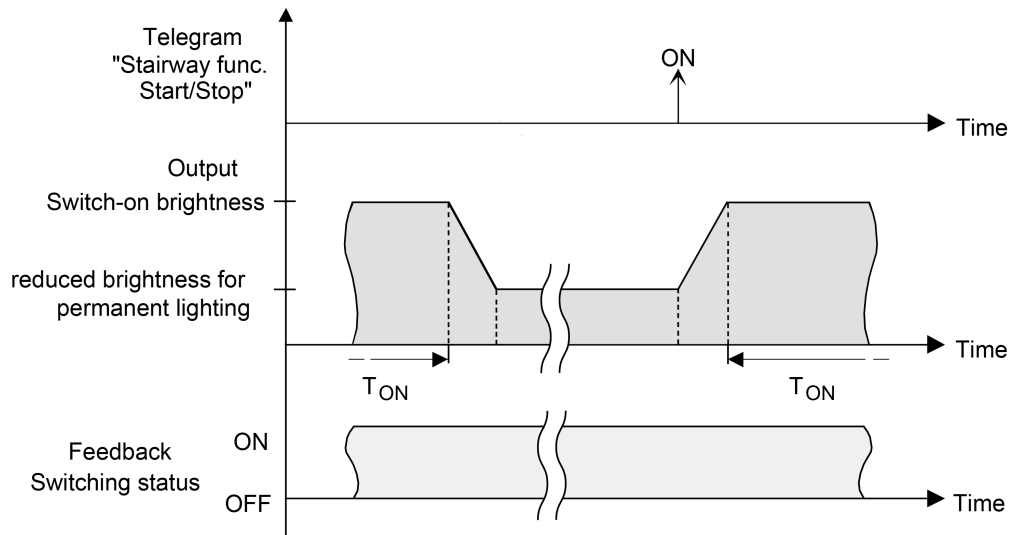

Image 24: The continuous lighting of the staircase function with soft OFF functions

- i** The brightness of the continuous lighting does not necessarily have to be less than the switch-on brightness. The brightness of the continuous lighting can always be configured to values between basic/minimum brightness and maximum brightness.

Precondition:

The staircase function must have been enabled on parameter page "Dimming output 1 -> DO1 - General -> Enabled functions".

- Set the parameter "At the end of the staircase time" on the parameter page "Dimming output 1 -> DO1 - General -> Staircase function" to "Activate reduced continuous lighting".

The continuous lighting is enabled. The "Reduced brightness" can be set to the desired brightness value.

- i** The configured value for the reduced brightness must be greater than or equal to the minimum brightness (if configured) or less than or equal to the maximum brightness!
- i** An ON telegram to the object "Staircase function start/stop" while a pre-warning function is still in progress stops the pre-warning time and always restarts the staircase time (independently of the parameter "Staircase time retriggerable"). Even during activated continuous lighting, the parameter "Reaction to OFF telegram" is evaluated so that continuous lighting can be switched off.
- i** Using the automatic switch-off function: The reduced brightness of the continuous lighting does not start the switch-off function after reaching or undershooting the switch-off brightness!

### Setting supplementary function of the staircase function – time extension

With the time extension function, the staircase time can be retriggered several times (i.e. extended) via the "Staircase function start/stop" object. The duration of the extension is predefined by several operations at the control section (several ON tele-

grams in succession). The configured staircase time can be extended in this way by the configured factor (a maximum of 5-fold). The time is then always extended automatically at the end of a single staircase time ( $T_{ON}$ ).

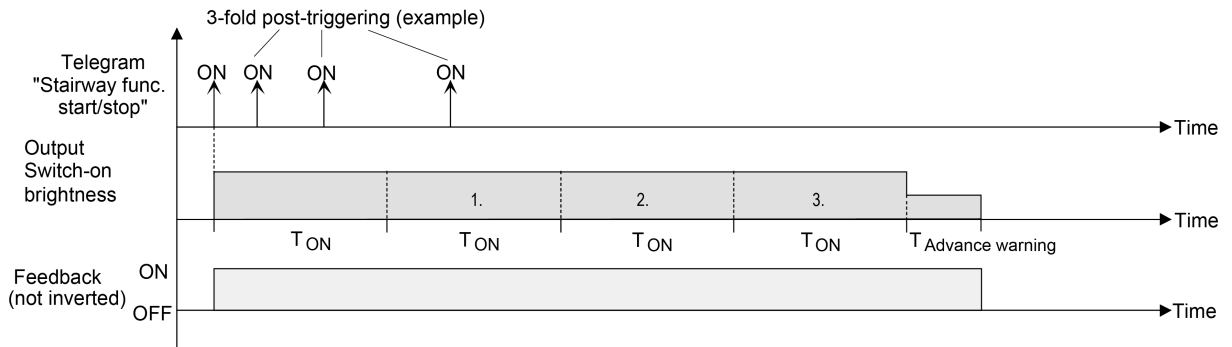

Image 25: Time extension of the staircase function

With this function, the lighting time in a staircase can be extended (e.g. by a person after shopping) by a defined length without having to retrigger the lighting every time the lighting shuts off automatically.

Precondition:

The staircase function must have been enabled on parameter page "Dimming output 1 -> DO1 - General -> Enabled functions".

- On the parameter page "Dimming output 1 -> DO1 - General -> Staircase function" set the parameter "Supplementary function" to "time extension" and set the maximum desired factor on the parameter "maximum time extension".  
The staircase time is retriggered each time an ON telegram is received on the "staircase time start/stop" object after the staircase time has elapsed, depending on the number of telegrams received, but only as often as pre-defined by the configured factor.  
For example, the "3-fold time" setting means that after the started staircase time has elapsed, it can be retriggered automatically a maximum of three additional times. The time is therefore extended a maximum of four fold.

**i** A time extension can be triggered during the entire staircase time ( $T_{ON}$ ). There is no time limit between two telegrams for the time extension. Telegrams for the time extension are only evaluated during the staircase time. An ON telegram during the pre-warning function triggers the staircase time as a restart, which means that a new time extension is possible.  
If a switch-on delay was configured, the time extension is recorded during the switch-on delay.

**i** If a time extension was configured as a supplementary function, the parameters "Staircase time retriggerable" and "Switch-on delay retriggerable" are permanently deactivated since the staircase time can be retriggered by the time extension.

## Setting supplementary function of the staircase function – time preset via the bus

With time specification via the bus, the configured staircase time can be multiplied by an 8-bit factor received via the KNX, thus it can be adapted dynamically. With this setting, the factor is derived from the object "staircase time factor". The possible factor value for setting the staircase time is between 1...255.

The entire staircase time arises as a product from factor (object value) and the configured staircase time as a basis as follows...

Staircase time = (staircase time object value) x (staircase time parameter)

### Example:

Object value "staircase time factor" = 5; parameter "staircase value" = 10s.  
-> set staircase time = 5 x 10s = 50 s.

Alternatively, the staircase function parameter can define whether the receipt of a new factor also starts the staircase time of the staircase function at the same time. In this case, the object "Staircase function start/stop" is not necessary and the received factor value determines the starting and stopping.

### Precondition:

The staircase function must have been enabled on parameter page "Dimming output 1 -> DO1 - General -> Enabled functions".

- On the parameter page "Dimming output 1 -> DO1 - General -> Staircase function" set the parameter "Supplementary function" to "time preset via the bus" and deactivate the parameter "Staircase function activatable via 'Staircase time' object".

The staircase time can be adapted dynamically by the "staircase time factor" object. A value "0" is interpreted as value "1". The staircase function is started and stopped exclusively via the "staircase function start / stop" object.

- Activate the parameter "supplementary function" to "time preset via the bus" and activate the parameter "staircase function activatable via 'staircase time' object".

The staircase time can be adapted dynamically by the "staircase time factor" object. In addition, the staircase function is started with the new staircase time (the object "staircase function start / stop" is not necessary). A factor value "0" is interpreted as an OFF telegram, whereby in this case, the configured reaction to an OFF telegram is evaluated, too.

A larger staircase with several floors is an example as an application for the time preset via the bus with automatic starting of the staircase time. On each floor there is a push-button sensor that transmits a factor value to the staircase function. The higher the floor, the greater the factor value transmitted so that the lighting stays switched on longer if the passing through the staircase needs more time. When a person enters a staircase and a pushbutton is pressed, the staircase time is now adjusted dynamically to the staircase time and switches on the lighting at the same time, too.

- i** The staircase function is started via the reception of a new factor: A factor > 0 received during a pre-warning time always triggers the staircase time independently of the parameter "Staircase time retriggerable".
- i** After a reset (bus voltage return or ETS programming) the "staircase time factor" object is always initialised with "1". However, the staircase function is not started automatically solely as the result of this (see "Set behaviour of staircase function after bus voltage return").
- i** The two supplementary functions "time extension" and "time preset via the bus" can only be configured alternatively.

### Setting the behaviour of the staircase function after bus voltage return

The staircase function can optionally be started automatically after bus voltage return.

Precondition:

The staircase function must have been enabled on parameter page "Dimming output 1 -> DO1 - General -> Enabled functions".

- Set the parameter "Behaviour after bus voltage return" on the parameter page "Dimming output 1 -> DO1 - General" to "activating staircase function".  
Immediately after bus voltage return, the staircase time of the staircase function is started.
- i** During automatic starting of the staircase function after bus voltage return, no switch-on delay is started if the staircase function has configured such a delay.
- i** The device only executes the configured "Behaviour on bus voltage return" only if the last ETS programming of the application or of the parameters ended at least approx. 20 s prior to switching on the bus voltage. Otherwise ( $T_{ETS} < 20$  s) the behaviour "after ETS programming" will be adopted also in case of bus voltage return.
- i** The configured behaviour will only be executed, if no forced position on bus voltage return is activated.

### 9.14.1 Staircase function parameters

Dimming output 1 -> DO1 - General -> Enabled functions

Staircase function/logic operation function	<b>no selection</b> Staircase function Logic operation function
This parameter determines whether the staircase function or alternatively the logic operation function is available for the dimming output.	

Dimming output 1 -> DO1 - General -> Staircase function

Staircase time	0...23 h 0...3...59 0...59
This parameter is used for programming the duration of the switch-on time for a scene recall.	

Staircase time retriggerable	Checkbox (yes / no)
An active switch-on time can be retriggered (parameter activated). Alternatively, the retriggering time (parameter deactivated) can be suppressed. This parameter is preset to deactivated if the supplementary function "Time extension" is configured. Re-triggering will not be possible.	

Switch-on delay	Checkbox (yes / no)
The staircase function enables the activation of an own switch-on delay. This switch-on delay affects the trigger result of the staircase function and thus delays the switch-on.  activated: The switch-on delay for the staircase function is enabled. After reception of an ON telegram on the object "Staircase function start/stop", the switch-on delay is started. Another ON-telegram triggers the time only when the parameter "Switch-on delay retriggerable" is activated. The staircase time is activated and the output is switched on only after the time delay has elapsed.  deactivated: The switch-on delay is deactivated. After reception of an ON telegram on the object "Staircase function start/stop", the staircase time is activated immediately and the output switched on.	

Switch-on delay	0...23 h 0...3...59 0...59
This parameter is used for setting the duration of the switch-on delay. Sets the switch-on delay hours.	

Switch-on delay retriggerable	Checkbox (yes / no)
<p>An active switch-on delay can be retriggered (parameter activated). Alternatively, the retriggering time (parameter deactivated) can be suppressed.</p> <p>This parameter is deactivated if the supplementary function "Time extension" is configured. Re-triggering will not be possible.</p> <p>The parameters for the switch-on delay are only visible when the switch-on delay is used.</p>	
Reaction to OFF-telegram	<p><b>switch off</b></p> <p>ignore</p>
<p>An active switch-on time can be aborted prematurely by switching off the staircase function.</p> <p>switch off: The switch-on time is aborted after receipt of an OFF telegram on the object "Staircase time start/stop".</p> <p>With the supplementary function "time preset via the bus" and the setting "Staircase function activatable via object 'Staircase time' = activated" the switch-on time can also be prematurely ended by a factor of "0".</p> <p>ignore: OFF Telegrams or "0" factors are ignored. The switch-on time will be executed completely to the end.</p>	
Supplementary function	<p><b>no supplementary function</b></p> <p>time extension</p> <p>time preset via the bus</p>
<p>The staircase function can be extended by the two supplementary functions "Time extension" and "Time specifications via bus", which should be used alternatively. This parameter enables the desired supplementary function and thereby activates the necessary parameters or objects.</p> <p>no supplementary function: No supplementary function is enabled.</p> <p>Time extension: The time extension is activated. This function permits retriggering an activated staircase lighting time span-times via the object "Staircase function start/stop".</p> <p>Time preset via the bus: The time preset via the bus is activated. With this supplementary function, the configured switch-on time can be multiplied by a factor received via the KNX, thus it can be adapted dynamically.</p>	



Maximum time extension	<b>1-fold staircase time</b> 2-fold staircase time 3-fold staircase time 4-fold staircase time 5-fold staircase time
<p>In case of a time extension (retriggering the lighting time n-times via the object "Staircase function start/stop), the parameterized staircase lighting time will be extended by the value programmed in this parameter.</p> <p>"1-fold staircase time" means that after the started staircase time has elapsed, it can be retriggered a maximum of one more time. The time is therefore extended two fold. The other settings behave in a similar manner.</p> <p>This parameter is visible only if the supplementary function "time extension" is set.</p>	
Staircase function activatable via "Staircase time" object	Checkbox (yes / no)
<p>A time preset via the bus can specify here whether the receipt of a new time factor also starts the switch-on time (parameter activated). At the same time, the object "Staircase function start/stop" is hidden.</p> <p>If the parameter is deactivated, the switch-on time can be activated exclusively via the object "Staircase function start/stop".</p> <p>This parameter is visible only if the supplementary function "time preset via the bus" is set.</p>	
At the end of the staircase time	<b>switch off</b> activate pre-warning time activate reduced continuous lighting
<p>At the end of the staircase time, the actuator for the dimming output displays the configured behaviour here. The output can be set to switch off immediately or alternatively to execute a pre-warning function.</p> <p>switch off: At the end of the staircase time, the actuator switches off the dimming output.</p> <p>Activate pre-warning time: At the end of the staircase time, the dimming output can generate a pre-warning prior to switch-off. The pre-warning, for example, should warn any person still on the staircase that the light will soon be switched off.</p> <p>Activate reduced continuous lighting: At the end of the switch-on time, the actuator activates reduced continuous lighting for the dimming output. The reduction of the lighting to continuous lighting is appropriate, for example, if a certain degree of artificial light should be switched on permanently in long, dark hallways. Switching to switch-on brightness by activating the staircase function normally takes place by additional presence detectors or motion detectors when people are present in the hallway. The continuous lighting remains permanently active after the switch-on time has elapsed. Only when an ON telegram is received again via the object "Staircase function start/stop" does the actuator switch back to the switch-on brightness and start counting the switch-on time again.</p>	

Pre-warning time	0...59 min 0... <b>30</b> ...59 s
------------------	--------------------------------------

This parameter is used for setting the duration of the pre-warning time. The pre-warning time is added to the switch-on time.

Reduced brightness	Basic brightness 5 % ... <b>50 %</b> ... 100 %
--------------------	---

This parameter defines the reduced brightness that is set either for pre-warning or continuous lighting.

### 9.14.2 Staircase function objects

Object no.	Function	Name	Type	DPT	Flag
41	Staircase function start/stop	Dimming 1 ... - Input	1-bit	1,010	C, (R), W, -, A
1-bit object to activate or deactivate the switch-on time of the staircase function of the dimming output ("1" = switch-on / "0" = switch-off).					
Object no.	Function	Name	Type	DPT	Flag
42	Staircase time factor	Dimming 1 ... - Input	1 bytes	5,010	C, (R), W, -, A
1-byte object to specify a time factor for the switch-on time of the staircase function (value range: 0... 255).					

### 9.15 Logic operation function

A logic function can be parameterized separately for the dimming output. This function allows the logic operation of the "Switching" object state and an additional logic operation object. The state of the communication object for "switching" can also be evaluated with a time delay if a switch-on delay or switch-off delay is set.

The logic operation function can also be combined with other functions of the dimming output. A combination with the staircase function is not possible, however.

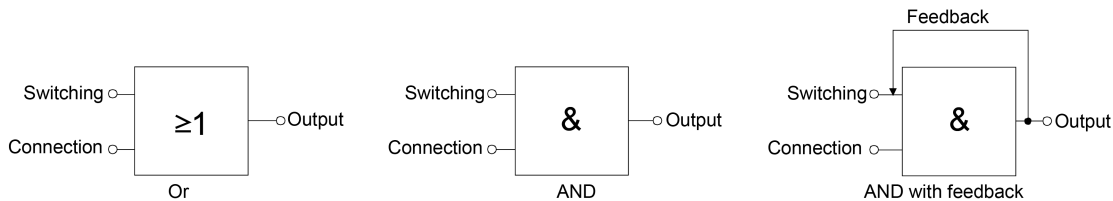

Image 26: Logic operation types of the logic operation function

**i** "AND with feedback":  
 With a logic object = "0", the switching output is always "0" (logic AND). In this case, the feedback signal from the output to the "switching" input will directly reset this input when it is being set. The output of the switching output can assume the logical state "1" by a newly received "1" on the input "switching" only when the logic object is = "1".

The object "Logic operation" can be initialised with a configured value after bus voltage return or after an ETS programming operation so that a correct logic operation result can be determined immediately and set on the output during a telegram update on the "Switching" object.

- Activate the parameter "Logic operation function" on parameter page "Dimming output 1 -> DO1 - General -> Enabled functions".  
 The logic operation function is enabled. The communication object "Logic operation" and the parameters of the logic operation function on the parameter page "Dimming output 1 -> DO1 - General -> Logic operation function" become visible.
- Set the parameter "Type of logic operation function" to the desired logic operation type.
- Set the parameters "object value after bus voltage return" and "object value after ETS programming" to the required initial states.

The "logic operation" object is initialised immediately with the set switching states after bus voltage return or ETS programming of the application program or parameters.

- i** The logic operation function after a reset of the actuator (bus voltage return or ETS programming operation) is first executed when the switching object is updated as the input of the logic operation by at least one telegram.
- i** The states or switching states specified at the end of a disabling function or forced position function, which are set after programming in the ETS, in the case of bus voltage failure or after bus or mains voltage return, override the lo-

gic operation function. The configured logic operation is first re-executed and the result set on the switching output when the switching object is updated as the input of the logic operation by at least one telegram.

### 9.15.1 Logic operation function parameters

Dimming output 1 -> DO1 - General -> Enabled functions

Staircase function/logic operation function	<b>no selection</b> Staircase function Logic operation function
This parameter determines whether the staircase function or alternatively the logic operation function is available for the dimming output.	

Dimming output 1 -> DO1 - General -> Logic operation function

Type of logic operation function	<b>OR</b> AND AND with feedback
This parameter defines the logical type of the logic operation function. The object "logic operation" is linked to the logic switching state of the dimming output (object "switching" after evaluation of the configured time delays if necessary) using the logic operation function set here. This parameter is only visible when the logic operation function is enabled.	

Object value after bus voltage return	<b>0 (OFF)</b> 1 (ON)
After bus voltage return, the object value of the logic operation object is initialised here with the preset value. This parameter is only visible when the logic operation function is enabled.	

Object value after ETS download	<b>0 (OFF)</b> 1 (ON)
After programming the application or the parameters in the ETS, the object value of the logic operation object is initialised here with the preset value. This parameter is only visible when the logic operation function is enabled.	

**9.15.2 Logic operation function objects**

Object no.	Function	Name	Type	DPT	Flag
33	Logic operation	Dimming 1 ... - Input	1-bit	1,002	C, (R), W, -, A
<p>1-bit object as input of the logical link of the dimming output. After bus voltage return or after programming with the ETS, the object value can be predefined for each parameter.</p>					

### 9.16 Operating hours counter

The operating hours counter determines the switch-on time of the dimming output. The output is actively on for the operating hours counter if the brightness value is greater than "0", i.e. when current is flowing to the load.

The operating hours counter can either be configured as a second counter or alternatively as an hour counter.

- Second counter  
The actuator adds up the determined switch-on time accurately to the second for the switched on dimming output. The totaled operating seconds are added in a 4-byte counter and stored permanently in the device. The current counter reading can be transmitted cyclically to the KNX by the "Value operating hours counter reading" communication object or when there is a change in an interval value in acc. with DPT 13.100.
- Second counter  
The actuator adds up the determined switch-on time accurately to the minute for the switched-on dimming output in full operating hours. The totaled operating hours are added in a 2-byte meter and stored permanently in the device. The current counter reading can be transmitted cyclically to the KNX by the "Value operating hours counter" communication object or when there is a change in an interval value in acc. with DPT 7.007.

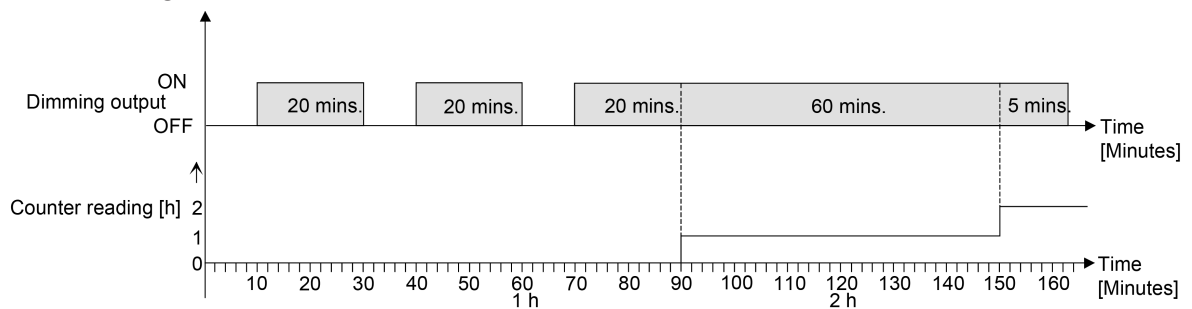

Image 27: Function of the operating hours counter (using the example of counted hours)

In the delivery state, all values of the actuator are "0". If the operating hours counter is not enabled in the configuration of an output, no operating hours or operating seconds will be counted for the output concerned. Once the operating hours counter is enabled in the ETS, however, the operating hours or operating seconds will be determined and added up by the ETS immediately after commissioning the actuator. If the operating hours counter is subsequently disabled again in the parameters and the actuator is programmed with this disabling function, all the operating hours or operating seconds previously counted for the output concerned will be deleted. When enabled again, the meter reading of the operating hours counter is always on "0 h".

The operating hours values (full hours) or operating seconds stored in the device will not be lost in case of a bus voltage failure or by ETS programming.

On the hour counter: Any summed up operating minutes (full hour not yet reached) will be rejected in this case, however.

After bus voltage return or after an ETS programming operation, the actuator passively updates the "Value operating hours counter" communication object in each output. The object value can be read out if the read-flag is set. The object value, de-



pending on the configuration for the automatic transmission, is actively transmitted if necessary to the KNX once the configured transmission delay has elapsed after bus voltage return (see "Set transmission behaviour of the operating hours counter").

### Activating the operating hours counter

- Activate the parameter "Operating hours counter" on parameter page "Dimming output 1 -> DO1 - General -> Enabled functions".

The operating hours counter is activated.

- Deactivate the operating hours counter".

The operating hours counter is deactivated.

**i** Disabling of the operating hours counter and subsequent programming with the ETS resets the counter status to "0".

### Setting the counter type

The operating hours counter can optionally be configured as an up-counter or down-counter. Depending on this type of counter, a limit or start value can be set optionally, whereby, for example, the operating time of a lamp can be monitored by restricting the counter range.

#### Up-counter:

After activating the operating hours counter by enabling in the ETS or by restarting, the operating hours are counted starting at "0". A maximum of 65,535 hours or 2147483647 can be counted (corresponds to approx. 66 years), after that the counter stops and signals a counter operation via the "Operating hours count. elapsed" object.

A limiting value can be set optionally in the ETS or can be predefined via the communication object "Limiting value operating hours counter". In this case, the counter operation is signaled to the KNX via the "Operating hours count. elapsed" object if the limiting value is reached, but the counter continues counting - if it is not restarted - up to the maximum value and then stops. Only a restart initiates a new counting operation.

#### Down-counter:

After enabling the operating hours counter in the ETS, the meter reading is on "0 h" and the actuator signals a counter operation for the output concerned after the programming operation or after bus voltage return via the "Operating hours count. elapsed" object. Only after a restart is the down-counter set to the maximum value of 65,535 hours or 2147483647 seconds (corresponds to approx. 66 years) and the counter operation is started.

A start value can be set optionally in the ETS or can be predefined via the communication object "start value operating hours counter". If a start value is set, the down-counter is initialised with this value instead of the maximum value after a restart. The meter then counts the start value downwards by the hour. When the down-counter reaches the value "0", the counter operation is signalled to the KNX via the "Operating hours count. elapsed" and the counting is stopped. Only a restart initiates a new counting operation.

The operating hours counter must have been enabled on parameter page "Dimming output 1 -> DO1 - General -> Enabled functions.

- Set the parameter "Type of counter" on parameter page "Dimming output 1 -> DO1 - General -> Operating hours counter" to "up-counter". Set the parameter "Limiting value presetting" to "yes, as specified in parameter" or "yes as received via object" if it is necessary to monitor the limiting value. Otherwise, reset the parameter to "no". In the "Yes, as specified in parameter" setting, specify the required limit value.

The meter counts the operating hours forwards starting from "0 h". If the monitoring of the limiting value is activated, the actuator transmits an "ON"-telegram via the object "Operating hours count. elapsed" for the output concerned once the predefined limiting value is reached. Otherwise, the counter operation is first transmitted when the maximum value is reached.

- Set the parameter "Counter type" to "Down-counter". Set the parameter "Start value preset" to "yes, as parameter" or "yes, as received via object" if a start value preset is necessary. Otherwise, reset the parameter to "no". In the "yes, as specified in parameter" setting, specify the required start value.

The meter counts the operating hours down to "0 h" after a restart. With a start value preset, the start value is counted down, otherwise the counting operation starts at the maximum value. The actuator transmits an "ON"-telegram via the object "Operating hours count. elapsed" for the output concerned once the value "0" is reached.

**i** The value of the communication object "Operating hours count. elapsed" is stored permanently. On switching on the bus voltage or after an ETS programming operation, the object is initialised with the most recently saved value. If an operating hours counter is in this case identified as elapsed, i.e. if the object value is a "ON", an additional telegram will be actively transmitted to the KNX as soon as the configured transmit delay has elapsed after bus voltage return. If the counter has not yet elapsed (object value (object value "OFF")), no telegram is transmitted on bus voltage return or after an ETS programming operation.

**i** With a limiting or start value preset via communication object: The values received via the object are first validly accepted and permanently saved internally after a restart of the operating hours counter. On switching on the bus voltage or after an ETS programming operation, the object is initialised with the most recently saved value. The values received will be lost in the case of a bus voltage failure or by an ETS programming operation if no counter restart was executed before. For this reason, when specifying a new start or limiting value it is advisable to always execute a counter restart afterwards as well. A standard value of 65,535 hours or 2147483647 seconds is predefined provided that no limiting value or start value has been received yet via the object. The values received and stored via the object are reset to the standard value if the operating hours counter is disabled in the parameters of the ETS and an ETS programming operation is being performed.

- i** With a limiting or start value predefined via object: If the start or limiting value is predefined with "0", the actuator will ignore a counter restart to avoid an undesired reset (e.g. in site operation -> hours already counted by manual operation).
- i** If the counter direction of an operating hours counter is reversed by reconfiguration in the ETS, a restart of the meter should always be performed after programming the actuator so that the meter is reinitialised.

### Restarting the operating hours counter

The meter reading of the operating hours can be reset at any time by the communication object "Restart operating hours counter". The polarity of the reset telegram is predefined: "1" = Restart / "0" = No reaction.

In the up-counter the meter is initialised with the value "0" after a restart and in the down-counter initialised with the start value. If no start value was configured or predefined by the object, the start value is preset to 65535 hours or 2147483647 seconds.

During every counter restart, the initialised meter reading is transmitted actively to the KNX.

After a restart, the signal of a counter operation is also reset. At the same time, an "OFF" telegram is transmitted to the KNX via the object "Operating hours count elapsed". In addition, the limiting or start value is initialised.

- i** If a new limiting or start value was predefined via the communication object, a counter restart should always be performed afterwards, too. Otherwise, the values received will be lost in the case of a bus voltage failure or by an ETS programming operation.
- i** If a start or limiting value is predefined with "0", there are different behaviours after a restart, depending on the principle of the value definition...  
Preset as parameter:  
The counter elapses immediately after a counter restart.  
Preset via object:  
A counter restart will be ignored to avoid an undesired reset (e.g. after installation of the devices with hours already being counted by manual operation). A limiting or start value greater than "0" must be predefined in order to perform the restart.

### Setting the transmission behaviour

The current value of the operating hours counter is tracked continuously in the communication object "value operating hours counter". The content of the object is transmitted to the KNX when there is a change by the set count interval or cyclically active. The object value can also be read out at any time (set read flag).

The operating hours counter must have been enabled on parameter page "Dimming output 1 -> DO1 - General -> Enabled functions.

- Set the parameter "Automatic transmission of counting value" on parameter page "Dimming output 1 -> DO1 - General -> Operating hours counter" to "after change by interval value". Set the "Counting value interval" to the desired value.

The meter reading is transmitted to the KNX as soon as it changes by the pre-defined counting value interval. After bus voltage return or after ETS programming operation, the object value is transmitted automatically after "Delay after bus voltage return" has elapsed if the current counter status or a multiple of this corresponds to the counting value interval. A counter status "0" is always transmitted in this case.

- Set the parameter "Automatic transmission of counting value" to "Cyclical".  
The counter value is transmitted cyclically. The cycle time is defined via the parameter of the same name. After bus voltage return or an ETS programming operation, the counter status is only transmitted to the KNX after the configured cycle time has elapsed.

### 9.16.1 Operating hours counter parameters

Dimming output 1 -> DO1 - General -> Enabled functions

Operating hours counter	Checkbox (yes / no)
The operating hours counter can be disabled or enabled here.	

Dimming output 1 -> DO1 - General -> Operating hours counter

Function	<b>second counter (DPT 13.100)</b> hour counter (DPT 7.007)
----------	--

The operating hours counter can either be configured as a second counter or alternatively as an hour counter.

**Second counter:** The actuator adds up the determined switch-on time accurately to the second for the switched on dimming output. The totalled operating seconds are added in a 4-byte counter and stored permanently in the device. The current counter reading can be transmitted cyclically to the KNX by the "Value operating hours counter reading" communication object or when there is a change in an interval value in acc. with DPT 13.100.

**Hour counter:** The actuator adds up the determined switch-on time accurately to the minute for the switched on dimming output in full operating hours. The totalled operating hours are added in a 2-byte meter and stored permanently in the device. The current counter reading can be transmitted cyclically to the KNX by the "Value operating hours counter" communication object or when there is a change in an interval value in acc. with DPT 7.007.

Type of counter	<b>up-counter</b> down-counter
-----------------	-----------------------------------

The operating hours counter can be configured as an up-counter or down-counter. The setting here influences the visibility of the other parameters and objects of the operating hours counter.

Limiting value presetting	<b>no</b> yes, as specified in parameter yes, as received via object
---------------------------	--

If the up-counter is used, a limiting value can optionally be predefined. This parameter defines whether the limiting value can be set via a separate parameter or adapted individually by a communication object from the bus. The "No" setting deactivates the limiting value.

This parameter is only visible in the configuration "Type of counter = up-counter".

Limiting value (s)*	0... <b>2147483647*</b>
Limiting value (h)**	0... <b>65535**</b>
<p>The limiting value of the up-counter is set here. Once the limiting value is reached, an "ON" telegram is transmitted via the object "Operating hours count elapsed". The counter itself continues until the maximum counter status is reached and then stops.</p> <p>*: With second counter            **: With hour counter</p> <p>This parameter is only visible if the parameter "Limiting value presetting" is set to "yes, as specified in parameter".</p>	
Start value preset	<b>no</b> yes, as specified in parameter yes, as received via object
<p>If the down-counter is used, a start value can optionally be predefined. This parameter defines whether the start value can be set via a separate parameter or adapted individually by a communication object from the bus. The setting "No" deactivates the start value.</p> <p>This parameter is only visible in the configuration "Type of counter = down-counter".</p>	
Start value (s)*	0... <b>2147483647*</b>
Start value (h)**	0... <b>65535**</b>
<p>The start value of the down-counter is set here. After the initialisation, the counter starts counting down the predefined value by the hour until the value "0". If this end value is reached, an "ON" telegram is transmitted via the object "Operating hours count elapsed"</p> <p>*: With second counter            **: With hour counter</p> <p>This parameter is only visible if the parameter "Start value preset" is set to "yes, as specified in parameter".</p>	
Transmission behaviour of the counter value	<b>cyclical</b> after change by interval value
<p>The current meter reading of the operating hours counter can be transmitted actively to the KNX via the "value operating hours counter" communication object.</p> <p>Cyclical: The counter reading is transmitted cyclically to the KNX and when there is a change.</p> <p>After change by interval value: The counter reading is transmitted to the KNX only when there is a change.</p>	
Time for cyclical transmission hours (0...23)	0...23
<p>This parameter defines the cycle time for the cyclical transmission. Setting the cycle time hours.</p>	

Minutes (0...59)	0...15...59
Setting the cycle time minutes.	
Seconds (10...59)	10...59
Setting the cycle time seconds. This parameter for the cycle time is only visible when parameter "Transmission behaviour of the counter value" is set to "cyclically".	
Counter value interval	0...3600...2147483647* 0...1...65535**
The interval of the counter value is set here for automatic transmission. The current counter reading is transmitted to the KNX after the time interval configured here. *: With second counter **: With hour counter This parameter is only visible when parameter "Transmission behaviour of the counter value" is set to "On change by interval value".	

### 9.16.2 Operating hours counter objects

Object no.	Function	Name	Type	DPT	Flag
239	Limiting value / starting value, operating hours counter	Dimming 1 ... - Input	4 bytes	13,100	C, (R), W, -, A
<p>4-byte object for external specification of a limit value/starting value of the operating hours counter of the dimming output.                      Value range: 0...2147483647 seconds                      This object is only available with the second counter.</p>					
Object no.	Function	Name	Type	DPT	Flag
240	Limiting value / starting value, operating hours counter	Dimming 1 ... - Input	2 bytes	7,007	C, (R), W, -, A
<p>2-byte object for external specification of a limit value/starting value of the operating hours counter of the dimming output.                      Value range: 0...65,535 hours                      This object is only available with the hour counter.</p>					
Object no.	Function	Name	Type	DPT	Flag
241	Restart op. hours counter	Dimming 1 ... - Input	1-bit	1,015	C, (R), W, -, A
<p>1-bit object for resetting the operating hours counter of the dimming output ("1" = restart, "0" = no reaction).</p>					
Object no.	Function	Name	Type	DPT	Flag
242	Value operating hours counter	Dimming 1 ... - Output	4 bytes	13,100	C, R, -, T, A
<p>4-byte object to transmit or read out the current counter level of the operating hours counter of the dimming output.                      Value range: 0...2147483647 seconds                      If the bus voltage should fail, the value of the communication object is not lost and is actively transmitted to the bus after bus voltage return or an ETS programming operation. In the as-delivered state, the value is "0".                      This object is only available with the second counter.</p>					



Object no.	Function	Name	Type	DPT	Flag
243	Value operating hours counter	Dimming 1 ... - Output	2 bytes	7,007	C, R, -, T, A

2-byte object to transmit or read out the current counter level of the operating hours counter of the dimming output.

Value range: 0...65,535 hours

If the bus voltage should fail, the value of the communication object is not lost and is actively transmitted to the bus after bus voltage return or an ETS programming operation. In the as-delivered state, the value is "0".

This object is only available with the hour counter.

Object no.	Function	Name	Type	DPT	Flag
244	Operating hours counter elapsed	Dimming 1 ... - Output	1-bit	1,002	C, R, -, T, A

1-bit object to sign that the operating hours counter has elapsed (forwards counter = limit value reached / backwards counter = value "0" reached). With a message, the object value is actively transmitted to the KNX ("1" = message active / "0" = message inactive).

If the bus voltage should fail, the value of the communication object is not lost and is actively transmitted to the bus after bus voltage return or an ETS programming operation.

## 9.17 Disabling function/forced position

A disabling function, or alternatively, a forced position function can be configured for the dimming output. Only one of these functions can be enabled.

### Setting disabling function as supplementary function

During an active disabling function, the KNX control of the output is overridden and locked. Continuous light switching, for example, can also be overridden. The deactivation of the disabling function can optionally take place using an additional 1-bit acknowledgement object. This prevents the deactivation of the disabling function by the disabling object.

- On parameter page "Dimming output 1 -> DO1 - General -> Enabled functions" Set the parameter "Disabling function / Forced position" to "Disabling function".

The disabling function is enabled. The communication object "Disable" and the parameters of the disabling function on the parameter page "Dimming output 1 -> DO1 - General -> Disabling function" become visible.

- Set the parameter "Polarity disabling object" to the desired polarity.
- Set the parameter "Beginning of the disabling function" to the required behaviour.

At the beginning of the disabling function, the configured behaviour will be executed and the bus control of the dimming output locked.

With the "Switch off" setting, the output is switched off and remains in this state.

With the "Brightness value" setting, the output sets the specified brightness value and remains in this brightness state.

The "Memory value (brightness value before last switch-off)" setting is used to set the brightness value that was active and internally stored before the last switch-off (via the "Switching" or "Central switching" object). After programming with the ETS, the value is predefined to maximum brightness. Only a bus voltage failure, however, does not delete the memory value.

In the "no reaction" setting, the dimming output shows no response and remains in the brightness state last selected.

In the "flashing" setting, the dimming output is switched on and off cyclically during the disabling. The "Time for flashing of the disabling functions" is generally configured on the parameter page "General -> Times". During flashing, the logical switching state of the dimming output is signalled back as "switched on" and the brightness value as "switch-on brightness". A soft ON/OFF function is not executed during flashing.

For disabling function without acknowledgement object...

- Deactivate the parameter "Confirmation".

No additional acknowledgement object is available. The disabling function is deactivated by the disabling object according to the set polarity.

- Set the parameter "End of the disabling function" to the required behaviour. At the end of the disabling function, the configured behaviour will be executed and the bus control of the dimming output enabled again.

With the "Switch off" setting, the output is switched off and remains in this state.

With the "Brightness value" setting, the output sets the specified brightness value.

The "Memory value (brightness value before last switch-off)" setting is used to set the brightness value that was active and internally stored before the last switch-off (via the "Switching" or "Central switching" object). After programming with the ETS, the value is predefined to maximum brightness. Only a bus voltage failure, however, does not delete the memory value.

With "tracked brightness value", the brightness value received during the disabling function or the brightness value set before the disabling function is tracked at the end of disabling. Any time functions still in progress will also be taken into account if necessary.

In the "No reaction" setting, the output shows no reaction and remains in the state last set by the disabling function.

In the "flashing" setting, the dimming output is switched on and off cyclically after the disabling. The flashing time is generally configured on the parameter page "General -> Times". During flashing, the logical switching state of the output is fed back as "Switched on". The flashing state remains active until another KNX command is received and thereby predefines another state.

For disabling function with acknowledgement object...

- Activate the parameter "Use acknowledgment"  
The acknowledgement object is available. The disabling function can only be deactivated using the acknowledgement object by an "ON telegram". Telegrams to the disabling object according to the "Deactivate disabling" polarity are ignored by the actuator.

**i** "OFF" telegrams to the acknowledgement object do not product a reaction.

- Set the parameter "End of the disabling function after acknowledgement" to the required behaviour. At the end of the disabling function, the configured behaviour will be executed and the bus control of the dimming output enabled again.

With the "Switch off" setting, the output is switched off and remains in this state.

With the "Brightness value" setting, the output sets the specified brightness value.

The "Memory value (brightness value before last switch-off)" setting is used to set the brightness value that was active and internally stored before the last switch-off (via the "Switching" or "Central switching" object). After programming with the ETS, the value is predefined to maximum brightness. Only a bus voltage failure, however, does not delete the memory value.

With "tracked brightness value", the brightness value received during the disabling function or the brightness value set before the disabling function is tracked at the end of disabling. Any time functions still in progress will also be taken into account if necessary.

In the "No reaction" setting, the output shows no reaction and remains in the state last set by the disabling function.

In the "flashing" setting, the dimming output is switched on and off cyclically after the disabling. The flashing time is generally configured on the parameter page "General -> Times". During flashing, the logical switching state of the output is fed back as "Switched on". The flashing state remains active until another KNX command is received and thereby predefines another state.

- i** After a bus failure or after programming the application or the parameters with the ETS, the disabling function is always deactivated (object value "0"). With the inverted setting "1 = enabled; 0 = disabled", a telegram update "0" must first be carried out after the initialisation until the disabling is activated.
- i** Updates of the disabling object from "activated" to "deactivated do not produce a reaction.
- i** In the setting "Set tracked state": During a disabling function, the overridden functions of the actuator (switching, scenes) continue to be executed internally. Consequently, newly received bus telegrams are evaluated and time functions are triggered as well. At the end of the disabling, the tracked states are set.

### Setting forced position function as supplementary function

The forced position function can also be combined with other functions of the dimming output. With an active forced position, functions with a lower priority are overridden so that the dimming output concerned is locked.

The forced position function possesses a separate 2-bit communication object. The first bit (Bit 0) of the object "Forced position" indicates whether the dimming output is switched off or switched on by force. If the dimming channel is switched on by force, an ETS parameter defines which brightness value it should be switched on to. The second bit (bit 1) activates or deactivates the forced-position state (see table below). The behaviour of the dimming output at the end of the forced-position can be configured. In addition, the forced object can be initialised on bus voltage return.

Bit 1	Bit 0	Function
0	x	Forced position not active -> normal control
1	0	Forced position active: switch off
1	1	Forced position active: switch on

## Bit coding of forced position

- On parameter page "Dimming output 1 -> DO1 - General -> Enabled functions" set the parameter "Disabling function / Forced position" to "Forced position".

The forced position function is enabled. The communication object "Forced position" and the parameters of the forced position function on the parameter page "Dimming output 1 ->DO1 - General -> Forced position" become visible.

- Set the parameter "forced position end 'inactive'" to the required behaviour.

At the end of the forced position, the configured behaviour will be executed and the bus control of the dimming output enabled again.

With the "No reaction" setting, the dimming output remains in the state last set by the forced position.

With "tracked brightness value", the brightness value received during the forced position function or the brightness value set before the function is adjusted at the end of the forced position. Any time functions still in progress will also be taken into account if necessary.

- i** Updates of the forced position object from "Forced position active" to "Forced position active" while maintaining the switching status or from "Forced position inactive" to "Forced position inactive" show no reaction.

- i** With the "tracked brightness value" setting at the end of the forced position: During a forced position, the overridden functions of the actuator (switching, scenes) continue to be executed internally. Consequently, newly received bus telegrams are evaluated and time functions are triggered as well. At the forced end, the tracked states are set.

- i** The current state of the forced position object will be stored in case of bus voltage failure.

- Set the parameter "After bus voltage return" to the required behaviour.

After bus voltage return, the configured state is transferred to the "Forced position" communication object. When a forced position is activated, the dimming output is immediately activated and interlocked accordingly by the forced control after bus voltage return until forced control is enabled via the KNX. The parameter "After bus voltage return" on the parameter page "Dimming output 1 -> DO1 - General" will, in this case, not be evaluated for the dimming output.

In the "state before bus voltage failure" setting, the forced position state last selected and internally stored before bus voltage failure will be tracked after bus voltage return. An ETS programming operation deletes the stored state (reaction in that case same as with "no forced position active").

If the tracked state corresponds to "No forced position", the force-independent parameter "After bus voltage return" (parameter page "Dimming output 1 -> DO1 - General") will be executed on return of bus voltage.

- i After programming the application or parameters with the ETS, the forced position function is always deactivated (object value "0").

### 9.17.1 Disabling function/forced position parameter

Dimming output 1 -> DO1 - General -> Enabled functions

Disabling function / Forced position	<b>no selection</b>  disabling function forced position
This parameter can define whether a disabling function or a forced position for the dimming output should be available. The disabling function is only configurable as an alternative to the forced position function.	

Dimming output 1 -> DO1 - General -> Disabling function

Acknowledgment	Checkbox (yes / no)
The deactivation of the disabling function can optionally take place using an additional 1-bit acknowledgement object. This prevents the deactivation of the disabling function by the disabling object. Alternatively, the acknowledgement object is not available. In this case, disabling is deactivated via the disabling object.  Parameter activated: The acknowledgement object is available. The disabling function can only be deactivated using the acknowledgement object by an "ON telegram". Telegrams to the disabling object according to the "Deactivate disabling" polarity are ignored by the actuator.  Parameter deactivated: No additional acknowledgement object is available. The disabling function is deactivated by the disabling object according to the set polarity.	
Polarity of the disabling object	<b>0 = disabled;</b> <b>1 = enabled</b>  1 = enabled; 0 = disabled
This parameter defines the polarity of the disabling object. This parameter is visible only if the disabling function is enabled.	

<p>Beginning of the disabling function</p>	<p><b>switch off</b>          brightness value          Memory value (brightn. bef. switch. off last time)          no reaction          flashing</p>
<p>The behaviour of the dimming output at the beginning of the disabling function can be configured.          This parameter is visible only if the disabling function is enabled.</p> <p>Switch off: At the start of the disabling function, the dimming output is switched off and locked.</p> <p>Brightness value: At the start of the disabling function, the dimming output is set to the predefined brightness value and locked.</p> <p>Memory value: At the start of the disabling function, the active and internally saved value prior to the last switch-off is set (via the "Switching" or "Central switching" object).</p> <p>No reaction: At the start of a disabling function, the dimming output shows no reaction and remains in the currently set state. Bus control of the dimming output is then locked.</p> <p>Switch on: At the start of the disabling function, the dimming output is switched on and locked.</p> <p>Flashing: The dimming output flashes on and off during the disabling function and the bus control is locked during this time. The flashing time is configured on the parameter page "General -&gt; General dimming output". During the flashing, the logical switching state is "on 1" and the switch-on brightness is signalled back as brightness. A soft ON/OFF function is ignored during flashing.</p>	

End of the disabling function	switch off brightness value Memory value (brightn. bef. switch. off last time) <b>tracked brightness value</b> no reaction flashing
-------------------------------	--

The behaviour of the dimming output at the end of the disabling function can be configured.

This parameter is visible only if the disabling function is enabled and acknowledgement is not used.

Switch off: At the end of the disabling function, the dimming output is switched off and enabled again.

Brightness value: At the end of the disabling function, the dimming output is set to the predefined brightness value and enabled again.

Memory value: At the end of disabling, the active and internally stored brightness value prior to the last switch-off is set (via the "Switching" or "Central switching" object).

tracked brightness value: At the end of the disabling function, the state received during the disabling function or the state set before the disabling function is tracked with the appropriate brightness value. Any time functions still in progress will also be taken into account if necessary.

No reaction: At the end of a disabling function, the dimming output shows no reaction and remains in the currently set state. Bus control of the dimming output is enabled again.

Flashing: The dimming output is enabled again for the bus control after the end of the disabling function and flashes on and off. The flashing time is configured on the parameter page "General -> General dimming output". During the flashing, the logical switching state is "on 1" and the switch-on brightness is signalled back as brightness. A soft ON/OFF function is ignored during flashing. The flashing status remains active until another bus command is received and specifies another status.



End of the disabling function after acknowledgement	switch off brightness value Memory value (brightn. bef. switch. off last time) <b>tracked brightness value</b> no reaction flashing
---	--

The behaviour of the dimming output at the end of the disabling function after successful confirmation can be configured.

This parameter is visible only if the disabling function is enabled and acknowledgement is used.

Switch off: On confirmation, the dimming output is switched off and enabled again.

Brightness value: On confirmation, the dimming output is set to the predefined brightness value and enabled again.

Memory value: On confirmation, the active and internally stored brightness value prior to the last switch-off is set (via the "Switching" or "Central switching" object).

tracked brightness value: On confirmation, the state received during the disabling function or the state set before the disabling function is tracked with the appropriate brightness value. Any time functions still in progress will also be taken into account if necessary.

No reaction: On confirmation, the dimming output shows no reaction and remains in the currently set state. Bus control of the dimming output is enabled again.

Flashing: The dimming output is enabled again for the bus control on confirmation and flashes on and off. The flashing time is configured on the parameter page "General -> General dimming output". During the flashing, the logical switching state is "on 1" and the switch-on brightness is signalled back as brightness. A soft ON/OFF function is ignored during flashing. The flashing status remains active until another bus command is received and specifies another status.

Dimming output 1 -> DO1 - General- -> Forced position

Forced position "active, switch on"	<b>brightness value</b> no reaction Memory value (brightn. bef. switch. off last time)
-------------------------------------	--

If the forced position is activated and forced-position state is "ON", you can define herehow the dimming output should behave.

Brightness value: The dimming output is set to the predefined brightness value.

No reaction: The dimming output shows no reaction and remains in the currently set state.

Memory value: The active and internally stored brightness value prior to the last switch-off is set (via the "Switching" or "Central switching" object).

Forced position "active, switch off"	<b>switch off</b>
<p>If forced position is activated and the forced position state is "OFF", the dimming output is always switched off.</p> <p>This parameter cannot be edited and is only visible when the forced position function is enabled.</p>	
Forced position end "inactive"	<b>no reaction</b> <b>tracked brightness value</b>
<p>The behaviour of the dimming output at the end of the forced-position can be configured here.</p> <p>This parameter is only visible when the forced position function is enabled.</p> <p>No reaction: The output shows no reaction and remains in the state last set by the forced position.</p> <p>tracked brightness value: At the end of the forced position, the state received during the forced position function or the state set before the function is tracked with the appropriate brightness value. Any time functions still in progress will also be taken into account if necessary. Bus control of the dimming output is enabled again.</p>	
After bus voltage return	<b>no forced position</b> Forced position active, switch on Forced position active, switch off state before bus voltage failure
<p>The forced position communication object can be initialised after bus voltage return. The brightness status of the dimming output can be influenced when the forced position function is activated.</p> <p>This parameter is only visible when the forced position function is enabled.</p> <p>No forced position: No forced position is activated after bus voltage return. Reaction of the dimming output according to the parameter "Behaviour after bus voltage return".</p> <p>Forced position active, switch on: The forced position is activated. The dimming output is switched on to the brightness value predefined by the parameter "Brightness for forced position 'active, switch on'".</p> <p>Forced position active, switch off: The forced position is activated. The dimming output is switched off under forced control.</p> <p>State before bus voltage failure": The forced position state last selected and internally stored before bus voltage failure will be tracked after bus voltage return. An ETS programming operation deletes the stored state (reaction in that case same as with "no forced position active"). If the tracked state corresponds to "No forced position", the force-independent parameter "After bus voltage return" (parameter page "Dimming output 1 -&gt; DO1 - General") will be executed on return of bus voltage.</p>	

**9.17.2 Disabling function and forced position objects**

Object no.	Function	Name	Type	DPT	Flag
39	Disabling	Dimming 1 ... - Input	1-bit	1,003	C, (R), W, -, A
1-bit object for disabling the dimming output (polarity configurable).					
Object no.	Function	Name	Type	DPT	Flag
40	forced position	Dimming 1 ... - Input	2-bit	2,001	C, (R), W, -, A
2-bit object for the forced position of a dimming output. The polarity is fixed by the telegram.					
Object no.	Function	Name	Type	DPT	Flag
47	Disabling acknowledgment	Dimming 1 ... - Input	1-bit	1,016	C, (R), W, -, A
1-bit object to acknowledge an active disabling function of the dimming output. This object is only visible if the acknowledgement is to be used with the disabling function ("1" = Disabling function is deactivated / "0" = disabling function remains active).					

## 10 Inputs

### 10.1 General settings

#### Introduction

The device has three inputs with a common reference potential. Potential-free switches, push-buttons or other contacts (e.g. magnetic contacts) or alternatively leakage and dew sensors (see also accessories) can be connected to these inputs. In addition, it is possible to connect an NTC temperature sensor to input 3 for measuring a floor or room temperature.

Depending on the ETS parameterisation in the application for switches, push-buttons or contacts, the inputs 1 and 2 either act internally on the dimming output or alternatively also separately on the KNX. Input 3 always acts on the KNX if required. With internal action, inputs 1 and 2 directly operate the dimming output in a defined configuration.

With the effect on the KNX, the inputs can transmit individual telegrams for switching or dimming for venetian blind control or value transmitter use (dimming value transmitter, light scene extension, colour or colour temperature value transmitter). They then function like the inputs of a push-button interface.

- i** The internal effect of inputs 1 and 2 on the dimming output corresponds to the delivery state (unprogrammed device). This means that a connected luminaire can already be put into operation and operated on the building site just by applying the bus voltage and without the use of further KNX sensors.

#### Configuration of inputs

The parameter "Inputs act internally on output" on the parameter page "General -> General inputs" defines the use of the inputs.

- Activate the parameter "Inputs act internally on output".  
Inputs 1 and 2 only act internally directly on the dimming output of the device and do not have their own parameters in the application programme. The type of action of the inputs is fixed.  
Input 3 acts separately on the KNX, independently of the dimming output and the other inputs. Depending on the ETS configuration, the functions "Switching", "Dimming", "Venetian blind", "Value transmitter", "Scene extension", "2-channel operation" and "Controller extension" can be set individually in the application for switches, push-buttons or contacts for input 3. In the "no function" setting, the input 3 is deactivated.
- Deactivate the parameter "Inputs act internally on output".  
The three inputs of the device act independently of the dimming output and separately from each other on the KNX. Depending on the ETS configuration, the functions "Switching", "Dimming", "Venetian blind", "Value transmitter", "Scene extension", "2-channel operation" and "Controller extension" can be set individually in the application for for each input. With the setting "no function", the corresponding input is deactivated.

In the application for dew and leakage sensors, the inputs are automatically configured by the application to the function "Switching". An ON telegram is sent on the KNX when the connected sensor is triggered, and an OFF telegram is sent when the sensor is reset. The debounce time is preset to the usable sensors by the parameter of the same name. However, the time can be set individually for each input if necessary. The instructions from the documentation of the dew and leakage sensors must be observed!

If input 3 is used as an input for a temperature sensor, parameters are available in the application program that define the acquisition of the measured value, the temperature adjustment and the transmission behaviour of the temperature value. The wired temperature sensor can be combined with an external temperature value. This makes it possible to form one measured value from up to two measured values.

- i** Only use the dew/leakage sensors and NTC temperature sensors listed in the accessories. Functional errors may occur with other sensors.
- i** The debounce time of the connected switches or push-buttons is always fixed at 30 ms with internal effect on the dimming output.
- i** After bus voltage recovery, the inputs show no reaction with internal effect. The intended reaction is only carried out when the signal changes. The device does not react to a change of state of the input signals until the parameterised "Delay after bus voltage return" has elapsed. Within the delay, any pending signals at the inputs are not evaluated and are ignored. In the delivery state the delay after bus voltage recovery is preset to 2 seconds.

The parameter "Functionality" on the parameter page "General -> General inputs" determines how inputs 1 and 2 operate in the event of an internal effect on the dimming output. Setting this parameter adjusts the inputs to the connected switches or buttons.

– Functioning of inputs 1 and 2 when controlling the internal dimming output as dual-area operation

In this application, the function of inputs 1 and 2 is predefined and cannot be changed. The inputs act together directly on the dimming output without KNX communication. In this application, for example, a series push-button can be connected. Simultaneous operation of both inputs must be avoided. The evaluation of the input signals can be taken from the following table.

Input	Push-button (NO contact)	Function
1	Press briefly (< 0.4 s)	On
1	Press for a long time (> 0.4 s)	Increase brightness
2	Press briefly (< 0.4 s)	Off
2	Press for a long time (> 0.4 s)	Reduce brightness

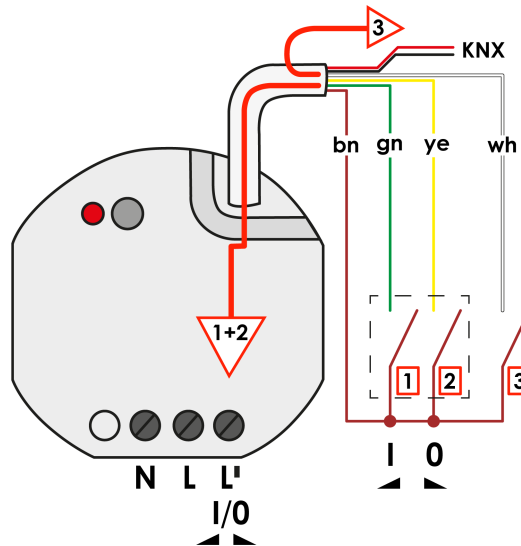

Image 28: Functioning of the inputs when controlling the internal dimming output as dual-area operation

- Functioning of input 1 when the internal dimming output 1 is controlled as single-area operation.

For this purpose, the parameter "Mode of operation" must be set to the setting "Single-area operation (I1 -> DO1)". Input 1 (I1) then acts directly on the dimming output 1 (DO1) without KNX communication. In this application, for example, a 1-fold rocker switch can be connected.

Input	Push-button (NO contact)	Function
1	Press briefly (< 0.4 s)	On / Off
1	Press for a long time (> 0.4 s)	Dim brighter / dim darker

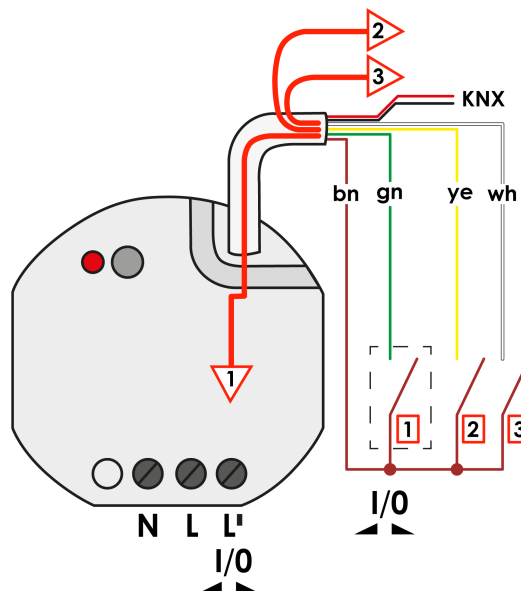

Image 29: Functioning of inputs when controlling the internal dimming output as single-area operation

### Name of a output

Here, you can optionally assign a name for each input. The name is intended to clarify the use of the input (e.g. "Contact window", "Switch light") and is used exclusively in the ETS in the text of the parameter pages and communication objects.

### Delay after bus voltage return

If the inputs act on the KNX, it can be defined separately for each input whether a reaction should take place after a device reset (bus voltage return or ETS programming operation). This means that a defined telegram can be transmitted to the KNX according to the input signal or with forced control. The configured "Delay after bus voltage return" for the inputs on the "General -> General inputs" parameter page must have elapsed fully by the time the set reaction is executed. Within the delay, any pending signals at the inputs are not evaluated and are ignored. The delay time is configured generally for all the inputs.

- i If a dew or leakage sensor is connected to the inputs, the delay after bus voltage recovery should not be configured to be less than 5 seconds.
- i In the delivery state the delay after bus voltage recovery is preset to 2 seconds.

### 10.1.1 Configuration inputs parameters

General -> General inputs

Inputs act internally on output	Checkbox (yes / no)
<p>Depending on the ETS parameterisation in the application for switches, push-buttons or contacts, the inputs 1 and 2 either act internally on the dimming output or alternatively also separately on the KNX. Input 3 always acts on the KNX if required. With internal action, input 1 and optionally input 2 directly operate the dimming output in a customisable mode of operation.</p> <p>This parameter defines in connection with the following parameter "Function" the use of the inputs.</p> <p>Parameter activated: Input 1 and optionally input 2 only act internally directly on the dimming outputs of the device and do not have their own parameters in the application programme. Input 3 acts separately on the KNX, independently of the relay outputs and the other inputs.</p> <p>Parameter deactivated: The three inputs of the device act independently of the dimming output and separately from each other on the KNX.</p>	

Function	single-area operation (I1 -> DO1) <b>dual-area operation (I1 &amp; I2 -&gt; DO1)</b>
<p>Single-area operation (I1 -&gt; DO1): Input 1 (I1) acts directly on dimming output 1 (DO1), input 2 (I2) acts separately on the KNX. In this application, for example, a push-button can be connected.</p> <p>Dual-area operation (I1 &amp; I2 -&gt; DO1): Inputs 1 (I1) and 2 (I2) act together directly on dimming output 1 (DO1) without KNX communication. In this application, for example, a 2-fold rocker switch can be connected. This setting corresponds to the delivery status of the device.</p>	

Delay after bus voltage return Minutes (0...59)	0...59
<p>If the inputs act on the KNX, it can be defined separately for each input whether a reaction should take place after a device reset (bus voltage return or ETS programming operation). This means that a defined telegram can be transmitted to the KNX according to the input signal or with forced control. The configured "Delay after bus voltage return" for the inputs on the "General -&gt; General inputs" parameter page must have elapsed fully by the time the set reaction is executed. Within the delay, any pending signals at the inputs are not evaluated and are ignored. The delay time is configured generally for all the inputs.</p> <p>If a dew or leakage sensor is connected to the inputs, the delay after bus voltage recovery should not be configured to be less than 5 seconds.</p> <p>Setting the delay time minutes.</p>	

Seconds (0...59)	0...5...59
Setting the delay time seconds.	

Input... -> I... - Function



Name of input	Free text
<p>The text entered in this parameter is adopted in the name of the communication objects and is used to identify the input in the ETS parameter window (e.g. "Contact window", "Switch light").</p> <p>The text is not programmed in the device.</p>	
Function	<p><b>Switches, push-buttons or contacts</b></p> <p>Dew/leakage sensor</p> <p>Temperature sensor (NTC)</p>
<p>Potential-free switches, push-buttons or other contacts (e.g. magnetic contacts) or alternatively leakage and dew sensors (accessories) can be connected to the inputs. In addition, it is possible to connect an NTC temperature sensor to input 3 for measuring a floor or room temperature.</p> <p>switches, push-buttons or contacts: The input acts independently of the relay outputs on the KNX. The functions "Switching", "Dimming", "Venetian blind", "Value transmitter", "Scene extension", "2-channel operation" and "Controller extension" can be set individually. In the "no function" setting, the input is deactivated.</p> <p>Dew/leakage sensor: With this setting, the input is automatically configured by the application to the "Switching" function. An ON telegram is sent on the KNX when the connected sensor is triggered, and an OFF telegram is sent when the sensor is reset. The debounce time is preset to the usable sensors by the parameter of the same name. However, the time can be set individually for each input if necessary. The instructions from the documentation of the dew and leakage sensors must be observed!</p> <p>Temperature sensor (NTC): This setting is only available for input 3. If this setting is selected, input 3 can be used as an input for a temperature sensor. Parameters are then available in the application programme that define the acquisition of the measured value, the temperature adjustment and the transmission behaviour of the temperature value. The wired temperature sensor can be combined with an external temperature value. This makes it possible to form one measured value from up to two measured values.</p>	

## 10.2 Switching

For each input whose function is set to "Switching", the ETS displays two 1-bit communication objects. The parameters can be used to determine which value the "Switch" object receives when the contact is closed and opened (ON, OFF, TOGGLE). No distinction is made between a brief or long press. Optionally, when using the "UM" operating command, the "Switching feedback" object can be used to switch the switching state of the input on the part of the KNX (for example, when using several operating devices).

### Behaviour after bus voltage return

After a device reset (bus voltage return or ETS programming operation), the communication object "Switching" of an input can be initialised. For this, the "On bus voltage return" parameter should be configured to the required reaction. In the settings "ON telegram" or "OFF telegram" telegrams are transmitted actively to the KNX according to this requirement. In the "Transmit current input status" setting, the device evaluates the static signal status of an input and, according to this, transmits the appropriately configured telegram to the bus (contact closed at the input = telegram as on closing; contact open at input = telegram as on opening). If, in this case, the edge command dependent on the current status is configured to "no reaction", the device does not transmit a telegram on initialisation.

- i** If a delay is set for the inputs after bus voltage return, the device only transmits the telegrams when the delay has elapsed.

### 10.2.1 Switching parameters

Input... -> I... - Function

Debounce time (10...255 ms)	10...255
This parameter sets the debouncing time individually for the input. According to the time set here, the input signal at the input is evaluated with a delay.	
When closing the contact	no reaction ON OFF TOGGLE
This parameter determines the reaction when the contact connected to the input is closed.	
When opening the contact	no reaction ON OFF TOGGLE
This parameter determines the reaction when the contact connected to the input is opened.	

After bus voltage return	<b>no reaction</b> Transmit current input status Send ON telegram Send OFF telegram
<p>At this point, the behaviour of the input after a device reset (bus voltage return, ETS programming operation) is defined. If a delay after bus voltage return is set for the inputs, the device will not carry out the reaction specified at this point until the delay has expired.</p> <p>no reaction: The device does not send a telegram for initialisation.</p> <p>transmit current input status: With this setting, the device evaluates the static signal status of an input and, according to this, transmits the appropriately configured telegram to the bus (contact closed at the input = telegram as on closing; contact open at input = telegram as on opening).</p> <p>Send ON telegram: The device sends an ON command for the input via the communication object "Switch".</p> <p>Send OFF telegram: The device sends an OFF command for the input via the communication object "Switch".</p>	

### 10.2.2 Switching objects

Object no.	Function	Name	Type	DPT	Flag
471, 474, 477	Switching	Input... - Output	1-bit	1,001	C, R, -, T, A
1-bit object for transmission of switching telegrams (ON, OFF).					
Object no.	Function	Name	Type	DPT	Flag
472, 475, 478	Switching feedback	Input... - Input	1-bit	1,001	C, -, W, -, U
1-bit object for receiving feedback telegrams (ON, OFF) from other control points.					

## 10.3 Dimming

For each input whose function is set to "dimming", two 1-bit objects and one 4-bit or one 3-byte object are available. In general, the device sends out a switching telegram when there is a short signal at the input (closed contact) and a dimming telegram when there is a long signal. After a long signal, the device sends a telegram to stop the dimming process in the standard parameterisation when the contact is opened. How long a signal must last until the device recognises it as long can be set in the parameters. The brightness or the colour temperature can be dimmed.

When an actuator is controlled by several control points, it is necessary for the actuator to report its switching status back to the 1-bit object "Switching feedback" of the input. Due to the feedback, the device detects that the actuator has changed its switching status by input from another element and adjusts the dimming direction accordingly.

The dimming direction is always only evaluated and switched locally, unless the actuator changes its switching status due to input from multiple elements (e.g. lighting ON / change of brightness value only). The 4-bit dimming objects and the 3-byte combi object are not tracked via the KNX.

### Advanced configuration options

The device has advanced parameters for the dimming function. If necessary, these advanced parameters can be activated and thus be made visible.

The advanced parameters can be used to determine whether the device is to cover the full adjusting range of the actuator with one dimming telegram continuously ("Increase brightness / Dimming colder by 100 %", "Reduce brightness / Dimming warmer by 100 %") or whether the dimming range is to be divided into several small levels (50 %, 25 %, 12.5 %, 6 %, 3 %, 1.5 %). With stepless dimming (100%), the device only sends a telegram at the beginning of a long signal to start the dimming process and usually a stop telegram when the contact at the input opens. For dimming in small levels it may be useful if the device repeats the dimming telegram in case of a sustained signal for a presettable time (parameter "Telegram repetition"). In return, the stop telegram can be omitted when opening the contact.

- i** When the parameters are hidden ("Advanced parameters = deactivated"), the dimming range is set to 100 %, the stop telegram is activated and the telegram repetition is deactivated.

### Behaviour after bus voltage return

After a device reset (bus voltage return or ETS programming operation), the communication object "Switching" of an input can be initialised. For this, the "On bus voltage return" parameter should be configured to the required reaction. In the settings "ON telegram" or "OFF telegram" telegrams are transmitted actively to the KNX according to this requirement.

- i** If a delay is set for the inputs after bus voltage return, the device only transmits the telegrams when the delay has elapsed.

### 10.3.1 Dimming of brightness

In the standard parameterisation, the brightness is dimmed, which is why the "Colour temperature control" parameter is deactivated.

- i** Even with "colour temperature control" activated, the brightness can be dimmed when using the combi object.

The "Dimming" function with the control of the brightness distinguishes between dual-area operation and single-area operation. The "Brightness when closing the contact" parameter defines the single- or dual-surface dimming principle.

dual-area operation	single-area operation
Brighter (ON)	Brighter / darker (TOGGLE)
Darker (OFF)	Brighter (TOGGLE)
	Darker (TOGGLE)

With dual-area operation, the device sends a telegram for switching on or off with a short signal and a telegram for dimming up ("Brighter") or dimming down ("Darker") with a long signal.

With single-area operation, the device sends switch-on and switch-off telegrams ("UM") alternately with a short signal and "Brighter" and "Darker" telegrams alternately with a long signal.

### 10.3.2 Dimming of colour temperature

When "Colour temperature control" is activated, only the colour temperature can be dimmed via an individual object.

- i** Even with "colour temperature control" activated, the brightness can be dimmed when using the combi object.

The "Dimming" function with the control of the colour temperature distinguishes between dual-area operation and single-area operation. The "Colour temperature when closing the contact" parameter defines the single- or dual-surface dimming principle.

dual-area operation	single-area operation
Colder (ON)	Colder / warmer (TOGGLE)
Warmer (OFF)	Colder (TOGGLE)
	Warmer (TOGGLE)

With dual-area operation, the device sends a telegram for switching on or off with a short signal and a telegram for dimming colder or dimming warmer with a long signal.

With single-area operation, the device sends switch-on and switch-off telegrams ("UM") alternately with a short signal and "Colder" and "Warmer" telegrams alternately with a long signal.

### 10.3.3 Dimming of brightness and colour temperature

If "colour temperature control" is activated, both the brightness and the colour temperature can be dimmed when using the combi object.

The "Dimming" function with the control of the brightness and colour temperature distinguishes between dual-area operation and single-area operation. The "Brightness + colour temperature when closing the contact" parameter defines the single- or dual-surface dimming principle.

dual-area operation	single-area operation
Brighter + colder (ON)	Brighter + colder / darker + warmer (TOGGLE)
Darker + warmer (OFF)	Brighter + colder (TOGGLE)
	Darker + warmer (TOGGLE)

With dual-area operation, the device sends a telegram for switching on or off with a short signal and a telegram for dimming brighter and colder or dimming darker and warmer with a long signal.

With single-area operation, the device sends switch-on and switch-off telegrams ("UM") alternately with a short signal and "Brighter + Colder" and "Darker + Warmer" telegrams alternately with a long signal.

### 10.3.4 Dimming parameters

Input... -> I... - Function

Debounce time (10...255 ms)	10...255
This parameter sets the debouncing time individually for the input. According to the time set here, the input signal at the input is evaluated with a delay.	
Colour temperature control	Checkbox (yes / no)
This parameter activates the variable colour temperature control and thus the Tunable White function if required. Additional parameters become visible.	
Communication	Individual objects Kombi object
When colour temperature control is activated, either the brightness or the colour temperature can be dimmed via an individual object. Alternatively, the brightness and the colour temperature can be controlled together via a combi object.	
Adjustment of	Brightness Colour temperature
For communication via individual objects, this parameter sets whether the brightness or the colour temperature is dimmed via the individual object.	
Brightness when closing the contact	no reaction Brighter (ON) Darker (OFF) <b>Brighter / darker (TOGGLE)</b> Brighter (TOGGLE) Darker (TOGGLE)
This parameter determines the reaction when the contact at the input is closed. If the device is to toggle on a brief signal, the corresponding switching objects of other sensors with the same function must be interlinked.	
This parameter is only visible if colour temperature control is deactivated or colour temperature control is active and communication is via a single object for brightness control.	

<p>Colour temperature when closing the contact</p>	<p>no reaction                  Colder (ON)                  Warmer (OFF)  <b>Colder / warmer (TOGGLE)</b>                  Colder (TOGGLE)                  Warmer (TOGGLE)</p>
<p>This parameter determines the reaction when the contact at the input is closed. If the device is to toggle on a brief signal, the corresponding switching objects of other sensors with the same function must be interlinked.</p> <p>This parameter is only visible if colour temperature control is active and communication is via a single object for controlling the colour temperature.</p>	
<p>Brightness + colour temperature when closing the contact</p>	<p>no reaction                  Brighter + colder (ON)                  Darker + warmer (OFF)  <b>Brighter + colder / darker + warmer (TOGGLE)</b>                  Brighter + colder (TOGGLE)                  Darker + warmer (TOGGLE)</p>
<p>This parameter determines the reaction when the contact at the input is closed. If the device is to toggle on a brief signal, the corresponding switching objects of other sensors with the same function must be interlinked.</p> <p>This parameter is only visible if colour temperature control is active and communication is via a combi object for controlling brightness and colour temperature.</p>	
<p>After bus voltage return</p>	<p><b>no reaction</b>                  Send ON telegram                  Send OFF telegram</p>
<p>At this point, the behaviour of the input after a device reset (bus voltage return, ETS programming operation) is defined. If a delay after bus voltage return is set for the inputs, the device will not carry out the reaction specified at this point until the delay has expired.</p> <p>no reaction: The device does not send a telegram for initialisation.</p> <p>Send ON telegram: The device sends an ON command for the input via the communication object "Switch".</p> <p>Send OFF telegram: The device sends an OFF command for the input via the communication object "Switch".</p>	
<p>Time between switching and dimming                  Seconds (0...50)</p>	<p>0 ... 50 s</p>
<p>This parameter determines how long a signal must last with a closed contact until a long signal is identified and a dimming telegram is triggered.</p> <p>Setting the seconds of time between switching and dimming.</p>	



Milliseconds (100...990)	100 ... <b>400</b> ... 990 ms
Setting the milliseconds of time between switching and dimming.	

Advanced parameters	Checkbox (yes / no)
At this point, the extended parameters of the dimming function can be activated and thus made visible, if required.	

Increase brightness by	1.5 % 3 % 6 % 12.5 % 25 % 50 % <b>100 %</b>
------------------------	---

This parameter sets the relative dimming level when the brightness is increased. On each new signal, the brightness is changed at maximum by the configured step width.  
 It is recommended that the device repeats the dimming telegrams automatically, particularly with a small dimming level (see "Telegram repetition").

Reduce brightness by	1.5 % 3 % 6 % 12.5 % 25 % 50 % <b>100 %</b>
----------------------	---

This parameter sets the relative dimming level when the brightness is reduced. On each new signal, the brightness is changed at maximum by the configured step width.  
 It is recommended that the device repeats the dimming telegrams automatically, particularly with a small dimming level (see "Telegram repetition").

Dimming colder by	1.5 % 3 % 6 % 12.5 % 25 % 50 % <b>100 %</b>
-------------------	---

This parameter sets the relative dimming step for cold dimming. On each new signal, the brightness is changed at maximum by the configured step width. It is recommended that the device repeats the dimming telegrams automatically, particularly with a small dimming level (see "Telegram repetition").

Dimming warmer by	1.5 % 3 % 6 % 12.5 % 25 % 50 % <b>100 %</b>
-------------------	---

This parameter sets the relative dimming step for dimming warmer. On each new signal, the brightness is changed at maximum by the configured step width. It is recommended that the device repeats the dimming telegrams automatically, particularly with a small dimming level (see "Telegram repetition").

Stop telegram	Checkbox (yes / no)
---------------	---------------------

If this parameter is activated, the device sends a telegram to stop the dimming process when the contact is opened.

Telegram repetition	Checkbox (yes / no)
---------------------	---------------------

At this point, the telegram repetition can be activated during dimming. With telegram repetition activated, the device cyclically sends relative dimming telegrams (in the parameterised step width) to the KNX if the button is pressed long.

Time between two telegrams	200 ms 300 ms 400 ms 500 ms 750 ms 1 s 2 s
----------------------------	--

This parameter defines the interval at which the dimming telegrams are automatically repeated in the telegram repetition mode. This parameter is only visible when telegram repetition is activated.

### 10.3.5 Dimming objects

Object no.	Function	Name	Type	DPT	Flag
486, 492, 498	Switching	Input... - Output	1-bit	1,001	C, R, -, T, A
1-bit object for transmission of switching telegrams (ON, OFF).					

Object no.	Function	Name	Type	DPT	Flag
487, 493, 499	Dimming brightness	Input... - Output	4-bit	3,007	C, R, -, T, A
4-bit individual object for sending relative dimming telegrams to adjust the brightness.					

Object no.	Function	Name	Type	DPT	Flag
489, 495, 501	Dimming colour temperature	Input... - Output	4-bit	3,007	C, R, -, T, A
4-bit object for sending relative dimming telegrams to adjust the colour temperature.					

Object no.	Function	Name	Type	DPT	Flag
487, 493, 499	Dimming brightness + colour temperature	Input... - Output	3 bytes	250,600	C, R, -, T, A
3-byte combination object for sending dimming telegrams for adjusting the brightness and the colour temperature in combination.					

Object no.	Function	Name	Type	DPT	Flag
488, 494, 500	Switching feedback	Input... - Input	1-bit	1,001	C, -, W, -, U
1-bit object for receiving feedback telegrams (ON, OFF) from other control points.					

## 10.4 Venetian blind

For each input whose function is set to "Venetian blind", the 1-bit objects "Short time operation" and "Long time operation" are available. The function distinguishes between dual-area operation (UP, DOWN) and single-area operation (TOGGLE). The "Command when closing the contact" parameter defines the single- or dual-area dimming principle.

dual-area operation	single-area operation
UP	TOGGLE
DOWN	

With dual-area operation, the device sends an UP or DOWN telegram when the contact closes according to the configuration. With single-area operation, the device switches the direction of travel for short- and long-term operation (UM) every time the contact closes on a long signal.

### Feedback

If the actuator can be controlled from several control points, a faultless single-area operation requires that the long time objects of the control elements are interlinked. The device would otherwise not be able to detect that the actuator has been addressed from another sensor, in which case it would have to be actuated twice during the next use in order to produce the desired reaction.

### Behaviour after bus voltage return

After a device reset (bus voltage return or ETS programming operation), the communication object "Long time operation" of an input can be initialised. For this, the "On bus voltage return" parameter should be configured to the required reaction. With the settings "DOWN" or "UP", telegrams are actively sent out on the KNX according to this specification.

- i** If a delay is set for the inputs after bus voltage return, the device only transmits the telegrams when the delay has elapsed.

### Operation concepts

For the control of Venetian blind, shutter, awning or similar drives, the device supports four operating concepts, for which the telegrams are transmitted in different time sequences. The device can therefore be used to operate a wide variety of drive configurations.

#### Operation concept "short – long – short"

In the operation concept "short – long – short", the device shows the following behaviour:

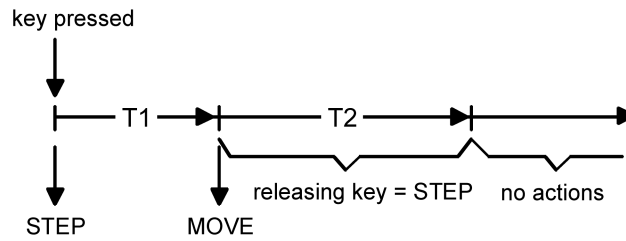

Image 30: Operation concept "short – long – short"

- Immediately when the contact closes, the device sends a short time telegram. Pressing the button stops a running drive and starts time T1 ("time between short time and long time command"). If the contact at the input is opened again within T1, no further telegram is sent. This short time serves the purpose of stopping a continuous movement. The "time between short and long time command" in the device should be selected shorter than the short-time operation of the actuator to prevent a jerky movement of the blind.
- If the signal at the input is longer than T1, the device transmits a long time telegram after the end of T1 for starting up the drive and time T2 ("slat adjusting time") is started.
- If the contact at the input is opened within the slat adjusting time, the device sends out another short time telegram. This function is used for adjusting the slats of a blind. The function permits stopping the slats in any position during their rotation. The "slat adjusting time" should be chosen as required by the drive for a complete rotation of the slats. If the "slat adjusting time" is selected longer than the complete running time of the drive, a push button function is possible as well. In this case, the drive only moves as long as the contact at the input is closed.
- If the signal at the input lasts longer than T2, the device does not send another telegram. The drive remains on until the end position is reached.

Operation concept "long – short":

In the operation concept "long – short", the device shows the following behaviour:

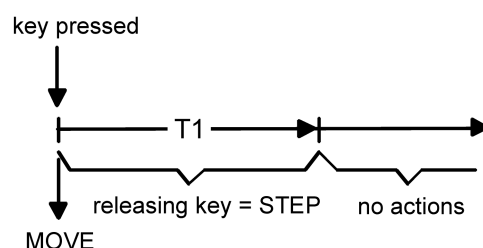

Image 31: Operation concept "long – short"

- Immediately when the contact closes, the device sends a long time telegram. The drive begins to move and time T1 ("slat adjusting time") is started.
- If the contact at the input is opened again within the slat adjusting time, the device sends out a short-time telegram. This function is used for adjusting the slats of a blind. The function permits stopping the slats in any position during their rotation. The "slat adjusting time" should be chosen as required by the drive for a com-

plete rotation of the slats. If the "slat adjusting time" is selected longer than the complete running time of the drive, a push button function is possible as well. In this case, the drive only moves as long as the contact at the input is closed.

- If the signal at the input lasts longer than T1, the device does not send another telegram. The drive remains on until the end position is reached.

Operation concept "short – long"

In the operation concept "short – long", the device shows the following behaviour:

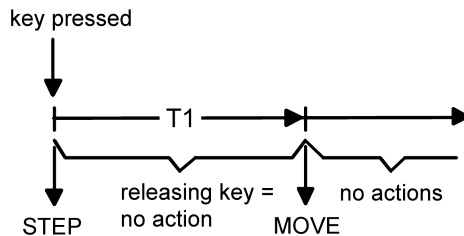

Image 32: Operation concept "short – long"

- Immediately when the contact closes, the device sends a short time telegram. Pressing the button stops a running drive and starts time T1 ("time between short time and long time command"). If the contact at the input is opened again within T1, the device does not send another telegram. This short time serves the purpose of stopping a continuous movement. The "time between short and long time command" in the device should be selected shorter than the short-time operation of the actuator to prevent a jerky movement of the blind.
- If the signal at the input lasts longer than T1, the device sends out a long term telegram to drive the actuator after T1 has elapsed.
- When the contact is opened, the device does not send another telegram. The drive remains on until the end position is reached.

Operation concept "long – short or short"

In the operation concept "long – short or short", the device shows the following behaviour:

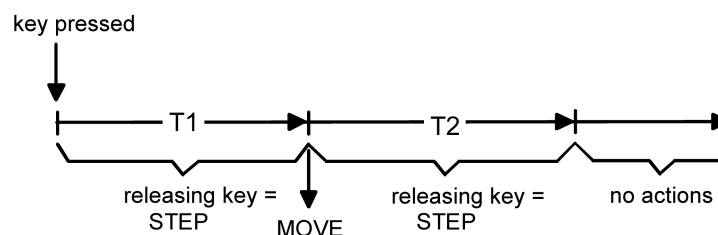

Image 33: Operation concept "long – short or short"

- Immediately on closing the contact, the device starts time T1 ("time between short time and long time command") and waits. If the contact at the input is opened again before T1 expires, the device sends a short time telegram. This telegram can be used to stop a running drive. A stationary drive rotates the slats by one level.

- If the signal at the input lasts longer than T1, the device sends a long term telegram and starts time T2 ("slat adjusting time").
- If the contact at the input is opened within T2, the device sends out another short-time telegram. This function is used for adjusting the slats of a blind. The function permits stopping the slats in any position during their rotation. The "slat adjusting time" should be chosen as required by the drive for a complete rotation of the slats. If the "slat adjusting time" is selected longer than the complete running time of the drive, a push button function is possible as well. In this case, the drive only moves as long as the contact at the input is closed.
- If the contact at the input remains closed longer than T2, the device does not send another telegram. The drive remains on until the end position is reached.

### 10.4.1 Shutter/blind parameters

Input... -> I... - Function

Debounce time (10...255 ms)	10...255
This parameter sets the debouncing time individually for the input. According to the time set here, the input signal at the input is evaluated with a delay.	
When closing the contact	UP DOWN TOGGLE
This parameter determines the direction of movement of the drive when closing the contact. If the setting is "TOGGLE", the direction is changed after each long time command. If several devices are to control the same drive, the long time objects of the devices must be interlinked to ensure that the running direction can be changed correctly.	
After bus voltage return	no reaction UP DOWN
At this point, the behaviour of the input after a device reset (bus voltage return, ETS programming operation) is defined. If a delay after bus voltage return is set for the inputs, the device will not carry out the reaction specified at this point until the delay has expired. no reaction: The device does not send a telegram for initialisation. DOWN: The device sends a shutdown command for the input via the communication object "Long term operation". UP: The device sends a open command for the input via the communication object "Long term operation".	
Operation concept	short – long – short long – short short – long long – short or short
For the control of Venetian blind, shutter, awning or similar drives, the device supports four operating concepts, for which the telegrams are transmitted in different time sequences. The device can therefore be used to operate a wide variety of drive configurations. At this point, the operating concepts can be selected.	



Time between short-time and long-time command Minutes (0...5)	0...5
<p>The time after which long term operation is evaluated when the contact closes is set here.</p> <p>Setting the minutes of time between short and long command.</p>	
Seconds (0...59)	0...59
<p>Setting the seconds of time between short and long command.</p>	
Milliseconds (100...990)	100...400...990
<p>Setting the milliseconds of time between short and long command.</p> <p>The parameters "Time between short and long command" are not visible with "Operating concept = Long - Short".</p>	
Slat adjusting time Minutes (0...5)	0...5
<p>Here you set the time during which an emitted short time telegram can be terminated by opening the contact. This function serves to adjust the slats of a blind.</p> <p>Setting the minutes of the slat adjusting time.</p>	
Seconds (0...59)	0...59
<p>Setting the seconds of the slat adjusting time.</p>	
Milliseconds (0...990)	0...500...990
<p>Setting the milliseconds of the slat adjusting time.</p> <p>The "Slat adjusting time" parameters are not visible with "Operating concept = Short - Long".</p>	

### 10.4.2 Shutter/blinds objects

Object no.	Function	Name	Type	DPT	Flag
516, 519, 522	Short time operation	Input... - Output	1-bit	1,007	C, R, -, T, A

1-bit object for the transmission of telegrams with which a Venetian blind or shutter drive motor can be stopped or with which the blind slats can be adjusted by short time operation.

Object no.	Function	Name	Type	DPT	Flag
517, 520, 523	Long-time operation	Input... - Output	1-bit	1,008	C, (R), W, T, A

1-bit object for the transmission of telegrams with which a Venetian blind or shutter drive motor can be moved upwards or downwards.

## 10.5 Value transmitter

With the "Value transmitter" function, the device sends parameterised values to the KNX when the contact at the input closes. The value transmitter distinguishes between different value ranges depending on the data format. Depending on the application, the parameters "Function" and "Value range" determine which value range the value transmitter uses.

Function	Value range	Range end below	Range end top
1-byte value transmitter	0...255	0	255
1-byte value transmitter	0...100%	0%	100%
1-byte value transmitter	-128...127	-128	127
1-byte value transmitter	0...255%	0%	255%
1-byte value transmitter	0...360°	0°	360°
2-byte value transmitter	0...65535	0	65535
2-byte value transmitter	-32768...32767	-32768	32767
2-byte value transmitter	Temperature value	0 °C	40 °C
2-byte value transmitter	brightness value	0 lux	1500 lux
2-byte value transmitter	Colour temperature value	1000 K	10000 K
3-byte value transmitter	RGB/HSV with colour wheel sequence	#000000	#FFFFFF
3-byte value transmitter	RGB/HSV with brightness adjustment	#000000	#FFFFFF
6-byte value transmitter	Colour value RGBW/HSVW	#000000 + 0	#FFFFFF + 255
6-byte value transmitter	Colour temperature value + brightness	1000 K   0 %	10000 K   100 %

### Behaviour after bus voltage return

The communication object of an input for sending the value can be initialised after a device reset (bus voltage return or ETS programming operation). For this, the "On bus voltage return" parameter should be configured to the required reaction. With the setting "Reaction as when closing the contact", the device sends out the configured values.

- i** If a delay is set for the inputs after bus voltage return, the device only transmits the telegrams when the delay has elapsed.

**Value adjustment**

If the value adjustment is activated in the ETS, the contact at the input for adjusting the value must remain closed for longer than the parameterised time period. The value adjustment function continues until the contact is opened again.

- With the 1 byte and 2 byte value transmitter functions the value is adjusted across the entire number range.
- With the 3 byte value transmitter function in the function RGB/HSV with colour wheel adjustment, the colour hue (H) is adjusted in the range from 0 to 360°.
- With the 3 byte value transmitter function in the RGB / HSV function with brightness adjustment, the brightness value (V) is adjusted in the range from 0 to 100%.

With the activation of the "Value adjustment" parameter, further parameters become visible in the ETS, whereby the value adjustment can be configured.

- i** For the value transmitter 1 byte with the value range "0...100%", the step width of the value adjustment is also specified in "%". If the starting value of the communication object is used, it may happen in this case during value adjustment that the value last received via the object must be rounded and adapted before a new value can be calculated on the basis of the step width and transmitted. Due to the computation procedure used, the new calculation of the value may be slightly inaccurate.

- i** The value adjustment is not available with the "6 byte" mode of operation.

**Example 1: Value adjustment without overflow**

- Mode of operation and value range = 1 byte (0...255)
- Value = 227
- Step width = 5
- Starting value on value adjustment = same as configured value
- Direction of value adjustment = toggling (alternating)
- Time between two telegrams = 0.5 s

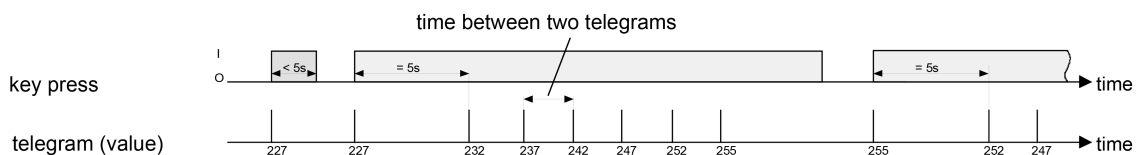

Image 34: Example of value adjustment without value range overflow

**Example 2: Value adjustment with overflow**

- Mode of operation and value range = Value transmitter 1 byte (0...255)
- Value = 227

**Example 2: Value adjustment with overflow**

- Step width = 5
- Starting value on value adjustment = same as configured value
- Direction of value adjustment = toggling (alternating)
- Time between two telegrams = 0.5 s

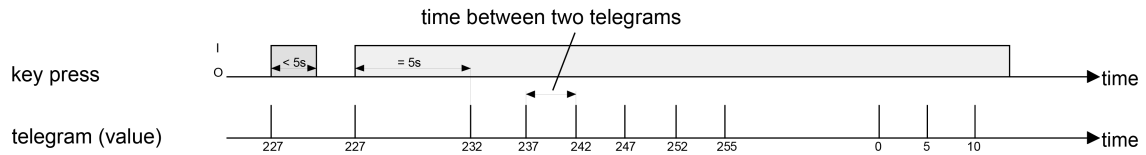

Image 35: Example of value adjustment with value range overflow

**i** The newly adjusted values are stored in non-volatile memory. The stored values are thereby replaced by the preset values programmed in the ETS when a reset of the device occurs (bus voltage failure or ETS programming).

### 10.5.1 1-byte value transmitter

The 1-byte value transmitter is available in the following four variants:

- 0 ... 255
- 0 ... 100%
- -128 ... 127
- 0 ... 255%
- 0 ... 360°

For each input, an object is available in the ETS for sending out the parameterised value. When the contact closes, the parameterised value is sent out on the KNX.

### 10.5.2 2-byte value transmitter

The 2-byte value transmitter is available in the following five variants:

- 0 ... 65535
- -32768 ... 32767
- Temperature value (0 ... 40 °C)
- Brightness value (0, 50, ..., 1500 lux)
- Colour temperature value (1000, 1100, ..., 10000)

For each input, an object is available in the ETS for sending out the parameterised value. When the contact closes, the parameterised value is sent out on the KNX.

### 10.5.3 3-byte value transmitter

The 3-byte value transmitter is available in the following variant:

- RGB/HSV with colour wheel sequence
- RGB/HSV with brightness adjustment

Objects for sending the parameterised values are available in the ETS for each input. When the contact closes, the parameterised values are sent out on the KNX. The colour circle run and the brightness adjustment are realised by a value adjustment.

Communication takes place via a 3-byte combination object according to DPT 232.600 in the RGB colour space or via three 1-byte individual objects in the HSV colour space. All four communication objects are displayed in the object overview. The object values to be sent out are parameterised via a colour picker in the ETS.

#### Value adjustment with colour wheel sequence

The colour wheel sequence performs a value adjustment of the colour angle (H) in the range from 0 to 360°.

- i** For the colour space "RGB", an adjustment of the colour angle (H) is converted internally in the device.

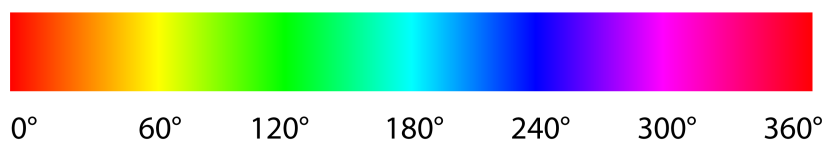

Image 36: Colour scale (Colour hue H)

The colour wheel sequence is realised according to the direction of the value adjustment and the step width via KNX telegrams. During a colour wheel sequence, the device cyclically sends new values to the KNX, whereby the colour wheel is continuously run through. The colour hue (H) changes cyclically by the parameterised step width. The saturation (S) and the brightness value (V) remain unaffected by a colour pass. Depending on the start position at the beginning of the adjustment, the values R, G or B change cyclically.

Using the colour picker of the ETS, the colour wheel sequence can be traced by adjusting the slider of the H value from 0° to 360°.

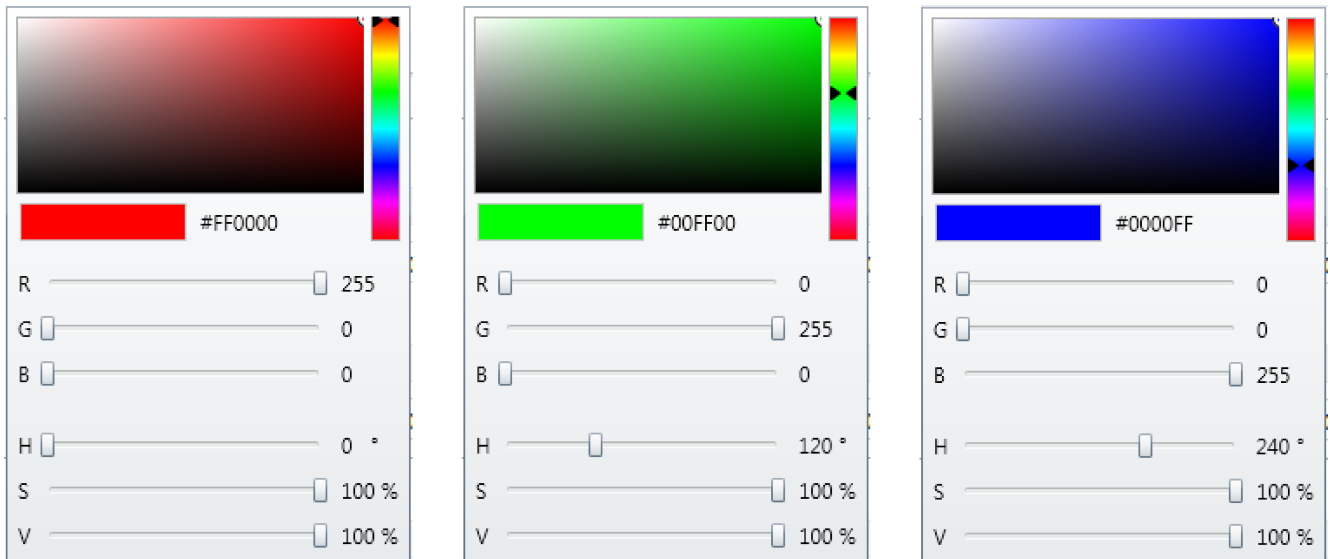

Image 37: Examples of colour adjustment using the ETS colour picker

Examples of HSV-RGB conversion:

Example	HSV - Values	RGB - Values	Colour
1	0°, 100%, 100%	255, 0, 0	Red
2	120°, 100%, 100%	0, 255, 0	Green
3	240°, 100%, 100%	0, 0, 255	Blue
4	360°, 0%, 100%	255, 255, 255	White
5	360°, 0%, 0%	0, 0, 0	Black

- i** With "Saturation (S) = 0%" and "Brightness (V) = 100%", a change in the colour hue (H) has no effect on the RGB values and thus no effect on the colour.
- i** With "Saturation (S) = 0%" and "Brightness (V) = 0%", a change in the colour hue (H) has no effect on the RGB values and thus no effect on the colour.

### Value adjustment with brightness adjustment

The brightness adjustment performs a value adjustment of the brightness value (V) in the range from 0 to 100%.

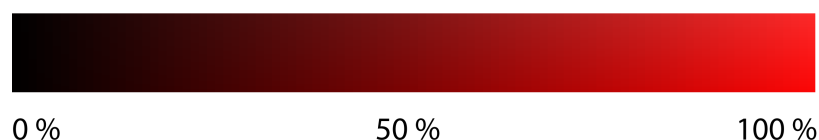

Image 38: Brightness scale (brightness value V) - example red

The brightness adjustment is realised according to the direction of the value adjustment and the step width via KNX telegrams. When adjusting the brightness, the device cyclically sends new values to the KNX, which continuously changes the brightness.



- i** The brightness adjustment ends automatically either when the brightness is increased at 100% or when the brightness is decreased at 0%. The brightness value (V) changes cyclically by the parameterised step width. The colour hue (H) and the saturation (S) remain unaffected by a brightness adjustment. Depending on the start position at the beginning of the adjustment, the values R, G or B change cyclically.

Using the colour picker of the ETS, the brightness adjustment can be reproduced by adjusting the slider of the V-value from 0% to 100%.

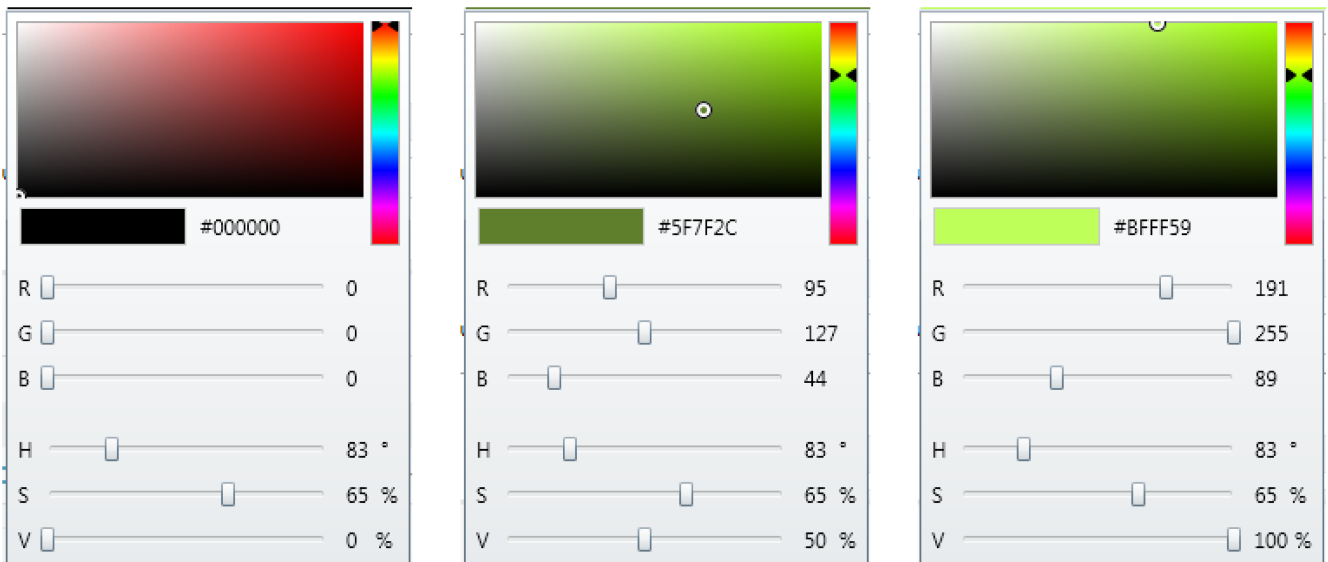

Image 39: Examples of brightness adjustment using the colour picker of the ETS

Examples of HSV-RGB conversion:

Example	HSV - Values	RGB - Values	Colour
1	83°, 65%, 0%	0, 0, 0	Black
2	83°, 65%, 50%	95, 127, 44	Dark green
3	83°, 65%, 100%	191, 255, 89	Light green

- i** With "Brightness value (V) = 0%", a change in the colour angle (H) or saturation (S) has no effect on the RGB values and thus no effect on the colour.

### 10.5.4 6-byte value transmitter

The 6-byte value transmitter is available in the following two variants:

- Colour value RGBW/HSVW
- Colour temperature value + brightness

Objects for sending the parameterised values are available in the ETS for each input. When the contact closes, the parameterised values are sent out on the KNX.

With the value range "Colour value RGBW/HSVW", the colour space of this function can be defined in the parameters. The object values RGB or HSV to be transmitted are parameterised via a colour picker in the ETS. The object value for the white component (W) is configured via a separate slider.

Communication takes place in the RGBW colour space via a 6-byte combination object according to DPT 251.600 and in the HSVW colour space via four 1-byte individual objects. All five communication objects are displayed in the object overview.

For the value range "Colour temperature value + brightness", the object values to be transmitted for colour temperature and brightness as well as a time window are defined in the parameters. The device combines all three pieces of information together in one communication object according to DPT 249.600 and sends them to the KNX. The receiving actuator converts this information and sets the colour temperature and brightness in the parameterised time window.

### 10.5.5 Value transmitter parameters

Input... -> I... - Function

Debounce time (10...255 ms)	<b>10...255</b>
This parameter sets the debouncing time individually for the input. According to the time set here, the input signal at the input is evaluated with a delay.	
Function	No function <b>1 bytes</b> 2 bytes 3 bytes 6 bytes
At this point, the functionality of the encoder is defined.	
Value range	<b>0...255</b> 0...100% -128...127 0...255% 0...360°
The 1-byte value transmitter offers these value ranges for setting. The other parameters and objects of the function are based on the setting of this parameter.	
Value range	<b>0...65535</b> -32768...32767 Temperature value brightness value Colour temperature value
The 2-byte value transmitter offers these value ranges for setting. The other parameters and objects of the function are based on the setting of this parameter.	
Value range	<b>RGB/HSV with colour wheel sequence</b> RGB/HSV with brightness adjustment
The 3-byte value transmitter offers these value ranges for setting. The other parameters and objects of the function are based on the setting of this parameter.	
Value range	<b>Colour value RGBW/HSVW</b> Colour temperature value + brightness
The 6-byte value transmitter offers these value ranges for setting. The other parameters and objects of the function are based on the setting of this parameter.	
Value when closing the contact (0...255)	<b>0...255</b>
This parameter determines the object value when closing the contact. It is only visible with "Function = 1 byte" and "Value range = 0...255".	

Value when closing the contact (0...100 %)	0...100
This parameter determines the object value when closing the contact. This parameter is only visible if "Function = 1-byte" and "Value range = 0...100%".	
Value when closing the contact (-128...127)	-128...0...127
This parameter determines the object value when closing the contact. This parameter is only visible if "Function = 1-byte" and "Value range = -128...127%".	
Value when closing the contact (0...255%)	0...255
This parameter determines the object value when closing the contact. This parameter is only visible if "Function = 1-byte" and "Value range = 0...255%".	
Value when closing the contact (0...360°)	0...360
This parameter determines the object value when closing the contact. It is only visible if "Function = 0...360%".	
Value when closing the contact (0...65535)	0...65535
This parameter determines the object value when closing the contact. This parameter is only visible if "Function = 2-byte" and "Value range = 0...65535%".	
Value when closing the contact (-32768...32767)	-32768...0...32767
This parameter determines the object value when closing the contact. This parameter is only visible if "Function = 2-byte" and "Value range = -32768...32767%".	
Temperature value when closing the contact (0...40 °C)	0...20...40
This parameter determines the object value when closing the contact. This parameter is only visible if "Function = 2-byte" and "Value range = temperature value".	
Brightness value when closing the contact (0, 50, ..., 1500 Lux)	0, 50, ..., 300, ..., 1500
This parameter determines the object value when closing the contact. This parameter is only visible if "Function = 2-byte" and "Value range = brightness value".	
Colour temperature value when closing the contact (1000, 1100, ..., 10000 K)	1000, 1100, ..., 2700, ..., 10000
This parameter determines the object value when closing the contact. This parameter is only visible if "Function = 2-byte" and "Value range = temperature value".	

Colour value when closing the contact (RGB/HSV)	#000000 ... #FFFFFF
<p>This parameter determines the object values of the objects Value transmitter 3 byte and Value transmitter 6 byte, Brightness value (V), Saturation (S) and Colour hue (H) when closing the contact. It is visible for "Function = 3 byte RGB/HSV with colour wheel sequence", "Function = 3 byte RGB/HSV with brightness adjustment" and "6 byte RGBW/HSVW".</p>	
White level (W)	0...255
<p>This parameter determines the value of the White value (W) object when the contact closes. Visible only if "Function = 6 byte RGBW/HSVW".</p>	
Colour temperature value (1000, 1100, ..., 10000 K)	1000, 1100, ..., 2700, ..., 10000
<p>This parameter determines the colour temperature of the object value when the contact closes. It is only visible with "Function = 6 bytes" and "Value range = colour temperature value + brightness".</p>	
brightness value (0...100%)	0...100
<p>This parameter determines the brightness of the object value when the button is pressed. It is only visible with "Function = 6 bytes" and "Value range = colour temperature value + brightness".</p>	
Time frame (0...100 minutes)	0...100
<p>This parameter determines the time period in which the actuator adjusts the colour temperature and brightness after the contact is closed. It is only visible with "Function = 6 bytes" and "Value range = colour temperature value + brightness".</p> <p>Setting the minutes of the time window.</p>	
(0...59 seconds)	0...1...59
<p>Setting the seconds of the time window.</p>	
(0...900 milliseconds)	0...900
<p>Setting the milliseconds of the time window.</p>	
After bus voltage return	no reaction Reaction as when closing the contact
<p>At this point, the behaviour of the input after a device reset (bus voltage return, ETS programming operation) is defined. If a delay after bus voltage return is set for the inputs, the device will not carry out the reaction specified at this point until the delay has expired.</p> <p>no reaction: The device does not send a telegram for initialisation.</p> <p>Reaction as when closing the contact: When closing the contact, the device sends out the configured values.</p>	

Value adjustment	Checkbox (yes / no)
<p>This parameter optionally enables the value adjustment.</p> <p><b>i</b> The value adjustment is not available with the "6 byte" mode of operation.</p>	
Starting value in case of value adjustment	<p>same as configured value</p> <p>Same as value after last adjustment</p> <p><b>Same as value from communication object</b></p>
<p>Value adjustment can begin with different starting values. This parameter is visible only if the value adjustment is enabled! The selection is only available for the 1-byte and 2-byte modes.</p> <p>Same as parameterised value: After each long press, the device always starts with the value configured in the ETS.</p> <p>Same as value after last adjustment: After a long press, the device starts with the value transmitted by itself or by another device with this group address as the last value.</p> <p>Same as value from communication object: After a long press, the device starts with the value transmitted by itself or by another device with this group address as the last value.</p>	
Starting value in case of value adjustment	<p>same as configured value</p> <p>Same as value after last adjustment</p> <p><b>same as value from feedback object (1-byte colour hue/H-value)</b></p> <p>as value from feedback object (3-byte RGB)</p>
<p>Value adjustment can begin with different starting values. This parameter is visible only if the value adjustment is enabled! The selection is only available with the 3-byte RGB/HSV mode of operation with colour wheel scrolling.</p> <p>Same as parameterised value: After each long press, the device always starts with the value configured in the ETS.</p> <p>Same as value after last adjustment: After a long press, the device starts with the value transmitted by itself or by another device with this group address as the last value.</p> <p>Same as value on feedback object (1-byte colour hue/H-value): After a long press, the device starts with the value transmitted by itself or by another device with this group address as the last value.</p> <p>Same as value from feedback object (3-byte RGB): After a long press, the device starts with the value transmitted by itself or by another device with this group address as the last value.</p>	

Starting value in case of value adjustment	same as configured value Same as value after last adjustment <b>same as value on feedback object (1-byte brightness/V-value)</b> as value from feedback object (3-byte RGB)
<p>Value adjustment can begin with different starting values. This parameter is visible only if the value adjustment is enabled! The selection is only available with the 3-byte RGB/HSV function with brightness adjustment.</p> <p>Same as parameterised value: After each long press, the device always starts with the value configured in the ETS.</p> <p>Same as value after last adjustment: After a long press, the device starts with the value transmitted by itself or by another device with this group address as the last value.</p> <p>Same as value on feedback object (1-byte brightness/V-value): After a long press, the device starts with the value transmitted by itself or by another device with this group address as the last value.</p> <p>Same as value from feedback object (3-byte RGB): After a long press, the device starts with the value transmitted by itself or by another device with this group address as the last value.</p>	
Direction of value adjustment	upwards downwards <b>toggleing (alternating)</b>
<p>The device can either always adjust the values in the same direction when there is a long signal at the input, or it stores the direction of the last adjustment and reverses it when there is a new signal at the input. This parameter is visible only if the value adjustment is enabled! The selection is only available for the 1-byte and 2-byte modes.</p>	
Direction of the colour sequence	Colour sequence in clockwise direction (red -> green -> blue -> red -> ...) Colour sequence in anti-clockwise direction (red -> blue -> green -> red -> ...) <b>Toggleing colour sequence (alternating whenever a button is pressed for a longer period of time)</b>
<p>The device can either always adjust the values in the same direction when there is a long signal at the input, or it stores the direction of the last adjustment and reverses it when there is a new signal at the input. This parameter is visible only if the value adjustment is enabled! The selection is only available with the 3-byte RGB/HSV mode of operation with colour wheel scrolling.</p>	

Direction of the brightness adjustment	brighter <b>darker</b> toggling (alternating)
<p>The device can either always adjust the values in the same direction when there is a long signal at the input, or it stores the direction of the last adjustment and reverses it when there is a new signal at the input. This parameter is visible only if the value adjustment is enabled! The selection is only available with the 3-byte RGB/HSV function with brightness adjustment.</p>	
Step width	1...15
<p>In a value adjustment, the device determines the new telegram value from the previous value and the preset step width. If the lower limit of the adjustment range is not reached or the upper limit is exceeded, the device automatically adjusts the step size for the last step.</p> <p>This parameter is only visible when value adjustment is enabled and is only available with the following functions: 1 byte (0...255), 1 byte (0...100%), 1 byte (-128...127), 1 byte (0...255%) and 1 byte (0...360°).</p>	
Step width	1, 2, 5, 10, 20, 50, 75, 100, 200, 500, 750, 1000
<p>In a value adjustment, the device determines the new telegram value from the previous value and the preset step width. If the lower limit of the adjustment range is not reached or the upper limit is exceeded, the device automatically adjusts the step size for the last step.</p> <p>This parameter is only visible when value adjustment is enabled and is only available with the following functions: 2 bytes (0...65535) and 2 bytes (-32768...32767).</p>	
Step width	1
<p>With the 2-byte temperature value transmitter, the step size of the value adjustment is always set to "1°C" and cannot be changed.</p> <p>This parameter is only visible with enabled value adjustment and only available with the following mode of operation: 2-byte temperature value.</p>	
Step width (1...1000 K)	1, 10, 20, ..., 500, ..., 1000
<p>In a value adjustment, the device determines the new telegram value from the previous value and the preset step width. If the lower limit of the adjustment range is not reached or the upper limit is exceeded, the device automatically adjusts the step size for the last step.</p> <p>This parameter is only visible with enabled value adjustment and only available with the following function: 2-byte colour temperature value.</p>	



Step width	<b>50</b>
<p>With the 2-byte brightness value transmitter, the step size of the value adjustment is always set to "50 lux" and cannot be changed.</p> <p>This parameter is only visible with enabled value adjustment and only available with the following function: 2-byte brightness value.</p>	
Step width	<b>1°, 2°, 4°, 5°, 10°, 20°, 25°, 30°, 50°, 60°</b>
<p>In a value adjustment, the device determines the new telegram value from the previous value and the preset step width. If the lower limit of the adjustment range is not reached or the upper limit is exceeded, the device automatically adjusts the step size for the last step.</p> <p>This parameter is only visible when the value adjustment is enabled and is only available with the following modes of operation: 3-byte RGB/HSV with colour circle run-through.</p>	
Step width	<b>1...15</b>
<p>In a value adjustment, the device determines the new telegram value from the previous value and the preset step width. If the lower limit of the adjustment range is not reached or the upper limit is exceeded, the device automatically adjusts the step size for the last step.</p> <p>This parameter is only visible with enabled value adjustment and only available with the following function: 3-byte RGB/HSV with brightness adjustment.</p>	
Time period until the start of value adjustment	<b>0.5 s</b> 1 s 2 s 3 s <b>5 s</b>
<p>This parameter determines the time from which the device starts the value adjustment after the contact is closed.</p> <p>This parameter is visible only if the value adjustment is enabled!</p>	
Time between two telegrams	<b>0.5 s</b> 1 s 2 s 3 s
<p>This parameter defines the interval at which the device transmits new telegrams during a value adjustment.</p> <p>This parameter is visible only if the value adjustment is enabled!</p>	

Value adjustment with overflow	Checkbox (yes / no)
<p>If the value adjustment is to take place without overflow (parameter deactivated) and the device reaches the lower limit of the adjustment range or the upper limit during the value adjustment, it ends the value adjustment automatically.</p> <p>If the value adjustment is to be made with overflow (parameter activated) and the device reaches the lower or upper range limit, it sends the value of this range limit and then inserts a pause whose duration corresponds to two steps. Thereafter, the device transmits a telegram with the value of the other range limit and continues the value adjustment in the same direction.</p>	

### 10.5.6 Value transmitter objects

Object no.	Function	Name	Type	DPT	Flag
531, 543, 555	Value transmitter 0...255	Input... - Output	1 bytes	5,010	C, (R), W, T, A

1-byte object for transmitting values from 0 to 255.

- i** These objects are only visible when:
- "Function = 1 bytes" and
  - "Value range: 0...255"

Object no.	Function	Name	Type	DPT	Flag
531, 543, 555	Value transmitter 0...100 %	Input... - Output	1 bytes	5,001	C, (R), W, T, A

1-byte object for transmitting values from 0 to 100%.

- i** These objects are only visible when:
- "Function = 1 bytes" and
  - "Value range: 0...100%"

Object no.	Function	Name	Type	DPT	Flag
531, 543, 555	Value transmitter -128...127	Input... - Output	1 bytes	6,010	C, (R), W, T, A

1-byte object for transmitting values from -128 to 127.

- i** These objects are only visible when:
- "Function = 1 bytes" and
  - "Value range: -128...127"

Object no.	Function	Name	Type	DPT	Flag
531, 543, 555	Value transmitter 0...255 %	Input... - Output	1 bytes	5,004	C, (R), W, T, A

1-byte object for transmitting values from 0 to 255%.

- i** These objects are only visible when:
- "Function = 1 bytes" and
  - "Value range: 0...255%"

Object no.	Function	Name	Type	DPT	Flag
531, 543, 555	Value transmitter 0...360°	Input... - Output	1 bytes	5,003	C, (R), W, T, A

1-byte object for transmitting values from 0 to 360°.

- i** These objects are only visible when:
- "Function = 1 bytes" and
  - "Value range: 0...360°"

Object no.	Function	Name	Type	DPT	Flag
531, 543, 555	Value transmitter 0...65535	Input... - Output	2 bytes	7,001	C, (R), W, T, A

2-byte object for transmitting values from 0 to 65535.

- i** These objects are only visible when:
- "Function = 2 bytes" and
  - "Value range: 0...65535"

Object no.	Function	Name	Type	DPT	Flag
531, 543, 555	Value transmitter -32768...32767	Input... - Output	2 bytes	8,001	C, (R), W, T, A

2-byte object for transmitting values from -32768 to 32767.

- i** These objects are only visible when:
- "Function = 2 bytes" and
  - "Value range: -32768...32767"

Object no.	Function	Name	Type	DPT	Flag
531, 543, 555	Temperature value transmitter	Input... - Output	2 bytes	9,001	C, (R), W, T, A

2-byte object for transmitting temperature values from 0 to 40 °C.

- i** These objects are only visible when:
- "Function = 2 bytes" and
  - "Value range = temperature value"

Object no.	Function	Name	Type	DPT	Flag
531, 543, 555	Brightness value transmitter	Input... - Output	2 bytes	9,004	C, (R), W, T, A

2-byte object for transmitting brightness values from 0 to 1500 Lux.

- i** These objects are only visible when:
- "Function = 2 bytes" and
  - "Value range = brightness value"

Object no.	Function	Name	Type	DPT	Flag
531, 543, 555	Colour temperature value transmitter	Input... - Output	2 bytes	7,600	C, (R), W, T, A

2-byte object for transmitting colour temperature values from 1000 to 10000 Kelvin.

- i** These objects are only visible when:
- "Function = 2 bytes" and
  - "Value range = colour temperature value"

Object no.	Function	Name	Type	DPT	Flag
531, 543, 555	Value transmitter 3 bytes (colour wheel sequence)	Input... - Output	3 bytes	232,600	C, R, -, T, A
3-byte object for transmitting 3-byte colour information.					
<p><b>i</b> These objects are only visible if function: 3-byte RGB/HSV with colour wheel sequence.</p>					
531, 543, 555	Value transmitter 3-byte (brightness adjustment)	Input... - Output	3 bytes	232,600	C, R, -, T, A
3-byte object for transmitting 3-byte colour information.					
<p><b>i</b> These objects are only visible if function: 3-byte RGB/HSV with brightness adjustment.</p>					
531, 543, 555	6-byte value transmitter	Input... - Output	6 bytes	251,600	C, R, -, T, A
6-byte object for transmitting 6-byte colour information.					
<p><b>i</b> These objects are only visible if function: 6-byte RGBW/HSVW.</p>					
532, 544, 556	Colour hue (H)	Input... - Output	1 bytes	5,003	C, R, -, T, A
1-byte object for transmitting the colour hue.					
<p><b>i</b> These objects are only visible if functions:</p> <ul style="list-style-type: none"> <li>- 3-byte RGB/HSV with colour wheel sequence</li> <li>- 3-byte RGB/HSV with brightness adjustment</li> <li>- 6-byte RGBW/HSVW</li> </ul>					
533, 545, 557	Saturation (S)	Input... - Output	1 bytes	5,001	C, R, -, T, A
1-byte object for transmitting the saturation.					
<p><b>i</b> These objects are only visible if functions:</p> <ul style="list-style-type: none"> <li>- 3-byte RGB/HSV with colour wheel sequence</li> <li>- 3-byte RGB/HSV with brightness adjustment</li> <li>- 6-byte RGBW/HSVW</li> </ul>					

Object no.	Function	Name	Type	DPT	Flag
534, 546, 558	Brightness (V)	Input... - Output	1 bytes	5,001	C, R, -, T, A

1-byte object for transmitting the brightness value.

- i** These objects are only visible if functions:
- 3-byte RGB/HSV with colour wheel sequence
  - 3-byte RGB/HSV with brightness adjustment
  - 6-byte RGBW/HSVW

Object no.	Function	Name	Type	DPT	Flag
535, 547, 559	White level (W)	Input... - Output	1 bytes	5,001	C, R, -, T, A

1-byte object for transmitting the white level.

- i** These objects are only visible if function: 6-byte RGBW/HSVW.

Object no.	Function	Name	Type	DPT	Flag
537, 549, 561	Feedback brightness value (V)	Input... - Input	1 bytes	5,001	C, (R), W, -, A

1-byte object for receiving the brightness value.

- i** These objects are only visible with the following configuration:
- "Function" parameter = 3-byte RGB/HSV with brightness adjustment
  - "Starting value of value adjustment" parameter = same as value from feedback object (1-byte brightness/V-value)

Object no.	Function	Name	Type	DPT	Flag
537, 549, 561	Feedback colour hue (H)	Input... - Input	1 bytes	5,003	C, (R), W, -, A

1-byte object for receiving the colour hue.

- i** These objects are only visible with the following configuration:
- "Function" parameter = 3-byte RGB/HSV with colour wheel sequence
  - "Starting value of value adjustment" parameter = same as value from feedback object (1-byte/colour hue/H-value)

Object no.	Function	Name	Type	DPT	Flag
537, 549, 561	Value transmitter feedback RGB	Input... - Input	3 bytes	232,600	C, (R), W, -, A

3-byte object for receiving 3-byte colour information.

- i** These objects are only visible with the following configuration:
- The "Function" parameter" = 3-byte RGB/HSV with colour wheel sequence or 3 byte RGB/HSV with brightness adjustment and
  - "Starting value of value adjustment" parameter = same as value from feedback object (3-byte RGB)

Object no.	Function	Input... - Output	Type	DPT	Flag
531, 543, 555	Colour temperature value transmitter + brightness	Input... - Output	6 bytes	249,600	C, R, -, T, A

6-byte object for sending the time window, colour temperature and brightness.

- i** These objects are only visible when:
- "Function = 6 bytes" and
  - "Value range = colour temperature value + brightness".

## 10.6 Scene extension

For each input whose function is set to "Scene extension device", a 1-byte communication object is available according to DPT 18.001. The "Function" parameter defines the specific operating function:

- "Scene extension without storage function",
- "Scene extension with storage function",

In the function as a scene extension, the device sends a preset scene number (1...64) to the KNX via the communication object when the contact at the input closes. This feature permits recalling scenes stored in other devices and also storing them, if the storage function is used.

### Function for the setting "... Scene extension without storage function":

Closing the contact leads to easy retrieval of the scene. A long signal at the input has no further effect.

### Function for the setting "... Scene extension with storage function":

Closing the contact with a signal length shorter than one second results in easy recall of the scene. If the signal at the input lasts longer than five seconds, the device generates a save command. In the scene extension function, a storage telegram is in this case transmitted to the KNX.

- i** A signal at the input with a time length between one and five seconds is rejected as invalid.



### 10.6.1 Scene extension parameters

Input... -> I... - Function

Debounce time (10...255 ms)	10...255
This parameter sets the debouncing time individually for the input. According to the time set here, the input signal at the input is evaluated with a delay.	
Function	<b>Scene extension without storage function</b> Scene extension with storage function
A signal at the input with a time length between one and five seconds is rejected as invalid.  Scene extension without storage function: Closing the contact leads to simple retrieval of the scene. A long signal at the input has no further effect.  Scene extension with storage function: Closing the contact with a signal length shorter than one second results in easy recall of the scene. If the signal at the input lasts longer than five seconds, the device generates a save command. In the scene extension function, a storage telegram is in this case transmitted to the KNX.	
Scene number when closing the contact (1 ... 64)	1...64
In accordance with the KNX standard, objects with data type 18.001 can retrieve or store up to 64 scenes by their numbers. The parameter defines the scene number to be transmitted when the contact is closed.	

### 10.6.2 Scene extension objects

Object no.	Function	Name	Type	DPT	Flag
592, 595, 598	Scene extension	Input... - Output	1 bytes	18,001	C, R, -, T, A
1-byte object for recalling or storing one of max. 64 external KNX scenes.					

## 10.7 2-channel operation

The "2-channel operation" function allows two function channels to be operated with only one input. This makes it possible to carry out two different functions with one contact and to send different types of telegrams.

For the two channels, the parameters "Function channel 1" and "Function channel 2" can be used independently of each other to determine which data formats the operating function uses in each case. The following functions are available:

- 1-bit switching
- Value transmitter 1 byte (0...255)
- Value transmitter 1 byte (0...100%)
- Value transmitter 1 byte (-128...127)
- Value transmitter 1 byte (0...255%)
- Value transmitter 1 byte (0 ... 360 °)
- Value transmitter 2 byte (0...65535)
- Value transmitter 2 byte (-32768...32767)
- Value transmitter 2-byte temperature value
- Value transmitter 2-byte brightness value
- Value transmitter 2 byte colour temperature value
- Value transmitter 3 byte colour value RGB/HSV
- Value transmitter 6 byte colour value RGBW/HSVW
- Value transmitter 6 byte colour temperature value + brightness
- Recalling scene (external)

Depending on the set function, the value command that the device sends to the KNX when the contact closes can be individually parameterised in the ETS. With "1 bit switching" it can be set whether an ON or OFF telegram is to be sent. Alternatively, the object value can be switched and sent at "UM".

With parameterization as a value transmitter "1 byte ..." or "2 byte ..." it is possible to select the object value within the intended value range. When used as a colour value transmitter "3 Byte..." the object values can be set according to RGB or HSV via a colour picker. With the colour value transmitter "6 byte..." the object values RGB or HSV are configured via a colour picker and the white value "W" via a slider.

When used as a value transmitter "6 byte colour temperature value + brightness", the object values colour temperature and brightness as well as a time window can be specified. With "Call scene (external)", the scene number is set which is to be sent out on the KNX when the contact closes.

The "Operation concept" parameter determines whether both channels or only one channel at a time sends the configured telegram when the contact closes.

**Operation concept channel 1 or channel 2**

With this operation concept, exactly one telegram is sent each time the contact is closed.

- With a short signal, the device only sends the telegram for channel 1.
- If the signal is long, the device only sends the telegram for channel 2.

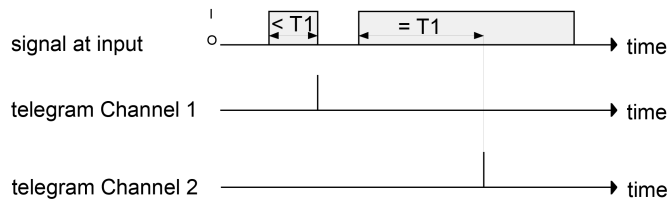

Image 40: Example of operation concept "Channel 1 or Channel 2"

The time duration (T1) for distinguishing between a short and a long signal is determined by the parameter "Time between channel 1 and channel 2". If the signal is shorter than the parameterised time, only the telegram to channel 1 is sent when the contact is opened. If the signal is longer, only the telegram to channel 2 is sent after time T1 has elapsed. This concept provides the transmission of only one channel.

**Operation concept channel 1 and channel 2**

With this operating concept, either only one or alternatively two telegrams are sent each time the contact is closed.

- With a short signal, the device only sends the telegram for channel 1.
- With a long signal, the device first sends the telegram for channel 1 and then the telegram for channel 2.

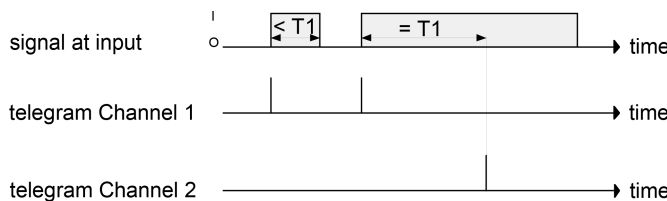

Image 41: Example for operation concept "Channel 1 and channel 2"

The time duration (T1) for distinguishing between a short and a long signal is determined by the parameter "Time between channel 1 and channel 2". When the contact is closed, the telegram for channel 1 is sent immediately. If the signal lasts longer than T1, the telegram for the second channel is also sent immediately after the time has elapsed. If the contact at the input is released before the time T1 has elapsed, the device does not send a telegram for channel 2.

### 10.7.1 2-channel operation parameters

Input... -> I... - Function

Debounce time (10...255 ms)	10...255
This parameter sets the debouncing time individually for the input. According to the time set here, the input signal at the input is evaluated with a delay.	
Operation concept	Channel 1 or channel 2 Channel 1 and channel 2
<p>This is where the 2-channel operation concept is defined.</p> <p>Channel 1 or channel 2: With this operating concept, exactly one telegram is sent each time the contact closes. The time duration for distinguishing between a short and a long signal is determined by the parameter "Time between channel 1 and channel 2". If the signal is shorter than the parameterised time, only the telegram to channel 1 is sent when the contact is opened. If the signal is longer, only the telegram to channel 2 is sent after time has elapsed. This concept provides the transmission of only one channel.</p> <p>Channel 1 and channel 2: With this operating concept, either only one or alternatively two telegrams are sent each time the contact closes. The time duration for distinguishing between a short and a long signal is determined by the parameter "Time between channel 1 and channel 2". When the contact is closed, the telegram for channel 1 is sent immediately. If the signal lasts longer than the set time, the telegram for the second channel is also sent immediately after the time has expired. If the contact at the input is released before the time has elapsed, the device does not send a telegram for channel 2.</p>	

Function channel 1	No function 1-bit switching 1 bytes (0...255) 1 byte (0...100%) 1 bytes (-128...127) 1 byte (0...255%) 1 byte (0...360°) 2 bytes (0...65535) 2 bytes (-32768...32767) 2 byte temperature value 2 byte brightness value 2 bytes colour temperature value 3 bytes colour value RGB/HSV 6 bytes colour value RGBW/HSVW 6 bytes colour temperature value + brightness Recalling scene (external)
--------------------	---

This parameter determines the function of the first channel and defines which other parameters and which communication objects are displayed for channel 1.

Function channel 2	No function 1-bit switching 1 bytes (0...255) 1 byte (0...100%) 1 bytes (-128...127) 1 byte (0...255%) 1 byte (0...360°) 2 bytes (0...65535) 2 bytes (-32768...32767) 2 byte temperature value 2 byte brightness value 2 bytes colour temperature value 3 bytes colour value RGB/HSV 6 bytes colour value RGBW/HSVW 6 bytes colour temperature value + brightness Recalling scene (external)
--------------------	---

This parameter determines the function of the second channel and defines which other parameters and which communication objects are displayed for channel 2.

Colour space	RGB HSV
<p>This parameter defines the colour space of the function "3 byte colour value RGB/HSV".</p> <p>With "RGB", the data format of the communication objects can be set by the "Communication" parameter. With HSV, communication takes place via 1-byte individual objects.</p>	
Communication	Single object Kombi object
<p>This parameter defines the data format of the communication objects for the function "3 byte colour value RGB/HSV" in the colour space "RGB". Communication can take place via 1-byte individual objects or via a 3-byte combination object according to DPT 232.600.</p>	
Colour space	RGBW HSVW
<p>This parameter defines the colour space of the function "6 byte colour value RGBW/HSVW".</p> <p>With "RGBW", the data format of the communication objects can be set by the "Communication" parameter. With HSVW, communication takes place via 1-byte individual objects.</p>	
Communication	Single object Kombi object
<p>This parameter defines the data format of the communication objects for the function "3 byte colour value RGBW/HSVW" in the colour space "RGBW". Communication can take place via 1-byte individual objects or via a 6-byte combination object according to DPT 251.600.</p>	
Time between channel 1 and channel 2 (0...25 seconds)	0... <b>3</b> ...25
<p>Depending on the selected operation concept, this parameter defines the interval at which the device transmits the telegram for channel 1 and the telegram for channel 2.</p> <p>Setting the seconds of time between channel 1 and channel 2.</p>	
(0...990 milliseconds)	0...990
<p>Setting the milliseconds of time between channel 1 and channel 2.</p>	
Command for channel 1 (2)	ON OFF TOGGLE
<p>This parameter determines the object value that is sent out on the KNX when the contact closes. Visible only if "Function channel 1 (2) = 1 bit switching".</p>	

Value (0...255)	0...255
This parameter determines the object value that is sent out on the KNX when the contact closes. Visible only if "Function channel 1 (2) = 1-byte (0...255)".	
Value (0...100%)	0...100
This parameter determines the object value that is sent out on the KNX when the contact closes. Visible only if "Function channel 1 (2) = 1-byte (0...100%)".	
Value (-128...127)	-128...0...127
This parameter determines the object value that is sent out on the KNX when the contact closes. Visible only if "Function channel 1 (2) = 1-byte (-128...127)".	
Value (0...255%)	0...255
This parameter determines the object value that is sent out on the KNX when the contact closes. Visible only if "Function channel 1 (2) = 1-byte (0...255%)".	
Value (0...360°)	0...360
This parameter determines the object value that is sent out on the KNX when the contact closes. Visible only if "Function channel 1 (2) = 1-byte (0...360°)".	
Value (0...65535)	0...65535
This parameter determines the object value that is sent out on the KNX when the contact closes. Visible only if "Function channel 1 (2) = 2-byte (0...65535)".	
Value (-32768...32767)	-32768...0...32767
This parameter determines the object value that is sent out on the KNX when the contact closes. Visible only if "Function channel 1 (2) = 2-byte (-32768...32767)".	
Temperature value (0...40 °C)	0...20...40
This parameter determines the object value that is sent out on the KNX when the contact closes. Visible only if "Function channel 1 (2) = 2-byte temperature value".	
Brightness value (0, 50, ..., 1500 lux)	0...300...1500
This parameter determines the object value that is sent out on the KNX when the contact closes. Visible only if "Function channel 1 (2) = 2-byte brightness value".	
Colour temperature value (1000, 1100, ..., 10000 K)	1000, 1100, ...2700, ..., 10000
This parameter determines the colour temperature value of the object value that is sent out on the KNX when the contact closes. It is only visible with "Function channel 1 (2) = 2 byte colour temperature value".	

Colour value (RGB/HSV)	#000000...#FFFFFF
<p>This parameter determines the object values when closing the contact for the following output objects:</p> <ul style="list-style-type: none"> <li>- "Channel 1 (2) colour value red", "Channel 1 (2) colour value green", "Channel 1 (2) colour value blue" or</li> <li>- "Channel 1 (2) colour value RGB", "Channel 1 (2) colour value RGBW".</li> </ul> <p>or</p> <ul style="list-style-type: none"> <li>- "Channel 1 (2) colour hue (H)", "Channel 1 (2) saturation (S)", "Channel 1 (2) brightness (V)".</li> </ul> <p>The parameter is only visible with "Function channel 1 (2) = 3 byte colour value RGB/HSV or 6 byte colour value RGBW/HSVW".</p>	
White level (W)	0...255
<p>This parameter determines the object values of the following output objects, which is sent out on the KNX when the contact closes:</p> <ul style="list-style-type: none"> <li>- "Channel 1 (2) colour value white" or</li> <li>- "Channel 1 (2) colour value RGBW"</li> </ul> <p>The parameter is only visible with "Function channel 1 (2) = 6 byte colour value RGBW/HSVW" in the colour space "RGB".</p>	
Value (W %)	0...100
<p>This parameter determines the object values of the following output objects, which is sent out on the KNX when the contact closes:</p> <ul style="list-style-type: none"> <li>- Channel 1 (2) white level (W)</li> </ul> <p>The parameter is only visible with "Function channel 1 (2) = 6 byte colour value RGBW/HSVW" in the colour space "HSV".</p>	
Colour temperature value (1000, 1100, ..., 10000 K)	1000, 1100, ..., <b>2700</b> , ..., 10000
<p>This parameter determines the object value for the colour temperature that is sent out on the KNX when the contact closes. It is only visible with "Function channel 1 (2) = 6 byte colour temperature value + brightness".</p>	
Brightness (0...100%)	0...100
<p>This parameter determines the object value for the brightness that is sent out on the KNX when the contact closes. It is only visible with "Function channel 1 (2) = 6 byte colour temperature value + brightness".</p>	
Time frame (0...100 minutes)	0...100
<p>This parameter determines the time period in which the actuator adjusts the colour temperature and brightness after the contact is closed. It is only visible with "Function channel 1 (2) = 6 byte colour temperature value + brightness".</p> <p>Setting the minutes of the time window.</p>	



(0...59 seconds)	0...1...59
Setting the seconds of the time window.	
(0...900 milliseconds)	0...900
Setting the milliseconds of the time window.	
Scene number (1...64) for channel 1 (2)	1...64
<p>This parameter determines the object value that is sent out on the KNX when the contact closes.</p> <p>It is only visible if "Function channel 1 (2) = Recalling scene (external)".</p>	

### 10.7.2 2-channel operation objects

Object no.	Function	Name	Type	DPT	Flag
636, 649, 662	Channel 1 switching	Input... - Output	1-bit	1,001	C, (R), W, T, A
1-bit object for transmitting switching telegrams on channel 1 if 2-channel operation is activated.					
Object no.	Function	Name	Type	DPT	Flag
637, 650, 663	Channel 2 switching	Input... - Output	1-bit	1,001	C, -, W, T, U
1-bit object for transmitting switching telegrams on channel 2 if 2-channel operation is activated.					
Object no.	Function	Name	Type	DPT	Flag
636, 649, 662	Channel 1 value 0...255	Input... - Output	1 bytes	5,010	C, R, -, T, A
1-byte object for transmitting value telegrams on channel 1 if 2-channel operation is activated.					
Object no.	Function	Name	Type	DPT	Flag
637, 650, 663	Channel 2 value 0...255	Input... - Output	1 bytes	5,010	C, R, -, T, A
1-byte object for transmitting value telegrams on channel 2 if 2-channel operation is activated.					
Object no.	Function	Name	Type	DPT	Flag
636, 649, 662	Channel 1 value 0...100 %	Input... - Output	1 bytes	5,001	C, R, -, T, A
1-byte object for transmitting value telegrams on channel 1 if 2-channel operation is activated.					
Object no.	Function	Name	Type	DPT	Flag
637, 650, 663	Channel 2 value 0...100 %	Input... - Output	1 bytes	5,001	C, R, -, T, A
1-byte object for transmitting value telegrams on channel 2 if 2-channel operation is activated.					
Object no.	Function	Name	Type	DPT	Flag
636, 649, 662	Channel 1 value -128...127	Input... - Output	1 bytes	6,010	C, R, -, T, A
1-byte object for transmitting value telegrams on channel 1 if 2-channel operation is activated.					

Object no.	Function	Name	Type	DPT	Flag
637, 650, 663	Channel 2 value -128...127	Input... - Output	1 bytes	6,010	C, R, -, T, A
1-byte object for transmitting value telegrams on channel 2 if 2-channel operation is activated.					

Object no.	Function	Name	Type	DPT	Flag
636, 649, 662	Channel 1 value 0...255 %	Input... - Output	1 bytes	5,004	C, R, -, T, A
1-byte object for transmitting value telegrams on channel 1 if 2-channel operation is activated.					

Object no.	Function	Name	Type	DPT	Flag
637, 650, 663	Channel 2 value 0...255 %	Input... - Output	1 bytes	5,004	C, R, -, T, A
1-byte object for transmitting value telegrams on channel 2 if 2-channel operation is activated.					

Object no.	Function	Name	Type	DPT	Flag
636, 649, 662	Channel 1 value 0...360°	Input... - Output	1 bytes	5,003	C, R, -, T, A
1-byte object for transmitting value telegrams on channel 1 if 2-channel operation is activated.					

Object no.	Function	Name	Type	DPT	Flag
637, 650, 663	Channel 2 value 0...360°	Input... - Output	1 bytes	5,003	C, R, -, T, A
1-byte object for transmitting value telegrams on channel 2 if 2-channel operation is activated.					

Object no.	Function	Name	Type	DPT	Flag
636, 649, 662	Channel 1 value 0...65535	Input... - Output	2 bytes	7,001	C, R, -, T, A
2-byte object for transmitting value telegrams on channel 1 if 2-channel operation is activated.					

Object no.	Function	Name	Type	DPT	Flag
637, 650, 663	Channel 2 value 0...65535	Input... - Output	2 bytes	7,001	C, R, -, T, A
2-byte object for transmitting value telegrams on channel 2 if 2-channel operation is activated.					

Object no.	Function	Name	Type	DPT	Flag
636, 649, 662	Channel 1 value -32768...32767	Input... - Output	2 bytes	8,001	C, R, -, T, A
2-byte object for transmitting value telegrams on channel 1 if 2-channel operation is activated.					

Object no.	Function	Name	Type	DPT	Flag
637, 650, 663	Channel 2 value -32768...32767	Input... - Output	2 bytes	8,001	C, R, -, T, A
2-byte object for transmitting value telegrams on channel 2 if 2-channel operation is activated.					

Object no.	Function	Name	Type	DPT	Flag
636, 649, 662	Channel 1 temperat- ure value	Input... - Output	2 bytes	9,001	C, R, -, T, A
2-byte object for transmitting temperature values on channel 1 if 2-channel operation is activated.					

Object no.	Function	Name	Type	DPT	Flag
637, 650, 663	Channel 2 temperat- ure value	Input... - Output	2 bytes	9,001	C, R, -, T, A
2-byte object for transmitting temperature values on channel 2 if 2-channel operation is activated.					

Object no.	Function	Name	Type	DPT	Flag
636, 649, 662	Channel 1 bright- ness value	Input... - Output	2 bytes	9,004	C, R, -, T, A
2-byte object for transmitting brightness values on channel 1 if 2-channel operation is activated.					

Object no.	Function	Name	Type	DPT	Flag
637, 650, 663	Channel 2 bright- ness value	Input... - Output	2 bytes	9,004	C, R, -, T, A
2-byte object for transmitting brightness values on channel 2 if 2-channel operation is activated.					

Object no.	Function	Name	Type	DPT	Flag
636, 649, 662	Channel 1 colour temperature value	Input... - Output	2 bytes	7,600	C, R, -, T, A
2-byte object for sending colour temperature values from 1000 to 10000 Kelvin on channel 1 if 2-channel operation is activated.					

Object no.	Function	Name	Type	DPT	Flag
637, 650, 663	Channel 2 colour temperature value	Input... - Output	2 bytes	7,600	C, R, -, T, A
2-byte object for sending colour temperature values from 1000 to 10000 Kelvin on channel 2 if 2-channel operation is activated.					

Object no.	Function	Name	Type	DPT	Flag
636, 649, 662	Channel 1 colour value RGB	Input... - Output	3 bytes	232,600	C, R, -, T, A
3-byte object for sending the colour information red, green and blue in a communication object on channel 1 if 2-channel operation is activated.					

Object no.	Function	Name	Type	DPT	Flag
637, 650, 663	Channel 2 colour value RGB	Input... - Output	3 bytes	232,600	C, R, -, T, A
3-byte object for sending the colour information red, green and blue in a communication object on channel 2 if 2-channel operation is activated.					

Object no.	Function	Name	Type	DPT	Flag
636, 649, 662	Channel 1 colour value RGBW	Input... - Output	6 bytes	251,600	C, R, -, T, A
6-byte object for sending the colour information red, green, blue and white in a communication object on channel 1 if 2-channel operation is activated.					

Object no.	Function	Name	Type	DPT	Flag
637, 650, 663	Channel 2 colour value RGBW	Input... - Output	6 bytes	251,600	C, R, -, T, A
6-byte object for sending the colour information red, green, blue and white in a communication object on channel 2 if 2-channel operation is activated.					

Object no.	Function	Name	Type	DPT	Flag
638, 651, 664	Channel 1 colour value red	Input... - Output	1 bytes	5,001	C, R, -, T, A
1-byte object for sending the colour value red from 0 to 100 percent on channel 1 if 2-channel operation is activated.					

Object no.	Function	Name	Type	DPT	Flag
642, 655, 668	Channel 2 colour value red	Input... - Output	1 bytes	5,001	C, R, -, T, A
1-byte object for sending the colour value red from 0 to 100 percent on channel 2 if 2-channel operation is activated.					

Object no.	Function	Name	Type	DPT	Flag
639, 652, 665	Channel 1 colour value green	Input... - Output	1 bytes	5,001	C, R, -, T, A
1-byte object for sending the colour value green from 0 to 100 percent on channel 1 if 2-channel operation is activated.					

Object no.	Function	Name	Type	DPT	Flag
643, 656, 669	Channel 2 colour value green	Input... - Output	1 bytes	5,001	C, R, -, T, A
1-byte object for sending the colour value green from 0 to 100 percent on channel 2 if 2-channel operation is activated.					

Object no.	Function	Name	Type	DPT	Flag
640, 653, 666	Channel 1 colour value blue	Input... - Output	1 bytes	5,001	C, R, -, T, A
1-byte object for sending the colour value blue from 0 to 100 percent on channel 1 if 2-channel operation is activated.					

Object no.	Function	Name	Type	DPT	Flag
644, 657, 670	Channel 2 colour value blue	Input... - Output	1 bytes	5,001	C, R, -, T, A
1-byte object for sending the colour value blue from 0 to 100 percent on channel 2 if 2-channel operation is activated.					

Object no.	Function	Name	Type	DPT	Flag
641, 654, 667	Channel 1 colour value transmitter white	Input... - Output	1 bytes	5,001	C, R, -, T, A
1-byte object for sending the colour value white from 0 to 100 percent on channel 1 if 2-channel operation is activated.					

Object no.	Function	Name	Type	DPT	Flag
645, 658, 671	Channel 2 colour value transmitter white	Input... - Output	1 bytes	5,001	C, R, -, T, A
1-byte object for sending the colour value white from 0 to 100 percent on channel 2 if 2-channel operation is activated.					

Object no.	Function	Name	Type	DPT	Flag
638, 651, 664	Channel 1 colour hue (H)	Input... - Output	1 bytes	5,003	C, R, -, T, A
1-byte object for sending the colour angle (H) from 0 ... 360° on channel 1 if 2-channel operation is activated.					

Object no.	Function	Name	Type	DPT	Flag
642, 655, 668	Channel 2 colour hue (H)	Input... - Output	1 bytes	5,003	C, R, -, T, A
1-byte object for sending the colour angle (H) from 0 ... 360° on channel 2 if 2-channel operation is activated.					

Object no.	Function	Name	Type	DPT	Flag
639, 652, 665	Channel 1 saturation (S)	Input... - Output	1 bytes	5,001	C, R, -, T, A
1-byte object for sending the saturation (S) from 0 to 100 percent on channel 1 if 2-channel operation is activated.					

Object no.	Function	Name	Type	DPT	Flag
643, 656, 669	Channel 2 saturation (S)	Input... - Output	1 bytes	5,001	C, R, -, T, A
1-byte object for sending the saturation (S) from 0 to 100 percent on channel 2 if 2-channel operation is activated.					

Object no.	Function	Name	Type	DPT	Flag
640, 653, 666	Channel 1 brightness (V)	Input... - Output	1 bytes	5,001	C, R, -, T, A
1-byte object for sending the brightness value (V) from 0 to 100 percent on channel 1 if 2-channel operation is activated.					

Object no.	Function	Name	Type	DPT	Flag
644, 657, 670	Channel 2 brightness (V)	Input... - Output	1 bytes	5,001	C, R, -, T, A
1-byte object for sending the brightness value (V) from 0 to 100 percent on channel 2 if 2-channel operation is activated.					

Object no.	Function	Name	Type	DPT	Flag
641, 654, 667	Channel 1 white level (W)	Input... - Output	1 bytes	5,001	C, R, -, T, A
1-byte object for sending the white value (W) from 0 to 100 percent on channel 1 if 2-channel operation is activated.					

Object no.	Function	Name	Type	DPT	Flag
645, 658, 671	Channel 2 white level (W)	Input... - Output	1 bytes	5,001	C, R, -, T, A
1-byte object for sending the white value (W) from 0 to 100 percent on channel 2 if 2-channel operation is activated.					

Object no.	Function	Name	Type	DPT	Flag
636, 649, 662	Channel 1 colour temperature value + brightness	Input... - Output	6 bytes	249,600	C, R, -, T, A

6-byte object for sending the time window, colour temperature and brightness on channel 1 if 2-channel operation is activated.

Object no.	Function	Name	Type	DPT	Flag
637, 650, 663	Channel 1 colour temperature value + brightness	Input... - Output	6 bytes	249,600	C, R, -, T, A

6-byte object for sending the time window, colour temperature and brightness on channel 2 if 2-channel operation is activated.

Object no.	Function	Name	Type	DPT	Flag
636, 649, 662	Channel 1 scene (external) 1...64	Input... - Output	1 bytes	18,001	C, R, -, T, A

1-byte object for transmitting scene values on channel 1 if 2-channel operation is activated.

Object no.	Function	Name	Type	DPT	Flag
637, 650, 663	Channel 2 scene (external) 1...64	Input... - Output	1 bytes	18,001	C, R, -, T, A

1-byte object for transmitting scene values on channel 2 if 2-channel operation is activated.



## 10.8 Controller extension

The function "controller extension" can be used to control a KNX room temperature controller. The controller extension itself is not involved in the regulating process. With it, the user can operate the single-room regulation from different places in the room. It can also be used to adjust central heating control devices which are located, for instance, in a sub-distribution device.

Typical KNX room temperature controllers generally offer different ways of influencing the room temperature control:

- Operating mode switch:  
Switching over between different modes of operation (e.g. "Comfort", "Night" ...) with different setpoint temperatures assigned to each mode by the controller.
- Presence function:  
Signalling the presence of a person in a room. The signalling may also be combined with a configured switchover in the mode of operation.
- Setpoint shift:  
Adjustment of the setpoint temperature via a temperature offset (DPT 9.002) or via levels (DPT 6.010).

The controller extension is operated by the input functions of the device. In this way, it is possible to completely control a room temperature controller by changing the operating mode, by predefining the presence function or by readjusting the setpoint shift.

### 10.8.1 Operating mode switchover

The switching of the controller operating mode can be carried out with two 1-byte communication objects in accordance with the KNX specification for room temperature controllers. The operating mode can be switched over with the normal and with the forced objects. The "Operating mode switchover" object offers a selection between the following modes:

- Comfort mode
- Standby mode
- Night operation
- Frost/heat protection mode

The "Forced object operating mode" communication object has a higher priority. It permits forced switching between the following modes of operation:

- Auto (normal operating mode switchover)
- Comfort mode
- Standby mode
- Night operation
- Frost/heat protection mode

**i** Notes on multiple selection: In order to ensure that a change-over from one operating mode to another works properly even from different locations, the operating mode objects of the controller and those of all controller extensions must be interlinked. By checking the linked operating mode switchover feedback object, the controller extension knows which of the possible operating modes is active. Based on this information, the system switches to the next operating mode when the contact is closed. In the event that none of the possible operating modes is active, the next operating mode in the sequence is activated. As far as switching over between the forced operating modes and "Auto" is concerned, the device switches into the "Auto" operating mode when none of the configured operating modes is active.

### 10.8.2 Presence function

In the "Presence function" function mode, the two communication objects "Presence function" and "Presence function feedback" are available. The "Presence function when closing the contact" parameter determines the object value that is sent out on the KNX when the contact at the input closes.

To ensure that the appropriate object value is always sent with the "Presence TOGGLE" setting, the presence object of the room temperature controller and the feedback objects of the controller extension devices must be connected to each other via a separate group address (this group address must be transmitting at the controller).

### 10.8.3 Setpoint shift

The setpoint shift is another available function of the controller extension. It makes use of either two 2-byte communication objects with datapoint type 9.002 or two 1-byte communication objects with datapoint type 6.010 (integer with sign).

This extension function allows shifting of the basic setpoint for the temperature on a room temperature controller by signals at the input. Operation of the extension is generally the same as the operation of the main controller. An input parameterised as setpoint shift decreases or increases the value of the setpoint shift once each time the contact closes. The direction of the value adjustment is determined by the parameters "Temperature difference when closing the contact" or "Setpoint shift when closing the contact".

#### Type of setpoint shift

The device provides two options for setpoint shifting. Depending on the setting of the parameter "Type of setpoint shift", the shift takes place via the 2-byte communication object "Setpoint shift specification" (acc. to KNX DPT 9.002) or via the 1-byte-communication object "Setpoint shift specification" (acc. to KNX DPT 6.010).

The setting "Via offset (DPT 9.002)" defines the temperature difference in Kelvin by which the setpoint temperature will be shifted up or down when the contact is closed. For a setpoint value shift, the controller extension makes use of the two communication objects "Setpoint shift specification" and "Current setpoint shift". The "Current setpoint shift" communication object informs the extension about the current state of the room temperature controller. Based on this value and the respective parameter, the controller extension determines the new level size which it transmits via the "Setpoint shift specification" communication object to the room temperature controller.

With the "Via levels (DPT 6.010)" setting, only the direction of the setpoint shift on the extension is defined. For a setpoint value shift, the controller extension makes use of the two communication objects "Setpoint shift specification" and "Current setpoint shift". The "Current setpoint shift" communication object informs the extension about the current state of the room temperature controller. Based on this value and the respective parameter, the controller extension determines the new level size which it transmits via the "Setpoint shift specification" communication object to the room temperature controller.

#### Communication with main controller

In order to enable the device to effect a setpoint shift in a room temperature controller, the controller must have input and output objects for setpoint shifting. In this case, the output object of the controller must be linked with the input object of the extension device and the input object of the controller must be linked with the output object of the extension via an independent group address.

All objects are of the same datapoint type and have the same value range. A setpoint shift is interpreted by count values: a shift in positive direction is expressed by positive values whereas a shift in negative direction is represented by negative object values. An object value of "0" means that no setpoint shift has been activated.

Via the "Current setpoint shift" object of the controller extensions, which is linked with the room temperature controller, the extensions are enabled to determine the current setpoint shift position. Based on the value of the communication object, the setpoint is adjusted in the configured direction each time the contact at an extension closes. Each time the setpoint is adjusted, the new shift is transmitted to the room temperature controller via the "Controller extension setpoint value specification" object of the controller extension. The controller itself checks the received value for the minimum and maximum temperature limits (see controller documentation) and adjusts the new setpoint shift if the values are valid. When the new count value is accepted as valid, the controller transfers this value to its output object for setpoint shifting and retransmits the value to the extension as feedback.

Due to the standard data point type used as the output and input object of the controller extension, each extension device is able to determine whether a shift took place, in which direction it took place and by which value (DPT 9.002) or by how many levels (DPT 6.010) the setpoint was shifted.

- i In "Via levels (DPT 6.010)" function, the weighting of the respective level is done by the controller itself.
- i This requires that the communication objects are connected on all controller extensions and the controller. The feedback information from the controller enables the extension to continue the adjustment anytime at the right point.

### 10.8.4 Controller extension parameters

Input... -> I... - Function

Debounce time (10...255 ms)	10...255
This parameter sets the debouncing time individually for the input. According to the time set here, the input signal at the input is evaluated with a delay.	
Function	<b>Operating mode switchover</b> Forced oper. mode switchover Presence function Setpoint shift
A controller extension can optionally switch over the operating mode with normal or high priority (forced), change the presence state or change the current room temperature setpoint value. With regard to the setting of this parameter, the ETS shows further parameters.	
Operating mode when closing the contact	<b>Comfort mode</b> Standby mode Night operation Frost/heat protection mode Comfort mode -> Standby mode ->* Comfort mode -> Night mode ->* Standby mode -> Night mode ->* Comfort mode -> Standby mode -> Night mode ->*
If the controller extension is to change over the operating mode of the room temperature controller with normal priority, the extension can – when operated – either switch on a defined operating mode or change over between different operating modes.  This parameter is only visible if "Function = operating mode switchover".	

<p>Forced operating mode when closing the contact</p>	<p>Auto (Normal operating mode change-over) <b>Comfort mode</b> Standby mode Night operation Frost/heat protection mode Comfort mode -&gt; Standby mode -&gt;* Comfort mode -&gt; Night mode -&gt;* Standby mode -&gt; Night mode -&gt;* Comfort mode -&gt; Standby mode -&gt; Night mode -&gt;* Auto -&gt; Comfort mode -&gt;* Auto -&gt; Standby mode -&gt;* Auto -&gt; Night mode -&gt;* Auto -&gt; Frost/heat protection mode -&gt;*</p>
<p>If the controller extension is to change over the operating mode of the room temperature controller with high priority, the extension can – when operated – either enable change-over with normal priority (Auto), switch on a defined operating mode with high priority or change over between different operating modes. This parameter is only visible if "Function = forced operating mode switchover".</p>	
<p>Presence function when closing the contact</p>	<p>Presence OFF Presence ON <b>Presence TOGGLE</b></p>
<p>On closing the contact, the controller extension can switch the presence state of the room temperature controller either on or off in a defined way or change over between both states ("Presence TOGGLE"). This parameter is only visible if "Function = presence function".</p>	
<p>Type of setpoint shift</p>	<p><b>Via offset (DPT 9.002)</b> Via levels (DPT 6.010)</p>
<p>Depending on the setting of this parameter, the shift takes place via the 2-byte communication object "Setpoint shift specification" (acc. to KNX DPT 9.002) or via the 1-byte-communication object "Setpoint shift specification" (acc. to KNX DPT 6.010). This parameter is only visible if "Function = Setpoint shift".</p>	

Temperature difference when closing the contact	+2 K
	+1.5 K
	+1 K
	<b>+0.5 K</b>
	-0.5 K
	-1 K
	-1.5 K
	-2 K

The temperature difference is defined in Kelvin here by which the setpoint temperature will be shifted up or down when the contact is closed.

For a setpoint value shift, the controller extension makes use of the two communication objects "Setpoint shift specification" and "Current setpoint shift".

The "Current setpoint shift" communication object informs the extension about the current state of the room temperature controller. Based on this value and the respective parameter, the controller extension determines the new level size which it transmits via the "Setpoint shift specification" communication object to the room temperature controller.

This parameter is only visible if "Function = Setpoint shift" and "Type of setpoint shift = Via offset (DPT 9.002)".

Setpoint shift when closing the contact	<b>Increase setpoint (level size)</b>
	Reduce setpoint value (level size)

This parameter defines the direction of the setpoint shift on the extension.

For a setpoint value shift, the controller extension makes use of the two communication objects "Setpoint shift specification" and "Current setpoint shift".

The "Current setpoint shift" communication object informs the extension about the current state of the room temperature controller. Based on this value and the respective parameter, the controller extension determines the new level size which it transmits via the "Setpoint shift specification" communication object to the room temperature controller.

This parameter is only visible if "Function = Setpoint shift" and "Type of setpoint shift = Via levels (DPT 6.010)".



### 10.8.5 Controller extension objects

Object no.	Function	Name	Type	DPT	Flag
606, 613, 620	Controller extension operating mode switchover	Input... - Output	1 bytes	20,102	C, R, -, T, A
<p>1-byte object for changing over a room temperature controller between the Comfort, Standby, Night and Frost/heat protection operating modes. This object is only visible if "Function = operating mode change-over".</p>					

Object no.	Function	Name	Type	DPT	Flag
607, 614, 621	Controller extension operating mode switchover feedback	Input... - Input	1 bytes	20,102	C, (R), W, -, A
<p>1-byte object for receiving the operating mode of a room temperature controller. This object is only visible if "Function = operating mode change-over".</p>					

Object no.	Function	Name	Type	DPT	Flag
606, 613, 620	Controller extension forced-object operating	Input... - Output	1 bytes	20,102	C, R, -, T, A
<p>1-byte object for changing over a room temperature controller under forced control between the Automatic, Comfort, Standby, Night and Frost / heat protection operating modes This object is only visible if "Function = forced operating mode change-over".</p>					

Object no.	Function	Name	Type	DPT	Flag
607, 614, 621	Controller extension forced-object operating feedback	Input... - Input	1 bytes	20,102	C, (R), W, -, A
<p>1-byte object for receiving the operating mode of a room temperature controller. This object is only visible if "Function = forced operating mode change-over".</p>					

Object no.	Function	Name	Type	DPT	Flag
606, 613, 620	Controller extension presence function	Input... - Output	1-bit	1,018	C, R, -, T, A
<p>1-bit object for changing over the presence status of a room temperature controller. This object is only visible if "Function = presence function".</p>					

Object no.	Function	Name	Type	DPT	Flag
607, 614, 621	Controller extension presence function feedback	Input... - Input	1-bit	1,018	C, (R), W, -, A
<p>1-bit object for receiving the presence status of a room temperature controller. This object is only visible if "Function = presence function".</p>					

Object no.	Function	Name	Type	DPT	Flag
606, 613, 620	Controller extension setting setpoint shift	Input... - Output	2 bytes	9,002	C, R, -, T, A

2-byte object for presetting a basic setpoint shift in Kelvin. The value "0" means that no shift is active . The values can be specified between -670760 K and 670760 K.  
 This object is only visible if "Function = Setpoint shift" and "Type of setpoint shift = Via offset (DPT 9.002)".

Object no.	Function	Name	Type	DPT	Flag
607, 614, 621	Controller extension actual setpoint shift	Input... - Input	2 bytes	9,002	C, (R), W, -, A

2-byte object for receiving the feedback from the current basic setpoint shift in Kelvin.  
 This object is only visible if "Function = Setpoint shift" and "Type of setpoint shift = Via offset (DPT 9.002)".

Object no.	Function	Name	Type	DPT	Flag
606, 613, 620	Controller extension setting setpoint shift	Input... - Output	1 bytes	6,010	C, R, -, T, A

1-byte object for presetting a basic setpoint shift. The value "0" means that no shift is active . The value is depicted in a two's complement in the positive or negative direction.  
 This object is only visible if "Function = Setpoint shift" and "Type of setpoint shift = Via levels (DPT 6.010)".

Object no.	Function	Name	Type	DPT	Flag
607, 614, 621	Controller extension actual setpoint shift	Input... - Input	1 bytes	6,010	C, (R), W, -, A

1-byte object for receiving the feedback from the current basic setpoint shift.  
 This object is only visible if "Function = Setpoint shift" and "Type of setpoint shift = Via levels (DPT 6.010)".

## 10.9 Temperature measurement

### Introduction

It is possible to connect an NTC temperature sensor to input 3 for measuring a floor or room temperature. If input 3 is used as an input for a temperature sensor, parameters are available in the application program that define the acquisition of the measured value, the temperature adjustment and the transmission behaviour of the temperature value. The wired temperature sensor can be combined with an external temperature value. This makes it possible to form one measured value from up to two measured values.

- i** When connecting to input 3, only use the NTC temperature sensor listed in the accessories. Functional errors may occur with other sensors.

If the "Function" parameter for input 3 is set to "Temperature sensor (NTC)", temperature measurement can be used. Depending on the application, the temperature can then be recorded by the wired sensor and optionally supplemented by a temperature value received from the KNX from another measuring point. The parameter "Measurement by" defines the temperature measurement by either one or two sensors.

When selecting the mounting location of the temperature sensors, the following points should be considered:

- Do not install the temperature sensor in the area of large electrical consumers (avoid heat influences).
- The push button sensor should not be installed in the vicinity of radiators or cooling systems.
- The temperature sensor should not be exposed to direct sun.
- The installation of sensors on the inside of an outside wall might have a negative impact on the temperature measurement.
- Temperature sensors should be installed at least 30 cm away from doors, windows or ventilation devices and at least 1.5 m above the floor.

### Temperature detection and measured value formation

The "Measurement by" parameter specifies which sensors are used to determine the temperature. The following settings are possible:

- wired sensor (input 3)  
The temperature value is determined exclusively by the NTC temperature sensor connected to input 3. With this configuration, temperature measurement starts a few seconds after a device reset (bus voltage return, ETS programming operation).
- wired sensor (input 3) and external sensor (object)  
With this setting, two temperature sensors are combined. The temperature is determined by the NTC temperature sensor connected to input 3 and also by a temperature value received from the KNX. This external sensor is coupled via the 2-byte object "External sensor" and can be a KNX room thermostat or a controller extension with temperature detection.

The "Measured value formation" parameter defines the weighting of the temperature values. It is possible to adjust the temperature measurement depending on different installation locations of the sensors or a different heat distribution in the room. Often, those temperature sensors that are subject to negative external influences (for example, unfavourable location because of exposure to sun or heater or door / window directly next to it) are weighted less heavily. Example: The wired sensor is mounted on an interior wall in the middle of the room below the ceiling. Another push-button sensor with temperature measurement is mounted next to the room entrance door.

Wired sensor: 21.5 °C

External sensor (push-button sensor): 22.3 °C

Determination of measured value: 30 % to 70 %

$$\rightarrow T_{\text{Result wired}} = T_{\text{wired}} \cdot 0.3 = 6.45 \text{ °C},$$

$$\rightarrow T_{\text{Result 2}} = T_2 = 22.3 \text{ °C} \cdot 0.7 = 15.61 \text{ °C}$$

$$\rightarrow T_{\text{Result is}} = T_{\text{Result wired}} + T_{\text{Result extern}} = \underline{22.06 \text{ °C}}$$

The device can request the external temperature value cyclically. To do this, the "Polling time of external sensor" parameter must be set to a time > 0 minutes.

A few seconds after a device reset (bus voltage return, ETS programming operation), the temperature measurement starts. If no temperature value has yet been received via the "External sensor" object when evaluating an external temperature sensor, only the value formed by the internal sensor is processed.

### Calibrating the measured values

In some cases, it may be necessary in the course of temperature measurement to match the measured values of the wired sensor and the external sensor (received temperature value). Adjustment becomes necessary, for example, if the temperature measured by the sensors stays permanently below or above the actual temperature in the vicinity of the sensor. To determine the temperature deviation, the actual room temperature should be detected with a reference measurement using a calibrated temperature measuring device.

The positive (temperature increase, 1 ..127 K) or negative (temperature decrease, -128...-1 K) temperature adjustment can be parameterised in 0.1 K steps using the parameters "Wired sensor adjustment" and " External sensor adjustment". The adjustment is thus statically set only once and is the same for all operating states of the temperature measurement.

- i The measured value must be raised if the value measured by the sensor is below the actual temperature. The measured value must be lowered if the value measured by the sensor is above the actual temperature.

### Sending the determined temperature

The determined temperature can be actively transmitted to the KNX via the 2-byte "Actual temperature" object. The parameter "Transmit on change by" defines the temperature change by which the actual temperature value must change so that the value is automatically sent out via the object. Setting to "0" at this point will deactivate the automatic transmission of the actual temperature.

In addition, the actual temperature can be transmitted cyclically. The parameter determines the cycle time. The value "0" will deactivate the periodical transmission of the actual temperature value.

- i Setting the "Read" flag on the "actual temperature" object makes it possible to read out the current temperature value at any time over the KNX. It has to be pointed out that with deactivated periodical transmission and deactivated automatic transmission, no more actual-temperature telegrams will be transmitted".

After bus voltage return or after an ETS programming operation, the object value is updated after a few seconds according to the current actual temperature value and transmitted to the KNX. The set "Delay after bus voltage return" is taken into account. If no temperature value has yet been received via the "External sensor" object when evaluating an external temperature sensor, only the value formed by the internal sensor is processed.

### 10.9.1 Temperature measurement parameters

Input... -> I... - Function

Measurement by	<p>wired sensor (input 3)</p> <p>wired sensor (input 3) and external sensor (object)</p>
<p>This parameter determines which sensor is used for temperature measurement.</p> <p>wired sensor (input 3): The temperature value is determined exclusively by the NTC temperature sensor connected to input 3. With this configuration, temperature measurement starts a few seconds after a device reset (bus voltage return, ETS programming operation).</p> <p>wired sensor (input 3) and external sensor (object): With this setting, two temperature sensors are combined. The temperature is determined by the NTC temperature sensor connected to input 3 and also by a temperature value received from the KNX. This external sensor is coupled via the 2-byte object "External sensor" and can be a KNX room thermostat or a controller extension with temperature detection. A few seconds after a device reset (bus voltage return, ETS programming operation), the temperature measurement starts. If no temperature value has yet been received via the "External sensor" object when evaluating an external temperature sensor, only the value formed by the internal sensor is processed.</p>	
Measured value formation	<p>wired 10% to external 90%</p> <p>wired 20% to external 80%</p> <p>wired 30% to external 70%</p> <p>wired 40% to external 60%</p> <p><b>wired 50% to external 50%</b></p> <p>wired 60% to external 40%</p> <p>wired 70% to external 30%</p> <p>wired 80% to external 20%</p> <p>wired 90% to external 10%</p>
<p>The weighting of the measured temperature value for the wired and external sensors is specified here. This forms a resulting total measured value that is used for further evaluation of the actual temperature.</p> <p>It is possible to adjust the temperature measurement depending on different installation locations of the sensors or a different heat distribution in the room. Often, those temperature sensors that are subject to negative external influences (for example, unfavourable location because of exposure to sun or heater or door / window directly next to it) are weighted less heavily.</p>	
Wired sensor adjustment (-12.8...12.7 K)	-12.8...0...12.7
<p>This parameter adjusts the measured value of the wired sensor.</p>	
External sensor calibration (-12.8...12.7 K)	-12.8...0...12.7
<p>This parameter adjusts the measured value of the external sensor. The parameter is only visible if the temperature is also measured by the external sensor.</p>	

Polling time of external sensor (0...255 minutes)	0...255
The polling time for the external sensor's temperature value is specified here. In the "0" setting, the external sensor is not automatically polled. In this case, the sensor must transmit its temperature value itself.	
Transmit on change by (0..25.5 K)	0...0.2...25.5
This parameter defines the temperature change by which the actual temperature value must change so that the value is automatically sent out via the object. Setting to "0" at this point will deactivate the automatic transmission of the actual temperature.  After bus voltage return or after an ETS programming operation, the object value is updated after a few seconds according to the current actual temperature value and transmitted to the KNX. The set "Delay after bus voltage return" is taken into account.	
Cyclical transmission (0...255 minutes)	0...15...255
This parameter determines whether and with what time the determined actual temperature is sent out cyclically on the KNX.	

### 10.9.2 Temperature measurement objects

Object no.	Function	Name	Type	DPT	Flag
701	Actual-temperature	Temperature measurement (...) - Output	2 bytes	9,001	C, R, -, T, A

2-byte object for the display of the determined actual temperature. The actual temperature is determined either by the internal sensor and optionally additionally by a temperature value received from the KNX. The output temperature value takes the configured value for calibration into account, as well as the measured value formation between the temperature values.

Object no.	Function	Name	Type	DPT	Flag
702	External sensor	Temperature measurement(...) - Input	2 bytes	9,001	C, (R), W, -, A

2-byte object for coupling an external KNX temperature sensor. This allows cascading of several temperature sensors for temperature measurement.



## 10.10 Disabling functions

### Introduction

The device offers the option of blocking the inputs when they are used for buttons, switches and contacts or for leakage and dew sensors. It is then possible to deactivate all inputs or only a selection via the 1-bit communication object "Disabling". If the input is blocked, status changes of the connected controls or sensors are no longer evaluated. During a lockout, the inputs cannot perform any function or can temporarily perform another function.

**i** The locking function does not affect the temperature measurement of input 3.

The disabling function and the associated parameters and communication objects are enabled if the "Disabling function for inputs" parameter on the "General -> General inputs" parameter page is enabled.

**i** The locking function for the inputs cannot be used if the inputs act internally on the relay outputs of the device. In this case, the locking function of the outputs can be used.

The polarity of the disabling object can be set. In case of polarity inversion ("0 = disabled / 1 = enabled"), the disabling function is not activated immediately after bus voltage return or ETS programming. A "0" telegram must first be written to the disabling object to activate the locking function.

Repeated telegrams ("0" after "0" or "1" after "1") to the "Disabling" object show no reaction.

### Defining the disabling function

- On the parameter page "General -> General inputs", activate the parameter "Disabling function for inputs". This parameter cannot be activated if the inputs act internally on the relay outputs of the device!

The "Disabling" communication object and the "Disabling function" parameter page are displayed.

- Set the polarity of the disabling object on the "Disabling function" parameter page.
- Assign the inputs to the disabling function. To do this, select those inputs that are to be affected by the disabling function with the parameter "Assignment of inputs". For "individual inputs assigned", make the assignment via the parameters "Input 1", "Input 2" and "Input 3". If an NTC temperature sensor is connected to input 3, the disabling function does not act on this input despite assignment!

### Configuring the reaction at the beginning and end of a disable

If the disabling function is used, the reaction of the assigned inputs when activating and deactivating the locking can be set in the parameterisation.

The disabling function must be enabled.

- Set parameter "At the beginning of the disabling function" / "At the end of the disabling function" to "no reaction".

The assigned inputs show no reaction at the beginning or end of the disabling. Only the behaviour "While active disabling function" is executed.
- Set parameter "At the beginning of the disabling function" / "At the end of the disabling function" to "as input ... when closing the contact" or "as input ... when opening the contact".

The assigned inputs perform the function that the specified input has in the unlocked state. Fixed inputs are any inputs of the device with the function "switch, push button or contacts".

The respective parameterisation of the defined input is executed. If the parameterisation of this input has no function or no telegram when closing or opening, there is also no reaction to the disabling or to the enabling. The telegrams are sent out on the KNX via the communication object of the defined input.

The following table shows all possible telegram reactions of the device depending on the configured function of the set inputs.

Function of the specified input	Reaction "as input ... when closing"	Reaction "as input ... when opening"
Switching / toggling	Switching telegram	Switching telegram
Dimming	Switching telegram	No telegram
Venetian blind	Long time telegram	No telegram
Scene extension	Scene recall telegram	No telegram
1-byte value transmitter	Value telegram	No telegram
2-byte value transmitter	Value telegram	No telegram
3-byte value transmitter	Value telegram(s)	No telegram
6-byte value transmitter	Value telegram(s)	No telegram
2-channel operation Channel 1: 1-bit object type	Switching telegram	No telegram
2-channel operation Channel 1: 1-byte object type	Value telegram	No telegram
2-channel operation Channel 1: 2-byte object type	Value telegram	No telegram
2-channel operation Channel 1: 3-byte object type	Value telegram(s)	No telegram
2-channel operation Channel 1: 6-byte object type	Value telegram(s)	No telegram
Controller extension Operating mode switchover	Operating mode telegram	No telegram

Function of the specified input	Reaction "as input ... when closing"	Reaction "as input ... when opening"
Controller extension Presence function	Presence telegram	No telegram
Controller operation Setpoint shift	Level value telegram	No telegram
No function	No telegram	No telegram

Table 3: Telegram reactions of the device depending on the configured function of the set inputs

- Set parameter "At the beginning of the disabling function" / "At the end of the disabling function" to "as disabling function ... when closing the contact" or "as disabling function ... when opening the contact".

The assigned inputs perform the function that has one of the two virtual disabling functions. The disabling functions are internal input functions with independent communication objects and independent parameters. The same setting options are available for disabling function 1 and disabling function 2 as for the normal inputs.

The respective configuration of the predefined disabling function will be executed. If the parameterisation of this disabling functions has no function or no telegram when closing or opening, there is also no reaction to the disabling or to the enabling.

The table shows all possible telegram reactions of the device depending on the project design of the disabling function for this setting, too. The telegrams are transmitted to the KNX via the communication object of the disabling function.

### Configuring the reaction during a disable

Regardless of the behaviour that the assigned inputs show at the beginning or end of a disabling, the inputs can be influenced separately during a disabling.

The disabling function must be enabled.

- Set the parameter "While active disabling function" to "no reaction to signal changes at the input".

The assigned inputs are completely blocked during a disabling. Closing or opening a contact shows no reaction.

- Set the parameter to "Inputs behave like". Continue to configure the parameters "Input ... behaves like" to the desired input or the desired disabling function.

All assigned inputs behave as defined by the parameterisation of the specified reference inputs or disabling functions. Different but also the same reference inputs can be parameterised for the inputs. The two virtual disabling functions can also be selected as reference inputs.

The telegrams are transmitted to the KNX via the communication objects of the specified reference inputs.

- i** If, at the time of activation or deactivation of a disabling, a signal evaluation is taking place at the affected inputs of the device, this will be terminated immediately.

### 10.10.1 Disabling functions parameters

General... -> General inputs

Disabling function for inputs	Checkbox (yes / no)
<p>The disabling function can be enabled centrally at this point.</p> <p>The locking function for the inputs cannot be used if the inputs act internally on the relay outputs of the device. In this case, the locking function of the outputs can be used.</p>	

Disabling function -> Disabling function

Polarity of disabling object	<b>1 = disable / 0 = enable</b> 0 = disable / 1 = enable
<p>This parameter defines the value of the disabling object at which the disabling function is active.</p>	

Assignment of inputs	<b>all inputs assigned</b> individual inputs assigned
<p>The disabling function affects either all inputs or only a selection. This parameter assigns the inputs to the disabling function.</p> <p>If an NTC temperature sensor is connected to input 3, the disabling function does not act on this input despite assignment!</p>	

Input 1	Checkbox (yes / no)
<p>With the setting "individual inputs assigned", this parameter defines the assignment of the first input to the disabling function.</p>	

Input 2	Checkbox (yes / no)
<p>With the setting "individual inputs assigned", this parameter defines the assignment of the second input to the disabling function.</p>	

Input 3	Checkbox (yes / no)
<p>With the setting "individual inputs assigned", this parameter defines the assignment of the third input to the disabling function.</p> <p>If an NTC temperature sensor is connected to input 3, the disabling function does not act on this input despite assignment!</p>	

<p>At the beginning of the disabling function</p>	<p><b>no reaction</b></p> <p>as input 1 when closing the contact</p> <p>as input 2 when closing the contact</p> <p>as input 3 when closing the contact</p> <p>as input 1 when opening the contact</p> <p>as input 2 when opening the contact</p> <p>as input 3 when opening the contact</p> <p>as disabling function 1 when closing the contact</p> <p>as disabling function 2 when closing the contact</p> <p>as disabling function 1 when opening the contact</p> <p>as disabling function 2 when opening the contact</p>
---	---

If the lock function is used, the reaction of the assigned inputs when the disabling is activated can be set at this point.

<p>While active disabling function</p>	<p><b>no reaction to signal changes at the input</b></p> <p>Inputs behave like</p>
--	--

Regardless of the behaviour that the assigned inputs show at the beginning or end of a disabling, the inputs can be influenced separately during a disabling.

No reaction to signal changes at the input: The assigned inputs are completely blocked during a block. Closing or opening a contact shows no reaction.

Inputs behave like: All assigned inputs behave as defined by the parameterisation of the specified reference inputs or disabling functions. Different but also the same reference inputs can be parameterised for the inputs. The two virtual disabling functions can also be selected as reference inputs.

The telegrams are transmitted to the KNX via the communication objects of the specified reference inputs.

<p>Input ... behaves like</p>	<p>Input 1*</p> <p>Input 2*</p> <p>Input 3*</p> <p>Disabling function 1</p> <p>Disabling function 2</p>
-------------------------------	---

The reference input or the disabling function is defined at this point. The disabled inputs then behave like the reference inputs or virtual disabling functions set at this point.

\*: The default setting depends on the parameter for input 1, 2 or 3.

This parameter is only visible with "While active disabling function = Inputs behave like".

<p>At the end of the disabling function</p>	<p><b>no reaction</b></p> <p>as input 1 when closing the contact</p> <p>as input 2 when closing the contact</p> <p>as input 3 when closing the contact</p> <p>as input 1 when opening the contact</p> <p>as input 2 when opening the contact</p> <p>as input 3 when opening the contact</p> <p>as disabling function 1 when closing the contact</p> <p>as disabling function 2 when closing the contact</p> <p>as disabling function 1 when opening the contact</p> <p>as disabling function 2 when opening the contact</p>
<p>If the lock function is used, the reaction of the assigned inputs when the disabling is deactivated can be set at this point.</p>	

**Disabling function 1 and disabling function 2**

Disabling function -> Disabling function 1

Disabling function -> Disabling function 2

**i** The same parameters are available for the two virtual disabling functions as for the normal inputs.

**10.10.2 Disabling functions objects**

Object no.	Function	Name	Type	DPT	Flag
758	Disabling	Disabling function - input	1-bit	1,002	C, -, W, -, -
1-bit object for activating and deactivating the disabling function for the inputs. The polarity can be configured.					

The two virtual disabling functions each have separate communication objects. The scope of all available objects is the same as for the normal input functions (see documentation of the input functions).



## 11 Logic functions

The device contains up to 8 logic functions. Simple logical operations in a KNX installation can be performed using these functions. Linking of input and output objects allows the networking of logic functions, permitting the execution of complex operations.

### Enabling and configuring the number of logic functions

To be able to use logic functions, they must be enabled centrally on the "General" parameter page.

- Activate the parameter "Use logic functions"

The logic functions can be used. The "Logic functions" parameter node becomes available, which contains additional parameter pages. The configuration of the logic functions takes place in this parameter node.

Logic functions can be enabled in steps so that the number of visible functions and, in consequence, the available parameters and communication objects are visible in the ETS. The number of available logic functions can be defined on the "Logic functions" parameter page

- Configure the "Number of logic functions" parameter to the desired value.  
As many logic functions are created as have been selected.

**i** The application program deletes existing logic functions from the configuration if the number of available functions is reduced.

## 11.1 Logic functions parameters

### General

Logic functions	Checkbox (yes / no)
This parameter enables the logic functions globally. If the parameter is activated, the "Logic functions" parameter node becomes available, which contains additional parameter pages. The configuration of the logic functions takes place in this parameter node.	

Number of logic functions (1...8)	1...8
The number of required logic functions is defined here.	

### Logic functions -> Logic function...

Name of logic function	Free text
The text entered in this parameter is applied to the name of the communication objects and is used for labelling the logic function in the ETS parameter window. The text is not programmed in the device.	

<p>Type of logic function</p>	<p><b>Logic gates</b>            Converter (1 bit -&gt; 1 byte)            Disabling element [Filtering/Time]            Comparator            Limit value switch with hysteresis</p>
<p>It is possible to be define which logical operation is to be executed for each logic function. This parameter is only visible if the logic functions have been enabled on the "General" parameter page.</p> <p>Logic gates: The logic function works as a Boolean logic gate with optionally 1 ... 4 inputs and one output.</p> <p>Converter (1 bit -&gt; 1 byte): The logic function is configured as a converter. The converter has a 1-bit input and a 1-byte output and also a disabling object. ON / OFF telegrams can be converted to preconfigured values. The disabling object is able to deactivate the converter</p> <p>Disabling element (Filtering/Time): The logic function is configured as a disabling element. The disabling element has a 1-bit input and a 1-bit output. This logic function can delay input signals depending on the state (ON or OFF) and output them filtered at the output. A disabling object is also available, which can be used to deactivate the disabling element.</p> <p>Comparator: The logic function works as a comparator with an input whose data format can be parameterised, and with a 1-bit output to output the result of the comparison operation. The reference function and the reference value are configured in the ETS.</p> <p>Limit value switch with hysteresis: The logic function acts like a limit switch with hysteresis. An input with a configurable data format and a 1-bit output are available. The hysteresis is determined by an upper and lower threshold. The threshold values can be parameterised in the ETS. The input value is compared with the threshold values. The command at the output (ON / OFF) upon exceeding or falling below the configured threshold values can be configured.</p>	

## 11.2 Logic gates

A logic gate has up to 4 Boolean inputs (1 bit) and one logic output (1 bit). In consequence, a logic operation only supports the 1-bit data format. The following table shows configurable comparison operations Logic gate and explains their function.

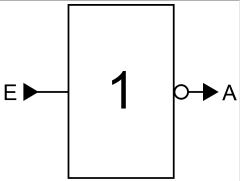
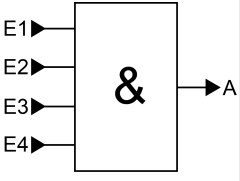
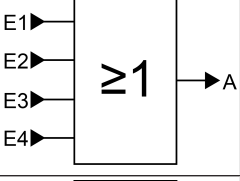
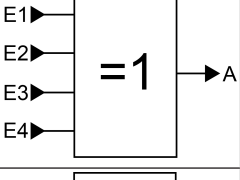
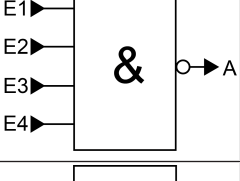
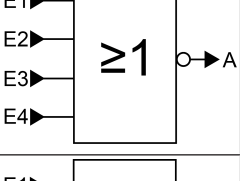
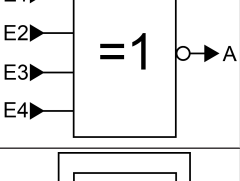
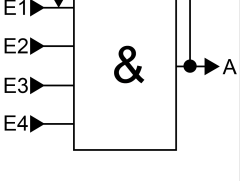
Logic gates	Description	Icon
Invert (NOT)	The logic gate has only one input. The input is forwarded to the gate output inverted.	
AND (AND)	Logic gate has 4 inputs The output is "1" if all inputs are "1". Otherwise the output is "0".	
OR (OR)	Logic gate has 4 inputs The output is "0" if all inputs are "0". Otherwise the output is "1".	
Exclusive OR (XOR)	Logic gate has 4 inputs The output is "1" if only one input is "1". Otherwise the output is "0".	
inverted AND (NAND)	Logic gate has 4 inputs The output is "0" if all inputs are "1". Otherwise the output is "1".	
inverted OR (NOR)	Logic gate has 4 inputs The output is "1" if all inputs are "0". Otherwise the output is "0".	
inverted Exclusive OR (NXOR)	Logic gate has 4 inputs The output is "0" if only one input is "1". Otherwise the output is "1".	
AND with feedback (ANDR)	Logic gate has 4 inputs The output is fed back to the first input of the gate. The output is "1" if all inputs are "1". Otherwise the output is "0". If input 1 is set to "1" and the output is still "0", the feedback of input 1 is also reset to "0". Only when	

Logic gates	Description	Icon
	<p>inputs 2 ... 4 are "1" will a newly received "1" at input 1 cause the output to assume the logical state "1".</p> <p>Application: Switch light manually only at twilight                      -&gt; Switch on input 1, twilight sensor on input 2                      -&gt; The manual switching signal is ignored for as long as the twilight sensor has not issued an enabling signal. The manual switching sign is only executed at twilight.</p>	

Inputs of a logic gate can be activated or deactivated separately. This allows gates with an individual number of inputs (1 ... 4) to be implemented. As an option, it is possible to invert inputs.

The transmission behaviour of the gate output can be configured.

### 11.2.1 Logic gate parameters

Logic functions -> Logic function...

Selection logic gate	Invert (NOT) <b>AND (AND)</b> OR (OR) Exclusive OR (XOR) inverted AND (NAND) inverted OR (NOR) inverted Exclusive OR (NXOR) AND with feedback (ANDR)
<p>This parameter defines the function of the logic gate and is only visible if "Type of logic function = logic gate".</p> <p>Invert (NOT): The inverter is configured. The gate has one input and one output. The Boolean data value of the input is forwarded to the output inverted.</p> <p>And (AND): An AND gate is configured. The gate has 1...4 inputs and one output. The inputs are logically AND-linked. The result is forwarded to the output.</p> <p>Or (OR): An OR gate is configured. The gate has 1...4 inputs and one output. The inputs are logically OR-linked. The result is forwarded to the output.</p> <p>Exclusive-OR (XOR): An exclusive-OR gate is configured. The gate has 1...4 inputs and one output. The inputs are logically Exclusive-OR-linked. The result is forwarded to the output.</p> <p>inverted And (NAND): An AND gate is configured. The gate has 1...4 inputs and one output. The inputs are logically AND-linked. The result is forwarded to the output inverted.</p> <p>inverted OR (NOR): An OR gate is configured. The gate has 1...4 inputs and one output. The inputs are logically OR-linked. The result is forwarded to the output inverted.</p> <p>Inverted Exclusive-OR (NXOR): An inverted Exclusive-OR gate is configured. The gate has 1...4 inputs and one output. The inputs are logically Exclusive-OR-linked. The result is forwarded to the output inverted.</p> <p>AND with feedback (ANDR): An AND gate with feedback is configured. The gate has 1...4 inputs and one output. The output is fed back to the first input of the gate.</p>	
Input 1	deactivated <b>input object</b>
<p>Inputs of a logic gate can be activated or deactivated separately. This allows gates with an individual number of inputs (1 ... 4) to be implemented. This parameter defines whether the first input of the gate should be used.</p> <p>This parameter is only visible if "Type of logic function = logic gate".</p>	

Input 2	deactivated input object
<p>Inputs of a logic gate can be activated or deactivated separately. This allows gates with an individual number of inputs (1 ... 4) to be implemented. This parameter defines whether the second input of the gate should be used.</p> <p>This parameter is only visible if "Type of logic function = logic gate".</p>	
Input 3	deactivated input object
<p>Inputs of a logic gate can be activated or deactivated separately. This allows gates with an individual number of inputs (1 ... 4) to be implemented. This parameter defines whether the third input of the gate should be used.</p> <p>This parameter is only visible if "Type of logic function = logic gate".</p>	
Input 4	deactivated input object
<p>Inputs of a logic gate can be activated or deactivated separately. This allows gates with an individual number of inputs (1 ... 4) to be implemented. This parameter defines whether the fourth input of the gate should be used.</p> <p>This parameter is only visible if "Type of logic function = logic gate".</p>	
Invert input	Checkbox (yes / no)
<p>It is possible to invert inputs of the logic gate as an option. This parameter is available for each input of the gate and defines whether the respective input should be evaluated unchanged or inverted.</p> <p>This parameter is only visible if "Type of logic function = logic gate".</p>	
Transmission criteria	always transmit when the input is updated send only if the output changes transmit cyclically
<p>The transmission behaviour of the output can be configured here.</p> <p><b>Always transmit when the input is updated:</b> The output transmits the current object value to the KNX with every telegram that is received at the input.</p> <p><b>Transmit only if the output changes:</b> The output only transmits the current object value if the object value has changed compared to the last transmission process. During the first telegram to an input after bus voltage return or after an ETS programming operation, the output always transmits to an input.</p> <p><b>transmit cyclically:</b> With this setting, the output transmits the current object value to the KNX cyclically. The cyclical transmission is only started by the first valid trigger after the first telegram has been received at the input. The output also transmits as soon as a new telegram is received at the input. At the same time, the cycle time for cyclical sending is restarted!</p>	

Transmission delay for sending the result hours (0...99)	0...99
<p>An optional delay before result transmission (telegram at output) can be configured. With the setting "always transmit when the input is updated": Telegrams at the output are only transmitted after the trigger when the delay has elapsed. The delay time is restarted by each telegram at the input.</p> <p>With the setting "only transmit if the output changes": Telegrams are only sent when the object value changes at the output if the delay has expired. If the logic function is reprocessed by a new telegram at the input within the delay time and the object value changes again, then the delay restarts. If the object value of the output does not change due to new input telegrams, the delay does not restart.</p> <p>This parameter defines the hours of the delay time.</p>	
Minutes (0...59)	0...59
<p>This parameter defines the minutes of the delay time.</p>	
Seconds (0...59)	0...59
<p>This parameter defines the seconds of the delay time.</p> <p>The parameters for the transmission delay are only visible for "Transmission criteria" = "Always transmit when the input is updated" and "Only transmit when the output changes".</p>	
Cycle time hours (0...99)	0...99
<p>During cyclical transmission of the output, this parameter defines the cycle time. Setting the cycle time hours.</p>	
Minutes (0...59)	0...5...59
<p>This parameter defines the minutes of the cycle time.</p>	
Seconds (0...59)	0...59
<p>This parameter defines the seconds of the cycle time.</p> <p>The parameters for the cycle time are only visible if "transmission criteria" = "transmit cyclically".</p>	



### 11.2.2 Logic gates objects

Object no.	Function	Name	Type	DPT	Flag
295, 299, 303, 307, 311, 315, 319, 323	Logic gate...Input 1	Logic... - Input	1-bit	1,002	C, (R), W, -, A
<p>1-bit object as input 1 of a logic gate (1...8). The input status can be inverted optionally.</p> <p>This object is only available if the type of logic function is configured to "logic gate" and input 1 is used..</p>					

Object no.	Function	Name	Type	DPT	Flag
296, 300, 304, 308, 312, 316, 320, 324	Logic gate...Input 2	Logic... - Input	1-bit	1,002	C, (R), W, -, A
<p>1-bit object as input 2 of a logic gate (1...8). The input status can be inverted optionally.</p> <p>This object is only available if the type of logic function is configured to "logic gate" and input 2 is used..</p>					

Object no.	Function	Name	Type	DPT	Flag
297, 301, 305, 309, 313, 317, 321, 325	Logic gate...Input 3	Logic... - Input	1-bit	1,002	C, (R), W, -, A
<p>1-bit object as input 3 of a logic gate (1...8). The input status can be inverted optionally.</p> <p>This object is only available if the type of logic function is configured to "logic gate" and input 3 is used..</p>					

Object no.	Function	Name	Type	DPT	Flag
298, 302, 306, 310, 314, 318, 322, 326	Logic gate...Input 4	Logic... - Input	1-bit	1,002	C, (R), W, -, A
<p>1-bit object as input 4 of a logic gate (1...8). The input status can be inverted optionally.</p> <p>This object is only available if the type of logic function is configured to "logic gate" and input 4 is used..</p>					

Object no.	Function	Name	Type	DPT	Flag
383, 385, 387, 389, 391, 393, 395, 397	Logic gate output	Logic... - Output	1-bit	1,002	C, R, -, T, A
<p>1-bit object as output of a logic gate (1...8).</p> <p>This object is only available if the type of logic function is configured to "logic gate".</p>					

### 11.3 Converter (1 bit -> 1 byte)

The converter has a 1-bit input and a 1-byte output and also a disabling object. ON / OFF telegrams can be converted to preconfigured values. The disabling object is able to deactivate the converter

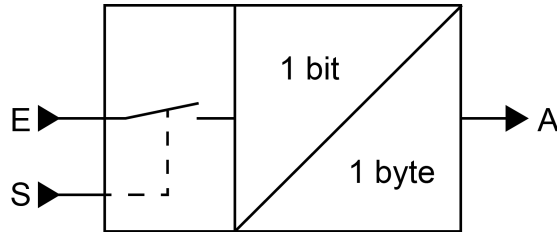

Image 42: Converter (1 bit -> 1 byte)

The converter can react differently to input states. The parameter "Reaction at input to" defines whether the converter responds to ON and OFF commands or alternatively only processes ON or OFF telegrams.

A concrete 1-byte output value can be assigned to each 1-bit input status. The two output values can be configured anywhere in the range 0 ... 255 as required. The data format of the converter output object is set to DPT 5.001 (0...100%).

The disabling object can be deactivated via the converter. A deactivated converter no longer processes input states and consequently does not convert any new output values (the last value is retained and transmitted cyclically, if necessary). At the end of a disabling function, the converter is enabled again. The converter then waits for the next telegram at the input.

The telegram polarity of the disabling object can be configured.

The transmission behaviour of the converter output can be configured.

### 11.3.1 Converter parameters

Logic functions -> Logic function...

Reaction at input to	<b>ON and OFF telegrams</b> ON telegrams OFF telegrams
The converter can react differently to input states. It is defined here whether the converter responds to ON and OFF commands or alternatively only processes ON or OFF telegrams.	
Polarity of the disabling object	<b>0 = enabled / 1 = disabled</b> 0 =disabled/ 1 = enabled
This parameter defines the polarity of the disabling object.	
Output value for ON (0...255)	<b>0...255</b>
A concrete 1-byte output value can be assigned to each 1-bit input status. This parameter defines the output value for ON telegrams. This parameter is only visible when the input should react to ON telegrams.	
Output value for OFF (0...255)	<b>0...255</b>
A concrete 1-byte output value can be assigned to each 1-bit input status. This parameter defines the output value for OFF telegrams. This parameter is only visible when the input should react to OFF telegrams.	
Transmission criteria	<b>always transmit when the input is updated</b> send only if the output changes transmit cyclically
The transmission behaviour of the output can be configured here. Always transmit when the input is updated: The output transmits the current object value to the KNX with every telegram that is received at the input. Transmit only if the output changes: The output only transmits the current object value if the object value has changed compared to the last transmission process. During the first telegram to an input after bus voltage return or after an ETS programming operation, the output always transmits to an input. transmit cyclically: With this setting, the output transmits the current object value to the KNX cyclically. The cyclical transmission is only started by the first valid trigger after the first telegram has been received at the input. The output also transmits as soon as a new telegram is received at the input. At the same time, the cycle time for cyclical sending is restarted!	

Transmission delay for sending the result hours (0...99)	0...99
<p>An optional delay before result transmission (telegram at output) can be configured. With the setting "always transmit when the input is updated": Telegrams at the output are only transmitted after the trigger when the delay has elapsed. The delay time is restarted by each telegram at the input.</p> <p>With the setting "only transmit if the output changes": Telegrams are only sent when the object value changes at the output if the delay has expired. If the logic function is reprocessed by a new telegram at the input within the delay time and the object value changes again, then the delay restarts. If the object value of the output does not change due to new input telegrams, the delay does not restart.</p> <p>This parameter defines the hours of the delay time.</p>	
Minutes (0...59)	0...59
<p>This parameter defines the minutes of the delay time.</p>	
Seconds (0...59)	0...59
<p>This parameter defines the seconds of the delay time.</p> <p>The parameters for the transmission delay are only visible for "Transmission criteria" = "Always transmit when the input is updated" and "Only transmit when the output changes".</p>	
Cycle time hours (0...99)	0...99
<p>During cyclical transmission of the output, this parameter defines the cycle time. Setting the cycle time hours.</p>	
Minutes (0...59)	0...5...59
<p>This parameter defines the minutes of the cycle time.</p>	
Seconds (0...59)	0...59
<p>This parameter defines the seconds of the cycle time.</p> <p>The parameters for the cycle time are only visible if "transmission criteria" = "transmit cyclically".</p>	

### 11.3.2 Converter objects

Object no.	Function	Name	Type	DPT	Flag
295, 299, 303, 307, 311, 315, 319, 323	Converter Input	Logic... - Input	1-bit	1,002	C, (R), W, -, A
<p>1-bit object as input of a converter. It is possible to configure whether the converter responds to ON and OFF commands or alternatively only processes ON or OFF telegrams.</p> <p>This object is only available if the type of logic function is configured to "converter".</p>					

Object no.	Function	Name	Type	DPT	Flag
296, 300, 304, 308, 312, 316, 320, 324	Converter Disabling function	Logic... - Input	1-bit	1,002	C, (R), W, -, A
<p>1-bit object as disabling input of a converter. A disabled converter no longer processes input states and consequently does not convert any new output values (the last value is retained and transmitted cyclically, if necessary).</p> <p>The telegram polarity can be configured.</p> <p>This object is only available if the type of logic function is configured to "converter".</p>					

Object no.	Function	Name	Type	DPT	Flag
431, 432, 433, 434, 435, 436, 437, 438	Converter Output	Logic... - Output	1 bytes	5,001	C, R, -, T, A
<p>1-byte object as value output of a converter.</p> <p>This object is only available if the type of logic function is configured to "converter".</p>					

### 11.4 Disabling element [Filtering/Time]

The disabling element has a 1-bit input and a 1-bit output as well as a disabling object. Input states (ON/OFF) can be delayed independently of one another and filtered at the output before output. The filter makes it possible to invert the states of the output (e.g. ON -> OFF) or to suppress it completely (e.g. OFF -> ---, OFF is not transmitted). If the filter is not used, the disabling element only works with the time functions if required. Alternatively, it is possible to use only the filter (without delays).

The disabling object is able to deactivate the disabling element.

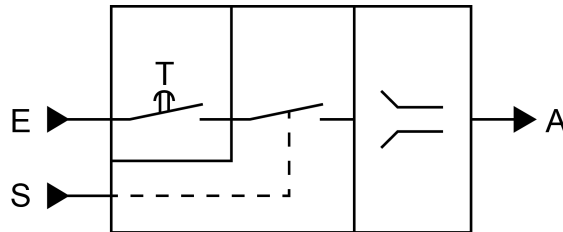

Image 43: Disabling element [Filtering/Time]

The parameter "Time function" defines whether ON or OFF telegrams or both states are evaluated with a delay after reception at the input. If a delay is provided, the delay time can be configured separately for ON and OFF telegrams. A delay is only effective if the delay time is set to greater than "0". Each telegram received at the input re-triggers the receptive delay time.

If no delay is configured, the input telegrams go directly into the filter.

**i** Special feature when using the delays: If no telegram is received at the input, a configured delay time (time > 0) acts like an automatic cyclic trigger of the filter. The most recently received input status is then forwarded to the filter automatically and repeatedly after the delay has elapsed. This then works according to its configuration and forwards the result to the output of the disabling element. Consequently, the output then also transmits telegrams depending on the transmission criteria set. If the cyclical transmission of the output is not desired due to the automatic triggering of the filter, the transmission criterion should be set to "only transmit if the output changes".

If no delay is provided, the filter is only triggered automatically via the received telegrams and thus not automatically.

**i** After bus voltage return or after an ETS programming operation, the delays are triggered automatically.

The filter is set by the parameter "Filter function" according to the following table.

Filter function	Result
ON -> OFF / OFF -> OFF	Input telegrams are forwarded to the output unchanged. Filter deactivated.
ON -> --- / OFF -> OFF	ON telegrams are filtered and not forwarded to the output. OFF telegrams are forwarded to the output unchanged.

Filter function	Result
ON -> ON / OFF -> ---	OFF telegrams are filtered and not forwarded to the output. ON telegrams are forwarded to the output unchanged.
ON -> OFF / OFF -> ON	ON telegrams are converted to OFF telegrams and OFF telegrams are converted to ON telegrams and are forwarded to the output.
ON -> --- / OFF -> ON	ON telegrams are filtered and not forwarded to the output. OFF telegrams are converted to ON telegrams and forwarded to the output.
ON -> OFF / OFF -> ---	OFF telegrams are filtered and not forwarded to the output. ON telegrams are converted to OFF telegrams and forwarded to the output.

The disabling element can be deactivated by the disabling object. A deactivated disabling element no longer forwards any input states to the filter and consequently does not convert any new output values (the last value is retained and transmitted cyclically, if necessary). However, the input states are still evaluated (even with effective delays). At the end of a disabling function, the disabling element is enabled again. The disabling element waits for the next telegram at the input or for the next cycle of the configured delay times.

The telegram polarity of the disabling object can be configured.

The transmission behaviour of the disabling element output can be configured.



### 11.4.1 Disabling element parameters

Logic functions -> Logic function...

Time function	<b>no delay</b> only delay ON telegrams only delay OFF telegrams delay ON and OFF telegrams
---------------	--

This parameter defines whether ON or OFF telegrams or both states are evaluated with a delay after reception at the input. If a delay is provided, the delay time can be configured separately for ON and OFF telegrams. If no delay is configured, the input telegrams go directly into the filter.

Delay for ON telegrams Minutes (0...59)	0...59
--	--------

The delay for ON telegrams is configured here. A delay is only effective if the delay time is set to greater than "0". Each ON telegram received at the input re-triggers the delay time.

Special feature when using the delays: If no telegram is received at the input, a configured delay time (time > 0) acts like an automatic cyclic trigger of the filter. The most recently received input status is then forwarded to the filter automatically and repeatedly after the delay has elapsed. This then works according to its configuration and forwards the result to the output of the disabling element. Consequently, the output then also transmits telegrams depending on the transmission criteria set. If the cyclical transmission of the output is not desired due to the automatic triggering of the filter, the transmission criterion should be set to "only transmit if the output changes".

After bus voltage return or after an ETS programming operation, the delays are triggered automatically.

Setting the ON delay time minutes.

Seconds (0...59)	0...10...59
------------------	-------------

Setting the seconds of the ON delay time.

The parameters for the ON delay are only available if the parameter "Time function" is set to "only delay ON telegrams" or "delay ON and OFF telegrams".

Delay for OFF telegrams Minutes (0...59)	0...59
<p>The delay for OFF telegrams is configured here. A delay is only effective if the delay time is set to greater than "0". Each OFF telegram received at the input re-triggers the delay time.</p> <p>Special feature when using the delays: If no telegram is received at the input, a configured delay time (time &gt; 0) acts like an automatic cyclic trigger of the filter. The most recently received input status is then forwarded to the filter automatically and repeatedly after the delay has elapsed. This then works according to its configuration and forwards the result to the output of the disabling element. Consequently, the output then also transmits telegrams depending on the transmission criteria set. If the cyclical transmission of the output is not desired due to the automatic triggering of the filter, the transmission criterion should be set to "only transmit if the output changes".</p> <p>After bus voltage return or after an ETS programming operation, the delays are triggered automatically.</p> <p>Setting the OFF delay time minutes.</p>	
Seconds (0...59)	0...10...59
<p>Setting the OFF delay time seconds.</p> <p>The parameters for the OFF delay are only available if the parameter "Time function" is set to "only delay OFF telegrams" or "delay ON and OFF telegrams".</p>	
Polarity of the disabling object	<p>0 = enabled / 1 = disabled</p> <p>0 =disabled/ 1 = enabled</p>
<p>This parameter defines the polarity of the disabling object.</p>	

Filter function	ON -> OFF / OFF -> OFF ON -> --- / OFF -> OFF ON -> ON / OFF -> --- ON -> OFF / OFF -> ON ON -> --- / OFF -> ON ON -> OFF / OFF -> ---
-----------------	---

This parameter defines the function of the filter.

ON -> ON / OFF -> OFF: Input telegrams are forwarded to the output unchanged. Filter deactivated.

ON -> --- / OFF -> OFF: ON telegrams are filtered and not forwarded to the output. OFF telegrams are forwarded to the output unchanged.

ON -> ON / OFF -> ---: OFF telegrams are filtered and not forwarded to the output. ON telegrams are forwarded to the output unchanged.

ON -> OFF / OFF -> ON: ON telegrams are converted to OFF telegrams and OFF telegrams are converted to ON telegrams and forwarded to the output.

ON -> --- / OFF -> ON: ON telegrams are filtered and not forwarded to the output. OFF telegrams are converted to ON telegrams and forwarded to the output.

ON -> OFF / OFF -> ---: OFF telegrams are filtered and not forwarded to the output. ON telegrams are converted to OFF telegrams and forwarded to the output.

Transmission criteria	always transmit when the input is updated send only if the output changes transmit cyclically
-----------------------	---

The transmission behaviour of the output can be configured here.

Always transmit when the input is updated: The output transmits the current object value to the KNX with every telegram that is received at the input. In addition, transmission at the output is repeated if no telegram was received at the input when the delay times were used and the configured time has expired.

Transmit only if the output changes: The output only transmits the current object value if the object value has changed compared to the last transmission process. After bus voltage return or an ETS programming operation, the output always transmits.

transmit cyclically: With this setting, the output transmits the current object value to the KNX cyclically. The cyclical transmission is only started by the first valid trigger after the first telegram has been received at the input. If the ON / OFF delay is used, after bus voltage return or after an ETS programming, operation cyclical transmission starts automatically once the delay time has expired. The output also transmits as soon as a new telegram is received at the input. At the same time, the cycle time for cyclical sending is restarted!

Cycle time hours (0...99)	0...99
---------------------------	--------

During cyclical transmission of the output, this parameter defines the cycle time. Setting the cycle time hours.

Minutes (0...59)	0...5...59
This parameter defines the minutes of the cycle time.	
Seconds (0...59)	0...59
This parameter defines the seconds of the cycle time. The parameters for the cycle time are only visible if "transmission criteria" = "transmit cyclically".	

### 11.4.2 Disabling element objects

Object no.	Function	Name	Type	DPT	Flag
295, 299, 303, 307, 311, 315, 319, 323	Disabling element Input	Logic... - Input	1-bit	1,002	C, (R), W, -, A
<p>1-bit object as input of a disabling element.</p> <p>This object is only available if the type of logic function is configured to "disabling element".</p>					

Object no.	Function	Name	Type	DPT	Flag
296, 300, 304, 308, 312, 316, 320, 324	Disabling element Disabling function	Logic... - Input	1-bit	1,002	C, (R), W, -, A
<p>1-bit object as disabling input of a disabling element. A disabled disabling element no longer forwards any input states to the filter and consequently does not convert any new output values (the last value is retained and transmitted cyclically, if necessary).</p> <p>The telegram polarity can be configured.</p> <p>This object is only available if the type of logic function is configured to "disabling element".</p>					

Object no.	Function	Name	Type	DPT	Flag
384, 386, 388, 390, 392, 394, 396, 398	Disabling element Output	Logic... - Output	1-bit	1,002	C, R, -, T, A
<p>1-bit object as output of a disabling element.</p> <p>This object is only available if the type of logic function is configured to "disabling element".</p>					

### 11.5 Comparator

The comparator works with an input whose data format can be parameterised, and with a 1-bit output to output the result of the comparison operation. The comparator compares the value received at the input with a configured reference value and evaluates whether the reference is correct (result = true) or not (result = false) according to the specified reference function.

The reference function and the reference value are configured in the ETS.

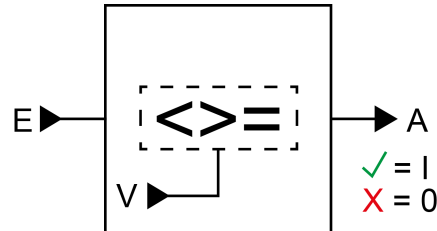

Image 44: Comparator

The parameter "data format" defines the size and format of input object according to the following table. The output object is preset to 1-bit (DPT 1.002) and outputs the result of the comparison operation (ON = true / OFF = false). The reference value that can be set in the ETS adapts to the input data format.

Data format	KNX DPT
4-bit dimming	3,007
1-byte operating mode switchover	20,102
1- byte scene extension	18,001
1-byte value 0...255	5,010
1-byte brightness value 0...100%	5,001
2-byte value 0...65535	7,001
2-byte value -32768...32767	8,001
2-byte floating-point number	9.0xx
4-byte value -2147483648...2147483647	13,001

The following table shows the possible reference functions (I = input value, R = reference value).

Reference function	Function
equal (I = R)	The comparator output is "ON" (true) if the input is equal to the reference value. Otherwise the output is "OFF" (false).
unequal (I ≠ R)	The comparator output is "ON" (true) if the input is unequal to the reference value. If the input value is equal to the reference value, the output is "OFF" (false).
greater than (I > R)	The comparator output is "ON" (true) if the input is greater than the reference value. If the input value is less than or equal to the reference value, the output switches "OFF" (false).

Reference function	Function
greater than or equal to ( $I \geq R$ )	The comparator output is "ON" (true) if the input is greater than the reference value or equal to the reference value. If the input value is less than the reference value, the output switches "OFF" (false).
less than ( $I < R$ )	The comparator output is "ON" (true) if the input is less than the reference value. If the input value is greater than or equal to the reference value, the output switches "OFF" (false).
less than or equal to ( $I \leq R$ )	The comparator output is "ON" (true) if the input is less than the reference value or equal to the reference value. If the input value is greater than the reference value, the output switches "OFF" (false).
range testing less than ( $R1 < I < R2$ )	There are two reference values. The comparator output is "ON" (true) if the input is greater than the first reference value or less than the second reference value. If the input value is less than the first reference value or equal to the first reference value or greater than the second reference value or equal to the second reference value, the output switches "OFF" (wrong).
range testing less than or equal to ( $R1 \leq I \leq R2$ )	There are two reference values. The comparator output is "ON" (true) if the input is greater than or equal to the first reference value and less than or equal to the second reference value, the output switches "OFF" (false). If the input value is less than the first reference value or greater than the second reference value, the output switches "OFF" (false).

The transmission behaviour of the comparator output can be configured.

### 11.5.1 Comparator parameters

The comparator works with an input whose data format can be parameterised, and with a 1-bit output to output the result of the comparison operation. The comparator compares the value received at the input with a configured reference value and evaluates whether the reference is correct (result = true) or not (result = false) according to the specified reference function.

The reference function and the reference value are configured in the ETS.

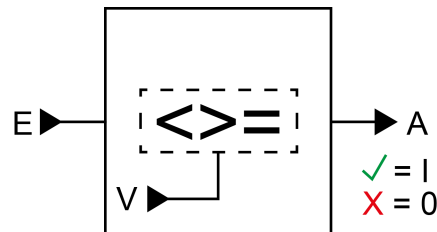

Image 45: Comparator

The parameter "data format" defines the size and format of input object according to the following table. The output object is preset to 1-bit (DPT 1.002) and outputs the result of the comparison operation (ON = true / OFF = false). The reference value that can be set in the ETS adapts to the input data format.

Data format	KNX DPT
4-bit dimming	3,007
1-byte operating mode switchover	20,102
1- byte scene extension	18,001
1-byte value 0...255	5,010
1-byte brightness value 0...100%	5,001
2-byte value 0...65535	7,001
2-byte value -32768...32767	8,001
2-byte floating-point number	9.0xx
4-byte value -2147483648...2147483647	13,001

The following table shows the possible reference functions (I = input value, R = reference value).



Reference function	Function
equal ( $I = R$ )	The comparator output is "ON" (true) if the input is equal to the reference value. Otherwise the output is "OFF" (false).
unequal ( $I \neq R$ )	The comparator output is "ON" (true) if the input is unequal to the reference value. If the input value is equal to the reference value, the output is "OFF" (false).
greater than ( $I > R$ )	The comparator output is "ON" (true) if the input is greater than the reference value. If the input value is less than or equal to the reference value, the output switches "OFF" (false).
greater than or equal to ( $I \geq R$ )	The comparator output is "ON" (true) if the input is greater than the reference value or equal to the reference value. If the input value is less than the reference value, the output switches "OFF" (false).
less than ( $I < R$ )	The comparator output is "ON" (true) if the input is less than the reference value. If the input value is greater than or equal to the reference value, the output switches "OFF" (false).
less than or equal to ( $I \leq R$ )	The comparator output is "ON" (true) if the input is less than the reference value or equal to the reference value. If the input value is greater than the reference value, the output switches "OFF" (false).
range testing less than ( $R1 < I < R2$ )	There are two reference values. The comparator output is "ON" (true) if the input is greater than the first reference value or less than the second reference value. If the input value is less than the first reference value or equal to the first reference value or greater than the second reference value or equal to the second reference value, the output switches "OFF" (wrong).
range testing less than or equal to ( $R1 \leq I \leq R2$ )	There are two reference values. The comparator output is "ON" (true) if the input is greater than or equal to the first reference value and less than or equal to the second reference value, the output switches "OFF" (false). If the input value is less than the first reference value or greater than the second reference value, the output switches "OFF" (false).

The transmission behaviour of the comparator output can be configured.

### 11.5.2 Comparator objects

Object no.	Function	Name	Type	DPT	Flag
327, 328, 329, 330, 331, 332, 333, 334	Comparator Input	Logic... - Input	4-bit	3,007	C, (R), W, -, A
<p>4-bit object as input of a comparator.</p> <p>This object is only available if the type of logic function is configured to "comparator" and the data format is configured to "4-bit dimming (DPT 3.007)".</p>					

Object no.	Function	Name	Type	DPT	Flag
343, 344, 345, 346, 347, 348, 349, 350	Comparator Input	Logic... - Input	1 bytes	20,102	C, (R), W, -, A
<p>1-byte object as input of a comparator.</p> <p>This object is only available if the type of logic function is configured to "comparator" and the data format is configured to "1 byte operating mode switchover (DPT 20.102)".</p>					

Object no.	Function	Name	Type	DPT	Flag
343, 344, 345, 346, 347, 348, 349, 350	Comparator Input	Logic... - Input	1 bytes	18,001	C, (R), W, -, A
<p>1-byte object as input of a comparator.</p> <p>This object is only available if the type of logic function is configured to "comparator" and the data format is configured to "1 byte scene extension (DPT 18.001)".</p>					

Object no.	Function	Name	Type	DPT	Flag
343, 344, 345, 346, 347, 348, 349, 350	Comparator Input	Logic... - Input	1 bytes	5,010	C, (R), W, -, A
<p>1-byte object as input of a comparator.</p> <p>This object is only available if the type of logic function is configured to "comparator" and the data format is configured to "1-byte value 0...255 (DPT 5.010)".</p>					

Object no.	Function	Name	Type	DPT	Flag
343, 344, 345, 346, 347, 348, 349, 350	Comparator Input	Logic... - Input	1 bytes	5,001	C, (R), W, -, A

1-byte object as input of a comparator.

This object is only available if the type of logic function is configured to "comparator" and the data format is configured to "1-byte brightness value 0...100 % (DPT 5.001)".

Object no.	Function	Name	Type	DPT	Flag
359, 360, 361, 362, 363, 364, 365, 366	Comparator Input	Logic... - Input	2 bytes	7,001	C, (R), W, -, A

2-byte object as input of a comparator.

This object is only available if the type of logic function is configured to "comparator" and the data format is configured to "2-byte value 0...65535 (DPT 7.001)".

Object no.	Function	Name	Type	DPT	Flag
359, 360, 361, 362, 363, 364, 365, 366	Comparator Input	Logic... - Input	2 bytes	8,001	C, (R), W, -, A

2-byte object as input of a comparator.

This object is only available if the type of logic function is configured to "comparator" and the data format is configured to "2-byte value -32768...32767 (DPT 8.001)".

Object no.	Function	Name	Type	DPT	Flag
359, 360, 361, 362, 363, 364, 365, 366	Comparator Input	Logic... - Input	2 bytes	9,xxx	C, (R), W, -, A

2-byte object as input of a comparator.

This object is only available if the type of logic function is configured to "comparator" and the data format is configured to "2-byte floating point value (DPT 9.0xx)".

Object no.	Function	Name	Type	DPT	Flag
375, 376, 377, 378, 379, 380, 381, 382	Comparator Input	Logic... - Input	4 bytes	13,001	C, (R), W, -, A

4-byte object as input of a comparator.

This object is only available if the type of logic function is configured to "comparator" and the data format is configured to "4-byte value -2147483648...2147483647 (DPT 13.001)".

Object no.	Function	Name	Type	DPT	Flag
383, 385, 387, 389, 391, 393, 395, 397	Comparator Output	Logic... - Output	1-bit	1,002	C, R, -, T, A
<p>1-bit object as output of a comparator. The output object is preset to 1-bit (DPT 1.002) and outputs the result of the comparison operation (ON = true / OFF = false). This object is only available if the type of logic function is configured to "comparator".</p>					

### 11.6 Limit value switch

The limit value switch works with an input whose data format can be configured, and with a 1-bit output to output the result of the threshold evaluation. The limit value switch compares the value received at the input with two configurable hysteresis threshold values. Once the upper threshold value (H2) is reached or exceeded, the output can transmit a switching telegram (e.g. ON = true). If the value falls below the lower threshold value (H1), the output can transmit another switching telegram (e.g. OFF = false).

The switching telegrams can always be configured in the ETS when the threshold values are exceeded and undershot.

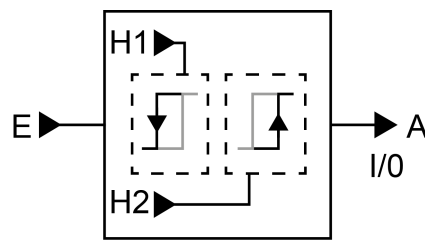

Image 46: Limit value switch

The two threshold values define a hysteresis. The hysteresis prevents frequent switching backwards and forwards of the output if the input value constantly changes in small intervals. Only when the change in value at the input exceeds the hysteresis as a whole, does the output switch the status.

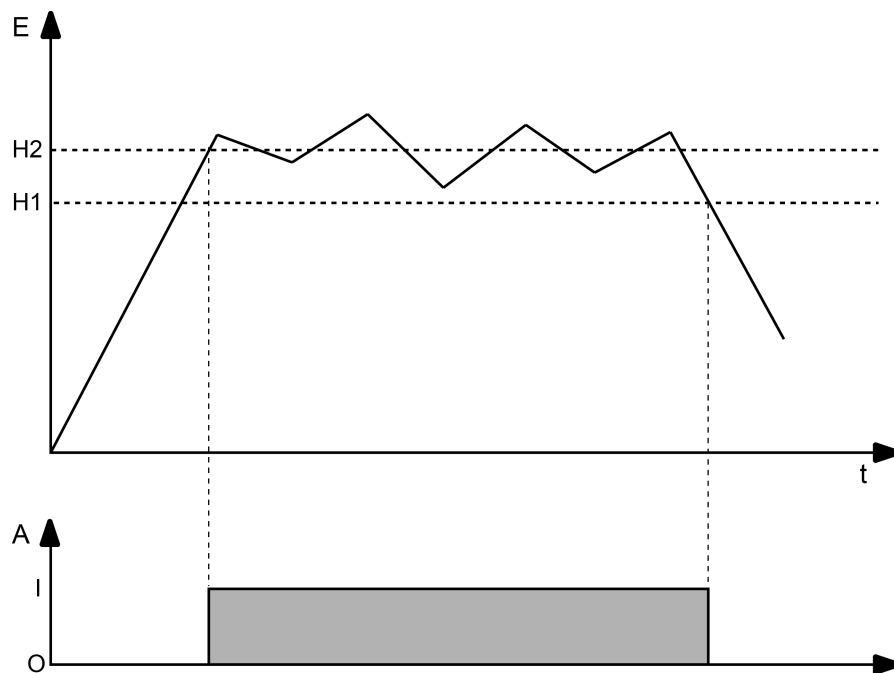

Image 47: Example of a hysteresis evaluation by upper and lower threshold value.

- i** The two threshold values can be freely configured in the ETS. Make sure that the upper threshold value is greater than the lower one!

- i** After bus voltage return or after an ETS programming operation, the output always transmits a telegram when the first value has been received at the input. The telegram depends on whether the value reaches or exceeds the upper threshold (H2) or not. If the value is less than the upper threshold, a telegram is transmitted in accordance with "Telegram upon not reaching the lower threshold". Otherwise the output transmits the "telegram on exceeding the upper threshold value".

The parameter "data format" defines the size and format of input object according to the following table. The output object is preset to 1-bit (DPT 1.002) and outputs the result of the threshold evaluation (ON = true / OFF = false). The threshold values that can be set in the ETS adapt to the input data format.

Data format	KNX DPT
4-bit dimming	3,007
1-byte operating mode switchover	20,102
1- byte scene extension	18,001
1-byte value 0...255	5,010
1-byte brightness value 0...100%	5,001
2-byte value 0...65535	7,001
2-byte value -32768...32767	8,001
2-byte floating-point number	9.0xx
4-byte value -2147483648...2147483647	13,001

The transmission behaviour of the limit value switch can be configured.

### 11.6.1 Limit value switch parameters

The limit value switch works with an input whose data format can be configured, and with a 1-bit output to output the result of the threshold evaluation. The limit value switch compares the value received at the input with two configurable hysteresis threshold values. Once the upper threshold value (H2) is reached or exceeded, the output can transmit a switching telegram (e.g. ON = true). If the value falls below the lower threshold value (H1), the output can transmit another switching telegram (e.g. OFF = false).

The switching telegrams can always be configured in the ETS when the threshold values are exceeded and undershot.

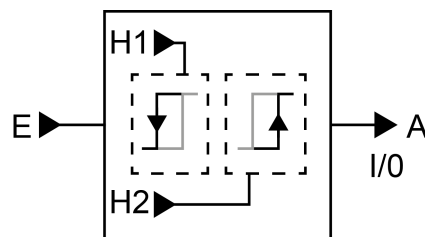

Image 48: Limit value switch

The two threshold values define a hysteresis. The hysteresis prevents frequent switching backwards and forwards of the output if the input value constantly changes in small intervals. Only when the change in value at the input exceeds the hysteresis as a whole, does the output switch the status.

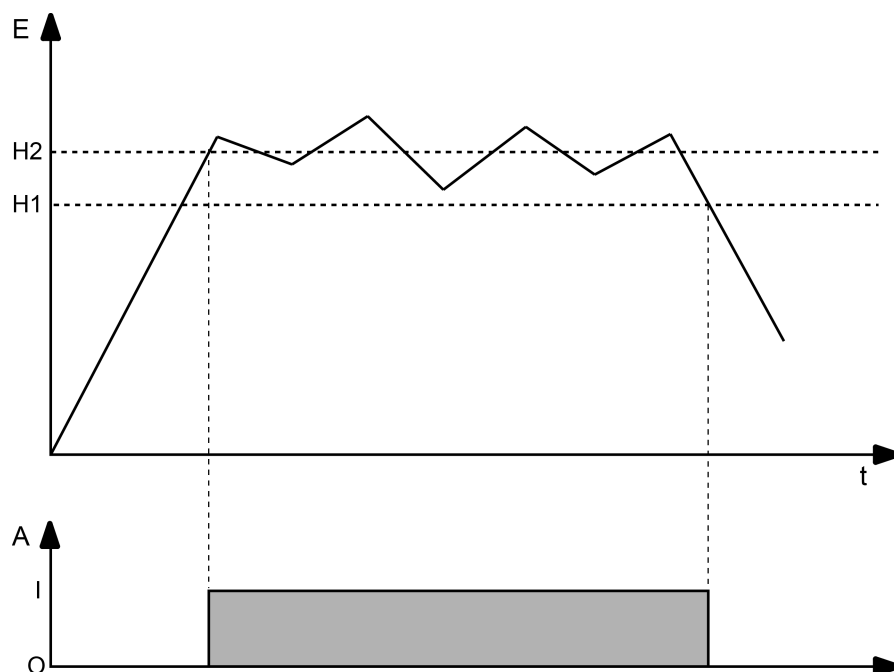

Image 49: Example of a hysteresis evaluation by upper and lower threshold value.

- i** The two threshold values can be freely configured in the ETS. Make sure that the upper threshold value is greater than the lower one!

- i** After bus voltage return or after an ETS programming operation, the output always transmits a telegram when the first value has been received at the input. The telegram depends on whether the value reaches or exceeds the upper threshold (H2) or not. If the value is less than the upper threshold, a telegram is transmitted in accordance with "Telegram upon not reaching the lower threshold". Otherwise the output transmits the "telegram on exceeding the upper threshold value".

The parameter "data format" defines the size and format of input object according to the following table. The output object is preset to 1-bit (DPT 1.002) and outputs the result of the threshold evaluation (ON = true / OFF = false). The threshold values that can be set in the ETS adapt to the input data format.

Data format	KNX DPT
4-bit dimming	3,007
1-byte operating mode switchover	20,102
1- byte scene extension	18,001
1-byte value 0...255	5,010
1-byte brightness value 0...100%	5,001
2-byte value 0...65535	7,001
2-byte value -32768...32767	8,001
2-byte floating-point number	9.0xx
4-byte value -2147483648...2147483647	13,001

The transmission behaviour of the limit value switch can be configured.



### 11.6.2 Limit value switch objects

Object no.	Function	Name	Type	DPT	Flag
327, 328, 329, 330, 331, 332, 333, 334	Limit value switch Input	Logic... - Input	4-bit	3,007	C, (R), W, -, A
<p>4-bit object as input of a limit value switch.</p> <p>This object is only available if the type of logic function is configured to "limit value switch" and the data format is configured to "4-bit dimming (DPT 3.007)".</p>					

Object no.	Function	Name	Type	DPT	Flag
343, 344, 345, 346, 347, 348, 349, 350	Limit value switch Input	Logic... - Input	1 bytes	20,102	C, (R), W, -, A
<p>1-bit object as input of a limit value switch.</p> <p>This object is only available if the type of logic function is configured to "limit value switch" and the data format is configured to "1 byte operating mode switchover (DPT 20.102)".</p>					

Object no.	Function	Name	Type	DPT	Flag
343, 344, 345, 346, 347, 348, 349, 350	Limit value switch Input	Logic... - Input	1 bytes	18,001	C, (R), W, -, A
<p>1-bit object as input of a limit value switch.</p> <p>This object is only available if the type of logic function is configured to "limit value switch" and the data format is configured to "1 byte scene extension (DPT 18.001)".</p>					

Object no.	Function	Name	Type	DPT	Flag
343, 344, 345, 346, 347, 348, 349, 350	Limit value switch Input	Logic... - Input	1 bytes	5,010	C, (R), W, -, A
<p>1-bit object as input of a limit value switch.</p> <p>This object is only available if the type of logic function is configured to "limit value switch" and the data format is configured to "1-byte value 0...255 (DPT 5.010)".</p>					

Object no.	Function	Name	Type	DPT	Flag
343, 344, 345, 346, 347, 348, 349, 350	Limit value switch Input	Logic... - Input	1 bytes	5,001	C, (R), W, -, A

1-bit object as input of a limit value switch.

This object is only available if the type of logic function is configured to "limit value switch" and the data format is configured to "1-byte brightness value 0...100 % (DPT 5.001)".

Object no.	Function	Name	Type	DPT	Flag
359, 360, 361, 362, 363, 364, 365, 366	Limit value switch Input	Logic... - Input	2 bytes	7,001	C, (R), W, -, A

2-bit object as input of a limit value switch.

This object is only available if the type of logic function is configured to "limit value switch" and the data format is configured to "2-byte value 0...65535 (DPT 7.001)".

Object no.	Function	Name	Type	DPT	Flag
359, 360, 361, 362, 363, 364, 365, 366	Limit value switch Input	Logic... - Input	2 bytes	8,001	C, (R), W, -, A

2-bit object as input of a limit value switch.

This object is only available if the type of logic function is configured to "limit value switch" and the data format is configured to "2-byte value 32768...32767 (DPT 8.001)".

Object no.	Function	Name	Type	DPT	Flag
359, 360, 361, 362, 363, 364, 365, 366	Limit value switch Input	Logic... - Input	2 bytes	9,xxx	C, (R), W, -, A

2-bit object as input of a limit value switch.

This object is only available if the type of logic function is configured to "limit value switch" and the data format is configured to "2-byte floating point value (DPT 9.0xx)".

Object no.	Function	Name	Type	DPT	Flag
375, 376, 377, 378, 379, 380, 381, 382	Limit value switch Input	Logic... - Input	4 bytes	13,001	C, (R), W, -, A

4-bit object as input of a limit value switch.

This object is only available if the type of logic function is configured to "limit value switch" and the data format is configured to "4-byte value 2147483648...2147483647 (DPT 13.001)".

Object no.	Function	Name	Type	DPT	Flag
383, 385, 387, 389, 391, 393, 395, 397	Limit value switch Output	Logic... - Output	1-bit	1,002	C, R, -, T, A

1-bit object as output of a limit value switch. The output object is preset to 1-bit (DPT 1.002) and outputs the result of the threshold evaluation (ON = true / OFF = false).

This object is only available if the type of logic function is configured to "limit value switch".

## 12 Delivery state

In the as-delivered state, the actuator is passive, i.e. no telegrams are transmitted to the KNX. The dimming output is set to the universal dimming principle with automatic recognition of the load type. Control of the output is possible via inputs 1 and 2, provided the bus voltage is switched on.

The device can be programmed and put into operation via the ETS. The physical address is preset to 15.15.255

Moreover the device has been configured at the factory with the following characteristics...

- Behaviour in case of bus voltage failure: no reaction
- Behaviour after bus voltage return: brightness before bus voltage failure

In the factory settings, the following properties are configured for inputs 1 and 2...

- Function: dimming
- Input 1: Switch on/brighter
- Input 2: Switch off/darker
- Time between switching and dimming: 0.4 s
- Debounce time: 30 ms
- Response to bus voltage return: no reaction
- Delay after bus voltage return: 2 s

**i** When using the dedicated application for secure operation: The application programme can be unloaded by the ETS. In this case, the device has no function on the part of KNX. However, the internal control of the relay outputs via the inputs is then possible.

**i** When using the application for conventional operation: The application programme can be unloaded by the ETS. In this case, the device has no function on the part of KNX. The internal control of the relay outputs via the inputs is then no longer possible.

**ALBRECHT JUNG GMBH & CO. KG**

Volmestraße 1  
58579 Schalksmühle  
GERMANY

Telefon: +49 2355 806-0  
Telefax: +49 2355 806-204  
kundencenter@jung.de  
www.jung.de