State 10/2017

Technical Manual



MDT Glass Push Button

KNX RF+

RF – GT0/GTT

4-fold/ 8-fold with switching actuator

4-fold/ 8-fold with switching actuator and temperature sensor

Further Documents:

Datasheet:

https://www.mdt.de/EN_Downloads_Datasheets.html

Assembly and Operation Instructions:

https://www.mdt.de/EN_Downloads_Instructions.html

1 Content

1 Content.....	2
2 Overview.....	5
2.1 Overview devices.....	5
2.2 Exemplary circuit diagram.....	6
2.2 Usage & Area of applications	7
2.4 Structure & Handling.....	7
2.5 Functions	8
2.5.1 Overview functions.....	9
2.6. Settings at the ETS-Software	11
2.7. Starting up	11
3 Communication objects.....	12
3.1 General	12
3.2 Communication objects per button	15
3.3 Switching output	18
3.4 Shutter output.....	20
3.5 Default settings of the communication objects	27
4 Reference-ETS-Parameter Push Button	30
4.1 General	30
4.2 Configuration.....	31
4.3 Identical parameter	33
4.3.1 Blocking object	33
4.4 Parameter Channels grouped.....	33
4.4.1 Dimming	34
4.4.2 Shutter.....	36
4.4.3 Switch	37
4.5 Parameters channels unique.....	38
4.5.1 Switch	38
4.5.2 Scene	48
4.5.3 Switch short/long	50
4.5.4 One button dimming	53
4.5.5 One-button Shutter	54
4.6 Panic/Cleaning function	55
4.7 Configuration of LED lights.....	56
4.7.1 LED 1 – 4[8].....	58
4.7.2 LED Priority.....	60

4.8. Logic.....	61
4.8.1 Logic sub-function switch	63
4.8.2 Logic sub function – Scene and Value	63
4.9 Room Temperature (RF-GTTx.01).....	64
5 Reference ETS-Parameter switching output	66
5.1 Channel selection	66
5.2 Identical parameter	67
5.2.1 Relay operating mode	67
5.2.2 Central function.....	68
5.2.3 Behavior at block/unblock.....	68
5.3 Switching output	70
5.3.1 Overview.....	70
5.3.2 On-/Off-delay	72
5.3.3 Logical functions.....	73
5.3.4 Scene function.....	74
5.4 Staircase	79
5.4.1 Overview.....	79
5.4.2 Staircase time	81
5.4.3 Prewarning und Warning	82
5.4.4 Manual switch off.....	83
5.4.5 Extend staircase time	83
6 Reference ETS-Parameter – Shutter output.....	84
6.1 Channel Selection	84
6.1.1 Shutter.....	85
6.1.2 Blinds	85
6.2 Time for movement.....	86
6.2.1 Measurement of times for Movement.....	87
6.2.2 Movement time.....	88
6.2.3 Step time for blinds	88
6.2.4 Duration of blind adjustment	88
6.2.5 Pause at change of direction	89
6.2.6 Switch-on/Switch-off delay motor	89
6.2.7 Position of blinds at end of driving.....	89
6.2.8 Short time operation	89

6.3 Objects for absolute position/ Status objects	90
6.3.1 Driving to reference.....	91
6.3.2 Commands for absolute positions.....	91
6.3.3 Status objects (actual position/direction)	91
6.3.4 Report objects	92
6.3.5 Status objects for Visualization	92
6.4 Drive to absolute position via 1 Bit	93
6.5 Scenes.....	95
6.5.1 Submenu scene	96
6.6 Automatic function.....	99
6.6.1 Submenu automatic function.....	99
6.7 Alarm functions/ superior functions	102
6.7.1 Order of alarms	104
6.7.2 Alarm types.....	105
6.7.3 Periodic observation.....	106
6.7.4 Normal blocking	106
6.7.5 Action at reset of alarms and blocks	107
6.8 Block functions	108
7 Index.....	111
7.1 Register of illustrations.....	111
7.2 List of tables.....	113
8 Attachment.....	115
8.1 Statutory requirements.....	115
8.2 Routine disposal	115
8.3 Assemblage.....	115
8.4 Datasheet	116

2 Overview

2.1 Overview devices

The manual refers to the following push buttons (Order Code respectively printed in bold type):

- **RF-GT04W.01** Glass push buttons 4-fold, white
 - surrounding orientation light, white/red LED per button, 2-fold switching output or 1-fold shutter output
- **RF-GT04S.01** Glass push buttons 4-fold, black
 - surrounding orientation light, white/red LED per button, 2-fold switching output or 1-fold shutter output
- **RF-GT08W.01** Glass push buttons 8-fold, white
 - surrounding orientation light, white/red LED per button, 4-fold switching output or 2-fold shutter output
- **RF-GT08S.01** Glass push buttons 8-fold, black
 - surrounding orientation light, white/red LED per button, 4-fold switching output or 2-fold shutter output
- **RF-GTT4W.01** Glass push buttons 4-fold, white, integrated temperature sensor
 - surrounding orientation light, white/red LED per button, 2-fold switching output or 1-fold shutter output
- **RF-GTT4S.01** Glass push buttons 4-fold, black, integrated temperature sensor
 - surrounding orientation light, white/red LED per button, 2-fold switching output or 1-fold shutter output
- **RF-GTT8W.01** Glass push buttons 8-fold, white, integrated temperature sensor
 - surrounding orientation light, white/red LED per button, 4-fold switching output or 2-fold shutter output
- **RF-GTT8S.01** Glass push buttons 8-fold, black, integrated temperature sensor
 - surrounding orientation light, white/red LED per button, 4-fold switching output or 2-fold shutter output

2.2 Exemplary circuit diagram

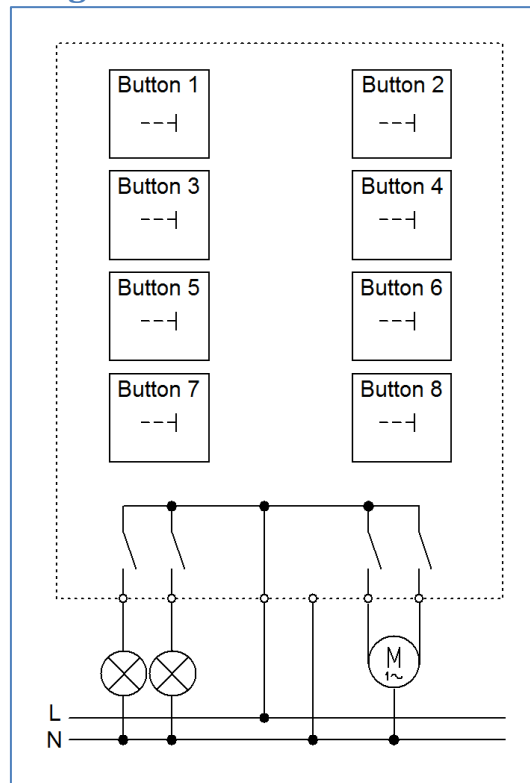

Figure 1: Exemplary circuit diagram RF-GT08.01

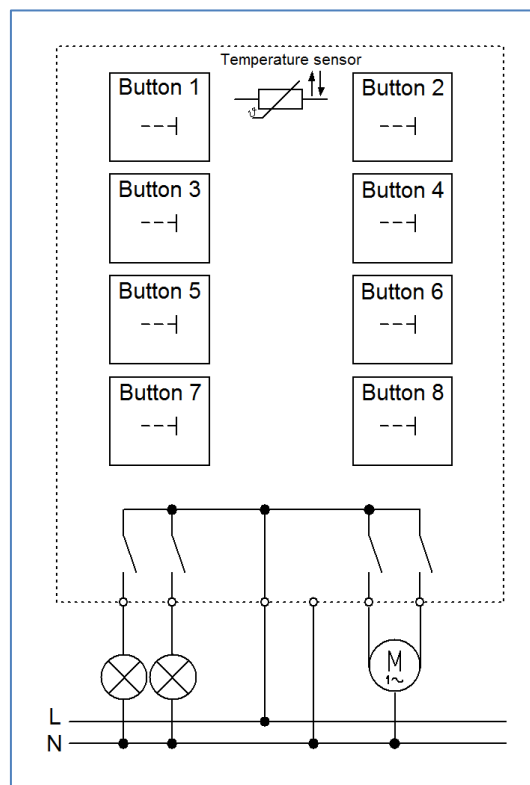

Figure 2: Exemplary circuit diagram RF-GTT8.01

At the 8-fold Glass Push Button, the Channels A and B are in the upper case and the Channels C and D are in the lower case. At the lower case, output A is Channel C and output B is Channel D.

2.2 Usage & Area of applications

The push buttons contains of all functions of the binary input and are designed for flush mounting. By a simple push, the push button can call parameterized functions like scenes or dimming functions. All designs contain of a surrounding orientation light and an illuminated sensitive area, which can light white or red and adjusted with additional parameters. Four logics, a cleaning function and a “panic button” complete the service portfolio of the push button.

Additional all Push buttons of the RF series have an actuator output, which can be used as shutter or switching output. The 4-fold actuator has one actuator module, which can be parameterized as two switching outputs or one shutter output, the 8-fold actuator has two actuator modules.

The push buttons of the series RF-GTT contain additional of an integrated temperature sensor, which can be used for the measurement of the room temperature.

2.4 Structure & Handling

The glass push buttons contain, according to the hardware design, of 4 or 8 buttons. Each contain of a free programmable background-LED. This can light as well red as white in 5 different illumination levels. Additional an orientation light can be activated. The glass surface is available in the colors black or white. Behind the surface, a marking draft can be inserted. A draft with a lot of symbols is available at http://www.mdt.de/EN_Downloads.html at the section “Other downloads”. All push buttons contains of bus connection at the back of the device as well as programming button at the side. An active programming mode is illustrated by the red programming LED. The push buttons of the series RF-GTTx.01 have the same style like the devices of the series RF-GT0x.01, but they contain of an additional temperature sensor.

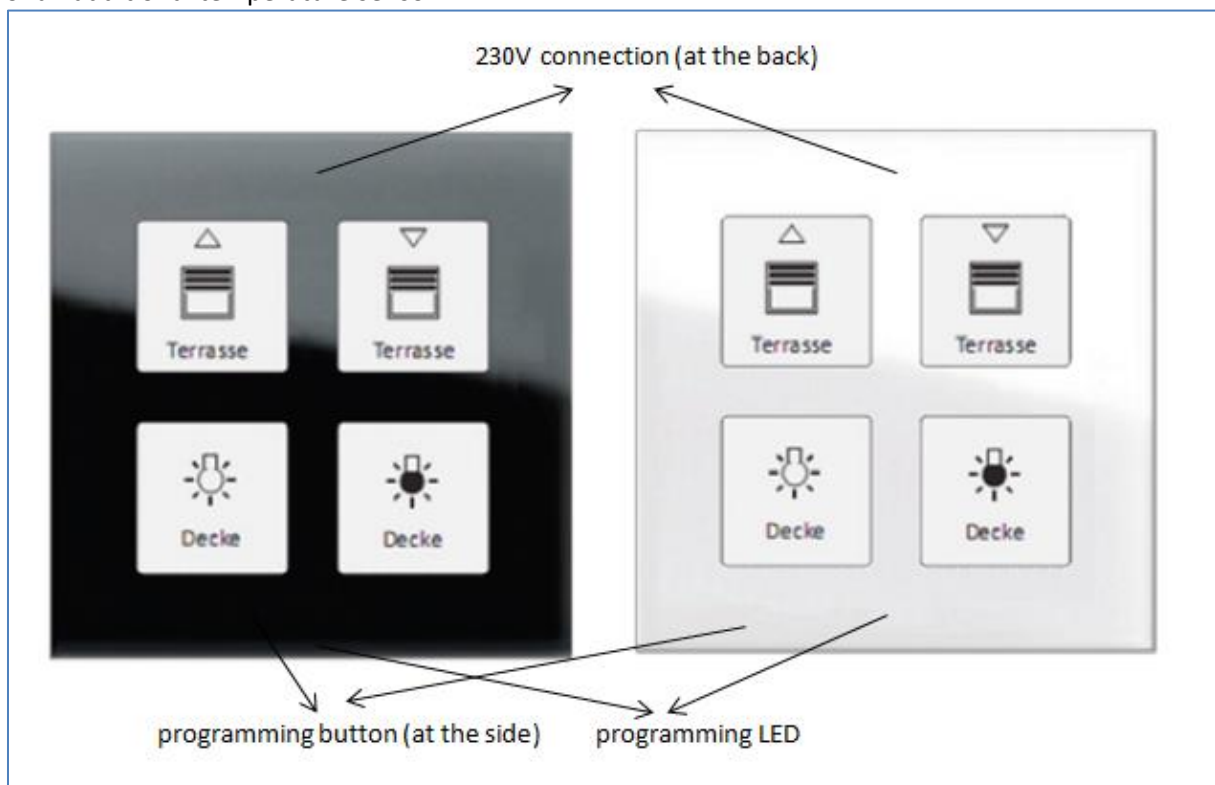

Figure 3: Overview hardware RF-GT04.01

2.5 Functions

The functions of the glass push buttons are divided into the general settings, the channel configuration, the settings for the panic button, the configuration of the LED display and the settings for the logic.

At the push buttons of the series BE-GTT, additional settings for the integrated temperature sensor are available.

The following menus can be shown and further parameterized there:

- **General settings**
The general settings are shown always. Changes, which are made here, are valid for the whole device. Settings for the reset behaviour and general settings can be made here.
- **Configuration of the buttons**
 - **disabled**
The channel is disabled and no communication objects are shown for this channel.
 - **Channels grouped**
If a channel is selected as “channel grouped”, the pair of channels can be parameterized as dimming function, switching function or shutter function.
 - **Channels unique**
If a channel is selected as “channel unique”, each channel can be parameterized as switch, scene, switch short/long, One-Button dimming or One-Button shutter.
- **Panic push button**
Here can be selected which function shall be called if more than 3 buttons are pressed. Different functions can be adjusted for the panic push button and the switchover between panic and cleaning can be selected.
- **Configuration LED lights**
For each button a background LED can be activated and adjusted. The background light can react as well to button activation as to an internal or external object.
- **Logic function**
Four adjustable logic blocks are available. For these an AND-Operation or an OR-Operation can be selected and the sending object can be parameterized as scene/value (1 Byte) or switch (1 Bit).
- **Room temperature (only at BE-GTT)**
The integrated temperature sensor can be used for sending the measured temperature to room temperature controller, as for example the SCN-RT6. So, no additional sensor is needed. Settings for the sending conditions of the temperature value and a communication object for an upper and lower threshold are available.
- **Outputs**
Each pair of outputs can be parameterized as two switching outputs or as one shutter output. According to this setting, the output can be parameterized. If the output is parameterized as shutter, it can be adjusted for controlling shutter or blinds. If the output is parameterized as switching output, it can be adjusted for a switching or a staircase function.

2.5.1 Overview functions

General settings	Resetverhalten	Behaviour at bus power reset
	Time for keystroke long	0,1-30s, selectable in steps
Channels grouped	Dimming function	brighter/darker function can be assigned to the channels freely
	Shutter function	up/down function can be assigned to the channels freely
	Switching function	off/on telegrams can be assigned to the channels freely
Channels unique	Switching function	<ul style="list-style-type: none"> • switching function • toggle function • status function • time functions <ul style="list-style-type: none"> ○ switch on/off delay • edge evaluation • forced settings • sending of byte-values
	Scene function	<ul style="list-style-type: none"> • memory function • selection of different scenes
	Switch short/long	<ul style="list-style-type: none"> • On-/Off-/toggle function • short/long independent parameterize able
	One button dimming	<ul style="list-style-type: none"> • steps of dimming • telegram repetition
	One button shutter	<ul style="list-style-type: none"> • shutter function with only one button
Logic functions	AND –operation/OR - operation	<ul style="list-style-type: none"> • Switching function • Sending scenes/values • Inverting
Configuration of the LED lights	Status-LEDs	<ul style="list-style-type: none"> • Connection to internal objects available • Connection to external objects available • Reaction to button activation • LED display behaviour parameterize able • strength and colour adjustable • LED priority adjustabel
	Orientation light	<ul style="list-style-type: none"> • permanent ON/OFF • Controlling by external object
Panic/Cleaning function	Panic function	<ul style="list-style-type: none"> • different functions available
	Cleaning function	<ul style="list-style-type: none"> • Switchover cleaning/panic function adjustable

integrated temperature sensor	<ul style="list-style-type: none"> • Sending condition adjustable • Status object for maximum/minimum adjustable
Switching output	<ul style="list-style-type: none"> • parameterizable as normal switching function or as staircase function • normally closed/normally opened • Blocking behavior adjustable • Central objects adjustable • Scene function • Logic functions
Shutter output	<ul style="list-style-type: none"> • Movement time adjustable • absolute positions • extended scene function • automatic function • extended alarm and blocking function

Table 1: Overview functions

2.6. Settings at the ETS-Software

Selection at the product database:

Manufacturer: MDT Technologies

Product family: Push buttons

Product type:

Medium Type: Twisted Pair (TP)

Product name: addicted to the used type, e.g.: RF-GTT8.01 Push button 8-fold, integrated temperature sensor

Order number: addicted to the used type, e.g.: RF-GTT8.01

The available parameters depend to the chosen product type. The additional functions for the plus variant are not shown at the normal push buttons.

2.7. Starting up

After wiring the allocation of the physical address and the parameterization of every channel follow:

- (1) Connect the interface with the bus, e.g. MDT USB interface
- (2) set bus power up
- (3) Connect and download MDT RF+ Line coupler, RF-LK001.01
- (4) Press the programming button at the device (red programming LED lights)
- (5) Loading of the physical address out of the ETS-Software by using the interface (red LED goes out, as well this process was completed successful)
- (6) Loading of the application, with requested parameterization
- (7) If the device is enabled you can test the requested functions (also possible by using the ETS-Software)

3 Communication objects

3.1 General

The following chart shows the general communication objects:

Nr.	Name	Object function	Data type	Direction	Info	Usage	Tip
20/40	Push button panic	Switch	DPT 1.001	sending	sends On or Off at activating the panic button	controlling actuator	Additional function for pressing all buttons
20/40	Push button panic	Send value	DPT 5.001	sending	sends adjusted value (0..255) at activation of the panic button	controlling actuator	Additional function for pressing all buttons
21/41	Push button panic	Value for toggle	DPT 1.001	receive	receives the last state (On/Off) of the controlled actuator	state object actuator, Visu	Additional function for pressing all buttons, for toggle function to get the last state and sending the opposed value
25/45	Logic input 1 A	Logic input 1 A	DPT 1.001	receive	logical input (receives on or off)	external switching, state objects of other devices	Additional function, up to 4 logical functions are available for the logical module, object appears only by activating „Logical object 1-4A (external)“
26/46	Logic input 1 B	Logic input 1 B	DPT 1.001	receive	logical input (receives On or Off)	external switching, state objects of other devices	Additional function, up to 4 logical functions are available for the logical module, object appears only by activating „Logical object 1-4B (external)“
27/47	Logic output 1	Logic output 1	DPT 1.001	sending	logical output; sends On or Off at activated logic	controlling actuator	Additional function, up to 4 logical functions are available for the logical module

27/47	Logic output 1 scene	Logic output 1 scene	DPT 18.001	sending	logical output; sends scene at active logic	controlling actuator	Additional function, up to 4 logical functions are available for the logical module
37/57	LED 1	Switch	DPT 1.001	receive	0 = LED On 1 = LED Off	external push button, external state objects/ Logical functions	For each button a LED can be activated, Object appears if „ LED 1 – 4[8] reacts at: external object” is selected
41/65	LED priority 1	Switch	DPT 1.001	receive	calls parameterized functions for LED priority with 0 or 1	external button, external state objects/ Logical functions...	Additional function for LED-function, can be activated and parameterized for each LED
45/73	LED orientation light	Switch	DPT 1.001	receive	0 = Orientation light off 1 = Orientation light on	Day/Night object, external buttons, external state objects/ logical function	Surrounding orientation light, can be activated once per push button, appears if Orientation light “over ext. object” is activated
46/74	LED	Blocking object	DPT 1.003	receive	0 = enable LED-Function 1 = block LED-Funktion	Day/Night object, button, state object, logical function...	is shown when the LED blocking object is activated, can block, according to the settings, all LEDs or only some
47/75	Day/Night	Switch	DPT 1.002	receive	activates day/night mode with 0 or 1	button, clock timer, Visu	can be activated in the general LED-Settings, switches between day and night mode
48/76	Temperature	Measurement	DPT 9.001	sending	sends the current temperature in °C	Visu, Room temperature controller	sends the current temperature, if the room temperature sensor is activated (only at RF-GTTx.01)

49/77	Temperature	State maximum value	DPT 1.001	sending	0 = maximum value not exceeded 1 = maximum value exceeded	Visu, alarm function...	sends a message if the maximum value is exceeded, can be activated in the menu "Room temperature" (only RF-GTTx.01)
50/78	Temperature	State minimum value	DPT 1.001	sending	0 = minimum value not undercut 1 = minimum value undercut	Visu, alarm function...	sends a message if the minimum value is undercut, can be activated in the menu "Room temperature" (only RF-GTTx.01)

Table 2: Communication objects general

3.2 Communication objects per button

The following chart shows the objects for each button:

Nr.	Name	Object function	Data type	Direction	Info	Usage	Tip
Configuration: Push buttons unique:							
0	Push Button 1	Switch	DPT 1.001	sending	sends On or Off at pushing/releasing the button	controlling actuator	can send the adjusted On or Off signal or both signals at toggeling-function
0	Push Button 1	Send forced setting	DPT 2.001	sending	sends forced settings On/Off at pushing/releasing the button	controlling actuator/presence detector...	is shown if button is set as switch, and sub function send value is configured as forced setting (2 Bit)
0	Push Button 1	Shutter	DPT 1.008	sending	controlling shutter with short or long keystroke	controlling up/down movement of the shutter actuator	controlling the up/down movement of shutter/blinds Function: One button shutter
0	Push Button 1	Dimming On/Off	DPT 1.001	sending	Switching object of the dimming functions, sends On/Off	controlling of the switching function of dimming actuators	controlling the switching function of dimming actuators, responds on a short keystroke Function: One button dimming
0	Push Button 1	Send value	DPT 5.001	sending	sends adjusted value (0..255) at pushing/releasing button	sends an absolute value to an actuator	is shown if button is set as switch, and sub function send value is configured as 1 Byte value
1	Push Button 1	Value for toggle	DPT 1.001	receive	receives the last state(On/Off) of the controlled actuator	State object actuator, Visu	for toggle function to get the last state and sending the opposed value

1	Push Button 1	Stop/Blinds open/close	DPT 1.009	sending	controlling slats via short or long keystroke, stops active up/down movement	controlling slat function of a shutter actuator	For controlling the step/stop function of shutter/blinds Function: One button shutter
1	Push Button 1	Dimming	DPT 3.007	sending	sends dimming value (0..255) to actuator	controlling actuator	Value is increased/decreased as long the button is pressed, direction depends to the last value respectively the value of object "Value for toggle" Function: One button dimming
2	Push Button 1	Value for change of direction	DPT 1.008	receive	receives last state (Up/Down) of the controlled shutter actuator	state object actuator, Visu	is used for the shutter function, for knowing the last value and sending the opposed value Function: One button shutter
2	Push Button 1	Scene	DPT 18.001	sending	sends adjusted scene number (1..64)	calling scenes in actuators	sends scene number at pressing the button Function: Scene
4	Push Button 1	Blocking object	DPT 1.003	receive	0 = enable button function 1 = block button function	state object actuator, other buttons, logical functions...	blockst he button, a blocked button cannot send any value available in all functions
+5 next button							
Configuration: Push buttons grouped:							
0	Push Buttons 1/2	Dimming On/Off	DPT 1.001	sending	Switching object of the dimming functions, sends On/Off	controlling actuator	controlling the switching function of dimming actuators, responds on a short keystroke Function: Dimming

0	Push Buttons 1/2	Shutter down/up	DPT 1.008	sending	controlling shutter with short or long keystroke	controlling up/down movement of the shutter actuator	controlling the up/down movement of shutter/blinds Function: Shutter
0	Push Buttons 1/2	Switch on/off	DPT 1.001	sending	sends On/Off at pushing the button	Controlling actuator	can send the adjusted On or Off signal or both signals at toggeling-function Function: Switch
1	Push Buttons 1/2	Dimming	DPT 3.007	sending	sends dimming value (0..255) to actuator	controlling actuator	Value is increased/decreased as long the button is pressed, direction depends to the last value respectively the value of object "Value for toggle" Function: Dimming
1	Push Buttons 1/2	Stop/Blinds open/close	DPT 1.009	sending	controlling slats via short or long keystroke, stops active up/down movement	controlling slat function of a shutter actuator	For controlling the step/stop function of shutter/blinds Function: Shutter
4	Push Buttons 1/2	Blocking object	DPT 1.003	receive	0 = enable button function 1 = block button function	state object actuator, other buttons, logical functions...	blockst he button, a blocked button cannot send any value available in all functions
+10 next grouped buttons							

Table 3: Communication objects per button

3.3 Switching output

The following table shows the available objects for a switching output:

Nr.	Name	Object function	Data type	Direction	Info	Usage	Tip
General functions:							
84	Central function	Switch on/off	DPT 1.001	receive	Actuator reacts to Incoming-telegramm	Push buttons, Visu... for manual control	Communication object is always shown and enables the central on/off switching of all channels , which have an enabled central function
Functions per channel:							
85	Channel A	Switch on/off	DPT 1.001	receive	Actuator reacts to Incoming-telegramm	Push buttons, Visu... for manual control	Communication object is shown at the operating mode „switch“ and controls the channel On/Off , which is normally connected to all control keys. (= Main function at switch)
86	Channel A	Staircase	DPT 1.001	receive	Actuator reacts to Incoming-telegramm	Push buttons, Visu... for manual control	Communication object is shown at the operating mode „switch“ and controls the channel On/Off , which is normally connected to all control keys. The channel switches off again after adjusted time is expired. (= Main function at staircase)
87	Channel A	Block	DPT 1.003	receive	Actuator reacts to Incoming-telegramm	Push buttons, Visu... for manual control	Communication object is only shown after activation of the blocking object. Object blocks the function of this channel. (= Additional function)

88	Channel A	Scene	DPT 18.001	receive	Actuator reacts to Incoming-telegramm	Push buttons, Visu... for manual control	Communication object appears only after activating scenes . For calling of saved scenes, which are saved in the actuator. (= Additional function)
89	Channel A	Status	DPT 1.001	sending	Actuator sends current state	For display on Visu, Tableau, and Display Connection to Push button object „Value for toggle“	Communication object operates as status indication and can be used for visualization... Must be connected to the object “value for toggle” of the controlling push button for sending its current state to the push button.
90	Channel A	Logic 1	DPT 1.002	receive	Actuator reacts to Incoming-telegramm	external switching, state object of other devices	Channel switches only On, if the logic function of activated objects and switching object (Nr. 85) is true. Only available for switching output.
91	Channel A	Logic 2	DPT 1.002	receive	Actuator reacts to Incoming-telegramm	external switching, state object of other devices	Channel switches only On, if the logic function of activated objects and switching object (Nr. 85) is true. Only available for switching output.
+8 next channel							

Table 4: Communication objects switching output

3.4 Shutter output

The following chart shows the available objects for a shutter output:

Nr.	Name	Object function	Data type	Direction	Info	Usage	Tip
Objects for automatic function:							
125 & 126	Automatic A	Automatic position 1-2	DPT 1.017	receive	Actuator reacts to Incoming-telegramm	Push buttons, Visu... for manual control	Actuator calls the saved values for this automatic position. Enables the adjustment of absolute values via 1 Bit
127 & 128	Automatic B	Automatic position 1-2	DPT 1.017	receive	Actuator reacts to Incoming-telegramm	Push buttons, Visu... for manual control	Actuator calls the saved values for this automatic position. Enables the adjustment of absolute values via 1 Bit
Objects per Channel:							
85	Channel A/B	Shutter up/down	DPT 1.007	receive	Actuator reacts to Incoming-telegramm	Push buttons, Visu... for manual control	Communication object is shown at the operating mode „Shutter“ and enables controlling the standard function up/down , which is normally connected to all control keys. (= Main function for shutter)

85	Channel A/B	Blinds up/down	DPT 1.007	receive	Actuator reacts to Incoming-telegramm	Push buttons, Visu... for manual control	Communication object is shown at the operating mode „Blinds“ and enables controlling the standard function up/down , which is normally connected to all control keys. (= Main function for blinds)
86	Channel A/B	Blinds up/down/stop	DPT 1.007	receive	Actuator reacts to Incoming-telegramm	Push buttons, Visu... for manual control	Communication object is shown at the operating mode „Shutter“ and enables the controlling of the standard function slat adjustment (step) and stop , which is normally connected to all control keys. (= Main function for shutter)
86	Channel A/B	Short time operation	DPT 1.007	receive	Actuator reacts to Incoming-telegramm	Push buttons, Visu... for manual control	Communication object is shown at the operating mode „Blinds“ and enables the controlling of the fine-tuning adjustment of the blinds in step, which is normally connected to all control keys. (= Additional function at shutter)

87	Channel A/B	Stop	DPT 1.017	receive	Actuator reacts to Incoming-telegramm	Push buttons, Visu... for manual control	Communication object is shown at the operating mode „Blinds“ and stops an active up/down movement (without step function) (= Main function for blinds)
88	Channel A/B	Scene	DPT 18.001	receive	Actuator reacts to Incoming-telegramm	Bedientasten, Visu... zum Szenenaufruf	Communication object is shown after activation and allows calling scenes, which are saved in the actuator. (= Additional function)
89	Channel A/B	Status act. direction	DPT 1.008	sending	Actuator sends current state	For display on Visu, Tableau, and Display	Communication object for displaying the current direction of movement. (= Additional function)
89	Channel A/B	Status of movement	DPT 1.008	sending	Actuator sends current state	For display on Visu, Tableau, and Display	Communication object for displaying, if the channel is moving at the moment. (= Additional function)

90	Channel A/B	absolute positions	DPT 5.001	receive	Actuator reacts to Incoming-telegramm	Push buttons, Visu... for manual control	Communication object for driving to an absolute position, which can be sent from control keys. (= Additional function)
91	Channel A/B	absolute position of slats	DPT 5.001	receive	Actuator reacts to Incoming-telegramm	Push buttons, Visu... for manual control	Communication object for driving the slats to an absolute position, which can be sent from control keys. (= Additional function)
92	Channel A/B	Status actual position	DPT 5.001	sending	Actuator sends current state	For diplay on Visu, Tableau, and Display	Communication object is shown after activation and shows the current position (0..100%). (= Additional function)
93	Channel A/B	Status act. position of blinds	DPT 5.001	sending	Actuator sends current state	For diplay on Visu, Tableau, and Display	Communication object is shown after activation and shows the current position of slats (0..100%). (= Additional function)
94	Channel A/B	Act. position valid	DPT 1.002	sending	for requesting current state	For diplay on Visu, Tableau, and Display or only for requesting once	Communication object indicates, if a refernce drive was already done, which is necessary at absolute position commands. (= Additional function)

95	Channel A/B	Start driving to reference	DPT 1.008	receive	Actuator reacts to Incoming-telegramm	Push buttons, Visu... for manual control	Communication object for starting a reference drive, which is necessary for absolute position commands. (= Additional function)
96	Channel A/B	Drive to position	DPT1.008	receive	Actuator reacts to Incoming-telegramm	Push buttons, Visu... for manual control	Communication object enables the driving to absolute commands, which are saved in the shutter actuator, via 1 Bit commands. (= Additional function) Enables the adjustment of absolute positions for shutter and blinds, which can be called via 1 Bit object.
97	Channel A/B	State upper position	DPT 1.001	sending	Actuator reacts with sending a telegramm	For display on Visu, Tableau, and Display	Communication sends a logical 1, if the upper position = 0% is reached. (= Additional function)
98	Channel A/B	State lower position	DPT 1.001	sending	Actuator reacts with sending a telegramm	For display on Visu, Tableau, and Display	Communication sends a logical 1, if the lower position = 100% is reached. (= Additional function)

99	Channel A/B	Block absolute position mode	DPT 1.003	receive	Actuator reacts to Incoming-telegramm	Push buttons, Visu... for manual control	Communication object is shown, if the Alarm and Block-function is active and “blocking absolute position mode” is activated at the extended blocking functions. Blocks absolute positions commands. (= Additional function)
100	Channel A/B	Block universal mode	DPT 1.003	receive	Actuator reacts to Incoming-telegramm	Push buttons, Visu... for manual control	Communication object is shown, if the Alarm and Block-function is active and “blocking universal mode” is activated at the extended blocking functions. Blocks functions like parameterized (= Additional function)
101	Channel A/B	Wind alarm	DPT 1.005	receive	Actuator reacts to Incoming-telegramm	Can be used from the weather station for safety functions	Communication object is shown, if the Alarm and Block-function is active. Can be used as safety functions, which get their signal from weather stations. (= Additional function)
102	Channel A/B	Rain alarm	DPT 1.005	receive	Actuator reacts to Incoming-telegramm	Can be used from the weather station for safety functions	Communication object is shown, if the Alarm and Block-function is active. Can be used as safety functions, which get their signal from weather stations. (= Additional function)

103	Channel A/B	Frost alarm	DPT 1.005	receive	Actuator reacts to Incoming-telegramm	Can be used from the weather station for safety functions	Communication object is shown, if the Alarm and Block-function is active. Can be used as safety functions, which get their signal from weather stations. (= Additional function)
104	Channel A/B	Block	DPT 1.003	receive	Actuator reacts to Incoming-telegramm	Can be used from the weather station for safety functions	Communication object is shown, if the Alarm and Block-function is active. Can be used as safety functions, which get their signal from weather stations. (= Additional function)

Table 5: Communication objects shutter output

3.5 Default settings of the communication objects

Default settings									
Nr.	Button	Function	Length	Priority	C	R	W	T	U
0	Push Button 1	Switch	1 Bit	Low	X	X		X	
0	Push Button 1	Shutter	1 Bit	Low	X	X		X	
0	Push Button 1	Send value	1 Byte	Low	X	X		X	
0	Push Button 1	Dimming On/Off	1 Bit	Low	X	X		X	
0	Push Button 1	push-button short	1 Bit	Low	X	X		X	
0	Push Button 1	push-button short	1 Byte	Low	X	X		X	
0	Push Button 1	Send forced setting	2 Bit	Low	X	X		X	
0	Push Buttons 1/2	Dimming On/Off	1 Bit	Low	X	X		X	
0	Push Buttons 1/2	Shutter down/up	1 Bit	Low	X	X		X	
0	Push Buttons 1/2	Switch on/off	1 Bit	Low	X	X		X	
1	Push Button 1	Value for toggle	1 Bit	Low	X	X		X	
1	Push Button 1	Stop/Blinds open/close	1 Bit	Low	X	X		X	
1	Push Button 1	Dimming	4 Bit	Low	X	X		X	
1	Push Buttons 1/2	Dimming	4 Bit	Low	X	X		X	
1	Push Buttons 1/2	Stop/Blinds open/close	1 Bit	Low	X	X		X	
2	Push Button 1	Scene	1 Byte	Low	X	X		X	
2	Push Button 1	Value for toggle	1 Bit	Low	X		X	X	X
2	Push Button 1	Value for change of direction	1 Bit	Low	X		X	X	X
2	Push Button 1	Push-button long	1 Bit	Low	X	X		X	
2	Push Button 1	Push-button long	1 Byte	Low	X	X		X	
4	Push Button 1	Blocking object	1 Bit	Low	X		X		X
+ 5 next unique button, +10 next grouped pair of buttons									
20/40	Push button panic	Switch	1 Bit	Low	X	X		X	
20/40	Push button panic	Send value	1 Byte	Low	X	X		X	
21/41	Push button panic	Value for toggle	1 Bit	Low	X		X	X	X
24/44	Push button panic	Blocking object	1 Bit	Low	X		X		X
+ 3 next logic									
25/45	Logic input 1 A	Logic input 1 A	1 Bit	Low	X		X		X
26/46	Logic input 1 B	Logic input 1 B	1 Bit	Low	X		X		X
27/47	Logic output 1	Logic output 1	1 Bit	Low	X	X		X	
27/47	Logic output 1 scene	Logic output 1 scene	1 Byte	Low	X	X		X	

37/57	LED 1	Switch	1 Bit	Low	X		X	X	
+ 1 next LED									
41/65	LED priority 1	Switch	1 Bit	Low	X		X	X	
+ 1 next LED priority									
45/73	LED orientation light	Switch	1 Bit	Low	X		X	X	
46/74	LED	Blocking object	1 Bit	Low	X			X	
47/75	Day/Night	Switch	1 Bit	Low	X			X	
48/76	Temperature	Measurement	1 Byte	Low	X	X		X	
49/77	Temperature	State maximum value	1 Bit	Low	X	X			
50/78	Temperature	State minimum value	1 Bit	Low	X	X			
Switching output									
84	Central function	switch on/off	1 Bit	Low	X		X		
85	Channel A	switch on/off	1 Bit	Low	X		X		
86	Channel A	Staircase	1 Bit	Low	X		X		
87	Channel A	Block	1 Bit	Low	X		X		
88	Channel A	Scene	1 Byte	Low	X		X		
89	Channel A	Status	1 Bit	Low	X	X		X	
90	Channel A	Logic 1	1 Bit	Low	X		X		
91	Channel A	Logic 2	1 Bit	Low	X		X		
+8 next channel									
Shutter output									
125	Automatic A	Automatic position 1	1 Bit	Low	X		X		
126	Automatic A	Automatic position 2	1 Bit	Low	X		X		
127	Automatic B	Automatic position 1	1 Bit	Low	X		X		
128	Automatic B	Automatic position 2	1 Bit	Low	X		X		
85	Channel A	Shutter up/down	1 Bit	Low	X		X		
85	Channel A	Blinds up/down/stop	1 Bit	Low	X		X		
86	Channel A	Short time operation	1 Bit	Low	X		X		
86	Channel A	Stop	1 Bit	Low	X		X		
87	Channel A	Scene	1 Byte	Low	X		X		
88	Channel A	Status actual direction	1 Bit	Low	X		X		
89	Channel A	Shutter up/down	1 Bit	Low	X	X		X	
89	Channel A	Status of movement	1 Bit	Low	X	X		X	
90	Channel A	absolute position	1 Byte	Low	X		X		

91	Channel A	absolute position of blinds	1 Byte	Low	X		X		
92	Channel A	Status actual position	1 Byte	Low	X	X		X	
93	Channel A	Status act. position of blinds	1 Byte	Low	X	X		X	
94	Channel A	Act. position valid	1 Bit	Low	X	X		X	
95	Channel A	Start driving to reference	1 Bit	Low	X		X		
96	Channel A	Drive to position	1 Bit	Low	X		X		
97	Channel A	State upper position	1 Bit	Low	X	X		X	
98	Channel A	State lower position	1 Bit	Low	X	X		X	
99	Channel A	Block absolute position mode	1 Bit	Low	X		X		
100	Channel A	Block universal mode	1 Bit	Low	X		X		
101	Channel A	Wind alarm	1 Bit	Low	X		X		
102	Channel A	Rain alarm	1 Bit	Low	X		X		
103	Channel A	Frost alarm	1 Bit	Low	X		X		
104	Channel A	Block	1 Bit	Low	X		X		
+20	next channel								

Table 6: Communication objects - Default settings

You can see the default values for the communication objects from the upper chart. According to requirements the priority of the particular communication objects as well as the flags can be adjusted by the user. The flags allocates the function of the objects in the programming thereby stands C for communication, R for Read, W for write, T for transmit and U for update.

4 Reference-ETS-Parameter Push Button

4.1 General

The following parameters are one-time available and affect to alle 4 or 8 channels:

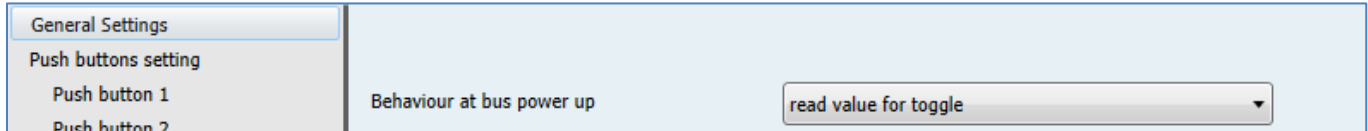

Figure 4: General settings

The chart shows the available settings for the general settings:

ETS-text	Dynamic range [default value]	comment
Behavior at power up	<ul style="list-style-type: none"> ▪ No read value for toggle ▪ Read value for toggle 	activates the reading of the value for toggle at bus power up

Table 7: General settings

The parameter “Behavior at power up” defines the behavior of the push button at a main power return. The setting “Read value for toggle” effects that all communication objects “value for toggle” are read. So the push button knows the current status of the objects. If you choose the setting “no read value for toggle”, the push button will not know the current status of the actor. So the push button assumes an unconfirmed value for the objects “value for toggle” and sends always a “0”-signal at the next operation. Only now the push button knows the status of the actor and can send the right values. But if you choose the read of these values at a bus power up, the push button will send immediately the right value for toggling.

4.2 Configuration

The following illustration shows the available settings for each channel:

Push button setting

Function push buttons 1 / 2 (top left / right)	Push buttons grouped ▼
Function push buttons 3 / 4 (2. line left / right)	Push buttons unique ▼
Function push buttons 5 / 6 (3. line left / right)	disabled ▼
Function push buttons 7 / 8 (bottom left / right)	disabled ▼
Panic push button	
	not active ▼
Cleaning function	
	Cleaning = long button, Panic = short button ▼
Reaction rate	
	medium ▼
Time for keystroke long [s]	
	0,4 s ▼

Figure 5: Configuration of push buttons

The following chart shows the available settings:

ETS-text	Dynamic range [default value]	comment
Function push buttons 1/2 – [7/8]	<ul style="list-style-type: none"> ▪ disabled ▪ Push buttons grouped ▪ Push buttons unique 	Operating mode of the channels
Panic push button	<ul style="list-style-type: none"> ▪ active ▪ not active 	activates the panic function
Cleaning function	<ul style="list-style-type: none"> ▪ Cleaning = long button, Panic= short button ▪ Cleaning = short button, Panic= long button 	Setting which function shall be called at a long/short keystroke
Reaction rate	<ul style="list-style-type: none"> ▪ fast ▪ medium ▪ slow 	Adjustment of the reaction rate respectively debounce time of the push buttons
Time for keystroke long [s]	0,1s – 30s [0,4s]	defines the time when the ETS recognizes a long keystroke

Table 8: Channel configuration

- Three operating modes can be chosen at the submenu push button settings for each button. The further parameterization options depend on the chosen mode. If a channel is deactivated, so chosen as “disabled, there are no further parameterization options for this channel.
- By the activation of the panic buttons, an additional submenu is shown in which this function can be parameterized. Also the polarity if at a short or at a long keystroke the panic or the cleaning function shall be activated can be adjusted.
- The reaction rate is the debouncing time of the push buttons. This can be chosen as slow, medium or fast and defines how long a buttons must be pressed for calling the function. In order that at a call of the panic or cleaning function no unrequested function is called, this function should be adapted to the user.
- The parameter “Time for keystroke long” allocates a static value to the push button from which time a long keystroke is recognized. This parameter is important for functions, which have different functions for a long and a short keystroke.

4.3 Identical parameter

4.3.1 Blocking object

As well for grouped channels as for unique channels the blocking object can be activated. At the unique channels one blocking object for every channel can be activated. For grouped channels, you can activate one blocking object for both channels. The communication object for a channel appears as soon as it is activated for a channel. So there are up to 8 blocking objects parameterize able at a 8-fold push button. The corresponding channel of the blocking object is blocked by sending a logical 1. A blocked channel is not controllable as long as it is blocked. By sending a logical 0, the channel can be unblocked again.

Number	Name	Length	Usage
4	Blocking object	1 Bit	blocks the related channel by sending a logical 1

Table 9: Communication object blocking object

4.4 Parameter Channels grouped

The chart shows the setting options for grouped channels:

ETS-text	Dynamic range [default value]	comment
Button A/B	<ul style="list-style-type: none"> ▪ Dimming ▪ Shutter ▪ Switch 	Operating mode of the channel
Dimming function A/B	<ul style="list-style-type: none"> ▪ Brighter/Darker ▪ Darker/Brighter 	Defines which channel should dim up and which should dim down
Shutter function A/B	<ul style="list-style-type: none"> ▪ Up/Down ▪ Down/Up 	Defines which channel should drive the shutter a down and which up
Switch function A/B	<ul style="list-style-type: none"> ▪ On/Off ▪ Off/On 	Defines which channel should switch off and which on
Blocking Object	<ul style="list-style-type: none"> ▪ Inactive ▪ Active 	The blocking object can be displayed for every pair of channels

Table 10: Parameter Channels grouped

By choosing channels as grouped, two channels become one common function. The grouped function is called dual surface, like dual surface dimming, and dual surface shutter. In contrast to the single surface functions, one action can be performed independent form the other one. One input performs always one function. The assignment for the buttons can be made individually, so it is possible to configure which button should for example drive the shutters up and which down.

4.4.1 Dimming

The dual surface dimming function (channels grouped) is for controlling dimming actuators by start-stop dimming commands.

The following parameters are visible, when a pair of channels is chosen as dimming-function:

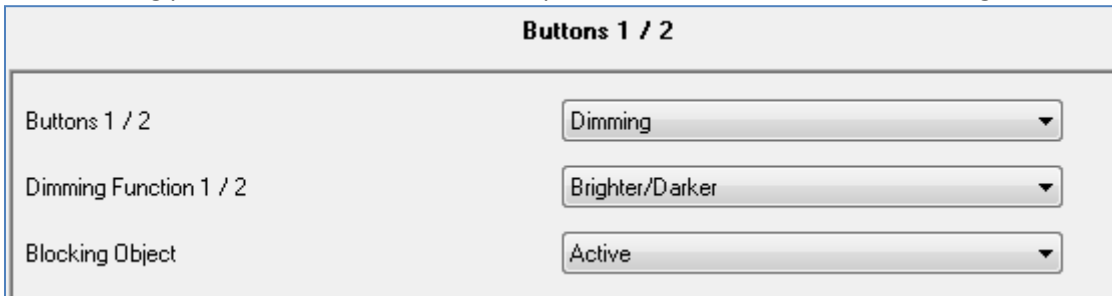

Figure 6: Parameter dual surface dimming

Number	Name	Length	Usage
0	Dimming on/off	1 Bit	Switching function of the dimming process; action for a short keystroke
1	Dimming	4 Bit	Dimming function; action for a long keystroke

Table 11: Communication objects dual surface dimming

When a pair of channels is parameterized as dimming function, two objects are shown. One object reacts to a short keystroke, the switching object “Dimming on/off”, and the other object reacts to a long keystroke, the dimming object “dimming”.

It is possible to parameterize this function as brighter/darker or as darker/brighter. The first function belongs always to the first button. If you switch this parameter, the function will be switched automatically.

By choosing the dimming function (channel A/B) as brighter/darker, the function reacts in this way: A short keystroke at button A switches the lights on. The lights are switched off by a short keystroke at button B. A long keystroke dims the lights step by step until releasing the long keystroke. The lights are dimmed brighter at button A and darker at button B. The push button starts always with the last brightness level, before switching off.

The step size is set fixed to 100% at the dual surface dimming. It is a start-stop dimming. that means the lights are dimmed as long as you hold the button. After releasing the button a stop value is sent, which stops the dimming process. So you can dim the lights with only one keystroke from 0% to 100% or from 100% to 0%, by pushing the button long enough.

The chart shows the correlations between the dimming- and the switching-object:

Button	Function Brighter/Darker		Function Darker/Brighter	
	Button A	Button B	Button A	Button B
Dimming function	Brighter	Darker	Darker	Brighter
Switching function	On	Off	Off	On

Table 12: Dimming function

The following diagram shows the dual surface dimming function:

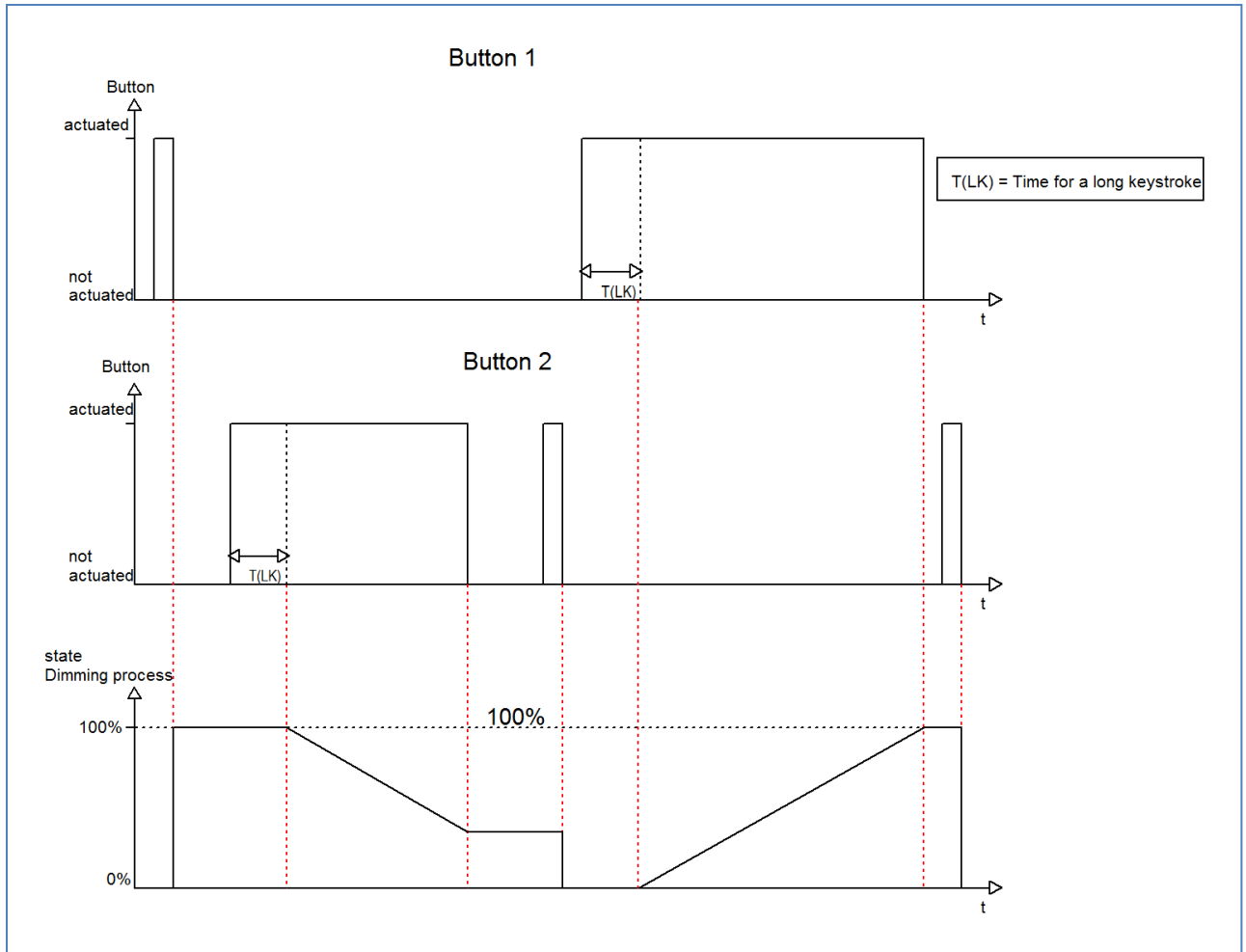

4.4.2 Shutter

The two button shutter-function triggers shutter actuators, which can drive shutter and blinds. The following parameters are shown, when a pair of channel is adjusted as shutter function:

Push buttons 1 / 2

Push buttons 1 / 2	Shutter ▼
Shutter function 1 / 2	Up, Down ▼
Operation function	Long=move / short=stop/Slats ▼
Blocking object	not active ▼

Figure 7: Two button shutter function

Number	Name	Length	Usage
0	Shutter Down/Up	1 Bit	Driving function for the shutters, action for a long keystroke
1	Stop/Blinds Open/Close	1 Bit	Stop/Adjustment of the blinds, action for a short keystroke

Table 13: Communication objects two button shutter function

If you choose a pair of channels as shutter function, two communication objects will appear for this pair of channel. On the one hand the stop/blind adjustment object called “Stop/Blinds Open/Close”, which responds to a short keystroke and on the other hand the driving object called “Shutter Down/Up”, which responds to a long keystroke.

The driving object is for moving the shutters up and down. The stop-/blind adjustment object is for the adjustment of the blinds and additional it stops a running movement of the shutter.

Every shutter actuator controls with a 0-signal the up-movement and with a 1-signal the down movement. So the push button sends these signals to the corresponding driving commands.

From hardware version 2.0 (have a look at the print of the side of the device: RX.X), it is additional possible to switch the functions for a long and a short keystroke. So it can be chosen whether he shutter/blinds shall be driven via a long or a short keystroke. The Stop-/Blind adjustment object is adjusted by the other operating concept.

The Chart shows the correlations between the Stop-/Blind adjustment object and the driving object for the individual channels:

	Function Down/Up		Function Up/Down	
	Button A	Button B	Button A	Button B
Stop-/Blind adjustment object	Down	Up	Up	Down
Driving object	Stop/close blinds	Stop/open blinds	Stop/open blinds	Stop/close blinds

Table 14: Shutter function

4.4.3 Switch

The values for on and off can be assigned freely at the switching function for the grouped channels. If you adjust a pair of channel as switch, the following parameters will be shown:

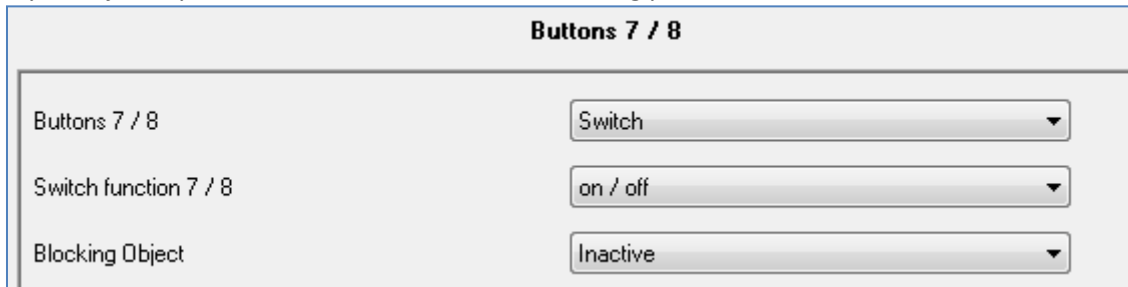

Figure 8: Two button switching function

Simple functions, like an alternating circuit, can be programmed easily by using the grouped switch function. The 1 bit communication object sends in dependence of the parameterization a 0- or a 1-signal for the first button and the inverted signal for the second channel. So you can chose which channel should switch off and which should switch on.

The following chart shows the corresponding communication object:

Number	Name	Length	Usage
0	Switch On/Off	1 Bit	Switching object for the dual surface switching function

Table 15: Communication object two button switching function

4.5 Parameters channels unique

There are 6 different operating modes for the unique channels, which can be adjusted for each channel:

- Inactive
- Switch
- Scene
- Switch short/long
- One button dimming
- One button shutter

After the assignment of the operating mode the further parameterization can be done. If the channel is selected as inactive, no further parameterization will be possible.

4.5.1 Switch

The switching function is for switching the corresponding output on, off and toggling it. There is a multitude of sub-functions at the switching function, which enables the user to evaluate edges and integrate times to the switching process.

The following parameters are shown, when the channel is selected as switch:

Push button 1	
Function	Switch
Subfunction	<div style="border: 1px solid black; padding: 2px;"> Toggle by push Switch by push Toggle by push Switch by release Toggle by release Send Status Send value by push Send value by release Send value by push and release Send Status with on-delay Send Status with off-delay </div>
Blocking object	

Figure 9: Parameter switch

Various sub-functions are available at a switching output. Most of these sub-functions contain also of further parameterization-options. The different sub-functions as well as their parameterization-options are described in the following segments:

4.5.1.1 Switch by push/release

The following setting options are available, when the sub-function switch falling/rising edge was adjusted:

ETS-text	Dynamic range [default value]	comment
Value for release/push	<ul style="list-style-type: none"> ▪ On ▪ Off 	switches on/off at push/release

Table 16: Parameter switch by push/release

The sub-function “switch by push” or “switch by release” sends only a signal at the adjusted action. You can parameterize whether a 0-signal or a 1-signal should be sent. There is no inverted signal at subsiding the edge. This function always sends only one adjusted signal.

The following diagram shows this sub-function for switch by push. As soon as the state changes from 0 to 1, the push button sends an On-pulse (=1-signal):

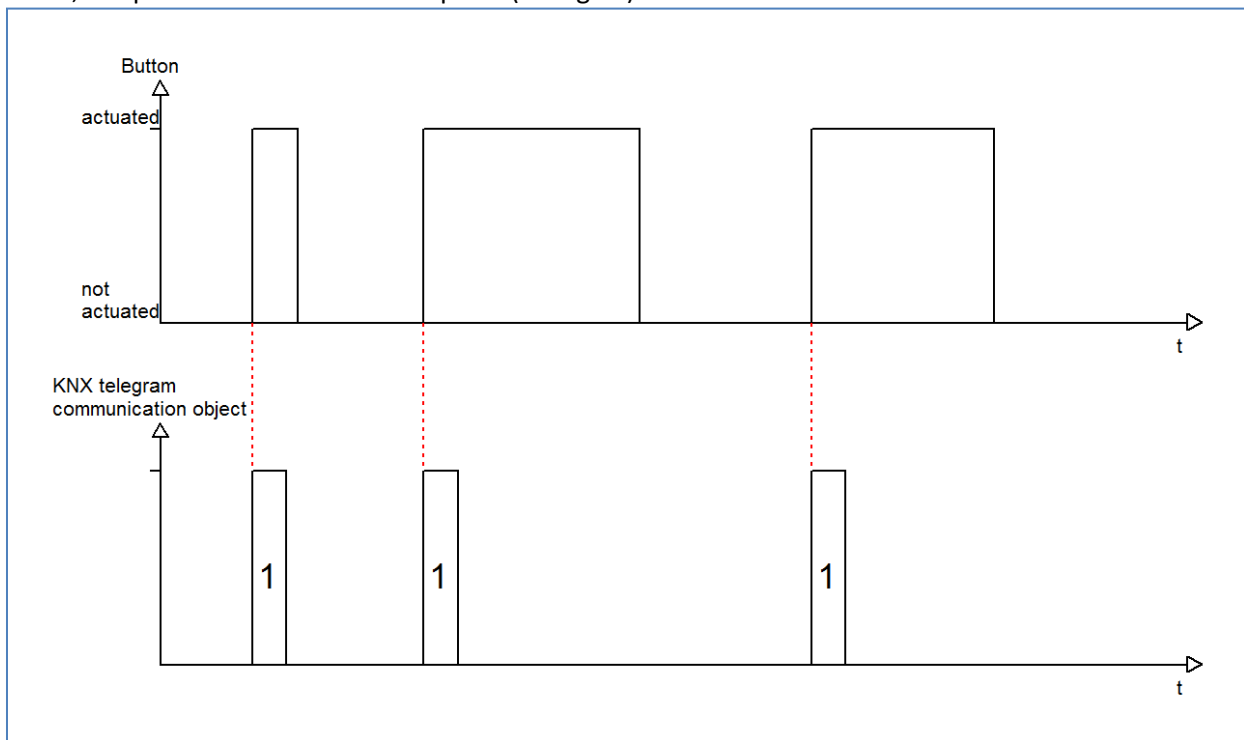

The following chart shows the corresponding communication object:

Number	Name	Length	Usage
0	Switch	1 Bit	Switching function, no differences between a long and a short keystroke

Table 17: Communication object switch by push/release

4.5.1.2 Toggle by push/release

The sub-function “toggle by push” or “toggle by release” toggles at the adjusted action. That means, the current value of the communication object is inverted at every switching process. By using this function an edge based alternating circuit can be realized.

The following diagram describes this sub-function. As soon as the state changes from 1 to 0, the push button sends the inverted signal. The signal is send always as a short pulse:

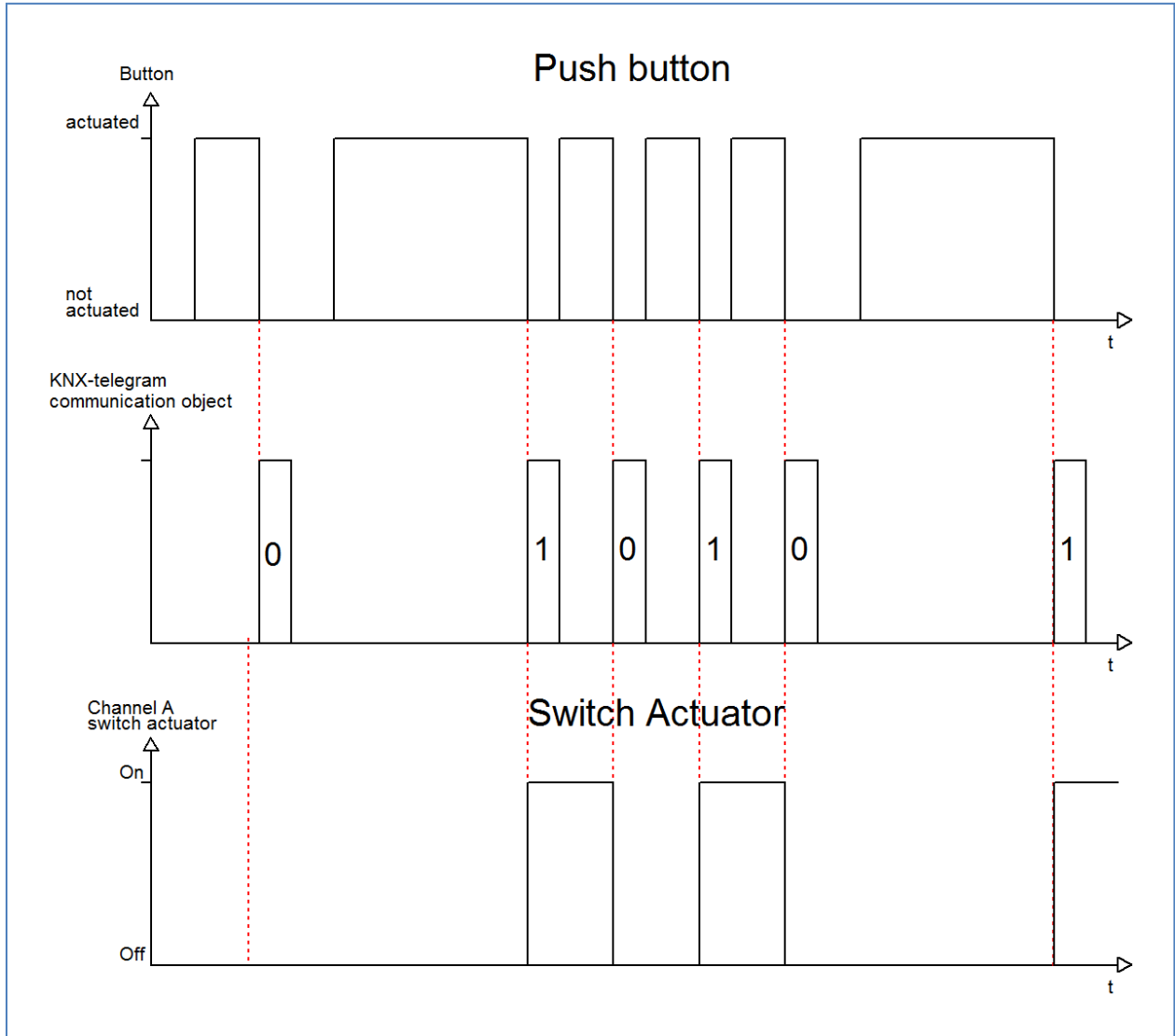

The following chart shows the corresponding communication objects:

Number	Name	Length	Usage
0	Switch	1 Bit	Switching function; no differences between long and short keystroke
1	Value for toggle	1 Bit	status object, indicates the switching state of the channel

Table 18: Communication objects toggle by push/release

To be sure that the push button toggles at every switching process, you have to connect the status object of the push button “Value for toggle” with the status object of the actuator. When the push button should work without an actuator, the object has to be connected to the switching object “switch”. The connection is important, because the push button cannot invert the signal, when it does not know its current state.

By undocking this communication object, you have more choices to program the push button. So you can use the object “Value for toggle” for visualizations or additional functions and you will be more free in design your project.

So you have for example the option to visualize the switching process by connecting the status-object to a switching object of a LED or something else.

4.5.1.3 Send Status

By using the sub-function „Send status“ the push button sends always the parameterized signal for the corresponding action. The following window is shown for the sub-function “Send status”:

Push button 1

Function	Switch
Subfunction	Send Status
Value for push	on
Value for release	off
Blocking object	not active

Figure 10: Sub-function send status

These settings are available:

ETS-text	Dynamic range [default value]	comment
Value for push	<ul style="list-style-type: none"> ▪ On ▪ Off 	switches on/off by pushing
Value for release	<ul style="list-style-type: none"> ▪ On ▪ Off 	switches on/off by releasing

Table 19: Parameter Send status

The corresponding communication object is shown at the following chart:

Number	Name	Length	Usage
0	Switch	1 Bit	Switching function; no differences between long and short keystroke

Table 20: Communication object send status

The parameter “Value for push” defines whether the channel should send an 1-signal (value: On) or a 0-signal (value: Off). If you want for example switch a channel of a switch actuator, you will have to choose different values for push and release. Otherwise the push button sends the same signal twice, for example an On-signal.

The cyclic sending causes that the state of the push button is sent periodically in certain parameterizable intervals. Then the push button sends the parameterized value for the corresponding edge.

A common application for this parameter is for example the observation of windows, which are equipped with window-contacts. So a display can for example show whether all windows are closed or not. Furthermore an alarm device can operate with this function.

The following diagram describes this sub-function. In this example, the push button sends a 1-signal for release and a 0-signal for push. Additionally the diagram shows the connection with a switch actuator, which was parameterized with a normal switching function:

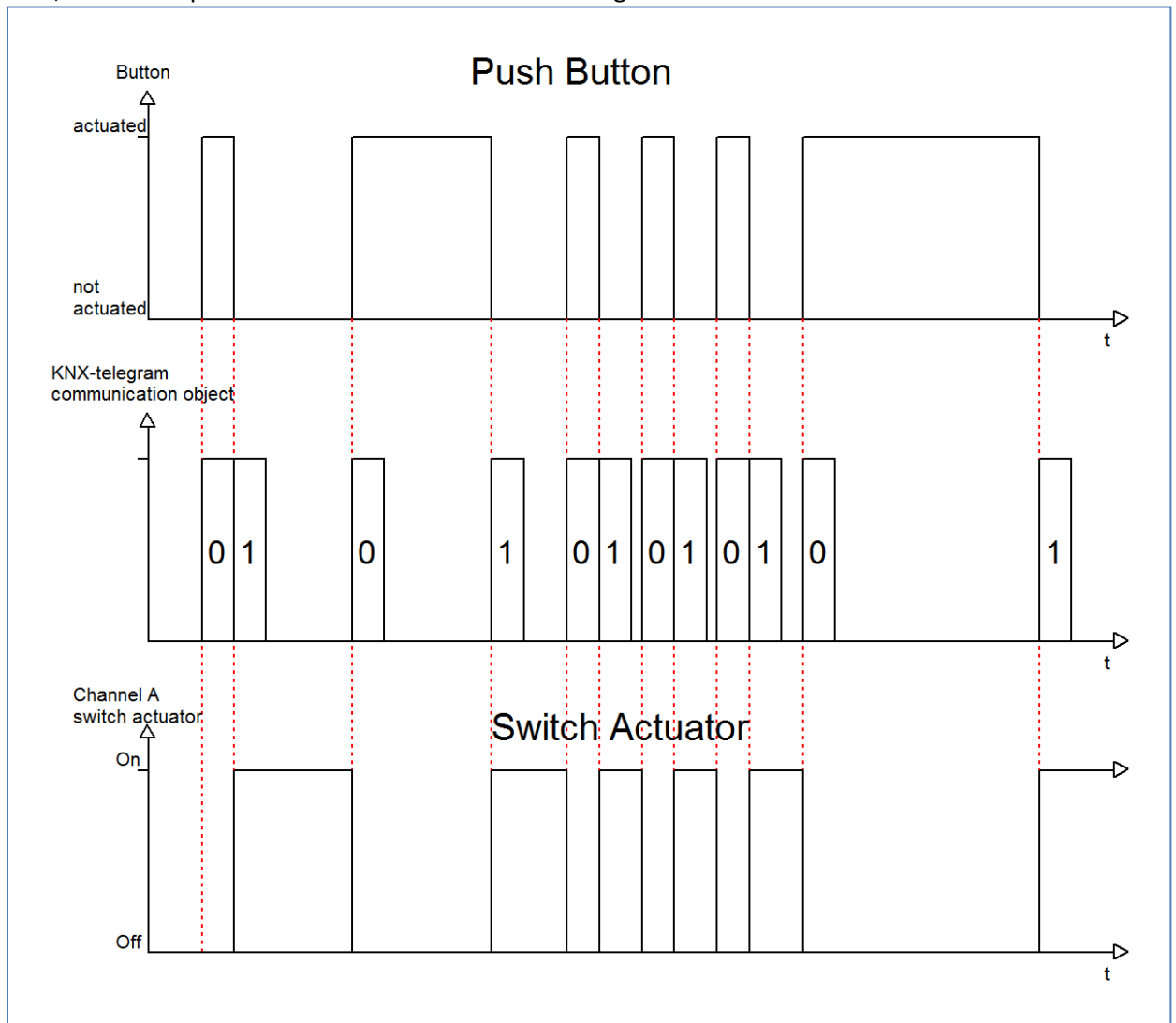

4.5.1.4 Send Value by push/release/push and release

There are two further sub-functions at the sub-function Send Value. On the one hand you can send 1 Byte Values and on the other hand you can activate a forced setting (2 Bit). These functions can be parameterized according to your wishes.

The following illustration shows this parameter:



Figure 11: Sub-function send value

After activating the sub function „Send value“, you have to choose which values should be sent. The setting options are shown at the chart:

ETS-text	Dynamic range [default value]	comment
Value (1 Byte)/ forced setting(2 Bit)	<ul style="list-style-type: none"> ▪ 1 Byte Value ▪ 2 Bit Value(forced setting) 	Choice between 1 Byte- and 2 Bit-Value

Table 21: Parameter send value

If you have activated the setting “1 Byte”, the following settings are possible:

ETS-text	Dynamic range [default value]	comment
Value for psuh/release	0-255 [0]	Assignment, which value should be send for push/release

Table 22: Parameter send value, 1 Byte object

The 1 Byte communication object can send any value in its dynamic range at both edges. The dynamic range is thereby from 0-255. Depending on parameterization the push button sends the adjusted values for the rising or the falling edge or for both edges.

The following chart shows the according communication object:

Number	Name	Length	Usage
0	Send value	1 Byte	sends the parameterized value

Table 23: Communication object Parameter Send value-1 Byte object

The setting option 2 Bit value (forced setting) has the following options to parameterize this function:

ETS-text	Dynamic range [default value]	comment
Send forced setting at rising/falling edge	<ul style="list-style-type: none"> ▪ Forced setting not active ▪ Forced setting off ▪ Forced setting on 	Assignment, which forced setting should be send at which edge

Table 24: Dynamic range send value-forced setting

The forced setting object allows for example to control the automatic brightness control of presence detectors.

The forced setting object can send 3 different states:

- **Forced setting not active (control=0; value=0)**
The forced setting object has no influence on the receiver. For example at a presence detector, the automatic function (motion detector operation) would be switched on.
- **Forced setting off (control=1; value=0)**
The forced setting object switches the receiver unconditionally off. For example a presence detector, would be switched permanent off. Detected motions have no influence on the output.
- **Forced setting on (control=1, value=1)**
The forced setting object switches the receiver unconditionally on. For example a presence detector, would be switched permanent on. Detected motions have no influence on the output.

The according communication object is shown at the chart:

Number	Name	Length	Usage
0	Send forced setting	2 Bit	sends the adjusted forced setting

Table 25: Communication object Send value-forced setting

4.5.1.5 Send value with on/off delay

The following setting options are available at the function “Send value with on/off delay”:

ETS-text	Dynamic range [default value]	comment
Delay time	0-60min [1s]	Adjustment of the delay time for the sending process

Table 26: Parameter Send value with delay

The sub-function “Send value with on/off delay” allows that the push button sends its value after a parameterized time. At the on-delay, the time starts when the associated button was switched on and at the off-delay, the time starts when the associated button was switched off. The push button sends always its current value at this function. If the value changes before the time ran out, the on-delay will expire. For example, when an input with a parameterized on-delay is switched off, before it was switched on, the input remains off.

The following diagram describes the sub-function „Send value with on-delay“:

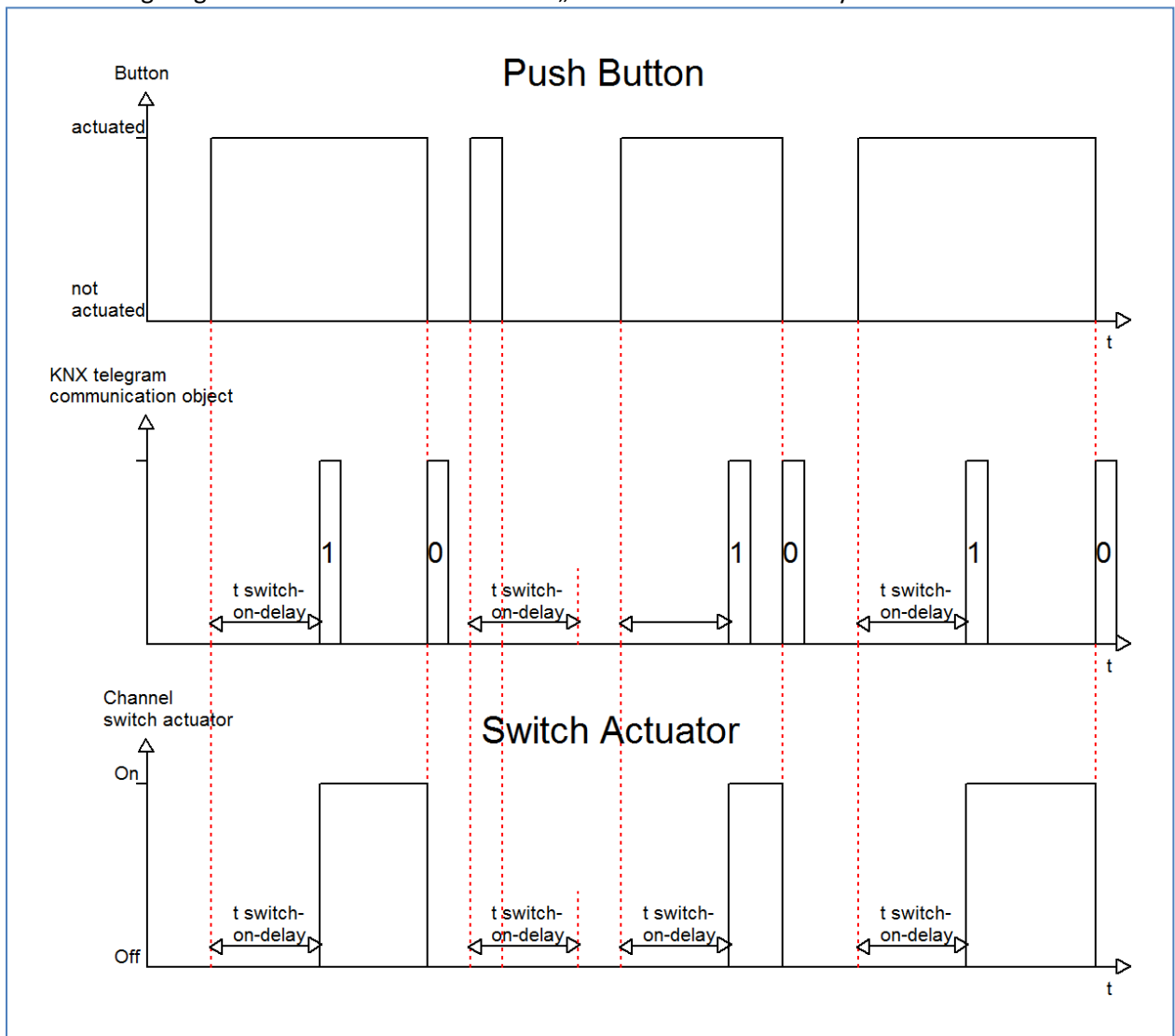

You can see the adjusted settings, which were made in the ETS for this setting:

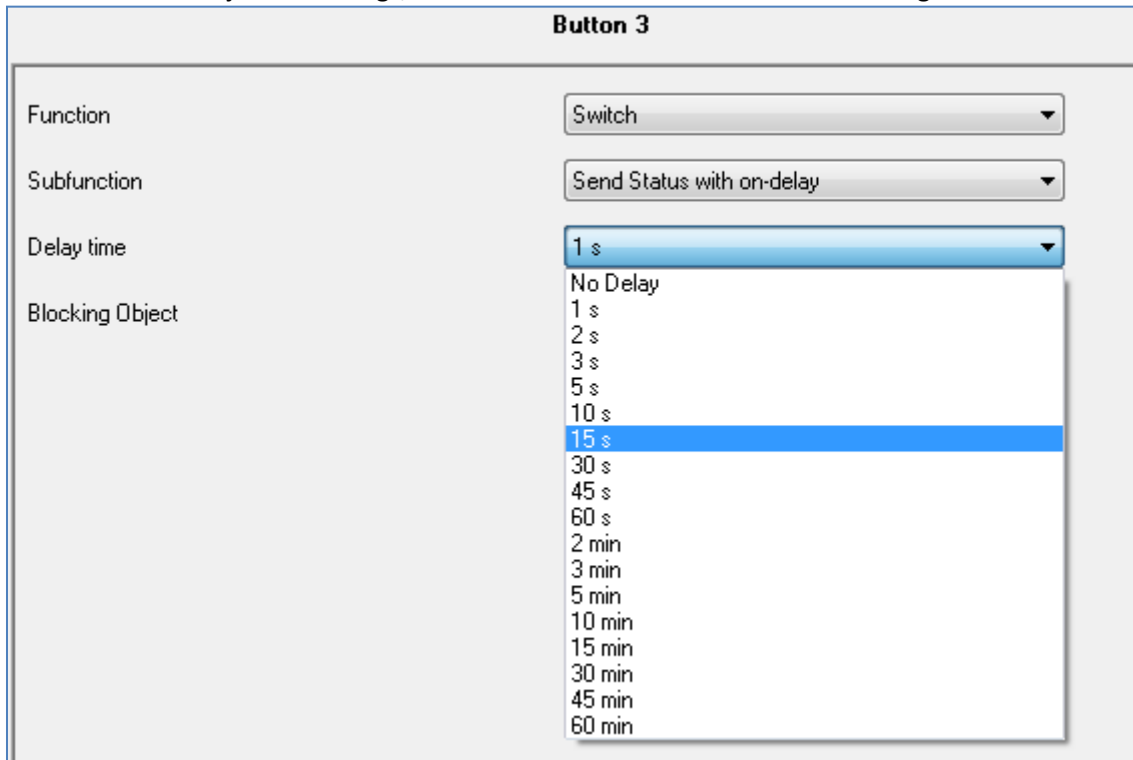

Figure 12: Send value with on-delay

The following chart shows the communication object:

Number	Name	Length	Usage
0	Switch	1 Bit	Switching function; no differences between long and short keystroke

Table 27: Communication object send value with delay

4.5.2 Scene

The scene function calls scenes, which are saved in actuators. Scene numbers in the push button and the actuators must be identical. It is possible to save scenes by a long keystroke if the saving function was activated.

The following illustration shows the setting options for this parameter:

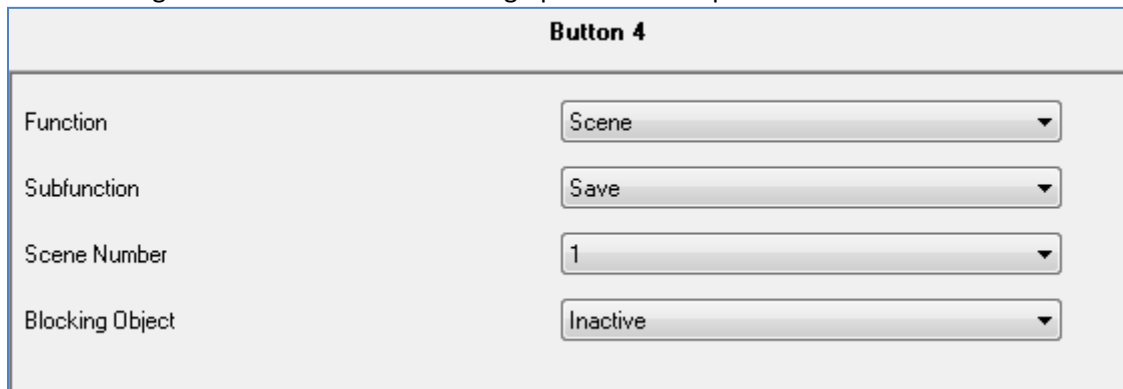

The screenshot shows a configuration window titled "Button 4". It contains four rows of settings, each with a label on the left and a dropdown menu on the right:

- Function: Scene
- Subfunction: Save
- Scene Number: 1
- Blocking Object: Inactive

Figure 13: Parameter Scene

The following chart shows the dynamic range of this parameter:

Sub-function	Dynamic range [default value]	comment
Saving function	<ul style="list-style-type: none"> ▪ No save ▪ Save 	Saving function is selected by a long keystroke
Scene number	1-64 [1]	Scene number must be identical with the one in the actuators
Blocking object	<ul style="list-style-type: none"> ▪ Inactive ▪ Active 	have a look at 4.3.1 blocking object

Table 28: sub-function scene

The chart shows the communication objects for this parameter:

Number	Name	Length	Usage
2	Scene	1 Byte	calls the depending scene

Table 29: Communication object Parameter scene

The scene function calls scenes, which were stored in actuators. Scenes contain of parameterized states of several actuators, which can be called with only one keystroke by using the scene function. Additional to the call of scenes, scenes can be saved at the call of a push button by a long keystroke. When the saving function was activated, a long keystroke at the push button saves the current state of the actuators to the depending scene.

For calling a scene or saving a new value for the scene, you have to send the accordingly code to the relevant communication object for the scene:

Scene	Retrieve		Save	
	Hex.	Dec.	Hex.	Dec.
1	0x00	0	0x80	128
2	0x01	1	0x81	129
3	0x02	2	0x82	130
4	0x03	3	0x83	131
5	0x04	4	0x84	132
6	0x05	5	0x85	133
7	0x06	6	0x86	134
8	0x07	7	0x87	135
9	0x08	8	0x88	136
10	0x09	9	0x89	137
11	0x0A	10	0x8A	138
12	0x0B	11	0x8B	139
13	0x0C	12	0x8C	140
14	0x0D	13	0x8D	141
15	0x0E	14	0x8E	142
16	0x0F	15	0x8F	143
17	0x10	16	0x90	144
18	0x11	17	0x91	145
19	0x12	18	0x92	146
20	0x13	19	0x93	147
21	0x14	20	0x94	148
22	0x15	21	0x95	149
23	0x16	22	0x96	150
24	0x17	23	0x97	151
25	0x18	24	0x98	152
26	0x19	25	0x99	153
27	0x1A	26	0x9A	154
28	0x1B	27	0x9B	155
29	0x1C	28	0x9C	156
30	0x1D	29	0x9D	157
31	0x1E	30	0x9E	158
32	0x1F	31	0x9F	159

Table 30: Calling and saving scenes

4.5.3 Switch short/long

The parameter switch short/long can assign the push button different switching processes for a long and a short keystroke.

The following illustration shows the sub-functions for this parameter:

Button 4

Function	<input type="text" value="Switch short/long"/>
Value for keystroke short - Object 1	<input type="text" value="On"/>
Value for keystroke long - Object 2	<input type="text" value="Nothing"/>
Blocking Object	<input type="text" value="Inactive"/>

Figure 14: Parameter switch short/long

The sub-functions for this parameter are shown in the chart below:

Sub-function	Dynamic range [default value]	comment
Value for keystroke short - Object 1	<ul style="list-style-type: none"> ▪ On ▪ Off ▪ Toggle ▪ Send value ▪ Nothing 	Action for a short keystroke
Value for keystroke long - Object 2	<ul style="list-style-type: none"> ▪ On ▪ Off ▪ Toggle ▪ Send value ▪ Nothing 	Action for a long keystroke
Blocking object	<ul style="list-style-type: none"> ▪ Inactive ▪ Active 	have a look at 4.3.1 blocking object

Table 31: Sub-functions parameter switch short/long

The chart shows the associated communication objects:

Number	Name	Length	Usage
0	push-button short	1 Bit/1 Byte	Switching function short keystroke
2	push-button long	1 Bit/ 1 Byte	Switching function long keystroke

Table 32: Communication object parameter switch short/long

The parameter “switch short/long” can control for example two channels of an actuator by using only one button. Furthermore you can switch a channel with a long keystroke on and with a short keystroke off. For both objects, a function can be set individually. Therefore the sub-functions on, off, toggle and nothing are available. Two communication objects are displayed, which can be connected in any way. By activating the sub-function “toggle” an additional communication object appears, called “value for toggling”. This object is a status object for the push button and must be connected to the status-object of the actuator (have a look at: 4.5.1 Toggle)

The following diagram shows the behavior of this parameter. Both objects (push-button and push-button long) were set to toggle. The object for the long keystroke is connected to channel A of the switch actuator and the object for the short keystroke is connected to channel B:

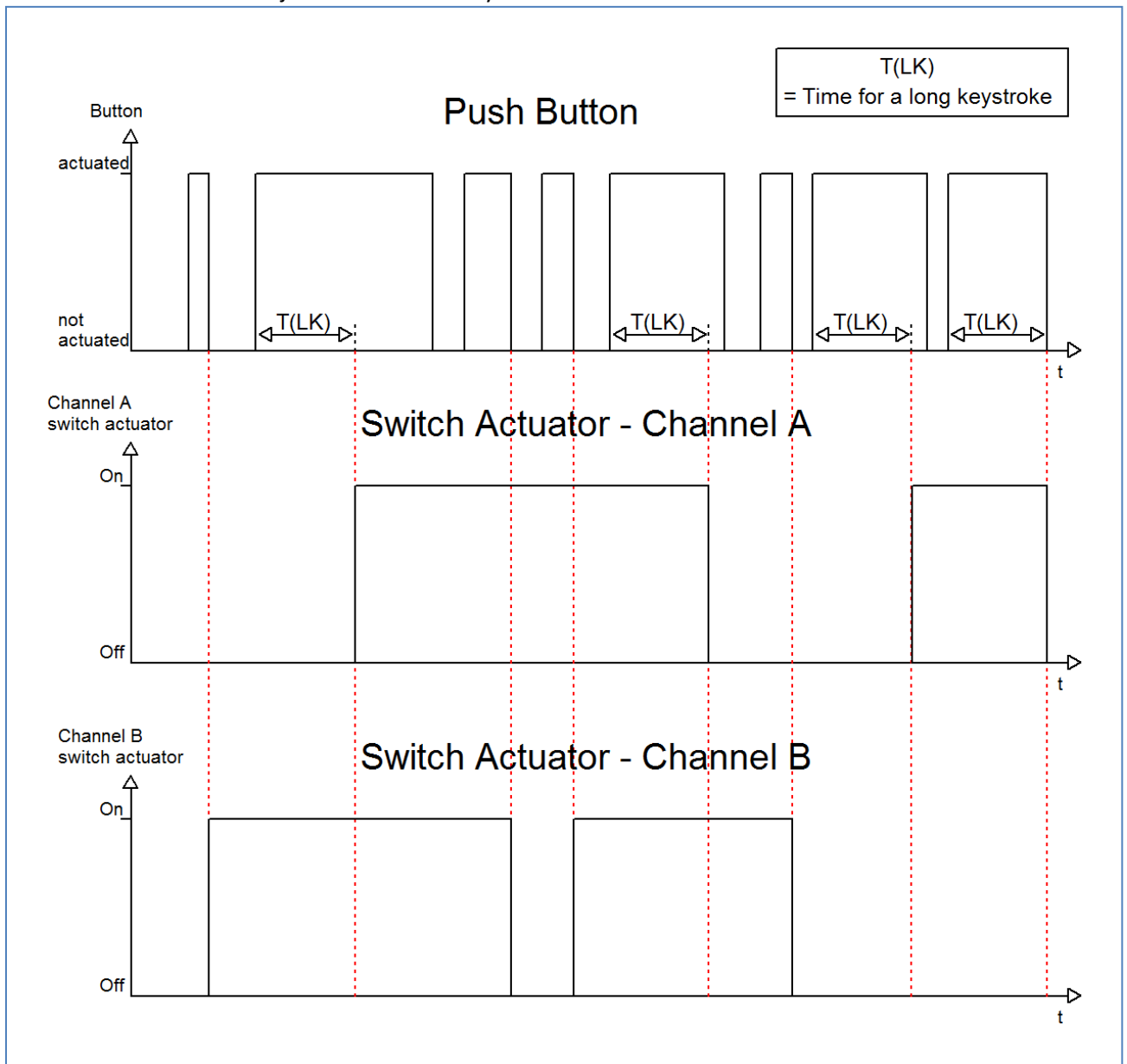

In this example the push button toggles Channel B with a short keystroke. The Channel A does not react to a short keystroke. This one reacts only at a long keystroke with toggling.

The following diagram shows a further application example for this parameter. In this example, the object for a long keystroke switches the channel A of a switch actuator on. A short keystroke switches the channel off. The three communication objects were connected in only one group address:

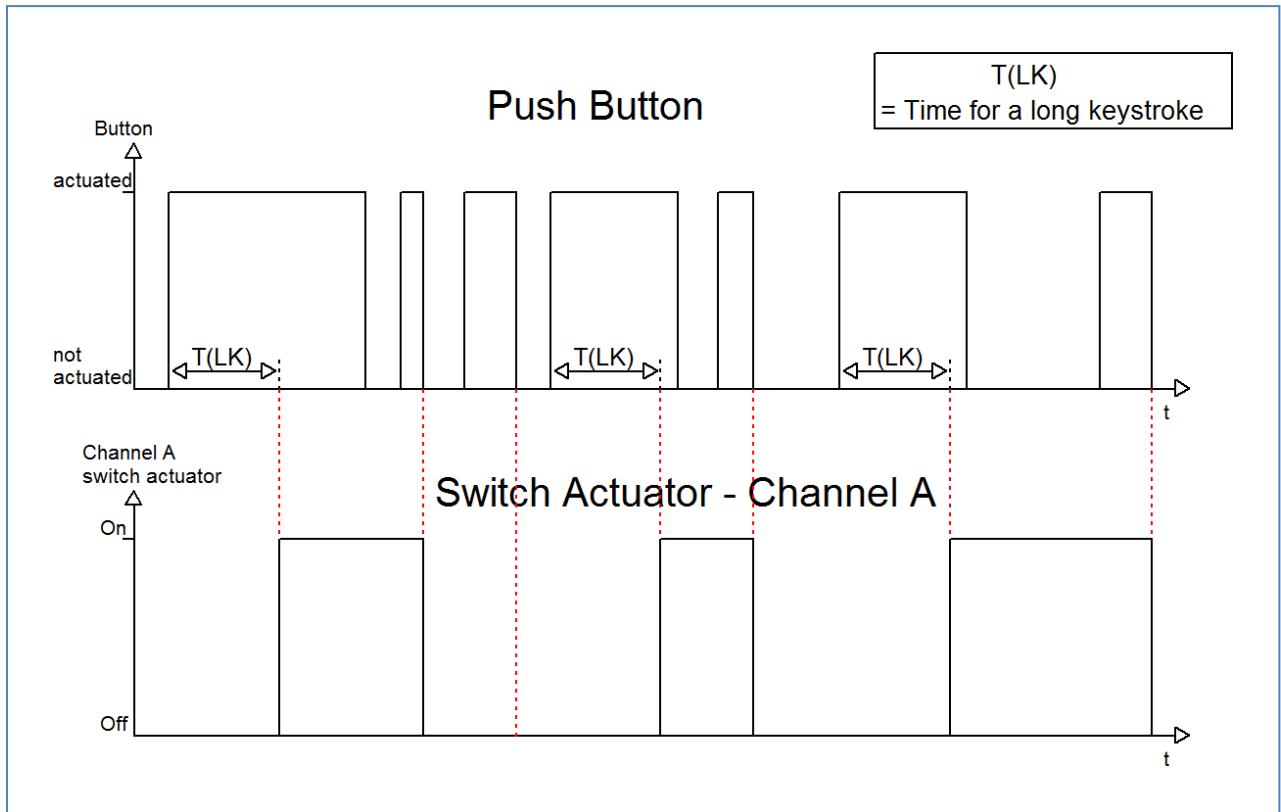

If the sub function “Send value” is selected, the following additional settings appear:

Sub-function	Dynamic range [default value]	comment
Value for keystroke short/long	Send value	chosen sub-function: Send value
Send value	<ul style="list-style-type: none"> ▪ 1 Byte-Value [0...255] ▪ Scene number 	Selection of the value, which shall be sent
1 Byte-Value [0...255]	0-255 [0]	Selection of the byte value, which shall be sent if byte value is chosen
Scene number	1-64 [1]	Selection of the scene number, which shall be sent if scene number is chosen

Table 33: Sub function Send value at switch short/long

Any value can be sent for the sub function „Send value“ at a short/long keystroke. As well scenes can be called as any byte value can be sent. So it is for example possible to call different scenes for a long and a short keystroke or sending absolute height/brightness commands.

4.5.4 One button dimming

At the dimming function for the single channels, the dimming process is proceeded by only one channel.

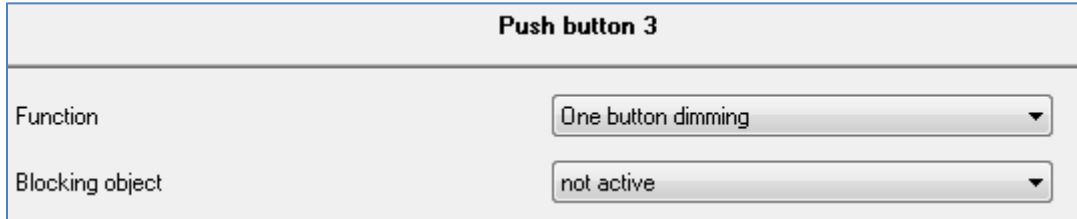

The screenshot shows a configuration window titled "Push button 3". It contains two dropdown menus. The first is labeled "Function" and is set to "One button dimming". The second is labeled "Blocking object" and is set to "not active".

Figure 15: Parameter one-button dimming

At the following chart, the sub functions for this parameter are shown:

Sub-function	Dynamic range [default value]	comment
Blocking object	<ul style="list-style-type: none"> ▪ Inactive ▪ Active 	have a look at 4.3.1 blocking object

Table 34: Sub function one-button dimming

The chart shows the available communication objects:

Number	Name	Length	Usage
0	Dimming on/off	1 Bit	Switching function for the dimming process; action for the short keystroke
1	Dimming	4 Bit	dimming function; action for a long keystroke
2	Value for toggle	1 Bit	status object, must be connected with the status function of the actuator for getting feedback of the current switching process

Table 35: Communication objects one-button dimming

At the one-button dimming, the dimming process is executed by one single channel. So it is possible to dim the lights via only one button.

By a long keystroke the communication “Dimming” is called, which is responsible for the dimming process and by a short keystroke the object “Dimming on/off” is called which is responsible for the switching.

The dimming direction is toggled by every keystroke, so if you have dimmed darker, the next time will be dimmed brighter and vice versa.

The one-button dimming is a start stop dimming, that means when the dimming function is active a darker or brighter command is sent until the button is released again. After releasing the button a stop command is sent, which stops the dimming process. The dimming step is set fixed to 100%. So with only one button activation the lights can be dimmed from 0% to 100% or from 100% to 0%.

4.5.5 One-button Shutter

The shutter function for the unique channels, often called one-surface shutter, performs the shutter-function by using only one channel.

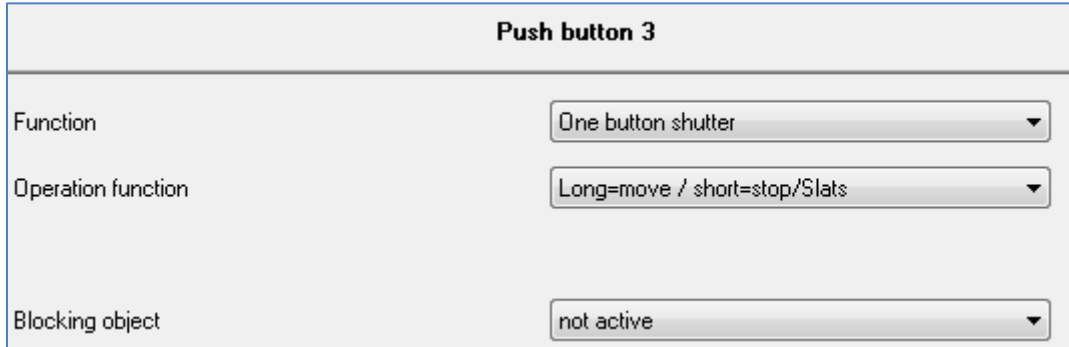

Figure 16: Parameter one-surface shutter

The sub-functions for this parameter are shown in the chart below:

Sub-function	Dynamic range [default value]	comment
Blocking object	<ul style="list-style-type: none"> ▪ Inactive ▪ Active 	have a look at 4.3.1 blocking object

Table 36: Sub-functions one-surface shutter

The chart shows the communication objects for this parameter:

Number	Name	Length	Usage
0	Shutter	1 Bit	Driving function of the shutter, action for a long keystroke
1	Blinds/Stop	1 Bit	Stop/ Adjustment of blinds; action for a short keystroke
2	Value for change of direction	1 Bit	Shows the last driving command

Table 37: Communication objects one-surface dimming

The one-surface dimming is performed by using only one channel. The communication object “Shutter” is addressed by a long keystroke and performs the up- and down-movement of the shutter. The direction of movement depends to the last direction of movement. If the shutter were driven up at the last time, they will be driven down at the next time. So the direction of movement changes after every movement.

The communication object “Blinds/Stop” is addressed by a short keystroke. Addressing this object stops a running movement of the shutter. Furthermore it will adjust the blinds if a shutter function is selected for this channel. The direction of the adjustment changes also here after every movement in the same way like the up/down moving of the shutter.

It is also possible to switch the functions for the short and the long keystroke. So it can be chosen whether a short or a long keystroke shall drive the shutter/blinds. The Stop-/ Adjustment object gets the other operating concept.

The object “Value for change of direction” serves as state object. It must be connected to the direction object of the actuator. So the button sends always the complementary value as before.

4.6 Panic/Cleaning function

If at least 3 buttons are pressed simultaneously, the panic or the cleaning function is activated. At the push button settings, have a look at 4.2 Configuration, can be defined which function shall be called at a short keystroke of at least 3 buttons and which function shall be called at long keystroke of at least 3 buttons.

The cleaning function is only a blocking of all buttons for the fixed adjusted time of 10 seconds. An active cleaning function is indicated by flashing of all white LEDs. The function allows an easy cleaning of the push button and avoids a function call during the cleaning process.

The panic function can generate an additional function call at the activation of at least 3 buttons. So function calls of central functions, like central on/off, forced settings can be generated or scenes can be called.

The following chart shows the menu for the panic buttons:

Panic push button	
Subfunction	Switch
Value for push	on
Blocking object	not active

Figure 17: Parameter Panic push button

Folgende Parameter sind für die Paniktasten verfügbar:

Function	Dynamic range [default value]	comment
Sub-function	<ul style="list-style-type: none"> Switch Toggle Send value 	Sub-function for the panic function
At Switch: Value for push	<ul style="list-style-type: none"> On Off 	At the sub function switch can be adjusted which value shall be sent
At send value: 1 Byte Value	0-255 [0]	If the sub function send value is adjusted as Byte value any value from 0-255 can be sent
At send value: 2 Bit Value (Forced setting)	<ul style="list-style-type: none"> forced setting not active forced setting ON forced setting OFF 	If the sun function send value is adjusted as forced setting, the type of the forced setting can be adjusted
Blocking object	<ul style="list-style-type: none"> Inactive Active 	have a look at 4.3.1 blocking object

Table 38: Parameter Panic button

An activated panic function is indicated by a light up of all red LEDs for a half second. The light behaviour is adjusted fixed and can not be changed of the user. The panic function calls at the activation the adjusted settings.

If at the call of the panic the function also the functions for the single buttons are called, the reaction time should be adjusted slower. This setting can be done at the menu button configuration (have a look at 4.2 Configuration).

An active cleaning function is indicated by a flashuig of all white LEDs at the rhythm 1:1 for the duration of the cleaning function. There are no further settings available for the cleaning function, because the cleaning function is only blocking of all buttons for the duration of 10 seconds.

4.7 Configuration of LED lights

The configuration of the LED lights is divided into the configuration, the general settings can be done at this menu, and the settings for each single LED per button.

The following illustration shows the menu Configuration of LED lights:

Configuration of LED lights	
Switching Day / Night	Day = 1 / Night = 0
LED orientation light	on
LED Orientation brightness by day	brightness 5
LED Orientation brightness by night	brightness 3
Block object for LED	not active
Behaviour of LEDs at bus power up	No read LED objects

Figure 18: Configuration of LED lights

The following parameters are for the LED-configuration available:

ETS-Text	Dynamic range [default value]	comment
Switching Day/Night	<ul style="list-style-type: none"> • not active • Day=1/Night=0 • Day=0/Night=1 	Adjustment of the polarity of the day/night object
LED orientation light	<ul style="list-style-type: none"> • Off • On • over ext. object 0=Off, 1=On • over ext. object 1=Off, 0=On 	Activation and adjustment of the orientation light
LED orientation by day	<ul style="list-style-type: none"> ▪ Off ▪ Brightness 1 - 5 	Luminiscent behaviour of the orientation light at day
LED orientation by night	<ul style="list-style-type: none"> • Off • Brightness 1 - 5 	Luminiscent behaviour of the orientation light at night
Blocking object for LED	<ul style="list-style-type: none"> • not active • block button LEDs • block orientation LED • block all LEDs 	Activation of the blocking object and adjustment which LEDs shall be blocked
Behavior of LEDs at bus power up	<ul style="list-style-type: none"> • Read LED objects • No read all LED objects 	activates the read of the LED objects at bus power up

Table 39: Configuration LED lights

The parameters are explained at the following segments:

- **Switching Day/Night**
The day/night object is used for the brightness control of the LEDs. So it can be adjusted a brightness for every LED for daytime and for night. The polarity of the object can be adjusted.
- **LED orientation**
The orientation light can be switched permanent on or off. Further more it can be activated or deactivated by an external object.
- **Blocking object for LED**
A common blocking object for all LEDs exists. This can be activated at this parameter and the blocking behaviour can be defined. The blocking behaviour for each single LED can be realized via the priority setting.
- **Behavior of LEDs at bus power up**
If the LED objects are read at a bus power up, these know instantly its current state. If the objects are not read, all LEDs are called at a bus power up with the settings for switched off.

4.7.1 LED 1 – 4[8]

Every LED can be activated single and parameterized individually. This can be done at the submenu for each LED:

LED 1

LED 1 (top left) active	yes
LED 1 reacts at:	external object and buttons activation
LED characterization by day (value ON)	white brightness 3
LED characterization by day (value OFF)	red brightness 3
State of LED by day (value ON)	blinking
LED characterization by night (value ON)	white brightness 3
LED characterization by night (value OFF)	red brightness 3
State of LED by night (value ON)	blinking
Priority LED 1	not active

Figure 19: Configuration LEDs per button

The following chart shows the available settings if the LED was activated:

ETS-Text	Dynamic range [default value]	comment
LED 1 – 4[8] reacts at	<ul style="list-style-type: none"> ▪ external object ▪ internal object ▪ button activation ▪ external object and button activation ▪ internal object and button activation 	Adjustment by what the LED shall be called
LED characterization by day (Value ON)	<ul style="list-style-type: none"> ▪ off ▪ white, brightness 1 – 5 ▪ red, brightness 1 – 5 ▪ [white, brightness 3] 	Luminiscent behaviour of the LED at day and value on
LED characterization by day (Value OFF)	<ul style="list-style-type: none"> ▪ off ▪ white, brightness 1 – 5 ▪ red, brightness 1 – 5 	Luminiscent behaviour of the LED at day and value off
State of LED by day (Value ON)	<ul style="list-style-type: none"> ▪ permanent ▪ blinking 	defines the luminescent behaviour when the LED is switched on

LED characterization by night (Value ON)	<ul style="list-style-type: none"> ▪ off ▪ white, brightness 1 – 5 ▪ red, brightness 1 – 5 ▪ [white, brightness 1] 	Luminiscent behaviour of the LED at night and value on
LED characterization by night (Value OFF)	<ul style="list-style-type: none"> ▪ off ▪ white, brightness 1 – 5 ▪ red, brightness 1 – 5 	Luminiscent behaviour of the LED at night and value off
State of LED by night (Value ON)	<ul style="list-style-type: none"> ▪ permanent ▪ blinking 	defines the luminescent behaviour when the LED is switched on

Table 40: Parameter LED 1-4[8]

The LED activated as follows:

- **external object**
By the activation via an external object, an additional communication object is shown, which can be called from every device at the bus system.
- **internal object**
By activation via an internal object, the LED can be called from any available object of the push button. For this purpose an additional window “Select of the object number” is shown in which the number of the calling object can be selected.
- **button activation**
The LED reacts standardly at the button activation. The value for on is called when the button is activated and the value for off when the button is not activated.
- **external object and button activation**
By this function it is possible to activate the LED via button activation and an external object. The settings for the LED characterization by value on and off refer to the external object. So the external object is preferential, because it has permanent a value. At the button activation, the LED lights 2 steps brighter. If the LED is already at the highest brightness level, the LED will be switched off at button activation. A blinking LED is switched into the permanent mode.
- **internal object und button activation**
By this function it is possible to activate the LED via button activation and an internal object. The settings for the LED characterization by value on and off refer to the internal object. So the internal object is preferential, because it has permanent a value. At the button activation, the LED lights 2 steps brighter. If the LED is already at the highest brightness level, the LED will be switched off at button activation. A blinking LED is switched into the permanent mode.

4.7.2 LED Priority

By using the LED priority fixed values can be generated and the LED can be locked for further activations.

The following illustration shows the LED priority:

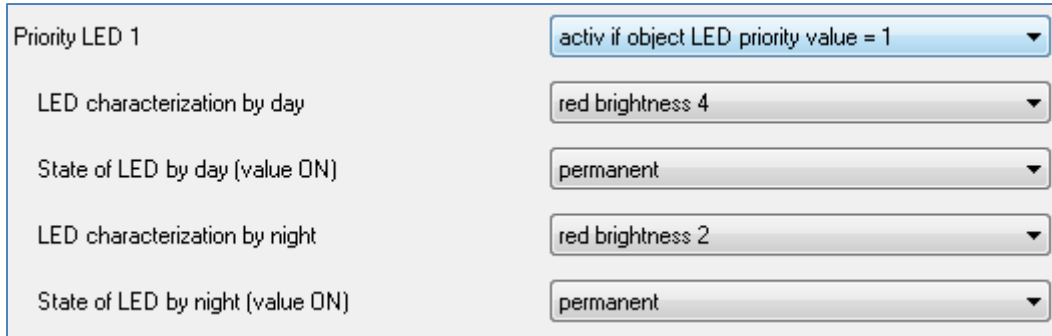

Figure 20: Parameter LED Priority

The following chart shows the available settings, when the LED priority was activated:

ETS-Text	Dynamic range [default value]	comment
Priority LED 1 – 4[8]	<ul style="list-style-type: none"> ▪ not active ▪ active, if object LED priority value = 1 ▪ active, if object LED priority value = 0 	Activation of the LED priority
LED characterization by day	<ul style="list-style-type: none"> ▪ off ▪ white, brightness 1 – 5 ▪ red, brightness 1 – 5 [white, brightness 3] 	Luminiscent behaviour of the LED at day when the priority is switched on
State of LED by day(value ON)	<ul style="list-style-type: none"> ▪ permanent ▪ blinking 	defines the luminescent behaviour when the LED is switched on
LED characterization by night	<ul style="list-style-type: none"> ▪ off ▪ white, brightness 1 – 5 ▪ red, brightness 1 – 5 [white, brightness 1] 	Luminiscent behaviour of the LED at night when the priority is switched on
State of LED by night(value ON)	<ul style="list-style-type: none"> ▪ permanent ▪ blinking 	defines the luminescent behaviour when the LED is switched on

Table 41: Parameter LED priority

The LED priority calls fixed adjusted brightness values for the corresponding LED and locks the LED for further activations. There is also at the LED priority a differentiation between day and night.

The following chart shows the communication objects for the LED lights:

Number	Name	Length	Usage
37/57	LED 1 – 4[8]	1 Bit	switches the LED on/off
41/65	LED priority 1 – 4[8]	1 Bit	switches the LED priority on/off
45/73	LED orientation	1 Bit	switches the orientation light on/off
46/74	LED Block object	1 Bit	activates the blocking function
47/75	Day/Night	1 Bit	Switchover between day and night

Table 42: Communication objects LED lights

4.8. Logic

The push buttons contain of 4 individually switchable and parameterize able logic blocks. At the following page, the logic blocks can be activated and the general settings can be made:

Settings for logic

Settings for logic 1	disabled ▼
Settings for logic 2	disabled ▼
Settings for logic 3	disabled ▼
Settings for logic 4	And ▼
Objecttype 4	Switch ▼
Sending condition	not automatic ▼
Output inverted	no ▼
Behaviour at bus power up	no read ext. logic objekts ▼

Figure 21: Activation logic functions

The following parameter can be adjusted once and is valid for all of the 4 logic blocks:

Sub-function	Dynamic range [default value]	comment
Behavior at bus power up	<ul style="list-style-type: none"> ▪ no read ext. logic objects ▪ read ext. logic objects 	sub-function indicates whether the external logic objects should be read or not at a bus power up

Table 43: Common Parameter logic blocks

If the read of the external logic at bus power up is activated, the status of all external logic objects will be read at a bus power up. So the logic operation is evaluated new. If this function is not active, the push button will hold the status before bus power outage.

The Chart shows the setting options for the logic blocks. The logic blocks can be assigned a logic function and an object type, the usage of this logic block:

Setting per logic [default value]	Dynamic range [default value]	comment
<ul style="list-style-type: none"> ▪ disabled ▪ And ▪ Or 	<ul style="list-style-type: none"> ▪ Switch ▪ Scene 	Every logic block can be adjusted as And- or as Or-function. Additional the object type (usage) can be adjusted for every block.

Table 44: Dynamic range logic

The following chart shows the communication objects for the logic functions:

Number	Name	Length	Usage
25/45	Logic input 1A	1 Bit	Communication object for an external logic; is only displayed when an external logic was activated
26/46	Logic input 1B	1 Bit	the same like logic input 1A
27/47	Logic Output 1	1 Bit	Output logic for switch is activated (=1-signal) when the logic block is true
27/47	Logic Output 1 Scene	1 Byte	Output logic for scenes is activated (=1-signal) when the logic block is true

Table 45: Communication objects logic

The communication objects for the other 3 possible logic blocks are the same like the first one. Three numbers are reserved for every logic block, so the next logic block starts at number 83.

As soon as a logic block is activated, a new sub-menu appears at the left selection list. In this menu can be set, which buttons should be connected to the logic block. Two external logic blocks can be activated additional. The external logic objects can be connected to communication objects of other devices by using the displayed communication objects “logic input 1 A&B”.

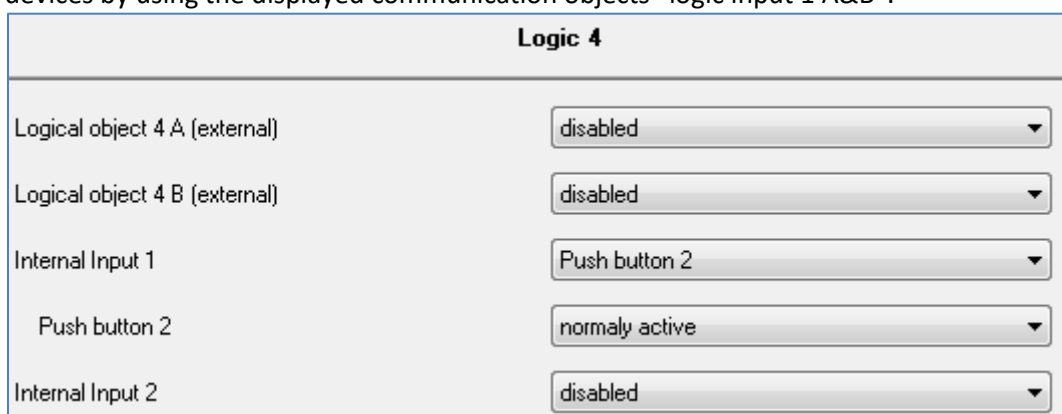

Figure 22: Setting logic

The read of the inputs (number depends to the device type) can be activated for every channel and two external objects. They can be read normal or inverted.

4.8.1 Logic sub-function switch

The chart shows the possible sub-functions for the logic sub-function switch:

Sub-function	Dynamic range [default value]	comment
Sending condition	<ul style="list-style-type: none"> ▪ not automatic ▪ change of input ▪ change of output 	Adjustment indicates, when the state of the logic block should be sent
Output inverted	<ul style="list-style-type: none"> ▪ No ▪ Yes 	Adjustment indicates, whether the output should be inverted or not

Table 46: Logic sub-function switch

The sending condition adjusts, when the push button should send a signal on the bus. By adjusting the sending condition “change of input”, the push button sends a signal at every change of any input whether that causes a change of the logic operation or not. The setting “change of output” causes that the push button sends only a signal when the logic changes its current status.

The sub-function Output inverted indicates whether the output signal should be issued inverted (that means reversed 1->0 and 0->1) or normal.

The following diagram shows the logic operation switch as an and-function. The logic reads in this example the channels A and B as well as an external logic object. The Output is inverted:

4.8.2 Logic sub function – Scene and Value

By using this logic sub-function scenes and byte values can be called.

The chart shows the available settings for the sub-function scene and value:

Sub-function	Dynamic range [default value]	comment
Scene number	1-64 [2]	Scene number must be the same like the one you want to call with the logic-function
1 Byte Value	0-255 [0]	Adjustment which byte value shall be sent when the logic function is true

Table 47: Logic sub-function scene and value

The logic function for the scenes and values works like a normal logic function. As soon as the logic function is satisfied, the communication object will send the adjusted scene-number or byte value. The communication object has the length of 1 Byte, so that it can be connected to other communication objects of scenes.

All sub-functions, like in a normal logic function can be parameterized. So you can set the logic function as an AND- or an OR-function and connect all inputs of the push button and additional 2 external logic objects to the logic function.

4.9 Room Temperature (RF-GTTxx.01)

The integrated room temperature sensor can send the room temperature to temperature controllers. So, no additional temperature sensors must be used.

The following chart shows the menu for the room temperature sensor:

Room temperature	
Sensor room temperature	active
Send temperature value cyclic	2 min
Alignment value (Value * 0,1 K)	0
Send temperature at changes of	0,3 °C
Upper state value	22 °C
Lower state value	7 °C

Figure 23: Room temperature sensor

The chart shows the available settings, when the room temperature was adjusted as active.

ETS-Text	Dynamic range [default value]	comment
Send temperature value cyclic	<ul style="list-style-type: none"> ▪ no send cyclic ▪ 1 min ▪ 2 min ▪ 3 min ▪ 5 min ▪ 10 min ▪ 15 min ▪ 20 min ▪ 30 min ▪ 60 min 	Adjustment if the temperature value shall be sent cyclic and defining of the time step
Alignment value (Value * 0,1K)	-50 – 50 [0]	The alignment value is for the increasedecrease of the measured value
Send tmeperatur value at changes of	no send, 0,1°C – 5°C [0,3°C]	Adjustment if the temperature value shall be sent at a determined change
Upper state value	not active, 20°C – 40°C [22°C]	Determination of the upper reporting value
Lower state value	not active, 3°C – 30°C [7°C]	Determination of the lower reporting value

Table 48: Parameter room temperature sensor

The following settings are available:

- **Send temperature value cyclic**
The temperature value can be sent in fixed time steps. The cyclic send is independent from a change of the temperature value.

- **Alignment value (Value * 0,1K)**
The measured temperature value can be corrected by this setting. By choosing a negative value for this parameter, the measured value will be lowered and by choosing a positive value, the measured value will be lifted. The value is multiplied by 0,1K, so the current value can be lowered or lifted up to 5K. This setting is useful, when the sensor was built at an unfavorable location, e.g. becoming draft or next to a window. When this function is activated, the temperature controller will also send the corrected values.
All sensors are matched in-plant to 0,1K.

- **Send temperature at change of**
By using this setting, the temperature can be sent at a determined absolute change.

- **Lower/upper state value**
If an upper/lower state value is adjusted, two additional 1Bit objects are shown. These send a 1-signal, when the temperature exceeds the upper state value or falls below the lower state value.

The following communication objects are available for the room temperature sensor:

Number	Name	Length	Usage
48	Measurement	2 Byte	sends the current temperature value
49	State maximum value	1 Bit	sends a 1-signal, when the temperature exceeds the adjusted value
50	State minimum value	1 Bit	sends a 1-signal, when the temperature falls below the adjusted value

Table 49: Communication objects room temperature sensor

5 Reference ETS-Parameter switching output

5.1 Channel selection

Every pair of channels can be selected as switch, staircase or shutter, blinds at the submenu outputs. If the pair of channels is selected as switch, staircase, every single channel can be parameterized as switch or staircase:

Channel A / B	Switch, Staircase lighting
Function Channel A	Switch output
Function Channel B	Staircase lighting
Channel C / D	Shutter, Blinds
Function Channel C / D	Blinds
Objects for automatic position	not active

Figure 24: Channel selection

Further more the automatic objects can be activated in this menu. The automatic objects are for shutter output, which is described in 6 Reference ETS-Parameter – Shutter output.

5.2 Identical parameter

The following parameters, which are described at the headings 5.2.x, are as well available at channels selected as switch as at channels selected as staircase.

5.2.1 Relay operating mode

The following illustration shows the setting options for this parameter:

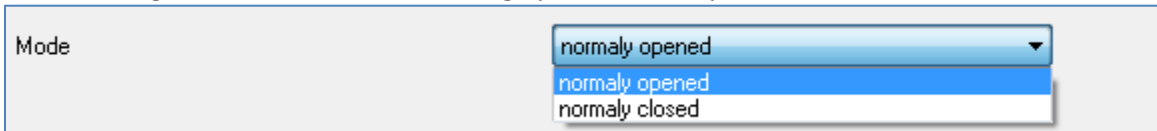

Figure 25: Operating mode

The following chart shows the dynamic range for this parameter:

ETS-text	Dynamic range [default value]	comment
Mode	<ul style="list-style-type: none"> ▪ normally opened ▪ normally closed 	Relay operating mode of the channel

Table 50: Operating mode

The following diagram shows the behavior of the relay operating mode normally closed and normally opened. The input for the channels is a KNX-telegram, which sends alternating 0-signals and 1-signals:

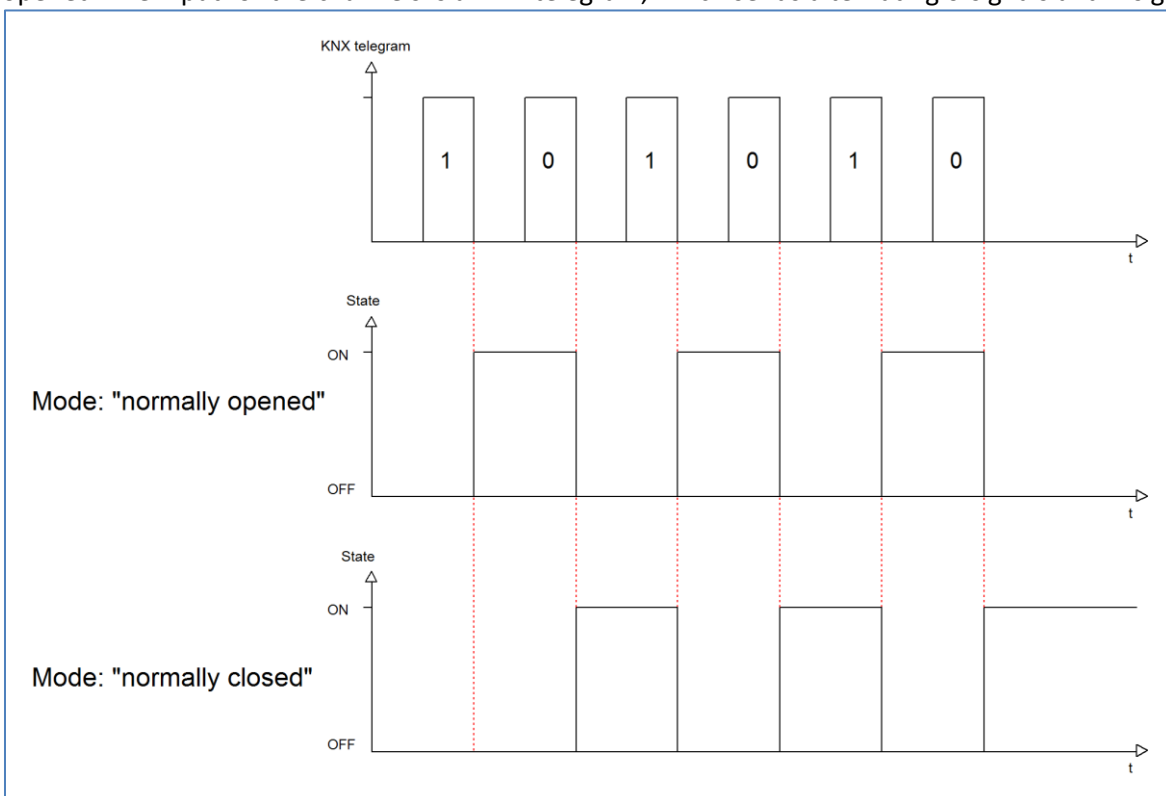

5.2.2 Central function

The following illustration shows the setting options at the ETS-Software:

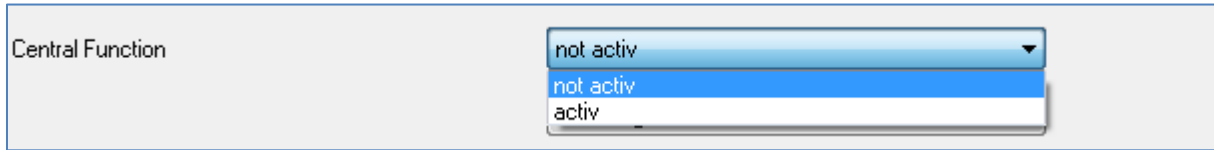

Figure 26: Central function

The following chart shows the dynamic range for this parameter:

ETS-text	Dynamic range [default value]	comment
Central function	<ul style="list-style-type: none"> ▪ not active ▪ active 	switches the central function on/off for this channel

Table 51: Central function

The central function can be switched on/off for every channel. For switching on this function, you have to choose the option “active”. By calling the central communication object, all channels with an activated central function are switched on with their current parameterization. So switch-on delays or staircase functions are still kept.

The central function can make programming much more easier and your project can become more clear.

The following chart shows the associated communication object:

Number	Name	Length	Usage
	Central function	1 Bit	central switching of the channels number depends to the number of channels

Table 52: Communication object central function

5.2.3 Behavior at block/unblock

The following illustration shows the setting options at the ETS-Software:

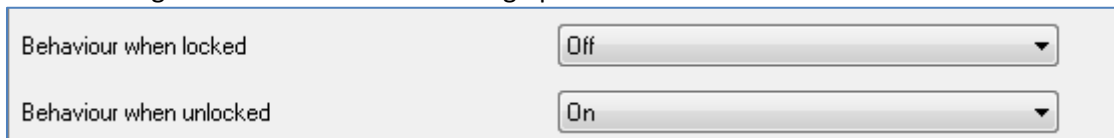

Figure 27: Blocking function

The following chart shows the dynamic range for this parameter:

ETS-text	Dynamic range [default value]	comment
Behavior when locked Behavior when unlocked	<ul style="list-style-type: none"> ▪ On ▪ Off ▪ no change 	Behavior to a blocking/unblocking process

Table 53: Behavior at block/unblock

The blocking function gets active, when the corresponding communication object becomes a logical “1”. By sending a logical “0”, the blocking function can be deactivated again.

The parameter “Behavior when locked” defines an action for the output at activating the blocking process. There are the setting on, off and no change available. The same settings are also available for the “Behavior when unlocked”. This action is called when the blocking function is deactivated again.

The following chart shows the corresponding communication object:

Number	Name	Length	Usage
87	Block	1 Bit	blocks the channel

Table 54: Communication object blocking function

The following diagram describes the blocking process. For the “Behavior when locked”, the action on was parameterized and for the “Behavior when unlocked” the action off was parameterized:

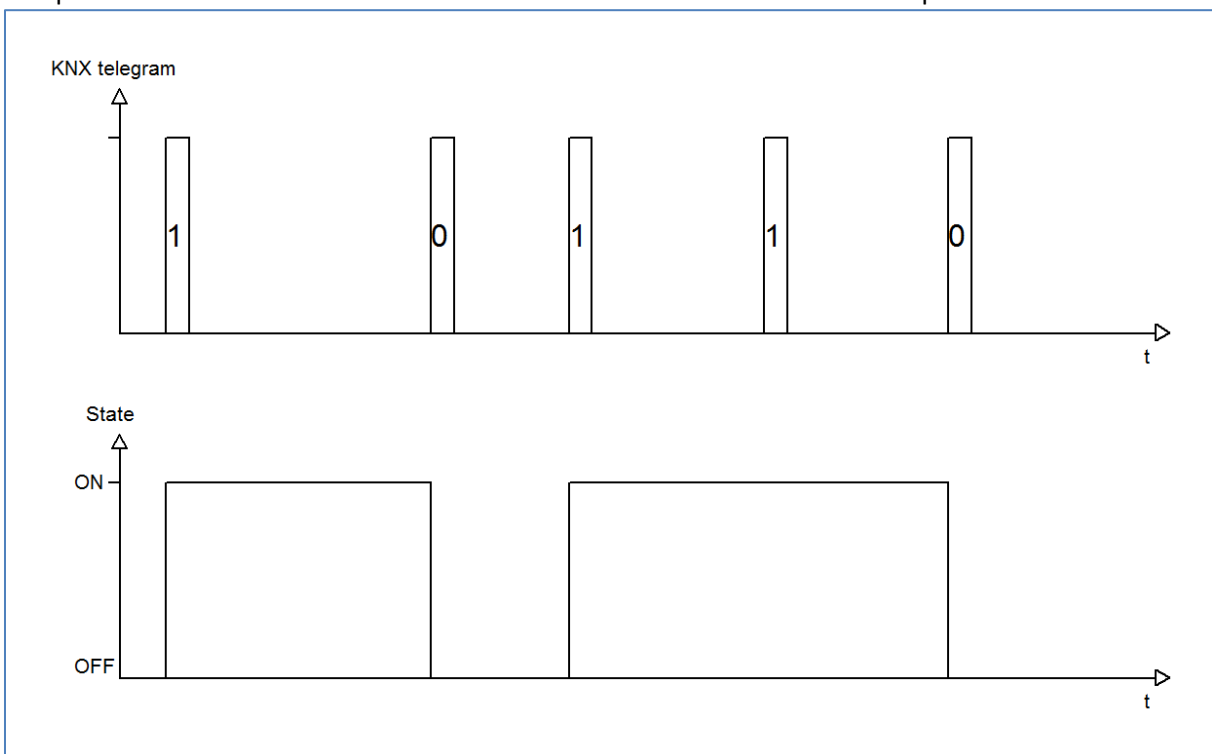

The KNX telegram shows which values are send to the blocking object. By sending a logical “1”, the blocking function is activated and the channel is switched on. The blocking function is deactivated again by sending a logical “0”. So the channel is switched off.

5.3 Switching output

The following parameters, which are described at the headings 4.4.x, are only available at channels selected as switch.

5.3.1 Overview

By choosing a channel as switch, a sub menu, called Channel A Switching, appears for this channel at the left drop down menu.

The sub menu is shown at the following illustration:

Mode	normally open
On delay [s]	0
Off delay [s]	0
Send cyclic current value [s]	0
Behaviour when locked	no change
Behaviour when unlocked	no change
Central function	not active
Logical functions	not active
Scene	not active

Figure 28: Switching output

The chart shows the possible settings for switching outputs:

ETS-text	Dynamic range [default value]	comment
Mode	<ul style="list-style-type: none"> ▪ normally opened ▪ normally closed 	Operation mode of the channel
On-Delay	0...30000 sec [0=no delay]	Switch on delay of the channel in seconds
Off-Delay	0...30000 sec [0=no delay]]	Switch off delay of the channel in seconds
Central function	<ul style="list-style-type: none"> ▪ not active ▪ active 	Activates the central function for this channel
Behavior when locked	<ul style="list-style-type: none"> ▪ Off ▪ On ▪ no change 	Action for activating the blocking process
Behavior when unlocked	<ul style="list-style-type: none"> ▪ Off ▪ On ▪ no change 	Action for deactivating the blocking process
Logic function	<ul style="list-style-type: none"> ▪ not active ▪ with one object ▪ with two objects 	Activation of the logic function with one or two objects
Logic operation	<ul style="list-style-type: none"> ▪ And ▪ Or 	Selection of the logic function only available, when the logic function was activated
Scene	<ul style="list-style-type: none"> ▪ not active ▪ active 	Activation of the scene function by activation this parameter a new sub menu appears (have a look at 4.4.4)

Table 55: Switching output

5.3.2 On-/Off-delay

The following illustration shows the setting options at the ETS-Software:

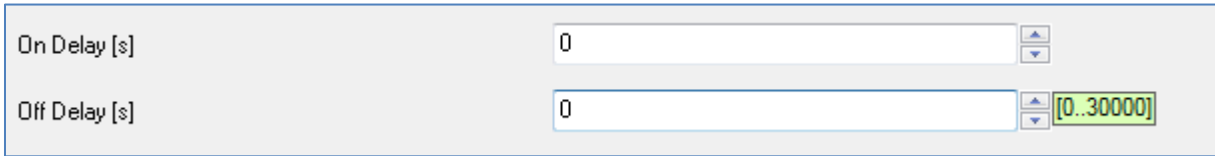

Table 56: On/Off delay

The on-delay causes a delayed switch of the channel. At sending an on-signal to the channel, first the adjusted on delay time expires and afterwards the channel will be switched on.

The off delay works on the same principle. At sending an off-signal, first the adjusted off delay time expires and afterwards the channel will be switched off.

Both functions work as well alone as combined. By adjusting “0 seconds” for a delay the function is switched off.

The following diagram describes the combination of on and off delay:

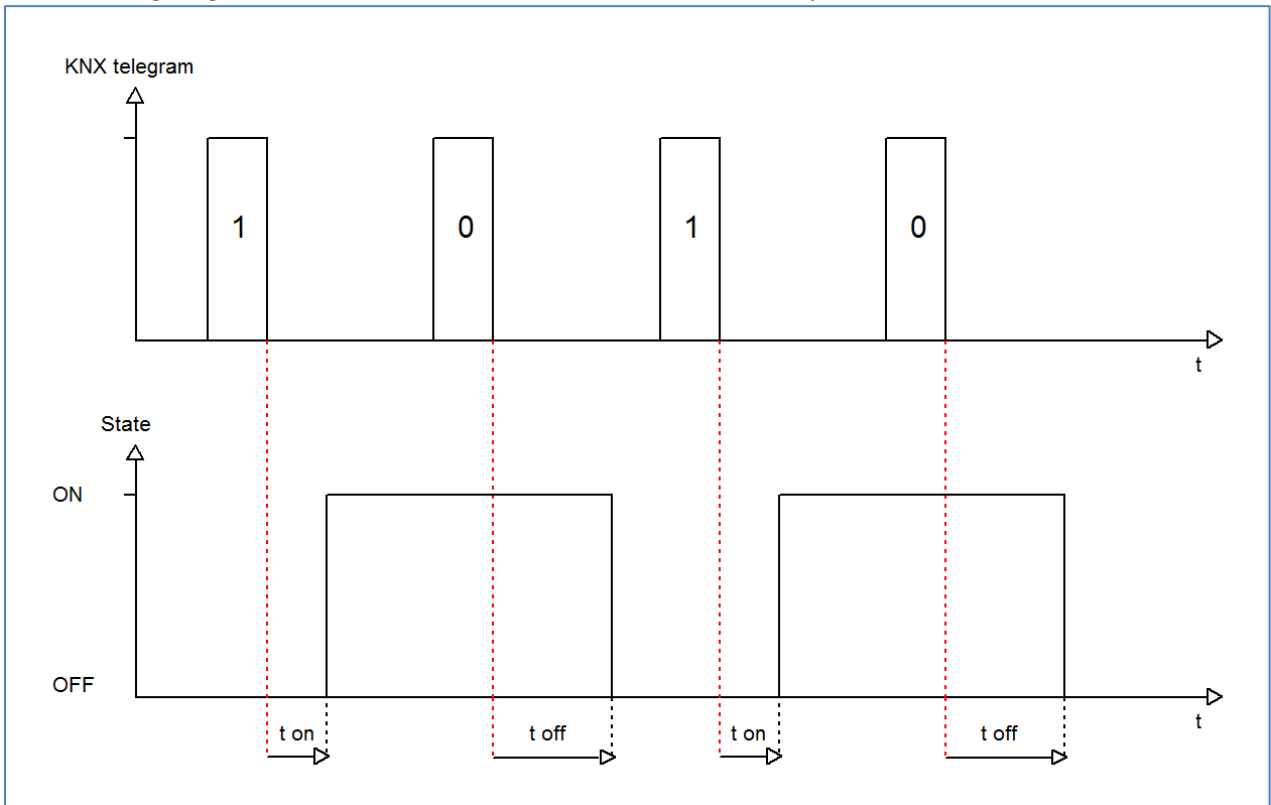

5.3.3 Logical functions

The following illustration shows the setting options at the ETS-Software:

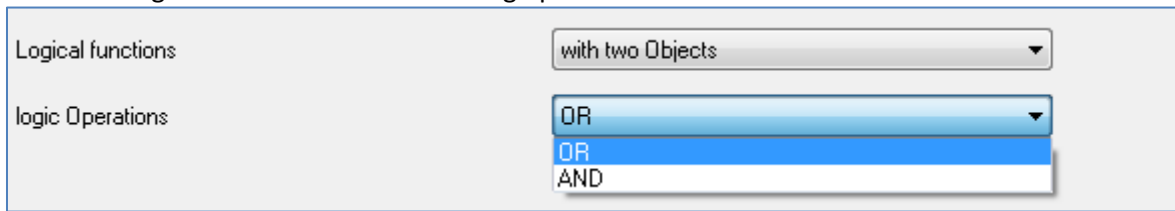

Figure 29: Logical functions

The logic function can be activated with one or two objects. The objects are the inputs of the logic block. Furthermore you can choose between an AND-function and an OR-function. When you have activated the logic function, the logic block has to be satisfied before switching the channel. As long as the logic function is not satisfied, the channel does not react to any signal.

The following chart shows the relevant communication objects:

Number	Name	Length	Usage
90	Logic 1	1 Bit	Logic object 1, is the first input for the logic block
91	Logic 2	1 Bit	Logic object 2, is the second input for the logic block

Table 57: Communication objects logic

According to the chosen logic operation only one or both objects have to become a 1-signal.

The following chart shows the both logic operations with two objects:

AND-Connection				OR-Connection		
Logic 1	Logic 2	Channel switchable?		Logic 1	Logic 2	Channel switchable?
0	0	No		0	0	No
0	1	No		0	1	Yes
1	0	No		1	0	Yes
1	1	Yes		1	1	Yes

Table 58: Logic operations

5.3.4 Scene function

When functions of different groups (e.g. light, heating and shutter) shall be changed simultaneously with only one keystroke, it is practical to use the scene function. By calling a scene, you can switch the lights to a specific value, drive the shutter to an absolute position, switch the heating to the day mode and switch the power supply of the sockets on. The telegrams of these functions can have as well different formats as different values with different meaning (e.g. "0" for switch the lights off and open the shutters). If there were no scene function, you would have to send a single telegram for every actuator to get the same function.

The scene function of the switch actuator enables you to connect the channels of the switch actuator to a scene control. For that, you have to assign the value to the appropriated space (scene A..H). It is possible to program up to 8 scenes per switching output. When you activate the scene function at the switching output, a new sub menu for the scenes appears at the left drop down menu. There are settings to activate single scenes, set values and scene numbers and switch the memory function on/off at this sub menu.

Scenes are activated by receiving their scene numbers at the communication object for the scenes. If the memory function of the scenes is activated, the current value of the channel will be saved at the called scene number.

The communication objects of the scenes have always the length of 1 byte.

The following illustration shows the setting options at the ETS-Software for activating the scene function:

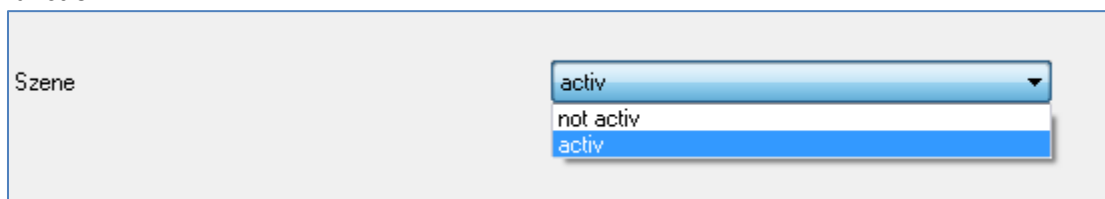

Figure 30: Scene function

The following chart shows the relevant communication object:

Number	Name	Length	Usage
88	Scene	1 Byte	Call of the scene

Table 59: Communication object scene

For calling a certain scene, you have to send the value for the scene to the communication object. The value of the scene number is always one number less than the adjusted scene number. For calling scene 1, you have to send a "0". So the scene numbers have the numbers from 1 to 64, but the values for the scenes only from 0 to 63.

If you want to call scenes by a binary input or another KNX device, you have to set the same number at the calling device as at the receiving device. The calling device, e.g. a binary input, sends automatically the right value for calling the scene.

There are up to 8 storage options for scenes at every channel.
 These 8 storage options can get any of the possible 64 scene numbers.

Channel A, Scene	
Save scene	enabled
Scene A	Off
Scene Number A	1
Scene B	Off
Scene Number B	2
Scene C	Off
Scene Number C	3
Scene D	Off
Scene Number D	4
Scene E	Off
Scene Number E	5
Scene F	Off
Scene Number F	6
Scene G	Off
Scene Number G	7
Scene H	Off
Scene Number H	8

Figure 31: Sub function scene

The chart shows the possible settings for scenes, which are identical for all channels. The settings are available at the sub menu for the scenes:

ETS-text	Dynamic range [default value]	comment
Save scene	<ul style="list-style-type: none"> ▪ disabled ▪ enabled 	Learning of scenarios; enable/disable memory function
Scene A	<ul style="list-style-type: none"> ▪ Off ▪ On 	Activation of the scene A
Scene number A	1-64 [1]	Scene number; Calling value = 1 less than the adjusted scene number
Scene B	<ul style="list-style-type: none"> ▪ Off ▪ On 	Activation of the scene B
Scene number B	1-64 [1]	Scene number; Calling value = 1 less than the adjusted scene number
Scene C	<ul style="list-style-type: none"> ▪ Off ▪ On 	Activation of the scene C
Scene number C	1-64 [1]	Scene number; Calling value = 1 less than the adjusted scene number
Scene D	<ul style="list-style-type: none"> ▪ Off ▪ On 	Activation of the scene D
Scene number D	1-64 [1]	Scene number; Calling value = 1 less than the adjusted scene number
Scene E	<ul style="list-style-type: none"> ▪ Off ▪ On 	Activation of the scene E
Scene number E	1-64 [1]	Scene number; Calling value = 1 less than the adjusted scene number
Scene F	<ul style="list-style-type: none"> ▪ Off ▪ On 	Activation of the scene F
Scene number F	1-64 [1]	Scene number; Calling value = 1 less than the adjusted scene number
Scene G	<ul style="list-style-type: none"> ▪ Off ▪ On 	Activation of the scene G
Scene number G	1-64 [1]	Scene number; Calling value = 1 less than the adjusted scene number
Scene H	<ul style="list-style-type: none"> ▪ Off ▪ On 	Activation of the scene H
Scene number H	1-64 [1]	Scene number; Calling value = 1 less than the adjusted scene number

Table 60: Parameter scene

For calling a scene or saving a new value for the scene, you have to send the accordingly code to the relevant communication object for the scene:

Scene	Retrieve		Save	
	Hex.	Dez.	Hex.	Dez.
1	0x00	0	0x80	128
2	0x01	1	0x81	129
3	0x02	2	0x82	130
4	0x03	3	0x83	131
5	0x04	4	0x84	132
6	0x05	5	0x85	133
7	0x06	6	0x86	134
8	0x07	7	0x87	135
9	0x08	8	0x88	136
10	0x09	9	0x89	137
11	0x0A	10	0x8A	138
12	0x0B	11	0x8B	139
13	0x0C	12	0x8C	140
14	0x0D	13	0x8D	141
15	0x0E	14	0x8E	142
16	0x0F	15	0x8F	143
17	0x10	16	0x90	144
18	0x11	17	0x91	145
19	0x12	18	0x92	146
20	0x13	19	0x93	147
21	0x14	20	0x94	148
22	0x15	21	0x95	149
23	0x16	22	0x96	150
24	0x17	23	0x97	151
25	0x18	24	0x98	152
26	0x19	25	0x99	153
27	0x1A	26	0x9A	154
28	0x1B	27	0x9B	155
29	0x1C	28	0x9C	156
30	0x1D	29	0x9D	157
31	0x1E	30	0x9E	158
32	0x1F	31	0x9F	159

Table 61: Calling and saving scenes

4.4.4.1 Scene programming example

When the scene function is activated for one channel, a new sub menu for the scene of this channel appears. Up to 8 scenes can be adjusted at this sub menu. Every scene gets one scene number, which enables the calling of the scene. You can adjust one specific state for every scene. So you can switch the channel off, with the setting “Off” or switch the channel on with the setting “On”. When the scene is called, the adjusted parameterization of the channel is kept (e.g. on delay, off delay, ...). To note at the scene programming is that if you want to call 2 or more channels with the same scene number, you have to set the both communication objects for the scenes to the same group address. By sending the calling value, both scenes are called. Your programming can become much clearer if you divide your group addresses by scene numbers. If now one channel shall react to 8 scenes, you will have to connect the communication object for the scenes to 8 group addresses.

The following illustrations shall make the division clearly:

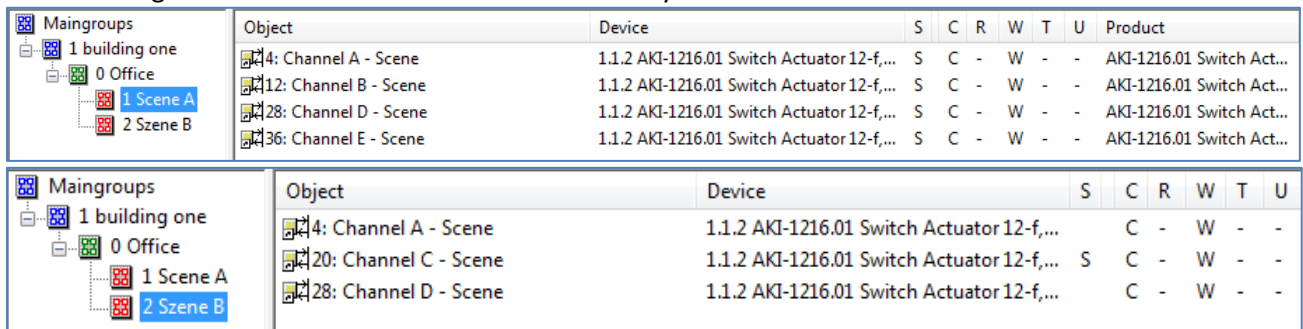

Object	Device	S	C	R	W	T	U	Product
4: Channel A - Scene	1.1.2 AKI-1216.01 Switch Actuator 12-f,...	S	C	-	W	-	-	AKI-1216.01 Switch Act...
12: Channel B - Scene	1.1.2 AKI-1216.01 Switch Actuator 12-f,...	S	C	-	W	-	-	AKI-1216.01 Switch Act...
28: Channel D - Scene	1.1.2 AKI-1216.01 Switch Actuator 12-f,...	S	C	-	W	-	-	AKI-1216.01 Switch Act...
36: Channel E - Scene	1.1.2 AKI-1216.01 Switch Actuator 12-f,...	S	C	-	W	-	-	AKI-1216.01 Switch Act...

Object	Device	S	C	R	W	T	U
4: Channel A - Scene	1.1.2 AKI-1216.01 Switch Actuator 12-f,...		C	-	W	-	-
20: Channel C - Scene	1.1.2 AKI-1216.01 Switch Actuator 12-f,...	S	C	-	W	-	-
28: Channel D - Scene	1.1.2 AKI-1216.01 Switch Actuator 12-f,...		C	-	W	-	-

Figure 32: Programming of scenes

The channels A and D shall react to the call of scene A and scene B. So they are connected to both group addresses.

Furthermore you can save scenes at the according scene numbers. For that you have to activate the memory function at a channel of the switch actuator. Now you can call scenes by a binary input with a short keystroke and save scenes by a long keystroke. The adjusted value for the scene is overwritten by the current state of the actuator, when you save the scenes. At the next call of the scene, the scene will be called with the new value.

5.4 Staircase

The following parameters, which are described at the headings 4.5.x, are only available at channels selected as staircase.

5.4.1 Overview

By choosing a channel as staircase, a sub menu, called Channel A Staircase, appears for this channel at the left drop down menu.

The sub menu is shown at the following illustration:

Mode	normally open
Time for Staircase lighting [s]	120
Prewarning	not active
Manual switching off	not active
Extend Staircase lighting time	not active
Send cyclic current value [s]	0
Behaviour when locked	no change
Behaviour when unlocked	no change
Central function	not active

Figure 33: Staircase

The chart shows all possible settings for staircase outputs:

ETS-text	Dynamic range [default value]	comment
Mode	<ul style="list-style-type: none"> ▪ normally opened ▪ normally closed 	Operation mode of the channel
Time for staircase [s]	0...65535 sec [120 sec]	Duration of the switching process
Prewarning	<ul style="list-style-type: none"> ▪ not active ▪ active 	Activates the prewarning function
Warning time [s]	0...65535 sec [120 sec]	Duration of the warning; Only available when warning is activated
Prewarning time [s]	0...65535 sec [120 sec]	Adjustment, how long the light shall be switched on after the warning; Whole duration of the warning process is the sum of the 3 times: Staircase time, warning and prewarning Only available when warning is activated
Manual switching off	<ul style="list-style-type: none"> ▪ not active ▪ active 	Activation of the manual turn off of the staircase
Extend staircase time	<ul style="list-style-type: none"> ▪ not active ▪ active 	Activation of the extension of the staircase
Central function	<ul style="list-style-type: none"> ▪ not active ▪ active 	Activates the central function for this channel
Behavior when locked	<ul style="list-style-type: none"> ▪ Off ▪ On ▪ no change 	Action for activating the blocking process
Behavior when unlocked	<ul style="list-style-type: none"> ▪ Off ▪ On ▪ no change 	Action for deactivating the blocking process

Table 62: Parameter staircase

5.4.2 Staircase time

The following illustration shows the setting options at the ETS-Software:

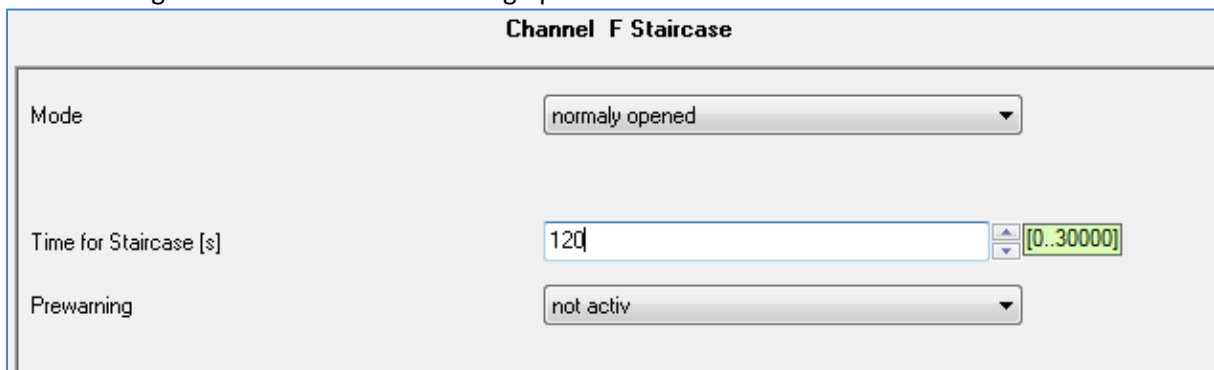

Figure 34: Staircase time

The staircase function is activated by choosing a channel as staircase. This function enables an automatic turn off of the channel after an adjusted time, called “time for staircase”. The time for staircase can be parameterized freely. By sending an “on-signal” at the communication object, the channel is switched on and the time runs out. After the time is ran out, the channel is switched off automatically. There are a lot of further functions to adjust the staircase function. These functions are described at the following segments.

The following chart shows the relevant communication object:

Number	Name	Length	Usage
86	Staircase	1 Bit	Calling of the staircase function

Table 63: Communication object staircase

5.4.3 Prewarning und Warning

The following illustration shows the setting options at the ETS-Software:

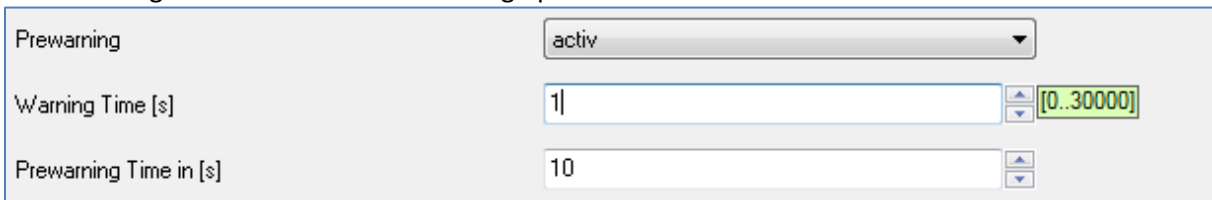
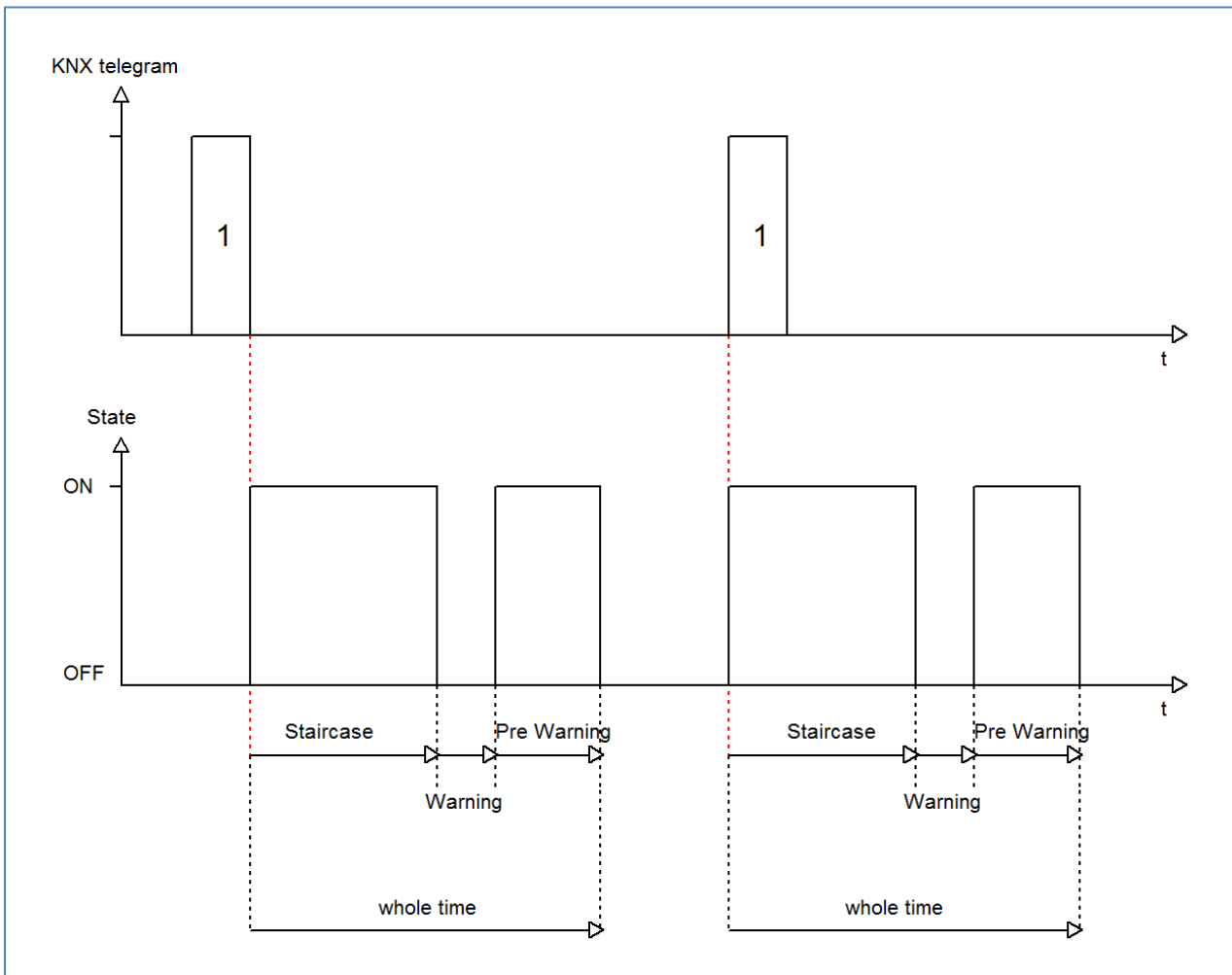

Figure 35: Warning timer & prewarning time

The warning function can be activated by adjusting the parameter “Prewarning” as active. Now, you can adjust warning time and prewarning time.

The warning function is for warning that the staircase time ran almost out and the lights are switched off soon. This warning happens through a short turn off the lights. The duration of the turn off is indicated by the warning time. A value of 1-3s is advisable for this parameter. When the warning time runs out, the lights will be switched on again for the adjusted prewarning time. Now you have the opportunities to extend the staircase time, when this parameter was activated, or leave the staircase. A dynamic programming is advisable for this time. So you can adapt this time to spatial conditions (next switch, length of the staircase, etc.).

The whole duration of the switching process is the sum of the 3 times. The following diagram shall make this clear:



5.4.4 Manual switch off

The following illustration shows the setting options at the ETS-Software:

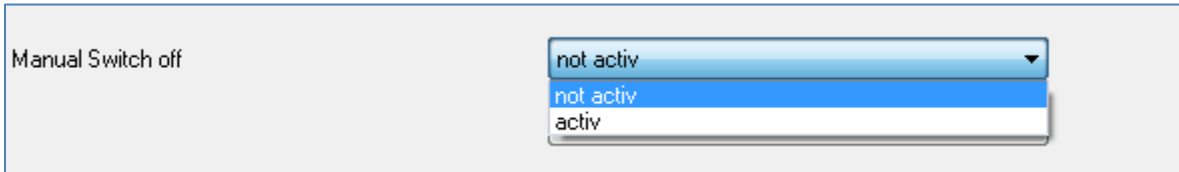

Figure 36: Manual switch off

By activation this function, you can switch the channel off before the staircase time runs out. For switching off the channel, you have to send a logical “0” to the communication object for switching the staircase function (have a look at Table 63: Communication object staircase). When this function is not activated, the channel switches only off after the staircase time runs out.

5.4.5 Extend staircase time

The following illustration shows the setting options at the ETS-Software:

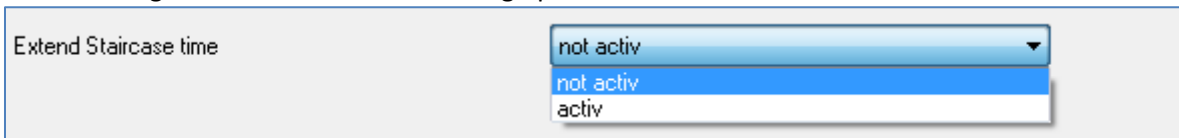
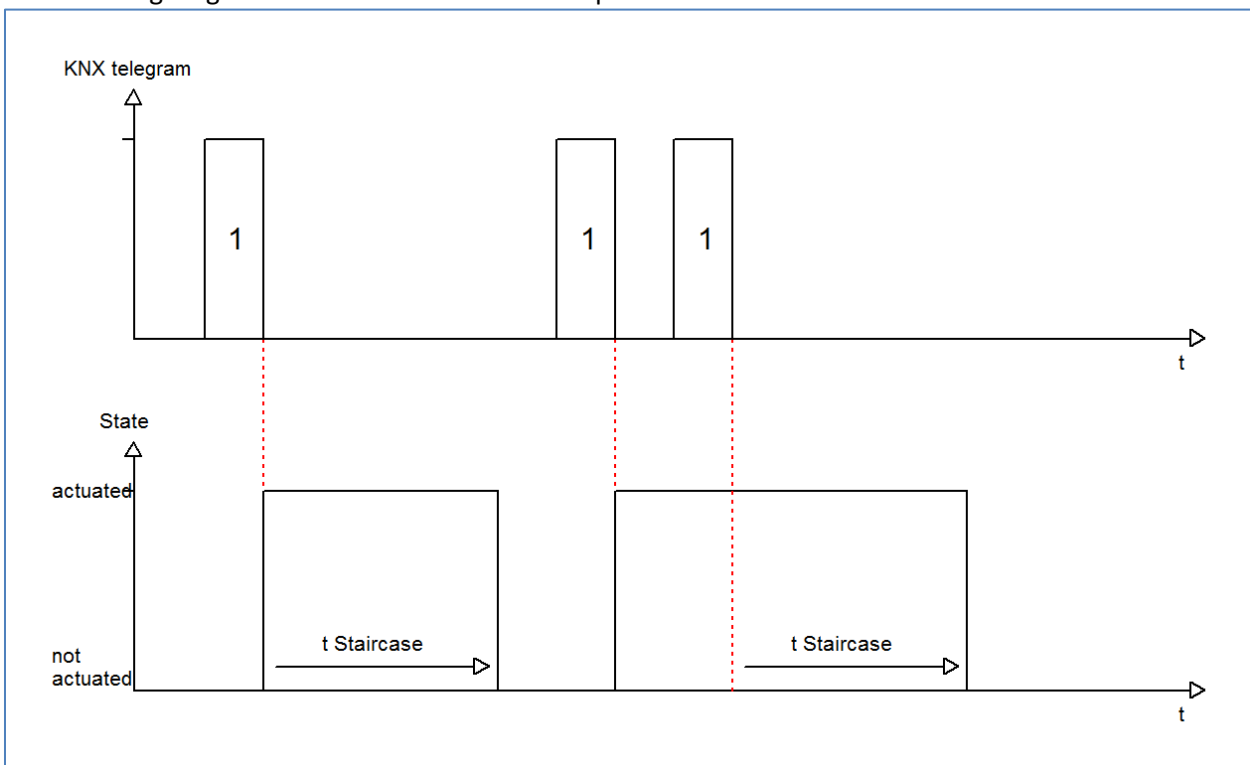

Figure 37: Extend staircase time

By activating this function, the staircase time is retriggerable. That means, when the staircase time runs already out to 2/3, you can restart the time by sending a new on-signal to the communication object of the staircase function (have a look at Table 63: Communication object staircase).

The following diagram shows the behavior of this parameter:



6 Reference ETS-Parameter – Shutter output

Attention:

After every transmission of a new parameterization you have to move the Shutter/Blinds once completely down and up, thereby the Shutter actuator knows his actual Reference values (see also 6.3.1 Driving to reference).

6.1 Channel Selection

Every pair of channels can be selected as switch, staircase or shutter, blinds at the submenu outputs. If the pair of channels is selected as shutter, blinds, the pair of channels can be parameterized as shutter or blinds:

Channel A / B	Switch, Staircase lighting
Function Channel A	Switch output
Function Channel B	Staircase lighting
Channel C / D	Shutter, Blinds
Function Channel C / D	Blinds
Objects for automatic position	not active

Figure 38: Channel selection

Further more the activation of the automatic objects can be done in this menu. The automatic objects are needed for the automatic function, which is described at 6.6 Automatic function.

6.1.1 Shutter

If a channel is selected as shutter the user has a wide range of opportunities to parameterize the channel. These one are expounded at the following segments.

As soon as the channel is selected as shutters standardly three communications objects appear.

The following chart shows these objects:

Number	Name	Length	Usage
85	Shutter up/down	1 Bit	Movement of the shutter
86	Blinds up/down/stop	1 Bit	Adjustment of the blinds/ Stopping of the shutter movement

Table 64: Communication objects shutter

The communication object “Shutter up/down” is used to move the shutter. Thereby is to consider that a logical “0” starts the up-movement and a logical “1” starts the down-movement. This configuration is standardly defined by KNX and controls an identical communication between KNX devices.

The communication object “Blinds up/down/stop” is used to adjust the blinds. By calling this object the current movement of the shutter is simultaneous stopped.

6.1.2 Blinds

There are also a wide range of opportunities to parameterize the channel at blind function. The shutter function and the blind function are almost identical, but there are no options to parameterize or move the blinds at the blind function.

As soon as the channel is selected as shutters appears standardly three communications objects.

The following chart shows these objects:

Number	Name	Length	Usage
85	Shutter up/down	1 Bit	Movement of the shutter
86	Short time operation	1 Bit	starts the short time operation
87	Stop	1 Bit	Stopping the shutter movement

Table 65: Communication objects blinds

The communication object “shutter up/down” is used to move the shutter. Thereby is to consider that a logical “0” starts the up-movement and a logical “1” starts the down-movement.

The communication object “Stop” is used to stop the current movement of the shutters. The object stop can be called by a logical “0” or “1”.

6.2 Time for movement

By setting different times for movement the user is able to parameterize the Actuator individually for almost every shutter/blind. To be sure that the movement function shutter works properly, you have to parameterize these times carefully. If the channel is selected as shutter there are additional settings for the moving time of the blinds.

You can see the screen for setting these times in the following illustration:

Channel B: Shutter

Time for movement for Up/Down (sec)	same
Time for movement (sec)	10
Extension of time for movement	10%
Step time for blinds (ms)	1000
Duration of blinds adjustment (ms)	5000
Pause at change of direction (ms)	1000
Switch-on delay motor (ms)	0
Switch-off delay motor (ms)	0
Position of blinds at end of driving	100%

Figure 39: Time for movement Shutter

Channel B: Blinds

Time for movement for Up/Down (sec)	same
Time for movement (sec)	10
Extension of time for movement	20%
Short time operation	not activ
Pause at change of direction (ms)	100
Switch-on delay motor (ms)	0
Switch-off delay motor (ms)	0

Figure 40: Time for movement Blinds

In the following chart, you can see the setting range for the movement times:

ETS-text	Dynamic range [default value]	comment
Time for movement up/down	<ul style="list-style-type: none"> ▪ same ▪ different 	Adjustment, whether up-and down-movement should be different or not
Time for movement Time for movement up/down	1-10000sec [45sec]	sets the duration for an up-/down-movement
Extension of time for movement	no extension, 2%, 5%, 10% , 15%, 20%	The extension of movement is for the definitely driving to the end stop and has no effects to the calculation of the absolute positions.
Step time for slats	50-1000ms [200ms]	only at shutter Duration for a step at the adjustment of blinds
Duration of slat adjustment	10-10000ms [1200ms]	only at shutter Duration for the whole adjustment of blinds (0-100%)
Pause at change of direction	1-1000ms [500ms]	sets the pause time between an up-and down movement
Switch-on delay motor	0-255ms [0ms]	switch-on delay for motors, which have not the whole power at the beginning
Switch-off delay motor	0-255ms [0ms]	switch-off delay for motors, which have time lag after set off
Position of blinds at end of driving	0-100% [50%]	only at shutter sets the position of blinds after driving the shutter
Short time operation	<ul style="list-style-type: none"> ▪ not active ▪ active 	only at blinds sets the short time operation on/off
Time for movement for short time operation	50-1000ms [200ms]	only at blinds adjusts the time for one short time operation

Table 66: Dynamic range time for movement

The functions are described in detail at the following segments.

6.2.1 Measurement of times for Movement

The individual times for the movement of shutter/blinds can normally determined very precise by using a stop watch.

If there are very short times for the movement, the measuring by using a watch will maybe cause problems. In this case it is advisable to adjust initially an approximated value, which should be a little bit shorter than the real time for movement. Afterwards you can test the adjusted time by triggering the shutters or blinds and control whether the final positions are achieved. If they are not achieved, you should set the time for movement gradually higher by using small steps until the final positions are achieved.

6.2.2 Movement time

The movement time describes the time which the shutter actuator needs to drive the shutter/blinds from one final position to the other. When the adjusted time is over the channel is set off even when the final position was not achieved. So the shutter actuator triggers the down-movement/ up-movement for the adjusted time.

Because shutters and blinds have often different times for the up down movement, different times can be adjusted for the up and down movement (from hardware version 2.2).

The extension of time for movement (from hardware version 2.2) guarantees the definitely driving to the end stops. This function has no effects to the calculation of the absolute positions. So you should always adjust the precise time for the movement time and activate the extension for the guaranteed driving to the end stops.

Check if the manufactory gives any data for the movement times.

6.2.3 Step time for blinds

→ only at blinds

You can adjust in which steps the blinds shall be shifted with the setting “step time for blinds”. The opening angle can adjust thereby in small steps to prevent e.g. a glare of the sun after a changing of the solar altitude or tighten sunblinds.

Additional, it is possible to adjust the step range in a way so that the blinds drive from one final position to the other in a specific number of steps. For this way of blind-movement, you have to set the step time for blinds to a multiple of the “duration of blinds adjustment”. Thereby the multiple of the duration time specifies the number of steps, which are required to drive the blinds from one final position to the other.

For Example: Duration of blind adjustment: 3000ms

Step time for blinds = 300ms

→ Number of steps=10 → therefore the values 0%, 10%, ..., 100% can be appointed

6.2.4 Duration of blind adjustment

→ only at blinds

The duration of blind adjustment sets the interval, which is required to drive the blinds from 0% to 100% or backwards. Therefore the shutter actuator triggers the blind adjustment.

Tip for the measurement from very small durations of blind adjustment

- Drive the blinds in a final position (either 100% closed or 100% opened)
- Now send step commands until the other final position is achieved
- Multiply the number of steps with the adjusted time for the step time of blinds
- Enter the result to the “duration of blind adjustment”

It is advisable to use the procedure, like under 6.2.1 Measurement of times for Movement described, by long blind adjustment times.

6.2.5 Pause at change of direction

The pause at change of direction is for the protection of the shutter motor, if the shutter actuator receives simultaneously commands for the up- and down-movement. A direct shift from the one to the other direction can contract the duration of the motor significantly and even by some motors a total damage is caused.

If the shutter actuator receives during a running movement a command for a movement to the other direction, the shutter actuator will switch off the movement. Before the shutter actuator switches the movement to the other direction on, the actuator stops for the adjusted time for the pause at change of direction.

The pause at change of direction counts as well for the change of direction of the up-/down-movement as for the blind adjustment.



Too short adjusted pause at change of direction can cause damages of the motor!
Notice the manufacturer's data at the datasheet of the drive absolutely.

6.2.6 Switch-on/Switch-off delay motor

Some motors can not bring the full power at the moment of switching it on, but first after some milliseconds. The time, which the motor needs to get the full power, can be balanced with the adjustment of the switch-on delay of the motor.

On the other hand there are motors, which run after it was switched off. This characteristic can be balanced by using the setting switch-off delay motor.

6.2.7 Position of blinds at end of driving

→only at blinds

By using the adjustment "position of blinds at end of driving" can be adjusted in which position the blinds shall be set after a down- or an up-movement. The shutter actuator drives automatically to this position after the end of a blind-movement. The position of blinds at end of driving can be set percentage in 1% steps, from 0% to 100%, whereby 0% full opened and 100% full closed correspond.

6.2.8 Short time operation

→only at blinds

The short time operation helps you to drive the blinds to a certain position, e.g. for sun protection. With small steps, the blinds can be driven to every possible position. It is often useful to set the short time operation as a multiple of the movement time. So the blinds can be driven from the bottom to the top, or the other way around, in a certain number of steps.

6.3 Objects for absolute position/ Status objects

Through activating the objects for absolute position it is possible to drive to absolute positions for movement and blind positions.

The following illustration shows the possible settings:

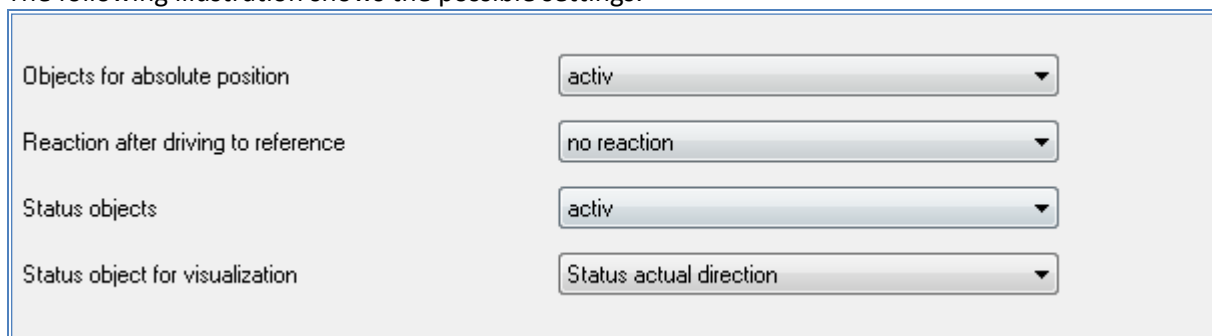

Figure 41: Objects absolute position

The following chart shows the setting range for this parameter:

ETS-text	Dynamic range [default value]	comment
Objects for absolute position	<ul style="list-style-type: none"> ▪ not active ▪ active 	activate/deactivate the objects for absolute position
Reaction after driving to reference	<ul style="list-style-type: none"> ▪ no reaction ▪ drive to former position 	gets only displayed if the objects are activated; sets the reaction after a driving to reference
Status objects	<ul style="list-style-type: none"> ▪ not active ▪ active 	enables the status objects
Status object for visualization	<ul style="list-style-type: none"> ▪ Status actual direction ▪ Status of movement 	adjusts the status object for the visualization

Table 67: Setting range absolute position

When the objects for the absolute position are activated, the following objects are displayed:

Number	Name	Length	Usage
89	Status actual direction	1 Bit	indicates the actual direction of the way of driving
89	Status of movement	1 Bit	indicates an active driving process
90	absolute position	1 Byte	utilized for driving the shutter/blinds to a specific value
91	absolute position of slats	1 Byte	for adjustment of the blinds to a specific value (only at shutter)
92	Status actual position	1 Byte	indicates the actual shutter-/blinds position
93	Status act. position of slats	1 Byte	indicates the actual position of the blinds (only at shutter)
94	act. position valid	1 Bit	indicates whether a driving to reference was already conducted

95	start driving to reference	1 Bit	starts the driving to reference
97	state upper position	1 Bit	notify achievement of the upper end position
98	state lower position	1 Bit	notify achievement of the lower end position

Table 68: Communication objects absolute position

The usage/function of this communication objects are explained at the following segments.

6.3.1 Driving to reference

The shutter actuator calculates its actual positions from the appointed times for movement. The real times for movement can be corrupted through outside influences after some time.

A driving to reference calculates the appointed time for movements anew and specifies in this way the shutter actuator new times for movement. Based on these new times for movement the shutter actuator can calculate the real position of the shutter/blinds more detailed.

The driving to reference is especially useful if someone works very often with commands for absolute positions. Therefore the shutter actuator can calculate the entered position more detailed and drive to this position more precise. Every drive to the lowest or highest position replaces a driving to reference. So the driving to reference should be done, when the shutter/blinds is only driven with absolute commands lower than 100% and more than 0%. In this case, a reference drive should be done regularly, e.g. one's a week.

The reference run is started through an 1-signal on its 1 bit communication object "start driving to reference". It is possible to adjust the reaction after the driving to reference by the parameter "reaction after driving to reference". The shutter actuator can drive to the position, which it had before the reference run, by the setting "drive to former position". Through the setting "no reaction" the shutter actuator lets the shutter/blinds at the position, which was reached after the end of the reference run.

After every transfer of a new parameterization you have to conduct a reference run. This can either manual occurred, that means the upper and lower position are approached ones, or by the object "start driving to reference". Now the reference run was conducted and the shutter actuator knows its actual state along the driving range.

6.3.2 Commands for absolute positions

By the objects for absolute positions you can specify a constant value to the shutter actuator, on which the shutter shall be driven. This value is indicated in percent and has a range from 0-100% with every 1% step between it. From the indicated percent value the shutter actuator calculates at the next step the real time for the movement of the shutter/blinds based on the appointed times for movement and the actual position.

The commands for the absolute position are transmitted to the 1 byte communication objects. There is an object for the absolute height positions of the driving way at shutter and blinds. Additional there is an object for the opening angle of the blinds at shutters, the object "absolute position of slats".

At the percentage description corresponds 0% always fully opened and 100% full closed.

6.3.3 Status objects (actual position/direction)

The status objects "Status actual position" and "Status act. position of blinds" conduce the visualization of the absolute position. Both objects indicate the actual state of the height and the opening angle of the blinds, respectively after end of driving. The objects can be used e.g. for Visualization.

6.3.4 Report objects

The 1 bit objects „state lower position“ and „state upper position“ will conduct respectively an 1-signal, if the lower end position or the upper end position is achieved. The signal of the object changes from 1 to 0, when the end position is left. Both objects are useful for the observation of the shutter/blinds.

6.3.5 Status objects for Visualization

The 1 bit status object “Status of movement” shows, that a movement of these shutters/blinds is active right now. A running movement is indicated by a logical “1”.

The 1 bit object “Status act. direction” conducts with a logical 0 a running up driving and with a logical 1 a running down driving. The state is respectively displayed, when a movement starts. The state exists intern as long as a new command for driving is sent. The 1 bit object “act. Position valid” will conduct, if a reference run was started after a new programming. This object can be used through a visualization to indicate that there is still a reference run necessary.

6.4 Drive to absolute position via 1 Bit

The following figure shows the available settings for the position start up via 1 Bit:

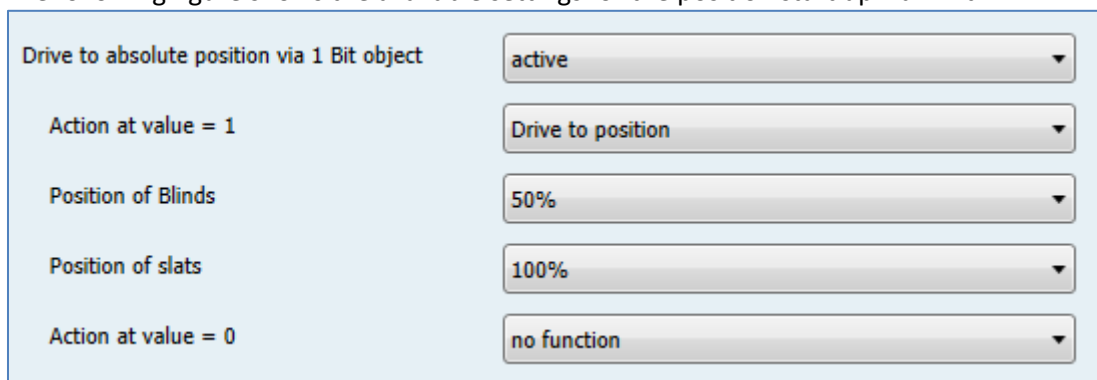

Drive to absolute position via 1 Bit object: active

Action at value = 1: Drive to position

Position of Blinds: 50%

Position of slats: 100%

Action at value = 0: no function

Figure 42: Position start up via 1Bit object

The following chart shows the dynamic range for this parameter:

ETS-text	Dynamic range [default value]	comment
Function object number 24	Position start up via 1Bit object	selected function for object number 24
Action at value = 1	<ul style="list-style-type: none"> ▪ Drive to position ▪ Drive to position if blind/shutter is up ▪ Drive to position if blind/shutter is down 	Function for sending a logical 1
Position of blinds/shutter/slats	0-100% [50%]	Position, which shall be activated at sending a logical 1
Action at value = 0	<ul style="list-style-type: none"> ▪ no function ▪ move up ▪ move down 	Action at the deactivation of the position start up, via logical 0

Table 69: Position start up via 1Bit object

The function position start up via 1 Bit object enables driving to absolute positions via 1 Bit object. On this, additional conditions can be parameterized when the channel shall drive to the adjusted functions. Compared to the automatic function, this function is only valid for one single channel. So this function can be parameterized individually for every channel.

The parameter “Action at value = 1” defines whether the position start up shall occur in every position or only at the end positions.

Furthermore, it can be selected via the “Action at value 0” what shall be happen at the deactivation of the position start up. The channel can drive to one of the both end positions or stay in its last position.

The “Action at value =0” will only be done, if the current position is still the same as the adjusted one. If the shutter/blinds are driven to another position before sending a logical 0, the channel will not drive.

The field of application for this function are widespread. Two examples are given at the following segments:

- **Moving up the blinds for air ventilation at opened/tilted window:**
As soon as the window contact detects an opened window, the blinds shall be moved up to the value of 90%. Of course this function shall only be administrated if the blinds are in the bottom end stop. So you choose at the parameter “Action at value = 0” the setting “Drive to position if position is down”. When the window is closed again, the blinds shall drive again to the bottom end position. So you choose at “Action at value = 0” the setting “move down”.
- **The shading shall only drive if the blinds are up:**
If the blinds are stilled closed in a room, e.g. the bedroom, or already manually driven to certain shading position and shall not drive to the adjusted shading position, the position start up via 1 Bit object can fix this problem. The parameter “Action at value = 1” must be selected as “Drive to position if blinds are up”. The deactivation can be selected as “move up”. To note is, that this function will only be done if the blinds are not moved to another position before.

6.5 Scenes

If functions of different crafts (e.g. light, shutter, heater) shall be controlled with only one keystroke or command, it will be useful to use the scene-function. By calling this scene, you are able to set the lights in a room to specific value or dim them, drive the shutter to a specific value and rotate the blinds, the control of the heater can be set to day operation and switch on the power supply of the sockets. The telegrams of this function can have different formats as well as different values with various meaning (e.g. "0" for lights off and open shutters). Without the scene function you have to send every actor a separate signal to get the same setting.

By using the scene function of the shutter actor you can integrate the channels to a scene control. In order to do this you have to allocate the respective memory (scene (A-H) a value. There are up to 8 scenes for every channel possible. If the scene function is activated for this channel the according scene menu is shown. At this menu the single scenes can be activated and values, scene numbers and the memory function on/off can be set.

Scenes get activated by reception of their scene number at the according scene object. If the memory function is activated at the scene, the saving will follow with the actual values of the channels. The communication objects have always the size of 1 Byte.

The following illustration shows the possible settings at the ETS-Software to activate the scenes:

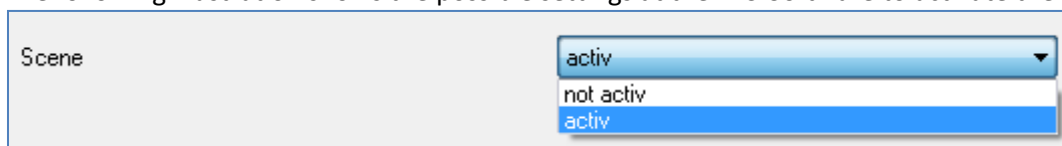

Figure 43: Scene function

Number	Name	Length	Usage
16	Scene	1 Byte	Call of the respectively scene

Table 70: Communication object scene

To call a specific scene, you have to send the value of the respectively scene to the communication object for the scene function. The value, to call the scene, is thereby always one number less than the adjusted scene number. If you for example want to call scene number 1, you have to send a 0. Consequently the scene number can have the values from 1 to 64, but the values to call a scene only from 0 to 63.

If you activate the call of a scene at a binary input, you have to set the same scene numbers at your binary input and at your shutter actor. The binary input sends automatically the right value to call the scene.

6.5.1 Submenu scene

Every channel has 8 opportunities to save scenes. This 8 memory cells have the names A-H. Every of the 8 scenes can get one of the possible 64 scene numbers. The following illustration shows the setting options at the sub item scene (channel X: scene) for the scenes A-D and a channel, which was selected as shutter (scenes E-H are the same as the first four):

Channel A: Scene	
Save scenes	not activ not activ activ
Scene A - Position	50%
Scene A -position of blinds	75%
Scene Number A	1
Scene B - Position	100%
Scene B -position of blinds	0%
Scene Number B	13
Scene C - Position	25%
Scene C -position of blinds	60%
Scene Number C	44
Scene D - Position	24%
Scene D -position of blinds	28%
Scene Number D	4

Figure 44: Submenu scene

The subitem for blinds is almost the same like the one for a shutter channel, but the setting options for position of blinds are dropped out.

The following chart shows the dynamic range for the scenes:

ETS-text	Dynamic range [default value]	comment
Save scenes	<ul style="list-style-type: none"> ▪ not active ▪ active 	activates/deactivates the memory function for scenes
Scene A - position	0-100% [0%]	Adjustment for absolute positions when calling the scenes
Scene A – position of blinds	0-100% [0%]	Adjustment for absolute blind positions when calling the scene (only at channels, which are chosen as shutter)
Scene number A	1-64 [1]	Scene number; pick-up value = one number less than the scene number (default values increase by every alphabetic increment, B=2; C=3,...)

Table 71: Dynamic range scenes

If a scene is activated in a channel, a subitem scene for this channel will appear. At this subitem the channel can be allocated a reaction for the call of this scene. This reaction contains a command for an absolute height (0-100%) for this channel or additional an absolute position of blinds at a shutter channel (see also Chart 17). Every channel can react to eight different scenes. By sending the according pick-up value for the scene, the scene is called and assumes its parameterized conditions. During this process the channel regards also its individual parameterization. If the channel shall for example drive to 0% by calling the scene and still drives down at 70%, the pause at change of direction will be observed before the channel starts driving up to 0%.

You have to observe at the programming, that if two or more channels shall refer to the same scene numbers, the communication objects are hosted in the same group address. By sending the pick-up value for the scene, all channels with the according scene number respond. It is useful to divide your group addresses after scenes to make the programming more clearly. That means if a channel shall react to eight different scenes, the communication object is also integrated in eight different group addresses.

For calling a scene or saving a new value for the scene, you have to send the accordingly code to the relevant communication object for the scene:

Scene	Retrieve		Save	
	Hex.	Dez.	Hex.	Dez.
1	0x00	0	0x80	128
2	0x01	1	0x81	129
3	0x02	2	0x82	130
4	0x03	3	0x83	131
5	0x04	4	0x84	132
6	0x05	5	0x85	133
7	0x06	6	0x86	134
8	0x07	7	0x87	135
9	0x08	8	0x88	136
10	0x09	9	0x89	137
11	0x0A	10	0x8A	138
12	0x0B	11	0x8B	139
13	0x0C	12	0x8C	140
14	0x0D	13	0x8D	141
15	0x0E	14	0x8E	142
16	0x0F	15	0x8F	143
17	0x10	16	0x90	144
18	0x11	17	0x91	145
19	0x12	18	0x92	146
20	0x13	19	0x93	147
21	0x14	20	0x94	148
22	0x15	21	0x95	149
23	0x16	22	0x96	150
24	0x17	23	0x97	151
25	0x18	24	0x98	152
26	0x19	25	0x99	153
27	0x1A	26	0x9A	154
28	0x1B	27	0x9B	155
29	0x1C	28	0x9C	156
30	0x1D	29	0x9D	157
31	0x1E	30	0x9E	158
32	0x1F	31	0x9F	159

Table 72: Calling and saving scenes

6.6 Automatic function

You can activate an automatic function for every channel. Through the automatic function, you can call up to 4 different conditions. The automatic function is divided into two different blocks (A and B). It is also possible to call several moves to the same time through the automatic function, for example drive the blinds as well as the shutter and change the opening angle of the blinds.

The following illustration shows the activation of the automatic function for a channel:

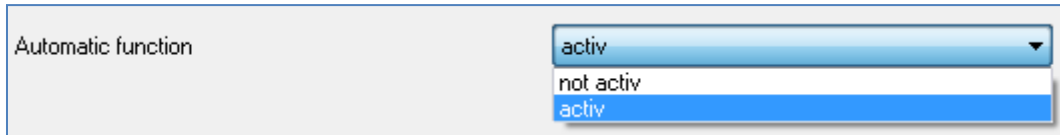

Figure 45: Automatic function

If the automatic function is activated for a channel, at the left drop down menu a new subitem (channel X: Automatic) will appear to parameterize the automatic function for this channel.

6.6.1 Submenu automatic function

The following illustration shows the setting options for an automatic function at the subitem channel X: automatic:

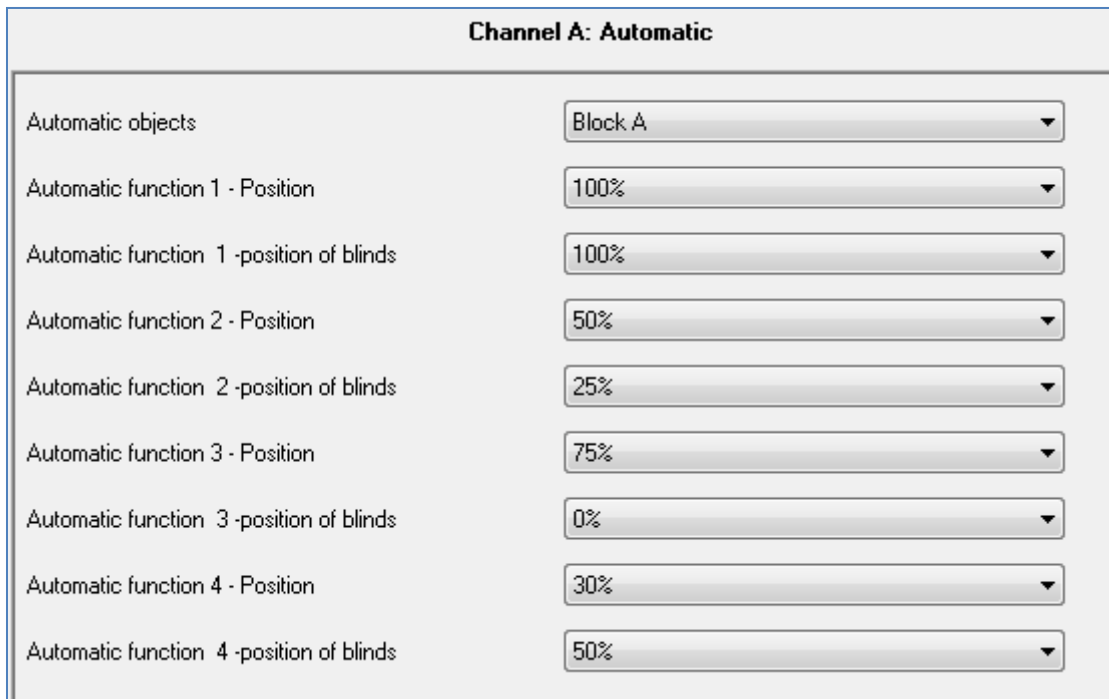

Figure 46: Submenu automatic function

The following chart shows the dynamic range for the first automatic function. There are 4 different automatic functions for every channel. The dynamic range of the automatic functions 2,3 and 4 are the same as the first.

ETS-text	Dynamic range [default value]	comment
Automatic function 1(-4) – Position	0-100% [0%]	height position for the first automatic function
Automatic function 1(-4) – position of blinds	0-100% [0%]	position of blinds for the first automatic function(only at shutters)

Table 73: Dynamic range automatic function

At the subitem for the automatic function, you can depose values for 4 different automatic calls. The values are absolute values, which the channel accepts at the call of the according automatic function. Additional you can determine for every channel to which automatic block the channel shall refer. Here are the blocks A and B disposal. The activation of the blocks is described below.

Additional an option for the automatic function can be parameterized:

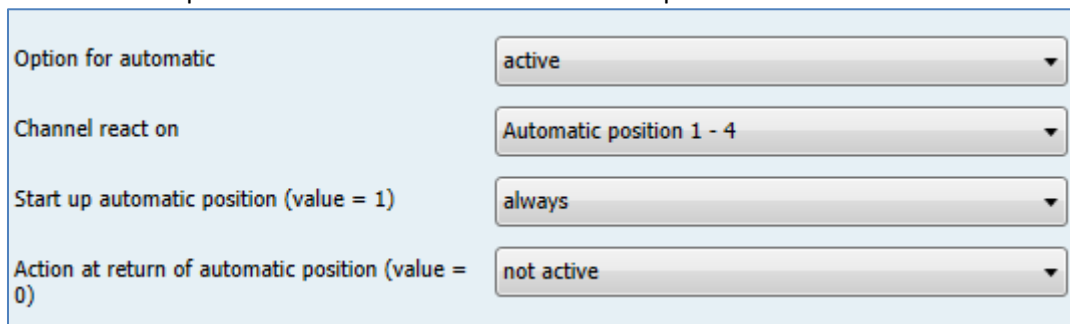

Figure 47: Option for automatic

At the “option for automatic” the area of validity of the automatic function for one channel can be restricted. So e.g. the channel B can react only to one certain position or perform the call of an automatic function only if the shutter/blinds are in an end position. Furthermore a moving command can be parameterized for the deactivation of the automatic function. But this moving command is only performed if the channel is still in the called position. For proofing this, an internal alignment between the current position and the called position is done before moving the channel. So it is ensured that the action at return of the automatic function is only performed if the shutter/blinds are not driven manually to any certain value.

The following settings are available for the automatic position:

ETS-text	Dynamic range [default value]	comment
Option for automatic	<ul style="list-style-type: none"> ▪ not active ▪ active 	Activation of the automatic option
Channel react on	<ul style="list-style-type: none"> ▪ Automatic position 1-4 ▪ Automatic position 1 ▪ Automatic position 2 ▪ Automatic position 3 ▪ Automatic position 4 	Adjustment which automatic positions shall be performed of the channel
Startup automatic position (value = 1)	<ul style="list-style-type: none"> ▪ ever ▪ if position = UP ▪ if position = DOWN 	Adjustment if the automatic position shall only be performed in an end position
Action at reset of automatic position (value=1)	<ul style="list-style-type: none"> ▪ not active ▪ move up ▪ move down 	Adjustment, which action the channel shall perform at the reset of the automatic function

Table 74: Option for automatic

Individual shading and air ventilation projects can be realized by the option for the automatic function.

The communication objects are shown at the following chart:

Number	Name	Length	Usage	Number
125	automatic	automatic position 1	1 Bit	Call of the first automatic position at block A
126	automatic	automatic position 2	1 Bit	Call of the second automatic position at block A
127	automatic	automatic position 3	1 Bit	Call of the first automatic position at block B
128	automatic	automatic position 4	1 Bit	Call of the second automatic position at block B

Table 75: Communication objects automatic function

The communication objects, with the size of 1 Bit, can be allocated arbitrary to the group addresses. By calling one of the communication objects, the deposited values for the automatic function are called. It is possible to move all channels of one shutter actuator to their parameterized values with only one command, but also to move only one channel. This happens in according to the parameterization, which was made for the individual channel at the subitem automatic function. To move more channels to the same time to a specific value, you have to choose the same blocks for these channels and set the same values for this automatic positions.

6.7 Alarm functions/ superior functions

The shutter actuator can react to specific weather situations and introduce several reactions for this channel to protect the shutters/blinds by using the alarm function. Additional reactions on a bus power breakdown or a bus power return can be defined. The alarm functions can be activated or deactivated for every several channel.

The signals for the alarms can be recovered of a KNX weather station. Now the shutter actuator is able to evaluate these signals and assemble them according to the parameterization.

The following illustration shows the activation of the alert functions for a channel:

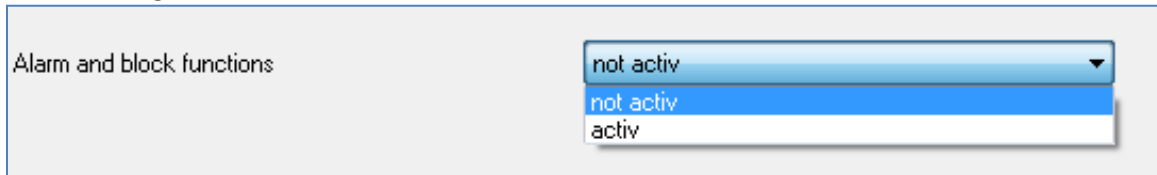

Figure 48: Alarm functions

If the alarm function is activated for a channel, at the left drop-down menu appears a subitem (channel X: Alarms), in which the following parameterization can ensue.

If the alarm function is activated, you can make the following parameterization at the appeared subitem.

The following illustration shows the drop-down menu for the alert function:

Channel A: Alarm and block functions	
Order of alarms	Wind, Rain, Frost, Block ▼
Action at reset of alarms / block	no action ▼
Action at blocking (value=1)	no action ▼
Extended block function	not activ ▼
Wind alarm	not activ ▼
Rain alarm	not activ ▼
Frost alarm	not activ ▼
Reaction when bus power down	no action ▼
Reaction when bus power up	no action ▼

Figure 49: Subitem alert function

The several parameters of the alert function, as well as the setting options, are described in detail at the following segments.

6.7.1 Order of alarms

The parameter “order of alarms” describes the priority of the several alarms. The following chart shows the setting options for this parameter:

ETS-text	Dynamic range [default value]	comment
Order of alarms	<ul style="list-style-type: none"> ▪ Wind, Rain, Frost, Block ▪ Wind, Rain, Block, Frost ▪ Wind, Block, Rain, Frost ▪ Block, Rain, Wind, Frost 	sets the priority of the alarms

Table 76: Order of alarms

If there are two or more alarms activate to the same time, the shutter actuator will evaluate the alarms according to the appointed order of alarms. The shutter actuator implements only the function of the alarm with the highest priority. The function for the alarm with the lower priority does not implement, as far the alarm with the higher priority is active. When the alarm with the higher priority is deactivated and the alarm with the lower priority is still active, the function for the alarm with the lower priority is activated afterwards.

6.7.2 Alarm types

Three different types of alarms can be activated (wind alarm, rain alarm, frost alarm), which can be set individually afterwards.

The following chart shows the dynamic range of the three types of alarms:

ETS-text	Dynamic range [default value]	comment
Wind alarm	<ul style="list-style-type: none"> ▪ not active ▪ active 	Activation of the wind alarm
<i>Cycle time (only when wind alarm is activated)</i>	<i>0-120 min [30min]</i>	<i>periodic observation of the wind alarm setting 0 deactivates the periodic observation</i>
<i>Action (only when wind alarm is activated)</i>	<ul style="list-style-type: none"> ▪ no action ▪ drive to top ▪ drive to bottom 	<i>Action when wind alarm gets active</i>
Rain alarm	<ul style="list-style-type: none"> ▪ not active ▪ active 	Activation of the wind alarm
<i>Cycle time (only when rain alarm is activated)</i>	<i>0-120 min [30min]</i>	<i>periodic observation of the rain alarm setting 0 deactivates the periodic observation</i>
<i>Action (only when rain alarm is activated)</i>	<ul style="list-style-type: none"> ▪ no action ▪ drive to top ▪ drive to bottom 	<i>Action when rain alarm gets active</i>
Frost alarm	<ul style="list-style-type: none"> ▪ not active ▪ active 	Activation of the wind alarm
<i>Cycle time (only when frost alarm is activated)</i>	<i>0-120 min [30min]</i>	<i>periodic observation of the frost alarm setting 0 deactivates the periodic observation</i>
<i>Action (only when frost alarm is activated)</i>	<ul style="list-style-type: none"> ▪ no action ▪ drive to top ▪ drive to bottom 	<i>Action when frost alarm gets active</i>

Table 77: Alarm types

If an alarm is activated the according communication object appears. If the according communication object receives an “1-signal”, the alarm function will be activated. By sending a “0-signal”, the alarm gets deactivated.

The following chart shows the according communication objects:

Number	Name	Length	Usage
101	Wind alarm	1 Bit	Activation/deactivation of the wind alarm
102	Rain alarm	1 Bit	Activation/deactivation of the rain alarm
103	Frost alarm	1 Bit	Activation/deactivation of the frost alarm

Table 78: Communication objects alarms

The function of the alarms is identical for every of the three alarm types. For every of the three alarms a periodic observation can be activated (have a look at 4.8.3). Furthermore an action for the release of each alarm can be set. Here, the user has 3 opportunities: On the one hand the shutter actuator can drive the channel to the top or to the bottom, when the alarm is activated. On the other hand the shutter actuator can react with the setting “no action”. At this setting, the channel stays in its actual position. A movement of this channel is not possible as long as the alarm is activated. Also after the reset of the alarms, the shutter actuator can perform predetermined functions. These are described at 4.8.5.

Please note, that the communication objects of the alarms shall always be connected to group addresses; otherwise there is no opportunity to receipt the alarms. If an alarm is activated because of its periodic observation, which is not connected to a group address, you will only be able to receipt it by using the ETS-Software!

6.7.3 Periodic observation

The periodic observation of the alarm function can be activated for every of the three alarms separately. The dynamic range extends from 0 to 120min, whereby the setting 0 min sets the periodic observation off.

The communication object for the respectively alarm must get a signal during the parameterized time, otherwise the alarm causes automatically. There are settings at KNX weather stations, in which clearances the periodic sending shall follow. The time for the periodic sending shall be always set less than the observation time to avoid an unwittingly cause of the alarm.

You can get sure that a weather sensor works properly, by using the periodic observation. If a signal is absent, because of a failure of the weather station or a wire break, the shutter actuator will trigger the alarm after the expiration of the observation time.

The following illustration shows the setting options for the periodic observation:

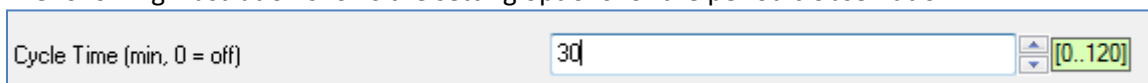

Table 79: Periodic observation

6.7.4 Normal blocking

The following chart shows the dynamic range for the activation of the blocking object:

ETS-text	Dynamic range [default value]	comment
Action at blocking (Value=1)	<ul style="list-style-type: none"> ▪ no action ▪ Drive to top ▪ Drive to bottom 	Adjustment for the activation of the blocking object of the channel

Table 80: Action at blocking

The shutter actuator can drive to predefined positions, top or bottom, at the activation of the blocking object or stay in its current position. At an activated block function, no driving of the channel is possible.

The following chart shows the relevant communication object:

Number	Name	Length	Usage
104	Block	1 Bit	Activation/Deactivation of the normal blocking function

Table 81: Communication object Block

6.7.5 Action at reset of alarms and blocks

For every channel an action at the reset of the alarm and all blocking functions can be parameterized. This parameter operates to all alarms and blocking functions of the selected channel. The dynamic range of this parameter is shown at the following chart:

ETS-text	Dynamic range [default value]	comment
Action at reset of alarms/block	<ul style="list-style-type: none"> ▪ no action ▪ drive to former position ▪ drive to top ▪ drive to bottom 	Adjustment for the repeal of the alarm and blocking functions

Table 82: Action at reset of alarms

The user has 4 different setting options for the parameter “Action at reset of the alarms/block”, which the shutter actuator can conduct for this channel.

By using the setting “no action” the channel stays in its position, which he had during the active alarm/block.

The setting “drive to former position” let the shutter actuator drive the channel to the position, which it had before the alarm/block was activated. If you chose “no action” for the action of an activated channel, this setting will have no effect to the position of this channel.

Furthermore the shutter actuator can drive the channel to the top or the bottom at the reset of an alarm/block.

The setting “Action at reset of alarms/block” is always valid for the complete channel, even if you have chosen three different settings for the three possible alarms and blocks.

6.8 Block functions

The extended block function can be activated for every channel by a separately subitem. When the extended block function was activated for a channel, a new subitem appears, under the according channel, called channel X: Extended block function at the drop down menu.

The following illustration shows the activation of the block function:

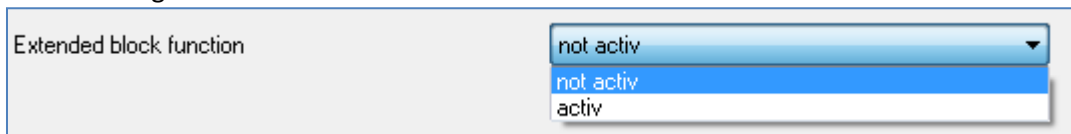

Figure 50: Activation block function

The following illustration shows the distribution at the submenu of the block function:

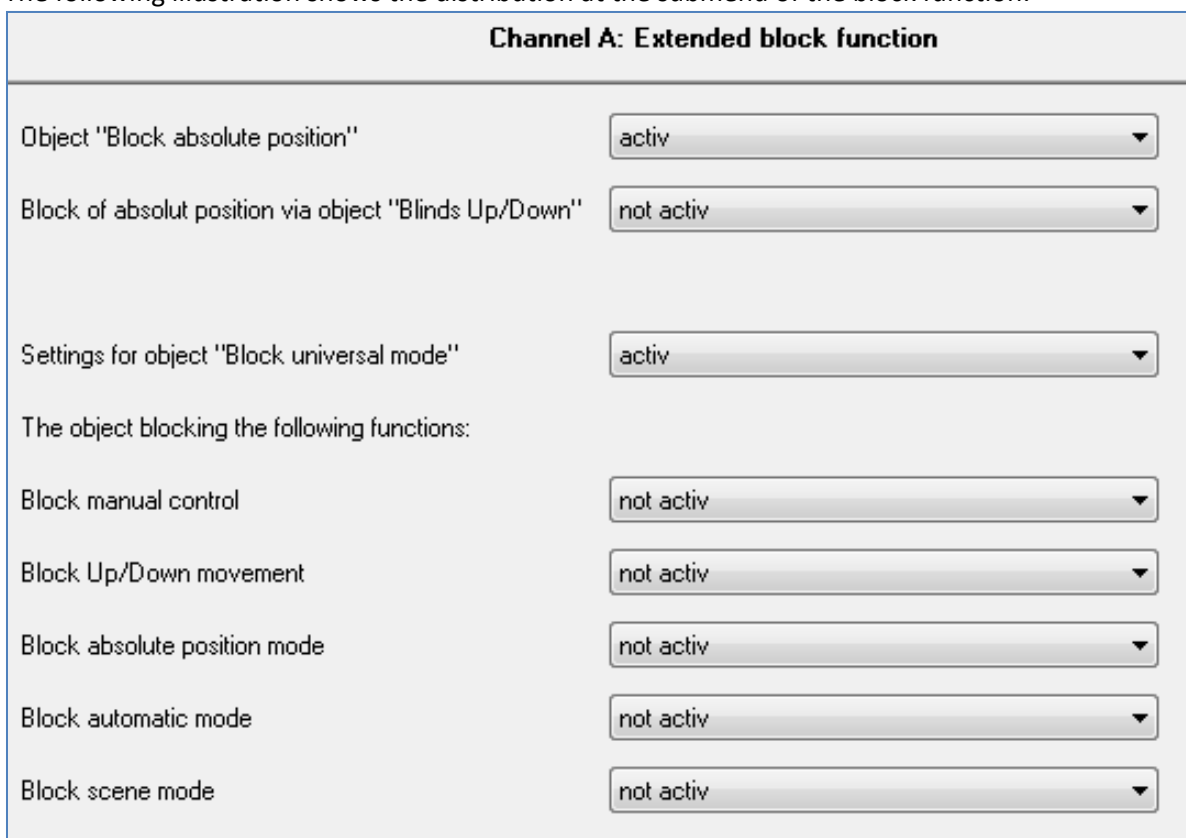

Figure 51: Block function

The following chart shows the dynamic range, which can be set at the submenu of the block function:

ETS-text	Dynamic range [default value]	comment
Action at blocking (Value=1)	<ul style="list-style-type: none"> ▪ no action ▪ drive to top ▪ drive to bottom 	Reaction to the activation of a blocking instance
Block of absolute position via Objects "Blinds Up/Down"	<ul style="list-style-type: none"> ▪ not active ▪ active 	activates the driving to absolute positions by manual driving
Settings for object "Block universal mode"	<ul style="list-style-type: none"> ▪ not active ▪ active 	activates the communication object and the setting options for the universal blocking mode
The object blocks the following functions:		
Block manual control	<ul style="list-style-type: none"> ▪ not active ▪ active 	with activation of the object "block universal mode" the manual control gets blocked
Block up/down movement	<ul style="list-style-type: none"> ▪ not active ▪ active 	with activation of the object "block universal mode" the up/down movement gets blocked
Block absolute position mode	<ul style="list-style-type: none"> ▪ not active ▪ active 	with activation of the object "block universal mode" the absolute position mode gets blocked
Block automatic mode	<ul style="list-style-type: none"> ▪ not active ▪ active 	with activation of the object "block universal mode" the automatic objects for this channel gets blocked
Block scene mode	<ul style="list-style-type: none"> ▪ not active ▪ active 	with activation of the object "block universal mode" the scen calling for this channel gets blocked

Table 83: Block functions

When the particular block functions are activated the according communication objects appears. The chart shows the according communication objects:

Number	Name	Length	Usage
99	block absolute position	1 Bit	blocks the object absolute position
100	block universal mode	1 Bit	blocks the channel according to the appointed parameterization

Table 84: Communication objects block function

It is possible to block the absolute position commands with the parameter “block absolute position”. By activation the according object the channel can no longer receive commands for an absolute height until the object is deactivated by a “0”. The sub function “Block of absolute position via Objects Blinds Up/Down” allows blocking the driving to absolute position as soon as manual driving is activated. This function has its areas of application when a weather station activates a sun protection, but the user wants to drive the shutter/blinds manual to any other value. By driving manual, the shutter actuator is blocked for receiving absolute positions for sun protection and can be driven normal.

It is possible to configure the blocking process on your own by using the parameter “Blocking universal mode”. Therefore 5 different options are available:

- Block manual control
 - blocks the manual control at the device for this channel
- Block up/down movement
 - blocks the driving commands of the channel (also the blind adjustment at shutters)
- Block absolute position mode
 - blocks the receiving of absolute position commands via the object “absolute position”
- Block automatic mode
 - blocks the automatic function for this channel, that means the call of the channel via the automatic function is blocked for this channel
- Block scene mode
 - blocks the scene mode for this channel, that means at a scene calling, in which the blocked channel is integrated, the channel is not called with and stays instead in its actual position

All blocking function can be activated by a logical “1” and deactivated by a logical “0”.

7 Index

7.1 Register of illustrations

Figure 1: Exemplary circuit diagram RF-GT08.01	6
Figure 2: Exemplary circuit diagram RF-GTT8.01	6
Figure 3: Overview hardware RF-GT04.01	7
Figure 4: General settings.....	30
Figure 5: Configuration of push buttons	31
Figure 6: Parameter dual surface dimming.....	34
Figure 7: Two button shutter function	36
Figure 8: Two button switching function	37
Figure 9: Parameter switch	38
Figure 10: Sub-function send status.....	42
Figure 11: Sub-function send value	44
Figure 12: Send value with on-delay	47
Figure 13: Parameter Scene	48
Figure 14: Parameter switch short/long	50
Figure 15: Parameter one-button dimming	53
Figure 16: Parameter one-surface shutter	54
Figure 17: Parameter Panic push button	55
Figure 18: Configuration of LED lights.....	56
Figure 19: Configuration LEDs per button.....	58
Figure 20: Parameter LED Priority.....	60
Figure 21: Activation logic functions	61
Figure 22: Setting logic.....	62
Figure 23: Room temperature sensor	64
Figure 24: Channel selection	66
Figure 25: Operating mode	67
Figure 26: Central function.....	68
Figure 27: Blocking function	68
Figure 28: Switching output	70
Figure 29: Logical functions.....	73
Figure 30: Scene function.....	74
Figure 31: Sub function scene	75
Figure 32: Programming of scenes.....	78
Figure 33: Staircase	79
Figure 34: Staircase time	81
Figure 35: Warning timer & prewarning time.....	82
Figure 36: Manual switch off.....	83
Figure 37: Extend staircase time	83
Figure 38: Channel selection	84
Figure 39: Time for movement Shutter.....	86
Figure 40: Time for movement Blinds	86
Figure 41: Objects absolute position.....	90

Figure 42: Position start up via 1Bit object	93
Figure 43: Scene function.....	95
Figure 44: Submenu scene	96
Figure 45: Automatic function.....	99
Figure 46: Submenu automatic function.....	99
Figure 47: Option for automatic.....	100
Figure 48: Automatic blocks	Fehler! Textmarke nicht definiert.
Figure 49: Alarm functions	102
Figure 50: Subitem alert function.....	103
Figure 51: Activation block function.....	108
Figure 52: Block function.....	108

7.2 List of tables

Table 1: Overview functions.....	10
Table 2: Communication objects general.....	14
Table 3: Communication objects per button	17
Table 4: Communication objects switching output.....	19
Table 5: Communication objects shutter output	26
Table 6: Communication objects - Default settings	29
Table 7: General settings.....	30
Table 8: Channel configuration	31
Table 9: Communication object blocking object	33
Table 10: Parameter Channels grouped.....	33
Table 11: Communication objects dual surface dimming	34
Table 12: Dimming function	35
Table 13: Communication objects two button shutter function.....	36
Table 14: Shutter function.....	36
Table 15: Communication object two button switching function.....	37
Table 16: Parameter switch by push/release.....	39
Table 17: Communication object switch by push/release	39
Table 18: Communication objects toggle by push/release	40
Table 19: Parameter Send status	42
Table 20: Communication object send status	42
Table 21: Parameter send value.....	44
Table 22: Parameter send value, 1 Byte object.....	44
Table 23: Communication object Parameter Send value-1 Byte object	44
Table 24: Dynamic range send value-forced setting.....	45
Table 25: Communication object Send value-forced setting	45
Table 26: Parameter Send value with delay.....	46
Table 27: Communication object send value with delay	47
Table 28: sub-function scene	48
Table 29: Communication object Parameter scene	48
Table 30: Calling and saving scenes.....	49
Table 31: Sub-functions parameter switch short/long	50
Table 32: Communication object parameter switch short/long.....	50
Table 33: Sub function Send value at switch short/long.....	52
Table 34: Sub function one-button dimming	53
Table 35: Communication objects one-button dimming	53
Table 36: Sub-functions one-surface shutter	54
Table 37: Communication objects one-surface dimming	54
Table 38: Parameter Panic button	55
Table 39: Configuration LED lights	57
Table 40: Parameter LED 1-4[8]	59
Table 41: Parameter LED priority	60
Table 42: Communication objects LED lights	61
Table 43: Common Parameter logic blocks.....	61
Table 44: Dynamic range logic.....	62
Table 45: Communication objects logic	62
Table 46: Logic sub-function switch	63

Table 47: Logic sub-function scene and value.....	63
Table 48: Parameter room temperature sensor	64
Table 49: Communication objects room temperature sensor	65
Table 50: Operating mode.....	67
Table 51: Central function	68
Table 52: Communication object central function.....	68
Table 53: Behavior at block/unblock.....	68
Table 54: Communication object blocking function.....	69
Table 55: Switching output.....	71
Table 56: On/Off delay	72
Table 57: Communication objects logic	73
Table 58: Logic operations	73
Table 59: Communication object scene	74
Table 60: Parameter scene.....	76
Table 61: Calling and saving scenes.....	77
Table 62: Parameter staircase	80
Table 63: Communication object staircase	81
Table 64: Communication objects shutter	85
Table 65: Communication objects blinds	85
Table 66: Dynamic range time for movement	87
Table 67: Setting range absolute position.....	90
Table 68: Communication objects absolute position.....	91
Table 69: Position start up via 1Bit object.....	93
Table 70: Communication object scene	95
Table 71: Dynamic range scenes	97
Table 72: Calling and saving scenes.....	98
Table 73: Dynamic range automatic function	100
Table 74: Option for automatic.....	101
Table 75: Communication objects automatic function	101
Table 76: Order of alarms.....	104
Table 77: Alarm types.....	105
Table 78: Communication objects alarms	105
Table 79: Periodic observation.....	106
Table 80: Action at blocking	106
Table 81: Communication object Block.....	106
Table 82: Action at reset of alarms	107
Table 83: Block functions	109
Table 84: Communication objects block function.....	109

8 Attachment

8.1 Statutory requirements

The above-described devices must not be used with devices, which serve directly or indirectly the purpose of human, health- or lifesaving. Further the devices must not be used if their usage can occur danger for humans, animals or material assets.

Do not let the packaging lying around careless, plastic foil/ -bags etc. can be a dangerous toy for kids.

8.2 Routine disposal

Do not throw the waste equipment in the household rubbish. The device contains electrical devices, which must be disposed as electronic scrap. The casing contains of recyclable synthetic material.

8.3 Assemblage



Risk for life of electrical power!

All activities on the device should only be done by an electrical specialist. The county specific regulations and the applicable EIB-directives have to be observed.

8.4 Datasheet