

Product documentation

KNX Blind- a.Heating-Act.FM w.3 Inputs
Art.-No. MEG6003-0006



Contents

1	Product definition	3
1.1	Product catalogue	3
1.2	Function	3
2	Installation, electrical connection and operation	4
2.1	Safety instructions	4
2.2	Device components	5
2.3	Fitting and electrical connection	6
2.4	Commissioning	10
2.5	Operation	13
3	Technical data	14
4	Software description	15
4.1	Software specification	15
4.2	Software "Venetian blind, valve, input 20BA11"	16
4.2.1	Scope of functions	16
4.2.2	Software information	18
4.2.3	Object table	19
4.2.3.1	Extension input objects	19
4.2.3.2	Venetian blind output objects	22
4.2.3.3	Valve output objects	27
4.2.4	Functional description	29
4.2.4.1	General functions for extension inputs	29
4.2.4.2	General functions for the outputs	31
4.2.4.3	Channel-orientated functions for extension inputs	32
4.2.4.3.1	Function configuration of the extension inputs	32
4.2.4.3.2	Disabling function for extension inputs	39
4.2.4.4	Channel-oriented functions for the Venetian blind output	40
4.2.4.4.1	General settings	40
4.2.4.4.2	Movement time settings	43
4.2.4.4.3	Positioning and feedback settings	47
4.2.4.4.4	Safety function settings	57
4.2.4.4.5	Sun protection settings	61
4.2.4.4.6	Settings for automatic heating/cooling	86
4.2.4.4.7	Scene function settings	92
4.2.4.4.8	Forced position settings	95
4.2.4.4.9	Fabric stretching settings	98
4.2.4.5	Channel-oriented functions for the valve output	100
4.2.4.5.1	General settings	100
4.2.4.5.2	Command value settings	109
4.2.4.5.3	Settings for the status function	121
4.2.4.6	Priorities for the outputs	127
4.2.5	Delivery state	128
4.2.6	Parameters	129
4.2.6.1	General parameters	129
4.2.6.2	Parameters for the extension inputs	131
4.2.6.3	Parameters for the Venetian blind output	144
4.2.6.4	Parameters for the valve output	178
5	Appendix	187
5.1	Index	187

1 Product definition

1.1 Product catalogue

Product name: KNX Blind- a.Heating-Act.FM w.3 Inputs

Use: Actuator / sensor

Form: UP (concealed)

Art.-No. MEG6003-0006

1.2 Function

The device is used to control electrical loads of three different building systems that are typically used in a residential, office or hotel room:

The first output (O1) allows the control of electrically-operated Venetian blinds, roller shutters, awnings, venting louvers or similar blinds for 230 V AC mains voltage. The relay contacts for the movement directions (up, down) are bistable, meaning that the last switching status set also remains intact, should the mains voltage fail.

Furthermore, the device has one additional electronic switching output (O2), which allows silent control of electrothermal valve drives for heating or cooling systems. Up to 2 electrothermal valve drives can be connected to these electronic output, which is protected against overload and short-circuit.

The functionalities that can be preset with the ETS for the Venetian blind output include, for instance, separately configurable travelling times, enlarged feedback functions, assignment to up to 5 different safety functions, an extensive sun protection function, and incorporation into scenes or forced-position applications.

The electronic switching output has the following scope of functions: conversion of constant command value telegrams into a pulse-width modulated output signal (PWM). This provides quasi-constant activation of the connected valve drives. Alternatively, conversion of switching command values. Status messaging for valve position and cyclical monitoring of the command value telegrams. Emergency operation in the event of bus voltage return and forced position via bus telegram in summer and winter mode. Alarm message in case of short-circuit or overload of the switching output and anti-sticking protection for the valves. Valve drives that are closed or open when deenergised can be connected. The status message "valve closed" can be transmitted to the bus for further processing or displaying the information on other bus devices.

Besides the two outputs, the device possesses three additional inputs, which can have an internal effect on the Venetian blind output or, alternatively, affect the KNX/EIB separately, depending on the ETS configuration. The connected potential-free switch or button contacts are downloaded to the device via a shared reference potential. With the internal effect, inputs 1 and 2 directly operate the Venetian blind output. With the effect on the bus, the inputs can, independently of one another, transmit telegrams for switching or dimming for Venetian blind control or value encoder use (dimming value encoder, light scene extension).

The connection of 230 V signals or other external voltages to the extension inputs is not permitted!

For configuration and commissioning of this device, it is necessary to use ETS3.0 from version "d" onwards. Advantages with regard to downloading (significantly shorter loading times) and parameter programming can be expected only if this ETS patch version or later versions are used.

The device electronics are supplied exclusively from the bus voltage. The device is designed for installation in concealed switch or device boxes in permanent installations.

2 Installation, electrical connection and operation

2.1 Safety instructions

Electrical devices may only be fitted and installed by electrically skilled persons. The applicable accident prevention regulations must be observed.

Failure to observe the instructions may cause damage to the device and result in fire and other hazards.

Before working on the device or exchanging the connected loads, disconnect it from the power supply (switch off the miniature circuit breaker), otherwise there is the risk of an electric shock.

The device is not suitable for disconnection from supply voltage.

Make sure during the installation that there is always sufficient insulation between the mains voltage and the bus and extension inputs. A minimum distance of at least 4 mm must be maintained between bus/extensions and mains voltage cores.

Do not connect any external voltage to the inputs, since doing so may damage the device(s), and the SELV potential on the KNX bus line will no longer be available.

For parallel connection of several drives to a shutter / blind output it is indispensable to observe the corresponding instructions of the manufacturers, and to use a cutoff relay if necessary. There is otherwise risk of irreparable damage to the drives.

Use only curtains with mechanical or electronic limit switches. Check the limit switches for correct adjustment.

Do not connect any three-phase motors.

Connect only electrothermal valve drives to the electronic switching output. Do not connect any inductive or capacitive loads.

Do not operate electrothermal valve drives with DC.

The connected actuators are not electrically isolated from the mains - even when switched off.

The device may not be opened or operated outside the technical specifications.

2.2 Device components

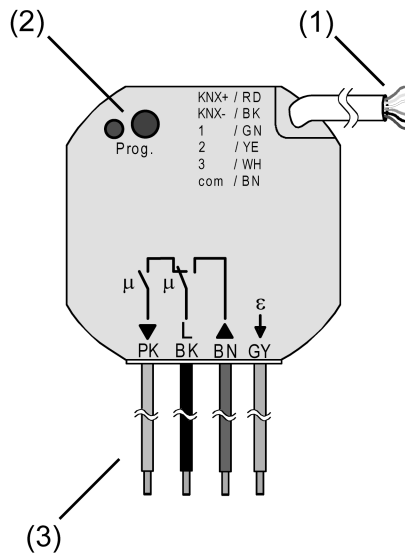

Figure 1: Device components

- (1) Control cable (bus connection and extension inputs)
- (2) Programming button and programming LED (red).
- (3) Connection cables for mains voltage and load

Connection assignment of the control cable (1)

- RD (red): KNX bus voltage +
- BK (black): KNX bus voltage -
- GN (green): Input 1
- YE (yellow): Input 2
- WH (white): Input 3
- BN (brown): Reference potential "COM" for inputs 1...3

Connection assignment for mains voltage and load (3)

- BK (black): Mains voltage (L)
- BN (brown): Connection for Venetian blind drive (UP, ▲) - relay output
- PK (pink): Connection for Venetian blind drive (DOWN, ▼) - relay output
- GY (grey): Connection for electrothermal actuators (ETA, ε) - electronic switching output

2.3 Fitting and electrical connection



DANGER!

Electrical shock when live parts are touched.

Electrical shocks can be fatal.

Before working on the device, disconnect the power supply and cover up live parts in the working environment.



DANGER!

When connecting the bus/extensions and mains voltage wires in a shared appliance box, the KNX bus line may come into contact with the mains voltage.

This endangers the safety of the entire KNX installation. People at remote devices may also receive an electric shock.

Do not place bus/extensions and mains voltage terminals in a shared connection compartment. Use an appliance box with a fixed partition wall or separate boxes.

Connecting and mounting the device

Minimum spacing between the mains voltage and bus/extension wires: 4 mm (Figure 2).

Recommendation: Use an electronics box when installing the device, e.g. with a series switch (Figure 3).

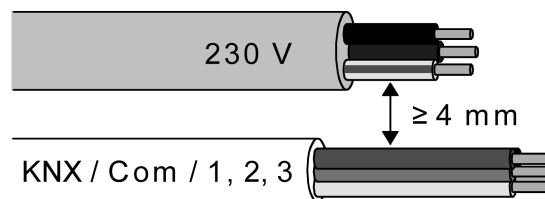

Figure 2: Minimum cable spacing

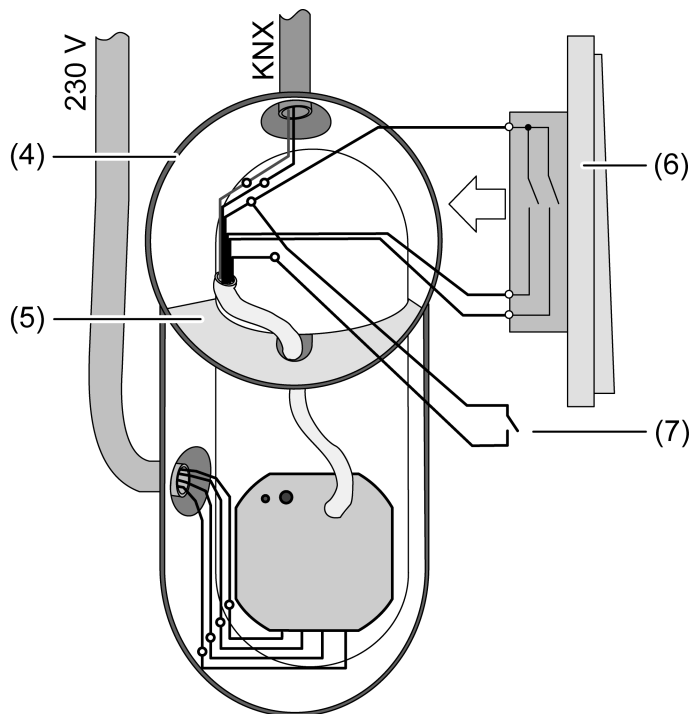

Figure 3: Installing the device in an electronics box (example)

- (4) Device box (e.g. electronics box)
- (5) Partition
- (6) Series switch
- (7) Potential-free contact, e. g. window contact

- Connect the mains voltage, Venetian blind drive and electrothermal actuators using the included screwless terminals (Figure 4).

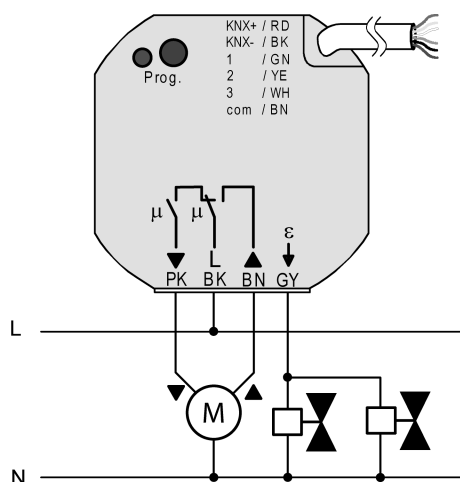

Figure 4: Connection of the mains voltage and the load

- Connect the device to KNX. For this, use a KNX connection terminal.
- If necessary, connect potential-free contacts to the inputs (Figure 5).
- i** Use suitable terminals to connect potential-free contacts to the control cable.

- i** The reference potential "com" may only be switched together with the reference potentials of other devices of the same type (!).

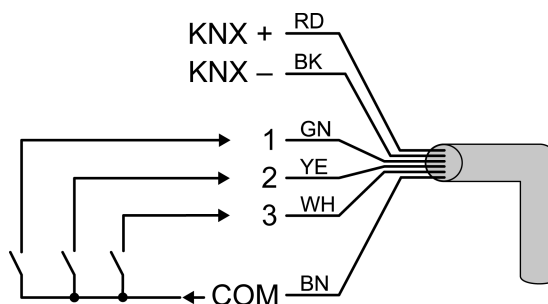

Figure 5: Connection of the extension inputs

- Install the device in a concealed box.
- i** Venting louvers must be connected in such a way that they open in travel direction "UP - ▲" and close in travel direction "DOWN - ▼".
- i** Do not connect any three-phase motors.
- i** Connect max. 2 electrothermal actuators to the electronic switching output. Do not connect any electric motor-driven actuators.
- i** When connecting the electrothermal actuators, pay attention to their direction of action (closed or open in deenergised state), and configure the device in the ETS accordingly. In the state as supplied the direction of action is preset to "closed when deenergised".
- i** Insulate unused wires of the 6-pin control cable against each other and outside voltage.
- i** To avoid interference from EMC radiation, the cables of the extension inputs should not be run in parallel to cables carrying voltage.

Use terminals

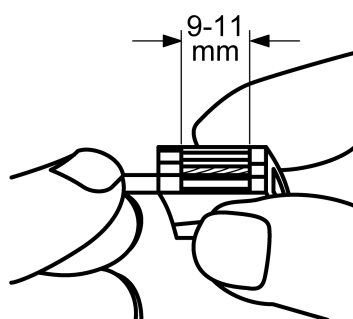

Figure 6: Stripping length

- Strip 9 - 11 mm of the cable (Figure 6).

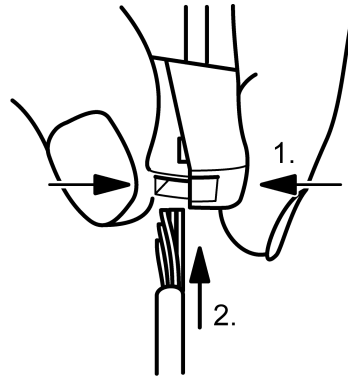

Figure 7: Connection of the fine-wire cable

- Push the terminal together on the side with the rectangular openings and connect the fine-wire connection cable of the device (Figure 7).

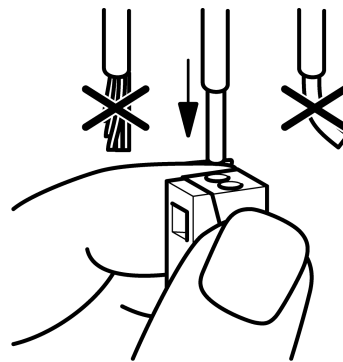

Figure 8: Connection of the single-stranded cable

- Push the single-stranded cable into the round opening on the installation side up to the stop (Figure 8).

2.4 Commissioning

After installation and connection of the bus line, the mains voltage and of all electrical loads, the device can be put into operation. For output 1 only, special commissioning steps have to be performed prior to programming with the ETS. The following procedure is generally recommended...



DANGER!

Electrical shock on contact with live parts in the installation environment.

Electrical shocks can be fatal.

Before working on the device, disconnect the power supply and cover up live parts in the working environment.

Measuring the travelling times

For the purpose of positioning blinds, shutters and awnings or for adjusting the opening angle of venting louvers, the device needs accurate information about the maximum travelling time for output 1.

The bus and mains voltage must be switched on.

Recommendation: Device operation using extension inputs (internal effect of input 1 "UP" and 2 "DOWN" on output 1 = as-delivered state).

- If not yet done, move the blind/shutter into the upper end position (open venting louver completely).
The upper limit-stop position is reached (venting louver opened).
 - Start the measuring time and move the blind/shutter by control into the lower end position (close the venting louver completely).
 - Stop the time measurement when the lower limit (when the completely closed) position is reached.
 - Enter the measured value in the ETS (cf. "software description").
- i** It is wise to perform several time measurements and to take the average of these values.
- i** The travelling time can also be determined after commissioning with the ETS (bus operation through communication objects).

Measuring the travelling time extension

When travelling upwards, blinds or shutters have a tendency of moving more slowly due to their own weight or to external physical influences (e.g. temperature, wind, etc.). The same applies to venting louvers where opening may take longer than closing.

For this reason, the device takes the configured travelling time extension into account for output 1 when moving upwards or when opening the louvers (MOVE operation / positioning). The extension is computed as a percentage of the difference of the travelling times in both directions.

The bus and mains voltage must be switched on.

Recommendation: Device operation using extension inputs (internal effect of input 1 "UP" and 2 "DOWN" on output 1 = as-delivered state).

The blind/shutter (venting louver) must be in the lower end position (venting louver closed).

- If not yet done, move the blind/shutter into the lower end position (close venting louver completely)
Lower end position reached (venting louver closed).
 - Start the measuring time and move the blind/shutter by control into the upper end position (open the venting louver completely).
 - Stop the time measurement when the upper limit (the completely open) position is reached.
 - Express the measured value as a percentage of the determined blind/shutter travelling time and enter the value in the ETS (cf. software description).
- i** It is wise to perform several time measurements and to take the average of these values.

- i** The travelling time extension can also be determined after commissioning with the ETS (bus operation through communication objects).

Measuring the slat moving time (only for blinds)

In the case of blinds with slats, the slat moving time is for technical reasons part of the overall travelling time of the blind. The slat moving time is the time required for a movement between the slat positions "closed – 100 %" and "open – 0 %". In order to compute the opening angle of the slats, the device needs an information about the slat moving time.

The slats must be completely closed (as in case of downward travel of the blind).

The bus and mains voltage must be switched on.

Recommendation: Device operation using extension inputs (internal effect of input 1 "UP" and 2 "DOWN" on output 1 = as-delivered state).

- Start the measuring time and open the slats completely by manual control (as in case of upward travel of the blind).
- Take the measuring time when the completely open position is reached.
- Enter the measured value in the ETS (cf. "software description").

- i** It is wise to perform several time measurements and to take the average of these values.
- i** The slat moving time can also be determined after commissioning with the ETS (bus operation through communication objects).

Commissioning with the ETS

After measuring the times for output 1, the device can be programmed by the ETS.

Commissioning is basically confined to programming of the physical address and the application data with the ETS.

Project planning and commissioning of the device using the ETS 3.0d with Patch A or newer versions.

The device is connected and ready for operation.

- Switch on the bus voltage
Check: When the programming button is pressed, the red programming LED must light up. Switching on the bus voltage causes the device carry out the "Behaviour after bus voltage return" configured in the ETS. In the state as supplied, this behaviour is set as follows for the outputs...
Blind output (O1): Drive stop,
O2 (valve output): Close valve. (Valve direction of action: deenergised closed = output OFF).
- Programming the physical address and the application data with the ETS.

Performing a reference movement (optional)

The device can approach newly preset curtain or louver positions for output 1 only if the current positions are known. For this purpose, the output must be given the opportunity to synchronise itself whenever the bus voltage is switched on or after every ETS programming run (physical address, application program, partial download). This synchronisation is performed by means of the reference movement.

The bus and mains voltage must be switched on.

- If not yet done, move the curtains to the upper end position (open venting louver completely).
- Wait until the output relay has switched off (not only the limit switch of the drive).
The reference movement is terminated.

- i** This device stores the curtain, slat or louver positions temporarily. After each bus voltage failure or after programming with the ETS, the device therefore automatically performs a reference movement for output 1 before a new position can be approached.
- i** After bus voltage return, the device generates an "invalid position" message for output 1 which can also be transmitted to the bus, if so configured. The message is withdrawn (inverted signal value) as soon as a reference movement could be executed.

2.5 Operation

In the as-delivered state of the device, extension inputs 1 and 2 have a direct effect on Venetian blind output 1. In this way, it is possible, for example, for a connected Venetian blind 'on the building site' to be commissioned and operated simply by applying the bus voltage and without using additional sensors.

After commissioning using the ETS, extension inputs 1 and 2 behaviour as they are configured in the ETS. It is also possible to let the inputs internally effect output 1. Alternatively, these inputs can also affect the bus and control other actuators. The extension inputs then function like standard KNX/EIB pushbutton interfaces.

- i** Extension input 3 always behaves independently and, through separate communication objects, only affects the bus. In the as-delivered state, this extension input is inactive.

If inputs 1 and 2 have an internal effect on output 1, control takes place using the two-area principle: Input 1 controls the "UP" command and input 2 controls the "DOWN" command. Venetian blind 1 is controlled according to Table 1...

Input	Contact on the input	Actuation time	Status of output 1
1	Closed (rising flank)	Short (< 0.4 s)	Short-time operation UP / Stop
1	Closed (rising flank)	Long (> 0.4 s)	Long time operation UP
2	Closed (rising flank)	Short (< 0.4 s)	Short-time operation DOWN / Stop
2	Closed (rising flank)	Long (> 0.4 s)	Long time operation DOWN
1 / 2	opened (falling flank)	Between 0.4 s ... 2.5 s	Stop / slat adjustment
1 / 2	opened (falling flank)	After 2.5 s	No reaction

Table 1: Effect of the extension inputs on output 1

- i** The times specified in Table 1 and the operating concept "Short - long - short" are preset in the as-delivered state of the device. However, the appropriate actuation times of inputs 1 and 2 can be configured in the ETS and thus adapted to special requirements (see page 32). The operating concept cannot be changed when inputs 1 and 2 have an internal impact.
- i** After bus voltage return, the device only switches to status change of the extension signals when the configured time for "delay after bus voltage return" has elapsed (see chapter 4.2.4.1. General functions for extension inputs). Within the delay, any pending flanks or signals at the inputs are not evaluated and are ignored. The delay time is configured generally for all the inputs. In the as-delivered state, the time is preset to "0 s".

3 Technical data

General

Mark of approval	KNX / EIB
Ambient temperature	-5 ... +45 °C
Storage/transport temperature	-25 ... +70 °C
Dimensions Ø×H	53×28 mm

KNX / EIB supply

KNX medium	TP 1
Commissioning mode	S-mode
Rated voltage KNX	DC 21 ... 32 V SELV
Power consumption KNX	max. 240 mW
Connection mode KNX	Connection terminal on control cable

Connection for mains voltage (L)

Connection mode	Terminal (enclosed)
Single stranded	1.0 ... 2.5 mm ²
Rated voltage	AC 230 / 240 V ~
Mains frequency	50 / 60 Hz

Output 1 (Venetian blind up / down)

Connection mode	Terminal (enclosed)
Single stranded	1.0 ... 2.5 mm ²
Contact type	μ
Switching voltage	AC 250 V~
Switching current AC1	3 A
Switch-on current 200 μs	max. 90 A
Switch-on current	max. 80 A (1 ms)
Minimum switching current AC	100 mA
Motors 230 V	600 VA

Output 2 (ETA output)

Connection mode	Terminal (enclosed)
Single stranded	1.0 ... 2.5 mm ²
Output type	Semi-conductor (Triac), ε
Switching voltage	AC 250 V~
Switching current	5 ... 25 mA
Switch-on current	max. 600 mA (2 sec)
Number of drives per output	max. 2

Inputs (I1, I2, I3)

Input type	Potential-free
Control cable (preterminated)	YY6x0.6
Total length of extension unit cable	max. 5 m
Loop resistance	max. 500 Ω

4 Software description

4.1 Software specification

ETS search paths: - 7.1 Heating/Single Room Thermostat / 7.1.13 Heating/switch actuator / KNX Blind- a.Heating-Act.FM w.3 Inputs
 - 4.5 Blind Actuator / 4.5.05 Flush-mounted UP / KNX Blind- a. Heating-Act.FM w.3 Inputs

BAU used: ASIC FZE 1066 + μ C
KNX/EIB type class: Device with cert. Physical layer + stack
Configuration: S-mode standard
PEI type: "00"_{Hex} / "0"_{Dec}
PEI connector: No connector

Application programs:

No.	Short description	Name	Version	from mask version
1	Multifunctional Venetian blind application incl. valve control for heating or cooling systems. Additional comprehensive extension function.	Venetian blind, valve, input 20BA11	1.1 for ETS3.0d onwards	705

4.2 Software "Venetian blind, valve, input 20BA11"

4.2.1 Scope of functions

General

- 1 x relay output (O1) to control a Venetian blind, roller shutter, awning or venting louver (mechanical locking of the running directions).
- 1 x electronic switching output (O2) for silent control of up to two electrothermal actuators (ETA) for heating or cooling systems. Conversion of switching or constant command value telegrams into a switching or pulse-width modulated output signal.
- 3 x extension inputs for potential-free contacts.
- No additional power supply required. The device electronics are supplied fully from the bus line.
- Each output and input offers the full scope of functions without any restrictions. All channel-orientated functions can be configured separately for each output or input. This feature permits independent and multi-functional control of the outputs and independent evaluation of the inputs.
- Actively transmitting feedback or status messages of the outputs can be delayed globally after bus voltage return or after ETS programming.
- The delay after bus voltage return can also be set generally for the inputs.
- Effect of the extension inputs can be configured: either internal effect of I1 and I2 on the Venetian blind output (O1) and I3 on the bus or, alternatively, all three inputs separately on the bus.
- Debounce time and telegram rate limit can be configured for the extension inputs.

Blind output (O1)

- Operating mode configurable: control of blinds with slats, shutters, awnings or venting louvers.
- Separately configurable blind travelling times with travelling time extension for moves into the upper end position.
- For blinds with slats, a slat moving time can be independently configured
- Travel direction change-over time and the times for short and long-time operation (Step, Move) presettable.
- Blind or slat position feedback telegram. In addition, an invalid blind position or an invalid travel movement can be reported back. Active (transmitting after changes or cyclically to the bus) or passive (object readout) feedback functions.
- Assigning of outputs to up to 5 different safety functions (3 wind alarms, 1 rain alarm, 1 frost alarm) optionally with cyclical monitoring.
- An extensive sun protection function with fixed and variable blind or slat positions at the beginning and at the end of the function can be activated separately for each output. Dynamic slat offset for slatted blinds included. Also with extended sun protection feature for integration into sophisticated shading control programs (operated via separate automatic and disabling object). Optionally also with automatic heating/cooling and presence detection function.
- Forced position function can be implemented.
- Up to 8 internal scenes configurable.

Valve output (O2)

- Control either via a switching (1 bit) or alternatively via a constant (1 byte) command value telegram. Constant command values are converted via pulse-width modulation at the output. The cycle time of the output signal can be configured.
- Status feedback (1 bit or 1 byte) possible automatically or on read request.
- Valve direction of action (open or closed in deenergised state) can be configured.
- Summer or winter mode can be selected via an object (polarity configurable).
- Cyclical monitoring of the command value can be set, taking into account a configurable monitoring time. If no telegram is received within the specified monitoring time, the output switches to emergency operation, and an alarm message can be transmitted to the bus (polarity can be configured).

- Forced position for activation of a fixed valve position configured in the ETS. Various valve positions can be preset for summer and winter mode. In forced operation, the electronic switching output cannot be controlled using the command values.
- If the command value is "OFF" or "0", the message "Valve closed" can be transmitted to the bus via an object. The telegram polarity of this status message can be configured in the ETS.
- Short-circuit and overload protection. Optionally with a separate alarm message to the bus (polarity can be configured).
- Anti-sticking protection for the connected valve drives.

Extension inputs (I1, I2, I3)

- With separate impact on bus:
 - Free allocation of the functions switching, dimming, Venetian blind and value encoder.
- Disable object for disabling individual inputs (polarity of the disable object is adjustable).
- Behaviour on bus voltage return can be configured separately for each input.
- Scope of detail for the "Switching" function:
 - Two independent switching objects available for each input (switching commands can be configured individually).
 - Command can be set independently for rising and falling flank (ON, OFF, TOGGLE, no reaction).
 - Independent cyclical transmission of the switching objects can be selected depending on the flank or depending on the object value.
- Scope of detail for the "Dimming" function:
 - Single-surface and double-surface operation possible.
 - Time between dimming and switching and dimming increments is adjustable.
 - Telegram repetition and stop telegram transmission possible.
- Scope of detail for the "Venetian blind" function:
 - Command can be set independently for rising flank (no function, UP, DOWN, TOGGLE).
 - Operation concept configurable (short – long – short or long – short).
 - Time adjustable between short-time and long-time operation (only for short – long – short)
 - Adjustable slat adjustment time (time during which a MOVE command can be terminated by releasing a pushbutton on the input).
- Scope of detail for the "Value encoder" function:
 - Flank (pushbutton as NO contact, pushbutton as NC contact, switch) and value for flank can be configured.
 - Value adjustment for pushbutton long key-press possible for value encoder.
 - For light scene extension with memory function, the scene can also be saved without prior recall.

4.2.2 Software information

ETS project design and commissioning

For configuration and commissioning of this device, it is necessary to use ETS3.0 from version "d" onwards. Advantages with regard to downloading (significantly shorter loading times) and parameter programming can be expected only if this ETS patch version or later versions are used. The advantages are gained through the use of the mask version 7.5.

The product database required for the ETS3.0 from version "d" or more recent versions is offered in the *.VD4 format. The corresponding application program has the version number "1.1".

Safe-state mode

If the device - for instance as a result of errors in the configuration or during commissioning - does not work properly, the execution of the loaded application program can be halted by activating the safe-state mode. The safe-state mode does not permit control of the outputs via the bus or evaluation of the inputs. The device remains passive since the application program is not being executed (state-of-execution: terminated). Only the system software is still functional so that the ETS diagnosis functions and also programming of the device continue to be possible.

Activating the safe-state mode

- Switch off the bus voltage (e.g. by disconnecting the device from the bus line).
- Press and hold down the programming button.
- Switch on the bus voltage (e.g. by connecting the device to the bus line). Release the programming button only after the programming LED starts flashing slowly.

The safe-state mode is activated. With a new brief press of the programming button, the programming mode can be switched on and off as usual also in the safe-state mode. The programming LED will nevertheless continue to flash independently of the programming mode as long as the safe-state mode is active.

- i** The safe-state mode can be terminated by switching off the bus voltage or by programming with the ETS.

Unloading the application program

The application program can be unloaded with the ETS. In this case, the internal effect of the extension inputs on the Venetian blind output as part of the application program is not available either. The device does not then function.

4.2.3 Object table

Number of communication objects:	36 (max. object number 86 - gaps in between)
Number of addresses (max):	254
Number of assignments (max):	255
Dynamic table management	Yes
Maximum table length	255

4.2.3.1 Extension input objects

Function: Switching

Object	Function	Name	Type	DPT	Flag
 10, 11, 12	Switching object X.1	Input 1 ... 3 ¹	1-bit	1.001	C, W, T ²

Description 1-bit object for the transmission of switching telegrams (ON, OFF)
(first switching object)

Function: Switching

Object	Function	Name	Type	DPT	Flag
 14, 15, 16	Switching object X.2	Input 1 ... 3 ¹	1-bit	1.001	C, W, T ²

Description 1-bit object for the transmission of switching telegrams (ON, OFF)
(second switching object)

Function: Dimming

Object	Function	Name	Type	DPT	Flag
 10, 11, 12	Switching	Input 1 ... 3 ¹	1-bit	1.001	C, W, T ²

Description 1-bit object for the transmission of switching telegrams (ON, OFF) for the
dimming function.

Function: Dimming

Object	Function	Name	Type	DPT	Flag
 14, 15, 16	Dimming	Input 1 ... 3 ¹	4-bit	3.007	C, W, T ²

Description 4-bit object for change of relative brightness between 0 and 100 %.

1: The objects for inputs 1 and 2 are not available when inputs have an internal effect on the Venetian blind output.

2: Each communication object can be read out. For reading, the R-flag must be set.

Function: Venetian blind

Object	Function	Name	Type	DPT	Flag
 10, 11, 12	Short time operation	Input 1 ... 3 ¹	1-bit	1.008	C, -, T ²

Description 1-bit object for short-time operation of a blind.

Function: Venetian blind

Object	Function	Name	Type	DPT	Flag
 14, 15, 16	Long time operation	Input 1 ... 3 ¹	1-bit	1.007	C, W, T ²

Description 1-bit object for long-time operation of a blind.

Function: Value encoder (dimming value encoder)

Object	Function	Name	Type	DPT	Flag
 10, 11, 12	Value	Input 1 ... 3 ¹	1 byte	5.001	C, -, T ²

Description 1 byte object to transmit value telegrams (0 ... 255).

Function: Value encoder (temperature value encoder)

Object	Function	Name	Type	DPT	Flag
 10, 11, 12	Temperature value	Input 1 ... 3 ¹	2 byte	9.001	C, -, T ²

Description 2-byte object for transmission of temperature value telegrams (0 °C ... 40 °C).

Function: Value encoder (brightness value encoder)

Object	Function	Name	Type	DPT	Flag
 10, 11, 12	Brightness value	Input 1 ... 3 ¹	2 byte	9.004	C, -, T ²

Description 2-byte object for transmission of brightness value telegrams (0 Lux ... 1,500 Lux).

Function: Value encoder (light scene extension)

Object	Function	Name	Type	DPT	Flag
 10, 11, 12	Light scene extension	Input 1 ... 3 ¹	1 byte	18.001	C, -, T ²

Description 1-byte object for opening or saving light scenes (1 ... 64).

1: The objects for inputs 1 and 2 are not available when inputs have an internal effect on the Venetian blind output.

2: Each communication object can be read out. For reading, the R-flag must be set.

Function: Disabling function

Object	Function	Name	Type	DPT	Flag
 18, 19, 20	Disabling switching object X.1	Input 1 ... 3 ¹	1-bit	1.003	C, S, - ²

Description 1-bit object for disabling the first switching object of an extension input (polarity configurable).
Only for the "Switching" function!

Function: Disabling function

Object	Function	Name	Type	DPT	Flag
 22, 23, 24	Disabling switching object X.2	Input 1 ... 3 ¹	1-bit	1.003	C, S, - ²

Description 1-bit object for disabling the second switching object of an extension input (polarity configurable).
Only for the "Switching" function!

Function: Disabling function

Object	Function	Name	Type	DPT	Flag
 18, 19, 20	Disabling	Input 1 ... 3 ¹	1-bit	1.003	C, S, - ²

Description 1-bit object for disabling an extension input (polarity configurable).
Only for the "Dimming", "Venetian blind" and "Value encoder" functions.

1: The objects for inputs 1 and 2 are not available when inputs have an internal effect on the Venetian blind output.

2: For reading, the R-flag must be set. The last value written to the object via the bus will be read.

4.2.3.2 Venetian blind output objects

Function: Safety function

Object	Function	Name	Type	DPT	Flag
 ³	Wind alarm 1	Output 1	1-bit	1.005	C, S, - ¹

Description 1-bit object for activation or deactivation of the first wind alarm ("0" = wind alarm deactivated / "1" = wind alarm activated).

Function: Safety function

Object	Function	Name	Type	DPT	Flag
 ⁴	Wind alarm 2	Output 1	1-bit	1.005	C, S, - ¹

Description 1-bit object for activation or deactivation of the second wind alarm ("0" = wind alarm deactivated / "1" = wind alarm activated).

Function: Safety function

Object	Function	Name	Type	DPT	Flag
 ⁵	Wind alarm 3	Output 1	1-bit	1.005	C, S, - ¹

Description 1-bit object for activation or deactivation of the third wind alarm ("0" = wind alarm deactivated / "1" = wind alarm activated).

Function: Safety function

Object	Function	Name	Type	DPT	Flag
 ⁶	Rain alarm	Output 1	1-bit	1.005	C, S, - ¹

Description 1-bit object for activation or deactivation of the rain alarm ("0" = rain alarm deactivated / "1" = rain alarm activated).

Function: Safety function

Object	Function	Name	Type	DPT	Flag
 ⁷	Frost alarm	Output 1	1-bit	1.005	C, S, - ¹

Description 1-bit object for activation or deactivation of the frost alarm ("0" = frost alarm deactivated / "1" = frost alarm activated).

Function: Long time operation

Object	Function	Name	Type	DPT	Flag
 ³⁶	Long time operation	Output 1	1-bit	1.008	C, S, - ¹

Description 1-bit object for activation of long time operation

1: For reading, the R-flag must be set. The last value written to the object via the bus will be read.

Function: Short time operation

Object	Function	Name	Type	DPT	Flag
 ³⁷	Short time operation	Output 1	1-bit	1.007	C, S, - ¹

Description 1-bit object for activation of short time operation or for stopping a drive movement.

Function: Forced position

Object	Function	Name	Type	DPT	Flag
 ³⁸	Forced position	Output 1	2-bit	2.008	C, S, - ¹

Description 2-bit object for forced control. The object state after bus voltage return can be predefined by means of a parameter.

Function: Light scene function

Object	Function	Name	Type	DPT	Flag
 ³⁹	Scene extension	Output 1	1 byte	18.001	C, S, - ¹

Description 1-byte object for recalling scenes or for storing new scene values.

Function: Sun protection function

Object	Function	Name	Type	DPT	Flag
 ⁴¹	Automatic mode	Output 1	1-bit	1.003	C, S, - ¹

Description 1-bit object for activation or deactivation of the automatic sun protection in the extended sun protection mode ("1" = automatic mode activated / "0" = automatic mode deactivated). The object is only visible, if the automatic sun protection is to be tracked immediately when the state of the automatic object changes (parameter setting).

Function: Sun protection function

Object	Function	Name	Type	DPT	Flag
 ⁴²	Automatic mode disable	Output 1	1-bit	1.003	C, S, - ¹

Description 1-bit object for disabling of the automatic sun protection in the extended sun protection mode. The polarity can be configured. The object is only visible, if the automatic sun protection is to be tracked immediately when the state of the automatic object changes (parameter setting).

1: For reading, the R-flag must be set. The last value written to the object via the bus will be read.

Function: Sun protection function

Object	Function	Name	Type	DPT	Flag
 ⁴²	Automatic mode	Output 1	1-bit	1.003	C, S, - ¹

Description 1-bit object for activation or deactivation of the automatic sun protection in the extended sun protection mode. The polarity can be configured. The object is only visible, if the automatic sun protection is to be tracked only when the state of the automatic object changes next time (parameter setting).

Function: Sun protection function

Object	Function	Name	Type	DPT	Flag
 ⁴³	Direct operation disable	Output 1	1-bit	1.003	C, S, - ¹

Description 1-bit object for disabling direct operation in the extended sun protection mode (direct operation = Move / Step / Position / Scene). The polarity can be configured.

Function: Sun protection function

Object	Function	Name	Type	DPT	Flag
 ⁴⁴	Sunshine / shading facade	Output 1	1-bit	1.002	C, S, - ¹

Description 1-bit object for activation or deactivation of sun shading in the simple or extended sun protection mode (sun / no sun). The polarity can be configured.

Function: Sun protection function

Object	Function	Name	Type	DPT	Flag
 ⁴⁵	Sunsh./shading position ²	Output 1	1 byte	5.001	C, S, - ¹

Description 1-byte object for presetting a variable position value (0...255) for the height of the Venetian blind or roller shutter height or the venting louver position when the sun protection is active.

Function: Sun protection function

Object	Function	Name	Type	DPT	Flag
 ⁴⁶	Slat pos. Sunshine / shading	Output 1	1 byte	5.001	C, S, - ¹

Description 1-byte object for presetting a variable slat position value (0...255) when the sun protection is active.

1: For reading, the R-flag must be set. The last value written to the object via the bus will be read.

2: The object designation varies with the type of blind (Venetian blind, roller shutter / awning, venting louver).

Function: Sun protection function

Object	Function	Name	Type	DPT	Flag
 ⁴⁷	Sunshine slat position offset	Output 1	1 byte	6.001	C, S, - ¹

Description 1-byte object for presetting a slat position angle (- 100 % ... +100 % / smaller or larger position angles are treated as + or - 100 %) for 'manual' readjustment of the slat position during active sun protection.

Function: Sun protection function – automatic heating/cooling

Object	Function	Name	Type	DPT	Flag
 ⁴⁸	Heating/cooling presence	Output 1	1-bit	1.018	C, S, - ¹

Description 1 -bit object for activation of the presence mode during automatic heating/cooling. The polarity can be configured. This object is generally linked with presence detectors.

Function: Sun protection function – automatic heating/cooling

Object	Function	Name	Type	DPT	Flag
 ⁴⁹	Heating/cooling switchover	Output 1	1-bit	1.100	C, S, - ¹

Description 1-bit object for switching over between heating and cooling operation during automatic heating/cooling. The polarity can be configured. This object is generally linked with room temperature controllers (object "heating/cooling switchover").

Function: Position feedback

Object	Function	Name	Type	DPT	Flag
 ⁵⁰	Position feedback ²	Output 1	1 byte	5.001	C, -, T, R ³

Description 1-byte object for position feedback of the Venetian blind or roller shutter height or louver position (0...255).

Function: Position feedback

Object	Function	Name	Type	DPT	Flag
 ⁵¹	Slat position feedback	Output 1	1 byte	5.001	C, -, T, R ³

Description 1-byte object for position feedback of the slat position (0...255) if one shutter is controlled.

1: For reading, the R-flag must be set. The last value written to the object via the bus will be read.

2: The object designation varies with the type of blind (Venetian blind, roller shutter / awning, venting louver).

3: The communication flags are set automatically depending on the configuration. "T" flag for active signalling object; "R" flag for passive status object.

Function: Position feedback

Object	Function	Name	Type	DPT	Flag
 ⁵²	Invalid position feedback	Output 1	1-bit	1.002	C, -, T, R ¹

Description 1-bit object for reporting back an invalid position of the Venetian blind or roller shutter height or louver position ("0" = position valid / "1" = position invalid).

Function: Drive movement feedback

Object	Function	Name	Type	DPT	Flag
 ⁵³	Drive movement feedback	Output 1	1-bit	1.002	C, -, T, R ¹

Description 1-bit object for feedback of an active drive movement (output energised - up or down). ("0" = no drive movement / "1" = drive movement).

Function: Presetting the position

Object	Function	Name	Type	DPT	Flag
 ⁵⁴	Position ²	Output 1	1 byte	5.001	C, S, - ³

Description 1-byte object for presetting a position value (0...255) for the height of the Venetian blind or roller shutter or the venting louver position in direct operation.

Function: Presetting the position

Object	Function	Name	Type	DPT	Flag
 ⁵⁵	Slat position	Output 1	1 byte	5.001	C, S, - ³

Description 1-byte object for presetting a slat position value (0...255) in direct operation.

1: The communication flags are set automatically depending on the configuration. "T" flag for active signalling object; "R" flag for passive status object.

2: The object designation varies with the type of blind (Venetian blind, roller shutter / awning, venting louver).

3: For reading, the R-flag must be set. The last value written to the object via the bus will be read.

4.2.3.3 Valve output objects

Function: Command value

Object	Function	Name	Type	DPT	Flag
 62	Command value	Output 2	1-bit	1.001	C, S, - 1

Description 1-bit object to specify a switching command value of a room temperature controller.

Function: Command value

Object	Function	Name	Type	DPT	Flag
 62	Command value	Output 2	1 byte	5.001	C, S, - 2

Description 1-byte object to specify a permanent command value of a room temperature controller.

Function: Command value status

Object	Function	Name	Type	DPT	Flag
 63	Command value status	Output 2	1-bit	1.001	C, -, T 3

Description 1-bit object to transmit or read out status telegrams on the current target valve position value for switching command values
"Valve opened" = "1" / "Valve closed" = "0".

Function: Command value status

Object	Function	Name	Type	DPT	Flag
 63	Command value status	Output 2	1 byte	5.001	C, -, T 3

Description 1-byte object to transmit or read out status telegrams on the current target valve position value for permanent command values (0...255).

Function: Forced position

Object	Function	Name	Type	DPT	Flag
 64	Forced position	Output 2	1-bit	1.001	C, S, - 1

Description 1-bit object for forced control of the valve output.
("1" = Forced position active / "0" = Forced position inactive).

1: For reading, the R-flag must be set. The last value written to the object via the bus will be read.

2: The communication flags are set automatically depending on the configuration. "T" flag for active object; "R" flag for passive object.

3: Each communication object can be read out. For reading, the R-flag must be set.

Function: Short-circuit / overload

Object	Function	Name	Type	DPT	Flag
 ⁶⁵	Short-circuit / overload alarm	Output 2	1-bit	1.005	C, -, T ¹

Description 1-bit object for the overload or short-circuit message of the valve output to the bus. The object remains active (configurable polarity) until the overload or short-circuit has been removed.

Function: Command value monitoring

Object	Function	Name	Type	DPT	Flag
 ⁶⁶	Command value monitoring alarm	Output 2	1-bit	1.005	C, -, T ¹

Description 1-bit object for signalling that command values have not appeared during the monitoring time and emergency operation was activated (configurable polarity).

Function: Command value limit

Object	Function	Name	Type	DPT	Flag
 ⁶⁷	Command value limit	Output 2	1-bit	1.001	C, S, - ²

Description 1-bit object to activate and deactivate the command value limit ("0" = Command value limit inactive / "1" = Command value active). The object value can be configured in the ETS after a device reset.

Function: Valve check

Object	Function	Name	Type	DPT	Flag
 ⁸⁵	Valve closed	Output 2	1-bit	1.002	C, -, T ¹

Description 1-bit object to display the command value "OFF" (1-bit) or "0" (1-byte) and that the valve is closed (configurable polarity).

Function: Summer/winter mode switchover

Object	Function	Name	Type	DPT	Flag
 ⁸⁶	Summer/winter switchover	Output 2	1-bit	1.001	C, S, - ²

Description 1-bit object to switch over between summer and winter mode (polarity and preference value can be configured after an ETS programming operation).

1: Each communication object can be read out. For reading, the R-flag must be set.

2: For reading, the R-flag must be set. The last value written to the object via the bus will be read.

4.2.4 Functional description

4.2.4.1 General functions for extension inputs

Effect of the extension inputs

The device possesses extension inputs, which can have an internal effect on the Venetian blind output or, alternatively, affect the KNX/EIB separately, depending on the ETS configuration. With the internal effect, inputs 1 and 2 directly operate the Venetian blind output. This configuration also corresponds to the as-delivered status (unprogrammed device). In this way, it is possible, for example, for a connected Venetian blind 'on the building site' to be commissioned and operated simply by applying the bus voltage and without using additional sensors.

With the effect on the bus, the inputs can, independently of one another, transmit telegrams for switching or dimming for Venetian blind control or value encoder use (dimming value encoder, light scene extension). They then function like a pushbutton interface.

The parameter "Effect of the extension inputs" on the "General" parameter page defines the use of the inputs.

- Set the parameter to "I1 & I2 internally on O1, I3 separately on the bus".

The extension inputs 1 and 2 only directly affect the internal Venetian blind output of the device. For two-area operation, input 1 operates the "UP" command and input 2 the "DOWN" command. Input 3 behaves independently and, through separate communication objects, only affects the bus.

Venetian blind output 1 is controlled according to Table 2...

Input	Contact on the input	Actuation time	Status of output 1
1	Closed (rising flank)	Short (< 0.4 s)	Short-time operation UP / Stop
1	Closed (rising flank)	Long (> 0.4 s)	Long time operation UP
2	Closed (rising flank)	Short (< 0.4 s)	Short-time operation DOWN / Stop
2	Closed (rising flank)	Long (> 0.4 s)	Long time operation DOWN
1 / 2	opened (falling flank)	Between 0.4 s ... 2.5 s	Stop / slat adjustment
1 / 2	opened (falling flank)	After 2.5 s	No reaction

Table 2: Effect of the extension inputs on output 1

i The times specified in Table 2 and the operating concept "Short - long - short" are preset in the as-delivered state of the device. However, the appropriate actuation times of inputs 1 and 2 can be configured in the ETS and thus adapted to special requirements (see page 32). The operating concept cannot be changed when inputs 1 and 2 have an internal impact.

i After bus voltage return, the device only switches to status change of the extension signals when the configured time for "delay after bus voltage return" has elapsed (see chapter 4.2.4.1. General functions for extension inputs). Within the delay, any pending flanks or signals at the inputs are not evaluated and are ignored. The delay time is configured generally for all the inputs. In the as-delivered state, the time is preset to "0 s". It is also possible to configure a general telegram rate limit. In this case no more telegrams are transmitted to the bus in 17 seconds (permanently defined, cyclical time interval) than are specified in the ETS.

- Set the parameter to "I1, I2 & I3 separately on the bus".

The three inputs of the device affect the KNX/EIB independently of the Venetian blind output and each other. Depending on the ETS configuration, the functions "Switching", "Dimming", "Venetian blind" or "Value encoder" can be set (see chapter 4.2.4.3.1. Function configuration of the extension inputs).

The "No function" setting deactivates the appropriate input. With the "Venetian blind" setting, the input objects can be connected to the objects of the Venetian blind output using group objects. This allows control of the device using its own inputs, even if the extensions are affecting the bus (e.g. with group control of multiple actuators during installation).

Delay after bus voltage return

It is possible to specify separately for each input whether a reaction should take place after a device reset (bus voltage return or ETS programming operation). This means that a defined telegram can be transmitted to the bus according to the input signal or with forced control. The configured "Delay after bus voltage return" for the extension inputs on the "General" parameter page must have elapsed fully by the time the set reaction is executed. Within the delay, any pending flanks or signals at the inputs are not evaluated and are ignored. The delay time is configured generally for all the inputs. In the as-delivered state of the device, the time is preset to "0 s".

Telegram rate limit

It is possible to configure a general telegram rate limit using the parameter of the same name on the "General" parameter page. If the telegram rate limit is enabled, no more telegrams are transmitted to the bus in 17 seconds (permanently defined, cyclical time interval) than is specified in the ETS. This avoids fast flank changes at the inputs causing an unpermissibly high bus load.

- i A telegram rate limit does not influence a configured delay after bus voltage return. These two functions can be combined in any way.

4.2.4.2 General functions for the outputs

Delay after bus voltage return

To reduce telegram traffic on the bus line after bus voltage activation (bus reset), after connection of the device to the bus line or after programming with the ETS, it is possible to delay all actively transmitted feedback telegrams of the actuator outputs. For this purpose, a channel-independent delay can be specified for the outputs 1 and 2 using the parameter "Delay after bus voltage return" on the "General" parameter page. Only after the configured time elapses are feedback telegrams for initialisation transmitted to the bus.

Which of the telegrams is actually delayed and which is not can be specified for each output channel and for the signalling or status function separately.

- i** The delay has no effect on the behaviour of the outputs. Only the bus telegrams for feedback are delayed. During the delay, the outputs can also be activated via the bus or the extension inputs after bus voltage return.
Exception: Delay for extension inputs (see chapter 4.2.4.1. General functions for extension inputs).
- i** A setting of "0" for the delay after bus voltage return deactivates the delaying function altogether. In this case, any messages, if actively transmitted, will be transmitted to the bus without any delay.

4.2.4.3 Channel-orientated functions for extension inputs

4.2.4.3.1 Function configuration of the extension inputs

The following section contains descriptions of the various functions that can be configured in the ETS independently for each input. The functions "Switching", "Dimming", "Venetian blind" or "Value encoder" can be set.

It should be noted that the extension inputs 1 and 2 can optionally affect the internal Venetian blind output of the device (see page 29-30). In this case, inputs 1 and 2 do not have separate communication objects and are permanently configured to the Venetian blind function in the ETS. These inputs can only be given a limited configuration.

- i** Extension input 3 always behaves independently and, through separate communication objects, only affects the bus.

Internal effect of the extension inputs 1 and 2

Inputs 1 and 2, can either have an internal effect on the Venetian blind output or, alternatively, affect the KNX/EIB separately. The parameter "Effect of the extension inputs" on the "General" parameter page defines the effect of the inputs (see page 29-30).

With the internal effect, inputs 1 and 2 directly operate the Venetian blind output. This configuration corresponds to the as-delivered state (unprogrammed device). With an internal effect, the operating concept (evaluation of short time and long time operation) is set permanently to "Short - long - short". However, the appropriate actuation times of inputs 1 and 2 can be configured in the ETS and thus adapted to special requirements. This means that it is possible, on parameter pages "I1 - General" and "I2 - General" to configure the "Time between short and long time operation" (T1) and the "Slat adjustment time" (T2) (Figure 9).

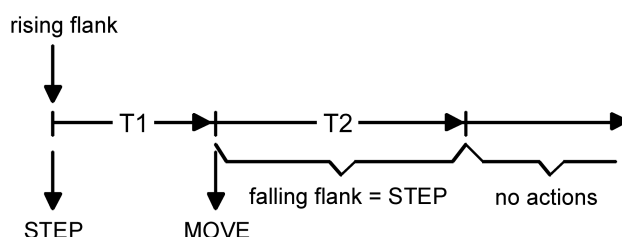

Figure 9: Operating concept "Short - long - short" when inputs 1 and 2 have an internal impact

With a rising flank, input 1 always operates the movement direction "UP". Input 2 operates the movement direction "DOWN". After bus voltage return, unoperated inputs do not show any special behaviour.

- i** In the as-delivered state, the times between short and long time operation and the slat adjustment times of the inputs are matched to the time of short time operation and the movement time (long time operation) of the Venetian blind output. If the times at the inputs are changed, then it should be observed that, for flawless operation of the blind or venting louver at output 1, the times of the output may also need to be adjusted.
- i** It is not possible to actuate the inputs simultaneously.
- i** After bus voltage return, the device only switches to status change of the extension signals when the configured time for "delay after bus voltage return" has elapsed (see page 30). Within the delay, any pending flanks or signals at the inputs are not evaluated and are ignored. The delay time is configured generally for all the inputs. In the as-delivered state, the time is preset to "0 s".

Switching function

For each input whose function is set to "Switching", the ETS displays two 1-bit communication objects (switching object X.1 and X.2). It is possible to use these two objects to transmit different switching telegrams to the bus depending on the signal flank at the input. The input

parameter on the parameter page "Ix - General " (x = 1, 2, 3) can be used to define which object value is transmitted to the bus when there is a rising or falling flank at the input (no reaction, ON, OFF, TOGGLE - switchover of the object value). No distinction is made between a brief or long signal flank/actuation in the "Switching" function.

Response to bus voltage return

After a device reset (bus voltage return or ETS programming operation), the communication objects of the input can be initialised. For this, the "Behaviour on bus voltage return" parameter should be configured to the required reaction. In the settings "On telegram" or "Off telegram" telegrams are transmitted actively to the bus according to this requirement. In the "Transmit current input status" setting, the device evaluates the static signal status of the input and, according to this, transmits the appropriately configured telegram to the bus (contact closed at the input = telegram as with rising flank; contact open at input = telegram as with falling flank). If, in this case, the flank command dependent on the current status is configured to "No reaction", the device does not transmit a telegram to the bus on initialisation. If, in the ETS, a delay is set for the extension inputs after bus voltage return, the device only transmits the telegrams when the delay has elapsed.

Cyclical transmission

Optionally, the object values can be transmitted cyclically to the bus for the "Switching" function. For this, the transmission criteria must first be defined in the ETS. The "Transmit cyclically ?" parameter on the parameter page "Ix - Transmit cyclically" (x = 1, 2, 3) specifies with which value cyclical transmission should take place. Depending on requirements, it is possible to transmit cyclically via both or just one switching object(s). In addition, it is possible to define the cycle time separately for both switching objects in the ETS.

The object value entered in the switching objects by the device on a flank change or externally by the bus is always transmitted cyclically. The object value is then also transmitted cyclically when "no reaction" is assigned to a rising or falling flank. Cyclical transmission also takes place directly after bus voltage return, if the reaction after bus voltage return corresponds to the transmission criterion for cyclical transmission. During an active disable, no cyclical transmissions take place via the disabled input.

Dimming function

For each input whose function is set to "Dimming", the ETS indicates a 1-bit "Switching" and a 4-bit "Dimming" object. In general, the device transmits a switching telegram on a short time input signal (triggered by the rising flank of a closed contact) and a dimming telegram on a long signal. In the standard configuration, the device transmits a telegram for stopping the dimming action after a long signal.

The length of time the input signal (closed pushbutton or switch) must last until a long actuation is detected can be set using the parameter "Time between switching and dimming" on the parameter page "Ix - General" (x = 1, 2, 3).

Operating principle

The "Operation" parameter specifies the operating principle. In the presetting of the dimming function, two-surface operation is specified here. This means that the input transmits a telegram for switching on after a short signal length and a telegram for increasing the brightness after a long signal length ("Brighter"). Alternatively, the device can transmit a telegram for switching off after a short signal length and a telegram for reducing the brightness after a long signal length ("Darker").

With a single-surface dimming function, the input transmits switch-on and switch-off telegrams ("TOGGLE") in an alternating pattern for each short signal. After long signals, the device transmits "brighter" and "darker" telegrams in an alternating pattern.

- i** With single-surface dimming, the following should be observed: if a dimming actuator is to be controlled from several locations, a faultless single-surface operation requires that the addressed actuator reports its switching state back to the 1-bit object of the input and that the 4-bit objects of all the sensors are interlinked. The sensor device would otherwise not be able to detect that the actuator has been addressed from another sensor, in which case it would have to be actuated twice during the next use in order to produce the desired reaction.

The additional input parameters on the parameter page "Ix - General" can be used to specify in which increments brighter or darker dimming take place, whether a stop telegram is transmitted on a falling flank or whether the dimming telegram is to be repeated cyclically.

Response to bus voltage return

After a device reset (bus voltage return or ETS programming operation), the communication object "Switching" of the input can be initialised. For this, the "Behaviour on bus voltage return" parameter should be configured to the required reaction. In the settings "On telegram" or "Off telegram" telegrams are transmitted actively to the bus.

If, in the ETS, a delay is set for the extension inputs after bus voltage return, the device only transmits the telegrams when the delay has elapsed.

After a device reset, the "Dimming" object is always initialised with "0".

Venetian blind function

For each input, whose function is set to "Venetian blind", the ETS indicates the two 1-bit objects "Short time operation" and "Long time operation".

For the control of Venetian blind, roller shutter, awning or similar drives, the device supports two operation concepts for the Venetian blind function in which the telegrams are transmitted in different time sequences. The device can therefore be used to operate a wide variety of drive configurations. In the ETS, the operating concept of an input is defined using the parameter of the same name on the parameter page "Ix - General" (x = 1, 2, 3). The following settings are possible...

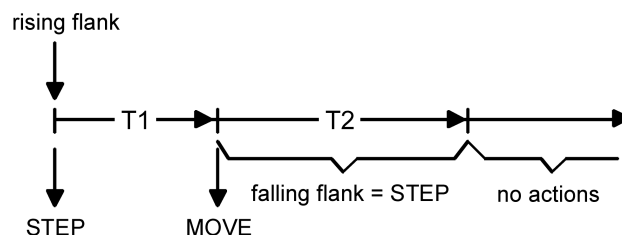

Figure 10: Operation concept "short - long - short"

Operation concept for the Venetian blind function

Operation concept "short - long - short":

In the operation concept "short - long - short", the input shows the following behaviour:

- Immediately after a rising flank (closed pushbutton or switch) the input transmits a short time telegram onto the bus. Pressing the button stops a running drive and starts time T1 ("time between short time and long time operation"). If the a falling flank is detected within T1 (closed pushbutton or switch), no further telegram will be transmitted. This short time serves the purpose of stopping a continuous movement. The "Time between short time and long time command" in the input parameters should be selected shorter than the short time operation of the actuator to prevent a jerky movement of the shutter.
- If the button is kept depressed longer than T1, the input transmits a long time telegram after the end of T1 for starting up the drive and time T2 ("slat adjusting time") is started.

- If a falling flank is detected within the slat adjustment time, the input transmits an additional short time telegram. This function is used for adjusting the slats of a blind. The function permits stopping the slats in any position during their rotation. The "slat adjusting time" should be chosen as required by the drive for a complete rotation of the slats. If the "slat adjusting time" is selected longer than the complete running time of the drive, a pushbutton function is possible as well. This means that the drive is active only when a button connected to the input is kept depressed.
- If the button is kept depressed longer than T2, the input transmits no further telegram. The drive remains on until the end position is reached.

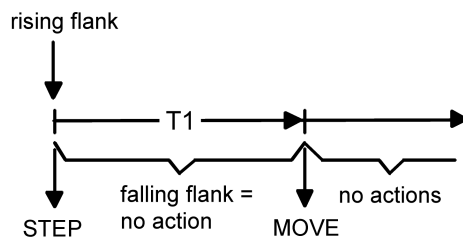

Figure 11: Operation concept "long – short"

Operation concept "long – short":

In the operation concept "long – short", the input shows the following behaviour:

- Immediately on pressing the button, the input transmits a long time telegram. The drive begins to move and time T1 ("slat adjusting time") is started.
- If a falling flank is detected within the slat adjustment time, the input transmits a short time telegram. This function is used for adjusting the slats of a blind. The function permits stopping the slats in any position during their rotation. The "slat adjusting time" should be chosen as required by the drive for a complete rotation of the slats. If the "slat adjusting time" is selected longer than the complete running time of the drive, a pushbutton function is possible as well. This means that the drive is active only when a button connected to the input is kept depressed.
- If the button is kept depressed longer than T1, the input transmits no further telegram. The drive remains on until the end position is reached.

Flank evaluation

The parameter "Command on rising flank" on the parameter page "Ix - General" (x = 1, 2, 3) specifies the direction of movement of the short time or long time telegram. In the "TOGGLE" setting (single-surface operation) the input switches the direction of the short and long time telegram each time there is a new signal. Several short time telegrams in succession have the same direction.

- i** If the actuator is to be controlled from several locations, a faultless single-surface actuation requires that the all long time objects of the sensor devices are interlinked. A sensor device would otherwise not be able to detect that the actuator has been addressed from another sensor, in which case it would have to be actuated twice during the next use in order to produce the desired reaction.

Response to bus voltage return

After a device reset (bus voltage return or ETS programming operation), the communication object "Long time operation" of the input can be initialised. For this, the "Behaviour on bus voltage return" parameter should be configured to the required reaction. In the settings "Up" or "Down", telegrams are transmitted actively to the bus.

If, in the ETS, a delay is set for the extension inputs after bus voltage return, the device only transmits the telegrams when the delay has elapsed.

After a device reset, the "Short time operation" object is always initialised with "0".

Value transmitter function

For each input whose function is set to "Value encoder", the ETS indicates either a 1-byte or a 2-byte object. The data format of the value object is dependent on the set function of the value encoder. The "Function as" parameter on the parameter page "Ix - General" (x = 1, 2, 3) defines the function on one of the following value encoder applications...

- Dimming value encoder (1-byte),
- Temperature value encoder (2-bytes),
- Brightness value encoder (2-bytes),
- Light scene extension without memory function (1-byte),
- Light scene extension with memory function (1-byte).

The dimming value encoder, temperature and brightness value encoder different in data format and in the range of values. The independent function of the light scene extension is special and is described below.

Dimming value encoder, temperature and brightness value encoder

In the function as a dimming value encoder, the input can transmitted unformatted integers in the range 0 ... 255 to the bus. As a brightness value encoder, the input transmits formatted floating point values in the range 0 ... 1500 Lux and, as a temperature value encoder, in the range 0 ... 40 °C. Table 3 shows a summary of the value ranges of the value encoders. The values to be transmitted are configured in the ETS and can be adjusted later during device operation (see value adjustment below).

The flank evaluation of the device means that it can transmit values only on a rising flank, only on a falling flank or on a rising and falling flank. In this way, it is possible to make adjustments to the contact connected at the input (pushbutton as NC contact or NO contact and switch).

Value encoder type	Function	Lower numerical limit	Upper numerical limit
Dimming value encoder	0 ... 255	0	255
Temperature value transmitter	Temperature value	0 °C	40 °C
Brightness value transmitter	Brightness value	0 lux	1,500 lux

Table 3: Value ranges of dimming value encoder, temperature and brightness value encoder

Value adjustment for dimming value encoder, temperature and brightness value encoder

With the dimming value encoder and the temperature and brightness value encoder, the value to be transmitted can be adjusted at any time during device operation. A value adjustment can only be configurable in the ETS when the value is to be transmitted only on a rising flank or only on a falling flank, i.e. a pushbutton is connected to the input.

A value adjustment is introduced by a long signal at the input (> 5 s) and continues for as long as the signal is detected as active, i.e. the pushbutton is actuated. With the first adjustment after commissioning, the value programmed by the ETS is increased cyclically by the step width configured for the dimming value encoder and transmitted. The step width of the temperature value encoder (1 °C) and the brightness value encoder (50 Lux) is permanently defined. The previously transmitted value is saved after releasing the pushbutton. The next long pushbutton actuation adjusts the saved value and the direction of the value adjustment changes.

The time between two telegrams on adjusting values can be configured in the ETS.

Example of value adjustment (Figure 12):

- Function as dimming value encoder
- Transmit value on = Rising flank
- Value configured in the ETS for rising flank = 17
- Step width = 5

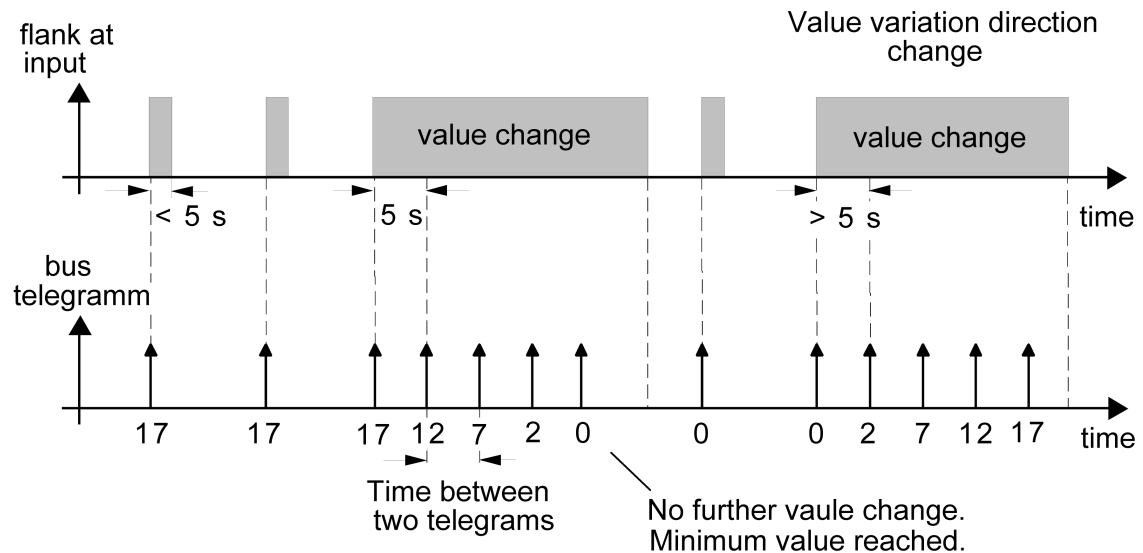

Figure 12: Example to change the value for dimming value encoder

- i** There is no value over- or underrun on adjustment. If, during an adjustment, the maximum or minimum value is reached (see Table 3), no more telegrams are transmitted.
- i** To ensure that, during a value adjustment, for example the controlled lighting switches off or switches on at the maximum, the limit values (e.g. the values "0" or "255") are always transmitted when the limits of the adjustable range are reached. This also takes place when the configured step width of these values is not immediately taken into account (see example above: step width = 5; value "2" is transmitted, then value "0"). In this case, to ensure that the original starting value can be reset on resetting with a change to the adjustment direction, the first value jump is not equal to the preset step width (see example above: step width = 5; value "0" is transmitted, then values "2"; "7" etc.).
- i** The newly adjusted values are stored in RAM. After a device reset (bus voltage failure or ETS programming operation), the adjusted values are replaced by the values originally configured in the ETS.

Light scene extension

With a configuration as a light scene extension without a memory function, it is possible to recall a light scene, which is stored in an external bus subscriber (e.g. light scene pushbutton sensor) With a rising, falling or rising and falling flank, the light scene number configured in the ETS is immediately transmitted to the bus.

With a configuration as a light scene extension with a memory function, it is possible to generate a memory telegram according to the light scene to be transmitted. For this, the appropriate memory telegram is transmitted for a long signal according to the configured flank evaluation (pushbutton as NC contact or NO contact - not as switch!). In this case, the time for long actuation can be configured (but not to below 5 s). With short actuation < 1 s, the configured light scene number (without memory telegram) is transmitted. If the actuation last longer than 1 s but less than 5 s, no telegram is triggered.

In addition, there is the option of only transmitting a memory telegram without prior light scene recall. In this case, the parameter "Only memory function ?" must be set to "Yes".

Examples for a light scene extension with memory function (Figure 13):

- 1.) Only memory function = No
- 2.) Only memory function = Yes

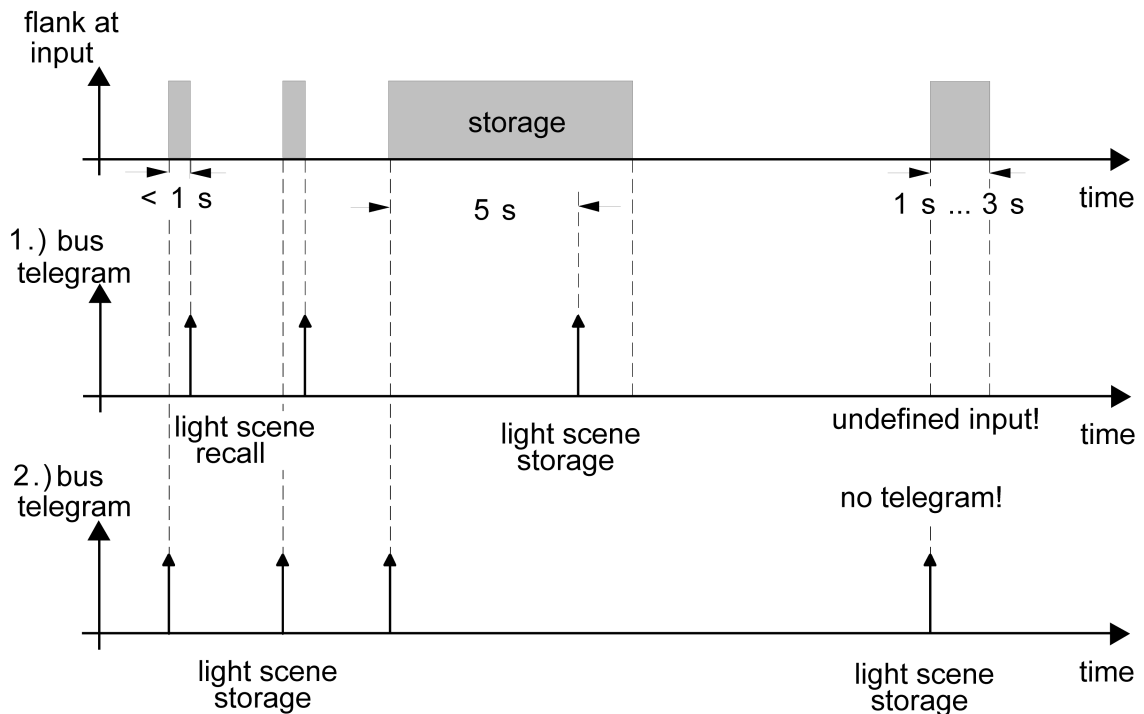

Figure 13: Example of scene storage

"Only memory function = No":

If a rising or falling flank is detected at the input (according to the configuration), the time recording operation begins. If actuation ceases during the first second, the appropriate light scene recall takes place immediately. If the signal length is longer, then the memory telegram is transmitted after 5 s.

"Only memory function = Yes":

The memory telegram is transmitted immediately after detection of the appropriate signal flank.

Behaviour on bus voltage return for value encoder and light scene extension

After a device reset (bus voltage return or ETS programming operation), the communication object of the value encoder or light scene extension can be initialised. For this, the "Behaviour on bus voltage return" parameter should be configured to the required reaction. The setting is dependent on the value encoder function and flank evaluation selected in the ETS. In the settings "Reaction as rising flank" or "Reaction as falling flank", telegrams are transmitted actively to the bus according to the configuration in the ETS. In the "Transmit current input status" setting, the device evaluates the static signal status of the input and, according to this, transmits the appropriately configured telegram to the bus (contact closed at the input = telegram as with rising flank; contact open at input = telegram as with falling flank). This setting can only be configured with "Transmit value on = rising and falling flank (switch)".

If, in the ETS, a delay is set for the extension inputs after bus voltage return, the device only transmits the telegrams when the delay has elapsed.

4.2.4.3.2 Disabling function for extension inputs

The extension inputs can be separately disabled via the bus using 1-bit objects. With the "Switching" function, it is possible to disable the two switching objects of an input independently of each other.

With an active disabling function, signal flanks at the input are ignored by the device related to the affected objects.

Each input or each switching object can execute a specific independent reaction at the beginning or end of a disable. This reaction is specified on the parameter page "Ix - disable" (x = 1, 2, 3) in the ETS and is dependent on the flank evaluation defined for the affected input. In so doing, it is possible to configure to "No reaction". Only in this case are dimming or Venetian blind control operations or value adjustments completed during an active disable and only then the input locked. In all other cases, the configured disabling command is executed immediately at the beginning of disabling.

In the "Transmit current input status" setting, the device evaluates the current static signal status of the input and, according to this, transmits the appropriately configured telegram to the bus (contact closed at the input = telegram as with rising flank; contact open at input = telegram as with falling flank).

A disabling function is activated or deactivated by the corresponding 1-bit object. The telegram polarity can be set in the ETS for each disabling object. The disabling object is always inactive after a device reset. Even with an inverted polarity "Disabling = 0 (Enabling = 1)", a "0" telegram must first be received after a reset until the appropriate disabling function is activated.

- i** Updates to disabling objects with the same telegram polarity (disabling -> disabling or enabling -> enabling) do not show a reaction.
- i** With cyclical transmission in the "Switching" function: during an active disable, cyclical transmission does not take place via the disabled input switching object. Cyclical transmission is continued immediately at the end of the disabling with the last object value written to the object, providing that the transmit criterion for cyclical transmission is fulfilled (transmit on ON, on OFF or on ON and OFF).

4.2.4.4 Channel-oriented functions for the Venetian blind output

4.2.4.4.1 General settings

Operating mode

Output 1 of the device can be independently configured for the drive type connected by defining the operating mode. The device permits controlling slatted Venetian blinds, roller shutters, awnings and also venting louvers. Depending on the preset operating mode, the ETS adapts the parameters and communication objects for all functions of an output.

For example, in the "Venetian blind" operation mode, there are also parameters and objects for slat control. There is no slat control in the "Roller shutter / awning" operating mode, but a fabric stretching function can be configured for awning use. In the "Venting louver" operation mode, a distinction is made between the "Closing" and "Opening" drive movements, instead of an up or down movement for Venetian blinds or roller shutters.

In this documentation, Venetian blinds, roller shutters or awnings are also designated with the term "blind", if the text does not explicitly refer to a particular function (e.g. slat control).

In all modes it is possible to specify positions.

Presetting the operating mode

The parameter "Operating mode" exists on the parameter page "O1 - General".

- Select the required operating mode in the "Operating mode" parameter.
- i** The "Operating mode" parameter has an influence on many channel-oriented parameters and communication objects. When the operating mode is changed in the ETS, the parameters are adapted dynamically so that settings already made or links between group addresses can be reset. For this reason, the required operating mode should be configured at the beginning of the channel-oriented device configuration.
- i** Venting louvers must be connected to the outputs in such a way that they are opened in the movement direction "up - ▲" and closed in the movement direction "down - ▼".
- i** An awning travels upwards when it is rolled up.

Behaviour in case of bus voltage failure, after bus voltage return or after programming with the ETS

The preferred contact positions of output 1 after bus voltage return or after ETS programming can be set. Since the device is equipped with bistable relays, the relay switching state at bus voltage failure can be defined as well.

Presetting the behaviour after ETS programming

The parameter "Behaviour after ETS programming operation" can be preset on the parameter page "O1 - General". This parameter can be used to configure the relay behaviour of the output irrespective of the behaviour after a bus or mains voltage return.

Depending on the selected operating mode, the ETS adapts the designations of the parameter settings ("raising" ↔ "opening the louver" / "lowering" ↔ "closing the louver").

- Set the parameter to "stop".
After programming with the ETS, the device switches the relays of the output to the "stop" position. A drive movement, if any, will be interrupted.
- Set the parameter to "raising" or "opening the louver".
After programming with the ETS, the device raises the blind or opens the venting louver.
- Set the parameter to "lowering" or "closing the louver".
After programming with the ETS, the device lowers blind or closes the venting louver.

- i** At the beginning of each ETS programming cycle, the device always executes a "stop" command for the output.
- i** The "Behaviour after ETS programming" as configured will be executed after every ETS application or parameter download. A simple download of the physical address alone or partial programming of only the group addresses has the effect that this parameter is disregarded and that the configured "Behaviour after bus or mains voltage return" will be executed instead.
- i** After programming with the ETS, the safety functions, the forced positions and the sun protection function are always deactivated.

Presetting the behaviour in case of bus voltage failure

The parameter "Behaviour in case of bus voltage failure" can be preset under "O1 - General". The parameter defines the behaviour of the shutter output if only the bus voltage fails. Depending on the selected operating mode, the ETS adapts the designations of the parameter settings ("raising" ↔ "opening the louver" / "lowering" ↔ "closing the louver").

- Set the parameter to "stop".
In case of bus voltage failure, the device switches the relays of the output to the "stop" position. A drive movement, if any, will be interrupted.
- Set the parameter to "no reaction".
In the event of bus voltage failure, the relay of the output shows no reaction. Movements still in progress at the time of failure will still be completed as long as the mains voltage is still on.
- i** As the device is supplied solely by the bus voltage, it is not ready for operation between a bus failure and the setting of the appropriate reaction up to the bus voltage return.
- i** When there is a bus voltage failure, the current position data is permanently saved internally, so that these position values can be accurately repositioned after bus voltage return, should this be configured. The data is stored before the configured reaction for bus voltage failures takes place and only if the bus voltage has been available before without interruption for at least 20 seconds after the last reset (storage capacitors sufficiently charged for storage purposes). The data will not be stored, if the position data is unknown.

The following rules apply for the position data to be stored:

The current blind, slat and louver positions are stored. With Venetian blinds, the height to be stored is always referred to a slat position of 100 % (cf. "Calculating the slat position"). Positions temporarily approached will be stored also for those outputs that are involved in a travel movement at the time of data storage. On account of the fact that position data is stored as integer percentage values (0...100), a minor deviation from the positions reported back later during bus voltage return (number range 0..255) cannot be avoided.

In case of ETS programming, the saved position data is not lost.

- i** In case of bus voltage failure, the current states of the forced position control or – if configured – also the slat offsets of the sun protection positions are stored as well.

Setting the behaviour after bus voltage return

The parameter "Behaviour after bus voltage return" can be preset on parameter page "O1 - General".

Depending on the selected operating mode, the ETS adapts the designations of the parameter settings ("raising" ↔ "opening the louver" / "lowering" ↔ "closing the louver").

- Set the parameter to "stop".
In case of bus voltage return, the device switches the relays of the output to the "stop" position. A drive movement, if any, will be interrupted.
- Set the parameter to "raising" or "opening the louver".
After bus voltage return, the device raises the blind or opens the venting louver.

- Set the parameter to "lowering" or "closing the louver".
After bus voltage return, the device lowers the blind or closes the venting louver.
- Set the parameter to "position on bus failure".
After bus voltage return, the forced position value (including slat position for Venetian blinds) last selected and internally stored before bus voltage failure will be tracked. Before the positioning movement, the device executes a reference movement.
- Set the parameter to "position approach".
In case of bus voltage return, the connected drive can approach a position (0...100 %) specified by further parameters. If Venetian blinds are controlled with the device, the slats can be positioned independently. Before the positioning movement, the device executes a reference movement.
- ⓘ "Position on bus failure" setting: If no position values could be stored in case of bus failure because the position data was unknown (no reference movement executed), the device shows no reaction with this configuration either.
- ⓘ The forced position communication object can be initialised separately after bus voltage return. This has an effect on the reaction of the output when the forced position is activated.
The configured "Behaviour on bus voltage return" is only executed when no forced position after a bus voltage return is activated.
- ⓘ The device only executes the configured "Behaviour on bus voltage return" only if the last ETS programming of the application or of the parameters ended at least approx. 20 s prior to switching on the bus voltage. Otherwise ($T_{ETS} < 20$ s), the "Behaviour after ETS programming" will be adopted also in case of bus voltage return.

4.2.4.4.2 Movement time settings

Determining and configuring short time and long time operation

Short time operation (Step) permits adjusting the slat tilting angle of a blind or the 'slit opening width' of a roller shutter. In most cases, short-time operation is activated by pressing a Venetian blind pushbutton sensor permitting manual intervention in the blind controller. When the device receives a short time command while the Venetian blind, roller shutter, awning or louver is in motion, the drive movement is stopped immediately by the device.

A long-time operation (Move) is determined by the movement time of the connected Venetian blind, roller shutter/awning or louver and must therefore not be preset separately. The movement time must be measured 'manually' and entered into the ETS parameters. The control of an output by means of a long time or a short time telegram is also designated as 'direct operation'.

To ensure that the curtain or the louver has definitely reached its end position at the end of long time operation, the device always prolongs the long time movement by 20 % of the configured or learnt movement time.

The configured travelling time extension will moreover be taken into account by the device for all upward movements or all movements into the open position as the drive motors are then generally not as fast due to the weight of the blind or external physical influences (e.g. temperature, wind, etc.). Thus, it is ensured that the upper end position is always reached even in case of uninterrupted long time travel movements.

- i** A long time or a short time operation can be retriggered by a new incoming long time or short time telegram.
- i** A drive movement activated by a safety function is always a long time operation. The "raising" or "lowering" commands configured in the ETS will equally activate the long time operation.

Presetting the short time operation

The short time operation is configured independent of the movement time of the blind or of the louver. The project designer can specify in the ETS whether the output executes only a "stop" for a travel movement on reception of a short time telegram or whether the output is activated for a specific duration.

- Set the parameter "Short time operation" on parameter page "O1 - Time settings" to "Yes".
The device activates the output for the time specified under "Duration of short time operation" when a short time telegram is received and when the output is not in the process of executing a movement. If the output is executing a travel movement at the time of telegram reception, the output will only just stop.
- Set the "Short time operation" parameter to "No (only stop)".
The device will only stop the output on reception of a short time telegram, if the output is in the process of executing a movement. There will be no reaction, if the output is not executing a movement at the time of telegram reception.
- i** The configured "Duration of short time operation" should correspond, for a Venetian blind, to approx. $\frac{1}{4}$ of the complete slat moving time and for a roller shutter to the full time needed for opening the roller shutter segments.
- i** The short time operation is always executed without a movement time extension.

Determining and configuring movement times

For computing positions and also for executing long time operation, the device needs the exact movement time of the connected Venetian blind, roller shutter/awning or louver. The movement time must be measured 'manually' and entered into the ETS configuration. It is important to determine the movement time accurately to permit positions to be approached with good precision. Therefore, it is recommended to make several time measurements and to take the average of these values before entering them into the corresponding parameter. The movement time corresponds to the duration of a drive movement from the completely open position

(upper end position / awning rolled up) to the completely closed position (lower end position / awning completely unrolled). Not vice-versa! The movement times are to be determined as a function of the different types of drives.

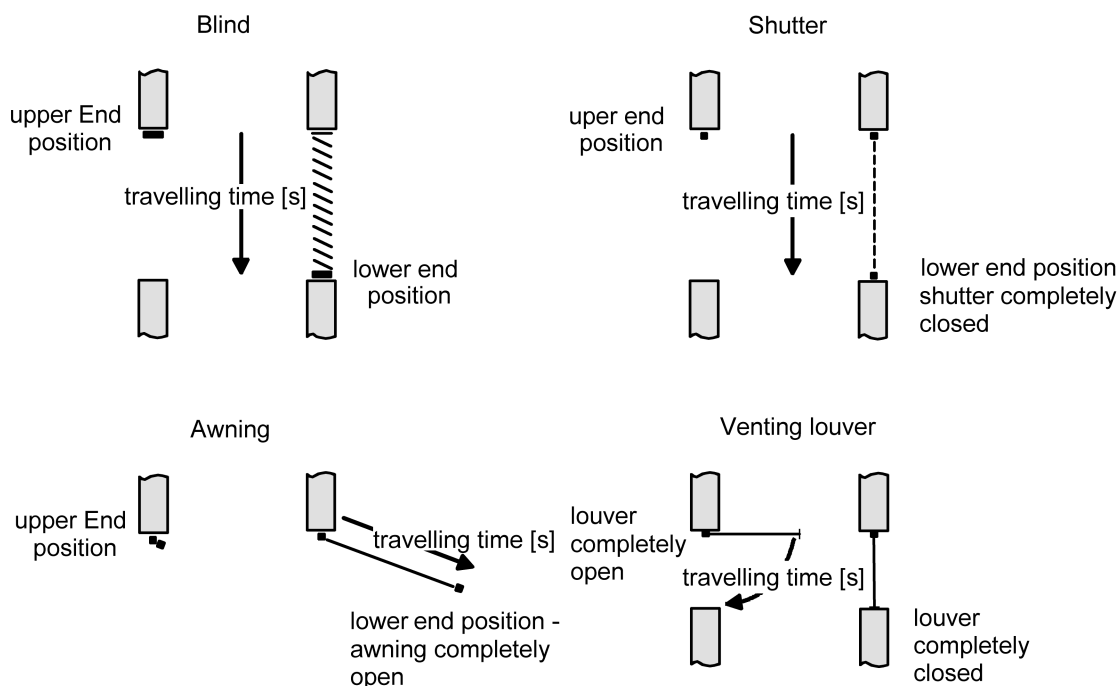

Figure 14: Determining the movement time according to the drive type

Setting the movement time of Venetian blinds, roller shutters/awnings and louvers

The measurement of the movement time is described in detail in chapter "Commissioning".

- Enter the exact movement times determined in the course of the commissioning procedure into the parameters "Venetian blind movement time" or "Roller shutter/awning movement time" or "Venting louver movement time" on parameter page "O1 – Times". The maximum travelling time is '59 minutes 59 seconds'. The working principle does not allow longer movement times.
- i** The configured movement time extension will also be taken into account by the device for all upward movement or all movements into the open position as the drive motors are then generally not as fast due to the weight of the blind or external physical influences (e.g. temperature, wind, etc.).

Determining and configuring the slat moving time (only with slatted Venetian blinds)

If Venetian blinds are controlled, the slats can be positioned independently. To enable the device to compute slat positions and to report them back to the bus, it is necessary that the device gets precise information about the time required for a slat rotation. The slat moving time must in each case be determined and configured 'manually'.

The device is designed in such a way that it can control single-motor Venetian blind drives without a working position. In this drive mode, the slats are directly adjusted by way of mechanical linkage when the height of the Venetian blind is changed. The device assumes that the slats are completely closed when the Venetian blind moves downwards. The actuator assumes that the slats are completely closed when the Venetian blind moves downwards (Figure 15). These Venetian blinds are the most common type on the market.

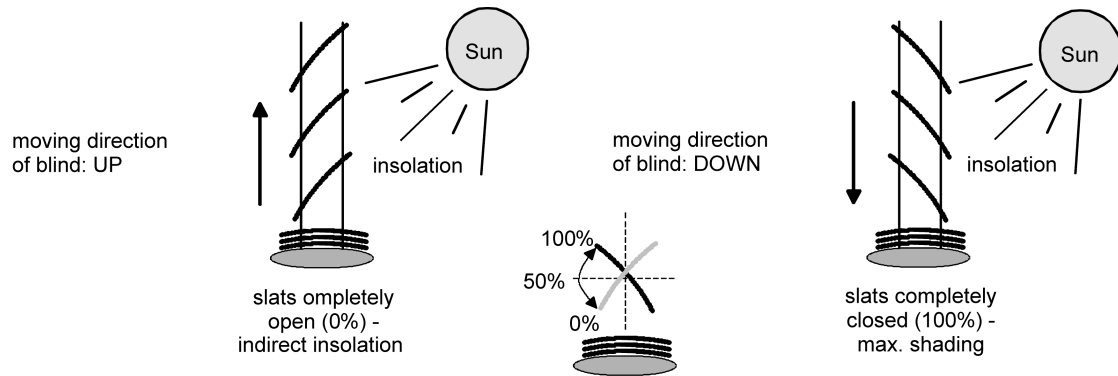

Figure 15: Type 1 - Slatted Venetian blinds with oblique slat position in both travel directions

There are also single-motor Venetian blind systems without a working position the slats of which are horizontal during an upward travel and oblique during a downward travel. Such Venetian blind types can also be connected to the device in which case a completely open slat position corresponds to the slats in horizontal position.

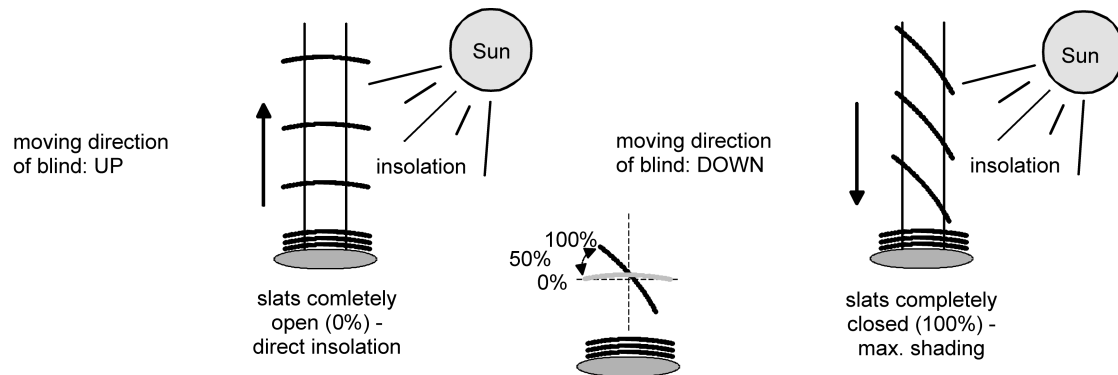

Figure 16: Type 2 - Slatted Venetian blinds with oblique and horizontal slat position

Presetting the slat moving time

The measurement of the slat moving time is described in detail in chapter "Commissioning".

- Set the parameter "Slat moving time" on parameter page "O1 - Times" exactly to the value determined in the course of the commissioning procedure.

i The slat moving time must be shorter than the preset or learnt blind travelling time.

i The configured or measured movement time extension will also be taken into account when slats are moved into the completely open position (upward movement).

Determining and configuring the movement time extension and the switchover time

When moving upwards, Venetian blinds, roller shutters or awnings have a tendency of moving more slowly due to their own weight or to external physical influences (e.g. temperature, wind, etc.). The same applies to venting louvers where opening may take longer than closing.

For this reason, the device takes the configured travelling time extension into account when moving upwards or when opening louvers. The extension is computed as a percentage of the difference of the movement times in both directions.

The movement time extension should be determined separately during commissioning and entered into the ETS configuration.

The measurement of the movement time extension is described in detail in chapter "Commissioning".

Example for determining the movement time extension:

- "Movement time" previously determined and configured: $T_{OU} = 20$ seconds,"
- Time determined for movement from lower to upper end position: $T_{UO} = 22$ seconds,
- Calculated supplementary movement time: $T_{UO} - T_{OU} = 2$ seconds -> 2 seconds out of 20 seconds are 10 %,
- Movement time extension to be configured: 10 %.

To protect the drive motors from irreparable damage, a fixed pause during movement direction switchover can be configured. During the pause, no movement direction is active ("stop"). The necessary parameter value can normally be found in the technical documents of the drive motor used. The switchover time is accounted for in every state of operation of the device.

Presetting the movement time extension

- Enter the determined movement time extension (by rounding up the determined extension value) into the parameter "Movement time extension for upward movement" on parameter page "O1 - General".

Presetting the switchover time for movement direction changes

- Set the parameter "Switchover time for travel direction change" on parameter page "O1 - Times" to the required switchover interval.
- i** In the as-delivered state of the device, the switchover time is generally preset to 1 s.

4.2.4.4.3 Positioning and feedback settings

Computing the blind height or the louver position

The device has a easy-to-use and accurate positioning function. The device calculates the current position of the connected Venetian blind, roller shutter, awning or louver whenever these elements are adjusted either by manual or bus control. The calculated position value is a measure of the height of the blind or of the opening width of the venting louver (Figure 17).

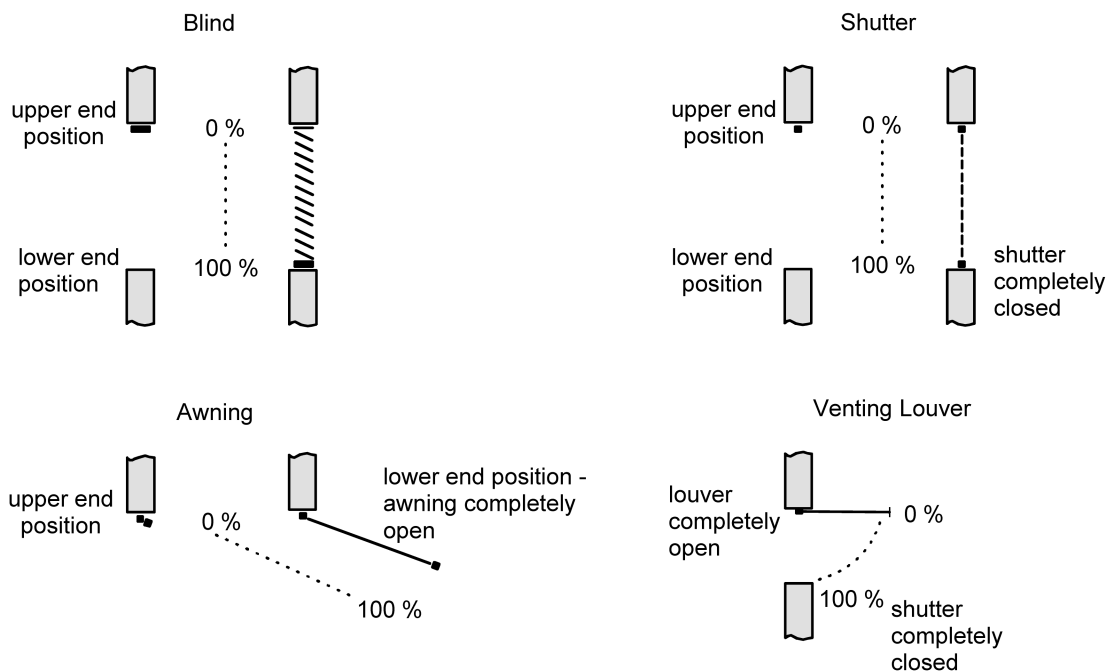

Figure 17: Positions defined as a function of the type of movement

The device derives the positions from the configured travelling time since conventional drives do not provide feedback about their positions. Thus, the travelling time configured in the ETS is the reference for all position approaches and of basic importance for the accuracy of the position calculations. For this reason, the travelling time should be determined with great accuracy in order to achieve the best possible positioning results.

For positioning purposes, the device calculates the movement time required as a function of the current position.

Example 1...

The roller shutter connected to the certain output has an overall travelling time of 20 s. The roller shutter is in its upper end position (0 %). It is to be positioned at 25 %. The device calculates the movement time required for approaching the desired position:
 $20 \text{ s} \times 0.25_{(25 \%)} = 5 \text{ s}$. The output will then lower the roller shutter for 5 s and thus position the blind at height of 25 %.

Example 2...

The shutter connected to the certain output has an overall travelling time of 20 s. The shutter is in the 75 % position. It is to be positioned at 75 %. The difference between the positions is 50 %. The device calculates the movement time required for bridging the difference between the positions:
 $20 \text{ s} \times 0.5_{(50 \%)} = 10 \text{ s}$. The output will then lower the roller shutter for 10 s and thus position the blind at height of 75 %.

With all the upward movements, the configured movement time extension is automatically added to the calculated movement time.

Example 3...

The roller shutter connected to the certain output has an overall movement time of 20 s. The roller shutter is in the 75 % position. It is to be positioned at 25 %. The difference between the positions is 50 %. The device calculates the unextended movement time required for bridging the difference between the positions:

$20 \text{ s} \times 0.5_{(50\%)} = 10 \text{ s}$. Taking the movement time extension into account (e.g. 10 %), the actual raising time is: $10 \text{ s} \times ((100\% + 10\%_{(\text{extension})}) : 100\%) = 10 \text{ s} \times 1.1 = 11 \text{ s}$. The output will then raise the roller shutter for 11 s and thus position it at a blind height of 25 %.

When the lower or upper end positions (0 % or 100 %) are approached, the movement time is always 20 % longer than the overall movement time.

Example 4...

The shutter connected to the certain output has an overall travelling time of 20 s. The shutter is in the 75 % position. It is to be positioned at 100 %. The difference between the positions is 50 %. The device calculates the movement time required for bridging the difference between the positions: $20 \text{ s} \times 0.5_{(50\%)} = 10 \text{ s}$. As the movement is a limit position movement, the device adds 20 % of the total movement time:

$10 \text{ s} + (20\% : 100\%) \cdot 20 \text{ s} = 14 \text{ s}$. The output will then lower the roller shutter for 14 s and thus position it safely at a blind height of 100 %.

Example 5:

The roller shutter connected to the certain output has an overall movement time of 20 s. The roller shutter is in the 50 % position. It is to be positioned at 0 %. The difference between the positions is 50 %. The device calculates the unextended movement time required for bridging the difference between the positions: $20 \text{ s} \times 0.5_{(50\%)} = 10 \text{ s}$. As the movement is a limit position movement, the device also adds 20 % of the total movement time:

$10 \text{ s} + (20\% : 100\%) \cdot 20 \text{ s} = 14 \text{ s}$.

Taking the movement time extension into account (e.g. 10 %), the actual raising time is:

$10 \text{ s} \times ((100\% + 10\%_{(\text{extension})}) : 100\%) = 10 \text{ s} \times 1.1 = 15.4 \text{ s}$. The output will then raise the roller shutter for 15.4 s and thus position safely at 0 %.

- i** The device executes position approaches only if a new position deviating from the current position is preset.
- i** The device stores the blind or louver positions temporarily. The device can approach newly preset blind or louver positions only if the current positions are known. For this purpose, each output must be given the opportunity to synchronise itself whenever the supply voltage is switched on or after every ETS programming operation (physical address, application program, partial download). Synchronisation is performed with the help of a reference movement (cf. "reference movement").
- i** Position approaches in progress will be aborted in case of bus voltage failure. In case of bus voltage failure, the configured behaviour will be executed.

Calculating the slat position (only with Venetian blinds)

In the "Venetian blind" operating mode, the device always calculates the slat position so that the opening angle and thus the amount of 'light admitted into the room' by the Venetian blind can be adjusted. A new position approach by a Venetian blind will always be followed by a positioning movement of the slats. Thus, the slat positions last selected will be tracked or readjusted to a new value if a position change has taken place.

In case of single-motor Venetian blind systems without a working position, the slats will be readjusted directly by a change of the Venetian blind height. For this reason, an adjustment of the slat position will always have an influence on the position of the Venetian blind itself (Figure 18).

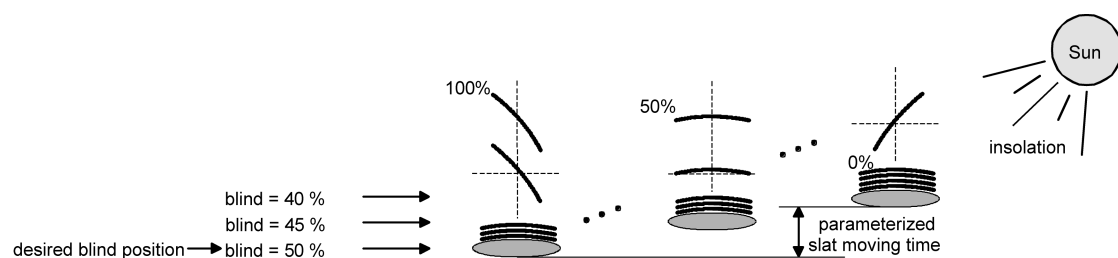

Figure 18: Example of slat positioning affecting the position of the Venetian blind (typical of slat type 1; analogous reaction for type 2)

Since a preset slat position is to remain constant until the next change, the device will not change the height of the Venetian blind, if the calculated movement time required for a change of position lies within the configured slat moving time.

Similarly, the device accounts for the ratio of the moving times of slat and Venetian blind and – in case of slat position changes – always recalculates the resulting Venetian blind position. If the position feedback objects are used (cf. "Position feedback"), the device transmits the Venetian blind positions changed by the adaptation also to the bus.

Example (Figure 18)...

The Venetian blind position is preset to 50 %. A change of the slat angle (100 %...0 %) initiates the calculation of a new Venetian blind position which is also tracked in the position feedback objects. If the device is to approach a new Venetian blind position of, for example, 47 % in this case, the device will not perform a movement as the calculated travelling time lies within the configured slat moving time and therefore coincides with the slat movement. A change of the Venetian blind position to 55 % in this case triggers a Venetian blind movement as the change does not lie within the slat movement (0 to 100 %).

In each position operation, the Venetian blind setpoint position refers to a slat position of 100 %. In the event of a slat repositioning movement (0 to 100 %), the system will therefore report a Venetian blind position below the desired position.

Exception: The Venetian blind setpoint position of 0 % (upper end position) is assigned to the slat position of 0 %. The readjustment of the slat position will result also in this case in a change of the Venetian blind height (brief downward movement). Only in this case will the actuator report back a Venetian blind position above the Venetian blind setpoint position (Figure 19). With slat type 1, the slats are generally horizontal when the Venetian blind is in its upper end position. For this reason, the calculated slat position with a slat type 1 corresponds to the actual opening angle only after the first slat is completely extended (100%).

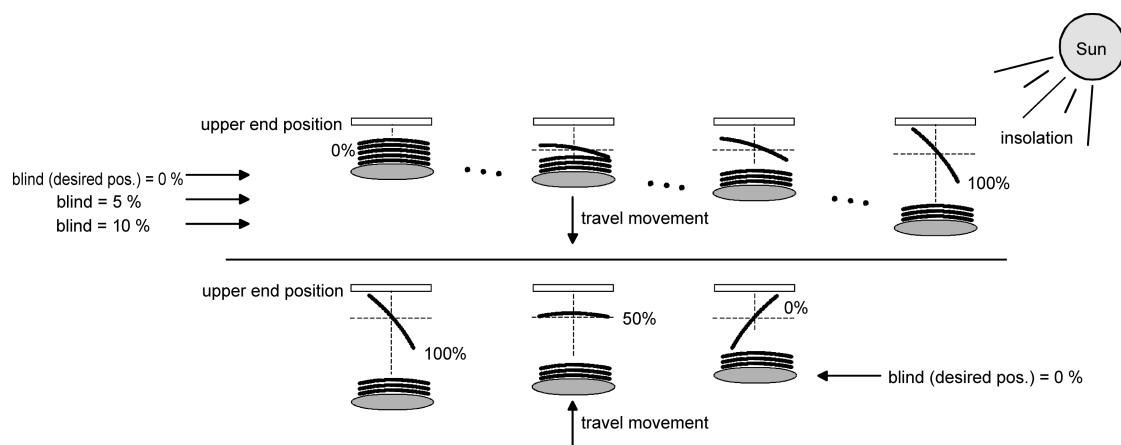

Figure 19: Example of slat positioning with the Venetian blind in upper end position (typical of slat type 1)

Example (Figure 19)...

The Venetian blind position is preset to 0 %. After an extended movement, the Venetian blind is safely in the upper end position. A change of the slat angle (0 %...100 %) initiates the calculation of a new Venetian blind position which is also tracked in the position feedback objects. If the device is to approach a new Venetian blind position of, for example, 5 % in this case, the device will not perform a movement as the calculated travelling time lies within the configured slat moving time and therefore coincides with the slat movement. A change of the Venetian blind position to 15 % in this case triggers a Venetian blind movement as the change does not lie within the slat movement (0 to 100 %).

- i** The device executes slat position adjustments only if a new position deviating from the current slat position is preset.

- i** The device stores the slat positions temporarily. The device can approach newly preset slat positions only if the current position is known. For this purpose, the output must be given the opportunity to synchronise itself whenever the supply voltage is switched on or after every ETS programming run (physical address, application program, partial download). The synchronisation is performed with the help of a reference movement for the slat or the Venetian blind (cf. "reference movement").
- i** A change of the Venetian blind height will always result in a change of the slat position. After reactivation of the supply voltage of after ETS programming, the device will in this case generally move the slats into the 100 % position, if no position has been preset for the slats.
- i** The smaller the ratio between slat moving time and Venetian blind travelling time, the more precise the position approaches and the less marked the influence of the slat angle adjustment on the height of the Venetian blind.

Reference movement

After ETS programming (physical address, application program, partial download) or after bus voltage failure all current position data are unknown. Before the device can approach new positions after bus voltage return or after programming, the positioning system must at first be calibrated. A position calibration is possible by executing the reference movement. A reference movement is the time required for a movement into the upper end position increased by 20 % and additionally by the configured movement time extension (Figure 20). A reference movement is not retriggerable.

Reference movements can be executed by the following commands...

- Uninterrupted long time operation (including also a terminated safety movement) into the upper end position activated via the corresponding communication object,
- Positioning to the 0 % position.

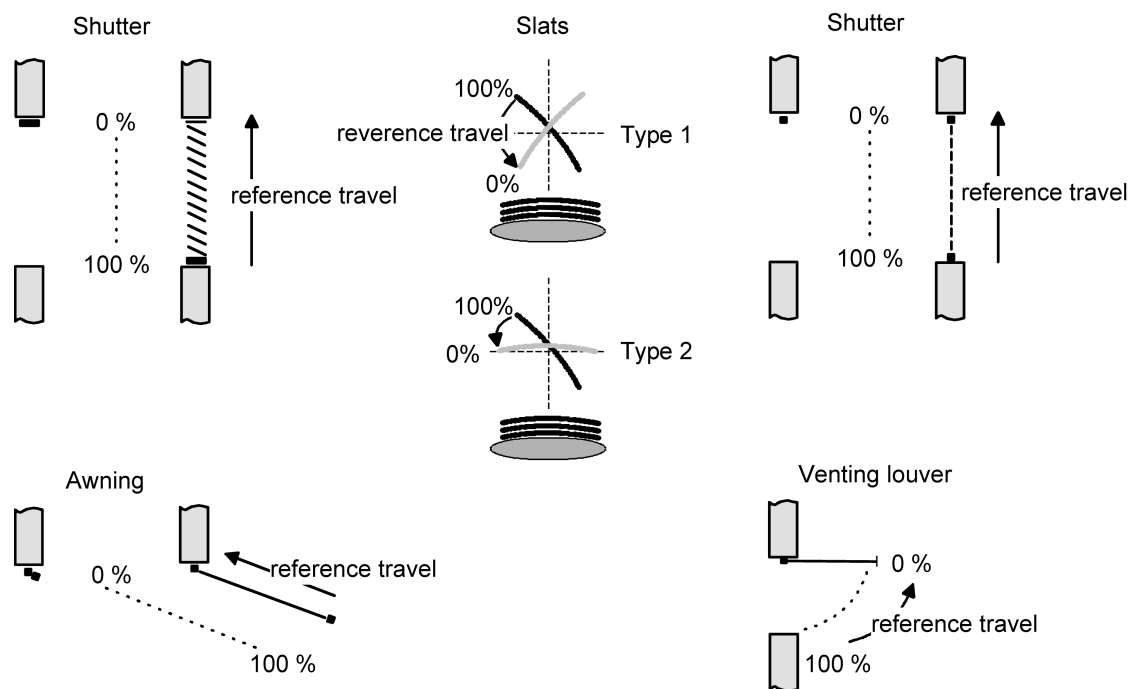

Figure 20: Reference movement

In the event of slat positioning via the corresponding communication objects after bus voltage return or after programming, a slat reference movement becomes necessary if the Venetian blind has not been moved beforehand in the up or down directions for at least the configured slat moving time. During a slat reference movement, the device always moves the slats for the

configured slat moving time into the completely open position (0 %) and then to the desired position. The slat position is also considered as calibrated when the Venetian blind has been moved by a long-time command in the up or down direction during at least the configured slat moving time.

- i** A terminated reference movement of the Venetian blind will also calibrate the slat position.
- i** If the reference movement is interrupted for instance by a short-time operation, the position is still unknown as before.
- i** A long-time travel into the lower end position activated via the corresponding communication object also calibrates the reference position.
- i** With the sun protection function it is moreover possible to force the actuator to perform a reference movement before each sun protection travel even if the positions are known. Thus, it is ensured that in case of sun protection the configured sun protection position is always precisely approached even after repeated position approaches.
- i** Using the connected drives frequently for position approaches (for instance several times a day) can result after some time in positioning inaccuracies. These deviations from the setpoint position are mostly due to external physical influences. To achieve accurate positioning in operation it is recommended to perform the reference movement at least once every day. This can be achieved for instance by a central raising command transmitted to the long-time object.

Presetting the position

The following ways of presetting positions can be distinguished...

- Direct positioning via the positioning objects (direct operation),
- Positioning by activating the sun protection function,
- Positioning using the response to bus voltage return,
- Positioning by a scene recall.

Positioning via the positioning objects:

Every Venetian blind, roller shutter, awning or louver can be positioned directly via the "Position..." object separate for each output. An independent positioning object exists for each of the slats. The position approached is always the position last received. The device does not show a reaction when the set or approached position value is received multiple times in succession.

Like the operation via short time, long time or scene recall, this form of control is also designated as 'direct operation'. Positioning via the objects therefore has the same priority. A position approach effected by the communication objects can be interrupted at any time by a short- or long-time or by a scene recall. Direct operation can be overridden by a function with a higher priority, e.g. forced position, safety or also sun protection (configurable).

The position telegrams must conform to the 1-byte data format as per KNX datapoint type 5.001 (scaling). The device converts the value received (0...255) linearly into a position (0...100 %) (see the table 4).

Received value (0...255)	Position derived from value (0...100 %)
0	0 % (upper end position / slat or louver opened)
↓	↓ (all intermediate values rounded off to 1 % increments)
255	100 % lower end position / slat or louver closed)

Table 4: Data format of positioning objects with conversion into percentage position values

It is possible that new positioning telegrams are being received while a position approach is in progress. In this case, the device immediately reverses the direction of travel, if the new position to be approached lies in the opposite direction.

If a slat positioning command is received during a running Venetian blind position approach, the device finishes first the Venetian blind position approach before positioning the slat. If a

Venetian blind positioning command is received during a slat positioning movement, the device interrupts the slat positioning movement and approaches the new Venetian blind position. The device only executes the most recently received slat positioning command after this.

In case of Venetian blind positioning, slat positioning will always be executed later. After switching on the bus voltage or after programming with the ETS, it may be the case that the slat position is unknown, if no long time command for the upward or downward movement with a duration of at least the configured slat moving time has been received or no slat positioning has taken place (no slat reference movement). In this case, the slat is moved during a Venetian blind position approach into the completely closed position (100 %). The slat position is then considered as calibrated.

- i** Optionally, the sun protection function offers the possibility of receiving the instruction of the blind height, venting louver or slat position to be adopted during sunshine via separate communication objects and to preset these values variably. This form of variable position preset in the sun protection function is identical to presetting the positions via communication objects in direct operation. The priority of the incoming telegrams in direct operation with the sun protection activated can be additionally configured in the ETS.

Positioning by the sun protection function, the behaviour after bus voltage return or by a scene recall:

In case of the device functions mentioned, the positions to be approached are configured directly in the ETS depending on the operating mode. The position values can be specified between 0 % and 100 % in 1 % increments.

With Venetian blinds, the height of the Venetian blind is positioned first in these cases. The configured slat position is adjusted only thereafter.

- i** Important notes for all positioning movements: Using the connected drives frequently for position approaches (for instance several times a day) can result after some time in positioning inaccuracies. These deviations from the setpoint position are mostly due to external physical influences. To achieve accurate positioning in operation it is recommended to perform the reference movement at least once every day. This can be achieved for instance by a central raising command transmitted to the long time object.

Position feedback messages

In addition to presetting positions via positioning objects, the device can track the current positions values via separate feedback objects and also transmit them to the bus, if the bus voltage is on. Thus, the preset setpoint position can be distinguished from the true actual position of the drives activated.

The following feedback telegrams can be preset depending on the configured operating mode...

- Feedback (1 byte) of the Venetian blind, roller shutter, awning or venting louver position,
- Feedback (1 byte) of the slat position (only with Venetian blinds).

The individual position feedback messages can be enabled in the ETS independent of one another and have communication objects of their own.

For each movement, the device calculates the current position and tracks it in the position feedback objects. The positions are tracked and the feedback objects updated even when the output has been activated via short time or long time telegrams on condition that the bus voltage is on.

The feedback objects are updated after the following events...

- At the end of a drive movement – including a slat positioning movement in a Venetian blind – when the drive stops and when the new position is reached,
- With a movement to an end position already at the time the end position is theoretically reached, i.e. before the 20 % extension and the movement time extension have elapsed.

The feedback objects are not updated, if the position last reported back has not changed after a movement (for instance, when the Venetian blind is repositioned, the unchanged slat position will not be reported back a second time).

The device cannot calculate a feedback position, if the current position data after switch-on of the bus voltage or after ETS programming are still unknown. In these cases, the system must first perform a reference movement (cf. "reference movement") so that the position can be calibrated. In case of unknown positions, the device automatically performs reference movements, if new positions are preset and if these positions are to be approached. As long as a position is unknown, the value of the feedback objects is "0".

Presetting position feedback for Venetian blind, roller shutter, awning or venting louver positions

The feedback functions can be enabled and programmed. When feedback is enabled, the ETS adapts the parameter texts depending on the preset operating mode ("Venetian blind position feedback", "Roller shutter/awning position feedback" or "Venting louver position feedback"). The feedback can be used as an active message object or as a passive status object. As an active signalling object, the position feedback information is transmitted to the bus whenever a position value changes. As a passive status object, there is no telegram transmission after a change. In this case, the object value must be read out. The ETS automatically sets the object communication flags required for proper functioning. In case of an actively transmitting signalling object, the current position can be transmitted to the bus after bus voltage return, if the position value differs from the one last transmitted. When the position data are known, the feedback telegram can in this case be transmitted with a time delay to reduce the bus load, with the delay being preset globally for all outputs in common (cf. "Delay after bus voltage return").

The feedback functions of an output must be enabled on parameter page "O1 - Enabled functions". Only then are the parameters for the feedback functions visible.

- Set the parameter "Venetian blind position feedback", "Roller shutter/awning position feedback" or "Venting louver position feedback" on parameter page "O1 - Feedbacks" to "feedback object is active signalling object".

The feedback object is enabled. The position value is transmitted as soon as it changes. No value will be actively transmitted, if the position is unknown.

- Set the parameter "Venetian blind position feedback", "Roller shutter/awning position feedback" or "Rückmeldung Lüftungsklappenposition" on parameter page "O1 - Feedbacks" to "feedback object is passive status object".

The feedback object is enabled. The position value will be transmitted in response only if the feedback object is read out from by the bus. If the position is unknown, a value of "0" will be reported back after readout.

The feedback must be set as actively transmitting.

- If a time delay after bus voltage return should be necessary, the parameter "Time delay for feedback after bus voltage return" on parameter page "O1 - Feedbacks" must be set to "yes".

The position feedback will be transmitted with a delay after bus voltage return. After the end of the time delay, the position last adjusted statically will be transmitted to the bus. No feedback telegram is transmitted during a running delay, even if a position value changes during this delay.

Presetting the position feedback for slat positions (only with Venetian blinds)

The feedback for the slat positions can be enabled and programmed separately. As with the position feedback of the Venetian blind height, the feedback can be used as an active message object or as a passive status object.

In case of an actively transmitting signalling object, the current slat position can be transmitted

to the bus after bus voltage return, if the position value differs from the one last transmitted. When the position data is known, the feedback telegram can, in this case, be transmitted with a time delay to reduce the bus load, with the delay being preset for all feedback in common (cf. "Delay after bus voltage return").

The feedback functions of the output must be enabled on parameter page "O1 - Enabled functions". Only then are the parameters for the slat position feedback functions visible.

- Set the parameter "Slat position feedback" on parameter page "O1 - Feedbacks" to "feedback object is active signalling object".
The feedback object is enabled. The position value is transmitted as soon as it changes. No value will be actively transmitted, if the position is unknown.
- Set the parameter "Slat position feedback" to "feedback object is passive status object".
The feedback object is enabled. The position value will be transmitted in response only if the feedback object is read out from by the bus. If the position is unknown, a value of "0" will be reported back after readout.

The feedback must be set as actively transmitting.

- If a time delay after bus voltage return should be necessary, the parameter "Time delay for feedback after bus voltage return" on parameter page "O1 - Feedbacks" must be set to "yes".

The position feedback will be transmitted with a delay after bus voltage return. After the end of the time delay, the position last adjusted statically will be transmitted to the bus. During a running delay the affected feedback object is updated but no feedback is transmitted actively, even if a position value changes during this delay.

- i** Behaviour of the position feedback on voltage failure & return:
On bus voltage return, the current position data is always written to the feedback objects. The positions are then also transmitted to the bus, if the feedback objects transmit actively. If the position data is unknown, the feedback objects are initialised with "0" and not transmitted to the bus.
- i** In case of Venetian blind operation, any position change of the Venetian blind within the limits of the slat adjustment (0 to 100 %) does not launch a movement and therefore no change of the feedback position data either.

Unknown position feedback and drive movement

In addition to position data feedback, the device can also report back enlarged 1-bit status information messages and transmit them actively to the bus, if the bus voltage is on.

The following status feedback messages can be preset...

- Feedback of an invalid position,
- Drive movement feedback,

Feedback of an invalid position:

After switch-on of the supply voltage or after programming with the ETS, all the position data of an output is unknown. In this case – when the bus voltage is on – the device can update the feedback object "Invalid position"(object value "1") which will then signal that the object values of the 1-byte position feedback objects are invalid.

An invalid position feedback will be only be reversed (object value "0") after the position data for the Venetian blind, roller shutter, awning or venting louver have been calibrated by means of a reference movement. The calibration of the slat position in a Venetian blind alone will not result in the reversal of an 'invalid position' status message.

As an option, the object value of the status feedback message can be actively transmitted to the bus in case of a value change.

Drive movement feedback:

The device can report back via a separate 1-bit communication object whether the connected drive is moving, i.e. whether the output is supplying current for any of the movement directions. The feedback object has a value of "1" when current is flowing from the output to the drive.

Likewise, a "0" is written into the object if the output concerned remains in a stop position. In this case, the operation by which the output was activated (short time or long time operation, positioning, etc.) is of no importance.

As an option, the object value of the status feedback message can be actively transmitted to the bus in case of a value change.

The state of the feedback is only derived from the relay state of the device. This means that if a drive is blocked or already in its end position, the value reported back does not correspond to the actual state of the drive movement.

Setting feedback of an invalid position

The feedback of an invalid position can be enabled and programmed independently. When feedback is enabled, the ETS adapts the parameter texts depending on the preset operating mode ("Invalid Venetian blind position feedback",

"Invalid roller shutter/awning position feedback" or "Invalid venting louver position feedback").

The feedback can be used as an active message object or as a passive status object. As an active signalling object, the status feedback information is transmitted to the bus whenever a position value changes. As a passive status object, there is no telegram transmission after a change. In this case, the object value must be read out. The ETS automatically sets the object communication flags required for proper functioning.

If the object is an actively transmitting signalling object, the feedback telegram can be transmitted after bus voltage return with a time delay to reduce the bus load, with the delay being preset globally for all outputs in common (cf. "Delay after bus voltage return").

The feedback functions of the output must be enabled on parameter page "O1 - Enabled functions". Only then are the parameters for the feedback functions visible.

- Set the parameter "Invalid Venetian blind position feedback", "Invalid roller shutter/awning position feedback" or "Invalid venting louver position feedback" on parameter page "O1 - Feedbacks" to "feedback object is active signalling object".

The feedback object is enabled. A telegram is transmitted as soon as there is a change (e.g. after ETS programming, after switch-on of the supply voltage or after a reference movement).

- Set the parameter "Invalid Venetian blind position feedback", "Invalid roller shutter/awning position feedback" or "Invalid venting louver position feedback" on parameter page "O1 - Feedbacks" to "Feedback object is passive status object".

The feedback object is enabled. A telegram will be transmitted in response only if the feedback object is read out by the bus.

The feedback must be set as actively transmitting.

- If a time delay after bus voltage return should be necessary, the parameter "Time delay for feedback after bus voltage return" on parameter page "O1 - Feedbacks" must be set to "yes".

The feedback of an invalid position will be transmitted with a delay after bus voltage return. After the end of the time delay, the object value state last adjusted will be transmitted to the bus. No feedback telegram is transmitted during a running delay, even if a position value becomes known during this delay, for example through a reference movement.

- i** Automatic transmission after bus voltage return only takes place if there has been an internal change to the object state.

Setting drive movement feedback

The feedback of a drive movement can be enabled and programmed independently. The feedback can be used as an active message object or as a passive status object. As an active signalling object, the status feedback information is transmitted to the bus whenever a position value changes. As a passive status object, there is no telegram transmission after a change. In this case, the object value must be read out. The ETS automatically sets the object communication flags required for proper functioning.

If the object is an actively transmitting signalling object, the feedback telegram can be transmitted after bus voltage return with a time delay to reduce the bus load, with the delay being preset globally for all outputs in common (cf. "Delay after bus voltage return").

The feedback functions of an output must be enabled on parameter page "O1 - Enabled functions". Only then are the parameters for the feedback functions visible.

- Set the parameter "Drive movement feedback" on parameter page "O1 - Feedbacks" to "feedback object is active signalling object".
The feedback object is enabled. A telegram is transmitted when the connected drive starts moving or stops.
- Set the parameter "Drive movement feedback" on parameter page "O1 - Feedbacks" to "Feedback object is passive status object".
The feedback object is enabled. A telegram representing the current travel movement will be transmitted in response only if the feedback object is read out by the bus.

The feedback must be set as actively transmitting.

- If a time delay after bus voltage return should be necessary, the parameter "Time delay for feedback after bus voltage return" on parameter page "O1 - Feedbacks" must be set to "yes".
The feedback of a drive movement is transmitted after a delay on bus voltage return, for example, when the drive starts moving on account of the set behaviour after bus voltage return. After the end of the time delay, the object value state last adjusted will be transmitted to the bus. No feedback telegram is transmitted during a running delay, even if the drive stops or starts moving.

- ⓘ Automatic transmission only takes place after a bus voltage return when the drive starts moving on bus voltage return or if the bus failure has caused a change to the drive movement.

4.2.4.4.4 Safety function settings

Safety function

The device can handle up to five different safety functions:

3 x wind alarm, 1 x rain alarm, 1 x frost alarm. Each safety function has a communication object of its own so that the functions can be activated or deactivated independently of one another.

There are three different wind alarms available. These alarms can be used, for instance, to protect Venetian blinds or awnings on several building facades from wind and gusts. In addition or as an alternative, a rain alarm, for instance, as a protection for awnings, and a frost alarm as a protection against mechanical damage to lowered Venetian blinds in low temperatures can be activated and used. The telegram polarity of the safety objects is fixed:

"0" = No alarm / "1" = Alarm.

Usually, weather stations, which record temperature, wind speed and rain via the sensors, control the communication objects of the safety function.

The reactions at the beginning of an alarm message ("1" telegram) or at the end of an alarm message ("0" telegram) can be specified during the configuration in the ETS.

The communication objects for the safety alarms can be monitored for the arrival of cyclical telegrams. If there are no telegrams within a settable monitoring time, the device activates the safety movement for the output. The safety function is terminated as soon as a new "0" telegram is received.

For the wind alarms, the rain alarm and the frost alarm, different monitoring times between '1 minute' and '23 hours 59 minutes' can be separately selected in the ETS. A shared time is configured for the wind alarms. Each wind alarm has its own timer so that the wind objects are separately checked for telegram updates.

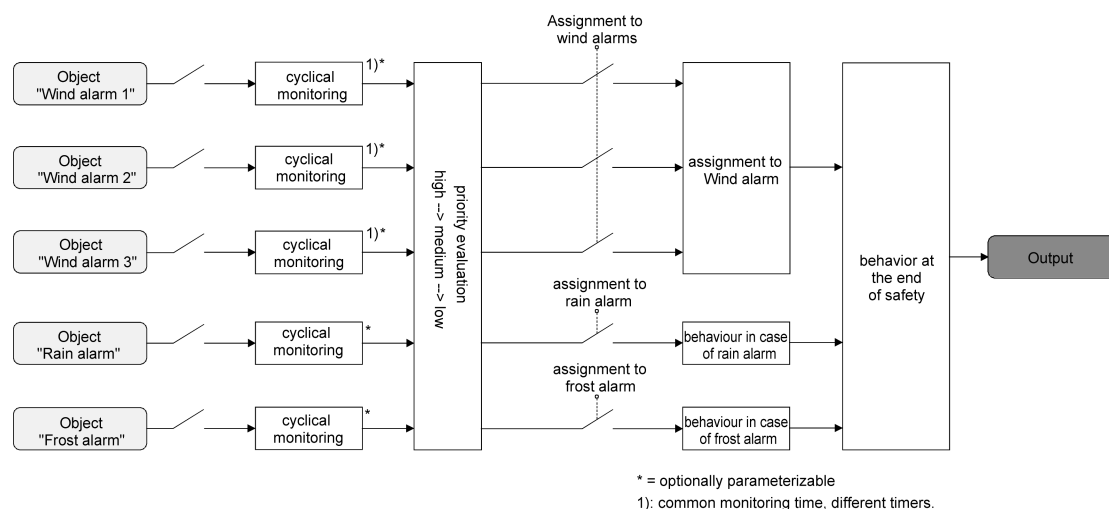

Figure 21: Function diagram of the safety function

The output can be assigned independently to the wind alarms, the rain alarm and the frost alarm. If the output is associated with several alarms, the preset priority decides which of the alarms will prevail and be executed. In so doing, an alarm with a higher priority overrides the alarms with the lower priorities. When safety alarm with the higher priority has ended, the safety alarm with the lower priority is executed on condition that it is active.

The order of priority of the wind alarms with respect to the frost alarm or to the rain alarm can be configured on the parameter page "O1 - Safety I". The three wind alarms have the same priority with respect to one another (logic OR). The last telegram update to the wind alarm objects decides which of the wind alarms will be executed. The wind alarm is completely deactivated only after all three objects are inactive ("0").

The output in the active safety alarm state is locked, i.e. the control of the output concerned via the bus by direct operation (short time, long time telegram, scenes, positioning) or by a sun protection function is prevented. Only a forced position has a higher priority so that this function may override a safety lock. At the end of a forced position, the safety reaction is re-executed if an assigned safety alarm is still active.

Presetting the safety priorities

If several safety alarms are assigned to the output, it is important to preset the priority of the incoming safety telegrams. In so doing, an alarm with a higher priority overrides the alarms with the lower priorities. When safety alarm with the higher priority has ended, the safety alarm with the lower priority is executed on condition that it is active.

The safety function for an output must be enabled on parameter page "O1 - Enabled functions. Only then are the parameters for the safety function visible.

- Set the "Priority of safety alarms" parameter on the "O1 - Safety I" parameter page in the required order of priority.
- i The three wind alarms have the same priority with respect to one another (logic OR). The last telegram update to the wind alarm objects decides which of the wind alarms will be executed. The wind alarm is completely deactivated only after all three objects are inactive ("0").

Presetting cyclical monitoring

If cyclical telegram monitoring of the safety objects is necessary, the individual monitoring functions must be activated separately. The monitoring functions must be enabled and the monitoring times preset on the "O1 - Safety II" parameter page.

The safety function for an output must be enabled on parameter page "O1 - Enabled functions. Only then are the parameters for the safety function visible.

- If monitoring of the wind alarms is to be activated, the parameter "Use wind alarm monitoring function ?" must be set to "yes".
The monitoring function for the wind alarm objects is now activated. As soon as the monitoring function is activated, telegrams must be transmitted cyclically to all enabled wind alarm objects. If only one of the wind alarm telegrams is missing within the monitoring period, the wind alarm reaction will be executed for the output.
- Specify the required monitoring time for the wind alarm objects in the "Wind alarm monitoring times" parameters.

- If the monitoring function is to be activated for a rain alarm, the parameter "Use rain alarm monitoring function ?" must be set to "yes".
The monitoring function for the rain alarm object is now activated. As soon as the monitoring function is activated, telegrams must be transmitted cyclically to the rain alarm object.
- Specify the required monitoring time for the rain alarm object in the "Rain alarm monitoring times" parameters.

- If the monitoring function is to be activated for a frost alarm, the parameter "Use frost alarm monitoring function ?" must be set to "yes".
The monitoring function for the frost alarm object is now activated. As soon as the monitoring function is activated, telegrams must be transmitted cyclically to the frost alarm object.
- Specify the required monitoring time for the frost alarm object in the "Frost alarm monitoring times" parameters.
- i The monitoring function for the wind alarms may only be activated, if at least one wind alarm has been activated on the "O1 - Safety I" page.

- i** The cycle time of the transmitters should be shorter than the monitoring time configured in the device in order to ensure that at least one telegram can be received during the monitoring time.

Assigning safety alarms

The individual safety alarms can be assigned separately to each output. The channels are assigned on parameter page "O1 - Safety III".

The safety function for an output must be enabled on parameter page "O1 - Enabled functions. Only then are the parameters for the safety function visible.

- If an assignment to the wind alarms is necessary, set the parameter "Assignment to wind alarms" to the wind alarms required.
The output is assigned to the specified wind alarms.
- If an assignment to the rain alarm is necessary, set the parameter "Assignment to rain alarm" to "yes".
The output is assigned to the rain alarm.
- If an assignment to the frost alarm is necessary, set the parameter "Assignment to frost alarm" to "yes".
The output is assigned to the frost alarm.

- i** If an output was assigned to the wind alarm and these alarms are not enabled on parameter page "O1 - Safety I", the assignment is without effect.

Presetting the behaviour at the beginning of a safety alarm

The behaviour of the output at the beginning of a safety alarm can be configured separately for each alarm (wind alarms in common, rain and frost alarms separately). The alarm behaviour is preset on parameter page "O1 - Safety III". At the beginning of a safety alarm, the device locks the output, i.e. control via the bus by direct operation (short time, long time telegram, scenes, positioning) or by a sun protection function is prevented.

Depending on the selected operating mode, the ETS adapts the designations of the parameter settings ("raising" ↔ "opening the louver" / "lowering" ↔ "closing the louver").

The safety function for an output must be enabled on parameter page "O1 - Enabled functions. Only then are the parameters for the safety function visible.

The behaviour in case of a safety alarm can only be adjusted, if the output has been assigned to the corresponding alarm. Since there is no difference between the alarm-dependent configurations, the selection of the parameters is described below only once.

- Set the parameter "Behaviour in case of ..." to "no reaction".
At the beginning of the alarm, the output is locked and the relay of the output shows no reaction. Any movements still in progress at this instant will still be completely finished.
- Set the parameter "Behaviour in case of ..." to "raising" or "opening the louver".
The device raises the blind or opens the venting louver at the beginning of the alarm and locks the output thereafter.
- Set the parameter "Behaviour in case of ..." to "lowering" or "closing the louver".
The device lowers the blind or closes the venting louver at the beginning of the alarm and locks the output thereafter.
- Set the parameter "Behaviour in case of ..." to "stop".
At the beginning of the alarm, the device switches the relays of the output to "stop" and locks the output. A drive movement, if any, will be interrupted.

- i** The safety movement time required by an output to move the drive into the end positions is determined by the "Movement time" parameter on parameter page "O1 - Times". Like the long-time operation, a safety movement is derived from the movement time. Downward movement: movement time + 20 %; Upward movement: movement time + 20 % + configured movement time extension. Safety movements are not retriggerable.
- i** Slats of blinds are not repositioned at the end of safety movements to end positions.

Presetting the behaviour at the end of all safety alarms

The device ends the safety interlock of the output only after all safety alarms assigned to the output have become inactive. Thereafter, the output shows the configured "Behaviour at the end of safety". The behaviour is configured on parameter page "O1 - Safety III" in common for all alarms.

Depending on the selected operating mode, the ETS adapts the designations of the parameter settings ("raising" ↔ "opening the louver" / "lowering" ↔ "closing the louver").

The safety function for an output must be enabled on parameter page "O1 - Enabled functions". Only then are the parameters for the safety function visible.

- Set the parameter "Behaviour at the end of safety" to "no reaction".
At the end of all safety alarms, the output is released and the relay of the output shows no reaction. Any movements still in progress at this instant will still be finished.
- Set the parameter "Behaviour at the end of safety" to "raising" or "opening the louver".
The device releases the output at the end of all safety alarms and raises the blind or opens the venting louver.
- Set the parameter "Behaviour at the end of safety" to "lowering" or "closing the louver".
The device releases the output at the end of all safety alarms and lowers or closes the venting louver.
- Set the parameter "Behaviour at the end of safety" to "stop".
At the end of all safety alarms, the output is released and the device switches the relays of the output to "stop". A drive movement, if any, will be interrupted.
- Set the parameter "Behaviour at the end of safety" to "tracking the position".
At the end of all safety alarms, the output will be set to the state last adjusted statically before the safety function or to the state tracked and internally stored during the safety function. The position objects, the long time object and the scene function are tracked.
- i** Parameter setting "Position tracking": The device can track absolute positions after safety release (position telegram, scene value) only if the position data is known and if the positions have been predefined. In all other cases, no reaction takes place on release of safety.
Position data can be tracked, if the output was in a defined position before the safety function or if a new position telegram was received via the position objects during the safety interlock. In the latter case, a reference movement will be executed when the safety function is enabled, if the position before or during the safety interlock was unknown. Known slat positions will also be tracked as described. This is also the case, when the height of the Venetian blind is unknown.
Long time movements (movements without position preset) will, however, always be tracked.
- i** The preset "Behaviour at the end of safety" will only be executed, if the output passes over to direct operation at the end of all safety alarms. If a sun protection function is activated (independent of the preset priority with respect to direct operation), it will be also executed.

4.2.4.4.5 Sun protection settings

Sun protection function - General information

A sun protection function can be configured and actuated for output 1 of the device. Sun protection is generally realized with blinds, shutters or awnings and offers an intelligent method of shading rooms, terraces or balconies during sunshine depending on the altitude of the sun in the sky and on the intensity of the sunlight (Figure 22)

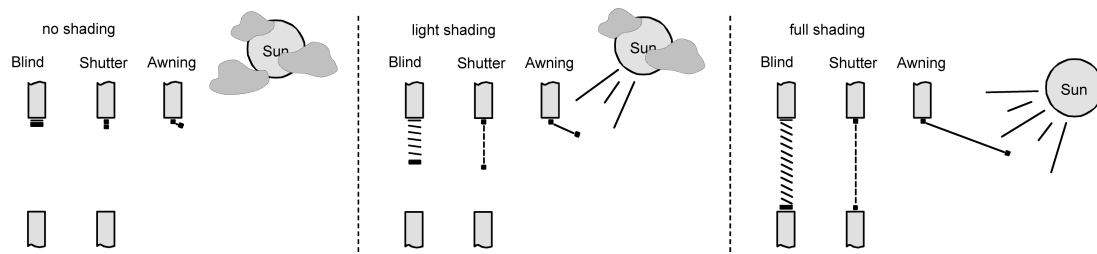

Figure 22: Sun protection principles (example)

The sun protection functions of the device can be adapted many different applications. In simple applications as, for instance, in case of direction-dependent measurement of the sun's intensity by means of a brightness sensor, the curtains controlled can be closed partly or completely to prevent being disturbed by direct sunlight. In these applications, the sun protection function merely evaluates the 1-bit sun signal from the brightness or a similar sensor (e.g. weather station with limit value monitoring) and makes a drive open or close the controlled curtains by moving them into fixed configured positions or into variable positions preset via the bus.

In extended applications – for instance where the degree of shading is controlled by weather stations evaluating additionally the sun angle as a function of astro co-ordinates and presetting the blind and also the slat positions dynamically – the sun protection function can be supplemented by an automatic control system. In such applications, the sun protection function evaluates additional bus communication objects allowing to enable or to disable the automatic control while the device is in operation. This results in a large number of combination variants with intelligent Venetian blind control systems.

Already simple sun protection applications are sufficient to permit a fixed or variable re-adjustment of the positions of Venetian blind slats for adapting the curtain to individual shading requirements. For such purpose, it is possible to preset a static slat offset in the ETS parameters, for instance, for adapting the reflection of sunlight depending on the building situation, or additionally, a dynamical slat offset via a bus communication object, for instance, for manual re-adjustment of the slat opening by persons in the room or otherwise by a central building services control system.

In all cases, the priority between an incoming sunshine or automatic telegram and the direct operation of the output (short time, long time telegram, scenes, positioning) is also presettable in the ETS. This way, a sun protection position can, for instance, be influenced by a 'manual' operation of a pushbutton sensor in the room and the sun protection function be interrupted. Alternatively, sun protection mode can therefore not be interrupted by a direct operation, i.e. the output is locked.

A sun protection function can be overridden by a safety function, a forced position or also by a manual control locally on the device itself as these functions of the device invariably have a higher priority. At the end of one of the mentioned functions with a higher priority, the same reaction as the one at the beginning of sun protection will be re-executed, if the sun protection function is still active at this time.

The device can be operated with two sun protection functions. The simple sun protection or alternatively the extended sun protection that can be enabled.

Sun protection function - Simple sun protection

In the simple sun protection, shading against sunlight is activated and deactivated via the 1-bit communication object "Sunshine / shading facade". The polarity of this object can be selected in the ETS. The sun protection is activated as soon as "sunshine" is signalled to the object depending on the preset polarity. After ETS programming or after switch-on of the supply voltage, the object must at first have data written into it by the bus also in case of inverted polarity before the sun protection can be activated.

A newly received object value (sun / beginning of shading or sun / end of shading) can optionally be evaluated with a time delay. This feature permits suppressing brief brightness variations caused, for instance, by passing clouds or by a thunderstorm. An update (from deactivated to activated) of the "Sunshine / shading facade" object causes the sun protection to be reactivated, if it had been influenced and possibly been re-enabled beforehand by a direct operation in acc. with the preset priority.

The reaction of the output at the beginning of shading can be preset in the ETS. Amongst other things, this setting permits approaching fixed configured positions or positions preset via the bus and thus variable. Variable positions for sun protection purposes can be preset, for instance, by means of pushbutton sensors or visualisations. In addition, it is possible in case of a defined sun protection positioning movement to have a reference movement executed by forced control. This ensures that identical blind positions are approached synchronously by different outputs in case of a sun protection positioning movement. The reaction at the end of a shading task can be preset as well. In this situation, the curtain can pass into an end position, be stopped or shown no special reaction. Tracking of positions is possible as well.

By means of a priority setting in the ETS configuration, it can be specified whether the sun protection function can be influenced by direct operation or whether the corresponding output is locked by a telegram "Sunshine / shading facade" in the sun protection position. The "Forced position" and "Safety" functions always have a higher priority so that these functions can override, but not terminate a sun protection. Thus, the sun protection function is re-executed at the end of a function with a higher priority, if the object "Sunshine / shading facade" continues to signal the presence of sunshine.

- i The following rules must be observed for the extended sun protection: After an ETS programming operation, the sun protection function including automatic operation is always deactivated.

The schematic diagram of the simple sun protection (Figure 23) and an example of how sensor components can be integrated into a simple sun protection configuration.

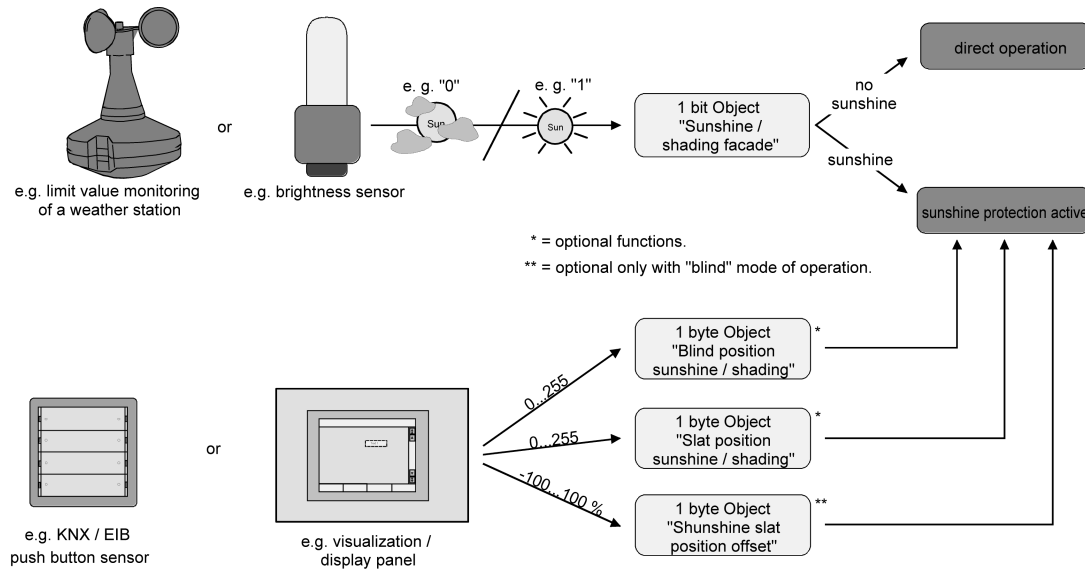

Figure 23: Schematic diagram illustrating the simple sun protection configuration

The function diagram (Figure 24) shows all possible functions of the simple sun protection. For reasons of clarity, the functions with a higher priority (forced position, safety function) are not shown in the diagram.

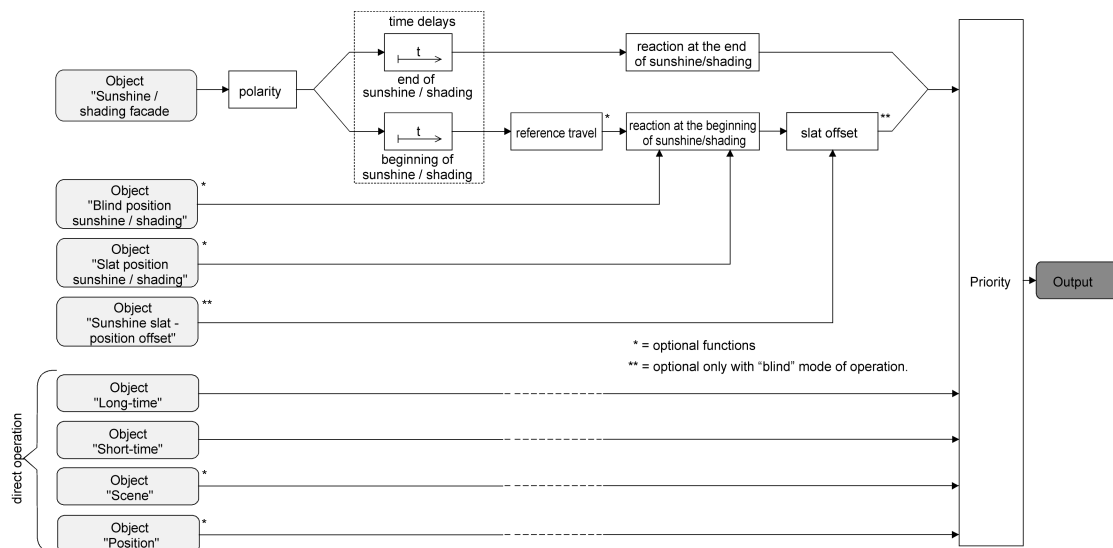

Figure 24: Function diagram illustrating the simple sun protection

Sun protection function - extended sun protection

The extended sun protection has the basic functional properties of the simple sun protection function. In addition, an automatic control system can be implemented. Venetian blind control systems for blind and slat position tracking with respect to the position of the sun as, for instance, a weather station with combination sensor can therefore be integrated into the device system via the bus as an added automatic function.

In the extended sun protection, shading against sunlight is activated and deactivated via the 1-bit communication object "Sunshine / shading facade". A reaction of the output to the sun telegram can be expected only after the automatic control has been activated. In all other cases, the sun protection function is completely deactivated.

As far as the activation of the automatic control via the corresponding object is concerned, the following two cases must be distinguished...

- Sun shading action starting immediately:
Automatic operation is activated as soon as the "Automatic" object receives a "1" telegram. The output reacts immediately to the activation and shows the preset behaviour depending on sunlight conditions (Sun / beginning of the shading action / Sun end of the shading action). The sunlight conditions are derived from the "Sun / shading facade" object according to the set polarity - if necessary after the delays have elapsed.
After an ETS programming operation or after switch-on of the supply voltage, the "Sunshine / shading facade" object is initialised with "0" and, unlike the simple sun protection, evaluated immediately depending on the preset polarity so that shading against sunlight can begin immediately on activation of the automatic sun protection function. The reception of a "0" telegram by the object "Automatic" always terminates an automatic operation independent of the state of the "Sunshine / shading facade" object.

Application example:

Private house with winter garden. The conservatory is equipped with Venetian blinds to shade the place against sunlight. When the conversation is used, automatic operation is activated, for instance, with a pushbutton sensor on the wall. The device then immediately executes the shading function, if sunshine was detected.
The device performs the behaviour configured for the end of the shading / sunshine in case no sunshine is detected when the automatic operation is activated.

- Activation of the sun shading only on the next update:
In this configuration, the polarity of the automatic object can be preset. Automatic operation is activated as soon as the "Automatic" object is set to 'active' in consideration of polarity. A reaction at the output occurs, however, only after a new change of state ("0" -> "1" or "1" -> "0") has been signalled via the "Sunshine / shading facade" object. In this case, the new state (beginning of sunshine/shading or end of sunshine/shading) determines the behaviour of the output immediately depending on the preset polarity.
After an ETS programming operation or after switch-on of the supply voltage, the object "Automatic" must at first have data written into it by the bus also in case of inverted polarity before the automatic operation can be activated.
The reception of an 'Automatic deactivated' telegram by the "Automatic" object always terminates an automatic operation independent of the state of the "Sunshine / shading facade" object.

Application example:

An office building is equipped with several Venetian blinds to shade individual offices against sunlight. In the early morning hours, the automatic sun protection is activated in a central place in the building, e.g. in the porter's lodge. The Venetian blinds will, however, not move into the shading positions unless the system has actually reported sunshine for the building facades in question.

The behaviour at the end of automatic operation is configured separately in the ETS and is executed whenever the automatic mode is terminated and when no function with a higher priority is active at this time. In this situation, the curtain can pass into an end position, be stopped or shown no special reaction. Tracking of positions is possible as well.

Disabling functions of the extended sun protection:

In the event of the sun shading action starting immediately, the automatic operation can optionally be disabled with an additional communication object. The objects "Automatic" and "Automatic mode disable" are logically combined (AND with feedback). When disabling is activated, the automatic operation is reset and thus aborted. The output will then show the behaviour at the end of automatic operation. The automatic mode can only be reactivated, if the disabling object is enabled and if the "Automatic" object is updated again by writing a "1" into it. Any attempt of activating the automatic mode while a disable is active will be ignored.

Automatic operation disabling example:

An office room is equipped with Venetian blinds to shade the room against sunlight. The room is

moreover equipped with a pushbutton sensor on the wall with which the automatic operation can be activated or also deactivated. When the automatic mode is activated, the room is immediately shaded against sunlight, if necessary. Depending on the time of day or in the event of disturbing sunlight falling into the room, the persons in the room can therefore decide for themselves whether automatic shading is desired or not.

If required, the automatic sun protection is disabled in a central place of the building, for instance, in the porter's lodge. The automatic control of the Venetian blinds can then be deactivated, if servicing work is being carried out (window cleaning or similar work). After the end of disabling, for instance, at the end of the working hours, automatic operation can only be restarted if it is reactivated in any of the rooms in case of need.

In addition, also the direct operation of the output can be disabled with an independent disabling object. When disabling is active, a direct operation can – independent of the preset priority – never override a sun protection function. In this case, direct operation is non operational in other functions, too. During disabling, incoming direct operation telegrams are completely ignored (positions received via the bus can then not be tracked either).

If the disabling command is received while a movement initiated by direct operation is in progress, the movement will still be completely finished. Thereafter, direct operation is disabled.

Direct operation disabling example:

An office building is equipped with several Venetian blinds to shade individual offices against sunlight. During the working hours, the rooms are to be shaded automatically. Any direct operation – e.g. by means of a simple Venetian blind pushbutton sensor on the wall – is to be disabled during the day. For this reason, the direct operation is disabled, for instance, by the porter or by a building services management system. Cleaners must have the possibility of controlling the shutters directly only after the normal working hours. In this case, direct operation can again be centrally enabled during evening and night hours.

The disabling functions for automatic and for direct operation can also be combined so that it is possible to intervene at any time and as required by the situation in sun protection control functions.

Sunshine signal in the extended sun protection mode:

In the sun protection mode, the system is informed about the prevailing sunshine conditions via the "Sunshine / shading facade" communication object. The system then decides whether shading is required or not. In the extended sun protection mode, the sunshine signal is only evaluated when the automatic operation is activated as well.

A new value received via the "Sunshine / shading facade" object can optionally be evaluated with a time delay. This feature permits suppressing brief brightness variations caused, for instance, by passing clouds or by a thunderstorm. The time delay is started after an update of the "Sunshine / shading facade" object also in those cases where the automatic operation is deactivated so that the newly received information about the sunshine conditions may possibly also be processed with a delay, if the automatic operation is activated later on.

Unlike in the simple sun protection mode, an update of the "Sunshine / shading facade" object from active to active or from inactive to inactive in the extended sun protection mode shows generally no reaction. The behaviour of the output is only influenced if a change of state is being detected. An update of the sunshine signal alone does not result in the activation of the automatic operation either.

When the automatic operation is active, the reaction of a specific output at the beginning of shading can be preset separately in the ETS. This setting permits approaching fixed configured positions or positions preset via the bus and thus variable. Positions for sun protection purposes can be variably preset, for instance, by means of a weather station for sun position tracking. In addition, it is possible in case of a defined sun protection positioning movement to have a reference movement executed by forced control. This ensures that identical blind positions are approached synchronously by different outputs in case of a sun protection positioning movement.

At the end of sun shading when automatic operation is active, the output reaction can also be configured separately. In this case, too, it is possible to approach fixed configured positions.

By means of a priority setting in the ETS parameters it can be specified whether the evaluation

of the sunshine signal in the automatic mode can be influenced by a direct operation or whether the automatic mode basically locks the corresponding output during sun protection. The "Forced position" and "Safety" functions invariably have a higher priority so that these functions can override, but not terminate a sun protection including an automatic operation. Thus, the sun protection function is re-executed at the end of a function with a higher priority, if the automatic sunshine protection is still active.

An update (from activated to activated) of the "Automatic" object causes the sun protection to be reactivated, if it had been influenced and cancelled beforehand by a direct operation in accordance with the lower priority.

The schematic diagram of the extended sun protection (Figure 25) and an example of how sensor components can be integrated into an extended sun protection configuration.

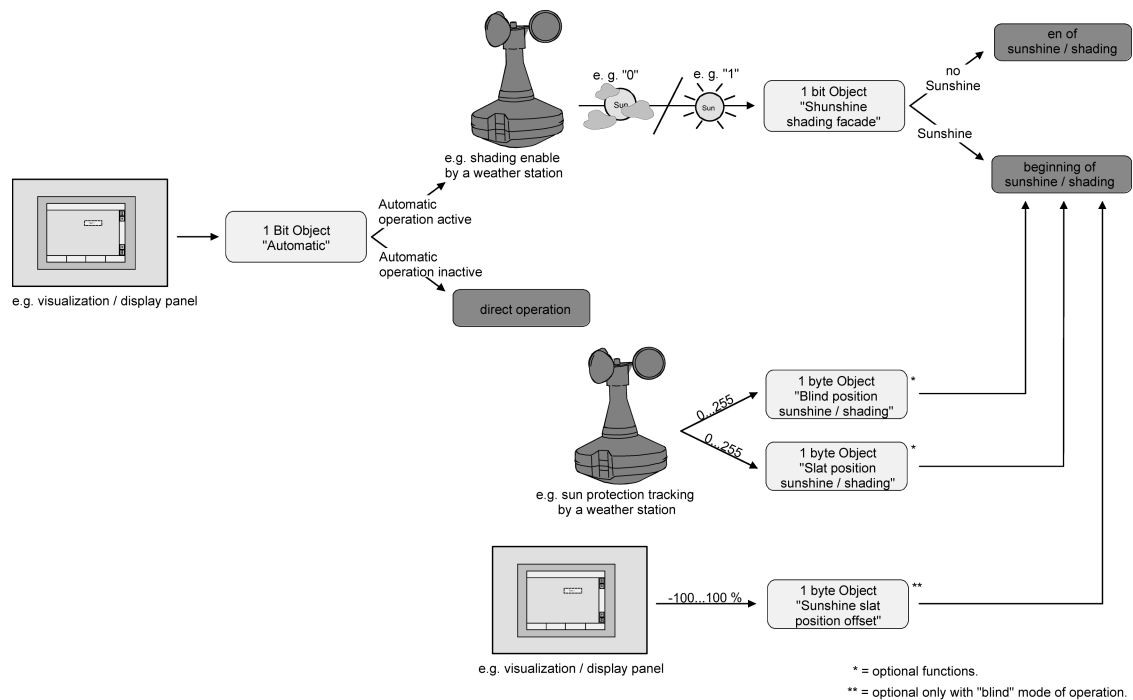

Figure 25: Schematic diagram illustrating the extended sun protection configuration (for reasons of simplicity without disabling functions)

The function diagram (Figure 26) shows all possible functions of the extended sun protection. For reasons of clarity, the functions with a higher priority (forced position, safety function) are not shown in the diagram.

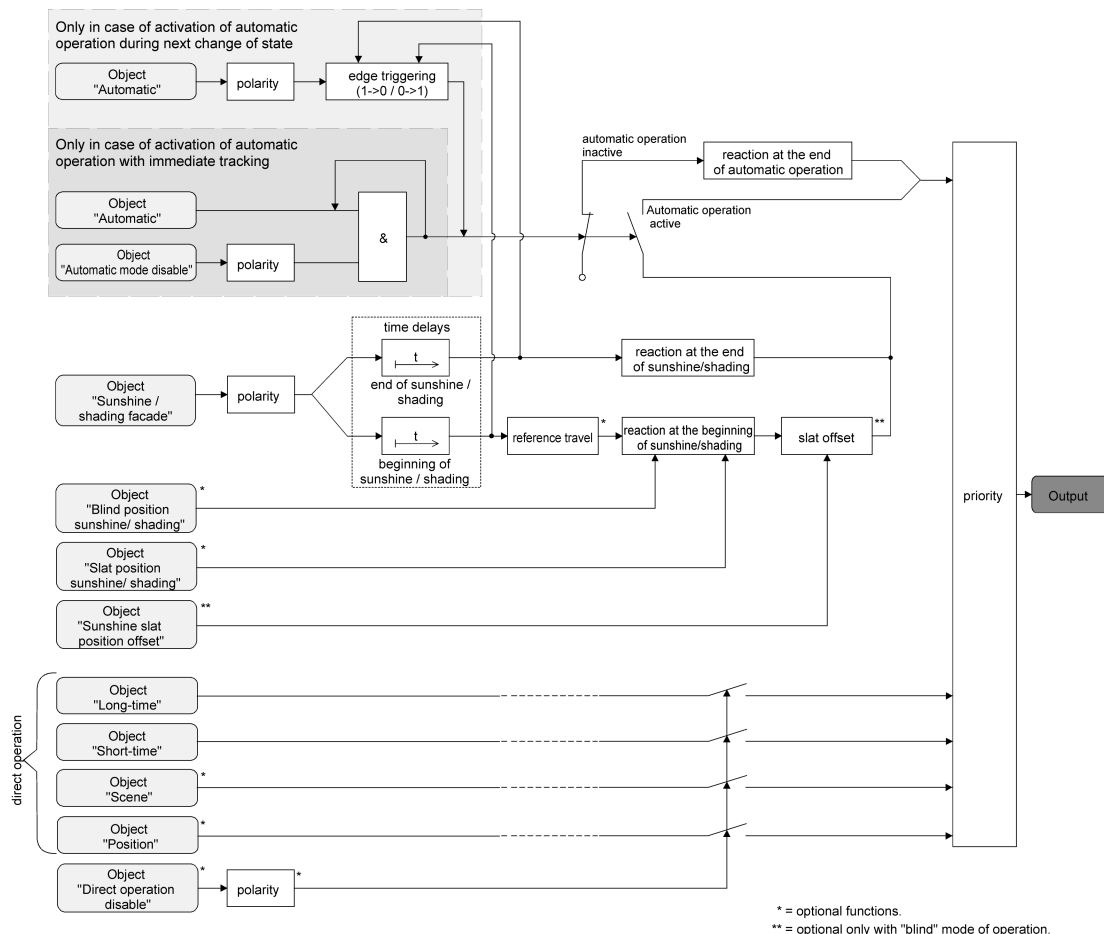

Figure 26: Function diagram illustrating the extended sun protection

- i** The following rules must be observed for the extended sun protection:
 After an ETS programming operation, the sun protection function including automatic operation is always deactivated. An activated sun protection (independent of the selected priority with respect to direct operation) remains active even after a bus voltage failure as long as the mains voltage supply is still on. The sun protection reaction last executed will therefore be executed again at the end of a temporary or permanent manual control (if enabled in case of bus failure), even if there is no bus voltage.

Presetting the type of sun protection

The type of sun protection can be preset. The setting determines whether the simple or the extended type of sun protection is configured.

For the sun protection parameters to be visible, the sun protection function must be enabled on parameter page "O1 - Enabled functions".

- Set the parameter "Type of sun protection" on parameter page "O1 - Sun protection" to "simple sun protection".

Simple sun protection is now configured. The necessary parameters and communication objects are visible.

- Set the parameter "Type of sun protection" on parameter page "O1 - Sun protection" to "extended sun protection".

Extended sun protection is now configured. The necessary parameters and communication objects are visible.

- i** When the sun protection type parameters are changed, the assignments of group addresses to sun protection objects or other parameter settings are lost. For this reason, the sun protection type parameter should be selected directly at the beginning of the sun protection configuration and then not be changed anymore later on.

Presetting the priority of sun protection (for simple sun protection only)

The priority of the sun protection function can be set. In the simple sun protection, the priority relations between the "Sunshine / shading facade" object and the objects of direct operation (short time, long time or position telegram, scene recall) must be configured.

For the sun protection parameters to be visible, the sun protection function must be enabled on parameter page "O1 - Enabled functions".

The function must have been configured for simple sun protection.

- Set the parameter "Priority of sun protection with respect to direct operation" on parameter page "O1 - Sun protection" to "same priority".

The sun protection mode can be overridden at any time by direct operation. In the same way, the sun protection overrides the direct operation, when a new "sunshine" telegram is received via the "Sunshine / shading facade" object and when a configured time delay, if any, has elapsed. If the sun protection function is overridden by a direct operation, the preset behaviour "Reaction at the end of sunshine / shading" will not be executed.

- Set the parameter "Priority of sun protection with respect to direct operation" on parameter page "O1 - Sun protection" to "higher priority".

An active sun protection will override a direct operation. The sun protection mode can therefore not be interrupted by a direct operation. Direct operation will be possible again only after the sun protection function is terminated.

- Set the parameter "Priority of sun protection with respect to direct operation" on parameter page "O1 - Sun protection" to "lower priority".

A direct operation can at any time override the sun protection mode. If the sun protection function is overridden by a direct operation, the preset behaviour "Reaction at the end of sunshine / shading" will not be executed. The sun protection function can only be reactivated after an enabling movement controlled by a direct operation has been effected and after a new "sunshine" telegram has been received via the "Sunshine / shading facade" object. Attempts to activate the sun protection function are ignored for as long as the enabling movement has not taken place.

On the enabling movement:

An enabling movement is an accomplished long time movement into the upper end position which has been initiated by the object "Long time operation". An upward movement after bus voltage return, a position approach to "0 %" or an upward movement after enabling of forced position or safety functions have no enabling effect.

The sun protection is not enabled if the enabling movement has been interrupted. The sunshine protection function will be also be disabled if the output has been readjusted again by a direct operation after an accomplished enabling movement.

After an ETS programming operation or switch-on of the bus voltage, the sunshine protection function is always enabled.

- i** The forced position function and the safety functions have a fixed priority higher than that of the sun protection. The sun protection is overridden – but not terminated – by a function with a higher priority. After the end of the function with the higher priority the reaction at the beginning of sun protection will therefore be executed again, if the sun protection is still active at this time.
- i** With the settings "same priority" or "lower priority", the sun protection can be overridden by a direct operation only if the direct control action can be executed at once. A direct operation will therefore not override the sun protection during an active forced position function or an active safety function.

- i** Parameter setting "same priority" or "lower priority": A variable preset of curtain and slat positions or of a slat offset via the bus at the beginning of sunshine / shading shows no reaction at the output, if the sun protection was overridden by direct operation. However, the position data or offsets received are stored internally so that the new positions will be approached on reactivation of the sun protection.

Presetting the priority of automatic sun protection (for extended sun protection only)

The priority of the automatic sun protection function can be set. In the extended sun protection, the priority relations between the "Sunshine / shading facade" object and the objects of direct operation (short time, long time or position telegram, scene recall) must be configured. The selected priority thus affects the evaluation of the sunshine signal in the automatic mode and not the automatic mode itself.

For the sun protection parameters to be visible, the sun protection function must be enabled on parameter page "O1 - Enabled functions".

The function must have been configured for extended sun protection.

- Set the parameter "Priority of automatic operation with respect to direct operation" on parameter page "O1 - Sun protection" to "same priority".

The sunshine signal of the automatic sun protection mode and the corresponding reaction can be overridden at any time by direct operation. In the same way, the sunshine signal overrides the direct operation, when a new "sunshine" or "no sunshine" telegram is received via the "Sunshine / shading facade" object and when this telegram results in a change of state. Moreover, a configured delay time, if any, must have elapsed. When the sunshine signal is overridden by a direct operation, the preset behaviour "Reaction at the end of sunshine / shading" will not be executed.

- Set the parameter "Priority of automatic operation with respect to direct operation" on parameter page "O1 - Sun protection" to "higher priority".

An active automatic mode always overrides the direct operation independent of the sunshine signal. The sunshine signal can therefore not be interrupted by a direct operation. Direct operation will be possible again only after the automatic mode is terminated.

- Set the parameter "Priority of automatic operation with respect to direct operation" on parameter page "O1 - Sun protection" to "lower priority".

A direct operation can at any time override the sunshine signal. If the sunshine signal is overridden, the preset behaviour "Reaction at the end of sunshine / shading" will not be executed. The sunshine signal will be evaluated again only after an enabling movement controlled by a direct operation has been effected and when a new "sunshine" or "no sunshine" telegram is received via the "Sunshine / shading facade" object and when this telegram results in a change of state. The sun protection function is ignored for as long as the enabling movement has not taken place.

On the enabling movement:

An enabling movement is an accomplished long time movement into the upper end position which has been initiated by the object "Long time operation". An upward movement after bus voltage return, a position approach to "0 %" or an upward movement after enabling of forced position or safety functions have no enabling effect.

The sunshine signal is not enabled if the enabling movement has been interrupted. The sunshine signal will be also be disabled, if the output has been re-adjusted again by a direct operation after an accomplished enabling movement.

- i** A direct operation never terminates the automatic mode. Irrespective of a function being overridden by a direct operation, an activation or a deactivation of the automatic mode (telegram update of the "Automatic" object) always re-enables the sunshine signal as well and evaluates it when the automatic mode is active. Attention must be paid to this behaviour especially in those cases where the "Automatic" object is cyclically overwritten by telegrams.

- i** The forced position function and the safety functions have a fixed priority higher than that of the automatic sun protection. The sun protection is overridden – but not terminated – by a function with a higher priority. After the end of the function with the higher priority the reaction last executed by the automatic sun protection will therefore be executed again, if the sun protection is still active at this time.
- i** With the settings "same priority" or "lower priority", the sunshine signal can be overridden by a direct operation only if the direct control action can be executed at once. A direct operation will therefore not override the sun signal during an active forced position function or an active safety function.
- i** Parameter setting "same priority" or "lower priority": A variable preset of blind and slat positions or of a slat offset via the bus at the beginning of sunshine / shading shows no reaction at the output, if the sunshine signal was overridden by direct operation. However, the position data or offsets received are stored internally so that the new positions can be approached when the sensor signals that the sun is shining again.
- i** Irrespective of the preset priority, an update of the "Sunshine / shading facade" object from active to active or from inactive to inactive in the extended sun protection mode shows generally no reaction. The behaviour of the output is only influenced if a change of state is detected.

Presetting the polarity of the "Sunshine / shading facade" object

The telegram polarity of the "Sunshine / shading facade" object can be preset. This means that an adaptation to the signals from existing sensors or weather stations is possible in the simple and also in the extended sun protection mode.

For the sun protection parameters to be visible, the sun protection function must be enabled on parameter page "O1 - Enabled functions".

- Set the parameter "Polarity of 'Sunshine / shading facade' object" on parameter page "O1 - Sun protection" to the required telegram polarity.

The sunshine signal is evaluated in accordance with the preset priority.

- i** In the simple sun protection mode, an update (from activated to activated) of the "Sunshine / shading facade" object causes the sun protection to be reactivated, if it had been influenced and possibly been re-enabled beforehand by a direct operation in acc. with the preset priority.
- i** In the extended sun protection mode, an update of the "Sunshine / shading facade" object from active to active or from inactive to inactive shows generally no reaction. The behaviour of the output is only influenced if a change of state is detected.

Presetting the activation of the automatic mode (for extended sun protection only)

As far as the activation of the automatic mode is concerned, two cases must be distinguished which can be configured with the help of ETS parameters. Either a travel movement in acc. with the reaction at the beginning or the end of sunshine is executed immediately on activation of the automatic mode, or otherwise the system waits after activation of the automatic mode for a new change of state in the "Sunshine / shading facade" object until the corresponding output shows the reaction at the beginning or at the end of sunshine.

For the sun protection parameters to be visible, the sun protection function must be enabled on parameter page "O1 - Enabled functions".

The function must have been configured for extended sun protection.

- Set the parameter "Activation of automatic mode by..." on parameter page "O1 - Sun protection" to "Object 'Automatic' and next change of state".

Automatic operation is activated as soon as the "Automatic" object is set to 'active' in consideration of polarity. A reaction at the output occurs, however, only after a new change of state has been signalled via the "Sunshine / shading facade" object. In this case, the new state (beginning of sunshine/shading or end of sunshine/shading) determines the behaviour of the output.

- Set the parameter "Activation of automatic mode by..." on parameter page "O1 - Sun protection" to "Object 'Automatic' & immediate tracking".

Automatic operation is activated as soon as object "Automatic" receives a "1" telegram. The behaviour of the output (beginning of sunshine/shading or end of sunshine/shading) is immediately determined by the state of the object "Sunshine / shading facade".

- i** Depending on the setting, various object numbers are created for the "Automatic" object in the ETS. If the parameters are changed, the group address assignments for the automatic object are lost.

Presetting the polarity of the "Automatic" object (for extended sun protection only)

If the automatic mode is to be activated via the object and only at the next change of state of the sunshine signal (see "Presetting the activation of the automatic mode"), the telegram polarity of the automatic object can be preset in addition.

For the sun protection parameters to be visible, the sun protection function must be enabled on parameter page "O1 - Enabled functions".

The extended sun protection must be configured for activation of the automatic mode on next change of state.

- Set the parameter "Polarity of 'Automatic' object" on parameter page "O1 - Sun protection" to the required telegram polarity.
The telegram to the "Automatic" object will be evaluated depending on the selected priority.

- i** After an ETS programming operation or after switch-on of the supply voltage, the object "Automatic" must at first have data written into it by the bus also in case of inverted polarity before the automatic operation can be activated.
- i** The polarity of the "Automatic" object is not presettable, if the automatic mode is activated via the object with immediate tracking. In this case, the telegram polarity is fixed: Automatic ON = "1", Automatic OFF = "0".

Presetting the disabling function for the automatic mode (for extended sun protection only)

Automatic mode can be deactivated at any time via a separate disabling object. After enabling of the disabling function in the ETS parameters, the "Automatic mode disable" object becomes visible.

For the sun protection parameters to be visible, the sun protection function must be enabled on parameter page "O1 - Enabled functions".

The extended sun protection must be configured for activation of the automatic mode with immediate tracking of the sunshine signal.

- Set the parameter "Disabling function for automatic mode ?" on parameter page "O1 - Sun protection" to "yes".
The disabling function is enabled. The parameter for setting of the polarity becomes visible.
- Set the parameter "Polarity of object 'Automatic mode disable'" on parameter page "O1 - Sun protection" to the required telegram polarity.

The telegram to the "Automatic mode disable" object will be evaluated depending on the selected priority.

- i** The objects "Automatic" and "Automatic mode disable" are logically combined (AND with feedback). When disabling is activated, the automatic operation is reset and thus aborted. The output will then show the behaviour at the end of automatic operation. The automatic mode can only be reactivated, if the disabling object is enabled and if the "Automatic" object is updated again by writing a "1" into it. Any attempt of activating the automatic mode while a disable is active will be ignored.
- i** After an ETS programming operation or after switch-on of the supply voltage, the objects "Automatic" and "Automatic mode disable" are always initialised with "0". If the disabling object works with inverted polarity (setting "disabled" = "0") the disabling function is in this case immediately active.

Presetting the disabling function for direct operation (for extended sun protection only)

The direct mode can be deactivated at any time via a separate disabling object. After enabling of the disabling function in the ETS parameters, the "Direct operation disable" object becomes visible.

For the sun protection parameters to be visible, the sun protection function must be enabled on parameter page "O1 - Enabled functions".

The function must have been configured for extended sun protection.

- Set the parameter "Disabling function for direct mode ?" on parameter page "O1 - Sun protection" to "yes".
The disabling function is enabled. The parameter for setting of the polarity becomes visible.
- Set the parameter "Polarity of object 'Direct operation disable'" on parameter page "O1 - Sun protection" to the required telegram polarity.
The telegram to the "Direction operation disable" object will be evaluated depending on the selected priority.

- i** After an ETS programming operation or after switch-on of the supply voltage, the "Automatic mode disable" object is always initialised with "0". If the disabling object works with inverted polarity (setting "disabled" = "0") the disabling function is in this case immediately active.

Presetting the reaction at the end of automatic operation (for extended sun protection only)

When the automatic operation is being deactivated – also by the disabling function – the output will show the preset reaction, if no function with a higher priority is active at the time of deactivation. The preset reaction will not be executed either on termination of the automatic operation, if the sunshine signal is overridden on account of priority settings by a direct operation. The reaction at the end of automatic operation is preset on parameter page "O1- Sun protection". Depending on the selected mode of operation, the ETS adapts the designations of the parameter settings ("raising" ↔ "opening the louver" / "lowering" ↔ "closing the louver").

For the sun protection parameters to be visible, the sun protection function must be enabled on parameter page "O1 - Enabled functions".

The function must have been configured for extended sun protection.

- Set the parameter "Reaction at the end of automatic operation" to "no reaction".
At the end of automatic operation the relay of the output shows no reaction. Any movements still in progress at this instant will still be finished.

- Set the parameter "Reaction at the end of automatic operation" to "raising" or "opening the louver".
At the end of automatic operation, the device raises the blind or opens the venting louver.
 - Set the parameter "Reaction at the end of automatic operation" to "lowering" or "closing the louver".
At the end of automatic operation, the device lowers the blind or closes the venting louver.
 - Set the parameter "Reaction at the end of automatic operation" to "stop".
At the end of automatic operation, the device switches the relays of the output to the "stop" position. A drive movement, if any, will be interrupted.
 - Set the parameter "Reaction at the end of automatic operation" to "position tracking".
At the end of automatic operation, the output will be set to the state last adjusted statically before the automatic sun protection or to the state tracked and internally stored during the automatic sun protection. The position objects, the long time object and the scene function are tracked.
- i** The behaviour preset in this parameter will only be executed, if no function with a higher priority (e.g. safety) is activated at the end of automatic operation.
- i** Parameter setting "Position tracking": The device can track absolute positions (position telegram, scene value) at the end of automatic operation only if the position data is known and if the positions have been predefined. There is otherwise no reaction at the end of automatic operation.
Position data can be tracked, if the output was in a defined position before the automatic sun protection function or if a new position telegram was received via the position objects during the sun protection. In the latter case, a reference movement will be executed at the end of automatic operation, if the position before or during the sun protection was unknown.
Known slat positions will also be tracked as described. This is also the case, when the height of the Venetian blind is unknown.
Long time travel movements (movements without position preset) will always be tracked.

Presetting a time delay for beginning and end of sunshine / shading

The telegram received via the object "Sunshine / shading facade" for activation or deactivation of shading (depending on polarity) can be evaluated with a time delay. The preset delay times are always evaluated in the simple as well as in the extended sun protection mode.

For the sun protection parameters to be visible, the sun protection function must be enabled on parameter page "O1 - Enabled functions".

- Set the parameter "Time delay at the beginning of sunshine / shading" on parameter page "O1 - Beginning of sun protection" to the required delay time.
The telegram for activation of the sun shading will be evaluated with a delay corresponding to the setting.
 - Set the parameter "Time delay at the end of sunshine / shading" to the required delay time.
The telegram for deactivation of the sun protection will be evaluated with a delay corresponding to the setting.
- i** A setting of "0" in the parameters deactivates the respective delay time. In this case, the state of the sunshine signal is evaluated immediately.
- i** Simple sun protection mode: An update (from deactivated to activated) of the "Sunshine / shading facade" object causes the sun protection to be reactivated in consideration of the delay time, if the sun protection had been influenced or aborted beforehand by a direct operation because of the same or a lower priority.

- i** For extended sun protection mode: The time delay is started after an update of the "Sunshine / shading facade" object also in those cases where the automatic operation is deactivated so that the newly received information about the sunshine conditions may possibly also be processed with a delay, if the automatic operation is activated later on. Unlike in the simple sun protection mode, an update of the "Sunshine / shading facade" object from active to active or from inactive to inactive in the extended sun protection mode shows generally no reaction. The behaviour of the output is only influenced if a change of state is detected. An update of the sunshine signal alone does not result in the activation of the automatic operation either.

Presetting the reaction at the beginning of sunshine / shading

The behaviour of the output at the beginning of sunshine / shading – if applicable, after the end of the delay time – can be configured in the ETS. In the simple sun protection mode, the behaviour will be executed, when the sun protection function is activated after receiving a new sunshine signal. In the extended sun protection mode, the output shows the configured reaction, when automatic operation is activated and when a new sunshine signal ("sun is shining") is being received or was received beforehand. The reaction will not be executed if a function with a higher priority is active at the time the sun shading is received. The reaction at the beginning of sunshine / shading is preset on parameter page "O1- Sun protection". Depending on the selected mode of operation, the ETS adapts the designations of the parameter settings ("raising" ↔ "opening the louver" / "lowering" ↔ "closing the louver". The ETS equally adapts the parameter selection depending on the preset mode of operation.

For the sun protection parameters to be visible, the sun protection function must be enabled on parameter page "O1 - Enabled functions".

- Set the parameter "Reaction at the beginning of sunshine / shading" to "no reaction".
At the beginning of shading, the output switches over to sun protection while the relays of the output show no reaction. Any movements still in progress at this instant will still be finished.
- Set the parameter "Reaction at the beginning of sunshine / shading" to "raising" or "opening the louver".
At the beginning of shading, the device raises the blind or opens the venting louver.
- Set the parameter "Reaction at the beginning of sunshine / shading" to "lowering" or "closing the louver".
At the beginning of shading, the device lowers the blind or closes the venting louver.
- Set the parameter "Reaction at the beginning of sunshine / shading" to "stop".
At the beginning of shading, the device switches the relays of the output to the "stop" position. A drive movement, if any, will be interrupted.
- Set the parameter "Reaction at the beginning of sunshine / shading" to "internal scene recall". The number of the scene to be recalled must be specified in the parameter "Scene number (1...8)".
At the beginning of shading, the device recalls the position value for the output which was preset in the scene configuration. This is not a scene recall as in direct operation, but only an approach to the corresponding scene position value.
- Set the parameter "Reaction at the beginning of sunshine / shading" to "fixed position".
At the beginning of shading, the device recalls a fixed position value output.

- i** In the "Venetian blinds" operating mode, the setting "fixed position" can be selected separately for the height of the Venetian blind and for the slat position. For this reason, the ETS adapts the parameter selection and enlarges the setting options in this operating mode.

- "Fixed position" only: Set the parameter "Fixed position of Venetian blind", "Fixed position of roller shutter/awning" or "Fixed position of venting louver" to "as parameter value". Thereafter, set the parameter "Position of Venetian blind (0...100%)", "Position of roller shutter/awning (0...100%)" or "Position of venting louver (0...100%)" to the desired position.
At the beginning of shading, the output invariably approaches the configured position value.
- "Fixed position" only: Set the parameter "Fixed position of Venetian blind", "Fixed position of roller shutter/awning" or "Fixed position of venting louver" to "no change of current position".
At the beginning of shading, the last set position of the Venetian blind height, the roller shutter, awning or venting louver will be maintained.
- "Fixed position" and operating mode = "Venetian blind" only: Set the parameter "Fixed slat position (0...100%)" to the desired position value.
At the beginning of shading, the output invariably moves the slats to the configured position after the height of the Venetian blind has been adjusted.
- Set the parameter "Reaction at the beginning of sunshine / shading" to "variable position".
At the beginning of shading, the device recalls the variably specified position value output. The variable specification of the Venetian blind height, the roller shutter, awning or venting louver position takes place via the separate communication object "...pos. sunshine / shading" (in the "Venetian blind" operating mode for the slats also using the separate object "Slat position sunshine / shading").

- i** In the "Venetian blind" operating mode, the "variable position" setting can be selected separately for the height of the Venetian blind and for the slat position. For this reason, the ETS adapts the parameter selection and enlarges the setting options in this operating mode.
- i** The behaviour preset in this parameter will only be executed, if no function with a higher priority (e.g. safety) is activated at the time of shading.
- i** "Internal scene recall" setting: For this setting, the scene function of the output must be enabled in the ETS. Otherwise, the positions approached at the beginning of sun shading are undefined positions. The scene position values stored in the device by a scene storage function will be approached as well. A delay configured for scene recalls has no influence on the recall of the scene value by the sun protection function.
- i** "Variable position" setting: After an ETS programming operation or after switch-on of the supply voltage, the objects "Sunsh./shading ... position" and "Sunsh./ shading slat position" must receive position values from the bus. Otherwise the device does not position itself at the start of sun shading as it does not have any valid position data.
When the device is in operation, the position data can be updated at any time via the bus even if the sun protection is active (e.g. by a weather station for the purpose of sun position tracking). The device will then immediately approach the newly received positions if the sun protection is active. If a function with a higher priority is active, the device stores the newly received position values and approaches them during a later shading operation.
The position data last received are not lost in a bus voltage failure.

Presetting a forced reference movement in the sun protection mode

If needed, a reference movement can be executed by forced-control in the simple and in the extended sun protection mode at the beginning of a shading cycle, if fixed or variable position values or scene positions are to be approached. The execution of a reference movement by forced control at the beginning of shading can be used in a sun protection positioning operation to ensure that the curtains or slats are moved synchronously by different outputs to identical positions (e.g. in a long row of windows). Without the execution of reference movement by forced control, there might otherwise be positioning inaccuracies with a negative effect on the overall appearance of a building facade with the blinds let down.

A reference movement by forced control will always be executed in the simple sun protection mode, when the beginning of shading is signalled for the first time via the "Sunshine/shading facade" object. Updates of the object from 'sun is shining' to 'sun is shining' do not initiate a reference movement if, at this time, the output is still in the sun protection position.

A reference movement by forced control will be executed in the extended sun protection mode, when the beginning of shading is signalled via the "Sun shading facade" object and when automatic operation is active or is activated. Updates of the object from 'sun is shining' to 'sun is shining' will never initiate a reference movement. In this case, the sunshine signal must first change from 'sun is not shining' to 'sun is shining' before a new reference movement can take place.

A reference movement by forced control will always be executed for synchronisation purposes as described and also in such cases where the position data of the blind or the slats are known. No reference movement by forced control will be executed at the end of shading.

For the sun protection parameters to be visible, the sun protection function must be enabled on parameter page "O1 - Enabled functions".

- Set the parameter "reference movement before every sun protection positioning operation ?" on parameter page "O1 - Beginning of sun protection" to "yes".

At the beginning of shading there is always a reference movement by forced control as described. The preset position will be approached after the end of the reference movement.

- Set the parameter "reference movement before every sun protection positioning operation ?" on parameter page "O1 - Beginning of sun protection" to "no".

A reference movement at the beginning of sun protection will only be executed, if the position data are unknown, for instance, after an ETS programming operation or after switch-on of the power supply. In all other cases, the preset shading position will be approached immediately.

- i** A reference movement is the time required for a travel movement into the upper end position increased by 20 % and additionally by the configured travel time extension. A reference travel is not retriggerable.
- i** Variable position preset: No reference movement will be executed, if new position values are preset via the bus while the sun protection is active.
- i** "Venetian Blind" operating mode: A terminated reference movement of for the height of the Venetian blind synchronises at the same time also the slat position.

Slat offset in the sun protection mode (only "Venetian blind" operating mode)

An offset can be specified for the slat position at the start of sun shading, if fixed or variable slat position values are to be approached.

If necessary, the slat offset can correct the fixed or variable nominal slat position and thus allow the creation of an individual shading situation, when the sun protection is active. The offset can be preset in two ways...

- The slat offset can be configured statically in the ETS. The configuration of a static offset value allows variation of the degree of shading in those parts of the building that are not exposed to full sunshine due to objects in front of the building. The variable slat angle adjusted by the sun protection control or the fixed angle specified in a parameter can thus be overridden so that the slats are always opened a bit wider than originally preset. Alternatively, the slats can also be closed completely by means of the static offset if too much sunlight is reflected into the room.
- The slat offset can additionally be adapted by the bus via the separate communication object "Sunshine slat position offset". In this way, the desired slat offset can also be adjusted during an active shading cycle and independent of a direct operation as, for instance, the short time mode. Thus, it is possible, for instance, that persons in a room can correct the slat angle at any time 'manually' and individually by selecting another preset value at a touch sensor or a visualisation. An offset preset via the object overwrites the value configured in the ETS.

The preset offset is taken into account in the simple and in the extended sun protection mode for each positioning move during an active shading cycle (beginning of sun / shading) and added to the predefined nominal slat position. The offset value can be varied within a range from -100 % ... 0 ... 100 % so that the slats can be moved in both directions into the respective end positions (Figure 27). At an offset of "0 %", the actual slat position is always identical with the predefined nominal slat position for sun protection purposes.

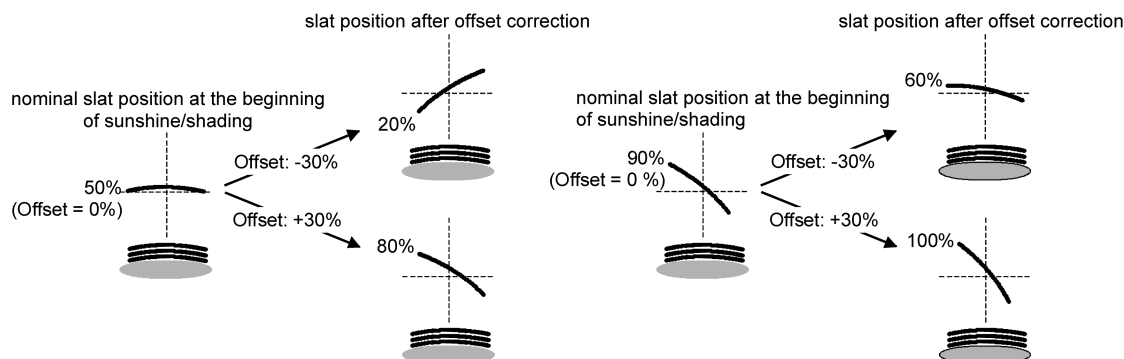

Figure 27: Functional principle of slat offset (example showing slat type 1 / slat type 2 identical)

The position value actually adjusted with the offset after adding the slat position value is always between 0 and 100 %. Minimum and maximum position are thus determined by the slat end positions. These limits cannot be exceeded by specifying an greater offset. Example (Figure 27)...

Slat position at start of sun / shading = 90 %

Slat position offset at start of sun / shading = +30 %

-> The resulting slat position is 100% as the end position is reached.

In acc. with the KNX datapoint type 6.001 (DPT_Percent_V8) the data format of the communication object "Sunshine slat position offset" permits presetting positive and negative values in a range of -128 ... 0 ... +127. The device interprets the value received directly as an offset in %. Values below 100 or above +100 are limited to the minimum (-100 %) and maximum offset (+100 %) and evaluated accordingly.

An offset preset via the object overwrites the value configured in the ETS. In the event of a bus voltage failure, an offset value received via the communication object can be stored internally in a non-volatile memory so that the offset value last received is not lost even in case the power

supply fails. As an alternative, the offset preset via the bus can be reset (0 %) in the event of a power supply failure with the result that the value configured in the ETS is again used in operation. The offset reaction preset in the event of bus voltage failure can be configured in the ETS.

Configuring the slat offset in the sun protection mode (only "Venetian blind" operating mode)

For the sun protection parameters to be visible, the sun protection function must be enabled on parameter page "O1 - Enabled functions".

The function must be configured for the "Venetian blind" operating mode.

The reaction at the beginning of sunshine/shading must be configured for fixed or variable position preset.

- Set the parameter "Offset with fixed and variable slat position" on parameter page "O1 - Beginning of sun protection" to "no offset".
The offset correction is deactivated. During shading (beginning of sunshine/shading), the fixed or variable slat position will be approached without offset correction. The other parameter relating to the offset are blanked out.
 - Set the parameter "Offset with fixed and variable slat position" to "offset as configured".
The static offset correction based on the parameter preset in the ETS is activated. During every shading operation (beginning of sunshine/shading), the nominal slat position is always corrected by the configured offset value.
 - Set the parameter "Offset with fixed and variable slat position" to "offset as configured and via object".
The offset correction based on the parameter preset in the ETS and via the object is activated. The slat offset is preset by a fixed value configured in the ETS and can be adapted dynamically with a separate communication object. During every shading operation (beginning of sunshine/shading), the nominal slat position is always corrected by the preset offset value.
 - Set the parameter "Slat offset position (-100 ... 100 %)" on parameter page "O1 - Beginning of sun protection" to the desired offset value.
The configured value defines the static offset correction of the slat position. The configured value can be re-adjusted via the "Sunshine slat position offset" object, if the communication object has been enabled.
 - Set the "Store offset slat position via object in case of bus voltage failure ?" to "No".
The value received via the object will only be stored temporarily in volatile memory. The received value only replaces the configured value until the device is reinitialised (bus voltage return, if both were previously switched up). After the initialisation, the offset value configured in the ETS will be used again.
 - Set the "Store offset slat position via object in case of bus voltage failure ?" to "Yes".
The value received via the object will be stored in case of bus voltage failure in a non-volatile memory of the device. The originally configured offset value is definitely overwritten in the process. Only a new ETS programming operation sets the offset back to the configured value.
- i** An offset value received via the bus is stored temporarily or permanently in the device and taken into account during the next shading operation. The reception of an offset value during an active shading phase (beginning of sunshine/shading active) results in an immediate and 'visible' correction of the offset angle by the output.
- i** After an ETS programming operation, the offset is always set to the value configured in the ETS.
- i** Storage of the slat offset position in case of bus voltage failure: The offset value preset via the object is stored only if the bus voltage has been available without interruption for at least 20 seconds after the last reset (storage capacitors sufficiently charged for storage purposes). In all other cases nothing is stored.

- i** The slat offset has no influence on the behaviour of an output at the end of a shading phase (end of sunshine/shading).

Presetting the reaction at the end of sunshine / shading (for simple sun protection only)

At the end of the shading phase – if applicable, after the end of the delay time – the output will show the preset reaction, if no function with a higher priority is active at the time of deactivation. The preset reaction will also not be executed at the end of sun shading, if the sunshine signal is overridden on account of priority settings by a direct operation.

The reaction at the end of sun shading is preset on parameter page "O1- Sun protection end". Depending on the selected mode of operation, the ETS adapts the designations of the parameter settings ("raising" ↔ "opening the louver" / "lowering" ↔ "closing the louver".

For the sun protection parameters to be visible, the sun protection function must be enabled on parameter page "O1 - Enabled functions".

The function must have been configured for simple sun protection.

- Set the parameter "Reaction at the end of sunshine / shading" to "no reaction".
At the end of shading, the relay of the output shows no reaction. Any movements still in progress at this instant will still be finished.
- Set the parameter "Reaction at the end of sunshine / shading" to "raising" or "opening the louver".
At the end of shading, the device raises the blind or opens the venting louver.
- Set the parameter "Reaction at the end of sunshine / shading" to "lowering" or "closing the louver".
At the end of shading, the device lowers the blind or closes the venting louver.
- Set the parameter "Reaction at the end of sunshine / shading" to "stop".
At the end of shading, the device switches the relays of the output to the "stop" position. A drive movement, if any, will be interrupted.
- Set the parameter "Reaction at the end of sunshine / shading" to "position tracking".
At the end of shading, the output will be set to the state last adjusted statically before sun protection or to the state tracked and internally stored during sun protection. The position objects, the long time object and the scene function are tracked.

- i** The behaviour preset in this parameter will only be executed, if no function with a higher priority (e.g. safety) is activated when the sun protection is enabled or when a direct operation has not overridden the sunshine signal on account of priority settings.

- i** Parameter setting "Position tracking": The device can track absolute positions (position telegram, scene value) at the end of sun protection only if the position data are known and if the positions have been predefined. There is otherwise no reaction at the end of sun shading.

Position data can be tracked, if the output was in a defined position before the automatic sun protection function or if a new position telegram was received via the position objects during the sun protection. In the latter case, a reference movement will be executed at the end of sun protection, if the position before or during the sun protection was unknown. Known slat positions will also be tracked as described. This is also the case, when the height of the Venetian blind is unknown.

Long time travel movements (movements without position preset) will always be tracked.

Presetting the reaction at the end of sunshine / shading (for extended sun protection only)

The behaviour of the output at the end of sunshine / shading – if applicable, after the end of the delay time – can be configured in the ETS. In the extended sun protection mode, the output shows the configured reaction, when automatic operation is activated and when a new sunshine signal (change of state from "sun is shining" -> "sun is not shining") is being received. The

reaction will not be executed if a function with a higher priority is active at the time the sunshine signal changes. The preset reaction will not be executed either, if the sunshine signal is overridden on account of priority settings by a direct operation.

The reaction at the end of sunshine / shading is preset on parameter page "O1- Sun protection end". Depending on the selected mode of operation, the ETS adapts the designations of the parameter settings ("raising" ↔ "opening the louver" / "lowering" ↔ "closing the louver").

For the sun protection parameters to be visible, the sun protection function must be enabled on parameter page "O1 - Enabled functions".

The function must have been configured for extended sun protection.

- Set the parameter "Reaction at the end of sunshine / shading" to "no reaction".
At the end of shading, the relay of the output shows no reaction. Any movements still in progress at this instant will still be finished.
 - Set the parameter "Reaction at the end of sunshine / shading" to "raising" or "opening the louver".
At the end of shading, the device raises the blind or opens the venting louver.
 - Set the parameter "Reaction at the end of sunshine / shading" to "lowering" or "closing the louver".
At the end of shading, the device lowers the blind or closes the venting louver.
 - Set the parameter "Reaction at the end of sunshine / shading" to "stop".
At the end of shading, the device switches the relays of the output to the "stop" position. A drive movement, if any, will be interrupted.
 - Set the parameter "Reaction at the end of sunshine / shading" to "internal scene recall".
The number of the scene to be recalled must be specified in the parameter "Scene number (1...8)".
At the end of shading, the device recalls the position value for the output which was preset in the scene configuration. This is not a scene recall as in direct operation, but only an approach to the corresponding scene position value.
 - Set the parameter "Reaction at the end of sunshine / shading" to "fixed position".
At the end of shading, the device recalls a fixed position value output.
- i** In the "Venetian blind" operating mode, the setting "fixed position" can only be selected in common for the height of the Venetian blind and for the slat position.

- "Fixed position" only: Set the parameter "Fixed position of Venetian blind", "Fixed position of roller shutter/awning" or "Fixed position of venting louver" to "as specified by parameter". Thereafter, set the parameter "Position of Venetian blind (0...100%)", "Position of roller shutter/awning (0...100%)" or "Position of venting louver (0...100%)" to the desired position.
At the end of shading, the output invariably approaches the configured position value.
- "Fixed position" only: Set the parameter "Fixed position of Venetian blind", "Fixed position of roller shutter/awning" or "Fixed position of venting louver" to "no change of current position".
At the end of shading, the last set position of the Venetian blind height, the roller shutter, awning or venting louver will be maintained.
- "Fixed position" and operating mode = "Venetian blind" only: Set the parameter "Fixed slat position (0...100%)" to the desired position value.
At the end of shading, the output invariably moves the slats to the configured position after the height of the Venetian blind has been adjusted.

- i** The behaviour preset in this parameter will only be executed, if no function with a higher priority (e.g. safety) is activated at the time the sunshine signal changes. The preset reaction will not be executed either, if the sunshine signal is overridden on account of priority settings by a direct operation.

- i** "Internal scene recall" setting: For this setting, the scene function of the output must be enabled in the ETS. Otherwise, the positions approached at the end of sunshine/shading are undefined positions. The scene position values stored in the device by a scene storage function will be approached as well. A delay configured for scene recalls has no influence on the recall of the scene value by the sun protection function.

Sun protection application examples

This chapter describes different applications of the sun protection function of the device in combination with the KNX / EIB weather station REG-K 4-gang and the combisensor. The applications described can be used in the simple and in the extended sun protection mode. For the extended sun protection it is important that the automatic function must be activated, if the sunshine signal of the weather station is to be evaluated and a reaction produced at the output. Also, the disabling functions can optionally be used for automatic or direct operation. The following section contains sketches for each application of which communication objects of the weather station should be connected with the device.

Information on the appropriate configuration of the KNX / EIB weather station can be found in the appropriate product documentation.

- I. Sun protection with brightness limit value monitoring and fixed sun protection positions:

The limit value monitoring function of the weather station is used. The weather station transmits a "1" telegram via the "Limit value 1 [Sun...]" to the bus when a preset brightness limit value is exceeded. This activates the shading function in the device and the corresponding fixed sun protection position set for the blind. In addition, the fixed slat position is recalled in the "Venetian blind" operating mode of the device. When the brightness drops below the limit value for the measured brightness (with hysteresis, if programmed), the weather station transmits the value "0" to the bus. This deactivates the shading function in the device and the corresponding reaction at the end of sunshine / shading will be executed. The communication objects should be interconnected according to specifications (Figure 28).

Required project planning (unlisted configuration is optional):

- Simple or extended sun protection,
- Polarity of the "Sunshine / shading facade" object = "1" sunshine,
- Reaction at the beginning of sunshine / shading = fixed positions,
- Configure fixed positions.

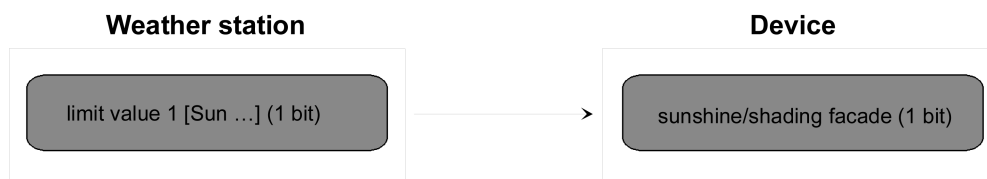

Figure 28: Programming of the communication objects for application example I.

- II. Sun protection with shading control and fixed sun protection positions:

The shading control of the weather station is used. When the preset basic brightness for shading operations is exceeded, the weather station transmits a 1-bit telegram of value "1" via the "Shading facade [shading control facades 1-4]" to the bus. This activates the shading function in the device and the corresponding fixed sun protection position set for the blind. In addition, the fixed slat position is recalled in the "Venetian blind" operating mode of the device.

When the brightness drops below the basic brightness for shading operations (with hysteresis, if programmed), the weather station transmits the value "0" to the bus. This deactivates the shading function in the device and the corresponding reaction at the end of sunshine / shading will be executed. The communication objects should be interconnected according to specifications (Figure 29).

Required project planning (unlisted configuration is optional):

- Simple or extended sun protection,
- Polarity of the "Sunshine / shading facade" object = "1" sunshine,
- Reaction at the beginning of sunshine / shading = fixed positions,
- Configure fixed positions.

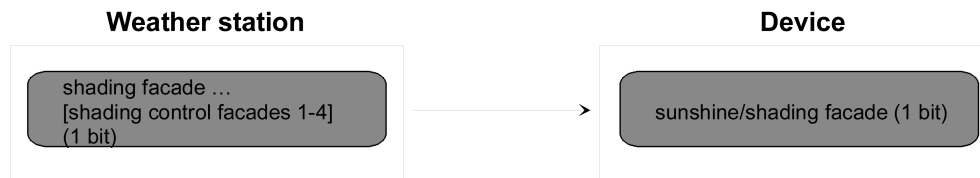

Figure 29: Programming of the communication objects for application example II.

- III. Sun protection with shading control and fixed blind height and variable slat position tracking:

The shading control of the weather station is used. The Venetian blinds connected to the device are slatted Venetian blinds. When the basic brightness for shading operations is exceeded, the weather station transmits a 1-bit telegram of value "1" via the "Shading facade [shading control facade 1-4]" to the bus. This activates the shading function in the device and the corresponding fixed sun protection position set for the Venetian blind height.

The individual facade control of the weather station transmits additionally the slat position to be preset for sun-dependent slat tracking via the 1-byte object "Slat position (%) facade [individual control facade ...]" to the bus. This sets the slat position required in the device for sun shading.

When the brightness drops below the basic brightness for shading operations (with hysteresis, if programmed), the weather station transmits the value "0" via the "Shading facade [shading control facade 1-4]" object to the bus. This deactivates the shading function in the device and the corresponding reaction at the end of sunshine / shading will be executed.

Ideally, the telegram "Slat position (%) facade [individual facade control ...]" = "0 %" is suppressed in the weather station by means of a parameter. The extra slat positioning movement might otherwise adversely affect the behaviour of the output at the end of shading (possibly brief bucking).

The global disabling function of the weather station should not be used for disabling the individual facade control. Disabling can, for example, be implemented individually using the disabling function of automatic operation in the device.

The communication objects should be interconnected according to specifications (Figure 30).

Required project planning (unlisted configuration is optional):

- Simple or extended sun protection,
- Polarity of the "Sunshine / shading facade" object = "1" sunshine,
- Reaction at beginning of sun / shading = Venetian blind position fixed / slat position variable,
- Configure fixed position of Venetian blind.

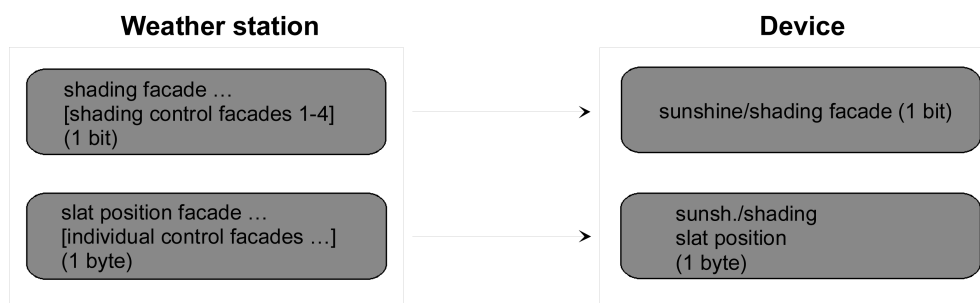

Figure 30: Programming of the communication objects for application example III

- IV. Sun protection with shading control and variable blind height and variable slat position tracking:

The shading control of the weather station is used. The Venetian blinds connected to the device are slatted Venetian blinds. When the basic brightness for shading operations is exceeded, the weather station transmits a 1-bit telegram of value "1" via the "Shading facade [shading control facade 1-4]" to the bus. The device activates the shading function.

The individual facade control of the weather station transmits additionally the slat position to be preset for sun-dependent slat tracking via the 1-byte object "Slat position (%) facade [individual control facade ...]" and the Venetian blind height to be adjusted via the 1-byte object "Shading facade curtain height threshold/position [individual control facade ...]" to the bus. This sets the slat position required in the device for sun shading as well as the Venetian blind height required for shading.

When the brightness drops below the basic brightness for shading operations (with hysteresis, if programmed), the weather station transmits the value "0" via the "Shading facade [shading control facade 1-4]" object to the bus. This deactivates the shading function in the device and the corresponding reaction at the end of sunshine / shading will be executed.

Ideally, the telegrams "Slat position (%) facade [individual facade control ...]" = "0 %" and "Shading facade blind height threshold/position [individual control facade ...]" = 0 % are suppressed in the weather station at the end of shading by means of a parameter. The extra Venetian blind and slat positioning movement might otherwise adversely affect the behaviour of the output at the end of shading (possibly brief bucking).

The global disabling function of the weather station should not be used for disabling the individual facade control. Disabling can, for example, be implemented individually using the disabling function of automatic operation in the device.

The communication objects should be interconnected according to specifications (Figure 31).

Required project planning (unlisted configuration is optional):

- Simple or extended sun protection,
- Polarity of the "Sunshine / shading facade" object = "1" sunshine,
- Reaction at beginning of sun / shading = Venetian blind position variable, slat position variable,

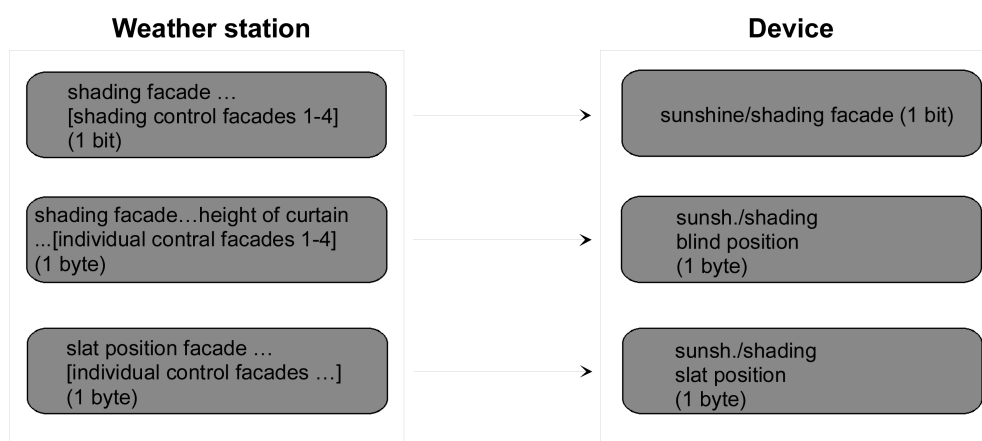

Figure 31: Programming of the communication objects for application example IV

- V. Sun protection with shading control and variable blind height and fixed slat position:

The shading control of the weather station is used. The Venetian blinds connected to the device are slatted Venetian blinds. When the basic brightness for shading operations is exceeded, the weather station transmits a 1-bit telegram of value "1" via the "Shading facade [shading control facade 1-4]" to the bus. This activates the shading function in the device and the corresponding fixed sun protection position set for the slat angle.

The individual facade control of the weather station transmits additionally the Venetian blind height to be adjusted via the 1-byte object "Shading facade blind height threshold/position [individual control facade ...]" to the bus. This sets the slat position required in the device for shading.

When the brightness drops below the basic brightness for shading operations (with hysteresis, if programmed), the weather station transmits the value "0" via the "Shading facade [shading control facade 1-4]" object to the bus. This deactivates the shading function in the device and the corresponding reaction at the end of sunshine / shading will be executed.

Ideally, the telegram "Slat position (%) facade [individual facade control ...]" = 0 % is suppressed in the weather station at the end of shading by means of a parameter. The extra Venetian blind positioning movement might otherwise adversely affect the behaviour of the output at the end of shading (possibly brief bucking).

The global disabling function of the weather station should not be used for disabling the individual facade control. Disabling can, for example, be implemented individually using the disabling function of automatic operation in the device.

The communication objects should be interconnected according to specifications (Figure 32).

Required project planning (unlisted configuration is optional):

- Simple or extended sun protection,
- Polarity of the "Sunshine / shading facade" object = "1" sunshine,
- Reaction at beginning of sun / shading = Venetian blind position variable, slat position fixed,
- Configure fixed slat position.

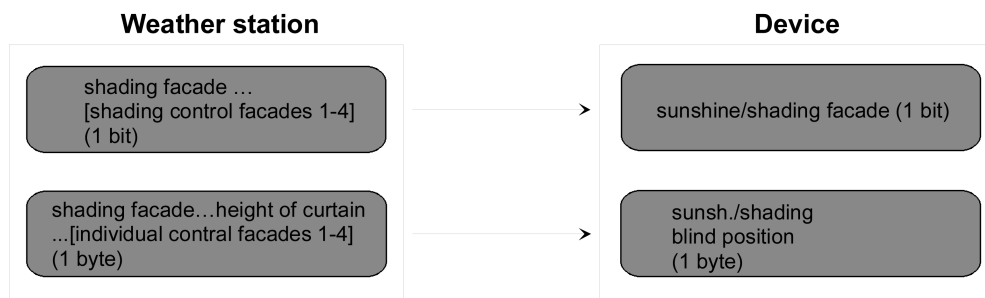

Figure 32: Programming of the communication objects for application example V

4.2.4.4.6 Settings for automatic heating/cooling

Automatic heating/cooling

Automatic heating/cooling can supplement the extended sun protection so that the sun shading of a room is available to an additional application.

When automatic heating / cooling is active, a presence signal – e.g. from a KNX / EIB presence monitor or a detector – is evaluated in addition to the signals of the extended sun protection function. The automatic sun protection function will then only be activated by the device when people are in the room. The room is then shaded or not according to the sunshine signal (see chapter 4.2.4.4.5. Sun protection settings).

If no presence is signalled, the device evaluates in addition a heating/cooling signal derived, for instance, from a room temperature controller or from an outside thermostat. In this case, the shading function can be used to support the heating or cooling function in a room. As no persons are present in the room, intensive sunlight can be used, for instance, to heat up the room by opening the slats or by raising the curtain. Similarly, the room can also be shaded against sunlight during the absence of persons, if additional heating up of the room is not desired.

By evaluating the three 1-bit signals "Presence", "Heating/cooling switchover" and "Sunshine / shading facade" the telegram polarity of which can be configured independently in the ETS, the enlarged sun protection function with automatic heating/cooling can differentiate between the 6 states shown in Table 5 and the corresponding output reactions.

Presence signal	Heating/cooling switchover	Sunshine / shading facade	Reaction at output
persons present	--- (irrelevant)	Sunshine signal active	Reaction at the beginning of sunshine/shading
persons present	--- (irrelevant)	Sunshine signal inactive	Reaction at the end of sunshine/shading
No people present	Heating active	Sunshine signal active	Reaction at the beginning of sunshine/shading with heating
No people present	Heating active	Sunshine signal inactive	Reaction at the end of sunshine/shading with heating
No people present	Cooling active	Sunshine signal active	Sunshine signal active reaction at the beginning of sunshine/shading with cooling
No people present	Cooling active	Sunshine signal inactive	Reaction at the end of sunshine/shading with cooling

Table 5: States of the extended sun protection function with heating/cooling switchover

As described for the extended sun protection without automatic heating/cooling, the sunshine signal will be delayed, if a delay is configured in the ETS for this signal. In the same way, the presence signal can be evaluated independently after a delay, for example in order to 'debounce' short time changes to the signal state.

The schematic diagram (Figure 33) shows the interaction of the different communication objects of the extended sun protection function in combination with the automatic heating/cooling function. The diagram moreover illustrates the principle of incorporating sensor components into the automatic heating/cooling system.

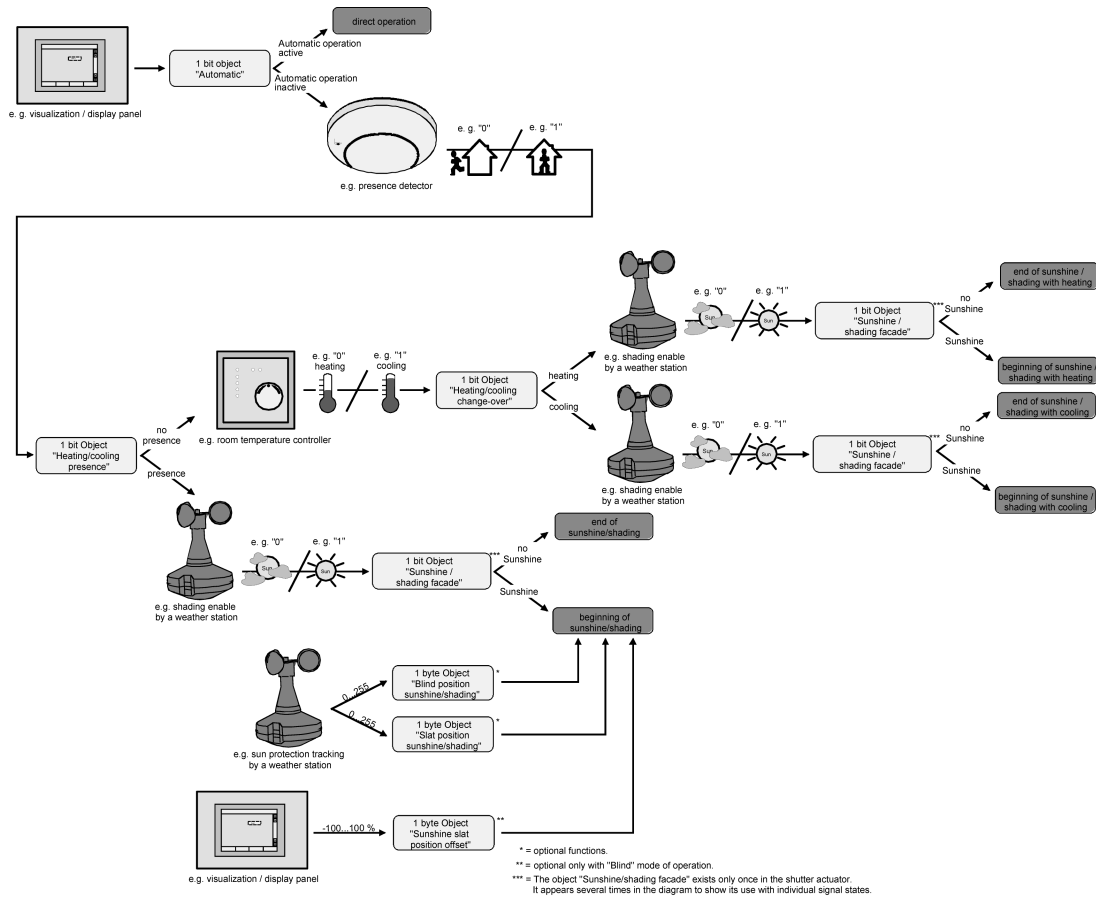

Figure 33: Schematic diagram of automatic heating/cooling (for reasons of simplicity shown without disabling functions of the automatic or direct operation)

In accordance with the schematic diagram, the automatic heating/cooling function is only active when the automatic sun protection is active, too. Like in the extended sun protection mode without automatic heating/cooling, the automatic sun protection is activated via the object "Automatic" depending on the configuration either immediately or only after a change of state has been detected for one of the signals "Presence", "Heating/cooling switchover" and "Sunshine / shading facade" (cf. "Sun protection function – extended sun protection"). After an ETS programming operation or after switch-on of the bus voltage supply), the corresponding communication objects of the signals "Presence", "Heating/cooling switchover" and "Sunshine / shading facade" are initialised with "0". In accordance with the preset polarity, the state of the sunshine and of the presence signal as well as the heating/cooling state will be determined and the corresponding reaction executed provided the automatic sun protection function is active. When the automatic sun protection is active, any change of state of the presence signal or any change in the heating/cooling signal will be evaluated immediately and the corresponding reaction executed.

The schematic function diagram (Figure 34) shows all possible functions of the extended sun protection with automatic heating/cooling. For reasons of clarity, the functions with a higher priority (manual control, forced position, safety function) are not shown in the diagram.

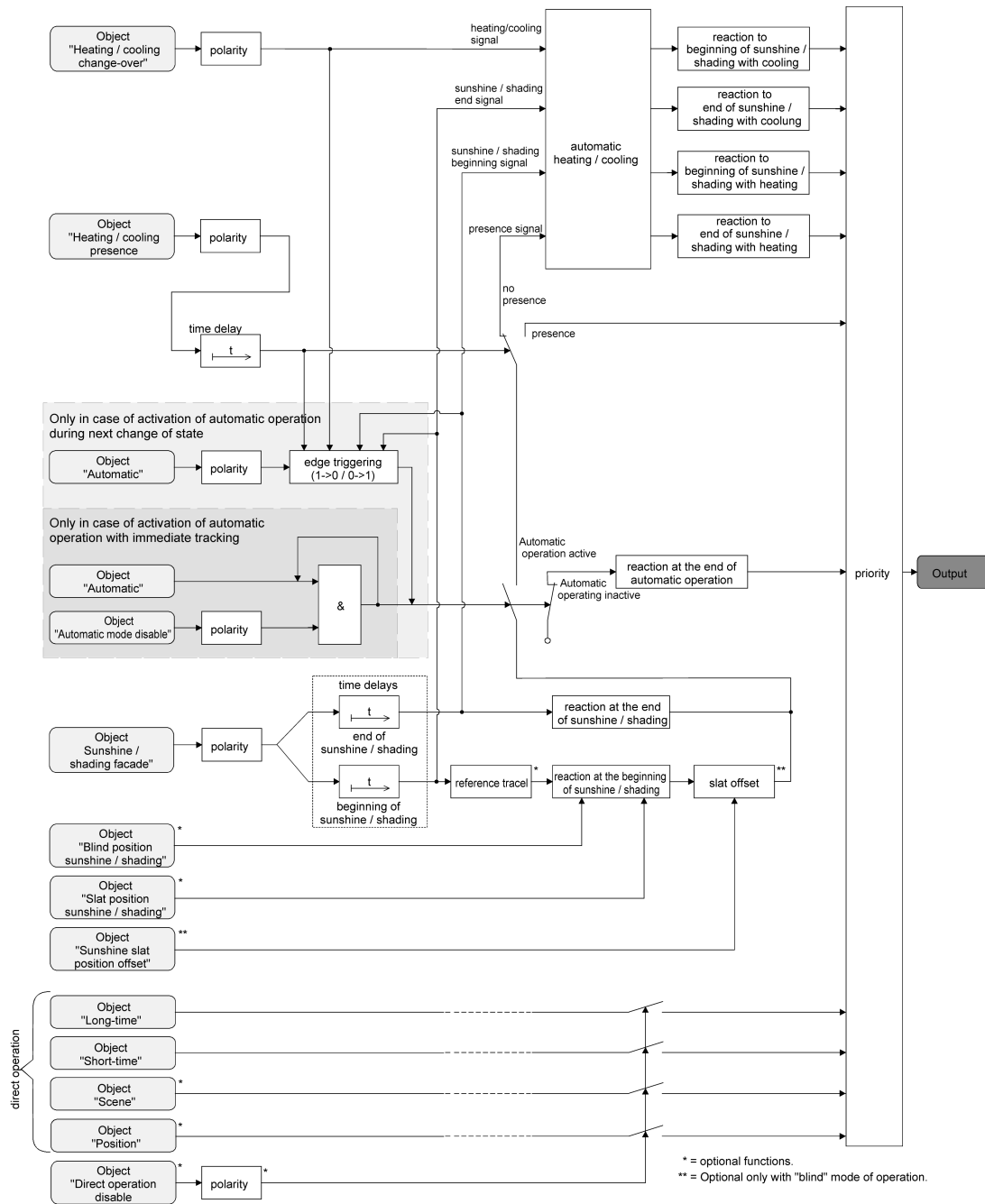

Figure 34: Schematic function diagram of automatic heating/cooling

Enabling automatic heating/cooling

Automatic heating/cooling can be preset separately in the ETS. When automatic heating/cooling is enabled, the extended sun protection function will be supplemented by the necessary communication objects and parameters.

The sun protection function must be enabled on parameter page "O1 - Enabled functions". Moreover, the function must have been configured for extended sun protection.

- Set the parameter "Automatic heating/cooling" on parameter page "O1 - Automatic heating/cooling" to "enabled".

The automatic heating/cooling function is enabled. The necessary parameters and communication objects are visible.

- Set the parameter "Automatic heating/cooling" on parameter page "O1 - Automatic heating/cooling" to "disabled".

The automatic heating/cooling function is deactivated. The corresponding parameters and objects are hidden. Only the extended sun protection without evaluation of the heating/cooling and of the presence signal is now configured.

- i** If the automatic heating/cooling activation parameters are changed, the group address assignments and the parameter settings are lost. For this reason, the automatic heating/cooling parameters should be selected directly at the beginning of configuration and then not be changed anymore later on.

Presetting the polarity of the "Heating/cooling switchover" object

The telegram polarity of the "Heating / cooling switchover" object can be preset. This means that an adaptation to the signals from existing room temperature controllers or from outside thermostats is possible.

For the parameters to be visible, automatic heating/cooling must be enabled on parameter page "O1 - Automatic heating/cooling".

- Set the parameter "Polarity of 'Heating/cooling switchover' object" to the required telegram polarity.

The heating/cooling signal is evaluated in accordance with the preset priority.

- i** An update of the "Heating / cooling switchover" object from active to active or from inactive to inactive shows generally no reaction. The behaviour of the output is only influenced if a change of state is detected.
- i** After switch-on of the bus supply voltage, the heating/cooling switchover function is initialised with an object value of "0".

Presetting the polarity of the "Heating/cooling presence" object

The telegram polarity of the "Heating / cooling presence" object can be preset. This means that an adaptation to the signals from existing KNX/EIB presence monitors or detectors is possible.

For the parameters to be visible, automatic heating/cooling must be enabled on parameter page "O1 - Automatic heating/cooling".

- Set the parameter "Polarity of 'Heating / cooling presence' object" to the required telegram polarity.

The presence signal is evaluated in accordance with the preset priority.

- i** An update of the "Heating / cooling presence" object from active to active or from inactive to inactive shows generally no reaction. The behaviour of the output is only influenced if a change of state is detected.
- i** After presence control of the bus supply voltage, the heating/cooling switchover function is initialised with an object value of "0".

Presetting a time delay for beginning and end of presence

The telegram received via the object "Heating / cooling presence" for transmission of the presence state (depending on polarity) can be evaluated with a time delay separately for the output.

For the parameters to be visible, automatic heating/cooling must be enabled on parameter page "O1 - Automatic heating/cooling".

- Set the parameter "Time delay at the beginning of presence" to the required delay time.

The telegram for activation of the presence mode will be evaluated with a delay corresponding to the setting.

- Set the parameter "Time delay at the end of presence" to the required delay time.

The telegram for deactivation of the presence mode will be evaluated with a delay corresponding to the setting.

- i** A setting of "0" in the parameters deactivates the respective delay time. In this case, the presence state is evaluated immediately on reception of a telegram.
- i** An update of the "Heating / cooling presence" object from active to active or from inactive to inactive shows generally no reaction. The behaviour of the output is only influenced if a change of state is detected. An update of the presence signal alone does not result in the activation of automatic operation either.
- i** The time delay is started after an update of the "Heating / cooling presence" object also in those cases where the automatic operation is deactivated so that the newly received presence state may possibly also be processed with a delay, if the automatic operation is activated later on.

Presetting the reaction of automatic heating/cooling

The behaviour of the output when automatic heating/cooling is active can be configured in the ETS. A distinction is made between four states in the evaluation of the three 1-bit signals "Presence", "Heating/cooling switchover" and "Sunshine / shading facade"...

- "Reaction at the **beginning** of sunshine / shading with **heating**",
- "Reaction at the **end** of sunshine / shading with **heating**",
- "Reaction at the **beginning** of sunshine / shading with **cooling**",
- "Reaction at the **end** of sunshine / shading with **cooling**".

The reaction of the output can be set separately in the ETS for each of the named states. There is no difference between the parameter settings for the individual states. For this reason, the following section only describes the possible configuration as an example.

The reaction at the end of automatic heating/cooling is set on parameter page "O1 - Automatic heating/cooling". Depending on the selected mode of operation, the ETS adapts the designations of the parameter settings ("raising" ↔ "opening the louver" / "lowering" ↔ "closing the louver").

For the parameters to be visible, automatic heating/cooling must be enabled on parameter page "O1 - Automatic heating/cooling".

- Set the parameter "Reaction at the ... of sunshine / shading" to "no reaction".
During automatic heating/cooling, the relays of the output show no reaction. Any movements still in progress will still be finished.
- Set the parameter "Reaction at the ... of sunshine / shading" to "raising" or "opening the louver".
During automatic heating/cooling, the device raises the blind or opens the venting louver.
- Set the parameter "Reaction at the ... of sunshine / shading" to "lowering" or "closing the louver".
During automatic heating/cooling, the device lowers the blind or closes the venting louver.
- Set the parameter "Reaction at the ... of sunshine / shading" to "stop".
During automatic heating/cooling, the device switches the relays of the output to the "stop" position. A drive movement, if any, will be interrupted.
- Set the parameter "Reaction at the ... of sunshine / shading" to "internal scene recall". The number of the scene to be recalled must be specified in the parameter "Scene number (1...8)".
During automatic heating/cooling, the device recalls the position value preset in the scene configuration for the output. This is not a scene recall as in direct operation, but only an approach to the corresponding scene position value.

- Set the parameter "Reaction at the ... of sunshine / shading" to "fixed position".
During automatic heating/cooling, the device recalls the fixed position value for the output.

- ❗ In the "Venetian blind" operating mode, the setting "fixed position" can only be selected in common for the height of the Venetian blind and for the slat position.

- "Fixed position" only: Set the parameter "Fixed position of Venetian blind", "Fixed position of roller shutter/awning" or "Fixed position of venting louver" to "as specified by parameter". Thereafter, set the parameter "Position of Venetian blind (0...100%)", "Position of roller shutter/awning (0...100%)" or "Position of venting louver (0...100%)" to the desired position.
During automatic heating/cooling, the output invariably approaches the configured position value.
- "Fixed position" only: Set the parameter "Fixed position of Venetian blind", "Fixed position of roller shutter/awning" or "Fixed position of venting louver" to "no change of current position".
With automatic heating/cooling, the last set position of the Venetian blind height, the roller shutter, awning or venting louver will be maintained.
- "Fixed position" and operating mode = "Venetian blind" only: Set the parameter "Fixed slat position (0...100%)" to the desired position value".
During automatic heating/cooling, the output invariably moves the slats to the configured position after the height of the Venetian blind has been adjusted.

- ❗ The configured reactions will not be executed if a function with a higher priority is active during automatic heating/cooling (e.g. safety function, forced position). The preset reaction will not be executed either, if the automatic sun protection is overridden on account of priority settings by a direct operation.
- ❗ "Internal scene recall" setting: For this setting, the scene function of the output must be enabled in the ETS. Otherwise, the positions approached during automatic heating/cooling are undefined positions. The scene position values stored in the device by a scene storage function will be approached as well. A delay configured for scene recalls has no influence on the recall of the scene value by the automatic heating/cooling function.

4.2.4.4.7 Scene function settings

Light scene function

A device can hold up to 8 scenes for output 1 and store scene position values for the height of a Venetian blind, roller shutter or awning or the position of a venting louver. In the 'Venetian blinds' mode, the user can also preset slat positions. The scene values are recalled or stored via a separate scene extension object by means of extension telegrams. A scene recall can optionally take place after a delay.

The datapoint type of the extension object permits addressing a maximum of 64 scenes. This means that, in the configuration of a scene, it is possible to specify which scene number (1...64) contacts the internal scene (1...8).

The scene function must be enabled on parameter page "O1 - Enabling functions", for the required communication objects and parameters (on the parameter page "O1 - Scenes") to be visible.

Like the output control via short time, long time or position telegrams, the scene function should be assigned to direct operation. For this reason, a recalled scene position can at any time be overridden by a forced position or a safety function. The scene position last recalled can also be readjusted by other telegrams of the direct operation mode. The priority of direct operation and also of the scene function can be configured with respect to the sun protection function (see chapter 4.2.4.4.5. Sun protection settings).

Presetting a scene recall delay for the scene function

Each scene recall of the output can optionally also be delayed. With this feature, dynamical scene sequences can be configured if several outputs are combined with cyclical scene telegrams.

The scene function must be enabled on parameter page "O1 - Enabled functions".

- Set the parameter "Delay scene recall?" on parameter page "O1 - Scenes" to "yes".

The delay time is now activated and can be configured separately. The delay only influences the scene recall of the output. The delay time is started on arrival of a recall telegram. The corresponding scene will be recalled and the output set to the respective scene position value only after this time has elapsed.

- i** Each scene recall telegram restarts the delay time and retriggers it. If a new scene recall telegram is received while a delay is active (scene recall not yet executed), the old (and not yet recalled scene) will be rejected and only the scene last received executed.
- i** The scene recall delay has no influence on the storage of scene values. A scene storage telegram within a scene recall delay terminates the delay and thus the scene recall.
- i** In case of bus voltage failure, all time functions will be stopped. Therefore, all scene recalls that are still in the delay stage will be aborted. A scene recall received shortly before bus voltage failure is then lost, if the corresponding delay has not yet elapsed. A delayed scene recall will also be aborted, if a function with a higher priority (forced position, safety, sun protection, if the priority is the same as or higher than that of direct operation) is activated. The scene recall is nevertheless stored internally so that the scene positions last recalled can be tracked at the end of a higher-ranking function.

Presetting the ETS download behaviour for the scene function

During storage of a scene, the scene values are stored permanently in the device (cf. "Presetting the storage behaviour for scene functions"). To prevent the stored values from being replaced during ETS programming of the application or of the parameters by the originally programmed scene position values, the device can inhibit overwriting of the scene values. As an alternative, the original values can be reloaded into the device during each programming run of the ETS.

The scene function must be enabled on parameter page "O1 - Enabled functions".

- Set the parameter "Overwrite the values values in the device during ETS download ?" to "Yes".

During each ETS programming of the application or of the parameters, the scene values configured in the ETS for the output will be programmed into the device. Scene values stored in the device by means of a storage function will be overwritten, if any.

- Set the parameter "Overwrite the values values in the device during ETS download ?" to "No".

Scene values stored in the device with a storage function will be maintained. If no scene values have been stored, the position values last programmed in the ETS remain valid.

- i** When the device is put into operation for the first time, this parameter should be set to "yes" so that the output is initialised with valid scene values. In the device as delivered, the scene positions are internally set to default values as in the ETS product database.

Presetting scene numbers

The datapoint type of the scene extension object permits addressing of up to 64 scenes max. For this reason, the scene number (1...8) with which the scene is addressed, i.e. recalled or stored, must be determined for each internal scene (1...64) of the output.

The scene function must be enabled on parameter page "O1 - Enabled functions".

- Set the parameter "Scene y activatable by scene number" (y = number of the scene (1...8)) on parameter page "O1 - Scenes" for each scene to the numbers with which the scenes are to be addressed.

A scene can be addressed with the configured scene number. A setting of "0" deactivates the corresponding scene so that neither recalling nor storage is possible.

- i** If the same scene number is configured for several scenes, only the scene with the lowest internal scene number (1...8) will be addressed. The other internal scenes will be ignored in this case.

Presetting scene positions

Moreover, the position value (Venetian blind, roller shutter, awning, venting louver position) to be set for the output in case of a scene recall must be specified as well. In the "Venetian blind" mode, the height of the Venetian blind and the slat position can be preset.

The scene function must be enabled on parameter page "O1 - Enabled functions".

- Set the parameter "Position ... for scene y" (y = number of the scene (1...8)) on parameter page "O1 - Scenes" for each scene to the desired position (0 %...100 %).

In case of a scene recall, the output is set to the configured position.

- i** The configured position values are adopted in the device during programming with the ETS only if the parameter "Overwrite values stored in the device during ETS download ?" is set to "yes".
- i** Before approaching the required scene position, the device may perform a reference movement, if the current position data is unknown (e.g. after an ETS programming operation or after switch-on of the bus voltage).

Presetting the storage behaviour for the scene function

The current position value of a Venetian blind, roller shutter, awning, venting louver and also of a slat can be stored internally via the extension object on reception of a scene storage telegram. The position value can be influenced before storage by all functions of the output (e.g. short-time and long-time operation or scene recall telegram, safety and sun protection function).

The scene function must be enabled on parameter page "O1 - Enabled functions".

- Set the parameter "Storage function for scene y" (y = number of the scene (1...8)) on parameter page "O1 - Scenes" for each scene to "yes".

The storage function is activated for the scene in question. On reception of a storage telegram via the "Scene extension" object, the current position value will be internally stored.

- Set the parameter "Storage function for scene y" (y = number of the scene (1...8)) on parameter page "O1 - Scenes" for each scene to "no".

The storage function is deactivated for the scene in question. A storage telegram received via the "scene extension" object will be rejected.

- ❗ The following rules apply for the position data to be stored:

The current blind, slat and louver positions are stored. With Venetian blinds, the height to be stored is always referred to a slat position of 100 %. A position temporarily approached will also be stored for that output that are involved in a travel movement at the time of data storage.

On account of the fact that position data is stored as integer percentage values (rounding to 0...100), a minor deviation from the set positions on a later scene recall cannot be avoided.

The data is only stored if the bus voltage has been available before without interruption for at least 20 seconds after the last reset (storage capacitors sufficiently charged for storage purposes). The data will not be stored, if the position data is unknown.

4.2.4.4.8 Forced position settings

Forced position function

The forced position function can be enabled for the output 1. The forced position has the highest priority. An active forced position therefore overrides the safety function, the sun protection function and the direct operation (short time, long time telegram, scenes, positioning). During a forced-position state, the output is locked so that it can no longer be controlled with functions of a lower priority.

The forced position function possesses a separate 2-bit communication object. The state of the output in case of a forced position function is directly determined by the forced position telegram. The first bit (bit 0) of the "Forced position" object specifies the travel direction to be forced onto the output as in long time operation. The second bit (bit 1) activates or deactivates the forced-position state (cf. table 6).

Bit 1	Bit 0	Function
0	x	Forced position not active normal control
0	x	Forced position not active normal control
1	0	Forced position active, raising / opening the louver
1	1	Forced position active, lowering / closing the louver

Table 6: Bit coding of forced position

The behaviour of an output at the end of the forced-position function can be configured. In addition, the forced object can be initialised on bus voltage return.

- i** The forced movement time required by an output to move the drive into the end positions is determined by the "Movement time" parameter on parameter page "O1 - Times". Like long time operation, a forced-position movement is derived from the travel time. Downward movement: movement time + 20 %; Upward movement: movement time + 20 % + configured movement time extension. Forced movements are not retriggerable.
- i** The slats of blinds are not repositioned at the end of forced movements into the end positions.
- i** Updates of the forced position object from "forced position active" to "forced position active" while maintaining the forced movement direction or from "forced position inactive" to "forced position inactive" show no reaction.
- i** After programming of the application or of the parameters with the ETS, the forced position is always cancelled.
- i** The current state of the forced position function will be stored in case of bus voltage failure.

Enabling the forced position function

The forced position function can be enabled.

- Set the parameter "Forced position function" on parameter page "O1 - Enabled functions" to "enabled".

The forced position function is enabled. The corresponding communication object is created and the respective parameters on parameter page "O1 - Forced position" become visible.

Presetting the behaviour at the end of the forced position function

The behaviour of the output at the end of the forced position function can be configured. The behaviour is configured on parameter page "O1 - Forced position".

The forced position function of the output must be enabled on parameter page "O1 - Enabled functions". Only then are the parameters for the forced position function visible.

- Set the parameter "Behaviour at the end of the forced position function" to "position tracking".

At the end of a forced position function, the output will be set to the state adjusted statically before the forced position function or to the state tracked and internally stored during the forced position function. The position objects, the long time object and the scene function are tracked.

- Set the parameter "Behaviour at the end of the forced position function" to "no change".

At the end of forced position function, the state last adjusted will not be changed. Thereafter, the output is again enabled. Any movements still in progress at this instant will still be finished.

- i** Parameter setting "Position tracking": The device can track absolute positions (position telegram, scene value) during activated forced control only if the position data are known and if positions have been predefined. If this is not the case, no reaction takes place at the time forced control is enabled.
Position data can be tracked, if the output has been in a defined position before the forced position function or if a new position telegram has been received via the position objects while the forced position function was interlocked. In the latter case, a reference movement will be executed when the forced position function is enabled, if the position was unknown before or during the safety interlock.
Known slat positions will also be tracked as described. This is also the case, when the height of the Venetian blind is unknown.
Long time movements (movements without position preset) will, however, always be tracked.
- i** The preset "Behaviour at the end of the forced position function" will only be executed, if the output passes over to direct operation at the end of the forced position function. If a safety function or a sun protection function is activated (independent of the preset priority with respect to direct operation), the function with the next lower priority will be executed. The configured behaviour is not executed when the forced position is terminated by a specification on bus voltage return. The parameter "Behaviour after bus voltage return" will in this case be evaluated.

Presetting the behaviour of the forced position function after bus voltage return

The forced position communication object can be initialised after bus voltage return. In this way, an output can be influenced and locked on bus initialisation when the forced position function is being activated.

The behaviour of the forced position after bus voltage return is configured separately on the parameter pages "O1 - Forced position".

Depending on the selected operating mode, the ETS adapts the designations of the parameter settings ("raising" ↔ "opening the louver" / "lowering" ↔ "closing the louver").

After bus voltage return, the configured state is transferred to the "Forced position" communication object.

The forced position function of the output must be enabled on parameter page "O1 - Enabled functions". Only then are the channel-related parameters for the forced position function visible.

- Set the parameter "Behaviour after bus voltage return" to "no forced position active".

The forced position is deactivated after bus voltage return. In this case, the parameter "Behaviour after bus voltage return" will be evaluated on bus voltage return.

- Set the parameter "Behaviour after bus voltage return" to "forced position function ON, raising" or "forced position function ON, opening the louver".

After bus voltage return, the forced position is activated and the blind raised or the venting louver opened. The output is interlocked by forced control until an enable signal is received via the bus. In this case, the parameter "Behaviour after bus voltage return" will not be evaluated for the output.

- Set the parameter "Behaviour after bus voltage return" to "forced position function ON, lowering" or "forced position function ON, closing the louver".

After bus voltage return, the forced position is activated and the blind lowered or the venting louver closed. The output is interlocked by forced control until an enable signal is received via the bus. In this case, the parameter "Behaviour after bus voltage return" will not be evaluated for the output.

- Set the parameter "Behaviour after bus voltage return" to "state of forced position before bus failure".

After bus voltage return, the forced position state last selected and internally stored before bus voltage failure will be tracked. An ETS programming operation deletes the stored state (reaction in that case same as with "no forced position active"). If the tracked state corresponds to "no forced position active", the parameter "Behaviour after bus voltage return" will be executed on return of bus voltage.

- i** Setting or tracked state "no forced position active": The reaction of the output after return of bus voltage is defined by the parameter "Behaviour after bus voltage return".
- i** After programming of the application or of the parameters with the ETS, the forced position is always cancelled.

4.2.4.4.9 Fabric stretching settings

Fabric-stretching function

In the roller shutter/awning operating mode, the fabric stretching function can be activated. The fabric stretching function permits 'smoothing' the fabric of an awning tight after lowering. The fabric stretching function can also be used with roller shutters to reopen the slits of the shutter curtain after a downward movement into the lower end position.

If activated in the ETS parameters, fabric stretching is executed during each downward movement after stopping and after the configured switchover delay has elapsed. The curtain is then 'stretched' by moving briefly into the opposite movement direction (Figure 35).

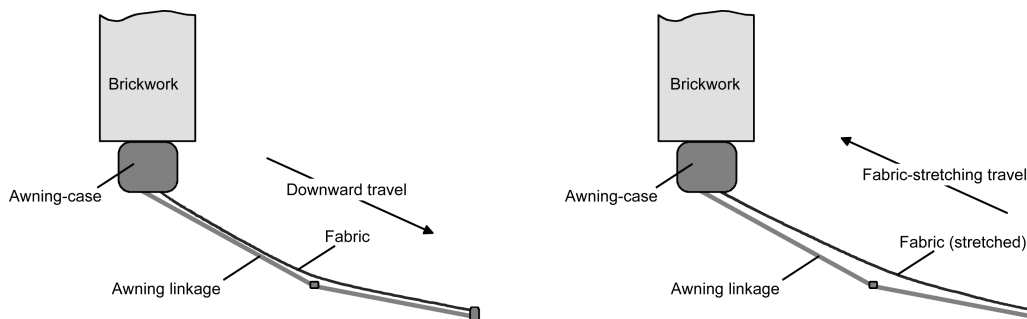

Figure 35: Fabric stretching in an awning

The downward movement can be triggered by any of the following events: Long time, short time or position telegram, forced position, safety or sun protection function or scene recall.

Fabric stretching is never effected in upward movements.

- i Fabric stretching affects the determination of positions and the position feedback since a fabric stretching movement changes the position of a shutter or an awning. In a positioning move into the lower end position (100 %), the position value reported back after the fabric stretching operation will always be a smaller one.
- i Fabric stretching cannot be configured in the Venetian blind or louver modes of operation.

Activating the fabric stretching function

The fabric stretching function can be activated on parameter page "O1 - Enabled functions".

The operating mode selected must be the "Roller shutter/awning" mode.

- Set the parameter "Fabric stretching function" to "enabled".
Parameter page "O1 - Fabric stretching" is enabled and the fabric stretching function is activated.

- i Fabric stretching cannot be configured in the Venetian blind or louver modes of operation.

Presetting the fabric stretching function

The fabric stretching function can be configured independently for each roller shutter or awning output on parameter page "O1 - Fabric stretching". The movement time required for fabric stretching by means of a movement in opposite direction can be configured.

The fabric stretching function must be activated.

- Select the desired value for the "Time for fabric stretching" parameter.
After the end of a downward movement the blind stops and – after the switchover delay has elapsed – moves backwards in opposite direction for a period corresponding to the configured fabric stretching time.

- ⓘ Set the time for fabric stretching to less than the configured or measured movement time of the roller shutter or awning. Otherwise, there is the risk of malfunction.
- ⓘ Fabric stretching will only be effected if the downward movement lasts longer than the configured fabric stretching time.

4.2.4.5 Channel-oriented functions for the valve output

4.2.4.5.1 General settings

Valve direction of action

Valve drives, which are closed in the deenergised state, and valve drives, which open in the deenergised state, can be connected to the valve output. The direction of action of a deenergised valve drive is determined by the physical structure of the drive and is usually prespecified by the manufacturer of these devices. For the valve drives to be controlled 'with the correction direction of action', the valve direction of action of the connected drives must be configured in the ETS.

Setting the valve direction of action

The valve direction of action can be set on the parameter page "O2 - General".

- Set the "Valve direction of action (valve in deenergised state)" to "closed".

With switching command values, the switching telegram received via the "Command value" object is forwarded directly to the output. This means that, if an "ON" telegram is received, the output is energised and thus the valve completely opened. Switching the output off completely closes the valve when an "OFF" telegram is received (Figure 36).

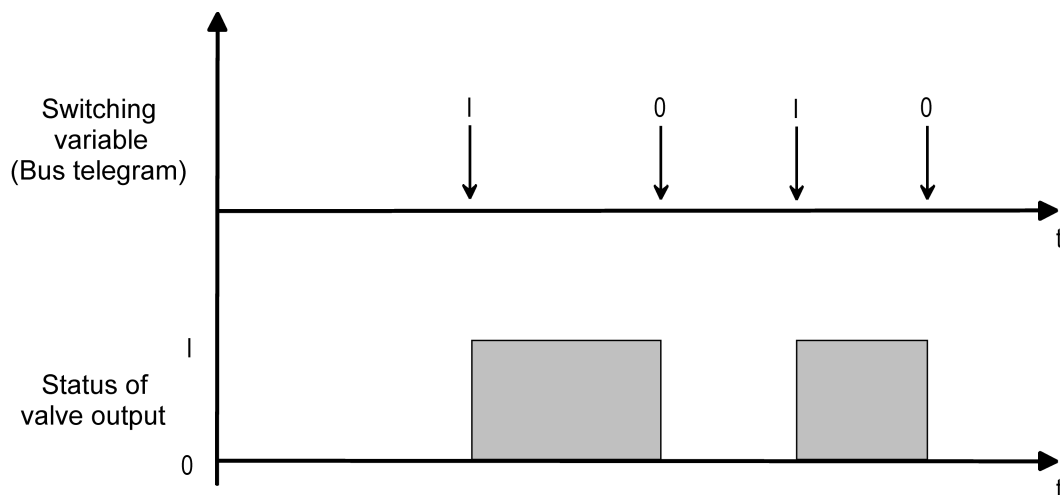

Figure 36: Conversion of a switching command value to an output signal with deenergised, closed valve drives (example)

With constant command values or constant valve setpoint positions (for example, with a forced position or in emergency operation), the valve output is either energised or deenergised cyclically using a pulse width modulation according to the constant valve position to be approached. The scanning ratio of the pulse width modulation is converted in such a way that the switch-on time corresponds directly to the valve target position (Figure 37).

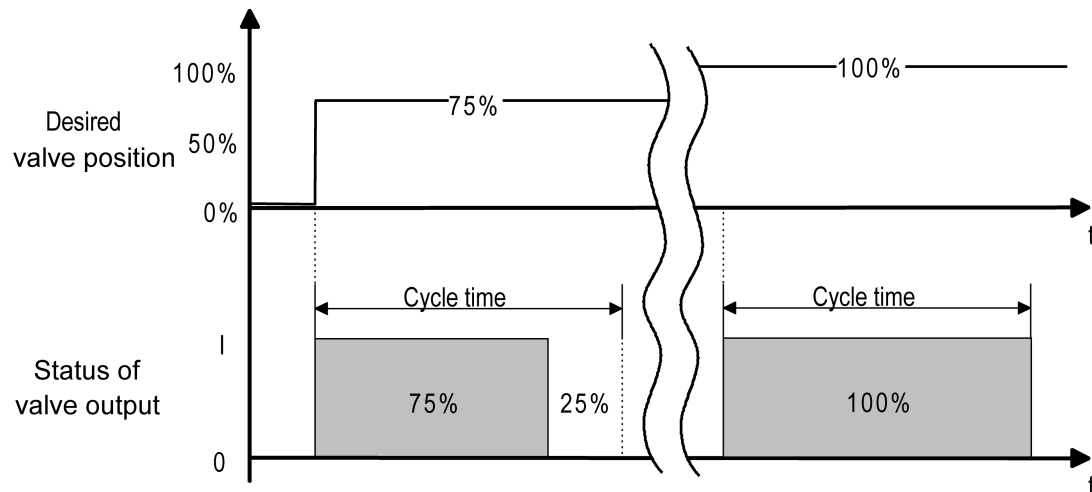

Figure 37: Conversion of a constant valve setpoint position to an output signal with deenergised, closed valve drives (example)

- Set the "Valve direction of action (valve in deenergised state)" to "open".
 With switching command values, the switching telegram received via the "Command value" object is forwarded directly to the output. This means that, if an "ON" telegram is received, the output is deenergised and thus the valve completely opened. Switching the output on completely closes the valve when an "OFF" telegram is received (Figure 38).

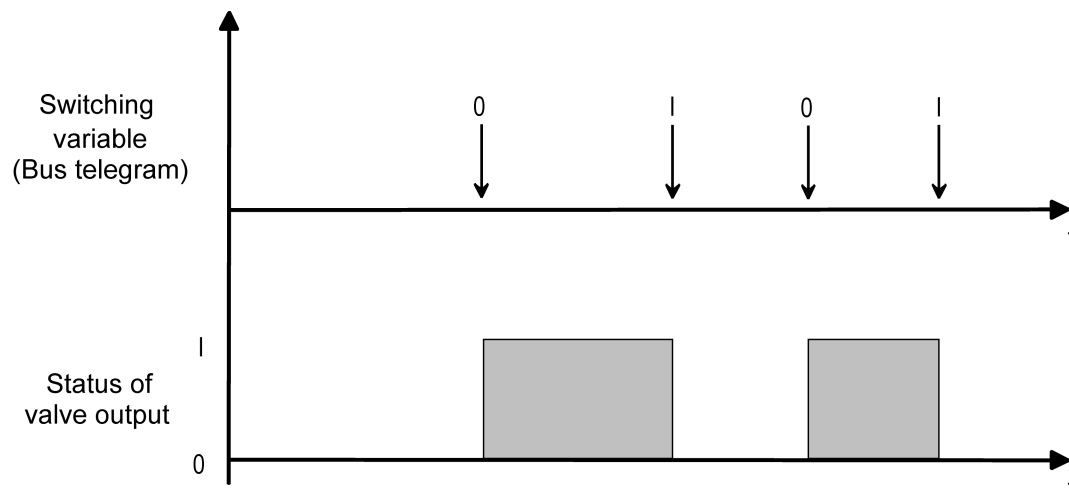

Figure 38: Conversion of a switching command value to an output signal with deenergised, opened valve drives (example)

With constant command values or constant valve setpoint positions (for example, with a forced position or in emergency operation), the valve output is either energised or deenergised cyclically using a pulse width modulation according to the constant valve position to be approached. The scanning ratio of the pulse width modulation is converted in such a way that the switch-off time corresponds directly to the valve target position (Figure 39).

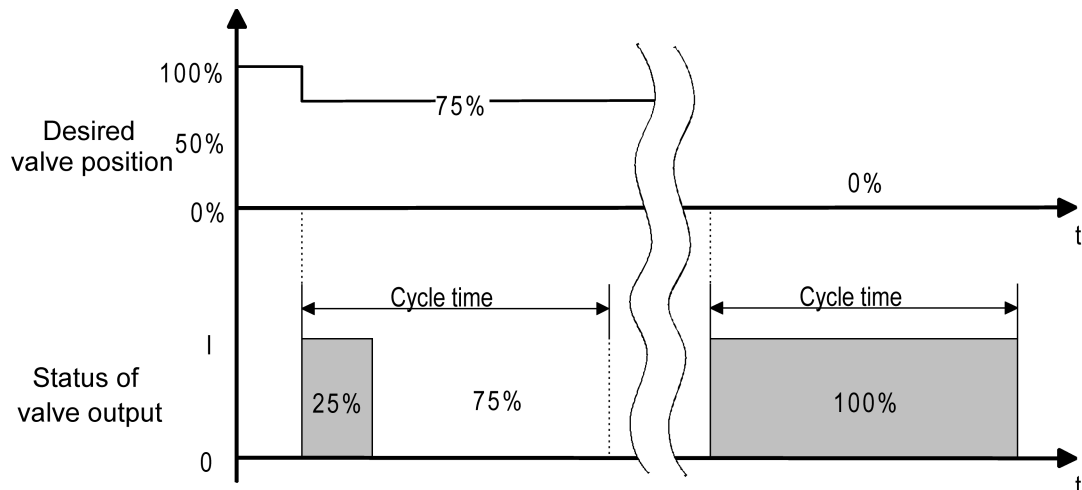

Figure 39: Conversion of a constant valve setpoint position to an output signal with deenergised, opened valve drives (example)

- i** Depending on the conversion of the PWM switch-on time to the valve setpoint position, there is no unintentional average value shift for the different valve types.

Example:

Command value: 60 % ->

Scanning ratio, deenergised closed: 60 % On, 40 % Off,

Scanning ratio, deenergised opened: 40 % On, 60 % Off,

- i** If there is a mains voltage failure or a short-circuit at the valve output, the connected valve drives are no longer controlled electrically, meaning that the drives switch to the deenergised status preset by the manufacturer (deenergised opened / deenergised closed).
With the device status messages ("Command value status", "Valve closed"), a valve completely opened by a mains voltage failure or short-circuit (valve direction of action deenergised open) is evaluated as a closed valve, as the valve status was caused by a fault.

Forced position function

The valve can be idle in various operating states, which it may be possible to activate using separate communication objects. One of these object-controlled operating states is the forced position.

With the forced position of the valve output, a constant valve forced position (0 % to 100 %) can be stored in the device, which is applied as the valve setpoint in an activated forced position and which is executed by a pulse width modulation. The valve forced position can be set in the ETS differently for summer and winter operation, if the operating mode switchover is enabled.

- i** With an active forced position, the configured pulse width modulation is also executed when the output is configured to a switching 1-bit command value.

Enabling the forced position function

The forced position function can be activated on the parameter page "O2 - General".

- Set the parameter "Forced position through object to "Enabled". Configure the parameter "Value for forced position (0...100%)" to the required valve forced position. The "Value for forced position..." parameter may be visible twice if the operating mode switchover is enabled. In this case, it is possible to specify different valve forced positions for summer and winter operation in the ETS.

The forced position function is enabled and the 1-bit communication object "Forced position" is visible in the ETS. As soon as an "ON" telegram was received, the device activates the forced position for the valve output and controls the valve drive to the specified valve forced position value. The valve output can then no longer be controlled using command values from the bus.

If the device receives an "OFF" telegram via the forced object, it deactivates the forced position and reenables bus control using the command values. The command most recently received before or during the forced position and stored in the device is applied as the new command value setpoint at the end of the forced position.

- Set the parameter "Forced position through object to "Disabled".

The forced position function is deactivated, meaning that the appropriate object is not visible in the ETS.

However, the parameters "Value for forced position" or "Value for summer forced position" or "Value for winter forced position" are visible and settable in the ETS because, on bus voltage failure and after a bus voltage return or after an ETS programming operation, the forced value can be applied as a command value setpoint and thus a configurable value must be available in the ETS.

- i** The forced position has a higher priority than the command value limit. This means that, in the case of a forced position, the command value setpoint configured in the ETS is always set at the valve output and is not limited by the command value limit. However, at the end of a forced position the command value limit is again taken into account, if it is active at this time. In this case, the added command value is limited at the end of the forced position.
- i** The operating mode (summer / winter) can also be switched over using the object during an activated forced position. In this case, the device adjusts the pulse width modulation to the valve position value of the valid operating mode immediately after the switchover.
- i** Updates of the forced object from "ON" to "ON" or "OFF" to "OFF" do not produce a reaction.
- i** Behaviour of the forced position function after a bus voltage return: If there is a bus voltage failure, the state of the "Forced position" object is saved in the non-volatile memory of the device.
A forced position function activated using the forced position object before the bus voltage failure can then be activated after bus voltage return and continue to be executed if the "Behaviour after bus voltage return" of the valve output is configured to "State as before bus failure". Otherwise, the forced position is always deactivated after bus voltage return. After bus voltage return, the operating mode (summer / winter) is initialised according to the parameter "Operation mode after device reset".
The forced position function is always deactivated after an ETS programming operation.
- i** The anti-sticking protection has a higher priority than a forced position, meaning that the anti-sticking protection overrides forced operation. By contrast, the forced position has a higher priority than emergency operation or operation through command value telegrams.

Operating switchover, summer / winter operation

Constant valve position values (0...100%) can be configured in the ETS for the forced position function and emergency operation. If a forced position or emergency operation was activated, the device switches the specified valve position at the valve output using pulse width modulation.

It is possible to specify different valve position values for summer and winter in the ETS for the named functions. For example, emergency operation activated during a fault as part of command value monitoring can cause a different valve opening than winter operation. In addition, a different valve position can be specified according to the season for a forced position.

Enabling operating mode switchovers

For the device to be able to distinguish between the summer and winter valve position values for the forced position function and emergency operation, the operating mode switchover must be enabled in the ETS.

- Set the "Summer/winter mode switchover ?" parameter on the parameter page "O2 - General" to "Yes".

The operating mode switchover for summer and winter operation is enabled. The 1-bit communication object "Summer/winter switchover" becomes visible in the ETS. The operating mode can be switched over by a bus telegram at any time using this object. In addition, the ETS automatically makes additional parameters visible, meaning that separate valve position values can be configured for summer and winter for the forced position function and emergency operation.

- Set the "Summer/winter mode switchover ?" parameter on the parameter page "O2 - General" to "No".

The operating mode switchover for summer and winter operation is disabled. Only one valve position value can be configured separately for the forced position function and emergency operation in the ETS. No distinction is made between summer and winter operation.

- i** The summer / winter operating mode switchover is deactivated in the as-delivered state. The device then only works with one valve position value for the forced position and emergency operation.

Setting the telegram polarity for the operating mode switchover

The telegram polarity of the 1-bit "Summer/winter switchover" communication object can be set in the ETS.

The operating mode switchover must have been enabled in advance.

- Set the "Polarity, summer/winter switchover object" on the parameter page "O2 - General" to "Summer = 0 / Winter = 1".

Summer operation is activated by an "OFF" telegram and winter operation by an "ON" telegram.

- Set the "Polarity, summer/winter switchover object" on the parameter page "O2 - General" to "Summer = 1 / Winter = 0".

Summer operation is activated by an "ON" telegram and winter operation by an "OFF" telegram.

- i** The object state after a device reset (ETS programming operation, bus voltage return) can be set separately in the ETS (see "Setting the operating mode after a device reset").

- i** The operating mode can also be switched over using the object during activated emergency operation or an activated forced position. In this case, the device adjusts the pulse width modulation to the valve position value of the valid operating mode immediately after the switchover.

In addition, the value for emergency operation and the value for the forced position can be applied as a valve position value after an ETS programming operation or a bus voltage return and pulse width modulation started. The device only uses the valve position values (0...100 %) configured in the ETS, taking the set or added operation mode into account. The forced position function or emergency operation are not activated, meaning that the switchover of the operation mode after one of the named events does not lead to a switchover of the summer/winter valve position.

Setting the operating mode after device reset

After an ETS programming operation or bus voltage return, the device automatically initialises the value of the communication object "Summer/winter switchover". The initialisation value is configured in the ETS.

The operating mode switchover must have been enabled in advance.

- Set the parameter "Operating mode after ETS programming operation" on the parameter page "O2 - General" to "Summer operation".
Summer operation is initialised immediately after bus voltage return or ETS programming.
- Set the parameter "Operating mode after ETS programming operation" on the parameter page "O2 - General" to "Winter operation".
Winter operation is initialised immediately after bus voltage return or ETS programming.
- ❗ The operating mode set after a device reset is also added to the object "Summer/winter switchover", taking the configured telegram polarity into account, and can be read out (set the "R" flag).

Anti-sticking protection

The device possesses automatic anti-sticking protection, in order to prevent calcification or sticking of a valve which has not been operated for some time.

Enabling anti-sticking protection

Anti-sticking protection is enabled on parameter page "O2 - General".

- Set the parameter "Anti-sticking protection" to "enabled".
Anti-sticking protection is activated cyclically every 6 days, irrespective of the current operating state and the active valve position. In so doing, the device switches the valve output on for approx. 5 minutes. After this switch-on phase, the device switches the valve output off for approx. 5 minutes. This ensures that the valves are opened and closes almost completely, meaning that the entire valve movement path is 'travelled' once. After the anti-sticking protection, the device again controls the output according to the set operating state.
- Set the parameter "Anti-sticking protection" to "disabled".
The anti-sticking protection is completely deactivated and is not executed.
- ❗ Irrespective of the bus voltage, anti-sticking protection always runs 'in the background' and is not signalled to the bus using the status objects.
- ❗ The cycle time of the anti-sticking protection is only restarted after the bus voltage has been switched on again on the device or the device was reprogrammed using the ETS. In these cases, at least approx. 6 days must elapse until the anti-sticking protection is automatically executed for the first time.
- ❗ The anti-sticking protection has a higher priority than a forced position or emergency operation. These operating states are overridden by the anti-sticking protection, as normal operation is by command values.

Reset and initialisation behaviour

The state of the valve output after bus voltage return or after an ETS programming operation can be set in the ETS.

Behaviour in case of bus voltage failure

The device is supplied solely via the bus voltage. If the bus voltage fails or is switched off, the device does not work either, meaning that the valve output is no longer controlled electrically. As a result, the drives switch over to the deenergised state specified by the manufacturer.

- i** If the bus voltage fails, the states of the last command value/valve setpoint position and the "Forced position" object are stored in the non-volatile memory of the device. Storage takes place so that the states can be restored on bus voltage return, if this is configured for bus voltage return.

The data is only stored if the bus voltage has been available before without interruption for at least 20 seconds after the last reset (storage capacitors sufficiently charged for storage purposes). In all other cases nothing is stored.

Setting the behaviour on bus voltage return

The parameter "Behaviour after bus voltage return" can be preset on parameter page "O2 - General". The parameter defines the behaviour as soon as the the bus supply voltage is switched on.

- Set the parameter to "Close valve".

After bus voltage return, the device closes the connected valve drives completely. In so doing, the valve direction of action configured in the ETS is taken into account so that the output is switched off for deenergised closed valves and the output is energised for deenergised opened valves.

- Set the parameter to "Open valve".

After bus voltage return, the device opens the connected valve drives completely. In so doing, the valve direction of action configured in the ETS is taken into account so that the output is switched off for deenergised closed valves and the output is energised for deenergised opened valves.

- Set the parameter to "Valve to value for forced position".

The device sets the valve drive to the value for the forced position (0...100 %) configured in the ETS. In the 0 % setting, the output is closed completely, whilst, in the 100 % setting it is completely opened. The energisation of the valve output always takes place taking the set valve direction of action into account. The forced position value is executed as pulse width modulation (PWM) even in the case that the output is configured to a switching command value (1 bit).

In the settings 1...99 % for the forced position value, the device carries out PWM at the valve output after bus voltage return until a new valve state is specified.

- Set the parameter to "Valve to value for emergency operation".

The device sets the valve drive to the value for emergency operation (0...100 %) configured in the ETS. In the 0 % setting, the output is closed completely, whilst, in the 100 % setting it is completely opened. The energisation of the valve output always takes place taking the set valve direction of action into account. The forced position value is executed as pulse width modulation (PWM) even in the case that the output is configured to a switching command value (1 bit).

In the settings 1...99 % for the emergency operation value, the device carries out PWM at the valve output after bus voltage return until a new valve state is specified.

- Set the parameter to "State as before bus failure".

After bus voltage return, the state last selected and internally stored before bus voltage failure (last command value/valve setpoint position and state of the "Forced position" object) will be tracked. If the last command value before the bus failure was limited by the command value limit, then the limited value is added as the last active value after bus voltage return.

- i** The device only executes the configured "Behaviour after bus voltage return" only if the last ETS programming of the application or of the parameters ended at least approx. 20 s prior to switching on the bus voltage. Otherwise ($T_{ETS} < 20$ s), the "Behaviour after ETS programming" will be adopted also in case of bus voltage return.

- i** The following should be observed for the settings "Valve to value for forced position" and "Valve to value for emergency operation":
The device only uses the valve position values (0...100 %) configured in the ETS. The forced position function or emergency operation are not activated. However, it should be noted that the value for the forced position has a higher priority than a command value limit. Thus, a forced position value set for after bus voltage return is not limited by the command value limit. However, a value for emergency operation can be limited.
The values for forced position and emergency operation are also dependent on the summer / winter operation of the device. If the operating mode switchover is activated for the valve outputs (see page 103), two separate valve position values for summer operation and winter operation are configured and distinguished between in the ETS.
After bus voltage return, the device reinitialises and uses the operating mode configured in the ETS according to the parameter "Operation mode after device reset".
- i** In the setting "State before bus failure": An ETS programming operation of the application or the parameter deletes the internally stored states.
- i** A valve state set after bus voltage return is added to the status object.
- i** The cycle times of the anti-sticking protection and the command value monitoring are restarted after the bus supply voltage is switched on again.
- i** The valve state configured in the ETS is set after bus voltage return. In so doing, the status message "Valve closed" is updated according to the current status and a telegram sent to the bus, providing the status message is enabled.
However, transmission of the status telegram shall only take place after the delay time after bus voltage return configured in the ETS has elapsed.
- i** Optionally, the command value limit for 1-byte command values can be active after bus voltage return (see page 119). In this case, it should be noted that the reactions specified after bus voltage return are influenced and thus limited by the command value limit (exception: "Valve to forced position value").
- i** After bus voltage return, the device retracts a short-circuit message transmitted before bus voltage failure by transmitting an alarm telegram appropriate to the polarity set in the ETS (see page 123).

Presetting the behaviour after ETS programming

The parameter "Behaviour after ETS programming operation" can be preset on the parameter page "O2 - General". This parameter can be used to configure the behaviour of the valve output, irrespective of the behaviour after bus voltage return.

- Set the parameter to "Close valve".
After an ETS programming operation, the device closes the connected valve drives completely. In so doing, the valve direction of action configured in the ETS is taken into account so that the output is switched off for deenergised closed valves and the output is energised for deenergised opened valves.
- Set the parameter to "Open valve".
After an ETS programming operation, the device opens the connected valve drives completely. In so doing, the valve direction of action configured in the ETS is taken into account so that the output is switched off for deenergised closed valves and the output is energised for deenergised opened valves.
- Set the parameter to "Valves to value for forced position".
The device sets the connected valve drives to the value for the forced position (0...100 %) configured in the ETS. In the 0 % setting, the output is closed completely, whilst, in the 100 % setting it is completely opened. The energisation of the valve output always takes place taking the set valve direction of action into account.
In the settings 1...99 % for the forced position value, the device carries out PWM at the valve output after an ETS programming operation until a new command value or another function is specified or activated. In this case, the PWM is also executed after an ETS programming operation, should the output be configured to a switching command value (1-bit).
- Set the parameter to "Valves to value for emergency operation".

The device sets the connected valve drives to the value for emergency operation (0...100 %) configured in the ETS. In the 0 % setting, the output is closed completely, whilst, in the 100 % setting it is completely opened. The energisation of the valve output always takes place taking the set valve direction of action into account.

In the settings 1...99 % for the emergency operation value, the device carries out PWM at the valve output after an ETS programming operation until a new command value or another function is specified or activated. In this case, the PWM is also executed after an ETS programming operation, should the output be configured to a switching command value (1-bit).

- i** The following should be observed for the settings "Valve to value for forced position" and "Valve to value for emergency operation":
The device only uses the valve position values (0...100 %) configured in the ETS. The forced position function or emergency operation are not activated. However, it should be noted that the value for the forced position has a higher priority than a command value limit. Thus, a forced position value set for after an ETS programming operation is not limited by the command value limit. However, a value for emergency operation can be limited.
The values for forced position and emergency operation are also dependent on the summer / winter operation of the device. If the operating mode switchover is activated for the valve outputs (see page 103), two separate valve position values for summer operation and winter operation are configured and distinguished between in the ETS.
- i** The configured behaviour will be executed after every application or parameter download by the ETS. A simple download of the physical address alone or partial programming of only the group addresses has the effect that this parameter is disregarded and that the configured "Behaviour after bus voltage return" will be executed instead.
- i** Optionally, the command value limit for 1-byte command values can be active after an ETS programming operation (see page 119). In this case, it should be noted that the reactions specified after an ETS programming operation are influenced and thus limited by the command value limit (exception: "Valve to forced position value").
- i** The valve state configured in the ETS is set after an ETS programming operation. In so doing, the status message "Valve closed" is updated by the device according to the current status and a telegram sent to the bus, providing the status message is enabled. However, transmission of the status telegram shall only take place after the delay time after bus voltage return configured in the ETS has elapsed.
- i** A valve state set after an ETS programming operation is added to the feedback object.

4.2.4.5.2 Command value settings

Command value evaluation

The valve output can be controlled via switching with a 1-bit command value telegram or alternatively constantly with a 1-byte command value telegram. Constant command values are converted via pulse width modulation at the output. The cycle time of the output signal is generally configurable in this case.

Command value telegrams are usually transmitted to the device via the bus by a KNX/EIB room temperature controller. In so doing, the room temperature controller generates the command value telegrams using a control algorithm. It should be noted that the actuator does not carry out temperature control itself.

Configuring the command value type (1-bit / 1-byte)

The type of command value can be set. This configuration is possible on parameter page "O2 - Command value".

- Set the "Type of command value" parameter to "Switching (1-bit)".

In normal operation, the switching telegram received via the 1-bit "Command value" object, is directly forwarded to the valve output of the device, taking the valve direction of action (deenergised open / deenergised closed) into account (Figure 40). This means that, if an "ON" telegram is received, the valve is completely opened (output energised on valve direction of action = closed / output deenergised on valve direction of action = opened).

If an "OFF" telegram is received, the valve is completely closed (output deenergised on valve direction of action = closed / output energised on valve direction of action = opened).

In a forced position, emergency operation, after an ETS programming operation and on bus voltage return, a constant valve setpoint position value (0...100%) can be configured and activated in the ETS, even with a 1-bit command value. In this case, the setpoint is set by pulse width modulation on the valve output, taking the "Cycle time (PWM of the valve output" into account (see "Pulse width modulation for constant command values and constant setpoint valve positions").

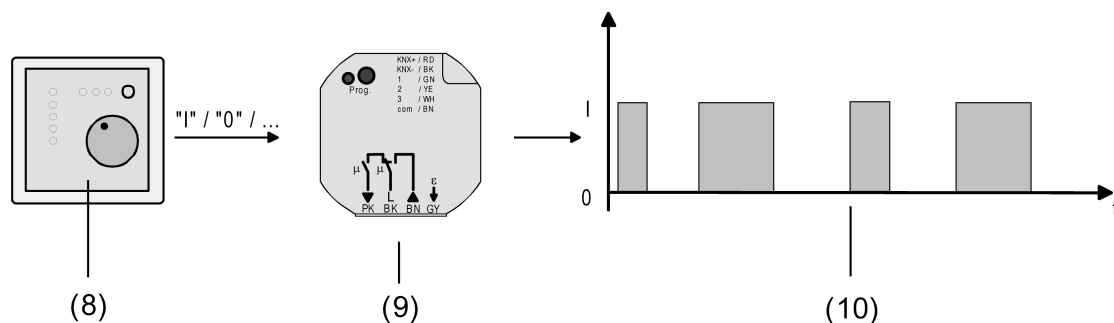

Figure 40: Command value principle for switching command value

- (8) Room temperature controller (command value "1-bit")
- (9) Blind- and heating actuator
- (10) Switching output signal for valve drives

- Set the "Type of command value" parameter to "Continuous (1-byte)".

In normal operation, the value telegram received via the 1-byte "Command value" object is converted by the device into an equivalent pulse width modulated switching signal at the valve outputs (Figure 41). Taking the cycle time (T) settable in the device into account, the average output signal resulting from this modulation is a measure of the centred valve position of the control valve and thus a reference for the set room temperature (see "Pulse width modulation for constant command values and constant valve setpoint positions").

A shift of the mean value, and thus a change in the heating or cooling capacity, can be obtained by changing the duty factor of the switch-on and switch-off pulses of the output signal. The scanning ratio is continually adjusted by the device according to the received command value (normal operation) or the valve setpoint position (forced position, emergency operation, after ETS programming operation, on bus voltage return).

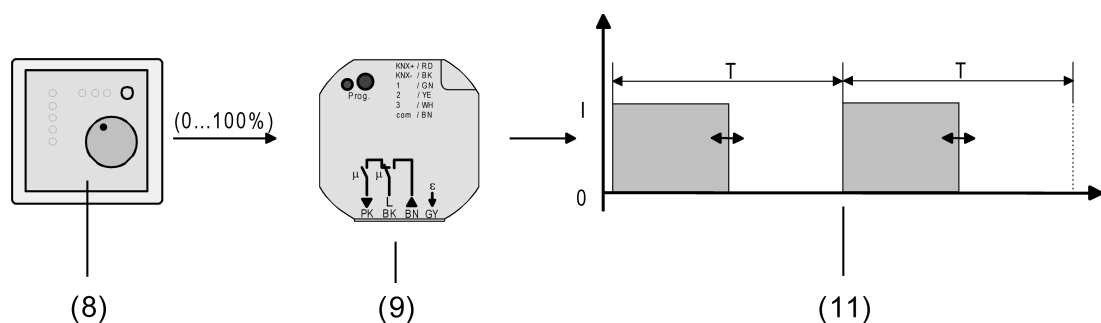

Figure 41: Command value principle for constant command value

- (8) Room temperature controller (command value "1-byte")
- (9) Blind- and heating actuator
- (11) Pulse width modulated output signal for valve drives

Pulse width modulation for constant command values and constant valve setpoint positions

Function of a pulse width modulation:

As soon as that device should set a constant command value or a valve setpoint position value configured in the ETS, it modulates the output signal using the switch-on pulse width. Taking the cycle time (T) settable in the device into account, the average output signal (M) resulting from this modulation is a measure of the centred valve position of the control valve and thus a reference for the set room temperature (Figure 42).

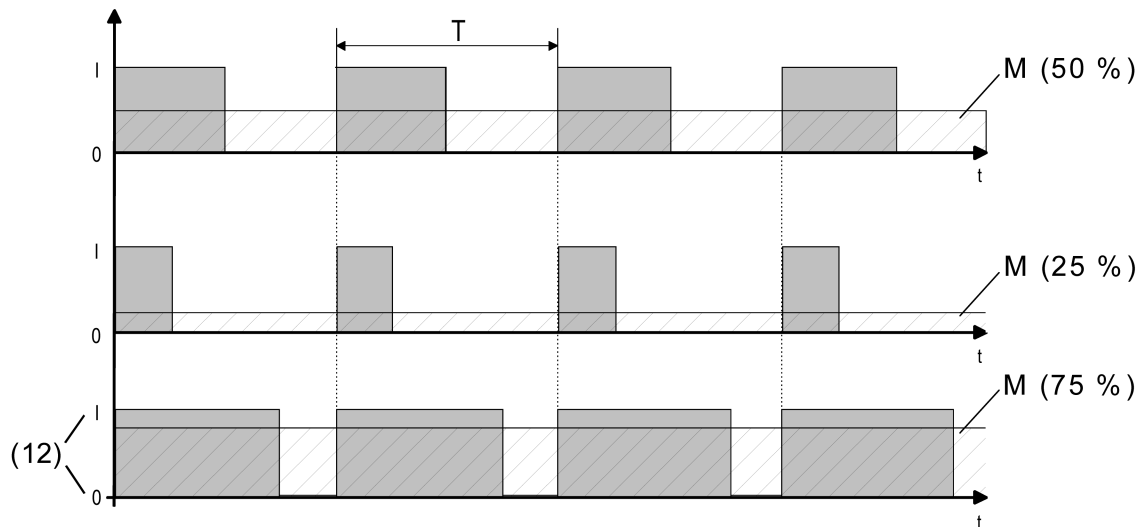

Figure 42: Pulse width modulation of a valve output signal

(12) Valve state (0 = Valve closed / 1 = Valve opened)

A shift of the mean value, and thus a change in the heating or cooling capacity, can be obtained by changing the duty factor of the switch-on and switch-off pulses of the output signal. The scanning ratio is continually adjusted by the device according to the received command value (normal operation) or the valve setpoint position (forced position, emergency operation, after ETS programming operation, on bus voltage return).

Adjusting the pulse width modulation:

Often, control circuits are subject to changes in the setpoint specification (e.g. frost protection, night operation, etc.) or short time interference (e.g. measured value deviations due to brief opening of windows or doors near the sensor). For the setting of the scanning ratio of the required command value to take place as quickly and correctly in these cases, even with longer cycle times (typically 10...20 minutes), without any negative impact on the reaction time of the control section, the device uses a special and very effective method for continuous command value adjustment.

A distinction is made between the following cases...

Case 1:

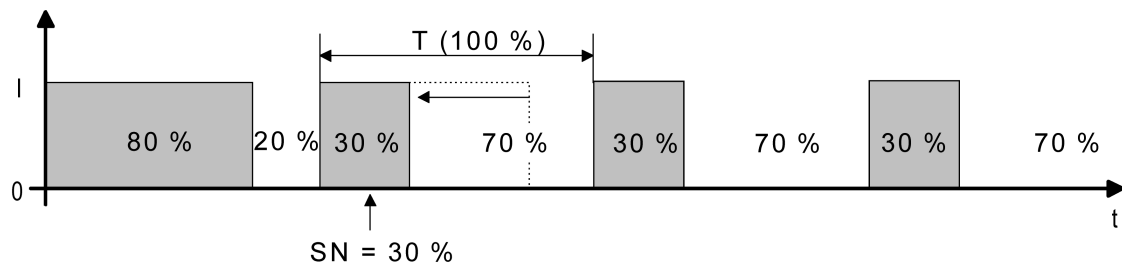

Figure 43: Command value change, e.g. from 80 % to 30 % during the opening phase of the valve

Before specifying a new valve setpoint position value (SN = 30 %), the old setpoint (80 %) was active. The new setpoint is specified during the open phase of the valve. At this point, the device detects that it is still possible to shorten the opening phase, so that it corresponds to the

new valve position (30 %). The cycle time (T) is not affected by this operation.

The new scanning ration is set immediately after receipt of the new valve setpoint position value.

Case 2:

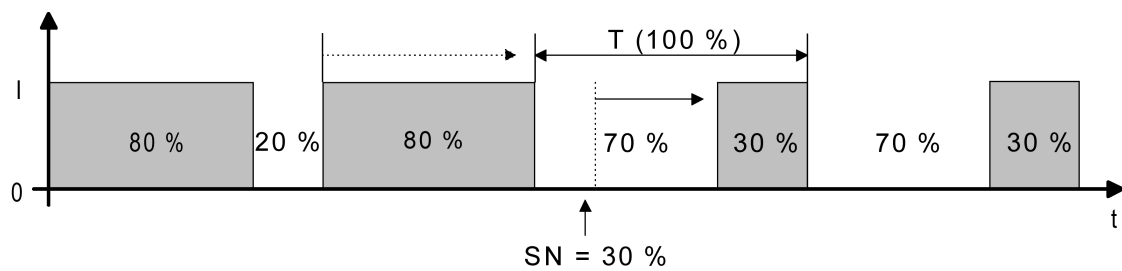

Figure 44: Command value change, e.g. from 80 % to 30 % during the closing phase of the valve

Before specifying a new valve setpoint position value (SN = 30 %), the old setpoint (80 %) was active. The new setpoint is specified during the closing phase of the valve. At this point, the device detects that it is still possible to extend the closing phase, so that it corresponds to the new valve position (30 %). The cycle time (T) remains unchanged, but the starting time of the period is shifted automatically.

The new scanning ration is set immediately after receipt of the new valve setpoint position value.

Case 3:

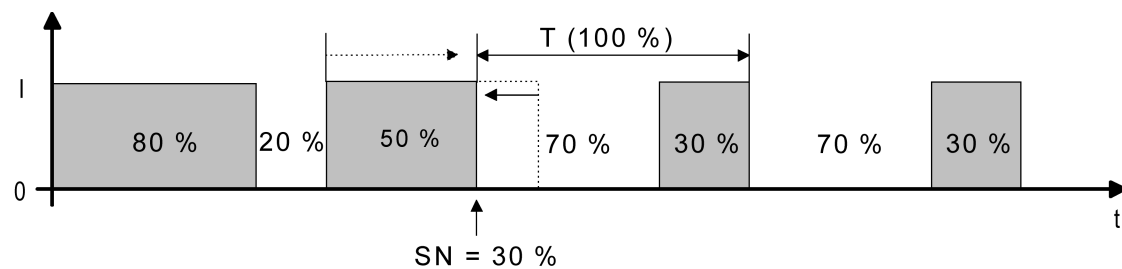

Figure 45: Command value change, e.g. from 80 % to 30 % during the opening phase of the valve (opening phase too long)

Before specifying a new valve setpoint position value (SN = 30 %), the old setpoint (80 %) was active. The new setpoint is specified during the open phase of the valve. At this point, the device detects that it is necessary to cancel the opening phase and close the valve, so that the scanning ration corresponds to the new valve position (30 %). The cycle time (T) remains unchanged, but the starting time of the period is shifted automatically.

The new scanning ration is set immediately after receipt of the new valve setpoint position value.

Case 4:

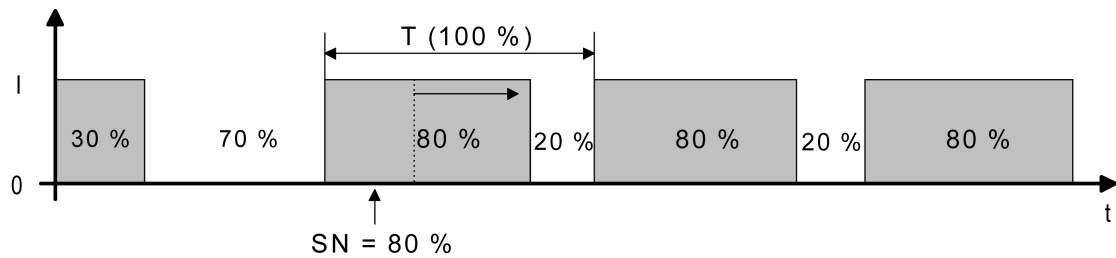

Figure 46: Command value change, e.g. from 30 % to 80 % during the opening phase of the valve

Before specifying a new valve setpoint position value (SN = 80 %), the old setpoint (30 %) was active. The new setpoint is specified during the open phase of the valve. At this point, the device detects that it is still possible to extend the open phase, so that it corresponds to the new valve position (80 %). The cycle time (T) is not affected by this operation.

The new scanning ration is set immediately after receipt of the new valve setpoint position value.

Case 5:

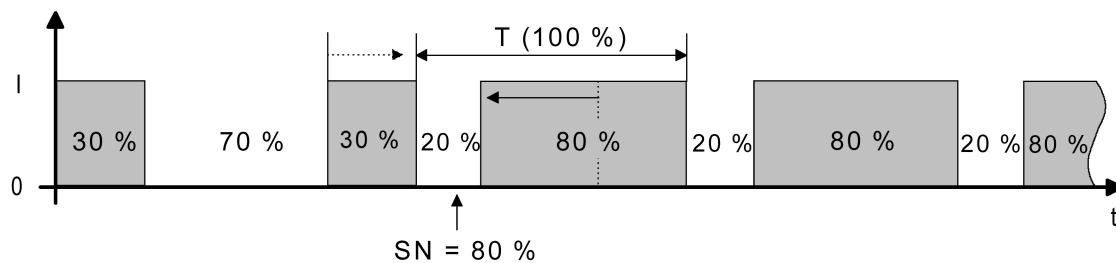

Figure 47: Command value change, e.g. from 30 % to 80 % during the closing phase of the valve

Before specifying a new valve setpoint position value (SN = 80 %), the old setpoint (30 %) was active. The new setpoint is specified during the closing phase of the valve. At this point, the device detects that it is still possible to reduce the closing phase, so that it corresponds to the new valve position (80 %). The cycle time (T) remains unchanged, but the starting time of the period is shifted automatically.

The new scanning ration is set immediately after receipt of the new valve setpoint position value.

Case 6:

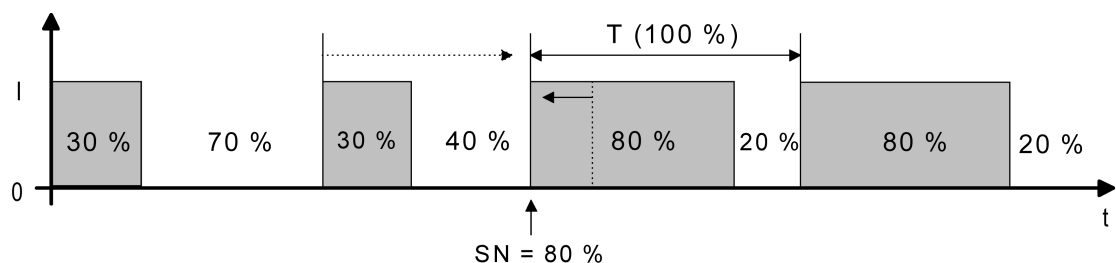

Figure 48: Command value change, e.g. from 30 % to 80 % during the closing phase of the valve (closing phase too long)

Before specifying a new valve setpoint position value (SN = 80 %), the old setpoint (30 %) was active. The new setpoint is specified during the closing phase of the valve. At this point, the device detects that it is necessary to cancel the closing phase and open the valve, so that the scanning ratio corresponds to the new valve position (80 %). The cycle time (T) remains unchanged, but the starting time of the period is shifted automatically.

The new scanning ration is set immediately after receipt of the new valve setpoint position value.

Cycle time of the pulse width modulation:

The cycle time specifies the switching frequency of a pulse width modulated output signal. The variable adjustment option of the cycle time in the ETS allows adaptation to the adjusting cycle times (the adjusting time it takes the drive to bring the valve from its completely closed to its completely opened position) of the actuators used. In this setting, take account of the dead times of the valve drives (the time in which the actuators do not show any response when being switched on or off). If different actuators with different adjusting cycle times are used, take account of the longest of the times.

The cycle time specified on parameter page "O2 - Times".

- i It may be necessary, depending on the drives used, to energise these for a longer period of time on first commissioning for the drives to be ready for operation (observe the information of the drive manufacturer).

During cycle time configuration, a distinction can always be made between two cases...

Case 1: Cycle time > 2 x adjusting cycle time of the electrothermal drives used (ETA)

In this case, the switch-on or switch-off times of the valve output are long enough for the actuators to have sufficient time to fully open or fully close within a given period.

Advantages:

The desired mean value for the command value and thus for the required room temperature will be set relatively precisely, even for several actuators triggered at the same time.

Disadvantages:

It should be noted, that, due to the full valve lift to be continuously 'swept', the life expectancy of the actuators can diminish. For very long cycle times (> 15 minutes) with less sluggishness in the system, the heat emission into the room, for example, in the vicinity of the radiators, can possibly be non-uniform and be found disturbing.

- i This setting is recommended for sluggish heating systems (such as underfloor heating).
- i Even for a bigger number of triggered actuators, maybe of different types, this setting can be recommended to be able to obtain a better mean value of the adjusting travels of the valves.

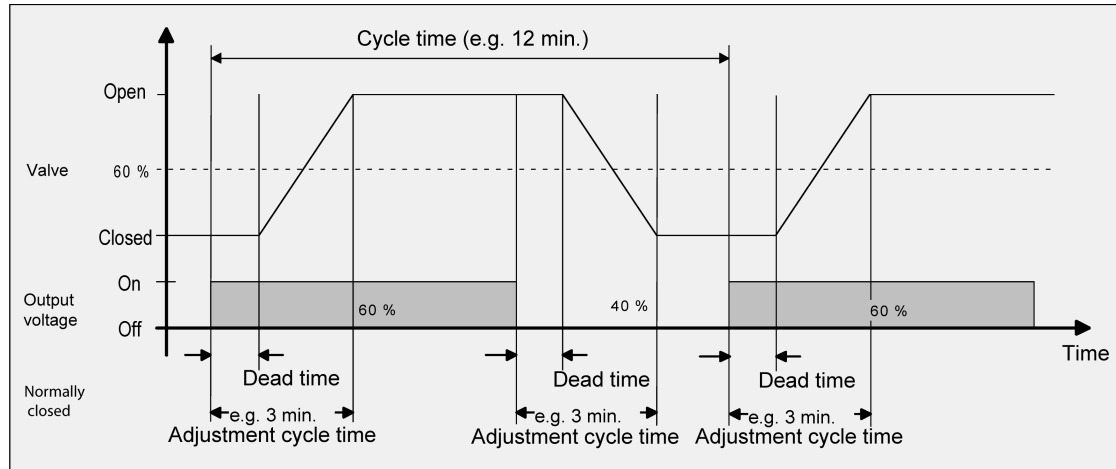

Figure 49: Ideal course of the valve stroke for a command value of approx. 60 % of a deenergised, closed valve

Case 2: Cycle time < adjusting cycle time of the electrothermal drives used (ETA)

In this case, the switch-on or switch-off times of the valve output are too short for the actuators to have enough time to fully open or fully close within a given period.

Advantages:

This setting ensures continuous water flow through the radiators, thus facilitating uniform heat emission into the room.

If only one actuator is triggered the regulator can continuously adapt the command value to compensate the mean value shift caused by the short cycle time, thus setting the desired room temperature.

Disadvantages:

If more than one drive is triggered at the same time the desired mean value will become the command value, which will result in a very poor adjustment of the required room temperature, or in adjustment of the latter with major deviations, respectively.

i This setting is recommended for 'quicker' heating systems (such as surface radiators).

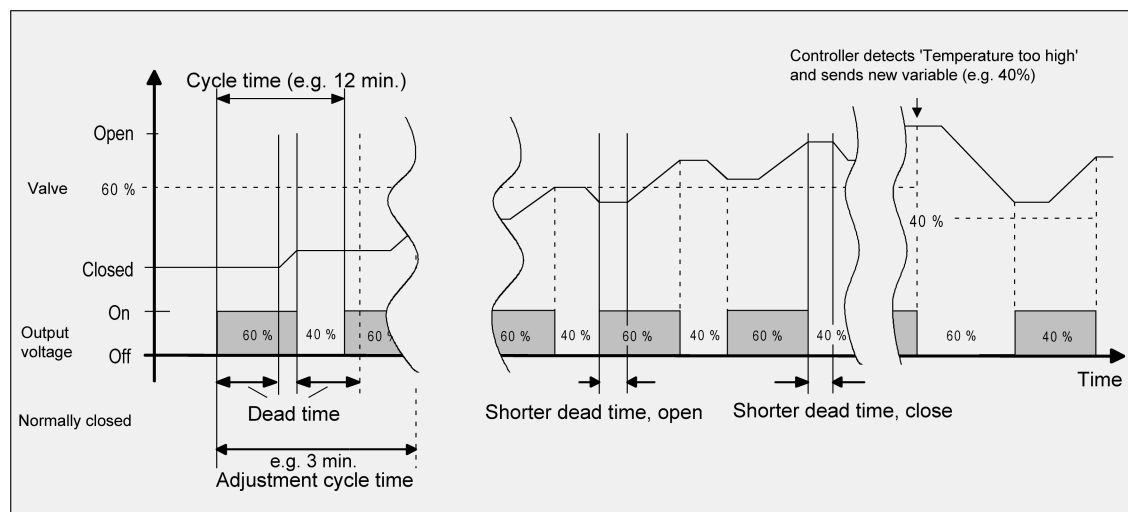

Figure 50: Ideal course of the valve stroke for a command value of approx. 60 % at first of a deenergised, closed valve

The continuous flow of water through the valve, and thus the continuous heating of the drives causes changes to the dead times of the drives during the opening and closing phase. The short cycle time and the dead times means that the required variable (mean value) is only set with a possibly large deviation. For the room temperature to be regulated constantly after a set time, the controller must continually adjust the command value to compensate for the mean value shift caused by the short cycle time. Usually, the control algorithm implemented in the controller (PI control) ensures that control deviations are compensated.

Cyclical command value monitoring

The device offers the option of monitoring the command value of the valve output. This monitoring checks whether command value telegrams have been received by the device within a time interval that can be defined in the ETS. If there are no telegrams during the monitoring time, the device activates emergency operation and adjusts the connected valve drives to an emergency operation valve position configured in the ETS. As a rule, a room thermostat transmits its command values cyclically to the bus if cyclical monitoring has been activated in the device (Figure 51).

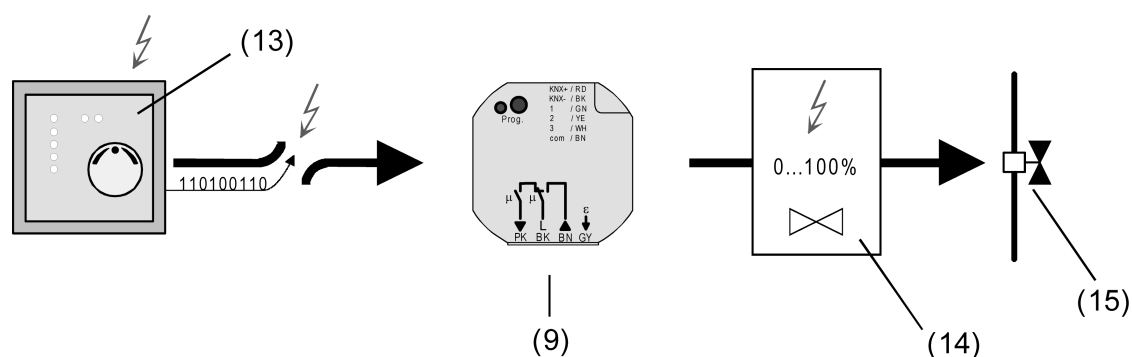

Figure 51: Principle of cyclical command value monitoring in the event of a fault (e.g. open circuit)

- (9) Blind- and heating actuator
- (13) Faulty room thermostat with cyclical telegram transmission of the command values
- (14) Valve setpoint position value for emergency operation
- (15) Valve drive

In the device, the monitoring time can be configured to between 1 minute and 59 minutes, whereby the device automatically adds a safety window of 30 seconds to the configured time.

During the monitoring time the device expects at least one command value telegram. If a telegram is received, then the device resets the monitoring time for the valve output and restarts the time interval.

The cyclical monitoring begins immediately after commissioning via the ETS, or after the bus voltage is switched on.

When the bus voltage is switched on, if no telegram is received by the time the monitoring time has elapsed, the valve output immediately assumes the emergency operation valve state as configured in the ETS. In so doing, the device can also transmit a 1-bit alarm message to the bus via the object "Alarm monitoring command value" provided that the alarm object in the ETS is connected to a group address. The telegram polarity of this alarm message can be configured in the ETS.

In the ETS, the valve state for emergency operation is stored as the constant valve emergency position (0 %... 100 %), which is applied as the valve setpoint position in activated emergency operation and which is executed by a pulse width modulation. The valve emergency position

can be set in the ETS differently for summer and winter operation, if the operating mode switchover is enabled.

- i** With active emergency operation, the configured pulse width modulation is also executed when the valve output is configured to a switching 1-bit command value.

Only when a new command value telegram is received does the device reset the monitoring time, reset it, and resets the valve output in accordance with the command value specification. Emergency operation is then terminated automatically. The alarm message is also retracted here by having the device transmit an inverted alarm telegram to the bus.

Enable cyclical command value monitoring

Cyclical command value monitoring can be enabled on the parameter page "O2 - Command value".

- Set the "Cyclical monitoring of the command value" parameter to "Enabled".
Configure the "Time for cyclical monitoring of the command values" on the parameter page "O2 - Times" to the required monitoring time. The time set there should agree with the time for cyclical transmission of the command value of the room temperature controller.
Configure the parameter "Value for emergency operation (0...100%)" on the parameter page "O2 - General" to the required valve emergency position. The parameter "Value for emergency operation..." may be visible twice if the operating mode switchover is enabled. In this case, it is possible to specify different valve emergency positions for summer and winter operation in the ETS.

The cyclical command value monitoring is enabled and the communication object "Command value monitoring alarm" becomes visible in the ETS.

In fault-free operation, the command value object of the corresponding valve output must have telegrams transmitted to it cyclically during the monitoring time.

- Set the "Cyclical monitoring of the command value" parameter to "Disabled".
The cyclical monitoring is completely disabled. No telegram monitoring of the command value object is performed.
- i** After bus voltage return and an ETS programming operation, the object "Alarm monitoring command value" is initialised so that the device also transmits a telegram to the bus. After bus voltage return and an ETS programming operation, automatic alarm telegram transmission only takes place when the "Delay after bus voltage return" configured in the ETs has elapsed.
- i** The operating mode (summer / winter) can also be switched over using the object during activated emergency operation. In this case, the device adjusts the pulse width modulation to the valve position value of the valid operating mode immediately after the switchover.

Setting the telegram polarity for the alarm object for command value monitoring

The telegram polarity of the 1-bit "Command value monitoring alarm" object can be set. The configuration of the polarity is possible on parameter page "O2 - Command value".

The cyclical command value monitoring must have been enabled already.

- Set the "Polarity of 'Command value monitoring' object" parameter to "Object value on no command values = 0".
A fault in the command value monitoring (emergency operation) is signalled by an "OFF" telegram (alarm). When the fault is reset (emergency operation terminated) an "ON" telegram is transmitted to the bus (no alarm).
- Set the "Polarity of 'Command value monitoring' object" parameter to "Object value on no command values = 1".

A fault in the command value monitoring (emergency operation) is signalled by an "ON" telegram (alarm). When the fault is reset (emergency operation terminated) an "OFF" telegram is transmitted to the bus (no alarm).

Command value limit

If the valve output is controlled using 1-byte constant command value telegrams, a command value limit can optionally be configured in the ETS. The command value limit allows the restriction of command values specified via the bus to the range limits "minimum" and "maximum". The limits are permanently set in the ETS and, if command value limitation is active, can be neither undershot or exceeded during device operation.

- i** The command value limit cannot be configured in the ETS, if the valve output is configured for 1-bit switching command values.

The command value limit can either be activated or deactivated using a separate 1-bit communication object or be permanently active. When controlling via the object, it is possible to have the device activate the command value limit automatically after bus voltage return or an ETS programming operation.

As soon as the command value limit is active, command values received via the bus and valve setpoint positions specified by emergency operation (cyclical command value monitoring) are limited. If the limit is removed, the device does not automatically track the most recently specified command value or the valve setpoint position to the unlimited values. After the limit, a new command value or valve setpoint position must be specified until new values are set at the valve output.

- i** In the status messages ("Command value status" or "Valve closed") the limited command value is always taken into account and fed back.
- i** The forced position has a higher priority than the command value limit (see chapter 4.2.4.6. Priorities for the outputs). This means that, in the case of a forced position, the command value setpoint configured in the ETS is always set at the valve output and is not limited by the command value limit.
- i** After an ETS programming operation and on bus voltage return, a constant valve setpoint position value (0...100%) can be configured and activated in the ETS as the "Value for forced position" or "Value for emergency operation". The following should be observed in this case:
The device only uses the valve position values (0...100 %) configured in the ETS. The forced position function or emergency operation are not activated. However, it should be noted that the value for the forced position has a higher priority than a command value limit. Thus, a forced position value set after bus voltage return or after an ETS programming operation is not limited by the command value limit. However, a value for emergency operation can be limited.

Enabling the command value limit

The command value limit can optionally be enabled on parameter page "O2 - Command value".

- Set the parameter "Command value limit" to "enabled".
The command value limit is enabled. Additional parameters become visible in the ETS.
- Set the parameter "Command value limit" to "disabled".
The command value limit is deactivated.

Configuring the activation of the command value limit

The command value limit can either be activated or deactivated using a separate 1-bit communication object or be permanently active. The activation property is configured in the parameter set for command value limiting on parameter page "O2 - Command value".

The command value limit must have been enabled beforehand in the ETS.

- Set the parameter "Activation of the command value limit" to "by object".

The 1-bit object "Command value limit" becomes visible in the ETS. The telegram polarity of this object is fixed: "0" = command value limit inactive / "1" = command value limit active.

As soon as a "1" telegram is received via the object, the device activates the command value limit for the valve output. Only a "0" telegram removes the limit for command value telegrams or valve setpoint position values for emergency operation.

- i** The initialisation of the command value limit object after a device reset is defined by the parameter "Command value limit after bus voltage return" (see "Define behaviour of the command value limit after device reset" below).

- Set the parameter "Activation of the command value limit" to "permanent".

The command value limit is always active and cannot be deactivated. There is no separate communication object available. Only a forced position of the valve output can by-pass the command value limit in normal device operation.

Specifying limit values for the command value limit

As soon as the command value limit is active, command values received via the bus and valve setpoint positions specified by emergency operation (cyclical command value monitoring) are limited. The command values to act as limits must be defined in the ETS as the minimum and maximum command value limit values. The limit values is configured in the parameter set for command value limiting on parameter page "O2 - Command value".

The command value limit must have been enabled beforehand in the ETS.

- Set the Minimum command value parameter to the required command value. The setting can be made in 5 % increments in the range 0 % ... 50 %.

With an active command value limit, the set minimum command value is not undershot by command values from the bus or emergency operation. Should the named functions specify smaller command values, the device sets the minimum command value at the valve output and signals this value, including the status, to the bus (if the status message is enabled).

- Set the Maximum command value parameter to the required command value. The setting can be made in 5 % increments in the range 55 % ... 100 %.

With an active command value limit, the set maximum command value is not exceeded by command values from the bus or emergency operation. Should the named functions specify larger command values, the device sets the maximum command value at the valve output and signals this value, including the status, to the bus (if the status message is enabled).

- i** The forced position has a higher priority than the command value limit. This means that, in the case of a forced position, the command value setpoint configured in the ETS is always set at the valve output and is not limited by the command value limit.

Defining the behaviour of the command value limit after a device reset

If the command value limit is to be activated or deactivated via the object, the initialisation of the object after a device reset (bus voltage return or ETS programming operation) can be specified. This setting is also made in the parameter set for command value limiting on parameter page "O2 - Command value".

With a permanently active command value limit, the initialisation behaviour cannot be configured separately after a device reset, as the limit is always active.

The command value limit must have been enabled beforehand in the ETS.

- Set the parameter "Command value limit after bus voltage return" to "deactivated".
After a device reset, the device does not automatically activate the command value limit. A "1" telegram must first be received via the object before the limit is activated.
- Set the parameter "Command value limit after bus voltage return" to "activated".
After a device reset, the device automatically activates the command value limit. A "0" telegram must first be received via the object before the limit is deactivated. The limit can be switched on or off at any time using the object.

i After a reset, the value of the "Command value limit" object is set according to the configuration and can be read out as necessary (set "Read" flat).

4.2.4.5.3 Settings for the status function

Status message for valve position

The device makes a command value status message available to the valve output. In so doing, the current valve setpoint position can be transmitted to the bus via the communication object "Command value status" according to the projected command value data format (1-bit or 1-byte). In this manner, the state of a valve can be displayed in a visualisation or evaluated further in other bus devices, for example.

The status object is updated after the following events...

- When the command value received from the bus changes,
- When the prespecified valve setpoint position is changed by a forced position or emergency operation,
- Always after an ETS programming operation or bus voltage return,
- Always when a short-circuit or an overload has caused a switch-off of a valve output.

The status object always specifies the value of the valve setpoint position. With constant 1-byte command values, the absolute value of the valve setpoint position is immediately added to the status object according to the KNX data point type 5.001 ("0" = 0% ... "255" = 100%). With switching 1-bit command values, the state "closed" ("0") or "opened" ("1") is added according to the KNX data point type 1.001.

The valve direction of action configured in the ETS is not included in the determination of the status message. The direction of action specifies solely the energising state of the valve output when the valve position is opened or closed.

A constant valve setpoint position (0 % to 100 %) can be activated in the forced position of the valve output, in emergency operation, after an ETS programming operation or after bus voltage return. In these cases, the configured valve setpoint position is executed as pulse width modulation (PWM). This also takes place when the output is configured to a switching 1-bit command value. In so doing, a PWM for valve outputs with 1-bit command value format in the status object is fed back as "Valve opened" ("1").

- i** If there is a short-circuit at the valve output, the connected valve drives are no longer controlled electrically, meaning that the drives switch to the deenergised status preset by the manufacturer (deenergised opened / deenergised closed). With the device status messages ("Command value status", "Valve closed"), a valve completely opened by a short-circuit (valve direction of action deenergised open) is evaluated as a closed valve, as the valve status was caused by a fault.
- i** Anti-sticking protection always runs 'in the background' and is not signalled to the bus using the status objects.

Enabling and configuring the status message for valve position

The configuration of the status message for the valve output is possible on parameter page "O2 - Status".

Irrespective of the data format of the command value, a distinction is made whether the status object of the valve output acts as an actively transmitting signal object or as a passive status object.

The configuration as a signalling or status object is performed in the ETS, which then automatically sets the necessary communication flags of the status object.

- Set the "Transmit status of the valve position ?" parameter to "Status object is actively transmitting".

The status message is enabled. As soon as the device updates the status message, a telegram is also actively transmitted to the bus. In the ETS the "Transmit" flag is set automatically on the status object.

i It is entirely possible, even when a signalling object is active, to set the "Read" flag in the ETS subsequently, in order to keep the read-out functionality of the object.

- Set the "Transmit status of the valve position ?" parameter to "Status object is passively readable".

The status message is enabled. The device updates only the status object internally, and does not transmit any telegram. The object value can be read out via the bus at any time (ValueRead), as a result of which the device then transmits a response telegram (ValueResponse). In the ETS the "Read" flag is set automatically on the status object.

- Set the "Transmit status of the valve position ?" parameter to "No status".

The communication object is hidden in the ETS meaning that the status message is completely inactive.

Setting the time delay after bus voltage return for the status message

It is possible to set a time delay for the actively transmitting status messages after bus voltage return (switching on of the bus voltage), and also after ETS programming. This can be useful, for example, in order to reduce the bus load if after a bus reset several devices are carrying out initialisation of their status or feedback objects at the same time. Here it is advisable to define different time delays in the devices, so that the transmission of the signal telegrams is staggered in time.

For this purpose a delay time can be defined in the device. Only after the configured time elapses is the status telegram for initialisation transmitted to the bus.

Whether the status message is transmitted with a time delay after initialisation can be configured on parameter page "O2 - Status".

The delay time itself is configured on the parameter page "General".

The status message for the valve position must have been enabled as 'actively transmitting' in advance.

- Set the parameter "Time delay for status after bus voltage return" to "Yes".
After the bus voltage supply is switched on or after ETS programming the status telegram is transmitted with a time delay.
- Set the parameter "Time delay for status after bus voltage return" to "No".
After the bus voltage supply is switched on or after ETS programming the status telegram is transmitted to the bus immediately after initialisation.

Status message "All valves closed"

The device can transmit the information to the bus using a 1-bit status telegram, that the valve drives connected to the valve output are closed, i.e. no heating or cooling energy is required via the command value. This status message can be useful, for example, for visualisations or pump control in a heating/cooling system.

Enabling the status message "Valve closed"

The status message can be enabled on parameter page "O2 - Status".

- Set the parameter "Status object 'Valve closed'" to "Enabled".
The "Valve closed" status function is enabled. The "Valve closed" communication object is visible in the ETS.
- Set the parameter "Status object 'Valve closed'" to "Blocked".

The "Valve closed" status function is completely deactivated.

Setting the telegram polarity of the "Valve closed" status message

The telegram polarity of the "Valve closed" communication object can be set in the ETS.

The status message must have been enabled in advance.

- Set the "Polarity object 'Valve closed'" parameter on the "O2 - Status" parameter page to "Object valve on 'Valve closed' = 0".

As soon as all the valve positions are specified as or set to "0 %" or "OFF", i.e. all the connected valves are completely closed, the device transmits an "OFF" telegram to the bus via the status object. As soon as the valves of the valve output are opened by a switching command value or any pulse width modulation, the device transmits an "ON" status telegram to the bus.

- Set the "Polarity object 'Valve closed'" parameter on the "O2 - Status" parameter page to "Object valve on 'Valve closed' = 1".

As soon as all the valve positions are specified as or set to "0 %" or "OFF", i.e. all the connected valves are completely closed, the device transmits an "ON" telegram to the bus via the status object. As soon as the valves of the valve output are opened by a switching command value or any pulse width modulation, the device transmits an "ON" status telegram to the bus.

i The status message takes switching and constant command values into account.

i The valve state configured in the ETS is set after bus voltage return or after an ETS programming operation. In so doing, the status message "Valve closed" is updated according to the current status and a telegram sent to the bus, providing the status message is enabled.

However, transmission shall only take place in the named cases after the delay time after bus voltage return configured in the ETS has elapsed.

i If there is a short-circuit at the valve output, the connected valve drives are no longer controlled electrically, meaning that the drives switch to the deenergised status preset by the manufacturer (deenergised opened / deenergised closed).

With the status message "Valve closed", a valve completely opened by a short-circuit (valve direction of action deenergised open) is evaluated as a closed valve, as the valve status was caused by a fault.

Short-circuit and overload protection

The device monitors the valve output for short-circuits and overloads as soon as the output is switched on and energised.

The device detects short-circuits against the neutral wire potential or a 'current-imposed' overload on the connected electrothermal actuators (Figure 52).

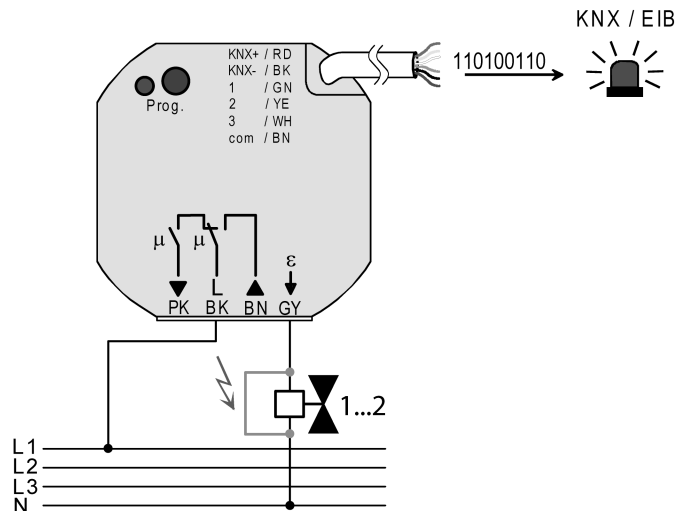

Figure 52: Short-circuit and overload detection in case of fault in valve output or valve drive

Short-circuit and overload detection with switch-off and testing operation:

As soon as a device detects a short-circuit or overload fault, it immediately deenergises the valve output and switches to the Fault status. In the Fault status, it is no longer possible to control the valve output via the bus. The device may still receive command values and forced position telegrams and save them, however it does not execute these telegrams and does not transmit any status feedback to the bus.

Only if the fault has not been eliminated 6 minutes after first detection and is still pending, the device switches to the Fault status and transmits an alarm telegram to the bus. This alarm message can be enabled and evaluated in the ETS. Irrespective of the alarm message, the device transmits a command value status telegram "0 %" or "OFF" to the bus 6 minutes after a fault is detected and thus signals a deactivated valve output

- i** With the status feedback, a valve completely opened by a short-circuit (valve direction of action deenergised open) is evaluated as a closed valve, as the valve status was caused by a fault.

If the fault is no longer pending 6 minutes after first detection (e.g. short switch-on overload), the device shall switch the valve output on for an additional 4 minutes, irrespective of the command value. Only when no new short-circuit or overload is detected within this additional switch-on phase of the testing operation does the device terminate the fault state after the 4 minutes have elapsed without the transmission of an alarm message.

The device then reactivates the added setpoint valve position which was active before the short-circuit or overload fault or which was most recently received from the bus during the fault state. In this way, the device switches the previously switched-off valve output on again, and also updates its status feedback. A forced position is also added, providing that this was activated before or during the fault.

- i** During the fault state, the cyclical command value monitoring is not active. Only when the fault state is reset is the cycle time of the cyclical monitoring restarted.

Resetting a short-circuit/overload fault:

The following procedures are available for recommissioning a valve output made fault by a short-circuit or an overload...

- Switch the bus voltage supply off and on again,
- ETS programming operation.

After the reset, the alarm message is immediately retracted by transmitting an alarm telegram according to the polarity set in the ETS (no alarm).

If, after resetting, the valve output is still overloaded or has a short circuit, the device, when switched on, detects the fault and starts the testing cycle again, as described above.

- i** If there is a short-circuit at the valve output, the connected valve drives are no longer controlled electrically, meaning that the drives switch to the deenergised status preset by the manufacturer (deenergised opened / deenergised closed).
With the status feedback ("Command value status", "Valve closed"), a valve completely opened by a short-circuit (valve direction of action deenergised open) is evaluated as a closed valve, as the valve status was caused by a fault.

Enabling the alarm object before short-circuit / overload detection

Short-circuit and overload detection is always active for the valve output. Optionally, a 1-bit alarm object can be enabled on the parameter page "O2 - Status", allowing the signalling of fault operation due to a short-circuit or overload in the bus.

- Set the "Alarm object for overload / short-circuit" parameter to "enabled".
This enables the short-circuit and overload signalling through the "Short-circuit / overload alarm" object. If the device at the valve output has detected a fault, it transmits an alarm telegram onto the bus after a 6-minute detection time has elapsed, provided that the fault is still pending. The alarm message is only retracted when the fault has been reset.
- Set the "Alarm object for overload / short-circuit" parameter to "disabled".
This deactivates the short-circuit and overload signalling through the "Short-circuit / overload alarm" object. When the device at the valve output detects a fault, the output is switched off and switched to fault operation without an alarm telegram being transmitted.
- i** After bus voltage return, the device retracts a alarm message transmitted before bus voltage failure by transmitting an alarm telegram appropriate to the polarity set in the ETS (no alarm). If, after resetting, the valve output is still overloaded or has a short circuit, the device, when switched on, detects the fault and starts the testing cycle again.
- i** The alarm message is, at first, deactivated after an ETS programming operation. For initialisation, the device transmits an alarm telegram onto the bus according to the polarity set in the ETS (no alarm). Only when a valve output switches on after the ETS programming operation and a fault has been detected does the device switch to fault operation of the valve output and starts the testing operation described above.

Setting the telegram polarity for the alarm object for short-circuit / overload

The telegram polarity of the 1-bit "Short-circuit / overload alarm" object can be set. The configuration of the polarity is possible on parameter page "O2 - Status".

The alarm object must have been enabled already.

- Set the "Polarity of 'Overland / short-circuit alarm" parameter to "Object value on overload / short-circuit = 0".
A short-circuit or overload fault is signalled by an "OFF" telegram (alarm). When the fault is reset, an "ON" telegram is transmitted to the bus (no alarm).
- Set the "Polarity of 'Overland / short-circuit alarm" parameter to "Object value on overload / short-circuit = 1".

A short-circuit or overload fault is signalled by an "ON" telegram (alarm). When the fault is reset, an "OFF" telegram is transmitted to the bus (no alarm).

Setting the time delay after bus voltage return for the short-circuit / overload alarm message

After bus voltage return, any alarm message transmitted before the bus voltage failure is always withdrawn (no alarm). Even if no alarm message was active before the bus failure, a message telegram (no alarm) is transmitted to bus for initialisation after bus voltage return or an ETS programming operation.

In these cases, the transmission of the alarm telegram may take place after a delay. The configuration of the time delay is possible on parameter page "O2 - Status".

The alarm object must have been enabled already.

- Set the parameter "Time delay for message after bus voltage return ?" to "Yes".
The time delay after a bus voltage return or an ETS programming operation is activated for the alarm message. The delay time is defined together with the Venetian blind and valve output using the parameter "Delay after bus voltage return (0...59 s)" on the parameter page "General".
- Set the parameter "Time delay for message after bus voltage return ?" to "Yes".
The time delay after a bus voltage return or an ETS programming operation is deactivated for the alarm message. The alarm telegram is transmitted immediately after the device initialisation.

4.2.4.6 Priorities for the outputs

The device distinguishes between different functions that can have an effect on the Venetian blind or valve output. In order to prevent conflicting states, each available function has a certain priority. The function with the higher priority overrides the one with the lower priority.

For output 1 there are the following priorities...

- 1st priority: forced position
- 2nd priority: safety function(s)

Priority levels 3 and 4 can be parameterized in the ETS. The options are then...

- 3th priority: sun protection function
- 4rd priority: direct operation via the bus (short time/long time operation, positioning, scenes),

or...

- 3rd priority: direct operation via the bus (short time/long time operation, positioning, scenes),
- 4th priority: sun protection function

or...

- 3rd priority: sun protection function and direct operation via the bus (short time/long time operation, positioning, scenes).

For valve output there are the following priorities...

- 1st priority: short-circuit / overload (highest priority)
- 2nd priority: anti-sticking protection
- 3th priority: forced position via object
- 4th priority: command value limit
- 5th priority: direct operation via the bus (command value evaluation) / emergency operation

4.2.5 Delivery state

Delivery state

In the state as delivered, the device is passive, i.e. no telegrams are transmitted to the bus. The device can be programmed and put into operation via the ETS. The physical address is preset to 15.15.255

Moreover the device has been configured at the factory with the following characteristics...

For output 1 (Venetian blind output)...

- Operating mode: Venetian blind
- Duration of short time operation: 0.5 seconds
- Movement time (continuous run): 1 minute
- Movement time (slat): 4 seconds
- Movement time extension: 2 %
- Break during movement direction changeover: 1 s
- Behaviour in case of bus voltage failure: no reaction
- Response to bus voltage return: stop

For output 2 (valve output)

- Valve direction of action (valve in deenergised state): closed
- Behaviour on bus voltage failure: output OFF (valve in deenergised state)
- Behaviour after bus voltage return: valve closes
- Cycle time (PWM of the outputs): 15 minutes, 10 seconds
- No cyclical command value monitoring

For inputs 1...3 (extension inputs)...

- Direction of action: I1 and I2 internally on Venetian blind output / I3 no function
- Operation concept: short - long - short
- Function: I1 UP / I2 DOWN
- Time between short and long time operation: 0.4 seconds
- Slat moving time: 2.5 seconds
- Response to bus voltage return: no reaction
- Delay after bus voltage return, 0 seconds

4.2.6 Parameters

4.2.6.1 General parameters

Description	Values	Comment
<p>☐ General</p> <p>Outputs (O1, O2)...</p>		
<p>Delay after bus voltage return Minutes (0...59)</p>	<p>0...59</p>	<p>To reduce telegram traffic on the bus line after bus voltage activation (bus reset), after connection of the device to the bus line or after programming with the ETS, it is possible to delay all actively transmitted feedback telegrams of the actuator outputs. For this purpose a channel-independent delay time can be defined here for outputs 1 and 2. Only after the configured time elapses are feedback telegrams for initialisation transmitted to the bus.</p> <p>Setting of the delay time minutes for the actuator outputs.</p>
<p>Seconds (0...59)</p>	<p>0...17...59</p>	<p>Setting of the delay time seconds for the actuator outputs.</p>
<p>Extension inputs (I1, I2, I3)...</p> <p>Effect of the extension inputs</p>	<p>I1, I2 & I3 separately on the bus</p> <p>I1 & I2 internally on O1, I3 separately on the bus</p>	<p>The device possesses extension inputs, which can have an internal effect on the Venetian blind output or, alternatively, affect the KNX/EIB separately, depending on this parameter.</p> <p>With the effect on the bus, the inputs can, independently of one another, transmit telegrams for switching or dimming for Venetian blind control or value encoder use (dimming value encoder, light scene extension). They then function like a pushbutton interface.</p> <p>With the internal effect, inputs 1 and 2 directly operate the Venetian blind output (O1). This configuration also corresponds to the as-delivered status (unprogrammed device). In this way, it is possible, for example, for a connected Venetian blind 'on the building site' to be commissioned and operated simply by applying the bus voltage and without using additional sensors. In this setting, extension input 3 also affects the bus.</p>
<p>Debounce time (10...255 ms)</p>	<p>10...30...255</p>	<p>This parameter specifies the time for software debounce for all the extension inputs. A signal flank at the input is</p>

		evaluated after a delay according to the time set here.
Delay after bus voltage return Minutes (0...59)	0...59	It is possible to specify separately for each input whether a reaction should take place after a device reset (bus voltage return or ETS programming operation). This means that a defined telegram can be transmitted to the bus according to the input signal or with forced control. The delay time for the extension inputs configurable at this point must have elapsed fully by the time the set reaction is executed. Within the delay, any pending flanks or signals at the inputs are not evaluated and are ignored.
		Minute setting of the delay time for the extension inputs.
Seconds (0...59)	0...17...59	Second setting of the delay time for the extension inputs.
Telegram rate limit	disabled Enabled	Here it is possible to configure a general telegram rate limit. If the telegram rate limit is enabled, no more telegrams are transmitted to the bus in 17 seconds (permanently defined, cyclical time interval) than is specified by the parameter "Telegrams per 17 s". This avoids fast flank changes at the inputs causing an unpermissibly high bus load.
Telegrams per 17 s	30, 60, 100, 127	Setting the telegram rate (telegrams in 17 s) for the telegram rate limit. Only visible on "Telegram rate limit = enabled".

4.2.6.2 Parameters for the extension inputs

Description	Values	Comment
□↵ Input X - General (x = 1, 2, 3)		
Function input x (X = 1...3)	No function Switching Dimming Venetian blind Value transmitter	The basic function of the appropriate extension input is defined here. It should be noted that the extension inputs 1 and 2 can optionally affect the internal Venetian blind output of the device. In this case, inputs 1 and 2 do not have separate communication objects and are permanently configured to the Venetian blind function in the ETS. These inputs can only be given a limited configuration. In the "No function" setting, the extension input is deactivated.

The following parameters are visible for the function "Switching"...

Command on rising flank Switching object 1.1	No reaction ON OFF TOGGLE	This parameter can be used to define which object value is transmitted first to the bus via the first communication object of the input when there is a rising flank (TOGGLE - switchover of the object value).
Command on falling flank Switching object 1.1	No reaction ON OFF TOGGLE	This parameter can be used to define which object value is transmitted first to the bus via the first communication object of the input when there is a falling flank (TOGGLE - switchover of the object value).
Command on rising flank Switching object 1.2	No reaction ON OFF TOGGLE	This parameter can be used to define which object value is transmitted first to the bus via the second communication object of the input when there is a rising flank (TOGGLE - switchover of the object value).
Command on falling flank Switching object 1.2	No reaction ON OFF TOGGLE	This parameter can be used to define which object value is transmitted first to the bus via the second communication object of the input when there is a falling flank (TOGGLE - switchover of the object value).
Behaviour after bus voltage return		After a device reset (bus voltage return or ETS programming operation), the communication objects of the input can be initialised. If, in the ETS, a delay is set for the extension inputs after bus

	voltage return, the device only transmits the telegrams when the delay has elapsed.
No reaction	After a device reset, no reaction takes place automatically (no telegram is transmitted to the bus).
Send ON telegram	In this configuration, an "ON" telegram is actively transmitted to the bus after a device reset.
Send OFF telegram	In this configuration, an "OFF" telegram is actively transmitted to the bus after a device reset.
Transmit current input status	In this setting, the device evaluates the static signal status of the input and, according to this, transmits the appropriately configured telegram to the bus (contact closed at the input = telegram as with rising flank; contact open at input = telegram as with falling flank). If, in this case, the flank command dependent on the current status is configured to "No reaction", the device does not transmit a telegram to the bus on initialisation.

The following parameters are visible for the function "Dimming"...

Operation	This parameter specifies the reaction to a rising flank at the input.
Single-surface operation: Brighter / darker (TOGGLE)	With a short signal length at the input, the object value of the switching object is toggled and an appropriate telegram transmitted. With a long signal length, a dimming telegram (brighter / darker). The dimming direction is only stored internally and switched on sequential dimming operations.
Two button operation: Brighter (ON)	With a short signal length at the input, an ON telegram is triggered and, if there is a long signal length, a dimming telegram (brighter) is triggered.
Two button operation: Darker (OFF)	With a short signal length at the input, an OFF telegram is triggered and, if there is a long signal length, a dimming telegram (darker) is triggered.
Two button operation: Brighter (TOGGLE)	With a short signal length at the input, the object value of the switching object is toggled and an appropriate telegram transmitted, if there is a long signal length, a dimming telegram (brighter) is triggered.
Two button operation: Darker (TOGGLE)	With a short signal length at the input, the object value of the switching object is toggled and an appropriate telegram transmitted, if there is a long signal

		length, a dimming telegram (darker) is triggered.
Time between switching and dimming Seconds (0...59)	0...59	Time from which the dimming function ("long signal length") is executed. Sets the time seconds.
Milliseconds (4...9 x 100)	4...9	Sets the time milliseconds.
Behaviour after bus voltage return		After a device reset (bus voltage return or ETS programming operation), the communication object "Switching" of the input can be initialised. If, in the ETS, a delay is set for the extension inputs after bus voltage return, the device only transmits the telegrams when the delay has elapsed.
	No reaction	After a device reset, no reaction takes place automatically (no telegram is transmitted to the bus).
	Send ON telegram	In this configuration, an "ON" telegram is actively transmitted to the bus after a device reset.
	Send OFF telegram	In this configuration, an "OFF" telegram is actively transmitted to the bus after a device reset.
Increase brightness by	100 % 50 % 25 % 12.5 % 6 % 3 % 1.5 %	A dimming telegram can increase brightness by a maximum of X %. This parameter determines the maximum dimming increments for a dimming telegram. This parameter depends on the set operation.
Reduce brightness by	100 % 50 % 25 % 12.5 % 6 % 3 % 1.5 %	A dimming telegram can increase darkness by a maximum of X %. This parameter determines the maximum dimming increments for a dimming telegram. This parameter depends on the set operation.
Transmit stop telegram?	No yes	One or no telegram is transmitted on releasing a pushbutton at the input (falling flank).
Telegram repeat?	No Yes	It is possible to use this parameter to determine whether the dimming telegram should be repeated cyclically for a long signal length (actuation of a pushbutton at the input).

Time between two telegrams Seconds (0...59)	0...1...59	Time between two telegrams when telegram repetition is active. A new dimming telegram is transmitted after this time has elapsed. Sets the time seconds.
Milliseconds (5...9 x 100)	5...9	Sets the time milliseconds.

The following parameters are visible for the function "Venetian Blind"...

Command on rising flank		This parameter specifies the reaction to a rising flank at the input.
	No function	The input is deactivated.
	UP	A short time telegram (UP) is triggered by a short signal length and a long time telegram (high) is triggered by a long signal length.
	DOWN	A short time telegram (DOWN) is triggered by a short signal length and a long time telegram (low) is triggered by a long signal length.
	TOGGLE	With this setting, the direction is switched over internally long signal length (MOVE). If a short time signal transmits a STEP telegram, then this STEP is always switched in the opposite direction of the last MOVE. Several STEP telegrams transmitted successively are switched in the same direction.
Behaviour after bus voltage return		After a device reset (bus voltage return or ETS programming operation), the communication object "Long time operation" of the input can be initialised. If, in the ETS, a delay is set for the extension inputs after bus voltage return, the device only transmits the telegrams when the delay has elapsed.
	No reaction	After a device reset, no reaction takes place automatically (no telegram is transmitted to the bus).
	Up	In this configuration, an "UP" telegram is actively transmitted to the bus after a device reset.
	Down	In this configuration, an "DOWN" telegram is actively transmitted to the bus after a device reset.
Operation concept		This parameter specifies the telegram sequence after actuation (rising flank).

	Short - long - short	A STEP is transmitted with a rising flank and the "Time between short and long time operation" started. This STEP serves the purpose of stopping a continuous movement. If, within the started time, a falling flank is detected, the input does not transmit an additional telegram. If no falling flank was detected during the time, a MOVE is transmitted automatically after the time has elapsed and the "slat adjustment time" is started. If a falling flank is detected within the slat adjustment time, the input transmits a STEP. This function is used for slat adjustment.
	Long - short	A MOVE is transmitted when there is a rising flank at the input and the "slat adjustment time" started. If a falling flank is detected within the started time, the input transmits a STEP. This function is used for slat adjustment.
Time between step and move operation Seconds (0...59)	0...59	Time after which the function of a long actuation is executed. Only visible with "Operation concept = "Short – Long – Short". Sets the time seconds.
Milliseconds (4...9 x 100)	4...9	Sets the time milliseconds.
Slat moving time Seconds (0...59)	0...2...59	Time during which a long time telegram for slat adjustment can be terminated by a falling flank at the input. Sets the time seconds.
Milliseconds (0...9 x 100)	0...9	Sets the time milliseconds.

The following parameters are visible for the function "Value encoder"...

Function as	Dimming value encoder	This parameter specifies the value transmitter function to be executed. The data format of the value object is dependent on the set function of the value encoder.
	Scene recall without storage function	
	Scene recall with storage function	
	Temperature value transmitter	
	Brightness value transmitter	
Transmit value / light scene number on	rising flank (pushbutton as NO contact)	This parameter specifies the flank which starts signal evaluation in the device. The setting "rising and falling flank

	falling flank (pushbutton as NC contact)	(switch)" cannot be selected with the value encoder function "Light scene recall with memory function".
	rising and falling flank (switch)	
Value on rising flank (0...255)	0... 100 ...255	This parameter specifies the value transmitted on a rising flank. Only visible with "Dimming value encoder" and "Transmit value on = rising flank (pushbutton as NO contact)" and "Transmit value on = rising and falling flank (switch)".
Value on falling flank (0...255)	0 ...255	This parameter specifies the value transmitted on a falling flank. Only visible with "Dimming value encoder" and "Transmit value on = falling flank (pushbutton as NC contact)" and "Transmit value on = rising and falling flank (switch)".
Light scene number on rising flank (1...64)	1 ...64	This parameter specifies the light scene number transmitted on a rising flank. Only visible with "Light scene recall" and "Transmit value on = rising flank (pushbutton as NO contact)" and "Transmit value on = rising and falling flank (switch)".
Light scene number on falling flank (1...64)	1 ...64	This parameter specifies the light scene number transmitted on a falling flank. Only visible with "Light scene recall" and "Transmit value on = falling flank (pushbutton as NC contact)" and "Transmit value on = rising and falling flank (switch)".
Value on rising flank	0 °C... 20 °C ...40 °C	This parameter specifies the temperature value transmitted on a rising flank. Only visible with "Temperature value encoder" and "Transmit value on = rising flank (pushbutton as NO contact)" and "Transmit value on = rising and falling flank (switch)".
Value on falling flank	0 °C... 18 °C ...40 °C	This parameter specifies the temperature value transmitted on a falling flank. Only visible with "Temperature value encoder" and "Transmit value on = falling flank (pushbutton as NC contact)" and "Transmit value on = rising and falling flank (switch)".

		falling flank (switch)".
Value on rising flank	0 Lux... 200 Lux ...1.500 Lux	This parameter specifies the brightness value transmitted on a rising flank. Only visible with "Brightness value encoder" and "Transmit value on = rising flank (pushbutton as NO contact)" and "Transmit value on = rising and falling flank (switch)".
Value on falling flank	0 Lux ...1,500 Lux	This parameter specifies the brightness value transmitted on a falling flank. Only visible with "Brightness value encoder" and "Transmit value on = falling flank (pushbutton as NC contact)" and "Transmit value on = rising and falling flank (switch)".
Behaviour after bus voltage return		After a device reset (bus voltage return or ETS programming operation), the communication object of the value encoder or light scene extension can be initialised. If, in the ETS, a delay is set for the extension inputs after bus voltage return, the device only transmits the telegrams when the delay has elapsed.
	No reaction	After a device reset, no reaction takes place automatically (no telegram is transmitted to the bus).
	Reaction as rising flank	In this configuration, a telegram is actively transmitted to the bus after a device reset in accordance with the configuration for the rising flank.
	Reaction as falling flank	In this configuration, a telegram is actively transmitted to the bus after a device reset in accordance with the configuration for the falling flank.
	Transmit current input status	In this setting, the device evaluates the static signal status of the input and, according to this, transmits the appropriately configured telegram to the bus (contact closed at the input = telegram as with rising flank; contact open at input = telegram as with falling flank). This setting can only be configured with "Transmit value on = rising and falling flank (switch)".
Adjustment via long actuation	No Yes	With the dimming value encoder and the temperature and brightness value encoder, the value to be transmitted can be adjusted at any time during device operation. A value adjustment can only be configurable here when the value is

to be transmitted only on a rising flank or only on a falling flank, i.e. a pushbutton is connected to the input. A value adjustment is introduced by a long signal at the input (> 5 s) and continues for as long as the signal is detected as active, i.e. the pushbutton is actuated. With the first adjustment after commissioning, the value programmed by the ETS is increased cyclically by the step width configured for the dimming value encoder and transmitted. The step width of the temperature value encoder (1 °C) and the brightness value encoder (50 Lux) is permanently defined. The previously transmitted value is saved after releasing the pushbutton. The next long pushbutton actuation adjusts the saved value and the direction of the value adjustment changes. Only visible with "Transmit value on = rising flank (pushbutton as NO contact)" and "Transmit value on = falling flank (pushbutton as NC contact)".

Time between two telegrams
Seconds (0...59) **0...1...59**

The time between two telegrams on adjusting values can be configured here. Only visible on "Adjustment via long actuation = Yes". Sets the time seconds.

Milliseconds (5...9 x 100) **5...9**

Sets the time milliseconds.

Level size (1...10) **1...10**

Increments by which the adjusted value is increased or decreased with long actuation. Only visible on "Function as = Dimming value encoder".

Input x - disable (X = 1, 2, 3) - Only for "Switching" function!

Disabling function switching object 1.1 **disabled**
Enabled

The extension inputs can be separately disabled via the bus using 1-bit objects. With the "Switching" function, it is possible to disable the two switching objects of an input independently of each other. With an active disabling function, signal flanks at the input are ignored by the device related to the affected objects. This parameter enables the disabling function of the first communication object.

Polarity of the disabling object **Disable = 1 (Enable = 0)**
Disable = 0 (Enable = 1)

This parameter defines the polarity of the disabling object.

Behaviour at the beginning of the disabling function Switching object 1.1	No reaction ON OFF TOGGLE	With an active disable, the first switching object is disabled. This parameter specifies the command transmitted via this object at the beginning of the disabling. "TOGGLE" switches over the current object value.
Behaviour at the end of the disabling function Switching object 1.1	No reaction ON OFF Transmit current input status	With an active disable, the first switching object is disabled. This parameter specifies the command transmitted via this object at the end of the disabling. "TOGGLE" switches over the current object value. In the "Transmit current input status" setting, the device evaluates the current static signal status of the input and, according to this, transmits the appropriately configured telegram to the bus (contact closed at the input = telegram as with rising flank; contact open at input = telegram as with falling flank).
Disabling function switching object 1.2	disabled Enabled	The extension inputs can be separately disabled via the bus using 1-bit objects. With the "Switching" function, it is possible to disable the two switching objects of an input independently of each other. With an active disabling function, signal flanks at the input are ignored by the device related to the affected objects. This parameter enables the disabling function of the second communication object.
Polarity of the disabling object	Disable = 1 (Enable = 0) Disable = 0 (Enable = 1)	This parameter defines the polarity of the disabling object.
Behaviour at the beginning of the disabling function Switching object 1.2	No reaction ON OFF TOGGLE	With an active disable, the second switching object is disabled. This parameter specifies the command transmitted via this object at the beginning of the disabling. "TOGGLE" switches over the current object value.
Behaviour at the end of the disabling function Switching object 1.2	No reaction ON OFF Transmit current input status	With an active disable, the second switching object is disabled. This parameter specifies the command transmitted via this object at the end of the disabling. "TOGGLE" switches over the current object value. In the "Transmit current input status" setting, the device evaluates the current static signal status

of the input and, according to this, transmits the appropriately configured telegram to the bus (contact closed at the input = telegram as with rising flank; contact open at input = telegram as with falling flank).

☐ Input x - disable (X = 1, 2, 3) - Only for "Dimming" function!

Disabling function	disabled Enabled	The extension inputs can be separately disabled via the bus using 1-bit objects. With an active disabling function, signal flanks at the input are ignored by the device related to the affected objects. This parameter enables the disabling function of the input.
--------------------	----------------------------	---

Polarity of the disabling object	Disable = 1 (Enable = 0) Disable = 0 (Enable = 1)	This parameter defines the polarity of the disabling object.
----------------------------------	---	--

Behaviour at the beginning of the disabling function	No reaction ON OFF TOGGLE	With an active disable, the input is disabled. This parameter specifies the command transmitted via the "Switching" object at the beginning of the disabling. "TOGGLE" switches over the current object value.
--	---	--

Behaviour at the end of the disabling function	No reaction OFF	With an active disable, the input is disabled. This parameter specifies the command transmitted via the "Switching" object at the end of the disabling.
--	---------------------------	---

☐ Input x - disable (X = 1, 2, 3) - Only for "Venetian blind" function!

Disabling function	disabled Enabled	The extension inputs can be separately disabled via the bus using 1-bit objects. With an active disabling function, signal flanks at the input are ignored by the device related to the affected objects. This parameter enables the disabling function of the input.
--------------------	----------------------------	---

Polarity of the disabling object	Disable = 1 (Enable = 0) Disable = 0 (Enable = 1)	This parameter defines the polarity of the disabling object.
----------------------------------	---	--

Behaviour at the beginning of the disabling function	No reaction Up Down Toggle	With an active disable, the input is disabled. This parameter specifies the command transmitted via the "Long time operation" object at the beginning of the disabling. "TOGGLE" switches over the
--	--	--

current object value.

Behaviour at the end of the disabling function

No reaction
Up
Down
Toggle

With an active disable, the input is disabled. This parameter specifies the command transmitted via the "Long time operation" object at the end of the disabling. "TOGGLE" switches over the current object value.

☐ Input x - disable (X = 1, 2, 3) - Only for "Value encoder" function!

Disabling function

disabled
Enabled

The extension inputs can be separately disabled via the bus using 1-bit objects. With an active disabling function, signal flanks at the input are ignored by the device related to the affected objects. This parameter enables the disabling function of the input.

Polarity of the disabling object

Disable = 1 (Enable = 0)
Disable = 0 (Enable = 1)

This parameter defines the polarity of the disabling object.

Behaviour at the beginning of the disabling function

No reaction
Reaction as rising flank
Reaction as falling flank
Transmit current input status

With an active disable, the input is disabled. This parameter specifies the command transmitted via the value object at the beginning of the disabling. In the "Transmit current input status" setting, the device evaluates the static signal status of the input and, according to this, transmits the appropriately configured telegram to the bus (contact closed at the input = telegram as with rising flank; contact open at input = telegram as with falling flank). The selection of the settings of this parameter depends on the configured flank evaluation of the input.

Behaviour at the end of the disabling function

No reaction
Reaction as rising flank
Reaction as falling flank
Transmit current input status

With an active disable, the input is disabled. This parameter specifies the command transmitted via the value object at the end of the disabling. In the "Transmit current input status" setting, the device evaluates the static signal status of the input and, according to this, transmits the appropriately configured telegram to the bus (contact closed at the input = telegram as with rising flank; contact open at input = telegram as with falling flank). The selection of the settings of this parameter depends on the configured flank evaluation of the input.

Input x - Transmit cyclically (X = 1, 2, 3) - Only for "Switching" function!

Cyclical transmission ?

Optionally, the object values can be transmitted cyclically to the bus for the "Switching" function. For this, the transmission criteria must first be defined in the ETS. This parameter specifies with which value cyclical transmission should take place. The object value entered in the switching objects by the device on a flank change or externally by the bus is always transmitted cyclically. The object value is then also transmitted cyclically when "no reaction" is assigned to a rising or falling flank. Cyclical transmission also takes place directly after bus voltage return, if the reaction after bus voltage return corresponds to the transmission criterion for cyclical transmission. During an active disable, no cyclical transmissions take place via the disabled input.

No cyclical transmission

There is no cyclical transmission.

Repeat on ON

Transmission takes place cyclically when the object value is "ON".

Repeat on OFF

Transmission takes place cyclically when the object value is "OFF".

Repeat on ON and OFF

Transmission takes place cyclically irrespective of the object value.

Cyclical transmission
Switching object 1.1 ?

yes
No

Here, it is possible to specify whether cyclical transmission should take place via the first switching object of the input.

Time for cyclical
transmission
Hours (0...23)

0...23

If cyclical transmission should take place via the first switching object of the input, then the cycle time can be configured here.
Sets the cycle time hours.

Minutes (0...59)

0...59

Sets the cycle time minutes.

Seconds (0...59)

0...30...59

Sets the cycle time seconds.

Cyclical transmission
Switching object 1.2 ?

Yes
No

Here, it is possible to specify whether cyclical transmission should take place via the second switching object of the input.

Time for cyclical
transmission
Hours (0...23)

0...23

If cyclical transmission should take place via the second switching object of the input, then the cycle time can be configured here.
Sets the cycle time hours.

Minutes (0...59)	0 ...59	Sets the cycle time minutes.
Seconds (0...59)	0... 30 ...59	Sets the cycle time seconds.

4.2.6.3 Parameters for the Venetian blind output

Description	Values	Comment
□ Output 1 - General		
Operating mode (Please set first!)	Venetian blind	The device can control various drive systems. This parameter defines which type of drive or which type of curtain is connected to Output 1.
	Roller shutter / awning	The ETS adapts all of the following parameters (designations, visible/non visible, etc.) dynamically to the respective "operating mode" parameter.
	Venting louver	For this reason, the "Operating mode" parameter should be adjusted before all other parameters of an output.
Behaviour after ETS programming		The device permits setting the preferred relay contact position after ETS programming.
	Raising / opening the louver	After programming with the ETS, the device raises the blind or opens the venting louver.
	Lowering / closing the louver	After programming with the ETS, the device lowers blind or closes the venting louver.
Behaviour in case of bus voltage failure	Stop	After programming with the ETS, the device switches the relays of the output to the "stop" position. A drive movement, if any, will be interrupted.
		The device permits setting the preferred relay contact position in case of bus voltage failure.
	No reaction	In case of bus voltage failure, the device switches the relays of the output to the "stop" position. A drive movement, if any, will be interrupted.
Response to bus voltage return		In the event of bus voltage failure, the relay of the output shows no reaction. Any drive movements still in progress at the time of failure will be completely finished.
	Stop	The device permits setting the preferred relay contact position after bus voltage return.
	Raising / opening the louver	In case of bus voltage return, the device switches the relays of the output to the "stop" position. A drive movement, if any, will be interrupted.
		After bus voltage return, the device raises the blind or opens the venting louver.

	Lowering / closing the louver	After bus voltage return, the device lowers the blind or closes the venting louver.
	Position on bus failure	After bus voltage return, the forced-position state last selected and internally stored <u>before</u> bus voltage failure will be tracked.
	Approaching a position	In case of bus voltage return, the connected drive can approach a position specified by further parameters.
Position of Venetian blind on bus voltage return (0...100%)	0...100	This parameter specifies the blind position to be approached in case of bus voltage return. This parameter is only visible, if "Behaviour in case of bus voltage return" is set to "approach position". This parameter is visible only in the 'Venetian blind' operating mode.
Position of slat on bus voltage return (0...100%)	0...100	This parameter specifies the slat position to be approached in case of bus voltage return after the blind has been positioned at the desired height. This parameter is only visible, if "Behaviour in case of bus voltage return" is set to "approach position". This parameter is visible only in the 'Venetian blind' operating mode.
Roller shutter/awning position on bus voltage return (0...100%)	0...100	This parameter specifies the roller shutter or awning position to be approached in case of bus voltage return. <div style="margin-left: 20px;"> <p>i This parameter is only visible, if "Behaviour in case of bus voltage return" is set to "approach position".</p> <p>i This parameter is visible only in the "Roller Shutter / Awning" operating mode.</p> </div>
Position of venting louver on bus voltage return (0...100%)	0...100	This parameter specifies the venting louver position to be approached in case of bus voltage return. This parameter is only visible, if "Behaviour in case of bus voltage return" is set to "approach position". This parameter is visible only in the 'Venting louver' operating mode.
Travelling time extension for upward travel	2 % 3 % 4 % 5 %	The device extends all the up movements or all venting louver movements into the opened louver position of Venetian blind outputs using the

	6 % 7 % 8 % 9 % 10 % 12.5 %	extension configured here. The time extension expressed in percent is the difference between the measured travel time needed to reach the lower end position (completely closed position) and the time needed to reach the upper end position (completely open position).
<hr/>		
□ Output 1 - Times		
Short time operation		
	No (only stop)	This parameter can be used to configure the reaction to a received short-time telegram. The drive will only be stopped if it is executing a travel movement at the time of telegram reception. There is no reaction if no movement is in progress.
	yes	Short-time operation is started on reception of a short-time telegram when the drive is stationary. If the drive is in motion at the time of telegram reception, it will be stopped.
Time for short time operation Seconds (0...59)	0...59	This parameter defines the duration of short-time operation. Sets the monitoring time seconds.
Milliseconds (0...99 x 10)	0...99	Sets the monitoring time milliseconds. The duration of short-time operation should in no case exceed half the slat adjusting time. This parameter is only visible, if the parameter "Short-time operation" is set to "yes".
Venetian blind travelling time Minutes (0...19)	0...1...59	This parameter defines the travelling time of the Venetian blind. The time needed for a complete travel from the upper into the lower end position must be determined. Sets the minutes of the Venetian blind travelling time.
Seconds (0...59)	0...59	Sets the seconds of the Venetian blind travelling time. The travelling time must be determined precisely. These parameters are visible only in the 'Blind' mode of operation.
Roller shutter/awning travelling time Minutes (0...59)	0...1...59	This parameter defines the travelling time of the roller shutter or awning. The time needed for a complete travel from the upper into the lower end position must be determined.

		Sets the minutes of the roller shutter/ awning moving time.
Seconds (0...59)	0...59	Sets the seconds of the roller shutter/ awning moving time. The travelling time must be determined precisely. These parameter are visible only in the "Roller Shutter / Awning" operating mode.
Venting louver travelling time Minutes (0...59)	0...1...59	This parameter defines the travelling time of the venting louver. The time needed for a complete travel from the completely open into the completely closed position must be determined.
		Sets the minutes of the venting louver travelling time.
Seconds (0...59)	0...59	Sets the seconds of the venting louver travelling time. The travelling time must be determined precisely. These parameters are visible only in the 'Venting louver' mode of operation.
Slat travelling time Minutes (0...59)	0...59	This parameter defines the travelling time of the slats. The time needed for a complete movement from the completely open slat position into the completely closed slat position (downward direction) must be determined.
		Sets the minutes of the slat moving time.
Seconds (0...59)	0...4...59	Sets the seconds of the slat moving time. The travelling time must be determined precisely. The slat moving time must be selected shorter than the blind travelling time. These parameters are visible only in the 'Blind' mode of operation.
Switchover time for travel direction change	0.5 s 1 s 2 s 5 s	Specifies the break in a travel direction change (switchover time).
<input type="checkbox"/> Output 1 - Enabled functions		
Feedback functions	disabled Enabled	This parameter can be used to disable or to enable the feedback functions. When the function is enabled, the required parameters will be displayed under "O1 –Feedbacks".
Safety functions		This parameter can be used disable or to enable the safety functions. When the

	disabled	function is enabled, the required parameters will be displayed under "O1 –Safety I...III".
	Enabled	
Sun protection functions	disabled	This parameter can be used disable or to enable the sun protection functions. When the function is enabled, the corresponding parameters will be displayed under "O1 - Sun protection" and the necessary objects enabled.
	Enabled	
Light scene function	disabled	This parameter can be used disable or to enable the scene function. When the function is enabled, the corresponding parameters will be displayed under "O1 - Scenes" and the necessary object enabled.
	Enabled	
Forced position function	disabled	This parameter can be used to disable or to enable the forced position function. When the function is enabled, the corresponding parameters will be displayed under "O1 - Forced position" and the necessary object enabled.
	Enabled	
Fabric-stretching function	disabled	This parameter can be used disable or to enable the fabric-stretching function. When the function is enabled, the required parameters will be displayed under "O1 – Fabric stretching".
	Enabled	
☐ Output 1 - Feedbacks		
Venetian blind position feedback		The current Venetian blind position of the output can be reported separately back to the bus.
	no feedback	No feedback object available for the output. Feedback deactivated.
	Feedback object is active signalling object	Feedback and the object are activated. The object transmits actively (telegram transmission after change).
	Feedback object is passive status object	Feedback and the object are activated. The object is passive (telegram transmission only as a response to 'Read' request). This parameter is visible only in the 'Venetian blind' operating mode.
Roller shutter/awning position feedback		The current roller shutter or awning position of the output can be reported separately back to the bus.

	no feedback	No feedback object available for the output. Feedback deactivated.
	Feedback object is active signalling object	Feedback and the object are activated. The object transmits actively (telegram transmission after change).
	Feedback object is passive status object	Feedback and the object are activated. The object is passive (telegram transmission only as a response to 'Read' request). This parameter is visible only in the "Roller Shutter / Awning" operating mode.
Venting louver position feedback		The current venting louver position of the output can be reported separately back to the bus.
	no feedback	No feedback object available for the output. Feedback deactivated.
	Feedback object is active signalling object	Feedback and the object are activated. The object transmits actively (telegram transmission after change).
	Feedback object is passive status object	Feedback and the object are activated. The object is passive (telegram transmission only as a response to 'Read' request). This parameter is visible only in the 'Venting louver' operating mode.
Time delay for feedback telegram after bus voltage return ?	Yes (delay time under "General!") No	The feedback telegram can be transmitted to the bus with a delay after bus voltage return or after programming with the ETS. Setting "Yes" activates the delay time of the feedback in case of bus voltage return. The delay time is configured under "General". This parameter is only visible in case of an actively transmitting feedback object.
Slat position feedback		The current slat position of the output can be reported separately back to the bus.
	no feedback	No feedback object available for the output. Feedback deactivated.
	Feedback object is active signalling object	Feedback and the object are activated. The object transmits actively (telegram transmission after change).
	Feedback object is passive status object	Feedback and the object are activated. The object is passive (telegram transmission only as a response to 'Read' request). This parameter is visible only in the 'Venetian blind' operating mode.

Time delay for feedback telegram after bus voltage return ?	Yes (delay time under "General!") No	The feedback telegram can be transmitted to the bus with a delay after bus voltage return or after programming with the ETS. Setting "Yes" activates the delay time of the feedback in case of bus voltage return. The delay time is configured under "General". This parameter is only visible in case of an actively transmitting feedback object.
Invalid Venetian blind position feedback	no feedback	The device can report to the bus that the current blind position is unknown (e.g. after an initialisation, when no reference movement has been executed as yet). No feedback object available for the output. Feedback deactivated.
	Feedback object is active signalling object	Feedback and the object are activated. The object transmits actively (telegram transmission after change).
	Feedback object is passive status object	Feedback and the object are activated. The object is passive (telegram transmission only as a response to 'Read' request). This parameter is visible only in the 'Venetian blind' operating mode.
Invalid roller shutter-awning position feedback	no feedback	The device can report to the bus that the current roller shutter/awning position is unknown (e.g. after an initialisation, when no reference movement has been executed as yet). No feedback object available for the output. Feedback deactivated.
	Feedback object is active signalling object	Feedback and the object are activated. The object transmits actively (telegram transmission after change).
	Feedback object is passive status object	Feedback and the object are activated. The object is passive (telegram transmission only as a response to 'Read' request). This parameter is visible only in the "Roller Shutter / Awning" operating mode.
Invalid venting louver position feedback	no feedback	The device can report to the bus that the current venting louver position is unknown (e.g. after an initialisation, when no reference movement has been executed as yet). No feedback object available for the output. Feedback deactivated.

	Feedback object is active signalling object	Feedback and the object are activated. The object transmits actively (telegram transmission after change).
	Feedback object is passive status object	Feedback and the object are activated. The object is passive (telegram transmission only as a response to 'Read' request). This parameter is visible only in the 'Venting louver' operating mode.
Time delay for feedback telegram after bus voltage return ?	Yes (delay time under "General") No	The feedback telegram can be transmitted to the bus with a delay after bus voltage return or after programming with the ETS. Setting "Yes" activates the delay time of the feedback in case of bus voltage return. The delay time is configured under "General". This parameter is only visible in case of an actively transmitting feedback object.
Drive movement feedback	no feedback	The device can report to the bus that the connected drive is active, i.e. the output is supplying power to the drive for a travel direction. No feedback object available for the output. Feedback deactivated.
	Feedback object is active signalling object	Feedback and the object are activated. The object transmits actively (telegram transmission after change).
	Feedback object is passive status object	Feedback and the object are activated. The object is passive (telegram transmission only as a response to 'Read' request).
Time delay for feedback telegram after bus voltage return ?	Yes (delay time under "General") No	The feedback telegram can be transmitted to the bus with a delay after bus voltage return or after programming with the ETS. Setting "Yes" activates the delay time of the feedback in case of bus voltage return. The delay time is configured under "General". This parameter is only visible in case of an actively transmitting feedback object.
<input type="checkbox"/> Output 1 - Safety I Wind alarm 1	disabled Enabled	This parameter can be used to enable the first wind alarm and thus to enable the communication object (setting: "disabled"). If the first wind alarm is deactivated (setting: "disabled"), the configured assignment of the Venetian blind output to wind alarm 1 is not operational.

Wind alarm 2	<p>disabled</p> <p>Enabled</p>	<p>This parameter can be used to enable the second wind alarm and thus to enable the communication object (setting: "disabled"). If the second wind alarm is deactivated (setting: "disabled"), the configured assignment of the Venetian blind output to wind alarm 2 is not operational.</p>
Wind alarm 3	<p>disabled</p> <p>Enabled</p>	<p>This parameter can be used to enable the third wind alarm and thus to enable the communication object (setting: "enabled"). If the third wind alarm is deactivated (setting: "disabled"), the configured assignment of the Venetian blind output to wind alarm 3 is not operational.</p>
Rain alarm	<p>disabled</p> <p>Enabled</p>	<p>This parameter can be used to enable the rain alarm and thus to enable the communication object (setting: "enabled"). If the rain alarm is deactivated (setting: "disabled"), any configured assignment of the Venetian blind output to the rain alarm is not operational.</p>
Frost alarm	<p>disabled</p> <p>Enabled</p>	<p>This parameter can be used to enable the frost alarm and thus to enable the communication object (setting: "enabled"). If the frost alarm is deactivated (setting: "disabled"), any configured assignment of the Venetian blind output to the frost alarm is not operational.</p>
Priority of safety alarms	<p>Wind -> rain -> frost Wind -> frost -> rain Rain -> wind -> frost Rain -> frost -> wind Frost -> rain -> wind Frost -> wind -> rain</p>	<p>This parameter defines the priority ranking of the individual safety alarms. Interpretation: High -> medium -> low. The three wind alarms have the same priority with respect to one another.</p>
<p><input type="checkbox"/> Output 1 - Safety II</p> <p>Use wind alarm monitoring function ? (only if wind alarms are enabled!)</p>	<p>Yes</p> <p>No</p>	<p>If the wind alarms enabled under "O1 - Safety I" are to be monitored cyclically for incoming telegrams to the safety objects, the monitoring function must be enabled here (setting: "yes"). Otherwise (setting: "No") there is no cyclical monitoring of the objects. As soon as the monitoring function is activated here, telegrams must be</p>

		transmitted cyclically to all enabled wind alarm objects. The monitoring function may only be activated, if at least one wind alarm has been activated under "O1 - Safety I".
Time for monitoring wind alarm Hours (0...23)	0...23	The wind alarm monitoring time is configured here.
Minutes (1...59)	1...25...59	Sets the monitoring time hours. Sets the monitoring time minutes. The cycle time of the transmitter should be less than half the configured monitoring time of the device. The times can only be set, if wind alarm monitoring is activated.
Use rain alarm monitoring function ?	Yes No	If the rain alarm enabled under "O1 - Safety I" is to be monitored cyclically for incoming telegrams to the safety object, the monitoring function must be enabled here (setting: "yes"). Otherwise (setting: "No") there is no cyclical monitoring of the object. As soon as the monitoring function is activated, telegrams must be transmitted cyclically to the enabled rain alarm object. The parameter is only visible, if the rain alarm has been enabled under "O1 - Safety I".
Time for monitoring rain alarm Hours (0...23)	0...23	The rain alarm monitoring time is configured here.
Minutes (1...59)	1...2...59	Sets the monitoring time hours. Sets the monitoring time minutes. The cycle time of the transmitter should be less than half the configured monitoring time of the device. The times can only be set if rain alarm monitoring is activated.
Use frost alarm monitoring function ?	Yes No	If the frost alarm enabled under "O1 - Safety I" is to be monitored cyclically for incoming telegrams to the safety object, the monitoring function must be enabled here (setting: "yes"). Otherwise (setting: "No") there is no cyclical monitoring of the object. As soon as the monitoring function is activated, telegrams must be transmitted cyclically to the enabled frost alarm object. The parameter is only visible, if the frost alarm has been enabled under "O1 - Safety I".

<p>Time for monitoring frost alarm Hours (0...23)</p>	<p>0...23</p>	<p>The frost alarm monitoring time is configured here.</p> <p>Sets the monitoring time hours.</p>
<p>Minutes (1...59)</p>	<p>1...2...59</p>	<p>Sets the monitoring time minutes. The cycle time of the transmitter should be less than half the configured monitoring time of the device. The times can only be set, if frost alarm monitoring is activated.</p>
<p><input type="checkbox"/> Output 1 - Safety III</p>		
<p>Assignment to wind alarms</p>	<p>No</p> <p>Wind alarm 1</p> <p>Wind alarm 2</p> <p>Wind alarm 3</p> <p>Wind alarm 1 + 2</p> <p>Wind alarm 1 + 3</p> <p>Wind alarm 2 + 3</p> <p>Wind alarm 1 + 2 + 3</p>	<p>This parameter defines whether the output responds to a wind alarm and to which of the alarms.</p>
<p>Behaviour in case of wind alarm</p>	<p>No reaction</p> <p>Raising / opening the louver</p> <p>Lowering / closing the louver</p> <p>Stop</p>	<p>This parameter defines the behaviour of the output at the beginning of a wind alarm.</p> <p>The behaviour preset in this parameter will be executed when one of the assigned wind alarms is activated. This parameter is only visible if the output has been assigned to at least one wind alarm.</p> <p>At the beginning of the wind alarm or wind alarms, the output is interlocked and the relay of the output shows no reaction. Any movements in progress at this instant will still be completely finished.</p> <p>The device raises the blind or opens the venting louver at the beginning of the wind alarm or wind alarms and locks the output thereafter.</p> <p>The device lowers the blind or closes the venting louver at the beginning of the wind alarm or wind alarms and locks the output thereafter.</p> <p>At the beginning of the wind alarm or wind alarms, the device switches the relays of the output to "stop" and locks the output. A drive movement, if any, will</p>

		be interrupted.
Assignment to rain alarm	Yes No	This parameter defines whether the output responds to the rain alarm.
Behaviour in case of rain alarm	No reaction	This parameter defines the behaviour of the output at the beginning of the rain alarm. This parameter is only visible, if the output has been assigned to the rain alarm. At the beginning of the rain alarm, the output is locked and the relay of the output shows no reaction. Any movements in progress at this instant will still be completely finished.
	Raising / opening the louver	The device raises the blind or opens the venting louver at the beginning of the rain alarm and locks the output thereafter.
	Lowering / closing the louver	The device lowers the blind or closes the venting louver at the beginning of the alarm and locks the output thereafter.
	Stop	At the beginning of the rain alarm, the device switches the relays of the output to "stop" and locks the output. A drive movement, if any, will be interrupted.
Assignment to frost alarm	Yes No	This parameter defines whether the output responds to the frost alarm.
Behaviour in case of frost alarm	No reaction	This parameter defines the behaviour of the output at the beginning of the frost alarm. This parameter is only visible, if the output has been assigned to the frost alarm. At the beginning of the frost alarm, the output is interlocked and the relay of the output shows no reaction. Any movements in progress at this instant will still be completely finished.
	Raising / opening the louver	The device raises the blind or opens the venting louver at the beginning of the frost alarm and locks the output thereafter.
	Lowering / closing the louver	The device lowers the blind or closes the venting louver at the beginning of the frost alarm and locks the output thereafter.
	Stop	

<p>Behaviour at the end of safety (Wind, rain, frost)</p>	<p>No reaction</p> <p>Raising / opening the louver</p> <p>Lowering / closing the louver</p> <p>Stop</p> <p>Tracking the position</p>	<p>At the beginning of the frost alarm, the device switches the relays of the output to "stop" and locks the output. A drive movement, if any, will be interrupted.</p> <p>This parameter defines the behaviour of the output at the end of all safety functions. The behaviour preset in this parameter will only be executed, if the output passes over to direct operation at the end of safety. Direct operation will be executed when a sun protection function is active.</p> <p>At the end of the safety functions, the output is unlocked and the relay of the output shows no reaction. Any movements still in progress at this instant will still be finished.</p> <p>The device unlocks the output at the end of all safety alarms and raises the blind or opens the venting louver.</p> <p>The device unlocks the output at the end of the safety functions and lowers the blind or closes the venting louver.</p> <p>At the end of the safety functions, the output is unlocked and the device switches the relays of the output into the "stop" position. A drive movement, if any, will be interrupted.</p> <p>At the end of safety, the output will be set to the state last adjusted before the safety function or to the state tracked and internally stored during the safety function. The position objects, the long time object and the scene function are tracked.</p>
<p><input type="checkbox"/> Output 1 - Sun protection</p> <p>Type of sun protection</p>	<p>simple sun protection</p> <p>enlarged sun protection mode</p>	<p>This parameter defines the scope of sun protection functions.</p> <p>Reduced scope of functions with standard configuration possibilities.</p> <p>Enlarged scope of functions including the possibilities of the simple sun protection. In addition, the connected drive can be integrated in shading control systems depending on the position of the sun. Automatic heating/cooling can also be implemented.</p>

Priority of sun protection with respect to direct operation

same priority

This parameter defines the priority of the sun protection function with respect to direct operation.

The sun protection can be overridden by direct operation and vice versa. Only after the next reception of a "sun is shining" signal will the sun protection mode be activated again.

higher priority

The sun protection has the higher priority and cannot be aborted by a direct operation.

Lower priority

The direct operation has the higher priority and cannot be aborted by sun protection. The sun protection can be activated only after an enabling movement into the upper end position initiated by a direct operation has occurred without interruption. This parameter is only visible in the simple sun protection. Direct operation = long-time/short-time operation; Positioning via objects, scenes

Priority of automatic operation with respect to direct operation

same priority

This parameter defines the priority of automatic operation with respect to direct operation. The selected priority affects the evaluation of the sunshine signal in the automatic mode and not the automatic mode itself.

The evaluation of the sunshine signal in the automatic mode can be overridden by a direct operation. In the same way, a direct operation is overridden by the reception of a new sunshine telegram.

higher priority

The automatic mode has the higher priority and cannot be aborted by a direct operation irrespective of the state of the sunshine signal. A direct operation will be possible again only after the automatic mode is terminated.

Lower priority

The direct operation has the higher priority and cannot be aborted by a sunshine signal in the automatic mode. The sunshine signal is evaluated again only after an enabling movement into the upper end position initiated by a direct operation has occurred without interruption and only if the automatic mode is activated and not disabled at this time. This parameter is only visible in the extended sun protection. Direct operation = long-time/short-time operation; Positioning via objects, scenes

Polarity of the "Sunshine / shading facade" object	<p>sunshine = 1; no sunshine = 0</p> <p>Sunshine = 0; no sunshine = 1</p>	This parameter defines the polarity of the input object "Sunshine / shading facade" of the sun protection.
Activation of automatic operation via...	Object "Automatic" & next change of state	This parameter defines how to activate the automatic mode and the reactions resulting from such activation.
	object "Automatic" & immediate tracking	Automatic operation is activated as soon as the "Automatic" object is set to 'active' in consideration of polarity. A reaction at the output occurs, however, only after a new change of state has been signalled via the "Sunshine / shading facade" object. In this case, the new state (beginning of sun protection or end of sun protection) determines the behaviour of the output.
		Automatic operation is activated as soon as the "Automatic" object receives a "1" telegram. The state of the object "Sunshine / shading facade" immediately determines the behaviour of the output (beginning of sun protection, end of sun protection).
		The reception of a telegram 'Automatic mode inactive' at the "Automatic" object immediately ends the automatic mode in both cases. The behaviour is in this case defined by the parameter "Reaction at the end of automatic operation".
Polarity of "Automatic" object	<p>automatic mode: activated = 1; deactivated = 0</p> <p>Automatic mode: activated = 0; deactivated = 1</p>	This parameter defines the polarity of the automatic object. This parameter is only visible if the parameter "Activation of automatic operation via..." is set to "automatic" & next change of state".
Disabling function for automatic mode ?	<p>Yes</p> <p>No</p>	The automatic mode can be disabled. When disabling is active, the automatic mode is aborted. It can only be reactivated, if a "1" is written into the "Automatic" object. The objects "Automatic" and "Automatic mode disable" are logically combined (AND with feedback). The "Yes" setting enables the disabling function and makes the disabling object visible. This parameter is only visible, if the parameter "Activation of automatic operation via..."

Polarity of "Automatic mode disable" object	<p>Automatic mode: enabled = 1; disabled = 0</p> <p>Automatic mode: enabled = 0; disabled = 1</p>	<p>is set to "object automatic & immediate tracking".</p> <p>This parameter defines the polarity of the automatic mode disable object. Disabling is active when a telegram with polarity 'disabled' is received. This parameter is only visible, if the parameter "Disabling function for automatic mode - ?" is set to "yes".</p>
Disabling function for direct operation ?	<p>Yes</p> <p>No</p>	<p>Direct operation can be disabled. When disabling is active, a direct operation can – independent of the preset priority – never override a sun protection function. In this case, direct operation is disabled in other functions, too. The "Yes" setting enables the disabling function and makes the disabling object visible.</p> <p>Direct operation = long-time/short-time operation; Positioning via objects, scenes</p>
Polarity of "Direct operation disable" object	<p>Automatic mode: enabled = 1; disabled = 0</p> <p>Automatic mode: enabled = 0; disabled = 1</p>	<p>This parameter defines the polarity of the disabling object for direct operation. Disabling is active when a telegram with polarity 'disabled' is received. This parameter is only visible, if the parameter "Direct operation disable?" is set to "yes".</p>
Reaction at the end of automatic operation	<p>No reaction</p> <p>Raising / opening the louver</p> <p>Lowering / closing the louver</p> <p>Stop</p>	<p>This parameter defines the behaviour of the output at the end of automatic operation and also at the beginning of an automatic operation disable. The behaviour preset in this parameter will only be executed, if no function with a higher priority (e.g. safety) is activated at the end of automatic operation.</p> <p>At the end of automatic operation, the sun protection function is ended and the relay of the output shows no reaction. Any movements still in progress at this instant will still be finished.</p> <p>At the end of automatic operation, the device terminates the sun protection and raises the blind or opens the venting louver.</p> <p>At the end of automatic operation, the device terminates the sun protection and lowers the blind or closes the venting louver.</p> <p>At the end of automatic operation the sun protection is terminated and the device switches the relays of the output to "stop". A drive movement, if any, will be interrupted.</p>

		Tracking the position	At the end of automatic operation, the output will be set to the state last adjusted before the automatic sun protection or to the state tracked and internally stored during the automatic sun protection. The position objects, the long time object and the scene function are tracked.
☐ Output 1 - Beginning of sun protection			
Time delay beginning of sunshine / shading Minutes (0...59)	0...59		The telegram received via the object "Sunshine / shading facade" for activation of shading (depending on polarity) can be evaluated with a time delay..
			Setting the delay time minutes.
Seconds (0...59)	0... 30 ...59		Setting the delay time seconds. A time setting of "0" in the parameters deactivates the respective delay time. In this case, the state of shading is evaluated immediately.
Reaction at the beginning of sunshine / shading			This parameter defines the behaviour of the output at the beginning of shading – if applicable, after the end of the delay time. This parameter is visible only in the 'Venetian blind' operating mode.
	No reaction		At the beginning of shading, the output switches over to sun protection while the relays of the output show no reaction. Any movements still in progress at this instant will still be finished.
	Raising		At the beginning of shading, the device raises the blind.
	Lowering		At the beginning of shading, the device lowers the blind.
	Stop		At the beginning of shading, the device switches the relays of the output to the "stop" position. A drive movement, if any, will be interrupted.
	Internal scene recall		At the beginning of shading, the device recalls the position values for the affected output which were preset in the scene configuration. This is not a scene recall as in direct operation, but only an approach of the corresponding scene position values.
	Venetian blind or slat position fixed		At the beginning of shading, the output controls the approach to a configured fixed Venetian blind and slat position.

	Venetian blind position fixed / slat position variable	At the beginning of shading, the output controls the approach to a configured fixed Venetian blind position and to slat position preset by a separate object and thus variable.
	Slat position fixed / Venetian blind position variable	At the beginning of shading, the output controls the approach to a configured fixed slat position and to a Venetian blind position preset by a separate object and thus variable.
	Venetian blind and slat position variable	At the beginning of shading, the output controls the approach to the Venetian blind and slat positions preset by two separate objects and thus variable.
Reaction at the beginning of sunshine / shading		This parameter defines the behaviour of the output at the beginning of shading – if applicable, after the end of the delay time. This parameter is visible only in the "Roller Shutter / Awning" operating mode.
	No reaction	At the beginning of shading, the output switches over to sun protection while the relays of the output show no reaction. Any movements still in progress at this instant will still be finished.
	Raising	At the beginning of shading, the device raises the blind.
	Lowering	At the beginning of shading, the device lowers the blind.
	Stop	At the beginning of shading, the device switches the relays of the output to the "stop" position. A drive movement, if any, will be interrupted.
	Internal scene recall	At the beginning of shading, the device recalls the position values for the affected output which were preset in the scene configuration. This is not a scene recall as in direct operation, but only an approach of the corresponding scene position values.
	shutter / awning position fixed	At the beginning of shading, the output controls the approach to a configured fixed roller shutter / awning position.
	Roller shutter / awning position variable	At the beginning of shading, the output controls the approach to the roller shutter / awning position preset by a separate object and thus variable.
Reaction at the beginning of sunshine / shading		This parameter defines the behaviour of the output at the beginning of shading – if applicable, after the end of the delay time.

		This parameter is visible only in the "Venting louver" operating mode.
	No reaction	At the beginning of shading, the output switches over to sun protection while the relays of the output show no reaction. Any movements still in progress at this instant will still be finished.
	Opening the louver	At the beginning of shading, the device opens the venting louver.
	Closing the louver	At the beginning of shading, the device closes the venting louver.
	Stop	At the beginning of shading, the device switches the relays of the output to the "stop" position. A drive movement, if any, will be interrupted.
	Internal scene recall	At the beginning of shading, the device recalls the position values for the affected output which were preset in the scene configuration. This is not a scene recall as in direct operation, but only an approach of the corresponding scene position values.
	Fixed position of venting louver	At the beginning of shading, the output controls the approach to a configured fixed venting louver position.
	Venting louver position variable	At the beginning of shading, the output controls the approach to the venting louver position preset by a separate object and thus variable.
Scene number (1...8)	1...8	This parameter defines the number of the internal scene which is recalled at the beginning of shading. This parameter is only visible, if the parameter "Reaction at the beginning of sunshine / shading" is set to "internal scene recall".
Fixed position of Venetian blind		The fixed Venetian blind position at the beginning of shading can either be preset statically by a separate parameter or basically adjusted to the value prevailing at the time of shading activation, i.e. remain unchanged.
	Same as configured value	At the beginning of shading, the configured Venetian blind position value will be approached.
	No change in current position	At the beginning of shading, the current position of the Venetian blind will be maintained. In this case, the output behaves as if only the slat were positioned as a result of shading. This parameter is only visible, if the Venetian blind is to approach a fixed

		position at the beginning of shading. This parameter is visible only in the 'Venetian blind' operating mode.
Venetian blind position (0...100 %)	0... 50 ...100	This parameter sets the fixed position of the Venetian blind to be approached at the beginning of shading. This parameter is only visible, if the parameter "Fixed position of Venetian blind" is set to "as specified by parameter". This parameter is visible only in the 'Venetian blind' operating mode.
Fixed slat position (0...100 %)	0... 50 ...100	This parameter sets the fixed position of the slat to be approached at the beginning of shading and, as the case may be, after positioning of the Venetian blind. This parameter is only visible, if the slat is to approach a fixed position at the beginning of shading. This parameter is visible only in the 'Venetian blind' operating mode.
Fixed position of roller shutter / awning		The fixed position of the roller shutter or awning at the beginning of shading can either be preset statically by a separate parameter or basically adjusted to the value prevailing at the time of shading activation, i.e. remain unchanged.
	Same as configured value	At the beginning of shading, the configured roller shutter or awning position will be approached.
	No change in current position	At the beginning of shading, the current position of the roller shutter or awning will be maintained. Any movements in progress at the time of shading activation will be finished. This parameter is only visible, if the shutter or awning is to approach a fixed position at the beginning of shading. This parameter is visible only in the "Roller Shutter / Awning" operating mode.
Position of roller shutter / awning (0...100 %)	0... 50 ...100	This parameter sets the fixed position of the roller shutter or awning to be approached at the beginning of shading. This parameter is only visible, if the parameter "Fixed position of shutter / awning" is set to "as specified by parameter". This parameter is visible only in the "Roller Shutter / Awning" operating mode.

Fixed position of venting louver

The fixed venting louver position at the beginning of shading can either be preset statically by a separate parameter or basically adjusted to the value prevailing at the time of shading activation, i.e. remain unchanged.

Same as configured value

At the beginning of shading, the configured venting louver position will be approached.

No change in current position

At the beginning of shading, the current position of the venting louver will be maintained. Any movements in progress at the time of shading activation will be finished.

This parameter is only visible if the venting louver is to approach a fixed position at the beginning of shading. This parameter is visible only in the "Venting louver" mode of operation.

Position of venting louver (0...100 %)

0...**50**...100

This parameter sets the fixed position of the venting louver to be approached at the beginning of shading.

This parameter is only visible, if the parameter "Fixed position of venting louver" is set to "as specified by parameter". This parameter is visible only in the "Venting louver" mode of operation.

Reference movement before each sun protection positioning operation ?

Yes

No

A forced reference movement of the drive is performed before sun protection positioning (setting "yes"). A reference movement is a positioning movement into the upper end position or into the completely open position. By means of a forced reference movement, drives connected to different outputs can be synchronised. If no synchronising movement is forced (setting "no"), the device performs a reference movement only once after return of the power supply.

Offset with fixed and variable slat position

For 'manual' readjustment of the slat angle during a shading or sun position tracking operation, a slat offset can be preset. The offset corrects the preset slat angle in positive or in negative direction. The lighting conditions in a room can thus be individually adapted by persons present in the room. This parameter is only visible, if the slat is to approach a fixed or a variable position at the beginning of shading.

		This parameter is visible only in the 'Venetian blind' operating mode.
	no offset	The offset correction is deactivated.
	Offset as configured	The slat offset is statically preset by means of a fixed parameter value.
	Offset as configured and via object	The slat offset is preset by a fixed parameter value and can be dynamically adapted via a separate communication object.
Offset slat position (-100..100 %)	-100... 0 ...100	This parameter is used for setting the slat offset. The value specified in this parameter is added at the beginning of shading to the current slat angle. Even with offset correction, the 0...100% slat position limits cannot be overstepped. It should be noted that the configured offset value can be overwritten by the object after reception of a dynamic value. This parameter is only visible, if the parameter "Offset with fixed and variable slat position" is set to "Offset as configured" or to "Offset as configured and via object". This parameter is visible only in the 'Venetian blind' operating mode.
Store offset slat position via object in case of bus voltage failure ?		If the offset is preset via the object, this parameter defines whether the received value is to be stored in the device's NV memory. This parameter is only visible, if the parameter "Offset with fixed and variable slat position" is set to "offset as configured and via object". This parameter is visible only in the 'Venetian blind' operating mode.
	yes	The value received via the object will be stored in case of bus voltage failure in a non-volatile memory of the device. The originally configured offset value is definitely overwritten in the process.
	No	The value received via the object will only be stored temporarily in volatile memory. This only replaces the configured value until the device is reinitialised. After the initialisation, the offset value configured in the ETS will be used again.
<input type="checkbox"/> Output 1 - End of sun protection		
Time delay at end of sunshine / shading Minutes (0...59)	0 ...59	The telegram received via the object "Sunshine / shading facade" for deactivation of shading (depending on

		polarity) can be evaluated with a time delay..
		Setting the delay time minutes.
Seconds (0...59)	0... 30 ...59	Setting the delay time seconds. A time setting of "0" in the parameters deactivates the respective delay time. In this case, the state of shading is evaluated immediately.
Reaction at the end of sunshine / shading		This parameter defines the behaviour of the output at the end of shading – if applicable, after the end of the delay time. The behaviour preset in this parameter will only be executed if no function with a higher priority (e.g. safety) is activated at the end of shading. This parameter is only visible in the simple sun protection.
	No reaction	At the end of shading, the output quits the sun protection mode and the relays of the output show no reaction. Any movements still in progress at this instant will still be finished.
	Raising / opening the louver	At the end of shading, the device raises the blind or opens the venting louver.
	Lowering / closing the louver	At the end of shading, the device lowers the blind or closes the venting louver.
	Stop	At the end of shading, the device switches the relays of the output to the "stop" position. A drive movement, if any, will be interrupted.
	Tracking the position	At the end of shading, the output will be set to the state last adjusted before sun protection or to the state tracked and internally stored during sun protection. The position objects, the long time object and the scene function are tracked.
Reaction at the end of sunshine / shading		This parameter defines the behaviour of the output at the end of shading – if applicable, after the end of the delay time. This parameter is only visible in the extended sun protection and in "Venetian blind" mode. This parameter does not define the behaviour of the output at the end of automatic operation (cf. parameter "Reaction at the end of automatic operation")!
	No reaction	At the end of shading, the relays of the output show no reaction. Any movements still in progress at this instant will still be finished.

	Raising	At the end of shading, the device raises the blind.
	Lowering	At the end of shading, the device lowers the blind.
	Stop	At the end of shading, the device switches the relays of the output to the "stop" position. A drive movement, if any, will be interrupted.
	Internal scene recall	At the end of shading, an internal scene of the device is recalled.
	Venetian blind or slat position fixed	At the end of shading, the output moves to a configured fixed Venetian blind and slat position.
Reaction at the end of sunshine / shading		<p>This parameter defines the behaviour of the output at the end of shading – if applicable, after the end of the delay time.</p> <p>This parameter is only visible in the extended sun protection and in "Roller shutter / awning" mode. This parameter does not define the behaviour of the output at the end of automatic operation (cf. parameter "Reaction at the end of automatic operation")!</p>
	No reaction	At the end of shading, the relays of the output show no reaction. Any movements still in progress at this instant will still be finished.
	Raising	At the end of shading, the device raises the blind.
	Lowering	At the end of shading, the device lowers the blind.
	Stop	At the end of shading, the device switches the relays of the output to the "stop" position. A drive movement, if any, will be interrupted.
	Internal scene recall	At the end of shading, an internal scene of the device is recalled.
	shutter / awning position fixed	At the end of shading, the output moves to a configured fixed roller shutter / awning position.
Reaction at the end of sunshine / shading		<p>This parameter defines the behaviour of the output at the end of shading – if applicable, after the end of the delay time.</p> <p>This parameter is only visible in the extended sun protection and in "Venting louver" mode. This parameter does not define the behaviour of the output at the end of automatic operation (cf. parameter "Reaction at the end of automatic operation")!</p>

	No reaction	At the end of shading, the relays of the output show no reaction. Any movements still in progress at this instant will still be finished.
	Opening the louver	At the end of shading, the device opens the venting louver.
	Closing the louver	At the end of shading, the device closes the venting louver.
	Stop	At the end of shading, the device switches the relays of the output to the "stop" position. A drive movement, if any, will be interrupted.
	Internal scene recall	At the end of shading, an internal scene of the device is recalled.
	Fixed position of venting louver	At the end of shading, the output moves to a configured fixed venting louver position.
Scene number (1...8)	1...8	This parameter defines the number of the internal scene which is recalled at the end of shading. This parameter is only visible, if the parameter "Reaction at the end of sunshine / shading" is set to "internal scene recall".
Fixed position of Venetian blind		The fixed Venetian blind position at the end of shading can either be preset statically by a separate parameter or basically remain at the value set or tracked by the shading operation. This parameter is only visible, if the Venetian blind is to approach a fixed position at the end of shading. This parameter is visible only in the 'Venetian blind' operating mode.
	Same as configured value	At the end of shading, the configured Venetian blind position will be approached.
	No change in current position	At the end of shading, the current position of the Venetian blind will be maintained. In this case, the output behaves as if only the slat were positioned as a result of the end of shading.
Venetian blind position (0...100 %)	0... 50 ...100	This parameter sets the fixed position of the Venetian blind to be approached at the end of shading.
Fixed slat position (0...100 %)	0... 50 ...100	This parameter sets the fixed position of the slat to be approached at the end of shading and, as the case may be, after positioning of the Venetian blind.

Fixed position of roller shutter / awning	Same as configured value	This parameter is only visible, if the slat is to approach a fixed position at the beginning of shading. This parameter is visible only in the 'Venetian blind' operating mode.
	No change in current position	The fixed position of the roller shutter or awning at the end of shading can either be preset statically by a separate parameter or basically adjusted to the value prevailing at the time of shading activation, i.e. remain unchanged. This parameter is only visible, if the shutter or awning is to approach a fixed position at the end of shading. This parameter is visible only in the "Roller Shutter / Awning" operating mode.
Position of roller shutter / awning (0...100 %)	0... 50 ...100	At the end of shading, the configured roller shutter or awning position will be approached. At the end of shading, the current position of the roller shutter or awning will be maintained. Any movements in progress at the time of shading activation will be finished. This parameter sets the fixed position of the roller shutter or awning to be approached at the end of shading. This parameter is only visible, if the parameter "Fixed position of shutter / awning" is set to "as specified by parameter". This parameter is visible only in the "Roller Shutter / Awning" operating mode.
Fixed position of venting louver	Same as configured value	The fixed venting louver position at the end of shading can either be preset statically by a separate parameter or basically adjusted to the value prevailing at the time of shading activation, i.e. remain unchanged.
	No change in current position	This parameter is only visible if the venting louver is to approach a fixed position at the end of shading. This parameter is visible only in the "Venting louver" mode of operation.
		At the end of shading, the configured venting louver position will be approached.
		At the end of shading, the current position of the venting louver will be maintained. Any movements in progress at the time of shading activation will be finished.

Position of venting louver (0...100 %)	0... 50 ...100	<p>This parameter sets the fixed position of the venting louver to be approached at the end of shading.</p> <p>This parameter is only visible, if the parameter "Fixed position of venting louver" is set to "as specified by parameter". This parameter is visible only in the "Venting louver" mode of operation.</p>
<input type="checkbox"/> Output 1 - Automatic heating/cooling		
Automatic heating/cooling	disabled Enabled	<p>This parameter can be used to activate the automatic heating/cooling function. The automatic heating/cooling function adds a presence detection function to the extended sun protection mode. If a person is present, the extended sun protection is executed as described. If nobody is present, however, the Venetian blinds, roller shutters, awnings or venting louvers can be operated in such a way that these devices support the heating or cooling function of the building.</p> <p>When the function is enabled, the other parameters and objects are visible. The automatic heating/cooling function can only be activated in the extended sun protection mode. Moreover, the automatic heating/cooling function is only active when the automatic mode of the extended sun protection function is activated.</p>
Polarity of "Heating/cooling presence" object	Cooling = 0; Heating = 1 Cooling = 1; Heating = 0	<p>This parameter defines the polarity of the object for heating/cooling switchover.</p> <p>This object is linked, for instance, with room temperature controllers or outside thermometers.</p> <p>After the return of the power supply of the device, the heating/cooling switchover function is initialised with an object value of "0" and the set polarity. This parameter is visible only if automatic heating/cooling is enabled.</p>
Polarity of "Heating/cooling presence" object	No presence = 0; Presence = 1 No presence = 1; Presence = 0	<p>This parameter defines the polarity of the object for presence control in case of automatic heating/cooling.</p> <p>This object is linked, for example, with presence detectors.</p> <p>After the return of the power supply of the device, the heating/cooling presence controller is initialised with an object</p>

		value of "0" and the set polarity. This parameter is visible only if automatic heating/cooling is enabled.
Time delay at the beginning of presence Minutes (0...59)	0...59	The telegram received via the object "Heating/cooling presence" for activation of the presence function (in acc. with polarity) can be evaluated with a time delay. A time setting of "0" in the parameters deactivates the respective delay time. In this case, the state of the presence object is evaluated immediately.
Seconds (0...59)	0...30...59	Setting the delay time minutes. Setting the delay time seconds. These parameters are visible only if automatic heating/cooling is enabled.
Time delay at the end of presence Minutes (0...59)	0...59	The telegram received via the object "Heating/cooling presence" for deactivation of the presence function (in acc. with polarity) can be evaluated with a time delay. A time setting of "0" in the parameters deactivates the respective delay time. In this case, the state of the presence object is evaluated immediately.
Seconds (0...59)	0...30...59	Setting the delay time minutes. Setting the delay time seconds. These parameters are visible only if automatic heating/cooling is enabled.
Reaction to sunshine / shading		This parameter defines the behaviour of the output at the end / at the beginning of sunshine / shading with heating / cooling – if applicable, after the end of the delay time.
Start on cooling *		This parameter is visible only in the "Venetian blind" mode if automatic heating/cooling is enabled.
End on cooling *		
Start on heating *		
End on heating *		
	No reaction	The relays of the output show no reaction. Any movements still in progress at this instant will still be finished.
	Raising	The device raises the blind.
	Lowering	The device lowers the blind.
	Internal scene recall	An internal scene of the device is recalled.
	Venetian blind or slat position fixed	The output moves to a configured fixed Venetian blind and slat position.

		<p>*: The parameter settings for heating or cooling or beginning or end must be configured separately. The setting options - also for the follow-up parameters - are identical in all cases.</p>
Reaction to sunshine / shading		This parameter defines the behaviour of the output at the end / at the beginning of sunshine / shading with heating / cooling – if applicable, after the end of the delay time.
Start on cooling *		This parameter is visible only in the "Roller shutter / awning" mode if automatic heating/cooling is enabled.
End on cooling *		
Start on heating *		
End on heating *		
	No reaction	The relays of the output show no reaction. Any movements still in progress at this instant will still be finished.
	Raising	The device raises the blind.
	Lowering	The device lowers the blind.
	Internal scene recall	An internal scene of the device is recalled.
	Fixed roller shutter / awning position	The output moves to a configured fixed roller shutter or awning position.
		<p>*: The parameter settings for heating or cooling or beginning or end must be configured separately. The setting options - also for the follow-up parameters - are identical in all cases.</p>
Reaction to sunshine / shading		This parameter defines the behaviour of the output at the end / at the beginning of sunshine / shading with heating / cooling – if applicable, after the end of the delay time.
Start on cooling *		This parameter is visible only in the "Venting louver" mode if automatic heating/cooling is enabled.
End on cooling *		
Start on heating *		
End on heating *		
	No reaction	The relays of the output show no reaction. Any movements still in progress at this instant will still be finished.
	Opening the louver	The device opens the venting louver.
	Closing the louver	The device closes the venting louver.
	Internal scene recall	An internal scene of the device is recalled.
	Venting louver position fixed	The output moves to a configured fixed venting louver position.

*: The parameter settings for heating or cooling or beginning or end must be configured separately. The setting options - also for the follow-up parameters - are identical in all cases.

Scene number (1...8)	1...8	This parameter defines the number of the internal scene which is recalled. This parameter is only visible, if the parameter "Reaction in case of sunshine / shading" of the automatic heating/cooling function is set to "internal scene recall".
Fixed position of Venetian blind		The fixed Venetian blind position in case of automatic heating/cooling can either be preset statically by a separate parameter or basically remain at the current value. This parameter is only visible, if the Venetian blind is to approach a fixed position in case of automatic heating/cooling. In addition, this parameter is visible only in the 'Venetian blind' operating mode.
	Same as configured value	The configured position of the Venetian blind will be approached.
	No change in current position	The current position of the Venetian blind will be maintained. In this case, the output behaves as if only the slat were positioned.
Venetian blind position (0...100 %)	0... 50 ...100	This parameter sets the fixed position of the Venetian blind to be approached in case of automatic heating/cooling. This parameter is only visible, if the parameter "Fixed position of Venetian blind" is set to "as specified by parameter". In addition, this parameter is visible only in the 'Venetian blind' operating mode.
Fixed slat position (0...100 %)	0... 50 ...100	This parameter sets the fixed position of the slat to be approached in case of automatic heating/cooling and, as the case may be, after positioning of the Venetian blind. This parameter is only visible, if the slat is to approach a fixed position with automatic heating/cooling. In addition, this parameter is visible only in the 'Venetian blind' operating mode.

Fixed position of roller shutter / awning

The fixed roller shutter/awning position in case of automatic heating/cooling can either be preset statically by a separate parameter or basically remain at the current value.

This parameter is only visible, if the roller shutter or awning is to approach a fixed position in case of automatic heating/cooling. In addition, this parameter is visible only in the "Roller Shutter / Awning" operating mode.

Same as configured value The configured roller shutter or awning position is approached.

No change in current position The current roller shutter / awning position will be maintained.

Position of roller shutter / awning (0...100 %)

0...**50**...100

This parameter sets the fixed position of the Venetian blind to be approached with automatic heating/cooling.

This parameter is only visible, if the parameter "Fixed position of shutter / awning" is set to "as specified by parameter". In addition, this parameter is visible only in the "Roller Shutter / Awning" operating mode.

Fixed position of venting louver

The fixed venting louver position in case of automatic heating/cooling can either be preset statically by a separate parameter or basically remain at the current value.

This parameter is only visible, if the venting louver is to approach a fixed position in case of automatic heating/cooling. In addition, this parameter is visible only in the "Venting louver" operating mode.

Same as configured value The configured venting louver position will be approached.

No change in current position The current position of the venting louver will be maintained.

Position of venting louver (0...100 %)

0...**50**...100

This parameter sets the fixed position of the venting louver to be approached in case of automatic heating/cooling.

This parameter is only visible, if the parameter "Fixed position of venting louver" is set to "as specified by parameter". In addition, this parameter is visible only in the "Venting louver" operating mode.

☐ Output 1 - Scenes

Delay scene recall ?	Yes No	A scene is recalled via the scene extension object. If needed, the scene recall on the device can be made with a delay after reception of a recall telegram (setting: "Yes"). The recall is alternatively made immediately on reception of the telegram (setting: "No"). A recall delay has no influence on the storage of scene values.
Delay time Minutes (0...59)	0...59	This parameter is used for programming the duration of the switch-on time for a scene recall. The delay time parameters are only visible, if the parameter "Delay scene recall ?" is configured to "Yes". Switch-on time minutes setting.
Seconds (0...59)	0...10...59	Switch-on time seconds setting.
Overwrite values stored in the device during ETS download ?	yes No	During storage of a scene, the scene values (current states of the output) are stored internally in the device. To prevent the stored values from being replaced during an ETS programming operation by the originally programmed scene states, the device can inhibit overwriting of the scene values (setting: "No"). As an alternative, the original values can be reloaded into the device during each ETS programming operation (setting: "Yes").
Scene X activatable by scene number (scene number "0" = scene deactivated) <i>X =depending on the scene (1...8)</i>	0...1*...64 <i>*: The predefined scene number is dependent on the scene (1...8).</i>	The device distinguishes between up to 8 different scenes which are recalled via the scene extension object or stored. The datapoint type of the extension object, however, permits addressing a maximum of 64 scenes. This parameter defines the scene number (1...64) which is used to address the internal scene (1...8). A setting of "0" deactivates the corresponding scene.
Venetian blind position for scene X <i>X =depending on the scene (1...8)</i>	0*...100 <i>*: The predefined position value is dependent on the scene (1...8).</i>	This parameter is used for parameterizing the blind position which is executed when the scene is recalled. This parameter is visible only in the "Venetian blind" operating mode.
Slat position for scene X <i>X =depending on the scene (1...8)</i>	0*...100 <i>*: The predefined position value is dependent on the scene (1...8).</i>	This parameter is used for configuring the slat position which is executed when the scene is recalled. This parameter is visible only in the "Venetian blind" operating mode.

<p>Roller shutter/awning position for scene X</p> <p><i>X =depending on the scene (1...8)</i></p>	<p>0*...100</p> <p><i>*: The predefined position value is dependent on the scene (1...8).</i></p>	<p>This parameter is used for configuring the roller shutter or awning position which is executed when the scene is recalled.</p> <p>This parameter is visible only in the "Roller Shutter / Awning" operating mode.</p>
<p>Position of venting louver for scene X</p> <p><i>X =depending on the scene (1...8)</i></p>	<p>0*...100</p> <p><i>*: The predefined position value is dependent on the scene (1...8).</i></p>	<p>This parameter is used for configuring the venting louver position which is executed when the scene is recalled.</p> <p>This parameter is visible only in the "Venting louver" operating mode.</p>
<p>Storage function for scene X</p> <p><i>X =depending on the scene (1...8)</i></p>	<p>Yes</p> <p>No</p>	<p>Setting "yes" enables the storage function of the scene. If the function is enabled, the current position (0...100 %) can be stored internally via the extension object on reception of a storage telegram. If "no" is selected, the storage telegrams are rejected.</p>
<p><input type="checkbox"/> Output 1 - Forced position</p>		
<p>Behaviour at the end of the forced position function</p>	<p>Tracking the position</p> <p>No change</p>	<p>The behaviour of the output at the beginning of a forced position function is directly determined by the forced position telegram. The behaviour of the output at the end of the forced position function can be configured.</p> <p>At the end of the forced position state, the output will be set to the position last existing before the forced position function or to the one tracked internally while the forced position function was active.</p> <p>At the end of forced position state, the position last adjusted will not be changed. Thereafter, the output is again enabled.</p>
<p>Behaviour after bus voltage return</p>	<p>no forced position active</p> <p>Forced position on, raising / opening the louver</p>	<p>The forced position communication object can be initialised after bus voltage return.</p> <p>This parameter is evaluated even after an ETS download of the application or of parameters.</p> <p>The forced position is deactivated after bus voltage return.</p>

		After bus voltage return, the forced position is activated and the blind raised or the venting louver opened.
	Forced position on, lowering / closing the louver	After bus voltage return, the forced position is activated and the blind lowered or the venting louver closed.
	State of forced position before bus failure	After bus voltage return, the forced position state last selected and internally stored <u>before</u> bus voltage failure will be tracked. An ETS programming operation deletes the stored state (reaction in that case same as with "no forced position active").
□ Output 1 - Fabric stretching (only in the "Roller Shutter / Awning" operating mode)		
Time for fabric stretching Seconds (0...59)	0...59	This parameter can be used to specify the time for fabric stretching. After the end of a downward travel the awning stops and – after elapsing of the switchover delay – moves backwards in opposite direction for a period corresponding to the fabric stretching time configured here. Setting of the fabric stretching time in seconds.
Milliseconds (4...9 x 100)	4...9	Setting of the fabric stretching time in milliseconds. The time for fabric stretching must be less than the movement time of the roller shutter/awning.

4.2.6.4 Parameters for the valve output

Description	Values	Comment
□ Output 2 - General		
Valve direction of action (valve in deenergised state)	closed	Valve drives, which are closed in the deenergised state, and valve drives, which open in the deenergised state, can be connected to the valve output of the device. For the device to control the valve drives 'with the correction direction of action', the valve direction of action of the connected drives must be configured here.
	opened	
Forced position via object		With the forced position of a valve output, a constant valve forced position (0 % to 100 %) can be stored in the device, which is applied as the valve setpoint in an activated forced position and which is executed by a pulse width modulation. The valve forced position can be set in the ETS differently for summer and winter operation, if the operating mode switchover is enabled.
	disabled	The forced position function is deactivated, meaning that the appropriate object is not visible in the ETS.
	Enabled	The forced position function is enabled and the 1-bit communication object "Forced position" is visible in the ETS.
Summer/winter mode switchover ?		Constant valve position values (0...100%) can be configured in the ETS for the forced position function and emergency operation. If a forced position or emergency operation was activated, the device switches the specified valve position at the valve output using pulse width modulation. It is possible to specify different valve position values for summer and winter in the ETS. For the device to be able to distinguish between the summer and winter valve position values for the forced position function and emergency operation, the operating mode switchover must be enabled here.
	Yes	The operating mode switchover for summer and winter operation is enabled. The 1-bit communication object "Summer/winter switchover" becomes visible in the ETS.

	No	The operating mode switchover for summer and winter operation is disabled. Only one valve position value can be configured separately for the forced position function and emergency operation in the ETS.
Polarity of "Summer/winter switchover" object	Summer = 1 / Winter = 0 Summer = 0 / Winter = 1	The telegram polarity of the 1-bit "Summer/winter switchover" communication object can be set here. This parameter is only visible if the summer/winter operation switchover is enabled.
Operating mode after device reset	Winter mode Summer mode	After an ETS programming operation or bus voltage return, the device automatically initialises the value of the communication object "Summer/winter switchover". The initialisation value is configured here. This parameter is only visible if the summer/winter operation switchover is enabled.
Value for forced position ... (0...100%)	0... 40 ...100	As soon as an "ON" telegram was received via the "Forced position" object, the device activates the forced position for the valve output and controls the valve drive to the valve forced position value specified here. The value configured here can also be used as a valve setpoint position value after an ETS programming operation and bus voltage return. This parameter is available twice if the operating mode switchover (summer/winter) is enabled.
Value for emergency operation ... (0...100%)	0... 50 ...100	If, during cyclical command value monitoring, a missing command value telegram was detected, the device activates emergency operation for the valve output and controls the valve drive to the valve emergency position value specified here. The value configured here can also be used as a valve setpoint position value after an ETS programming operation and bus voltage return. This parameter is available twice if the operating mode switchover (summer/winter) is enabled.
Anti-sticking protection	disabled Enabled	The device possesses automatic anti-sticking protection, in order to prevent calcification or sticking of a valve which

		has not been operated for some time.
Behaviour after bus voltage return		The state of the value output on bus voltage return can be configured here.
	Valve closes	After bus voltage return, the device closes the connected valve drives completely.
	Valve opens	After bus voltage return, the device opens the connected valve drives completely.
	Valve to value for forced position	The device sets the connected valve drives to the value for the forced position (0...100 %) configured in the ETS. In the 0 % setting, the output is closed completely, whilst, in the 100 % setting it is completely opened.
	Valve to value for emergency operation	The device sets the connected valve drives to the value for emergency operation (0...100 %) configured in the ETS. In the 0 % setting, the output is closed completely, whilst, in the 100 % setting it is completely opened.
	State before bus failure	After bus voltage return, the state last selected and internally stored <u>before</u> bus voltage failure (last command value/ valve setpoint position and state of the "Forced position" object) will be tracked. The energisation of the valve output always takes place taking the set valve direction of action into account.
Behaviour of all valve outputs after ETS programming		The state of a valve drive connected to the valve output after an ETS programming operation can be set here. This means that the behaviour can be configured independently to the behaviour after the bus voltage return. The energisation of the valve outputs always takes place taking the set valve direction of action of each output into account.
	Close valves	After an ETS programming operation, the device closes the connected valve drives completely.
	Open valves	After an ETS programming operation, the device opens the connected valve drives completely.
	Valves to value for forced position	The device sets the connected valve drives to the value for the forced position (0...100 %) configured in the ETS. In the 0 % setting, the output is closed completely, whilst, in the 100 % setting it is completely opened.

<p>Valves to value for emergency operation</p>	<p>The device sets the connected valve drives to the value for emergency operation (0...100 %) configured in the ETS. In the 0 % setting, the output is closed completely, whilst, in the 100 % setting it is completely opened.</p> <p>In the settings 1...99 % for the forced position or emergency operation value, the device carries out PWM at the valve output after an ETS programming operation until a new command value or another function is specified or activated. In this case, the PWM is also executed after an ETS programming operation, if the command value is configured to "switching (1-bit).</p>
<p><input type="checkbox"/> Output 2 - Times</p>	
<p>Cycle time (PWM of the valve output) Minutes (0...20)</p>	<p>0...15...20</p> <p>The cycle time specifies the switching frequency of a pulse width modulated output signal. The variable adjustment option of the cycle time here allows adaptation to the adjusting cycle times (the adjusting time it takes the drive to bring the valve from its completely closed to its completely opened position) of the actuators used. Sets the cycle time minutes.</p>
<p>Seconds (10...59)</p>	<p>10...59</p> <p>Sets the cycle time seconds.</p>
<p>Time for cycl. monitoring of command values Minutes (1...59)</p>	<p>1...30...59</p> <p>The device offers the option of monitoring the command value of the valve output. This monitoring checks whether command value telegrams have been received within the time interval defined here. If there are no telegrams during the monitoring time, the device activates emergency operation and adjusts the connected valve drives to an emergency operation valve position configured in the ETS.</p>
<p><input type="checkbox"/> Output 2 - Command value</p>	
<p>Type of command value</p>	<p>The valve output can be controlled via switching with a 1-bit command value telegram or alternatively constantly with a 1-byte command value telegram. Constant command values are converted via pulse width modulation at the output.</p>
<p>Switching (1 bit)</p>	<p>In normal operation, the switching telegram received via the 1-bit "Command value" object, is directly</p>

		<p>forwarded to the valve output, taking the valve direction of action (deenergised open / deenergised closed) into account. This means that, if an "ON" telegram is received, the valve is completely opened (output energised on valve direction of action = closed / output deenergised on valve direction of action = opened). If an "OFF" telegram is received, the valve is completely closed (output deenergised on valve direction of action = closed / output energised on valve direction of action = opened).</p>
	<p>Constant (1 byte)</p>	<p>In normal operation, the value telegram received via the 1-byte "Command value" object is converted into an equivalent pulse width modulated switching signal at the valve output. Taking the cycle time set in the device into account, the average output signal resulting from this modulation is a measure of the centred valve position of the control valve and thus a reference for the set room temperature.</p>
<p>Cyclical monitoring of the command value</p>	<p>disabled</p> <p>Enabled</p>	<p>The device offers the option of monitoring the command value of the valve output. This monitoring checks whether command value telegrams have been received within a time interval that can be defined in the ETS. If there are no telegrams during the monitoring time, the device activates emergency operation and adjusts the connected valve drives to an emergency operation valve position configured in the ETS.</p> <p>The cyclical command value monitoring is enabled and the communication object "Command value monitoring alarm" becomes visible in the ETS. In fault-free operation, the command value object of the valve output must have telegrams transmitted to it cyclically during the monitoring time.</p> <p>The cyclical monitoring is completely disabled. No telegram monitoring of the command value object is performed.</p>
<p>Polarity of "Command value monitoring alarm" object</p>	<p>Object value when command values absent = 0</p> <p>Object value when command values absent = 1</p>	<p>The telegram polarity of the 1-bit "Command value monitoring alarm" object can be set here. This parameter is only visible with enabled cyclical command value monitoring.</p>
<p>Command value limit</p>		

	disabled	<p>If the valve output is controlled using 1-byte constant command value telegrams, a command value limit can optionally be configured here. The command value limit allows the restriction of command values specified via the bus to the range limits "minimum" and "maximum". The limits are permanently set in the ETS and, if command value limitation is active, can be neither undershot or exceeded during device operation.</p>
	Enabled	
Activation of the command value limit		<p>The command value limit can either be activated or deactivated using a separate 1-bit communication object or be permanently active. The activation property is configured here.</p>
	By object	<p>The 1-bit object "Command value limit" becomes visible in the ETS. The telegram polarity of this object is fixed: "0" = command value limit inactive / "1" = command value limit active. As soon as a "1" telegram is received via the object, the device activates the command value limit for the valve output. Only a "0" telegram removes the limit for command value telegrams or valve setpoint position values for emergency operation.</p>
	Permanent	<p>The command value limit is always active and cannot be deactivated. There is no separate communication object available. Only a forced position of the valve output can by-pass the command value limit in normal device operation.</p>
Minimum command value	0 %...50 % (in 5 % increments)	<p>As soon as the command value limit is active, command values received via the bus and valve setpoint positions specified by emergency operation (cyclical command value monitoring) are limited. The command value to be limited in a downwards direction must be defined as a minimum command value limit value by this parameter. With an active command value limit, the set minimum command value is not undershot by command values from the bus or emergency operation. Should the named functions specify smaller command values, the device sets the minimum command value at the valve output and signals this value, including the status, to the bus (if the status message is enabled).</p>

Maximum command value	55 %... 100 % (in 5 % increments)	<p>As soon as the command value limit is active, command values received via the bus and valve setpoint positions specified by emergency operation (cyclical command value monitoring) are limited. The command value to be limited in an upwards direction must be defined as a maximum command value limit value by this parameter.</p> <p>With an active command value limit, the set maximum command value is not exceeded by command values from the bus or emergency operation. Should the named functions specify larger command values, the device sets the maximum command value at the valve output and signals this value, including the status, to the bus (if the status message is enabled).</p>
Command value limit after bus voltage return	Deactivated Activated	<p>If the command value limit is to be activated or deactivated via the object, the initialisation of the object after a device reset (bus voltage return or ETS programming operation) can be specified here.</p> <p>With a permanently active command value limit, the initialisation behaviour cannot be configured separately after a device reset, as the limit is always active. In this case, the parameter is permanently preset to "activated".</p>
<input type="checkbox"/> Output 2 - Status Transmit status of the valve position?	<p>No status</p> <p>Status object is actively transmitting</p> <p>Status object is passively readable</p>	<p>The device makes a command value status message available to the valve output. In so doing, the current valve setpoint position can be transmitted to the bus via the communication object "Command value status" according to the projected command value data format (1-bit or 1-byte).</p> <p>The communication object is hidden in the ETS meaning that the status message is completely inactive.</p> <p>The status message is enabled. As soon as the device updates the status message, a telegram is also actively transmitted to the bus. In the ETS the "Transmit" flag is set automatically on the status object.</p> <p>The status message is enabled. The device updates only the status object internally, and does not transmit any telegram. The object value can be read out via the bus at any time (ValueRead), as a result of which the device then</p>

		transmits a response telegram (ValueResponse). In the ETS the "Read" flag is set automatically on the status object.
Time delay for status after bus voltage return ?	Yes No	It is possible to set a time delay for the actively transmitting status messages after bus voltage return (switching on of the bus voltage), and also after ETS programming. For this purpose a delay time can be defined in the device. Only after the configured time elapses are status telegrams for initialisation transmitted to the bus. Whether the status message is transmitted with a time delay after initialisation can be configured here. The delay time itself is configured independent of the channel on the parameter page "General". This parameter is only visible in "Transmit status of the valve position?" = "Status object is actively transmitting".
Status object "Valve closed"	disabled Enabled	The device can transmit the information to the bus using a 1-bit status telegram, that the valve is closed, i.e. no heating or cooling energy is required via the command value. The status message can be enabled here.
Polarity object "Valve closed"	Object value on "Valve closed" = 0 Object value on "Valve closed" = 1	The telegram polarity of the 1-bit "Valve closed" communication object can be set here. This parameter is only visible if the status object "Valve closed" is enabled.
Alarm object for overload / short-circuit	disabled Enabled	The device monitors the valve output for short-circuits and overloads as soon as the output is switched on and energised. Short-circuit and overload detection is always active. Optionally, a 1-bit alarm object can be enabled here, allowing the signalling of fault operation due to a short-circuit or overload in the bus.
Polarity of "Short-circuit / overload alarm" object	Object value on overload / short-circuit = 0 Object value on overload / short-circuit = 1	The telegram polarity of the 1-bit "Short-circuit / overload alarm" object can be set here. This parameter is only visible when the short-circuit / overload message is enabled.

Time delay for message
after bus voltage
return ?

Yes

No

After bus voltage return, any alarm message transmitted before the bus voltage failure is always withdrawn (no alarm). Even if no alarm message was active before the bus failure, a message telegram (no alarm) is transmitted to bus for initialisation after bus voltage return or an ETS programming operation. In these cases, the transmission of the alarm telegram may take place after a delay.
The time delay is configured here.
This parameter is only visible when the short-circuit / overload message is enabled.

5 Appendix

5.1 Index

A	
Anti-sticking protection.....	105
application program.....	18
Automatic heating/cooling.....	86
B	
blind height.....	47
bus voltage failure.....	40, 105
bus voltage return.....	40, 106
C	
Command value evaluation.....	109
Command value limit.....	118
command value monitoring.....	116
Commissioning.....	11
communication objects.....	19
Computing.....	47
cycle time.....	114
D	
Delay after bus voltage return.....	30-31
Delivery state.....	128
Device components.....	5
Dimming function.....	33
direct operation.....	43, 51
disabling function.....	39
drive movement.....	54
E	
effect.....	32
Effect.....	29
ETS programming.....	40, 107
ETS search paths.....	15
extended sun protection.....	63
F	
Fabric-stretching function.....	98
Forced position function.....	102
functionalities.....	3
L	
Light scene function.....	92
limit values.....	119
long time operation.....	43
louver position.....	47
M	
Maximum command value.....	119
Measuring the slat moving time.....	11
Measuring the travelling time extension ..	10
Measuring the travelling times.....	10
Minimum command value.....	119
movement time extension.....	45
O	
operating mode.....	40
Operating mode.....	40
Operating switchover.....	103
P	
Performing a reference movement (optional) ..	11
Position feedback messages.....	52
Presetting the position.....	51
priority.....	127
Pulse width modulation.....	110
R	
Reference movement.....	50
S	
Safe-state mode.....	18
Safety function.....	57
Short time operation.....	43
Simple sun protection.....	62
slat moving time.....	44
Slat offset.....	77
slat position.....	48
Status message.....	121-122
Sun protection application examples.....	81
Sun protection function.....	61
Switching function.....	32
switchover time.....	45
T	
Telegram rate limit.....	30
U	
Unknown position.....	54
Unloading the application program.....	18
V	
Value transmitter function.....	36
Valve direction of action.....	100
Venetian blind function.....	34