

Synco™

KNX S-mode data points



Synco 700 devices RM_7xx, RM_7xxB, OZW77x, QAW740

Synco living central apartment units QAX9xx

Synco Room thermostats RD...

Engineering

Siemens Switzerland Ltd
Infrastructure & Cities Sector
Building Technologies Division
Gubelstrasse 22
CH-6301 Zug
Tel. +41 41-724 24 24
<http://www.siemens.com/sbt>

© 2004-2013 Siemens Switzerland Ltd
Subject to change

Table of contents

1	Introduction.....	7
1.1	Notes on this document.....	7
1.1.1	Terms and abbreviations.....	8
1.1.2	Synco devices with S-mode data points.....	8
1.2	KNX network.....	9
1.2.1	Complete KNX network.....	9
1.2.2	Network address.....	10
1.2.3	Device address.....	10
1.3	Group addresses, data point inputs/outputs.....	11
1.3.1	Group addresses for system time, fault information.....	12
1.3.2	Data point inputs / outputs.....	12
1.4	Data point description information.....	14
1.4.1	Communication flags.....	14
1.4.2	Data point formats.....	15
1.4.3	Referenced KNX manuals.....	15
1.5	Parameterization in ETS.....	17
1.5.1	Notes for parameterization.....	18
1.5.2	Workflow for parameterization.....	19
1.5.3	Parameterize terminals, inputs and outputs.....	21
2	RMU7x0, RMU7x0B, RMU7x0B Step 3 Universal controllers.....	23
2.1	Overview.....	23
2.1.1	RMU7x0 Universal controllers.....	23
2.1.2	RMU7x0B, RMU7x0 Step 3 Universal controllers.....	24
2.2	RMU7x0, S-mode data points.....	25
2.3	RMU7x0B, S-mode data points.....	29
2.4	RMU7x0B Step 3, S-mode data points.....	38
2.4.1	Basic type A, Ventilation controller.....	38
2.4.2	Basic type P, Primary air handling.....	44
2.4.3	Basic type C, Chilled water precontrol.....	48
2.4.4	Basic type U, Universal controller.....	52
2.4.5	Terminal inputs RMU7x0B Step 3 as reception objects.....	57
2.4.6	Terminal inputs RMU7x0B Step 3 as transmission objects.....	58
2.4.7	Terminal outputs RMU7x0B Step 3 as transmission objects.....	59
2.4.8	Terminal inputs as reception objects, Extension modules RMZ78x.....	60
2.4.9	Terminal inputs as transmission objects, Extension modules RMZ78x.....	61
2.4.10	Terminal outputs as transmission objects, Extension modules RMZ78x.....	62
3	RMH760, RMH760B Heating controller.....	63
3.1	Overview.....	63

3.1.1	RMH760 Heating controller.....	63
3.1.2	RMH760B Heating controller	64
3.2	RMH760, S-mode data points.....	66
3.3	RMH760B, S-mode data points	72
4	RMK770, RMK770 V2.0 Boiler sequence controller	83
4.1	Overview	83
4.2	RMK770, S-mode data points.....	84
4.3	RMK770 V2.0, S-mode data points	89
5	RMB795, RMB795B Central control unit	97
5.1	Overview	97
5.2	RMB795, S-mode data points.....	99
5.3	RMB795B, S-mode data points	106
5.3.1	Terminal inputs as reception objects, RMB795B	110
5.3.2	Terminal inputs as transmission (send) objects, RMB795B	111
5.3.3	Terminal outputs as transmission (send) objects, RMB795B	112
5.3.4	Terminal inputs as reception objects, Extension modules RMZ78x	113
5.3.5	Terminal inputs as transm. (send) objects, Extension modules RMZ78x....	114
5.3.6	Terminal outputs as transm. (send) objects, Extension modules RMZ78x..	115
6	RMS705, RMS705B switching and monitoring device.....	117
6.1	Overview	117
6.2	RMS705, S-mode data points.....	119
6.3	RMS705B, S-mode data points	126
6.3.1	Terminal inputs and outputs as reception or transmission objects	132
7	RMZ792, RMZ792B Bus operator units.....	137
7.1	Overview	137
7.2	RMZ792, RMZ792B, S-mode data points.....	138
8	OZW771 Central communication unit.....	141
8.1	Overview	141
8.2	OZW771, S-mode data points	142
9	OZW775 Central communication unit.....	145
9.1	Overview	145
9.2	OZW775, S-mode data points	146
10	OZW772 Web server	149
10.1	Overview	149
10.2	OZW772, S-mode data points	150
11	QAW740 Room unit.....	153

11.1	Overview.....	153
11.2	QAW740, S-mode data points.....	154
12	RDF301, RDF301.50, RDF600KN Room thermostats.....	155
12.1	Overview.....	155
12.2	RDF301, RDF301.50, RDF600KN, S-mode data points.....	156
13	RDU341 Room thermostat.....	165
13.1	Overview.....	165
13.2	RDU341, S-mode data points.....	166
14	RDG100KN, RDG160KN Room thermostats.....	173
14.1	Overview.....	173
14.2	RDG100KN, RDG160KN, S-mode data points.....	174
15	RDG400KN Room thermostat.....	181
15.1	Overview.....	181
15.2	RDG400KN, S-mode data points.....	182
16	QAX910 Central apartment unit.....	189
16.1	Overview.....	189
16.1.1	Parameterizing QAX910 series A, B and C.....	190
16.2	QAX910, S-mode data points.....	199
17	QAX903, QAX913 Central apartment units.....	211
17.1	Overview.....	211
17.1.1	Parameterizing QAX9x3.....	212
17.2	QAX903, QAX913, S-mode data points.....	220
18	Index.....	233

Blank page

1 Introduction

1.1 Notes on this document

About this document

The information in this document requires the following in-depth knowledge:

- Functionality and communications of Synco devices and KNX third-party devices.
- KNX technology and handling the engineering tool software ETS.
- Engineering and commissioning KNX networks using Synco devices.

Target audience

This document is intended for persons planning/engineering and commissioning KNX networks using Synco devices.

Edition 8.0

The edition 8.0 contains additional S-mode data points for the Synco RMU7x0B Step 3 controllers, Synco living central apartment units QAX903, QAX913 as well as Synco room thermostats RDG100KN and RDG400KN compared to edition 7.0 (April 8, 2010).

Synco and KNX

Synco uses KNX TP1 (Twisted Pair) as transmission medium. The Synco devices intercommunicate in LTE mode. The Synco LTE mode data points are connected via zone addresses (see document P3127).

S-mode data points

The KNX S-mode data points in the Synco devices represent a subset of the Synco LTE mode data points. The KNX S-mode data points are required to exchange process values between Synco devices and e.g. KNX third-party devices, i.e. if the third-party devices can communicate in S-mode only.

The term "data point" is intrinsic to KNX (see KNX standard, Volume 3: System Specifications, Part: 7: Interworking, Chapter 2: Data Point Types).

The title of this document, "KNX S-mode data points" is derived from the following:

- Transmission medium TP1 → KNX (KNX bus, Twisted Pair).
- Communication mode → S-mode.
- Communication objects → Data points.

Engineering tool software ETS

You can order the **Engineering Tool Software** (ETS Professional) from the KNX Association at <http://www.knx.org/>.

Product data, import files

The product data for the devices are contained in **import-File *.vd5**. Import file *.vd5 requires tool version **ETS3.0f** or **ETS4**.

The product data for just **ETS4** are contained in **Import-File *.knxprod**.

Both import files can be downloaded from Siemens Building Technologies.

Note on EIB

The **European Installation Bus** (EIB) employs TP1 as transmission medium (same as KNX) and communicates via EIB communication objects, or group objects, in S-mode.

In EIB, the term "data point" (common term in building automation and control) is largely unknown. The following convention applies to this document: One S-mode data point corresponds to one communication object or group object.

1.1.1 Terms and abbreviations

Data point type

The data point type (DPT) determines how compatible the devices are. The format and number of bits, bit coding, value range and, where required, the unit (°C, %, m³/h, etc.) are specified in each data point type.

S-mode

S-mode stands for system mode. This mode primarily is characterized by the assignment of (logical) group addresses to S-mode data points to communicate process values.

S-mode data points

Short: S-mode DP

Synco 700 devices provide selected data points in S-mode for control and measuring tasks in HVAC plants and individual rooms, for lighting and security plants, and for integration in higher building automation and control systems.

S-mode data points and EIB communication objects can exchange process values, if both data point type and group address match.

Abbreviations

Abbreviation	Meaning
DP	Data point (or EIB communication object)
DPT	Data point type
E-mode	Easy mode (LTE is one of several Easy modes)
EIB	European Installation Bus (also called Instabus)
ETS	Engineering Tool Software
LTE mode	Logical Tag Extended Mode (Easy mode used in Synco)
KNX	Konnex
S-mode	System mode (communication mode in KNX networks)

1.1.2 Synco devices with S-mode data points

Type / ASN	Designation	Section
RMU7x0, RMU7x0B, RMU7x0B Step 3	Universal controller	2
RMH760, RMH760B	Heating controller	3
RMK770	Boiler sequence controller	4
RMB795, RMB795B	Central control unit	5
RMS705, RMS705B	Switching and monitoring device	6
RMZ792, RMZ792B	Bus operator unit	7
OZW771	Central communication unit	8
OZW775	Central communication unit	9
OZW772 V2.0, OZW772 V3.0	Web server	10
QAW740	Room unit	11
RDF301, RDF301.50, RDF600KN	Room thermostat	12
RDU341	Room thermostat	13
RDG100KN, RDG160KN	Room hermostat	14
RDG400KN	Room thermostat	15
QAX910, Serie A, B, C	Central apartment unit (Synco living)	16
QAX903, QAX913	Central apartment unit (Synco living)	17

Room controllers RXB/RXL

This document does not describe S-mode data points of RXB.../RXL... room controllers (RXB... see data sheets N3873, N3874, N3875, RXL... see N3876, N3877, N3878).

1.2 KNX network

1.2.1 Complete KNX network

KNX network, three tiers

A complete KNX network comprises three tiers. It comprises:

- Area line 0 → Area 0 (backbone)
- Main lines 1...15 → Areas 1...15
- Lines 1.1...15.15

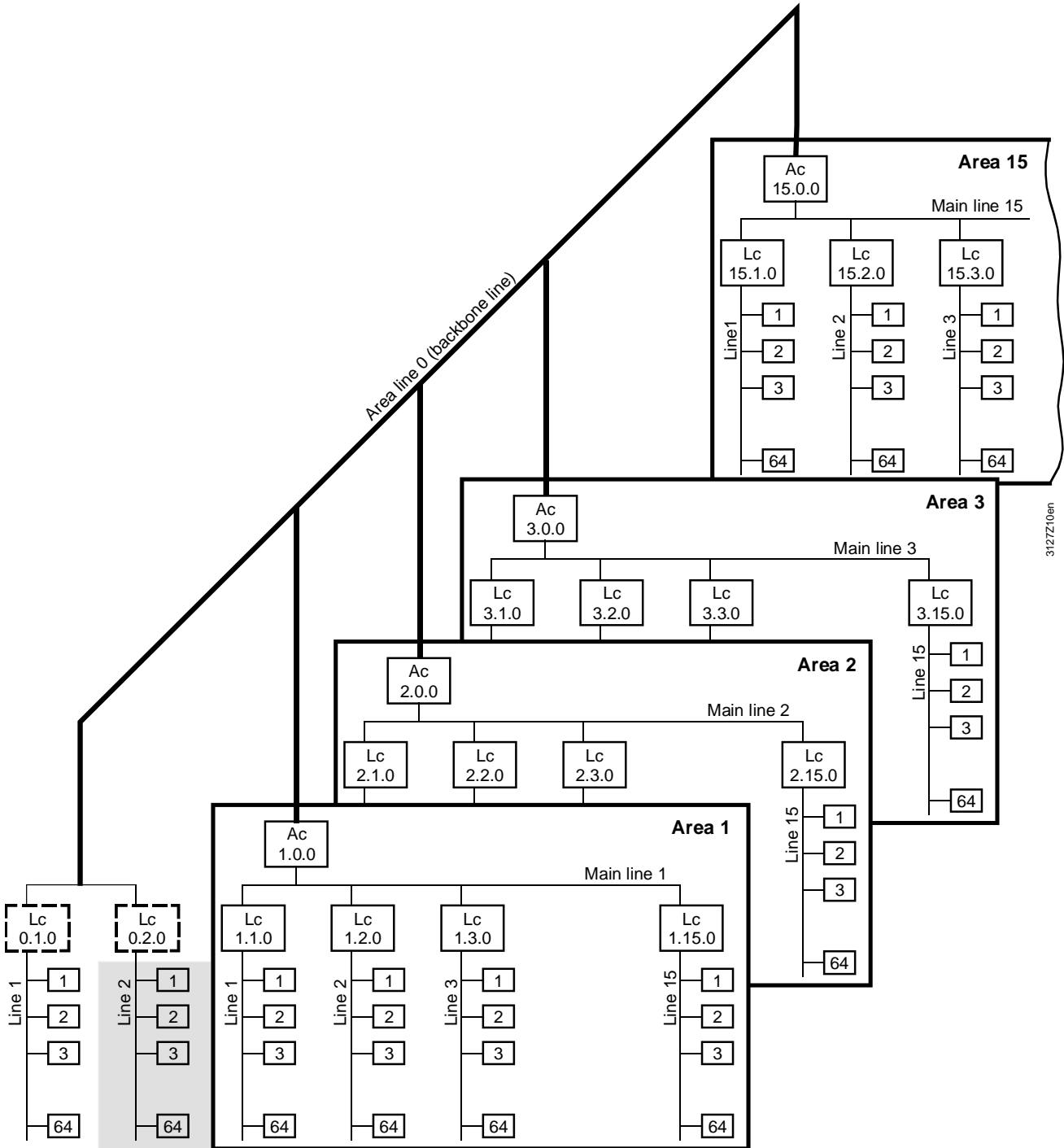

Note

In the above illustration, the device arrangement on the three-tier KNX network, with factory-set area/line address 0.2 on the Synco devices, corresponds to the highlighted area.

1.2.2 Network address

In a complete KNX network, the network address consists of area, line and device address. The address reflects the unambiguous position of a device on the network and is unique.

Network address syntax

A.L.D Area.Line.Device (with dot as separator ".")

Area	0	Area line 0
Area	1...15	Main lines 1...15
Line	1...15	
Devices	1...254	

Factory-set network address

The factory-set network address for Synco devices is 0.2.255 (exception: Central communication unit OZW775 with 0.2.150).

Area address "0" and line address "2" applies if no area or line couplers are used. Device address 255 must be changed to any value between 1 and 254 to allow the unit to spontaneously send process data via KNX.

Individual address

The individual address comprises the positions of the area, line and device address and corresponds to the above network address.

Subnetwork, subnetwork address

In KNX, a subnetwork is a line. Thus, the subnetwork address comprises address parts "Area" and "Line".

1.2.3 Device address

The device address helps identify a device in a particular area and line (Area 0, Line 2 in the illustration below).

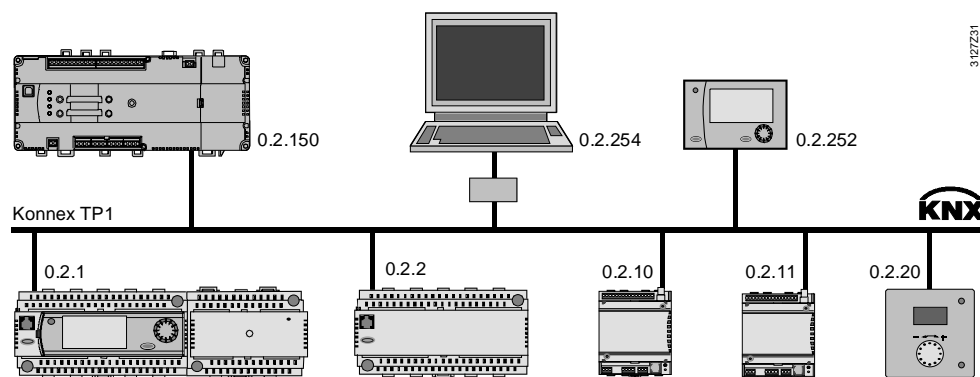

Device addressing

You only need to set the device address in a Synco device. Area and line address 0.2 are preset or are assumed automatically by the area and line coupler (for addressing, see document P3127).

1.3 Group addresses, data point inputs/outputs

The group address is used for S-mode communication. It is function-related address, structured in three levels as per EIB guidelines. You can freely select assignments, but you should not change them within a project.

Group address syntax

H/M/S Main group/medium group/subgroup (with slash as separator " / ")

Main group	0...15	e.g. plant
Medium group	0...7	e.g. function
Subgroup	0...255	e.g. element

Examples for group addresses

The assignments "Plant/function/element" e.g. provide for group addresses:

1/1/11	Heating/Signaling/Boiler
3/2/102	Room/Measuring/Temperature 2
5/4/151	Electro/Switching/Lighting 1

Group addresses

Group addresses allow you to connect EIB communication objects to S-mode data points. You can assign the addresses only via the ETS tool.

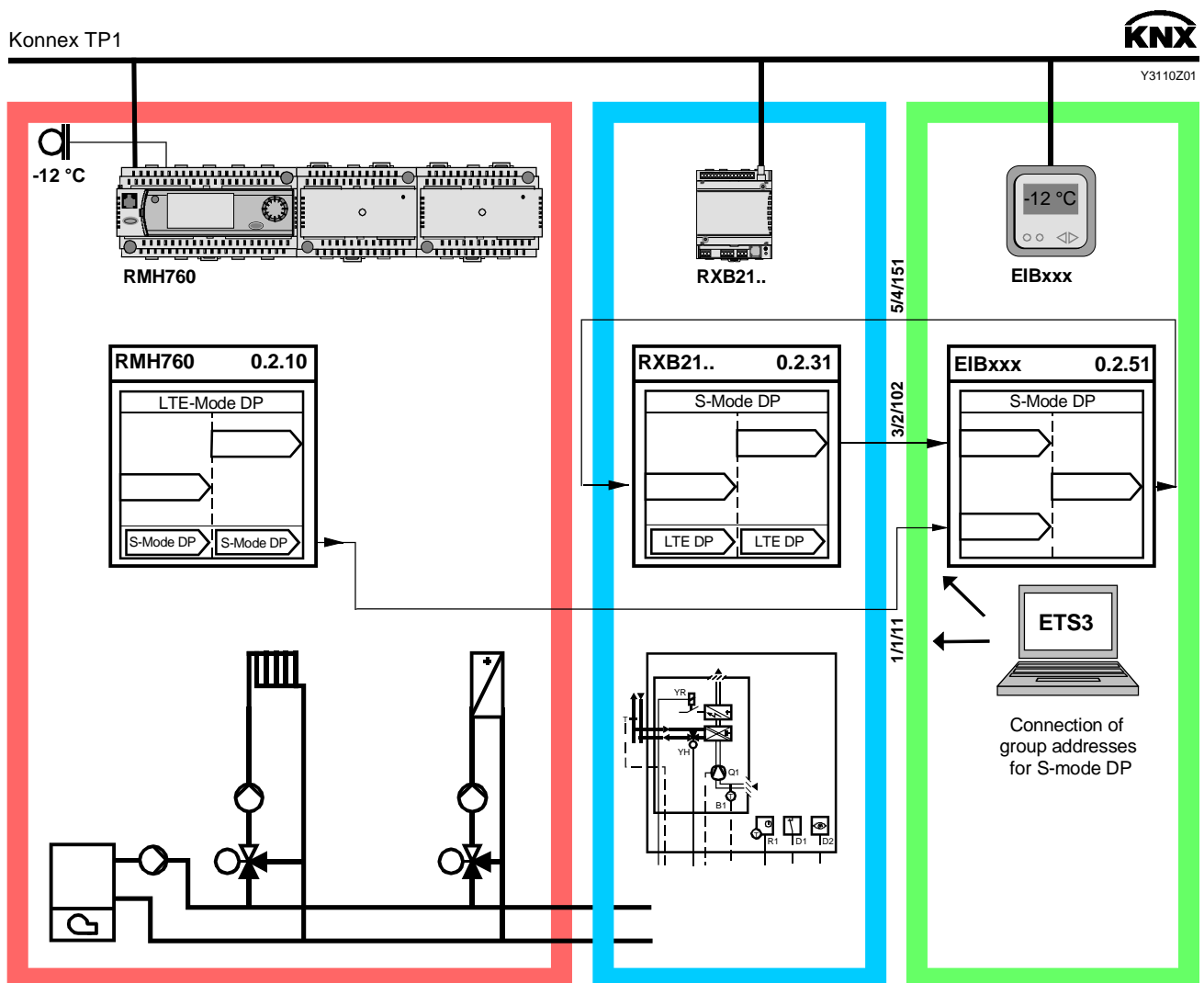

1.3.1 Group addresses for system time, fault information

Fixed group addresses

The KNX standard defines fixed group addresses for some system functions (Functions of Common Interest, FOCl).

In Synco (see screenshot below), this applies to the following data points:

- System time group address 30/3/254
- Fault information group address 30/3/250

Notes

All Synco devices featuring system time come with a preset group address and connected to the respective group object.

When you load new group addresses in Synco bus devices, the above group address 30/3/254 must exist and be connected in ETS. Only then can you begin download.

If group address 30/3/254 and the system time connection is not generated, time synchronization between the Synco bus devices will cease to function following initial download.

If you use another group address for system time, you must enter and load that group in all devices featuring system time (master and all slaves).

You cannot create the group address 30/3/254 (main group 30) in ETS via the standard settings. However, you can activate Windows registry entries to create main groups >15. Contact your supplier of ETS on the type of entry required.

1.3.2 Data point inputs / outputs

In Synco devices, S-mode data points are configured as input, output, input/output (or), or input and output respectively (see screenshot).

Number	Name	Object Function	Desc...
0	System time	Input / Output	
1	Date	Input / Output	
2	Time of day	Input / Output	
3	Fault information	Output	
4	Confirm faults	Input	
5	Reset faults	Input	
6	Fault state (normal/faulty)	Output	
7	Fault transmission (enable/disable)	Input	
10	Timer button	Input (Trigger)	
11	Comfort button	Input (Trigger)	
12	Room optg mode: Preselection	Input and Output	
15	Room optg mode: State	Output	
18	Room temperature: Setpoint relative	Input	
20	[Controller 1] Economy heating setpoint	Input and Output	
21	[Controller 1] Precomfort heating setpoint	Input and Output	
22	[Controller 1] Comfort heating setpoint	Input and Output	
23	[Controller 1] Comfort cooling setpoint	Input and Output	
24	[Controller 1] Precomfort cooling setpoint	Input and Output	
25	[Controller 1] Economy cooling setpoint	Input and Output	
27	[Controller 1] Current cooling setpoint supply air	Output	
28	[Controller 1] Current heating setpoint supply air	Output	

S-mode DP object function

The object function of the S-mode DP as input, output, input/output, or input and output is displayed in the "Object Function" column.

Below is an example for each object function (see the above screenshot for the DP number).

Input, I

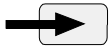

S-mode DP "Room temperature: Setpoint relative" (DP number 18).

→ Input → The Synco device receives "Setpoint relative", i.e. the correction of the room temperature in S-mode from a third-party device.

Output, O



S-mode DP "Room optg mode: State" (DP number 15).

Output → The Synco device sends the stat of the current operating mode in S-mode to one or multiple third-party devices.

Input / Output,
I / O



S-mode DP "Time of day" (DP number 2).

The S-mode DP is connected to an input or an output. The following applies:

→ Input → The Synco device is the clock time **slave** and receives the time of day in S-mode from a third-party clock time master.

or

Output → The Synco device is the clock time **master** and sends the time of day in S-mode to one or multiple clock time slaves.

Note

The basic setting "Rem set clock slave = Yes" in a Synco device does not apply to the S-mode DP inputs / outputs.

Input and Output,
I and O



S-mode DP "[Controller 1] Comfort heating setpoint" (DP number 22).

The S-mode DP is connected to an input and an output. The following applies:

→ Input → The Synco device receives the setpoint (e.g. external setpoint setting).

and

Output → The Synco device sends the setpoint (e.g. to other third-party devices).

Other examples

Parameterization with
send or receive

You can configure some S-mode DPs as output or input (e.g. S-mode DP "Outside temperature") as per the parameterization for send and receive.

Send → Output → Outside sensor is connected to the Synco device terminals and the Synco device sends the outside temperature in S-mode via KNX.

or

Receive → Input → The Synco device receives via KNX the outside temperature in S-mode from a third-party sensor.

Note

There are two cases to parameterize send or receive:

- S-mode DPs that change DP number x (Send, Output) to DP number y (Receive, Input) as per the parameterization.
- S-mode DPs that retain DP number x and only change to Input or Output in column "Object Function".

1.4 Data point description information

1.4.1 Communication flags

Meaning of communication flags

Meaning and action of the communication flags C, R, W, T, and U is explained in the following table. The order for C, R, W, T, and U corresponds to the default setting in the ETS tool.

Flags	Bit	Meaning
C = Communication	0	Data point value is not communicated.
	1	Data point is connected to the bus and the data point value is communicated. C = 1, default for inputs and outputs.
R = Read	0	Data point value cannot be read.
	1	With a read command, the device send its data point value.
W = Write	0	Data point value cannot be written.
	1	The device receives and overwrites its data point value. W = 1, default for inputs.
T = Transmission	0	Data point value is not transmitted.
	1	For COV, Event or Heartbeat, the device sends its data point value. T = 1, default for outputs.
U = Update	0	Data point value is not updated.
	1	The data point value is updated if flag W = 1 (and / or R = 1). U = 1, default for inputs.

Flags for inputs, receive values

The communication flags must be set as follows (default) for data point inputs (receive values):

Flags ⁽¹⁾					Data point type KNX		Value range ⁽²⁾	Receive value ⁽³⁾
C	R	W	T	U	ID	DPT_Name		
1	0	1	0	1	9.001	_Value_Temp	-273.00...+670760.00 Floating point	From KNX devices without/with timeout monitoring.

Flags for outputs, send values

The communication flags must be set as follows (default) for data point outputs (send values):

Flags ⁽¹⁾					Data point type KNX		Value range ⁽²⁾	Send value ⁽⁴⁾
C	R	W	T	U	ID	DPT_Name		
1	0	0	1	0	9.001	_Value_Temp	-273.00...+670760.00 Floating point	COV, Event, Heartbeat

- (1) Flags for data communication with setting values 0 or 1.
- (2) Data point value range.
- (3) Synco devices receive the values from third-party devices without/with timeout monitoring of the received values.
- (4) Synco devices send date and time values cyclically every 10 minutes.
 - Synco devices send analog process values after COV (change of value) and after heartbeat (e.g. every 15 min).
 - Synco devices send digital process values after an event, e.g. contact state change and after heartbeat (e.g. every 30 min).

1.4.2 Data point formats

The data point formats in this document are:

Format	Meaning	Comment
B	Boolean / bitset	
F	Floating point value	
N	eNumeration	
U	Unsigned value	Value without preceding sign

Example

F₁₆ means "Floating point 16 bit" coded, e.g. for value range: -670760.00...+670760.00.

1.4.3 Referenced KNX manuals

This document's information on KNX S-mode data points is based on the following manuals (English only):

- KNX, Volume 3: System Specifications, Part 7, Chapter 2: Data Point Types
- Supplement 11: HVAC Data Point Types on KNX, Volume 3: System Specifications, Part 7, Chapter 2: Data Point Types

Complex S-mode data points

This document does not fully describe the complex S-mode data points. For these data points, we refer to the following manuals and information.

DPT_DateTime ,
ID 19.001

¹⁾ Referenced manual:

KNX, Volume 3: System Specifications, Supplement 14: DateTime

KNX data point type	Value range
DPT_DateTime 19.001	1900...2155 = Year 0...23 = Hours 1...12 = Month 0...59 = Minutes 1...31 = Day of month 0...59 = Seconds 1...7 = Day of week Monday - Sunday Status bits (see table below)

Status bits

Synco devices evaluate the status bits 1, 4, 5, 6 and 7.

Status bit	Bit abbr.	Bit status = 0	Bit status = 1
1	F	Normal (no fault)	Fault
2	WD	Workday no (holiday)	Workday
3	NWD	Field "Workday" valid	Field "Workday" invalid
4	NY	Field "Year" valid	Field "Year" invalid
5	ND	Fields "Month" and "Day of month" valid	Fields "Month" and "Day of month" invalid
6	NDoW	Field "Day of week" valid	Field "Day of week" invalid
7	NT	Fields "Hours", "Minutes" and "Seconds" valid	Fields "Hours", "Minutes" and "Seconds" invalid
8	SUTI	Time of day = Universal time+X	Time of day = Universal time+X+1
9	CLQ	Clock without external time synchronization	Clock with external time synchronization

DPT_AlarmInfo ,
ID 219.001

2) Referenced manual:
KNX, Application Note No 027/03, pages 21 to 24.

KNX data point type	Value range
DPT_AlarmInfo	[0]...255 = Log number
ID 219.001	[0...2]...255 = Alarm priority
	[0...14]...255 = Application area
	[0...4]...255 = Error class
	[0...15]...63 = Alarm attributes
	[0...7] = Fault state

Log number: Always 0 for Synco devices.
Alarm priority: 0 = High, 1 = Medium, 2 = Low.
Application area: 0 = No error, 1 = System and functions (general errors),
2...9 reserved, 10 = HVAC function blocks, 11 = DHW,
12 = HVAC electrical heating, 13 = Room controllers (terminal units),
14 = Ventilation and air handling.
Error classes: 0 = No error, 1 = Device error (RAM, EEPROM, Watchdog, ...),
2 = Communication error, 3 = Configuration error, 4 = HW error.
Fault state: 0 = No fault, 1 = Fault, 2 = Fault unacknowledged, (3 = Fault + fault
unacknowledged), 4 = Interlocking fault.

DPT_Trigger , ID 1.017

3) Referenced manual:
KNX, Volume 7: Application Descriptions, Part:10: General Functional Blocks,
Chapter 4: Common Functional Blocks.

Note the differing functionality of the inputs "Timer button" and "Comfort button" for data point DPT_Trigger.

• **Timer button:**

The trigger signal from the timer button extends Comfort mode by the time set in the Synco 700 controller (default setting = 60 minutes).

Note: With Synco 700 controllers, you can set an extended time of 0...720 minutes (in 15-minute increments) via the RMZ790 and RM791 operator units. Menu e.g. for RMH:

Main menu > Settings > Heating circuit 1 > Space heating > Timer function.

• **Comfort button:**

The first trigger signal of the Comfort button changes over the operating mode from:

- Economy → Comfort
- Precomfort → Comfort
- Comfort → Precomfort

Notes: The second trigger signal from the Comfort button results in a changeover to the previous operating mode, e.g. from Comfort → Economy.

In Protection mode (building protection), the first and second trigger signals from the Comfort button do not change over the operating mode.

DPT_Date , ID 11.001

4) The value range for 00...99 = year means:
00 – 89 = 2000 – 2089, 90 – 99 = 1990 – 1999

1.5 Parameterization in ETS

Principal workflow

Below is a description of the principal workflow for parameterization in the ETS tool (screenshots ETS3). In this case, the RMU730B universal controller represents the Synco device to be parameterized. Thus, the screenshots refer to this controller.

Note

Procedures in ETS4 are the same as in ETS3, only the user interface is different.

Steps

1. Determine the configuration in the Synco device and then the parameter group(s) and parameters, or the required S-mode data points (short: S-mode DP).
2. Start parameterization in ETS (see 1.5.2).
3. Assign the required parameter value to each parameter (= parameterize) and configure the S-mode DP(s) in ETS.
4. Connect the S-mode DP via group addresses to the communication objects.

The DP in the Synco device and the S-mode are coupled only if the DP is configured in both places. For this reason, start at Step 1.

Terminology

In ETS, we speak of parameterization (= **Edit Parameters...**), parameter groups, parameters, and parameter values.

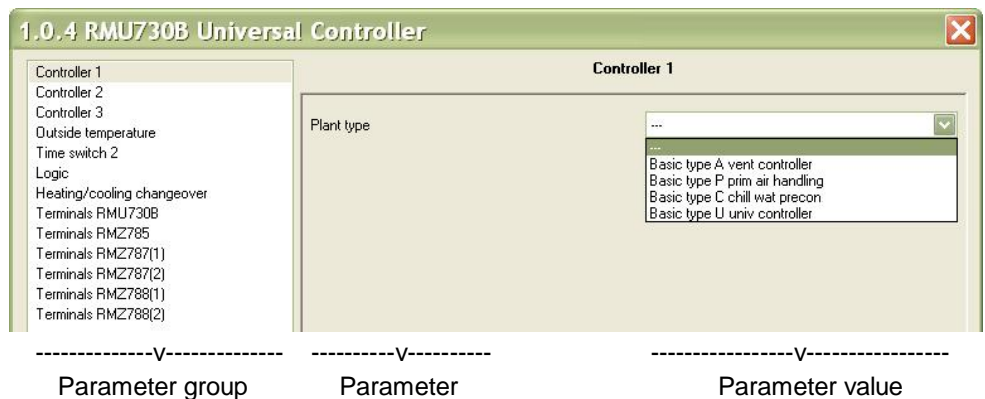

Parameter → S-mode DP

Assigning a parameter value to the parameter configures the S-mode DP. Both parameter and S-mode DP have the same name.

View "All Devices"

The view "All Devices" is set in ETS prior to parameterization.

View > **Project Views...** > **All Devices**

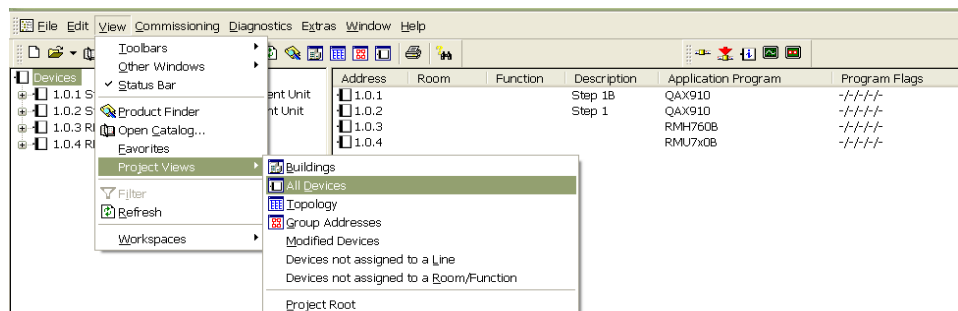

1.5.1 Notes for parameterization

Standard S-mode DP

Click to select the Synco device you want to parameterize. The right pane automatically displays the standard S-mode DP for the selected Synco device.

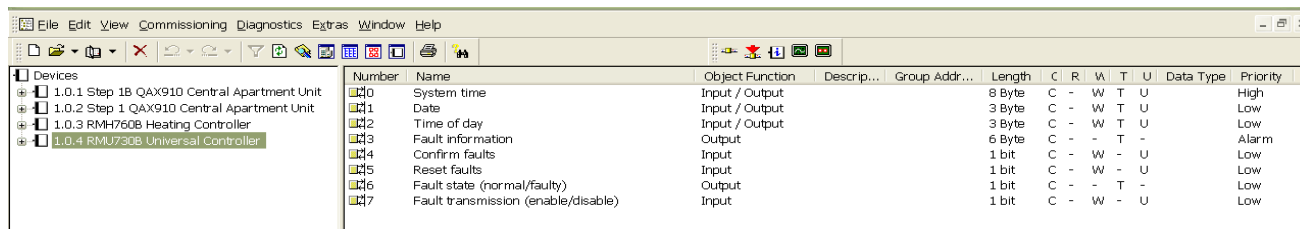

Number	Name	Object Function	Descrip...	Group Addr...	Length	C	R	W	T	U	Data Type	Priority
0	System time	Input / Output			8 Byte	C	-	W	T	U		High
1	Date	Input / Output			3 Byte	C	-	W	T	U		Low
2	Time of day	Input / Output			3 Byte	C	-	W	T	U		Low
3	Fault information	Output			6 Byte	C	-	-	T	-		Alarm
4	Confirm faults	Input			1 bit	C	-	W	-	U		Low
5	Reset faults	Input			1 bit	C	-	W	-	U		Low
6	Fault state (normal/faulty)	Output			1 bit	C	-	-	T	-		Low
7	Fault transmission (enable/disable)	Input			1 bit	C	-	W	-	U		Low

5) Standard S-mode DP

S-mode DPs marked as "Always" in the S-mode DP tables for the devices are standard S-mode DPs that are always configured using tool ETS when the corresponding device is selected.

For the Synco 700 devices RM_7xx, the standard S-mode DPs have numbers 0...7. To some extent, standard S-mode DP in range 0...7 are lacking for the other devices.

Examples:

For room thermostats RDF301... and RDU341, the standard S-mode DPs 2 and 7 are missing and for the Synco 900 Central Apartment Unit QAX910, the standard S-mode DPs 4 and 5 are missing.

Value transmission

6) Out of Service

If the application sets an S-mode DP to "Out of service", the S-mode DP does not send a value (not even "----" for "OSV").

- Value transmission is interrupted and either the value last transmitted or an error message appears on an external display unit, depending on the display unit's timeout response.

If the application then sets the S-mode DP to "In operation", the S-mode DP resumes sending the current value.

DP not parameterized

7) S-mode DP sends 0

If S-mode DPs are parameterized in ETS and connected via group addresses not configured in the Synco device, the S-mode DPs send an invalid value (normally value 0 (zero), possibly with a +/- deviation).

1.5.2 Workflow for parameterization

Start parameterization

Right-click the selected Synco device to open the context menu with menu item **Edit Parameters...**

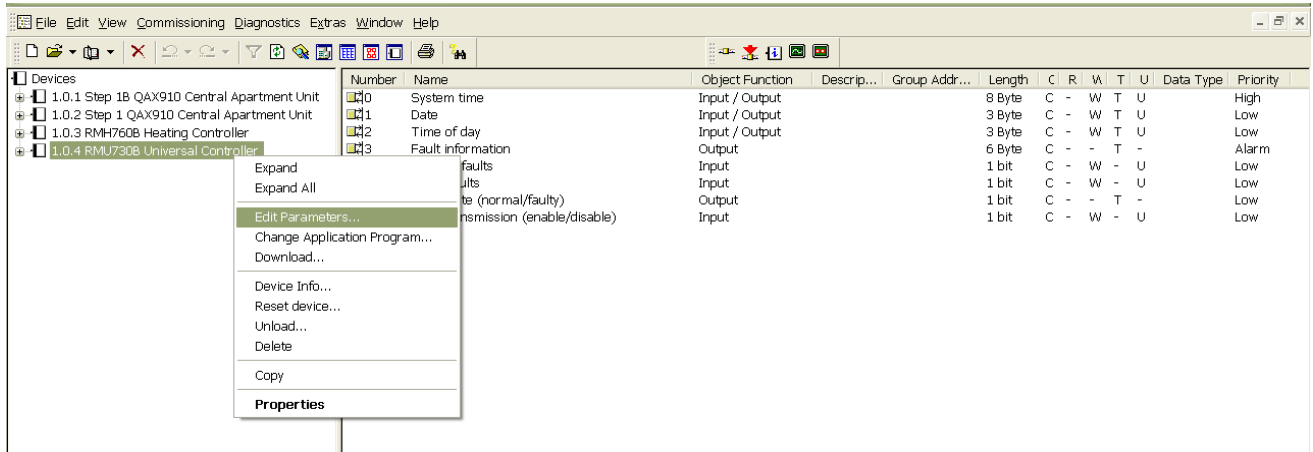

Note

You can also start parameterization by selecting the Edit menu and then **Edit Parameters...**

Edit Parameters

Select **Edit Parameters...** to open the dialog box for the selected Synco device.

The following dialog box is displayed for the RMU730B universal controller:



Assign parameter value

Assigning a parameter value to a parameter configures one S-mode DP or several in ETS.

Select the drop-down list box to display the corresponding parameters (see screenshot for parameter "Plant type").

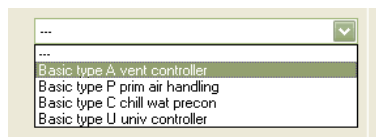

Parameter "Plant type"

The value assignment "Basic type A vent controller" to parameter "Plant type" configures S-mode DPs 10, 11, 12, 15, ..., 30 as well as parameters "Room temperature", "Time switch operation" and "Control strategy".

Number	Name	Object Function	Desc...	Group Addr...	Length	C	R	W	T	U	Data Type	Priority
0	System time	Input / Output			8 Byte	C	-	W	T	U		High
1	Date	Input / Output			3 Byte	C	-	W	T	U		Low
2	Time of day	Input / Output			3 Byte	C	-	W	T	U		Low
3	Fault information	Output			6 Byte	C	-	-	T	-		Alarm
4	Confirm faults	Input			1 bit	C	-	W	-	U		Low
5	Reset faults	Input			1 bit	C	-	W	-	U		Low
6	Fault state (normal/faulty)	Output			1 bit	C	-	-	T	-		Low
7	Fault transmission (enable/disable)	Input			1 bit	C	-	W	-	U		Low
10	Timer button	Input (Trigger)			1 bit	C	-	W	-	U		Low
11	Comfort button	Input (Trigger)			1 bit	C	-	W	-	U		Low
12	Room optg mode: Preselection	Input and Output			1 Byte	C	-	W	T	U		Low
15	Room optg mode: State	Output			1 Byte	C	-	-	T	-		Low
18	Room temperature: Setpoint relative	Input			2 Byte	C	-	W	-	U		Low
20	[Controller 1] Economy heating setpoint	Input and Output			2 Byte	C	R	W	T	U		Low
21	[Controller 1] Precomfort heating setpoint	Input and Output			2 Byte	C	R	W	T	U		Low
22	[Controller 1] Comfort heating setpoint	Input and Output			2 Byte	C	R	W	T	U		Low
23	[Controller 1] Comfort cooling setpoint	Input and Output			2 Byte	C	R	W	T	U		Low
24	[Controller 1] Precomfort cooling setpoint	Input and Output			2 Byte	C	R	W	T	U		Low
25	[Controller 1] Economy cooling setpoint	Input and Output			2 Byte	C	R	W	T	U		Low
27	[Controller 1] Current cooling setpoint supply air	Output			2 Byte	C	-	-	T	-		Low
28	[Controller 1] Current heating setpoint supply air	Output			2 Byte	C	-	-	T	-		Low
29	[Controller 1] Supply air limit max	Input and Output			2 Byte	C	R	W	T	U		Low
30	[Controller 1] Supply air limit min	Input and Output			2 Byte	C	R	W	T	U		Low

Outside temperature

Transmit, S-mode DP 8

Select **Outside temperature** and parameter value **Transmit** to configure S-mode DP 8 Outside temperature as Output.

7	Fault transmission (enable/disable)	Input			1 bit	C	-	W	-	U		Low
8	Outside temperature	Output			2 Byte	C	-	-	T	-		Low

Receive, S-mode DP 9

Select **Outside temperature** and parameter value **Receive** to configure S-mode DP 9 Outside temperature as Input.

7	Fault transmission (enable/disable)	Input			1 bit	C	-	W	-	U		Low
9	Outside temperature	Input			2 Byte	C	-	W	-	U		Low

1.5.3 Parameterize terminals, inputs and outputs

Terminals Inputs and outputs

Click **Terminals RMU730B** to display the Inputs and Outputs for the Synco device (for RMU730B universal controller below).

Click the drop-down list box [v] for either inputs or outputs to display all parameter values (see screenshot below for input N.X1).

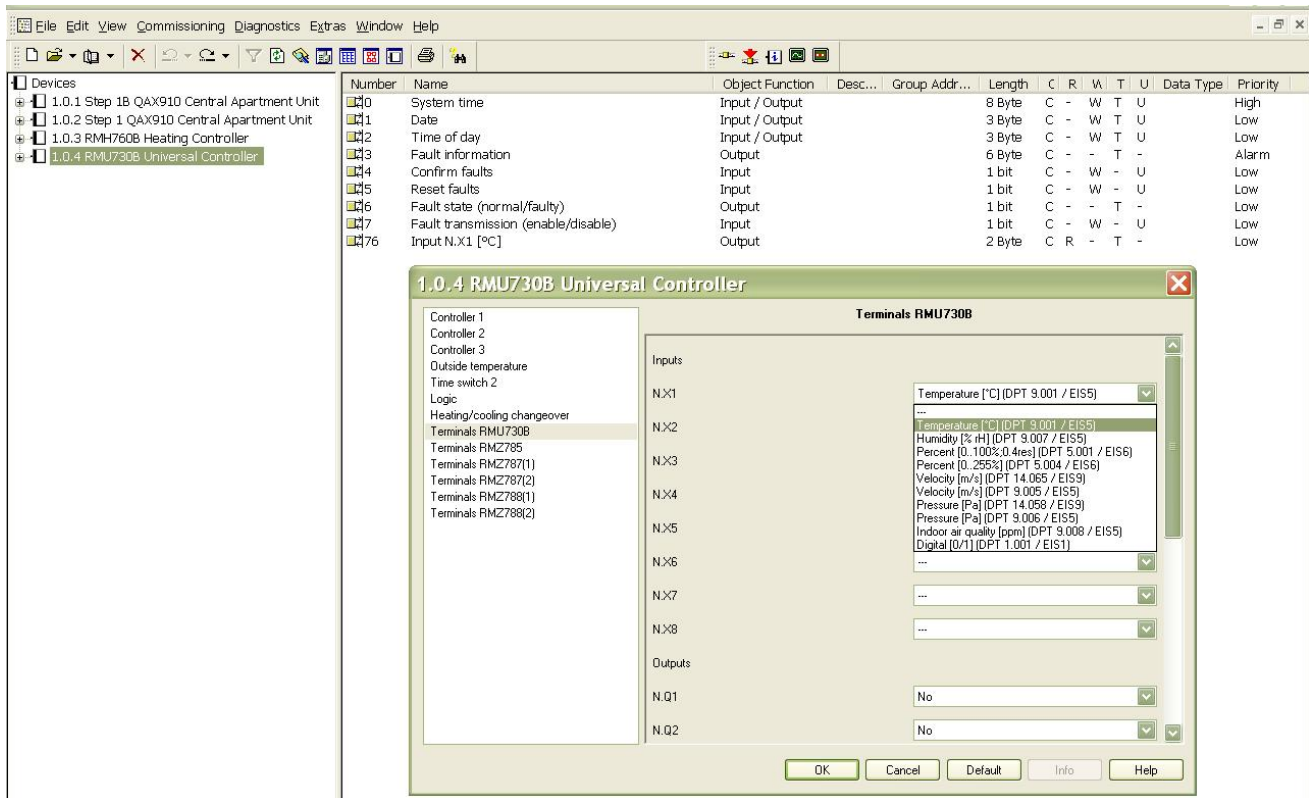

Parameterize inputs N.X_

When you use parameter value **Temperature [°C](DPT 9.001 / EIS5)** to parameterize **Terminals RMU730B > Input N.X1**, S-mode DP 76 is configured with function "Output" (see screenshot below).

Input value N.X1 becomes an output value as S-mode DP that can be used e.g. for value transmission to an display unit.



Notes

When you use parameter value **Humidity [% rH](DPT 9.007 / EIS5)** or another parameter value to parameterize **Terminals RMU730B > Input N.X1**, S-mode DP 76 is configured also.

Thus, the S-mode DP number is retained regardless of parameter value Temperature, Humidity, Percent, etc.

The S-mode DP can only send the value from N.X1 (or N.X2...N.X8), if a sensor is connected to terminal N.X1.

Blank page

2 RMU7x0, RMU7x0B, RMU7x0B Step 3 Universal controllers

2.1 Overview

Brief description

The Synco 700 universal controllers RMU710, RMU720, and RMU730 (short: RMU7x0) are designed for application in ventilation, air conditioning and chilled water plants.

The Synco 700 universal controllers series B, thus RMU710B, RMU720B, RMU730B (short: RMU7x0B) and RMU710B Step 3, RMU720B Step 3, RMU730B Step 3 (short: RMU7x0B Step 3) are designed additionally for application in primary plants together with individual room control. Controllers RMU7x0B Step 3 allow for universal data exchange via their own terminals (universal inputs as reception objects in reception zones and as transmission objects in transmission zones).

The controller types RMU7x0, RMU7x0B and RMU7x0B Step 3 are identical with regard to design and dimensions.

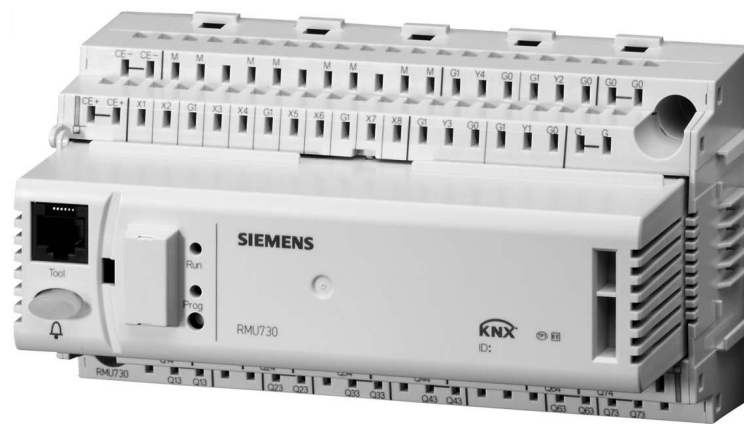

Documentation

Documentation RMU7x0

Data sheet Universal controllers RMU7... **N3144**
 Basic documentation Universal controllers RMU710, RMU720, RMU730 **P3140**

Documentation RMU7x0B, RMU7x0B Step 3

Data sheet Universal controllers RMU7..B **N3150**
 Basic documentation Universal controllers RMU710B, RMU720B, RMU730B **P3150**

Number of S-mode DPs

	RMU7x0	RMU7x0B	RMU7x0B Step 3
Inputs / Outputs	3	3	3...4 ¹⁾
Inputs and outputs	0	29	10...17 ¹⁾
Inputs	18	10	6...10 ¹⁾
Outputs	7	17 (+73 Terminals)	13...26 ¹⁾
Terminals as reception objects	--	--	32
Terminals as transmission obj.	--	--	64

¹⁾ The number of inputs and outputs depends on the set basic type (A, C, U or P).

2.1.1 RMU7x0 Universal controllers

Basic types A, C, U

The RMU7x0 universal controllers comprise basic types A, C, U. They serve as the basis to configure own, new applications. Selecting a basic type determines the application and use of the controller.

DP in basic type column The tables in Section 2.2, column **DP in basic type**, show basic types A, C, U with the data point communicating in S-mode. For more information on the basic types, refer to the documentation on basics P3140.

Parameterization RMU7x0 An S-mode DP must be configured in ETS and the Synco device to ensure that the S-mode DP transmits valid values. See Section 1.5 on workflows.

2.1.2 RMU7x0B, RMU7x0 Step 3 Universal controllers

Basic types A, C, U, P The RMU7x0B and RMU7x0B Step 3 universal controllers comprise basic types A, C, U **and** P. They serve as the basis to configure own, new applications. Selecting a basic type determines the application and use of the controller.

Basic type	Typical applications
A	Ventilation / air conditioning plants, e.g. air handling plant control
C	Demand-dependent control of a chilled water treatment
U	Universal applications, e.g. control to flow setpoint
P	Demand-dependent control of an air handling plant with individual room control

DP in basic type column The tables in Section 2.3 show the basic types A, C, U, P with the data point communicating in S-mode in column **DP in basic type**.

The tables in Section 2.4 show the basic types and parameter settings with the data point communicating in S-mode in column **DP active**.

For more information on the basic types, refer to the documentation on basics P3150.

Parameterization RMU7x0B RMU7x0B Step 3 An S-mode DP must be configured in ETS and the Synco device to ensure that the S-mode DP transmits valid values. See Section 1.5 on workflows.

Universal reception and transmission zones **Only RMU7x0 Step 3**
 Controllers RMU7x0B Step 3 allows for universal data exchange via own terminals (universal inputs, relay and analog outputs) as well as via terminals of extension modules RMZ78x. Data is exchanged via KNX.

The universal inputs can be used as reception objects in **reception zones** and as transmission objects in **transmission zones**. The relays and analog outputs can only be used as transmission objects.

Reception zones	Universal inputs	Terminals N.X_ and A__.X_
Transmission zones	Universal inputs	Terminals N.X_ and A__.X_
	Relay outputs	N.Q_ and A__.Q_
	Analog outputs.	N.Y_ and A__.Y_

Note See Sections 2.4.5 to 2.4.10:

Rec. object	Reception object (terminal value connected as input).
Trans. object	Transmission object (terminal value connected as output).

2.2 RMU7x0, S-mode data points

RMU7x0: Inputs / Outputs

Name in ETS	DP in basic type	Flags					Data point type KNX				Value range	RMU receives or sends:
		C	R	W	T	U	ID	DPT_Name	Format	Unit		
System time (input) System time (output)	Always ⁵⁾	1	0	1	1	1	19.001	_DateTime	8 bytes struct.	YYYY MM DD d hh mm ss ---	1900...2155 = Year 1...12 = Month 1...31 = Day of month 1...7 = Monday - Sunday 0...23 = Hours 0...59 = Minutes 0...59 = Seconds Status bits ¹⁾	From KNX system time source or to KNX system time receiver cycl. 10 min.
Date (input) Date (output)	Always	1	0	1	1	1	11.001	_Date	3 bytes struct.	DD MM YY	1...31 = Day of month 1..0.12 = Month 00...99 = Year ⁴⁾	From KNX date source or to KNX date receiver cycl. 10 min.
Time of day (input) Time of day (output)	Always	1	0	1	1	1	10.001	_TimeOfDay	3 bytes struct.	d hh mm ss	1...7 = Monday - Sunday 0...23 = Hours 0...59 = Minutes 0...59 = Seconds	From KNX time source or to KNX time receiver cycl. 10 min.

¹⁾ See Section 1.4.3, page 13.

⁴⁾ See Section 1.4.3, page 14.

⁵⁾ See Section 1.5.1, page 16, Standard S-mode DP.

RMU7x0: Inputs

Name in ETS	DP in basic type	Flags					Data point type KNX				Value range	RMU7x0 receives:
		C	R	W	T	U	ID	DPT_Name	Format	Unit		
Confirm faults	Always	1	0	1	0	1	1.016	_Ack	1 bit B ₁	---	0 = No action 1 = Acknowledge / confirm	Event from KNX contact. No timeout monitoring.
Reset faults	Always	1	0	1	0	1	1.015	_Reset	1 bit B ₁	---	0 = No action 1 = Reset	Event from KNX contact. No timeout monitoring.
Fault transmission (enable/disable)	Always	1	0	1	0	1	1.003	_Enable	1 bit B ₁	---	0 = Disable 1 = Enable (default)	Event from KNX contact. "Disable" timeout monit 24 h.
Outside temperature	A, C, U	1	0	1	0	1	9.001	_Value_Temp	2 bytes F ₁₆	°C	-273.00...+670760.00 Floating point	COV from KNX sensor.
Room temperature	A	1	0	1	0	1	9.001	_Value_Temp	2 bytes F ₁₆	°C	-273.00...+670760.00 Floating point	COV from KNX sensor.
Timer button	A	1	0	1	0	1	1.017	_Trigger	1 bit B ₁	---	0 = No action 1 = Comfort prolongation ³⁾	Event from KNX contact
Comfort button	A	1	0	1	0	1	1.017	_Trigger	1 bit B ₁	---	0 = No action 1 = Optg mode changeover ³⁾	Event from KNX contact
Room temperature: Setpoint relative	A	1	0	1	0	1	9.002	_Value_Tempd	2 bytes F ₁₆	K	-670760.00...+670760.00 Floating point	COV from KNX setp adj.
Room optg mode: Preselection	A	1	0	1	0	1	20.102	_HVACMode	1 byte N ₈	Enum.	0 = Auto 1 = Comfort 2 = Precomfort (Standby) 3 = Economy 4 = Protection (BldgProtect) 5...255 Reserve	Event from KNX preselect operation (device/progr)
Room optg mode: Time switch operation Slave	A	1	0	1	0	1	20.102	_HVACMode	1 byte N ₈	Enum.	0 = Not used 1 = Comfort 2 = Precomfort (Standby) 3 = Economy 4 = Protection (BldgProtect) 5...255 Reserve	Event from KNX operation (device/progr). Timeout monit 31 min.

³⁾ See Section 1.4.3, page 14.

RMU7x0: Inputs (continued)

Name in ETS	DP in basic type	Flags					Data point type KNX				Value range	RMU7x0 receives:
		C	R	W	T	U	ID	DPT_Name	Format	Unit		
Room temp: Protection heating setpoint	A	1	0	1	0	1	9.001	_Value_Temp	2 bytes F ₁₆	°C	-273.00...+670760.00 Floating point	COV from KNX setp adj.
Room temp: Economy heating setpoint	A	1	0	1	0	1	9.001	_Value_Temp	2 bytes F ₁₆	°C	-273.00...+670760.00 Floating point	COV from KNX setp adj.
Room temp: Precomfort heating setpoint	A	1	0	1	0	1	9.001	_Value_Temp	2 bytes F ₁₆	°C	-273.00...+670760.00 Floating point	COV from KNX setp adj.
Room temp: Comfort heating setpoint	A	1	0	1	0	1	9.001	_Value_Temp	2 bytes F ₁₆	°C	-273.00...+670760.00 Floating point	COV from KNX setp adj.
Room temp: Comfort cooling setpoint	A	1	0	1	0	1	9.001	_Value_Temp	2 bytes F ₁₆	°C	-273.00...+670760.00 Floating point	COV from KNX setp adj.
Room temp: Precomfort cooling setpoint	A	1	0	1	0	1	9.001	_Value_Temp	2 bytes F ₁₆	°C	-273.00...+670760.00 Floating point	COV from KNX setp adj.
Room temp: Economy cooling setpoint	A	1	0	1	0	1	9.001	_Value_Temp	2 bytes F ₁₆	°C	-273.00...+670760.00 Floating point	COV from KNX setp adj.
Room temp: Protection cooling setpoint	A	1	0	1	0	1	9.001	_Value_Temp	2 bytes F ₁₆	°C	-273.00...+670760.00 Floating point	COV from KNX setp adj.

RMU7x0: Outputs

Name in ETS	DP in basic type	Flags					Data point type KNX				Value range	RMU7x0 sends:
		C	R	W	T	U	ID	DPT_Name	Format	Unit		
Fault information	Always	1	0	0	1	0	219.001	_AlarmInfo ²⁾	6 bytes struct.	- - -	[0]...255 = Log no. [RMU = 0] [0...2]...255 = Alarm priority [0...14]...255 = Application area [0...4]...255 = Error class [0...15]...63 = Alarm attributes [0...7] = Fault state	Heartbeat 30 min.
Fault state (normal/faulty)	Always	1	0	0	1	0	1.005	_Alarm	1 bit B ₁	- - -	0 = No alarm (default) 1 = Alarm / faulty	Event, heart- beat 30 min.
Outside temperature	A, C, U	1	0	0	1	0	9.001	_Value_Temp	2 bytes F ₁₆	°C	-273.00...+670760.00 Floating point	COV, heart- beat 15 min.
Room temperature	A	1	0	0	1	0	9.001	_Value_Temp	2 bytes F ₁₆	°C	-273.00...+670760.00 Floating point	COV, heart- beat 15 min.
Room optg mode: Time switch operation Master	A	1	0	0	1	0	20.102	_HVACMode	1 byte N ₈	Enum.	0 = Not used 1 = Comfort 2 = Precomfort (Standby) 3 = Economy 4 = Protection (BldgProtect) 5...255 Reserve	Event, heart- beat 15 min.
Room optg mode: State	A	1	0	0	1	0	20.102	_HVACMode	1 byte N ₈	Enum.	0 = Not used 1 = Comfort 2 = Precomfort (Standby) 3 = Economy 4 = Protection (BldgProtect) 5...255 Reserve	Event, heart- beat 15 min.
Heating/cooling changeover	C	1	0	0	1	0	1.100	_Heat/Cool	1 bit B ₁	- - -	0 = Cooling 1 = Heating (default)	Event, heart- beat 15 min.

²⁾ See Section 1.4.3, page 14.

2.3 RMU7x0B, S-mode data points

RMU7x0B: Inputs / Outputs

Name in ETS	DP in basic type	Flags					Data point type KNX				Value range	RMU receives or sends:
		C	R	W	T	U	ID	DPT_Name	Format	Unit		
System time (input) System time (output)	Always ⁵⁾	1	0	1	1	1	19.001	_DateTime	8 bytes struct.	YYYY MM DD d hh mm ss ---	1900...2155 = Year 1...12 = Month 1...31 = Day of month 1...7 = Monday - Sunday 0...23 = Hours 0...59 = Minutes 0...59 = Seconds Status bits ¹⁾	From KNX system time source or to KNX system time receiver cycl. 10 min.
Date (input) Date (output)	Always	1	0	1	1	1	11.001	_Date	3 bytes struct.	DD MM YY	1...31 = Day of month 1...12 = Month 00...99 = Year ⁴⁾	From KNX date source or to KNX date receiver cycl. 10 min.
Time of day (input) Time of day (output)	Always	1	0	1	1	1	10.001	_TimeOfDay	3 bytes struct.	d hh mm ss	1...7 = Monday - Sunday 0...23 = Hours 0...59 = Minutes 0...59 = Seconds	From KNX time source or to KNX time receiver cycl. 10 min.

¹⁾ See Section 1.4.3, page 13.

⁴⁾ See Section 1.4.3, page 14.

⁵⁾ See Section 1.5.1, page 16, Standard S-mode DP.

RMU7x0B: Inputs and outputs

S-mode DPs operated as input and output.

- Input: For operation using external device via KNX, Synco controller RMU7x0B receives the values of the S-mode DPs.
- Output: For operation from the Synco controller RMU7x0B, the S-mode DP values are sent via KNX (synchronization of external unit).

Name in ETS	DP in basic type	Flags					Data point type KNX				Value range	RMU7x0B rec., sends
		C	R	W	T	U	ID	DPT_Name	Format	Unit		
Room optg mode: Preselection	A, U	1	0	1	1	1	20.102	_HVACMode	1 byte N ₈	Enum.	0 = Auto 1 = Comfort 2 = Precomfort (Standby) 3 = Economy 4 = Protection (BldgProtect) 5...255 Reserve	Event from KNX preselect operation (device/progr)
[Controller 1] Economy heating setpoint	A	1	1	1	1	1	9.001	_Value_Temp	2 bytes F ₁₆	°C	-273.00...+670760.00 Floating point	COV from KNX setp adj.
[Controller 1] Precomfort heating setpoint	A	1	1	1	1	1	9.001	_Value_Temp	2 bytes F ₁₆	°C	-273.00...+670760.00 Floating point	COV from KNX setp adj.
[Controller 1] Comfort heating setpoint	A	1	1	1	1	1	9.001	_Value_Temp	2 bytes F ₁₆	°C	-273.00...+670760.00 Floating point	COV from KNX setp adj.
[Controller 1] Comfort cooling setpoint	A	1	1	1	1	1	9.001	_Value_Temp	2 bytes F ₁₆	°C	-273.00...+670760.00 Floating point	COV from KNX setp adj.
[Controller 1] Precomfort cooling setpoint	A	1	1	1	1	1	9.001	_Value_Temp	2 bytes F ₁₆	°C	-273.00...+670760.00 Floating point	COV from KNX setp adj.
[Controller 1] Economy cooling setpoint	A	1	1	1	1	1	9.001	_Value_Temp	2 bytes F ₁₆	°C	-273.00...+670760.00 Floating point	COV from KNX setp adj.
[Controller 1] Supply air limit max	A, P	1	1	1	1	1	9.001	_Value_Temp	2 bytes F ₁₆	°C	-273.00...+670760.00 Floating point	COV from KNX setp adj.
[Controller 1] Supply air limit min	A, P	1	1	1	1	1	9.001	_Value_Temp	2 bytes F ₁₆	°C	-273.00...+670760.00 Floating point	COV from KNX setp adj.
[Controller 1] Limit value high	A	1	1	1	1	1	9.001	_Value_Temp	2 bytes F ₁₆	°C	-273.00...+670760.00 Floating point	COV from KNX setp adj.
[Controller 1] Limit value low	A	1	1	1	1	1	9.001	_Value_Temp	2 bytes F ₁₆	°C	-273.00...+670760.00 Floating point	COV from KNX setp adj.
[Controller 1] Heating flow setpoint	C	1	1	1	1	1	9.001	_Value_Temp	2 bytes F ₁₆	°C	-273.00...+670760.00 Floating point	COV from KNX setp adj.
[Controller 1] Chilled water flow setpoint	C	1	1	1	1	1	9.001	_Value_Temp	2 bytes F ₁₆	°C	-273.00...+670760.00 Floating point	COV from KNX setp adj.

RMU7x0B: Inputs and outputs (continued)

Name in ETS	DP in basic type	Flags					Data point type KNX				Value range	RMU7x0B rec., sends
		C	R	W	T	U	ID	DPT_Name	Format	Unit		
[Controller 1] Precomfort setpoint high [°C]	U	1	1	1	1	1	9.001	_Value_Temp	2 bytes F ₁₆	°C	-273.00...+670760.00 Floating point	COV from KNX setp adj.
[Controller 1] Comfort setpoint high [°C]	U	1	1	1	1	1	9.001	_Value_Temp	2 bytes F ₁₆	°C	-273.00...+670760.00 Floating point	COV from KNX setp adj.
[Controller 1] Comfort setpoint low [°C]	U	1	1	1	1	1	9.001	_Value_Temp	2 bytes F ₁₆	°C	-273.00...+670760.00 Floating point	COV from KNX setp adj.
[Controller 1] Precomfort setpoint low [°C]	U	1	1	1	1	1	9.001	_Value_Temp	2 bytes F ₁₆	°C	-273.00...+670760.00 Floating point	COV from KNX setp adj.
[Controller 2...3] Economy setpoint high [°C]	A, C, U, P	1	1	1	1	1	9.001	_Value_Temp	2 bytes F ₁₆	°C	-273.00...+670760.00 Floating point	COV from KNX setp adj.
[Controller 2...3] Precomfort setpoint high [°C]	A, C, U, P	1	1	1	1	1	9.001	_Value_Temp	2 bytes F ₁₆	°C	-273.00...+670760.00 Floating point	COV from KNX setp adj.
[Controller 2...3] Comfort setpoint high [°C]	A, C, U, P	1	1	1	1	1	9.001	_Value_Temp	2 bytes F ₁₆	°C	-273.00...+670760.00 Floating point	COV from KNX setp adj.
[Controller 2...3] Comfort setpoint low [°C]	A, C, U, P	1	1	1	1	1	9.001	_Value_Temp	2 bytes F ₁₆	°C	-273.00...+670760.00 Floating point	COV from KNX setp adj.
[Controller 2...3] Precomfort setpoint low [°C]	A, C, U, P	1	1	1	1	1	9.001	_Value_Temp	2 bytes F ₁₆	°C	-273.00...+670760.00 Floating point	COV from KNX setp adj.
[Controller 2...3] Economy setpoint low [°C]	A, C, U, P	1	1	1	1	1	9.001	_Value_Temp	2 bytes F ₁₆	°C	-273.00...+670760.00 Floating point	COV from KNX setp adj.

For [Controller 1] Basic type U and [Controller 2], [Controller 3] basic types A, C, U, P, parameter "[Controller 2] Main controlled variable unit" ([Controller 2] as example) can be used to configure the setpoint for various units or physical variables.

See screenshot (right) for [Controller 2].

47	[Controller 2] Economy setpoint high [°C]	Input and Output	2 Byte	C	R	W	T	U
48	[Controller 2] Precomfort setpoint high [°C]	Input and Output	2 Byte	C	R	W	T	U
49	[Controller 2] Comfort setpoint high [°C]	Input and Output	2 Byte	C	R	W	T	U
50	[Controller 2] Comfort setpoint low [°C]	Input and Output	2 Byte	C	R	W	T	U
51	[Controller 2] Precomfort setpoint low [°C]	Input and Output	2 Byte	C	R	W	T	U
52	[Controller 2] Economy setpoint low [°C]	Input and Output	2 Byte	C	R	W	T	U

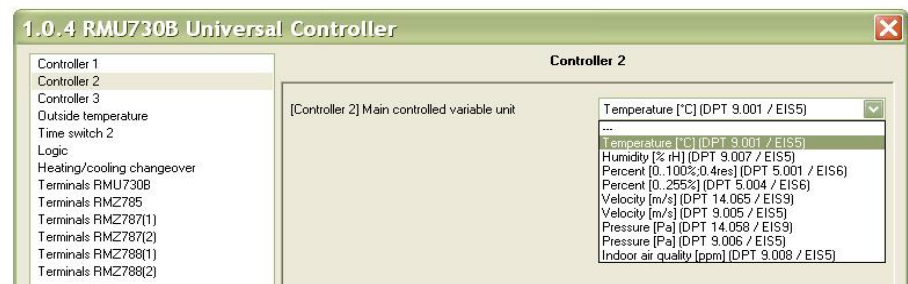

RMU7x0B: Inputs

Name in ETS	DP in basic type	Flags					Data point type KNX				Value range	RMU7x0B receives:
		C	R	W	T	U	ID	DPT_Name	Format	Unit		
Confirm faults	Always	1	0	1	0	1	1.016	_Ack	1 bit B ₁	- - -	0 = No action 1 = Acknowledge / confirm	Event from KNX contact. No timeout monitoring.
Reset faults	Always	1	0	1	0	1	1.015	_Reset	1 bit B ₁	- - -	0 = No action 1 = Reset	Event from KNX contact. No timeout monitoring.
Fault transmission (enable/disable)	Always	1	0	1	0	1	1.003	_Enable	1 bit B ₁	- - -	0 = Disable 1 = Enable (default)	Event from KNX contact. "Disable" time-out monit 24 h.
Outside temperature	A, C, U, P	1	0	1	0	1	9.001	_Value_Temp	2 bytes F ₁₆	°C	-273.00...+670760.00 Floating point	COV from KNX sensor.
Timer button	A	1	0	1	0	1	1.017	_Trigger	1 bit B ₁	- - -	0 = No action 1 = Comfort prolongation ³⁾	Event from KNX contact.
Comfort button	A	1	0	1	0	1	1.017	_Trigger	1 bit B ₁	- - -	0 = No action 1 = Optg mode changeover ³⁾	Event from KNX contact.
Room optg mode: Time switch (Parameterization: Slave)	A	1	0	1	0	1	20.102	_HVACMode	1 byte N ₈	Enum.	0 = Not used 1 = Comfort 2 = Precomfort (Standby) 3 = Economy 4 = Protection (BldgProtect) 5...255 Reserve	Event from KNX operation (device/progr). Timeout monit 31 min.
Room temperature	A	1	0	1	0	1	9.001	_Value_Temp	2 bytes F ₁₆	°C	-273.00...+670760.00 Floating point	COV from KNX sensor.
Room temperature: Setpoint relative	A	1	0	1	0	1	9.002	_Value_Tempd	2 bytes F ₁₆	K	-670760.00...+670760.00 Floating point	COV from KNX setp adj.
Heating/cooling changeover	A, C, U, P	1	0	1	1	0	1.100	_Heat/Cool	1 bit B ₁	- - -	0 = Cooling 1 = Heating (default)	Event, heart-beat 15 min.

³⁾ See Section 1.4.3, page 14.

RMU7x0B: Outputs

Name in ETS	DP in basic type	Flags					Data point type KNX				Value range	RMU7x0B sends:
		C	R	W	T	U	ID	DPT_Name	Format	Unit		
Fault information	Always	1	0	0	1	0	219.001	_AlarmInfo ²⁾	6 bytes struct.	- - -	[0]...255 = Log no. [RMU = 0] [0...2]...255 = Alarm priority [0...14]...255 = Application area [0...4]...255 = Error class [0...15]...63 = Alarm attributes [0...7] = Fault state	Heartbeat 30 min.
Fault state (normal/faulty)	Always	1	0	0	1	0	1.005	_Alarm	1 bit B ₁	- - -	0 = No alarm (default) 1 = Alarm / faulty	Event, heart-beat 30 min.
Outside temperature ⁷⁾	A, C, U, P	1	0	0	1	0	9.001	_Value_Temp	2 bytes F ₁₆	°C	-273.00...+670760.00 Floating point	COV, heart-beat 15 min.
Room optg mode: Time switch (Parameterization: Master)	A	1	0	0	1	0	20.102	_HVACMode	1 byte N ₈	Enum.	0 = Not used 1 = Comfort 2 = Precomfort (Standby) 3 = Economy 4 = Protection (BldgProtect) 5...255 Reserve	Event, heart-beat 15 min.
Room optg mode: State	A, U	1	0	0	1	0	20.102	_HVACMode	1 byte N ₈	Enum.	0 = Not used 1 = Comfort 2 = Precomfort (Standby) 3 = Economy 4 = Protection (BldgProtect) 5...255 Reserve	Event, heart-beat 15 min.
Room temperature ⁷⁾	A	1	0	0	1	0	9.001	_Value_Temp	2 bytes F ₁₆	°C	-273.00...+670760.00 Floating point	COV, heart-beat 15 min.
[Controller 1] Current cooling setpoint supply air ⁶⁾	A, P	1	0	0	1	0	9.001	_Value_Temp	2 bytes F ₁₆	°C	-273.00...+670760.00 Floating point	COV, heart-beat 15 min.
[Controller 1] Current heating setpoint supply air ⁶⁾	A, P	1	0	0	1	0	9.001	_Value_Temp	2 bytes F ₁₆	°C	-273.00...+670760.00 Floating point	COV, heart-beat 15 min.
[Controller 1] Current supply air temp setpoint ⁶⁾	P	1	0	0	1	0	9.001	_Value_Temp	2 bytes F ₁₆	°C	-273.00...+670760.00 Floating point	COV, heart-beat 15 min.

²⁾ See Section 1.4.3, page 14.

⁶⁾ See Section 1.5.1, page 16, Out of service.

⁷⁾ See Section 1.5.1, page 16, S-mode DP sends 0.

RMU7x0B: Outputs (continued)

Name in ETS	DP in basic type	Flags					Data point type KNX				Value range	RMU7x0B sends:
		C	R	W	T	U	ID	DPT_Name	Format	Unit		
[Controller 1] Current setpoint ⁶⁾	A, C	1	0	0	1	0	9.001	_Value_Temp	2 bytes F ₁₆	°C	-273.00...+670760.00 Floating point	COV, heart-beat 15 min.
[Controller 1] Current setpoint [°C] ⁶⁾	U	1	0	0	1	0	9.001	_Value_Temp	2 bytes F ₁₆	°C	-273.00...+670760.00 Floating point	COV, heart-beat 15 min.
[Controller 2...3] Current setpoint [°C] ⁶⁾	A, C, U, P	1	0	0	1	0	9.001	_Value_Temp	2 bytes F ₁₆	°C	-273.00...+670760.00 Floating point	COV, heart-beat 15 min.
[Time switch 2] State	A, C, U, P	1	0	0	1	0	1.001	_Switch	1 bit B ₁	- - -	0 = Off 1 = On	Event, heart-beat 15 min.
[Logic 1...2] State	A, C, U, P	1	0	0	1	0	1.001	_Switch	1 bit B ₁	- - -	0 = Off 1 = On	Event, heart-beat 15 min.
Heating/cooling changeover	A, C, U, P	1	0	0	1	0	1.100	_Heat/Cool	1 bit B ₁	- - -	0 = Cooling 1 = Heating (default)	Event, heart-beat 15 min.

For the S-mode DPs (see table above).

- [Controller 1] Current setpoint [°C], basic type U.
- [Controller 2] Current setpoint [°C], basic types A, C, U, P.
- [Controller 3] Current setpoint [°C], basic types A, C, U, P.

"Current setpoint" is displayed as per the unit selected during S-mode DP configuration (e.g. "[Controller 2] Comfort setpoint high").

Thus, "Current setpoint" is not always sent as a temperature value [°C], but can also be sent as humidity value [% rH], for example.

The screenshot (right) shows possible units for "Current setpoint".

47	[Controller 2] Economy setpoint high [°C]	Input and Output	2 Byte	C	R	W	T	U
48	[Controller 2] Precomfort setpoint high [°C]	Input and Output	2 Byte	C	R	W	T	U
49	[Controller 2] Comfort setpoint high [°C]	Input and Output	2 Byte	C	R	W	T	U
50	[Controller 2] Comfort setpoint low [°C]	Input and Output	2 Byte	C	R	W	T	U
51	[Controller 2] Precomfort setpoint low [°C]	Input and Output	2 Byte	C	R	W	T	U
52	[Controller 2] Economy setpoint low [°C]	Input and Output	2 Byte	C	R	W	T	U

⁶⁾ See Section 1.5.1, page 16, Out of service.

RMU7x0B: Terminals, Universal controllers RMU7x0B

- Input terminals N.X1...N.X6 (RMU710B) and N.X1...N.X8 (RMU720B, RMU730B) with S-mode function "Output", parameterizable for analog input value [°C], [% rH] etc. or for digital input value [0/1].

Name in ETS	DP ⁷⁾	Flags					Data point type KNX				Value range	RMU7x0B sends:
		C	R	W	T	U	ID	DPT_Name	Format	Unit		
Input N.X_ [°C]	RMU7x0B	1	1	0	1	0	9.001	_Value_Temp	2 bytes F ₁₆	°C	-273.00...+670760.00 Floating point	COV, heart-beat 15 min.
Input N.X_ [% rH]	RMU7x0B	1	1	0	1	0	9.007	_Value_Humidity	2 bytes F ₁₆	%	[0...670760]	COV, heart-beat 15 min.
Input N.X_ [0...100%]	RMU7x0B	1	1	0	1	0	5.001	_Scaling	8 bit U ₈	%	[0...100] Resolution 0.4 %	COV, heart-beat 15 min.
Input N.X_ [0...255%]	RMU7x0B	1	1	0	1	0	5.004	_Percent	8 bit U ₈	%	[0...255] Resolution 1%	COV, heart-beat 15 min.
Input N.X_ [m/s]	RMU7x0B	1	1	0	1	0	14.065	_Value_Speed	4 bytes F ₃₂	m/s	IEEE 754 floating [0...255].[0...8388607]	COV, heart-beat 15 min.
Input N.X_ [m/s]	RMU7x0B	1	1	0	1	0	9.005	_Value_Wsp	2 bytes F ₁₆	m/s	[0...670760]	COV, heart-beat 15 min.
Input N.X_ [Pa]	RMU7x0B	1	1	0	1	0	14.058	_Value_Pressure	4 bytes F ₃₂	Pa = N/m ²	IEEE 754 floating [0...255].[0...8388607]	COV, heart-beat 15 min.
Input N.X_ [Pa]	RMU7x0B	1	1	0	1	0	9.006	_Value_Pres	2 bytes F ₁₆	Pa = N/m ²	[0...670760]	COV, heart-beat 15 min.
Input N.X_ [ppm]	RMU7x0B	1	1	0	1	0	9.008	_Value_AirQuality	2 bytes F ₁₆	ppm	[0...670760]	COV, heart-beat 15 min.
Input N.X_ [0/1]	RMU7x0B	1	1	0	1	0	1.001	_Switch	1 bit B ₁	- - -	0 = Off 1 = On	Event, heart-beat 15 min.

- Output terminals N.Q1, N.Q3 (RMU710B), N.Q1...N.Q5 (RMU720B), N.Q1...N.Q7 (RMU730B), parameterized for digital output value [0/1].

Output N.Q_	RMU7x0B	1	1	0	1	0	1.001	_Switch	1 bit B ₁	- - -	0 = Off 1 = On	Event, heart-beat 15 min.
-------------	---------	---	---	---	---	---	-------	---------	-------------------------	-------	-------------------	---------------------------

- Output terminals N.Y1, N.Y2 (RMU710B), N.Y1...N.Y3 (RMU720B), N.Y1...N.Y4 (RMU730B), parameterized for analog output value [0...100].

Output N.Y_	RMU7x0B	1	1	0	1	0	5.001	_Scaling	8 bit U ₈	%	[0...100] Resolution 0.4 %	COV, heart-beat 15 min.
-------------	---------	---	---	---	---	---	-------	----------	-------------------------	---	-------------------------------	-------------------------

⁷⁾ See Section 1.5.1, page 16, S-mode DP sends 0.

RMU7x0B: Terminals, Extension modules RMZ78x on Universal controller RMU7x0B

- Input terminals A__X_ with S-mode function "Output", parameterizable for analog input value [°C], [% rH] etc. or for digital input value [0/1].

Name in ETS	DP ⁷⁾	Flags					Data point type KNX				Value range	RMU7x0B sends:
		C	R	W	T	U	ID	DPT_Name	Format	Unit		
Input A__X_ [°C]	RMZ78x	1	1	0	1	0	9.001	_Value_Temp	2 bytes F ₁₆	°C	-273.00...+670760.00 Floating point	COV, heart-beat 15 min.
Input A__X_ [% rH]	RMZ78x	1	1	0	1	0	9.007	_Value_Humidity	2 bytes F ₁₆	%	[0...670760]	COV, heart-beat 15 min.
Input A__X_ [0...100%]	RMZ78x	1	1	0	1	0	5.001	_Scaling	8 bit U ₈	%	[0...100] Resolution 0.4 %	COV, heart-beat 15 min.
Input A__X_ [0...255%]	RMZ78x	1	1	0	1	0	5.004	_Percent	8 bit U ₈	%	[0...255] Resolution 1%	COV, heart-beat 15 min.
Input A__X_ [m/s]	RMZ78x	1	1	0	1	0	14.065	_Value_Speed	4 bytes F ₃₂	m/s	IEEE 754 floating [0...255].[0...8388607]	COV, heart-beat 15 min.
Input A__X_ [m/s]	RMZ78x	1	1	0	1	0	9.005	_Value_Wsp	2 bytes F ₁₆	m/s	[0...670760]	COV, heart-beat 15 min.
Input A__X_ [Pa]	RMZ78x	1	1	0	1	0	14.058	_Value_Pressure	4 bytes F ₃₂	Pa = N/m ²	IEEE 754 floating [0...255].[0...8388607]	COV, heart-beat 15 min.
Input A__X_ [Pa]	RMZ78x	1	1	0	1	0	9.006	_Value_Pres	2 bytes F ₁₆	Pa = N/m ²	[0...670760]	COV, heart-beat 15 min.
Input A__X_ [ppm]	RMZ78x	1	1	0	1	0	9.008	_Value_AirQuality	2 bytes F ₁₆	ppm	[0...670760]	COV, heart-beat 15 min.
Input A__X_ [0/1]	RMZ78x	1	1	0	1	0	1.001	_Switch	1 bit B ₁	- - -	0 = Off 1 = On	Event, heart-beat 15 min.

Input A5.X1...A5.X8	RMZ785
Input A7(1).X1...A7(1).X4	RMZ787(1)
Input A7(2).X1...A7(2).X4	RMZ787(2)
Input A8(1).X1...A8(1).X4	RMZ788(1)
Input A8(2).X1...A8(2).X4	RMZ788(2)

⁷⁾ See Section 1.5.1, page 16, S-mode DP sends 0.

RMU7x0B: Terminals, Extension modules RMZ78x on Universal controller RMU7x0B (continued)

- Output terminals A__.Q_, parameterized for digital output value [0/1].

Name in ETS	DP ⁷⁾	Flags					Data point type KNX				Value range	RMU7x0B sends:
		C	R	W	T	U	ID	DPT_Name	Format	Unit		
Output A__.Q_	RMZ78x	1	1	0	1	0	1.001	_Switch	1 bit B ₁	- - -	0 = Off 1 = On	Event, heart-beat 15 min.

Output A7(1).Q1...A7(1).Q5 RMZ787(1) without Q4
 Output A7(2).Q1...A7(2).Q5 RMZ787(2) without Q4
 Output A8(1).Q1, A8(1).Q5 RMZ788(1)
 Output A8(2).Q1, A8(2).Q5 RMZ788(2)

- Output terminals A__.Y_, parameterized for analog output value [0...100].

Name in ETS	DP ⁷⁾	Flags					Data point type KNX				Value range	RMU7x0B sends:
		C	R	W	T	U	ID	DPT_Name	Format	Unit		
Output A__.Y_	RMZ78x	1	1	0	1	0	5.001	_Scaling	8 bit U ₈	%	[0...100] Resolution 0.4 %	COV, heart-beat 15 min.

Output A8(1).Y1, A8(1).Y2 RMZ788(1)
 Output A8(2).Y1, A8(2).Y2 RMZ788(2)

Note: Max. 4 Extension modules RMZ78x (same or different types) are allowed per Universal controller RMU7x0B.

⁷⁾ See Section 1.5.1, page 16, S-mode DP sends 0.

2.4 RMU7x0B Step 3, S-mode data points

2.4.1 Basic type A, Ventilation controller

RMU7x0B Step 3: Inputs / Outputs, Basic type A

Name in ETS	DP active	Flags					Data point type KNX				Value range	RMU receives or sends:
		C	R	W	T	U	ID	DPT_Name	Format	Unit		
System time (input) System time (output)	Always ⁵⁾	1	0	1	1	1	19.001	_DateTime	8 bytes struct.	YYYY MM DD d hh mm ss ---	1900...2155 = Year 1...12 = Month 1...31 = Day of month 1...7 = Monday - Sunday 0...23 = Hours 0...59 = Minutes 0...59 = Seconds Status bits ¹⁾	From KNX system time source or to KNX system time receiver cycl. 10 min.
Date (input) Date (output)	Always	1	0	1	1	1	11.001	_Date	3 bytes struct.	DD MM YY	1...31 = Day of month 1...12 = Month 00...99 = Year ⁴⁾	From KNX date source or to KNX date receiver cycl. 10 min.
Time of day (input) Time of day (output)	Always	1	0	1	1	1	10.001	_TimeOfDay	3 bytes struct.	d hh mm ss	1...7 = Monday - Sunday 0...23 = Hours 0...59 = Minutes 0...59 = Seconds	From KNX time source or to KNX time receiver cycl. 10 min.

¹⁾ See Section 1.4.3, page 13.

⁴⁾ See Section 1.4.3, page 14.

⁵⁾ See Section 1.5.1, page 16, Standard S-mode DP.

RMU7x0B Step 3: Inputs and outputs, Basic type A

S-mode DPs operated as input and output.

- Input: For operation using external device via KNX, Synco controller RMU7x0B Step 3 receives the values of the S-mode DPs.
- Output: For operation from the Synco controller RMU7x0B Step 3, the S-mode DP values are sent via KNX (synchronization of external unit).

The configuration of some S-mode data points is determined based on one of the following four control strategies for plant type "Basic type A, Ventilation controller":

- With supply air limitation [S'air limit]
- Cascade [Cascade]
- Constant (supply air) [Constant]
- Cascade/const (alternating) [A'nating]

Name in ETS	DP active	Flags					Data point type KNX				Value range	RMU7x0B rec., sends
		C	R	W	T	U		DPT_Name	Format	Unit		
Room optg mode: Preselection	Plant type = B.type A	1	1	1	1	1	20.102	_HVACMode	1 Byte N ₈	Enum.	0 = Auto 1 = Comfort 2 = Precomfort (Standby) 3 = Economy 4 = Protection (BldgProtect) 5...255 Reserve	Event from KNX preselect operation (device/progr)
[Controller 1] Economy heating setpoint	Plant type = B.type A	1	1	1	1	1	9.001	_Value_Temp	2 Bytes F ₁₆	°C	-273.00...+670760.00 Floating point	COV from KNX setp adj.
[Controller 1] Precomfort heating setpoint		1	1	1	1	1	9.001	_Value_Temp	2 Bytes F ₁₆	°C	-273.00...+670760.00 Floating point	COV from KNX setp adj.
[Controller 1] Comfort heating setpoint		1	1	1	1	1	9.001	_Value_Temp	2 Bytes F ₁₆	°C	-273.00...+670760.00 Floating point	COV from KNX setp adj.
[Controller 1] Comfort cooling setpoint		1	1	1	1	1	9.001	_Value_Temp	2 Bytes F ₁₆	°C	-273.00...+670760.00 Floating point	COV from KNX setp adj.
[Controller 1] Precomfort cooling setpoint		1	1	1	1	1	9.001	_Value_Temp	2 Bytes F ₁₆	°C	-273.00...+670760.00 Floating point	COV from KNX setp adj.
[Controller 1] Economy cooling setpoint		1	1	1	1	1	9.001	_Value_Temp	2 Bytes F ₁₆	°C	-273.00...+670760.00 Floating point	COV from KNX setp adj.
[Controller 1] Supply air limit max	A and [Cascade] [A'nating]	1	1	1	1	1	9.001	_Value_Temp	2 Bytes F ₁₆	°C	-273.00...+670760.00 Floating point	COV from KNX setp adj.
[Controller 1] Supply air limit min		1	1	1	1	1	9.001	_Value_Temp	2 Bytes F ₁₆	°C	-273.00...+670760.00 Floating point	COV from KNX setp adj.
[Controller 1] Limit value high	A and [S'air limit]	1	1	1	1	1	9.001	_Value_Temp	2 Bytes F ₁₆	°C	-273.00...+670760.00 Floating point	COV from KNX setp adj.
[Controller 1] Limit value low		1	1	1	1	1	9.001	_Value_Temp	2 Bytes F ₁₆	°C	-273.00...+670760.00 Floating point	COV from KNX setp adj.

RMU7x0B Step 3: Inputs and outputs, Basic type A (continued)

Name in ETS	DP active	Flags					Data point type KNX				Value range	RMU7x0B rec., sends
		C	R	W	T	U	ID	DPT_Name	Format	Unit		
[Controller 2...3] Economy setpoint high [°C]	A and [Ctr. 2...3] Main ctrd variab. unit = Temp.	1	1	1	1	1	9.001	_Value_Temp	2 Bytes F ₁₆	°C	-273.00...+670760.00 Floating point	COV from KNX setp adj.
[Controller 2...3] Precomfort setpoint high [°C]		1	1	1	1	1	9.001	_Value_Temp	2 Bytes F ₁₆	°C	-273.00...+670760.00 Floating point	COV from KNX setp adj.
[Controller 2...3] Comfort setpoint high [°C]		1	1	1	1	1	9.001	_Value_Temp	2 Bytes F ₁₆	°C	-273.00...+670760.00 Floating point	COV from KNX setp adj.
[Controller 2...3] Comfort setpoint low [°C]		1	1	1	1	1	9.001	_Value_Temp	2 Bytes F ₁₆	°C	-273.00...+670760.00 Floating point	COV from KNX setp adj.
[Controller 2...3] Precomfort setpoint low [°C]		1	1	1	1	1	9.001	_Value_Temp	2 Bytes F ₁₆	°C	-273.00...+670760.00 Floating point	COV from KNX setp adj.
[Controller 2...3] Economy setpoint low [°C]		1	1	1	1	1	9.001	_Value_Temp	2 Bytes F ₁₆	°C	-273.00...+670760.00 Floating point	COV from KNX setp adj.

[Controller 2...3] Economy setpoint high [°C] is displayed as per the unit selected during S-mode data point configuration.

[Controller 2...3] Economy setpoint high can be received and sent e.g. also as humidity value [% rH].

The screenshot shows the possible units for:

- [Controller 2...3] Economy setpoint high
- [Controller 2...3] Precomfort setpoint high
- [Controller 2...3] Comfort setpoint high
- [Controller 2...3] Comfort setpoint low
- [Controller 2...3] Precomfort setpoint low
- [Controller 2...3] Economy setpoint low

52	[Controller 2] Economy setpoint high [% rH]	Input and Output	2 Byte	C	R	W	T	U
53	[Controller 2] Precomfort setpoint high [% rH]	Input and Output	2 Byte	C	R	W	T	U
54	[Controller 2] Comfort setpoint high [% rH]	Input and Output	2 Byte	C	R	W	T	U
55	[Controller 2] Comfort setpoint low [% rH]	Input and Output	2 Byte	C	R	W	T	U
56	[Controller 2] Precomfort setpoint low [% rH]	Input and Output	2 Byte	C	R	W	T	U
57	[Controller 2] Economy setpoint low [% rH]	Input and Output	2 Byte	C	R	W	T	U

RMU7x0B Step 3: Inputs, Basic type A

Name in ETS	DP active	Flags					Data point type KNX				Value range	RMU7xB receives:
		C	R	W	T	U	ID	DPT_Name	Format	Unit		
Confirm faults	Always	1	0	1	0	1	1.016	_Ack	1 Bit B ₁	---	0 = No action 1 = Acknowledge / bestätigen	Event from KNX contact. No timeout monitoring.
Reset faults	Always	1	0	1	0	1	1.015	_Reset	1 Bit B ₁	---	0 = No action 1 = Reset / zurücksetzen	Event from KNX contact. No timeout monitoring.
Fault transmission (enable/disable)	Always	1	0	1	0	1	1.003	_Enable	1 Bit B ₁	---	0 = Disable / sperren 1 = Enable / freigeben (default)	Event from KNX contact. "Disable" time-out monit 24 h.
Outside temperature	Outs.temp. = Receive	1	0	1	0	1	9.001	_Value_Temp	2 Bytes F ₁₆	°C	-273.00...+670760.00 Floating point	COV from KNX sensor.
Timer button	Plant type = B.type A	1	0	1	0	1	1.017	_Trigger	1 Bit B ₁	---	0 = No action 1 = Comfort prolongation ³⁾	Event from KNX contact.
Comfort button		1	0	1	0	1	1.017	_Trigger	1 Bit B ₁	---	0 = No action 1 = Optg mode changeover ³⁾	Event from KNX contact.
Room optg mode: Time switch	A and Time swi. operation = Slave	1	0	1	0	1	20.102	_HVACMode	1 Byte N ₈	Enum.	0 = Not used 1 = Comfort 2 = Precomfort (Standby) 3 = Economy 4 = Protection (BldgProtect) 5...255 Reserve	Event from KNX operation (device/progr). Timeout monit 31 min.
Room temperature	A and Rm temp. = Receive	1	0	1	0	1	9.001	_Value_Temp	2 Bytes F ₁₆	°C	-273.00...+670760.00 Floating point	COV from KNX sensor.
Room temperature: Setpoint relative	Plant type = B.type A	1	0	1	0	1	9.002	_Value_Tempd	2 Bytes F ₁₆	K	-670760.00...+670760.00 Floating point	COV from KNX setp adj.
Heating/cooling changeover	H/C ch'over = Receive	1	0	1	0	1	1.100	_Heat/Cool	1 Bit B ₁	---	0 = Cooling 1 = Heating (default)	Event, heart-beat 15 min.

³⁾ See Section 1.4.3, page 14.

RMU7x0B Step 3: Outputs, Basic type A

Name in ETS	DP active	Flags					Data point type KNX				Value range	RMU7x0B sends:
		C	R	W	T	U	ID	DPT_Name	Format	Unit		
Fault information	Always	1	0	0	1	0	219.001	_AlarmInfo ²⁾	6 Bytes strukt.	- - -	[0]...255 = Log no. [RMU = 0] [0...2]...255 = Alarm priority [0...14]...255 = Application area [0...4]...255 = Error class [0...15]...63 = Alarm attributes [0...7] = Fault state	Heartbeat 30 min.
Fault state (normal/faulty)	Always	1	0	0	1	0	1.005	_Alarm	1 Bit B ₁	- - -	0 = No alarm (default) 1 = Alarm / faulty	Event, heart- beat 30 min.
Outside temperature ⁷⁾	Outs.temp. = Transmit	1	0	0	1	0	9.001	_Value_Temp	2 Bytes F ₁₆	°C	-273.00...+670760.00 Floating point	Event, heart- beat 30 min.
Room optg mode: Time switch	A and Time swi. operation = Master	1	0	0	1	0	20.102	_HVACMode	1 Byte N ₈	Enum.	0 = Not used 1 = Komfort 2 = Prekomfort (Standby) 3 = Economy 4 = Schutzbetrieb (BldgProtect) 5...255 Reserve	COV, heart- beat 15 min.
Room optg mode: State	Plant type = B.type A	1	0	0	1	0	20.102	_HVACMode	1 Byte N ₈	Enum.	0 = Not used 1 = Komfort 2 = Prekomfort (Standby) 3 = Economy 4 = Schutzbetrieb (BldgProtect) 5...255 Reserve	Event, heart- beat 15 min.
Room temperature ⁷⁾	A and Rm temp. = Transmit	1	0	0	1	0	9.001	_Value_Temp	2 Bytes F ₁₆	°C	-273.00...+670760.00 Floating point	Event, heart- beat 15 min.
[Controller 1] Current room temp setpoint ⁶⁾	A and [Cascade] [A'nating]	1	0	0	1	0	9.001	_Value_Temp	2 Bytes F ₁₆	°C	-273.00...+670760.00 Floating point	COV, heart- beat 15 min.

²⁾ See Section 1.4.3, page 14.

⁶⁾ See Section 1.5.1, page 16, Out of service.

⁷⁾ See Section 1.5.1, page 16, S-mode DP sends 0.

RMU7x0B Step 3: Outputs, Basic type A (continued)

Name in ETS	DP active	Flags					Data point type KNX				Value range	RMU7x0B sends:
		C	R	W	T	U	ID	DPT_Name	Format	Unit		
[Controller 1] Current setpoint ⁶⁾	A and [S'air limit] [Constant] [A'nating]	1	0	0	1	0	9.001	_Value_Temp	2 Bytes F ₁₆	°C	-273.00...+670760.00 Floating point	COV, heart-beat 15 min.
[Controller 2...3] Current setpoint [°C] ⁶⁾	A and [Ctr. 2...3] Main ctrd variab. unit = Temp.	1	0	0	1	0	9.001	_Value_Temp	2 Bytes F ₁₆	°C	-273.00...+670760.00 Floating point	COV, heart-beat 15 min.
[Time switch 2] State	[Time swi. 2] State = Yes	1	0	0	1	0	1.001	_Switch	1 Bit B ₁	- - -	0 = Off 1 = On	COV, heart-beat 15 min.
[Logic 1...4] State	[Logic X] State = Yes	1	0	0	1	0	1.001	_Switch	1 Bit B ₁	- - -	0 = Off 1 = On	Event, heart-beat 15 min.
Heating/cooling changeover	H/C ch'over = Transmit	1	0	0	1	0	1.100	_Heat/Cool	1 Bit B ₁	- - -	0 = Cooling 1 = Heating (default)	Event, heart-beat 15 min.

⁶⁾ See Section 1.5.1, page 16, Out of service.

- [Controller 1] Current setpoint (always [°C])
- [Controller 2...3] Current setpoint [°C] is displayed as per the unit selected during S-mode data point configuration.
[Controller 2...3] Current setpoint can be sent e.g. also as humidity value [% rH].

The screenshot shows:

[Controller 1] Current setpoint (always [°C]) and as an example
[Controller 2] Current setpoint [% rH]

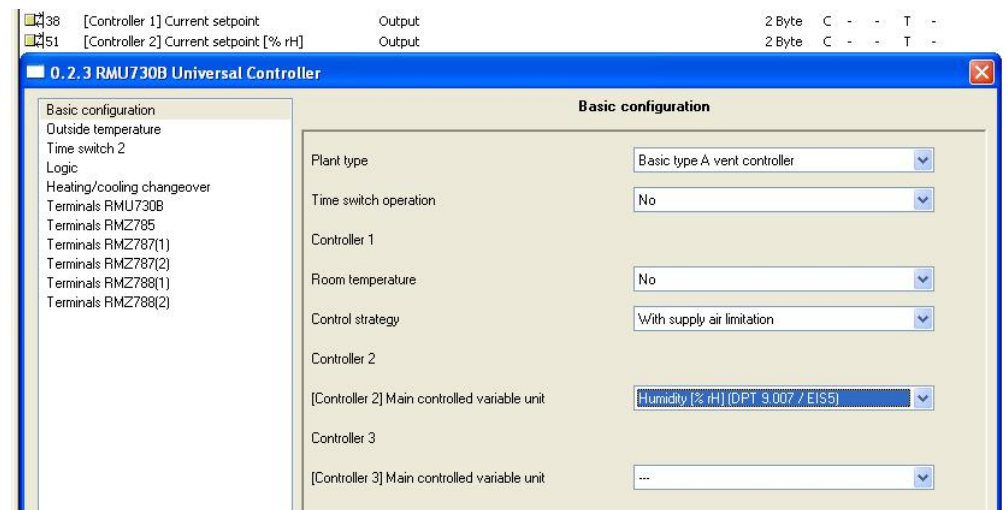

2.4.2 Basic type P, Primary air handling

RMU7x0B Step 3: Inputs / Outputs, Basic type P

Name in ETS	DP active	Flags					Data point type KNX				Value range	RMU receives or sends:
		C	R	W	T	U	ID	DPT_Name	Format	Unit		
System time (input) System time (output)	Always ⁵⁾	1	0	1	1	1	19.001	_DateTime	8 bytes struct.	YYYY MM DD d hh mm ss ---	1900...2155 = Year 1...12 = Month 1...31 = Day of month 1...7 = Monday - Sunday 0...23 = Hours 0...59 = Minutes 0...59 = Seconds Status bits ¹⁾	From KNX system time source or to KNX system time receiver cycl. 10 min.
Date (input) Date (output)	Always	1	0	1	1	1	11.001	_Date	3 bytes struct.	DD MM YY	1...31 = Day of month 1...12 = Month 00...99 = Year ⁴⁾	From KNX date source or to KNX date receiver cycl. 10 min.
Time of day (input) Time of day (output)	Always	1	0	1	1	1	10.001	_TimeOfDay	3 bytes struct.	d hh mm ss	1...7 = Monday - Sunday 0...23 = Hours 0...59 = Minutes 0...59 = Seconds	From KNX time source or to KNX time receiver cycl. 10 min.
[Controller 1] Current supply air temp setpoint	Plant type = B.type P	1	1	1	1	1	9.001	_Value_Temp	2 Bytes F ₁₆	°C	-273.00...+670760.00 Floating point	COV from KNX setp adj.

¹⁾ See Section 1.4.3, page 13.

⁴⁾ See Section 1.4.3, page 14.

⁵⁾ See Section 1.5.1, page 16, Standard S-mode DP.

RMU7x0B Step 3: Inputs and outputs, Basic type P

S-mode DPs operated as input and output.

- Input: For operation using external device via KNX, Synco controller RMU7x0B Step 3 receives the values of the S-mode DPs.
- Output: For operation from the Synco controller RMU7x0B Step 3, the S-mode DP values are sent via KNX (synchronization of external unit).

Name in ETS	DP active	Flags					Data point type KNX				Value range	RMU7x0B rec., sends:
		C	R	W	T	U	ID	DPT_Name	Format	Unit		
[Controller 1] Limit value high	Plant type = B.type P	1	1	1	1	1	9.001	_Value_Temp	2 Bytes F ₁₆	°C	-273.00...+670760.00 Floating point	COV from KNX setp adj.
[Controller 1] Limit value low		1	1	1	1	1	9.001	_Value_Temp	2 Bytes F ₁₆	°C	-273.00...+670760.00 Floating point	COV from KNX setp adj.
[Controller 2...3] Precomfort setpoint high [°C]	P and [Ctr. 2...3] Main ctrd variab. unit = Temp.	1	1	1	1	1	9.001	_Value_Temp	2 Bytes F ₁₆	°C	-273.00...+670760.00 Floating point	COV from KNX setp adj.
[Controller 2...3] Comfort setpoint high [°C]		1	1	1	1	1	9.001	_Value_Temp	2 Bytes F ₁₆	°C	-273.00...+670760.00 Floating point	COV from KNX setp adj.
[Controller 2...3] Comfort setpoint low [°C]		1	1	1	1	1	9.001	_Value_Temp	2 Bytes F ₁₆	°C	-273.00...+670760.00 Floating point	COV from KNX setp adj.
[Controller 2...3] Precomfort setpoint low [°C]		1	1	1	1	1	9.001	_Value_Temp	2 Bytes F ₁₆	°C	-273.00...+670760.00 Floating point	COV from KNX setp adj.

RMU7x0B Step 3: Inputs, Basic type P

Name in ETS	DP active	Flags					Data point type KNX				Value range	RMU7xB receives:
		C	R	W	T	U	ID	DPT_Name	Format	Unit		
Confirm faults	Always	1	0	1	0	1	1.016	_Ack	1 Bit B ₁	- - -	0 = No action 1 = Acknowledge / bestätigen	Event from KNX contact. No timeout monitoring.
Reset faults	Always	1	0	1	0	1	1.015	_Reset	1 Bit B ₁	- - -	0 = No action 1 = Reset / zurücksetzen	Event from KNX contact. No timeout monitoring.
Fault transmission (enable/disable)	Always	1	0	1	0	1	1.003	_Enable	1 Bit B ₁	- - -	0 = Disable / sperren 1 = Enable / freigeben (default)	Event from KNX contact. "Disable" time-out monit 24 h.
Outside temperature	Outs.temp. = Receive	1	0	1	0	1	9.001	_Value_Temp	2 Bytes F ₁₆	°C	-273.00...+670760.00 Floating point	COV from KNX sensor.
[Controller 1] Request input	Plant type = B.type P	1	0	1	0	1	1.001	_Switch	1 Bit B ₁	- - -	0 = Off / No request 1 = On / Request	Event, heart-beat 15 min.
Heating/cooling changeover	H/C ch'over = Receive	1	0	1	0	1	1.100	_Heat/Cool	1 Bit B ₁	- - -	0 = Cooling 1 = Heating (default)	Event, heart-beat 15 min.

RMU7x0B Step 3: Outputs, Basic type P

Name in ETS	DP active	Flags					Data point type KNX				Value range	RMU7x0B sends:
		C	R	W	T	U	ID	DPT_Name	Format	Unit		
Fault information	Always	1	0	0	1	0	219.001	_AlarmInfo ²⁾	6 Bytes strukt.	---	[0]...255 = Log no. [RMU = 0] [0...2]...255 = Alarm priority [0...14]...255 = Application area [0...4]...255 = Error class [0...15]...63 = Alarm attributes [0...7] = Fault state	Heartbeat 30 min.
Fault state (normal/faulty)	Always	1	0	0	1	0	1.005	_Alarm	1 Bit B ₁	---	0 = No alarm (default) 1 = Alarm / faulty	Event, heart- beat 30 min.
Outside temperature ⁷⁾	Outs.temp. = Transmit	1	0	0	1	0	9.001	_Value_Temp	2 Bytes F ₁₆	°C	-273.00...+670760.00 Floating point	COV, heart- beat 15 min.
[Controller 1] Current supply air temp setpoint ⁶⁾	Plant type = B.type P]	1	0	0	1	0	9.001	_Value_Temp	2 Bytes F ₁₆	°C	-273.00...+670760.00 Floating point	COV, heart- beat 15 min.
[Controller 2...3] Current setpoint [°C] ⁶⁾	P and [Ctr. 2...3] Main ctrd variab. unit = Temp.	1	0	0	1	0	9.001	_Value_Temp	2 Bytes F ₁₆	°C	-273.00...+670760.00 Floating point	COV, heart- beat 15 min.
[Time switch 1] State	P and [Time swi. 1] State = Yes	1	0	0	1	0	1.001	_Switch	1 Bit B ₁	---	0 = Off 1 = On	Event, heart- beat 15 min.
[Time switch 2] State	[Time swi. 2] State = Yes	1	0	0	1	0	1.001	_Switch	1 Bit B ₁	---	0 = Off 1 = On	Event, heart- beat 15 min.
[Logic 1...4] State	[Logic X] State = Yes	1	0	0	1	0	1.001	_Switch	1 Bit B ₁	---	0 = Off 1 = On	Event, heart- beat 15 min.
Heating/cooling changeover	H/C ch'over = Transmit	1	0	0	1	0	1.100	_Heat/Cool	1 Bit B ₁	---	0 = Cooling 1 = Heating (default)	Event, heart- beat 15 min.

²⁾ See Section 1.4.3, page 14.

⁶⁾ See Section 1.5.1, page 16, Out of service.

⁷⁾ See Section 1.5.1, page 16, S-mode DP sends 0.

2.4.3 Basic type C, Chilled water precontrol

RMU7x0B Step 3: Inputs / Outputs, Basic type C

Name in ETS	DP active	Flags					Data point type KNX				Value range	RMU receives or sends:
		C	R	W	T	U	ID	DPT_Name	Format	Unit		
System time (input) System time (output)	Always ⁵⁾	1	0	1	1	1	19.001	_DateTime	8 bytes struct.	YYYY MM DD d hh mm ss ---	1900...2155 = Year 1...12 = Month 1...31 = Day of month 1...7 = Monday - Sunday 0...23 = Hours 0...59 = Minutes 0...59 = Seconds Status bits ¹⁾	From KNX system time source or to KNX system time receiver cycl. 10 min.
Date (input) Date (output)	Always	1	0	1	1	1	11.001	_Date	3 bytes struct.	DD MM YY	1...31 = Day of month 1...12 = Month 00...99 = Year ⁴⁾	From KNX date source or to KNX date receiver cycl. 10 min.
Time of day (input) Time of day (output)	Always	1	0	1	1	1	10.001	_TimeOfDay	3 bytes struct.	d hh mm ss	1...7 = Monday - Sunday 0...23 = Hours 0...59 = Minutes 0...59 = Seconds	From KNX time source or to KNX time receiver cycl. 10 min.

¹⁾ See Section 1.4.3, page 13.

⁴⁾ See Section 1.4.3, page 14.

⁵⁾ See Section 1.5.1, page 16, Standard S-mode DP.

RMU7x0B Step 3: Inputs and outputs, Basic type C

S-mode DPs operated as input and output.

- Input: For operation using external device via KNX, Synco controller RMU7x0B Step 3 receives the values of the S-mode DPs.
- Output: For operation from the Synco controller RMU7x0B Step 3, the S-mode DP values are sent via KNX (synchronization of external unit).

Name in ETS	DP active	Flags					Data point type KNX				Value range	RMU7x0B rec., sends:
		C	R	W	T	U	ID	DPT_Name	Format	Unit		
[Controller 1] Heating flow setpoint	Plant type = B.type C	1	1	1	1	1	9.001	_Value_Temp	2 Bytes F ₁₆	°C	-273.00...+670760.00 Floating point	COV from KNX setp adj.
[Controller 1] Chilled water flow setpoint		1	1	1	1	1	9.001	_Value_Temp	2 Bytes F ₁₆	°C	-273.00...+670760.00 Floating point	COV from KNX setp adj.
[Controller 2...3] Precomfort setpoint high [°C]	C and [Ctr. 2...3] Main ctrd variab. unit = Temp.	1	1	1	1	1	9.001	_Value_Temp	2 Bytes F ₁₆	°C	-273.00...+670760.00 Floating point	COV from KNX setp adj.
[Controller 2...3] Comfort setpoint high [°C]		1	1	1	1	1	9.001	_Value_Temp	2 Bytes F ₁₆	°C	-273.00...+670760.00 Floating point	COV from KNX setp adj.
[Controller 2...3] Comfort setpoint low [°C]		1	1	1	1	1	9.001	_Value_Temp	2 Bytes F ₁₆	°C	-273.00...+670760.00 Floating point	COV from KNX setp adj.
[Controller 2...3] Precomfort setpoint low [°C]		1	1	1	1	1	9.001	_Value_Temp	2 Bytes F ₁₆	°C	-273.00...+670760.00 Floating point	COV from KNX setp adj.

RMU7x0B Step 3: Inputs, Basic type C

Name in ETS	DP active	Flags					Data point type KNX				Value range	RMU7xB receives:
		C	R	W	T	U	ID	DPT_Name	Format	Unit		
Confirm faults	Always	1	0	1	0	1	1.016	_Ack	1 Bit B ₁	- - -	0 = No action 1 = Acknowledge / bestätigen	Event from KNX contact. No timeout monitoring.
Reset faults	Always	1	0	1	0	1	1.015	_Reset	1 Bit B ₁	- - -	0 = No action 1 = Reset / zurücksetzen	Event from KNX contact. No timeout monitoring.
Fault transmission (enable/disable)	Always	1	0	1	0	1	1.003	_Enable	1 Bit B ₁	- - -	0 = Disable / sperren 1 = Enable / freigeben (default)	Event from KNX contact. "Disable" time-out monit 24 h.
Outside temperature	Outs.temp. = Receive	1	0	1	0	1	9.001	_Value_Temp	2 Bytes F ₁₆	°C	-273.00...+670760.00 Floating point	COV from KNX sensor.
[Controller 1] Request input	Plant type = B.type C	1	0	1	0	1	1.001	_Switch	1 Bit B ₁	- - -	0 = Off / No request 1 = On / Request	Event, heart-beat 15 min.
Heating/cooling changeover	H/C ch'over = Receive	1	0	1	0	1	1.100	_Heat/Cool	1 Bit B ₁	- - -	0 = Cooling 1 = Heating (default)	Event, heart-beat 15 min.

RMU7x0B Step 3: Outputs, Basic type C

Name in ETS	DP active	Flags					Data point type KNX				Value range	RMU7x0B sends:
		C	R	W	T	U	ID	DPT_Name	Format	Unit		
Fault information	Always	1	0	0	1	0	219.001	_AlarmInfo ²⁾	6 Bytes strukt.	---	[0]...255 = Log no. [RMU = 0] [0...2]...255 = Alarm priority [0...14]...255 = Application area [0...4]...255 = Error class [0...15]...63 = Alarm attributes [0...7] = Fault state	Heartbeat 30 min.
Fault state (normal/faulty)	Always	1	0	0	1	0	1.005	_Alarm	1 Bit B ₁	---	0 = No alarm (default) 1 = Alarm / faulty	Event, heart- beat 30 min.
Outside temperature ⁷⁾	Outs.temp. = Transmit	1	0	0	1	0	9.001	_Value_Temp	2 Bytes F ₁₆	°C	-273.00...+670760.00 Floating point	COV, heart- beat 15 min.
[Controller 1] Current setpoint ⁶⁾	Plant type = B.type C]	1	0	0	1	0	9.001	_Value_Temp	2 Bytes F ₁₆	°C	-273.00...+670760.00 Floating point	COV, heart- beat 15 min.
[Controller 2...3] Current setpoint [°C] ⁶⁾	C and [Ctr. 2...3] Main ctrd variab. unit = Temp.	1	0	0	1	0	9.001	_Value_Temp	2 Bytes F ₁₆	°C	-273.00...+670760.00 Floating point	COV, heart- beat 15 min.
[Time switch 1] State	C and [Time swi. 1] State = Yes	1	0	0	1	0	1.001	_Switch	1 Bit B ₁	---	0 = Off 1 = On	Event, heart- beat 15 min.
[Time switch 2] State	[Time swi. 2] State = Yes	1	0	0	1	0	1.001	_Switch	1 Bit B ₁	---	0 = Off 1 = On	Event, heart- beat 15 min.
[Logic 1...4] State	[Logic X] State = Yes	1	0	0	1	0	1.001	_Switch	1 Bit B ₁	---	0 = Off 1 = On	Event, heart- beat 15 min.
Heating/cooling changeover	H/C ch'over = Transmit	1	0	0	1	0	1.100	_Heat/Cool	1 Bit B ₁	---	0 = Cooling 1 = Heating (default)	Event, heart- beat 15 min.

²⁾ See Section 1.4.3, page 14.

⁶⁾ See Section 1.5.1, page 16, Out of service.

⁷⁾ See Section 1.5.1, page 16, S-mode DP sends 0.

2.4.4 Basic type U, Universal controller

RMU7x0B Step 3: Inputs / Outputs, Basic type U

Name in ETS	DP active	Flags					Data point type KNX				Value range	RMU receives or sends:
		C	R	W	T	U	ID	DPT_Name	Format	Unit		
System time (input) System time (output)	Always ⁵⁾	1	0	1	1	1	19.001	_DateTime	8 bytes struct.	YYYY MM DD d hh mm ss ---	1900...2155 = Year 1...12 = Month 1...31 = Day of month 1...7 = Monday - Sunday 0...23 = Hours 0...59 = Minutes 0...59 = Seconds Status bits ¹⁾	From KNX system time source or to KNX system time receiver cycl. 10 min.
Date (input) Date (output)	Always	1	0	1	1	1	11.001	_Date	3 bytes struct.	DD MM YY	1...31 = Day of month 1...12 = Month 00...99 = Year ⁴⁾	From KNX date source or to KNX date receiver cycl. 10 min.
Time of day (input) Time of day (output)	Always	1	0	1	1	1	10.001	_TimeOfDay	3 bytes struct.	d hh mm ss	1...7 = Monday - Sunday 0...23 = Hours 0...59 = Minutes 0...59 = Seconds	From KNX time source or to KNX time receiver cycl. 10 min.

¹⁾ See Section 1.4.3, page 13.

⁴⁾ See Section 1.4.3, page 14.

⁵⁾ See Section 1.5.1, page 16, Standard S-mode DP.

RMU7x0B Step 3: Inputs and outputs, Basic type U

S-mode DPs operated as input and output.

- Input: For operation using external device via KNX, Synco controller RMU7x0B Step 3 receives the values of the S-mode DPs.
- Output: For operation from the Synco controller RMU7x0B Step 3, the S-mode DP values are sent via KNX (synchronization of external unit).

Name in ETS	DP active	Flags					Data point type KNX				Value range	RMU7x0B rec., sends
		C	R	W	T	U		DPT_Name	Format	Unit		
Room optg mode: Preselection	Plant type = B.type U	1	1	1	1	1	20.102	_HVACMode	1 Byte N ₈	Enum.	0 = Auto 1 = Comfort 2 = Precomfort (Standby) 3 = Economy 4 = Protection (BldgProtect) 5...255 Reserve	Event from KNX preselect operation (device/progr)
[Controller 2...3] Precomfort setpoint high [°C]	U and [Ctr. 2...3] Main ctrd variab. unit = Temp.	1	1	1	1	1	9.001	_Value_Temp	2 Bytes F ₁₆	°C	-273.00...+670760.00 Floating point	COV from KNX setp adj.
[Controller 2...3] Comfort setpoint high [°C]		1	1	1	1	1	9.001	_Value_Temp	2 Bytes F ₁₆	°C	-273.00...+670760.00 Floating point	COV from KNX setp adj.
[Controller 2...3] Comfort setpoint low [°C]		1	1	1	1	1	9.001	_Value_Temp	2 Bytes F ₁₆	°C	-273.00...+670760.00 Floating point	COV from KNX setp adj.
[Controller 2...3] Precomfort setpoint low [°C]		1	1	1	1	1	9.001	_Value_Temp	2 Bytes F ₁₆	°C	-273.00...+670760.00 Floating point	COV from KNX setp adj.

RMU7x0B Step 3: Inputs, Basic type U

Name in ETS	DP active	Flags					Data point type KNX				Value range	RMU7xB receives:
		C	R	W	T	U	ID	DPT_Name	Format	Unit		
Confirm faults	Always	1	0	1	0	1	1.016	_Ack	1 Bit B ₁	- - -	0 = No action 1 = Acknowledge / bestätigen	Event from KNX contact. No timeout monitoring.
Reset faults	Always	1	0	1	0	1	1.015	_Reset	1 Bit B ₁	- - -	0 = No action 1 = Reset / zurücksetzen	Event from KNX contact. No timeout monitoring.
Fault transmission (enable/disable)	Always	1	0	1	0	1	1.003	_Enable	1 Bit B ₁	- - -	0 = Disable / sperren 1 = Enable / freigeben (default)	Event from KNX contact. "Disable" time-out monit 24 h.
Outside temperature	Outs.temp = Receive	1	0	1	0	1	9.001	_Value_Temp	2 Bytes F ₁₆	°C	-273.00...+670760.00 Floating point	COV from KNX sensor.
Room optg mode: Time switch	U and Time swi. operation = Slave	1	0	1	0	1	20.102	_HVACMode	1 Byte N ₈	Enum.	0 = Not used 1 = Comfort 2 = Precomfort (Standby) 3 = Economy 4 = Protection (BldgProtect) 5...255 Reserve	Event from KNX operation (device/progr). Timeout monit 31 min.
Heating/cooling changeover	H/C ch'over = Receive	1	0	1	0	1	1.100	_Heat/Cool	1 Bit B ₁	- - -	0 = Cooling 1 = Heating (default)	Event, heart-beat 15 min.

RMU7x0B Step 3: Outputs, Basic type U

Name in ETS	DP active	Flags					Data point type KNX				Value range	RMU7x0B sends:
		C	R	W	T	U	ID	DPT_Name	Format	Unit		
Fault information	Always	1	0	0	1	0	219.001	_AlarmInfo ²⁾	6 Bytes strukt.	---	[0]...255 = Log no. [RMU = 0] [0...2]...255 = Alarm priority [0...14]...255 = Application area [0...4]...255 = Error class [0...15]...63 = Alarm attributes [0...7] = Fault state	Heartbeat 30 min.
Fault state (normal/faulty)	Always	1	0	0	1	0	1.005	_Alarm	1 Bit B ₁	---	0 = No alarm (default) 1 = Alarm / faulty	Event, heart- beat 30 min.
Outside temperature ⁷⁾	Outs.temp. = Transmit	1	0	0	1	0	9.001	_Value_Temp	2 Bytes F ₁₆	°C	-273.00...+670760.00 Floating point	Event, heart- beat 30 min.
Room optg mode: Time switch	U and Time swi. operation = Master	1	0	0	1	0	20.102	_HVACMode	1 Byte N ₈	Enum.	0 = Not used 1 = Komfort 2 = Prekomfort (Standby) 3 = Economy 4 = Schutzbetrieb (BldgProtect) 5...255 Reserve	COV, heart- beat 15 min.
Room optg mode: State	Plant type = B.type U	1	0	0	1	0	20.102	_HVACMode	1 Byte N ₈	Enum.	0 = Not used 1 = Komfort 2 = Prekomfort (Standby) 3 = Economy 4 = Schutzbetrieb (BldgProtect) 5...255 Reserve	Event, heart- beat 15 min.
[Controller 1...3] Current setpoint [°C] ⁶⁾	U and [Ctr. 2...3] Main ctrd variab. unit = Temp.	1	0	0	1	0	9.001	_Value_Temp	2 Bytes F ₁₆	°C	-273.00...+670760.00 Floating point	COV, heart- beat 15 min.

²⁾ See Section 1.4.3, page 14.

⁶⁾ See Section 1.5.1, page 16, Out of service.

⁷⁾ See Section 1.5.1, page 16, S-mode DP sends 0.

RMU7x0B Step 3: Outputs, Basic type U (continued)

Name in ETS	DP active	Flags					Data point type KNX				Value range	RMU7x0B sends:
		C	R	W	T	U	ID	DPT_Name	Format	Unit		
[Time switch 2] State	[Time swi. 2] State = Yes	1	0	0	1	0	1.001	_Switch	1 Bit B ₁	- - -	0 = Off 1 = On	COV, heart-beat 15 min.
[Logic 1...4] State	[Logic X] State = Yes	1	0	0	1	0	1.001	_Switch	1 Bit B ₁	- - -	0 = Off 1 = On	Event, heart-beat 15 min.
Heating/cooling changeover	H/C ch'over = Transmit	1	0	0	1	0	1.100	_Heat/Cool	1 Bit B ₁	- - -	0 = Cooling 1 = Heating (default)	Event, heart-beat 15 min.

2.4.5 Terminal inputs RMU7x0B Step 3 as reception objects

RMU7x0B Step 3: Terminal inputs as reception objects, all Basic types

- Universal input N.X1...N.X8, parameterizable for analog input value [°C], [% rH] etc. or for digital input value [0/1]. The value can be received in S-mode via KNX.

Name in ETS	DP	Flags					Data point type KNX				Value range	RMU7x0B receives:
		C	R	W	T	U	ID	DPT_Name	Format	Unit		
Input N.X_ [°C]	Rec. object	1	0	1	0	1	9.001	_Value_Temp	2 bytes F ₁₆	°C	-273.00...+670760.00 Floating point	Event, no timeout monitoring
Input N.X_ [% rH]	Rec. object	1	0	1	0	1	9.007	_Value_Humidity	2 bytes F ₁₆	%	[0...670760]	Event, no timeout monitoring
Input N.X_ [0...100%]	Rec. object	1	0	1	0	1	5.001	_Scaling	8 bit U ₈	%	[0...100] Resolution 0.4%	Event, no timeout monitoring
Input N.X_ [0...255%]	Rec. object	1	0	1	0	1	5.004	_Percent	8 bit U ₈	%	[0...255] Resolution 1%	Event, no timeout monitoring.
Input N.X_ [m/s]	Rec. object	1	0	1	0	1	14.065	_Value_Speed	4 bytes F ₃₂	m/s	IEEE 754 floating [0...255].[0...8388607]	Event, no timeout monitoring
Input N.X_ [m/s]	Rec. object	1	0	1	0	1	9.005	_Value_Wsp	2 bytes F ₁₆	m/s	[0...670760]	Event, no timeout monitoring
Input N.X_ [Pa]	Rec. object	1	0	1	0	1	14.058	_Value_Pressure	4 bytes F ₃₂	Pa = N/m ²	IEEE 754 floating [0...255].[0...8388607]	Event, no timeout monitoring.
Input N.X_ [Pa]	Rec. object	1	0	1	0	1	9.006	_Value_Pres	2 bytes F ₁₆	Pa = N/m ²	[0...670760]	Event, no timeout monitoring.
Input N.X_ [ppm]	Rec. object	1	0	1	0	1	9.008	_Value_AirQuality	2 bytes F ₁₆	ppm	[0...670760]	Event, no timeout monitoring.
Input N.X_ [0/1]	Rec. object	1	0	1	0	1	1.001	_Switch	1 bit B ₁	- - -	0 = Off 1 = On	Event, no timeout monitoring.

Notes:

- Receipt of an S-mode DP via input N.X_ values, that is outside the range limits ("Value high" and "Value low"), is limited by them, e.g. air velocity >20 [m/s] are limited to 20 [m/s] (when "Value high" = 20 [m/s]).
- The following priority applies to communication of data (e.g. sensor values) in S-mode and LTE mode (both modes possible at the same): Value in S-mode before value in LTE mode before terminal input value.

2.4.6 Terminal inputs RMU7x0B Step 3 as transmission objects

RMU7x0B Step 3: Terminal inputs as transmission objects, all Basic types

- Universal inputs N.X1...N.X8 can be parameterized for analog value [°C], [% rH], etc., or for digital value [0/1]. The value can be sent in S-mode via KNX.

Name in ETS	DP ⁷⁾	Flags					Data point type KNX				Value range	RMU7x0B sends:
		C	R	W	T	U	ID	DPT_Name	Format	Unit		
Input N.X_ [°C]	Trans. object	1	1	0	1	0	9.001	_Value_Temp	2 bytes F ₁₆	°C	-273.00...+670760.00 Floating point	COV, heart-beat 15 min.
Input N.X_ [% rH]	Trans. object	1	1	0	1	0	9.007	_Value_Humidity	2 bytes F ₁₆	%	[0...670760]	COV, heart-beat 15 min.
Input N.X_ [0...100%]	Trans. object	1	1	0	1	0	5.001	_Scaling	8 bit U ₈	%	[0...100] Resolution 0.4%	COV, heart-beat 15 min.
Input N.X_ [0...255%]	Trans. object	1	1	0	1	0	5.004	_Percent	8 bit U ₈	%	[0...255] Resolution 1%	COV, heart-beat 15 min.
Input N.X_ [m/s]	Trans. object	1	1	0	1	0	14.065	_Value_Speed	4 bytes F ₃₂	m/s	IEEE 754 floating [0...255].[0...8388607]	COV, heart-beat 15 min.
Input N.X_ [m/s]	Trans. object	1	1	0	1	0	9.005	_Value_Wsp	2 bytes F ₁₆	m/s	[0...670760]	COV, heart-beat 15 min.
Input N.X_ [Pa]	Trans. object	1	1	0	1	0	14.058	_Value_Pressure	4 bytes F ₃₂	Pa = N/m ²	IEEE 754 floating [0...255].[0...8388607]	COV, heart-beat 15 min.
Input N.X_ [Pa]	Trans. object	1	1	0	1	0	9.006	_Value_Pres	2 bytes F ₁₆	Pa = N/m ²	[0...670760]	COV, heart-beat 15 min.
Input N.X_ [ppm]	Trans. object	1	1	0	1	0	9.008	_Value_AirQuality	2 bytes F ₁₆	ppm	[0...670760]	COV, heart-beat 15 min.
Input N.X_ [0/1]	Trans. object	1	1	0	1	0	1.001	_Switch	1 bit B ₁	- - -	0 = Off 1 = On	Event, heart-beat 15 min.

⁷⁾ See Section 1.5.1, page 16, S-mode DP sends 0.

2.4.7 Terminal outputs RMU7x0B Step 3 as transmission objects

RMU7x0B Step 3: Terminal outputs as transmission objects, all Basic types

- The relay outputs N.Q1...N.Q7, parameterized for digital output value [0/1]. The value can be sent in S-mode via KNX.

Name in ETS	DP ⁷⁾	Flags					Data point type KNX				Value range	RMU7x0B sends:
		C	R	W	T	U	ID	DPT_Name	Format	Unit		
Output N.Q_	Trans. object	1	1	0	1	0	1.001	_Switch	1 bit B ₁	- - -	0 = Off 1 = On	Event, heart-beat 15 min.

- Analog outputs N.Y1...N.Y4, parameterized for analog output value [0...100]. The value can be sent in S-mode via KNX.

Name in ETS	DP ⁷⁾	Flags					Data point type KNX				Value range	RMU7x0B sends:
		C	R	W	T	U	ID	DPT_Name	Format	Unit		
Output N.Y_	Trans. object	1	1	0	1	0	5.001	_Scaling	8 bit U ₈	%	[0...100] Resolution 0.4%	COV, heart-beat 15 min.

⁷⁾ See Section 1.5.1, page 16, S-mode DP sends 0.

2.4.8 Terminal inputs as reception objects, Extension modules RMZ78x

RMU7x0B Step 3: Terminal inputs as reception objects, Extension modules RMZ78x

- Universal inputs A__X1...A__X8, parameterized for analog values [°C], [% rH] etc., or digital value [0/1]. The value can be received in S-mode via KNX.

Name in ETS	DP	Flags					Data point type KNX				Value range	RMU7x0B receives:
		C	R	W	T	U	ID	DPT_Name	Format	Unit		
Input A__X_ [°C]	Rec. object	1	0	1	0	1	9.001	_Value_Temp	2 bytes F ₁₆	°C	-273.00...+670760.00 Floating point	Event, no timeout monitoring
Input A__X_ [% rH]	Rec. object	1	0	1	0	1	9.007	_Value_Humidity	2 bytes F ₁₆	%	[0...670760]	Event, no timeout monitoring
Input A__X_ [0...100%]	Rec. object	1	0	1	0	1	5.001	_Scaling	8 bit U ₈	%	[0...100] Resolution 0.4%	Event, no timeout monitoring
Input A__X_ [0...255%]	Rec. object	1	0	1	0	1	5.004	_Percent	8 bit U ₈	%	[0...255] Resolution 1%	Event, no timeout monitoring.
Input A__X_ [m/s]	Rec. object	1	0	1	0	1	14.065	_Value_Speed	4 bytes F ₃₂	m/s	IEEE 754 floating [0...255].[0...8388607]	Event, no timeout monitoring
Input A__X_ [m/s]	Rec. object	1	0	1	0	1	9.005	_Value_Wsp	2 bytes F ₁₆	m/s	[0...670760]	Event, no timeout monitoring
Input A__X_ [Pa]	Rec. object	1	0	1	0	1	14.058	_Value_Pressure	4 bytes F ₃₂	Pa = N/m ²	IEEE 754 floating [0...255].[0...8388607]	Event, no timeout monitoring
Input A__X_ [Pa]	Rec. object	1	0	1	0	1	9.006	_Value_Pres	2 bytes F ₁₆	Pa = N/m ²	[0...670760]	Event, no timeout monitoring
Input A__X_ [ppm]	Rec. object	1	0	1	0	1	9.008	_Value_AirQuality	2 bytes F ₁₆	ppm	[0...670760]	Event, no timeout monitoring
Input A__X_ [0/1]	Rec. object	1	0	1	0	1	1.001	_Switch	1 bit B ₁	- - -	0 = Off 1 = On	Event, no timeout monitoring

- Extension modules RMZ78x with universal inputs as reception objects

Input A5.X1...A5.X8	RMZ785
Input A7(1).X1...A7(1).X4	RMZ787(1)
Input A7(2).X1...A7(2).X4	RMZ787(2)
Input A8(1).X1...A8(1).X4	RMZ788(1)
Input A8(2).X1...A8(2).X4	RMZ788(2)

2.4.9 Terminal inputs as transmission objects, Extension modules RMZ78x

RMU7x0B Step 3: Terminal inputs as transmission objects, Extension modules RMZ78x

- Universal inputs A_{...}X1...A_{...}X8, can be parameterized for analog value [°C], [% rH] etc., or for digital value [0/1]. The value can be sent in S-mode via KNX.

Name in ETS	DP ⁷⁾	Flags					Data point type KNX				Value range	RMU7x0B sends:
		C	R	W	T	U	ID	DPT_Name	Format	Unit		
Input A _{...} X _{...} [°C]	Trans. object	1	1	0	1	0	9.001	_Value_Temp	2 bytes F ₁₆	°C	-273.00...+670760.00 Floating point	COV, heart-beat 15 min.
Input A _{...} X _{...} [% rH]	Trans. object	1	1	0	1	0	9.007	_Value_Humidity	2 bytes F ₁₆	%	[0...670760]	COV, heart-beat 15 min.
Input A _{...} X _{...} [0...100%]	Trans. object	1	1	0	1	0	5.001	_Scaling	8 bit U ₈	%	[0...100] Resolution 0.4%	COV, heart-beat 15 min.
Input A _{...} X _{...} [0...255%]	Trans. object	1	1	0	1	0	5.004	_Percent	8 bit U ₈	%	[0...255] Resolution 1%	COV, heart-beat 15 min.
Input A _{...} X _{...} [m/s]	Trans. object	1	1	0	1	0	14.065	_Value_Speed	4 bytes F ₃₂	m/s	IEEE 754 floating [0...255].[0...8388607]	COV, heart-beat 15 min.
Input A _{...} X _{...} [m/s]	Trans. object	1	1	0	1	0	9.005	_Value_Wsp	2 bytes F ₁₆	m/s	[0...670760]	COV, heart-beat 15 min.
Input A _{...} X _{...} [Pa]	Trans. object	1	1	0	1	0	14.058	_Value_Pressure	4 bytes F ₃₂	Pa = N/m ²	IEEE 754 floating [0...255].[0...8388607]	COV, heart-beat 15 min.
Input A _{...} X _{...} [Pa]	Trans. object	1	1	0	1	0	9.006	_Value_Pres	2 bytes F ₁₆	Pa = N/m ²	[0...670760]	COV, heart-beat 15 min.
Input A _{...} X _{...} [ppm]	Trans. object	1	1	0	1	0	9.008	_Value_AirQuality	2 bytes F ₁₆	ppm	[0...670760]	COV, heart-beat 15 min.
Input A _{...} X _{...} [0/1]	Trans. object	1	1	0	1	0	1.001	_Switch	1 bit B ₁	- - -	0 = Off 1 = On	Event, heart-beat 15 min.

- Extension modules RMZ78x with universal inputs as transmission objects

⁷⁾ See Section 1.5.1, page 16, S-mode DP sends 0

Input A5.X1...A5.X8	RMZ785
Input A7(1).X1...A7(1).X4	RMZ787(1)
Input A7(2).X1...A7(2).X4	RMZ787(2)
Input A8(1).X1...A8(1).X4	RMZ788(1)
Input A8(2).X1...A8(2).X4	RMZ788(2)

2.4.10 Terminal outputs as transmission objects, Extension modules RMZ78x

RMU7x0B Step 3: Terminal outputs as transmission objects, Extension modules RMZ78x

- Relay outputs A__.Q_, parameterized for digital output value [0/1]. The value can be sent in S-mode via KNX.

Name in ETS	DP ⁷⁾	Flags					Data point type KNX				Value range	RMU7x0B sends:
		C	R	W	T	U	ID	DPT Name	Format	Unit		
Output A__.Q_	Trans. object	1	1	0	1	0	1.001	_Switch	1 bit B ₁	- - -	0 = Off 1 = On	Event, heart-beat 15 min.

- Extension modules RMZ78x with relay outputs as transmission objects

Output A7(1).Q1...A7(1).Q5	RMZ787(1) without Q4
Output A7(2).Q1...A7(2).Q5	RMZ787(2) without Q4
Output A8(1).Q1, A8(1).Q5	RMZ788(1)
Output A8(2).Q1, A8(2).Q5	RMZ788(2)

- Analog outputs A__.Y_, parameterized for analog output value [0...100]. The value can be sent in S-mode via KNX.

Name in ETS	DP ⁷⁾	Flags					Data point type KNX				Value range	RMU7x0B sends:
		C	R	W	T	U	ID	DPT Name	Format	Unit		
Output A__.Y_	Trans. object	1	1	0	1	0	5.001	_Scaling	8 bit U ₈	%	[0...100] Resolution 0.4%	COV, heart-beat 15 min.

- Extension modules RMZ78x with analog outputs as transmission objects

Output A8(1).Y1, A8(1).Y2	RMZ788(1)
Output A8(2).Y1, A8(2).Y2	RMZ788(2)

Note: Max. 4 Extension modules RMZ78x (same or different types) are allowed per Universal controller RMU7x0B Step 3.

⁷⁾ See Section 1.5.1, page 16, S-mode DP sends 0.

3 RMH760, RMH760B Heating controller

3.1 Overview

Brief description

The Synco 700 heating controller RMH760 is used either as heating circuit or primary controller.

The Synco 700 heating controller series B, i.e. RMH760B, in addition can be deployed in remote heating plants.

The controller types RMU760 and RMU760B are identical with regard to design and dimensions.



Documentation

Heating controller
RMH760

Data sheet	Modular heating controller RMH760	N3131
Basic documentation	Modular heating controller RMH760	P3131

Heating controller
RMH760B

Data sheet	Modular heating controller RMH760B	N3133
Basic documentation	Modular heating controller RMH760B	P3133

Number of S-mode DPs

	RMH760	RMH760B
Inputs / Outputs	3	3
Inputs and Outputs	0	17
Inputs	30	26
Outputs	17	121

3.1.1 RMH760 Heating controller

DP in basic type column

The tables in Section 3.2, column **DP in basic type**, show the basic types with the data point communicating in S-mode. For more information on the basic types, refer to the documentation on basics P3131.

Basic types

The RMH760 heating controller is delivered with 28 basic types. The basic types correspond to combinations of plants and partial plants (see next page).

Basic types n-x

0-x	Heat consumers
1-x	Primary control for internal and external heat consumers
2-x	Primary control for external heat consumers
3-x	Boiler temperature control
4-x	Boiler temperature control with maintained boiler return temperature

Basic types x-n

x-1	DHW heating
x-2	Control of 1 heating circuit
x-3	Control of 1 heating circuit plus DHW heating
x-4	Control of 2 heating circuits
x-5	Control of 2 heating circuits plus DHW heating

3.1.2 RMH760B Heating controller

DP in FB column

The tables in Section 3.3, column **DP in FB**, show the function blocks with the data point communicating in S-mode. For more information on the function blocks, refer to the documentation on basics P3133.

Indication:

Always
All
MR Main controller
PC Primary controller
B Boiler
HC 1...3 Heating circuit 1...3
DHW DHW heating

Meaning:

Standard S-mode DP
S-mode in all function blocks
S-mode in FB "Main controller"
S-mode in FB "Primary controller"
S-mode in FB "Boiler"
S-mode in FB "Heating circuit 1...3"
S-mode in FB "Domestic hot water heating"

Plant types

The RMH760B heating controller is delivered with 41 plant types. The plant types are based on function blocks (FB). You can retroactively change or extend the supplementary configuration for each plant type.

Plant type designation

A plant type comprises H and a two-digit number e.g. H3-1.

- The first digit specifies the type of heat generation or distribution.
- The second digit specifies the type and number of internal consumers.

1st digit for plant type: Heat generation / distribution		Function block FB	2nd digit for plant type: Consumer		Function block FB
0	None	--	0	None.	--
1	Primary controller to remote heating	Main controller	1	DHW heating	DHW
2	Primary controller only for external consumers	Primary controller	2	Control of 1 heating circuit	Heating circuit 1
3	Heat generator	Boiler	3	Control of 1 heating circuit plus DHW heating	DHW and heat. circ. 1
4	Heat generator with return temperature control	Boiler	4	Control of 2 heating circuits	Heating circuit 2
5	Consumer to remote heating with storage tank charge and mixing valve control as preset DHW type	--	5	Control of 2 heating circuits plus DHW heating	DHW and heating circuit 2
6	Consumer to remote heating with direct DHW heating as preset DHW type	--	6	Control of 3 heating circuits	Heating circuit 3
			7	Control of 3 heating circuits plus DHW heating	DHW and heating circuit 3

Example,
plant type H3-1

Plant type H3-1 contains function blocks "Boiler" and "domestic hot water heating" (short DHW).

Plant type	Description	Plant diagram
H3-1	<p>N1: Boiler temperature control.</p> <p>A3: DHW circuit with mixing valve controlled primary storage tank and charging pump (DHW 2).</p>	

Basic type H

Basic type H is not preconfigured, i.e. no inputs or outputs are preconfigured. Choose this type when the real plant greatly differs from existing plant types (H with letters), and when manual, supplementary configuration requires greater effort than fully configuring plain basic type H.

**Parameterization
RMH760, RMH760B**

An S-mode DP must be configured in ETS and the Synco device to ensure that the S-mode DP transmits valid values. See Section 1.5 on workflows.

Example: Parameter
"Heating circuit 1"

The value assignment "Yes" to parameter "Heating circuit 1" configures S-mode DPs 16, 17, 18, 19, ... as well as parameters "Room temperature" and "Time switch operation".

Number	Name	Object Function	Desc...	Group	Addr...	Length	C	R	W	T	U	Data Type	Priority
0	System time	Input / Output				8 Byte	C	-	W	T	U		High
1	Date	Input / Output				3 Byte	C	-	W	T	U		Low
2	Time of day	Input / Output				3 Byte	C	-	W	T	U		Low
3	Fault information	Output				6 Byte	C	-	-	T	-		Alarm
4	Confirm faults	Input				1 bit	C	-	W	-	U		Low
5	Reset faults	Input				1 bit	C	-	W	-	U		Low
6	Fault state (normal/faulty)	Output				1 bit	C	-	-	T	-		Low
7	Fault transmission (enable/disable)	Input				1 bit	C	-	W	-	U		Low
16	[Heat circ 1] Timer button	Input (Trigger)				1 bit	C	-	W	-	U		Low
17	[Heat circ 1] Comfort button	Input (Trigger)				1 bit	C	-	W	-	U		Low
18	[Heat circ 1] Room temp: Setpoint relative	Input				2 Byte	C	-	W	-	U		Low
19	[Heat circ 1] Room operating mode: Preselection	Input and Output				1 Byte	C	-	W	T	U		Low
22	[Heat circ 1] Room operating mode: State	Output				1 Byte	C	-	-	T	-		Low
23	[Heat circ 1] Room temp: Protection setpoint	Input and Output				2 Byte	C	R	W	T	U		Low
24	[Heat circ 1] Room temp: Economy setpoint	Input and Output				2 Byte	C	R	W	T	U		Low
25	[Heat circ 1] Room temp: Precomfort setpoint	Input and Output				2 Byte	C	R	W	T	U		Low
26	[Heat circ 1] Room temp: Comfort setpoint	Input and Output				2 Byte	C	R	W	T	U		Low
27	[Heat circ 1] Mixing valve position	Output				1 Byte	C	R	-	T	-		Low
150	[Heat circ 1] Flow temperature: Setpoint	Output				2 Byte	C	R	-	T	-		Low
151	[Heat circ 1] Room temp: Setpoint act.	Output				2 Byte	C	R	-	T	-		Low
152	[Heat circ 1] Return temperature max.	Output				2 Byte	C	R	-	T	-		Low

3.2 RMH760, S-mode data points

RMH760: Inputs / Outputs

Name in ETS	DP in basic type	Flags					Data point type KNX				Value range	RMH receives <u>or</u> sends:
		B	R	W	T	U	ID	DPT_Name	Format	Unit		
System time (input) System time (output)	Always ⁵⁾	1	0	1	1	1	19.001	_DateTime	8 bytes struct.	YYYY MM DD d hh mm ss ---	1900...2155 = Year 1...12 = Month 1...31 = Day of month 1...7 = Monday - Sunday 0...23 = Hours 0...59 = Minutes 0...59 = Seconds Status bits ¹⁾	From KNX system time source <u>or</u> to KNX system time receiver cycl. 10 min.
Date (input) Date (output)	Always	1	0	1	1	1	11.001	_Date	3 bytes struct.	DD MM YY	1...31 = Day of month 1...12 = Month 00...99 = Year ⁴⁾	From KNX date source <u>or</u> to KNX date receiver cycl. 10 min.
Time of day (input) Time of day (output)	Always	1	0	1	1	1	10.001	_TimeOfDay	3 bytes struct.	d hh mm ss	1...7 = Monday - Sunday 0...23 = Hours 0...59 = Minutes 0...59 = Seconds	From KNX time source <u>or</u> to KNX time receiver cycl. 10 min.

¹⁾ See Section 1.4.3, page 13.

⁴⁾ See Section 1.4.3, page 14.

⁵⁾ See Section 1.5.1, page 16, Standard S-mode DP.

RMH760: Inputs

Name in ETS	DP in basic type	Flags					Data point type KNX				Value range	RMH760 receives:
		B	R	W	T	U	ID	DPT_Name	Format	Unit		
Confirm faults	Always	1	0	1	0	1	1.016	_Ack	1 bit B ₁	---	0 = No action 1 = Acknowledge / confirm	Event from KNX contact. No timeout monitoring.
Reset faults	Always	1	0	1	0	1	1.015	_Reset	1 bit B ₁	---	0 = No action 1 = Reset	Event from KNX contact. No timeout monitoring.
Fault transmission (enable/disable)	Always	1	0	1	0	1	1.003	_Enable	1 bit B ₁	---	0 = Disable 1 = Enable (default)	Event from KNX contact. "Disable" time-out monit 24 h.
Outside temperature	x-x (all)	1	0	1	0	1	9.001	_Value_Temp	2 bytes F ₁₆	°C	-273.00...+670760.00 Floating point	COV from KNX sensor.
Wind speed	x-x (all)	1	0	1	0	1	9.005	_Value_Wsp	2 bytes F ₁₆	m/s	0...670760.00 Floating point	COV from KNX wind speed meter.
Solar radiation	x-x (all)	1	0	1	0	1	9.022	_PowerDensity	2 bytes F ₁₆	W/m ²	0...670760.00 Floating point	COV from KNX solar sensor.
Heating circuit 1: Room temperature	x-2, x-4	1	0	1	0	1	9.001	_Value_Temp	2 bytes F ₁₆	°C	-273.00...+670760.00 Floating point	COV from KNX sensor.
Heat circ 1: Timer button	x-2, x-4	1	0	1	0	1	1.017	_Trigger	1 bit B ₁	---	0 = No action 1 = Comfort prolongation ³⁾	Event from KNX contact.
Heat circ 1: Comfort button	x-2, x-4	1	0	1	0	1	1.017	_Trigger	1 bit B ₁	---	0 = No action 1 = Operating mode ch'over ³⁾	Event from KNX contact.
Heat circ 1 Room temp: Setpoint relative	x-2, x-4	1	0	1	0	1	9.002	_Value_Tempd	2 bytes F ₁₆	K	-670760.00...+670760.00 Floating point	COV from KNX setp adj.
Heat circ 1 Room operating mode: Preselection	x-2, x-4	1	0	1	0	1	20.102	_HVACMode	1 byte N ₈	Enum.	0 = Auto 1 = Comfort 2 = Precomfort (Standby) 3 = Economy 4 = Protection (BldgProtect) 5...255 Reserve	Event from KNX preselect operation (device/progr)

³⁾ See Section 1.4.3, page 14.

RMH760: Inputs (continued)

Name in ETS	DP in basic type	Flags					Data point type KNX				Value range	RMH760 receives:
		C	R	W	T	U	ID	DPT_Name	Format	Unit		
Heat circ 1 Room optg mode: Time switch op Slave	x-2, x-4	1	0	1	0	1	20.102	_HVACMode	1 byte N ₈	Enum.	0 = Not used 1 = Comfort 2 = Precomfort (Standby) 3 = Economy 4 = Protection (BldgProtect) 5...255 Reserve	Event from KNX operation (device/progr). Timeout monit 31 min.
Heat circ 1 Room temp: Protection setpoint	x-2, x-4	1	0	1	0	1	9.001	_Value_Temp	2 bytes F ₁₆	°C	-273.00...+670760.00 Floating point	COV from KNX setp adj.
Heat circ 1 Room temp: Economy setpoint	x-2, x-4	1	0	1	0	1	9.001	_Value_Temp	2 bytes F ₁₆	°C	-273.00...+670760.00 Floating point	COV from KNX setp adj.
Heat circ 1 Room temp: Precomfort setpoint	x-2, x-4	1	0	1	0	1	9.001	_Value_Temp	2 bytes F ₁₆	°C	-273.00...+670760.00 Floating point	COV from KNX setp adj.
Heat circ 1 Room temp: Comfort setpoint	x-2, x-4	1	0	1	0	1	9.001	_Value_Temp	2 bytes F ₁₆	°C	-273.00...+670760.00 Floating point	COV from KNX setp adj.
Heat circuit 2: Room temperature	x-4	1	0	1	0	1	9.001	_Value_Temp	2 bytes F ₁₆	°C	-273.00...+670760.00 Floating point	COV from KNX sensor.
Heat circ 2: Timer button	x-4	1	0	1	0	1	1.017	_Trigger	1 bit B ₁	- - -	0 = No action 1 = Comfort prolongation ³⁾	Event from KNX contact.
Heat circ 2: Comfort button	x-4	1	0	1	0	1	1.017	_Trigger	1 bit B ₁	- - -	0 = No action 1 = Operating mode ch'over ³⁾	Event from KNX contact.
Heat circ 2 Room temp: Setpoint relative	x-4	1	0	1	0	1	9.002	_Value_Tempd	2 bytes F ₁₆	K	-670760.00...+670760.00 Floating point	COV from KNX setp adj.
Heat circ 2 Room operating mode: Preselection	x-4	1	0	1	0	1	20.102	_HVACMode	1 byte N ₈	Enum.	0 = Auto 1 = Comfort 2 = Precomfort (Standby) 3 = Economy 4 = Protection (BldgProtect) 5...255 Reserve	Event from KNX preselect operation (device/progr)
Heat circ 2 Room optg mode: Time switch op Slave	x-4	1	0	1	0	1	20.102	_HVACMode	1 byte N ₈	Enum.	0 = Not used 1 = Comfort 2 = Precomfort (Standby) 3 = Economy 4 = Protection (BldgProtect) 5...255 Reserve	Event from KNX operation (device/progr). Timeout monit 31 min.

³⁾ See Section 1.4.3, page 14.

RMH760: Inputs (continued)

Name in ETS	DP in basic type	Flags					Data point type KNX				Value range	RMH760 receives:
		C	R	W	T	U	ID	DPT_Name	Format	Unit		
Heat circ 2 Room temp: Protection setpoint	x-4	1	0	1	0	1	9.001	_Value_Temp	2 bytes F ₁₆	°C	-273.00...+670760.00 Floating point	COV from KNX setp adj.
Heat circ 2 Room temp: Economy setpoint	x-4	1	0	1	0	1	9.001	_Value_Temp	2 bytes F ₁₆	°C	-273.00...+670760.00 Floating point	COV from KNX setp adj.
Heat circ 2 Room temp: Precomfort setpoint	x-4	1	0	1	0	1	9.001	_Value_Temp	2 bytes F ₁₆	°C	-273.00...+670760.00 Floating point	COV from KNX setp adj.
Heat circ 2 Room temp: Comfort setpoint	x-4	1	0	1	0	1	9.001	_Value_Temp	2 bytes F ₁₆	°C	-273.00...+670760.00 Floating point	COV from KNX setp adj.
DHW: Forced charging	x-1, x-3, x-5	1	0	1	0	1	1.017	_Trigger	1 bit B ₁	- - -	0 = No action 1 = Action / forced charging	Event from KNX contact.
DHW operating mode: Preselection	x-1, x-3, x-5	1	0	1	0	1	20.103	_DHWMMode	1 byte N ₈	Enum.	0 = Auto 1 = Legionella prot. (65 °C) 2 = Normal temp. (55 °C) 3 = Reduced temp. (40 °C) 4 = Protection (5 °C) 5...255 Reserve	Event from KNX preselect operation (device/progr)
DHW operating mode: Time switch op Slave	x-1, x-3, x-5	1	0	1	0	1	20.103	_DHWMMode	1 byte N ₈	Enum.	0 = Not used 1 = Legionella prot. (65 °C) 2 = Normal temp. (55 °C) 3 = Reduced temp. (40 °C) 4 = Protection (5 °C) 5...255 Reserve	Event from KNX preselect operation (device/progr). Timeout monit 31 min.
DHW: Storage tank temp setpoint	x-1, x-3, x-5	1	0	1	0	1	9.001	_Value_Temp	2 bytes F ₁₆	°C	-273.00...+670760.00 Floating point	COV from KNX setp adj.

RMH760: Outputs

Name in ETS	DP in basic type	Flags					Data point type KNX				Value range	RMH760 sends:
		C	R	W	T	U	ID	DPT_Name	Format	Unit		
Fault information	Always	1	0	0	1	0	219.001	_AlarmInfo ²⁾	6 bytes struct.	- - -	[0]...255 = Log no. [RMH = 0] [0...2]...255 = Alarm priority [0...11]...255 = Application area [0...4]...255 = Error class [0...15]...63 = Alarm attributes [0...7] = Fault state	Heartbeat 30 min.
Fault state (normal/faulty)	Always	1	0	0	1	0	1.005	_Alarm	1 bit B ₁	- - -	0 = No alarm (default) 1 = Alarm / faulty	Event, heart- beat 30 min.
Outside temperature	x-x (all)	1	0	0	1	0	9.001	_Value_Temp	2 bytes F ₁₆	°C	-273.00...+670760.00 Floating point	COV, heart- beat 15 min.
Wind speed	x-x (all)	1	0	0	1	0	9.005	_Value_Wsp	2 bytes F ₁₆	m/s	0...670760.00 Floating point	COV, heart- beat 15 min.
Solar radiation	x-x (all)	1	0	0	1	0	9.022	_PowerDensity	2 bytes F ₁₆	W/m ²	0...670760.00 Floating point	COV, heart- beat 15 min.
Heat circuit 1: Room temperature	x-2, x-4	1	0	0	1	0	9.001	_Value_Temp	2 bytes F ₁₆	°C	-273.00...+670760.00 Floating point	COV, heart- beat 15 min.
Heat circ 1 Room optg mode: Time switch op Master	x-2, x-4	1	0	0	1	0	20.102	_HVACMode	1 byte N ₈	Enum.	0 = Not used 1 = Comfort 2 = Precomfort (Standby) 3 = Economy 4 = Protection (BldgProtect) 5...255 Reserve	Event, heart- beat 15 min.
Heat circ 1 Room optg mode: State	x-2, x-4	1	0	0	1	0	20.102	_HVACMode	1 byte N ₈	Enum.	0 = Not used 1 = Comfort 2 = Precomfort (Standby) 3 = Economy 4 = Protection (BldgProtect) 5...255 Reserve	Event, heart- beat 15 min.
Heat circuit 2: Room temperature	x-4	1	0	0	1	0	9.001	_Value_Temp	2 bytes F ₁₆	°C	-273.00...+670760.00 Floating point	COV, heart- beat 15 min.

²⁾ See Section 1.4.3, page 14.

RMH760: Outputs (continued)

Name in ETS	DP in basic type	Flags					Data point type KNX				Value range	RMH760 sends:
		C	R	W	T	U	ID	DPT_Name	Format	Unit		
Heat circ 2 Room optg mode: Time switch op Master	x-4	1	0	0	1	0	20.102	_HVACMode	1 byte N ₈	Enum.	0 = Not used 1 = Comfort 2 = Precomfort (Standby) 3 = Economy 4 = Protection (BldgProtect) 5...255 Reserve	Event, heart-beat 15 min.
Heat circ 2 Room optg mode: State	x-4	1	0	0	1	0	20.102	_HVACMode	1 byte N ₈	Enum.	0 = Not used 1 = Comfort 2 = Precomfort (Standby) 3 = Economy 4 = Protection (BldgProtect) 5...255 Reserve	Event, heart-beat 15 min.
DHW operating mode: Time switch op Master	x-1, x-3, x-5	1	0	0	1	0	20.103	_DHWMode	1 byte N ₈	Enum.	0 = Not used 1 = Legionella prot. (65 °C) 2 = Normal temp. (55 °C) 3 = Reduced temp. (40 °C) 4 = Protection (5 °C) 5...255 Reserve	Event, heart-beat 15 min.
DHW operating mode: State	x-1, x-3, x-5	1	0	0	0	1	20.103	_DHWMode	1 byte N ₈	Enum.	0 = Not used 1 = Legionella prot. (65 °C) 2 = Normal temp. (55 °C) 3 = Reduced temp. (40 °C) 4 = Protection (5 °C) 5...255 Reserve	Event, heart-beat 15 min.
DHW: Actual value storage tank temp top	x-1, x-3, x-5	1	0	0	0	1	9.001	_Value_Temp	2 bytes F ₁₆	°C	-273.00...+670760.00 Floating point	COV, heart-beat 15 min.
DHW: Actual value storage tank temp bottom	x-1, x-3, x-5	1	0	0	0	1	9.001	_Value_Temp	2 bytes F ₁₆	°C	-273.00...+670760.00 Floating point	COV, heart-beat 15 min.
Actual value boiler temperature	3-x, 4-x	1	0	0	0	1	9.001	_Value_Temp	2 bytes F ₁₆	°C	-273.00...+670760.00 Floating point	COV, heart-beat 15 min.
Boiler fault	3-x, 4-x	1	0	0	0	1	1.002	_Bool	1 bit B ₁	- - -	0 = No error (default) 1 = Boiler error	Event, heart-beat 15 min.

3.3 RMH760B, S-mode data points

RMH760B: Inputs / Outputs

Name in ETS	DP in FB	Flags					Data point type KNX				Value range	RMH receives <u>or</u> sends:
		C	R	W	T	U	ID	DPT_Name	Format	Unit		
System time (input) System time (output)	Always ⁵⁾	1	0	1	1	1	19.001	_DateTime	8 bytes struct.	YYYY MM DD d hh mm ss ---	1900...2155 = Year 1...12 = Month 1...31 = Day of month 1...7 = Monday - Sunday 0...23 = Hours 0...59 = Minutes 0...59 = Seconds Status bits ¹⁾	From KNX system time source <u>or</u> to KNX system time receiver cycl. 10 min.
Date (input) Date (output)	Always	1	0	1	1	1	11.001	_Date	3 bytes struct.	DD MM YY	1...31 = Day of month 1...12 = Month 00...99 = Year ⁴⁾	From KNX date source <u>or</u> to KNX date receiver cycl. 10 min.
Time of day (input) Time of day (output)	Always	1	0	1	1	1	10.001	_TimeOfDay	3 bytes struct.	d hh mm ss	1...7 = Monday - Sunday 0...23 = Hours 0...59 = Minutes 0...59 = Seconds	From KNX time source <u>or</u> to KNX time receiver cycl. 10 min.

¹⁾ See Section 1.4.3, page 13.

⁴⁾ See Section 1.4.3, page 14.

⁵⁾ See Section 1.5.1, page 16, Standard S-mode DP.

RMH760B: Inputs and outputs

S-mode DPs operated as input and output.

- Input: For operation using external device via KNX, Synco controller RMH760B receives the values of the S-mode DPs.
- Output: For operation from the Synco controller RMH760B, the S-mode DP values are sent via KNX (synchronization of external unit).

Name in ETS	DP in FB	Flags					Data point type KNX				Value range	RMH760B rec., sends
		C	R	W	T	U	ID	DPT_Name	Format	Unit		
[Heat circ 1...3] Room operating mode: Preselection	HC 1...3	1	0	1	1	1	20.102	_HVACMode	1 byte N ₈	Enum.	0 = Auto 1 = Comfort 2 = Precomfort (Standby) 3 = Economy 4 = Protection (BldgProtect) 5...255 Reserve	Event from KNX preselect operation (device/progr).
[Heat circ 1...3] Room temp: Protection setpoint	HC 1...3	1	1	1	1	1	9.001	_Value_Temp	2 bytes F ₁₆	°C	-273.00...+670760.00 Floating point	COV from KNX setp adj.
[Heat circ 1...3] Room temp: Economy setpoint	HC 1...3	1	1	1	1	1	9.001	_Value_Temp	2 bytes F ₁₆	°C	-273.00...+670760.00 Floating point	COV from KNX setp adj.
[Heat circ 1...3] Room temp: Precomfort setpoint	HC 1...3	1	1	1	1	1	9.001	_Value_Temp	2 bytes F ₁₆	°C	-273.00...+670760.00 Floating point	COV from KNX setp adj.
[Heat circ 1...3] Room temp: Comfort setpoint	HC 1...3	1	1	1	1	1	9.001	_Value_Temp	2 bytes F ₁₆	°C	-273.00...+670760.00 Floating point	COV from KNX setp adj.
[DHW] operating mode: Preselection	DHW	1	0	1	1	1	20.103	_DHWMode	1 byte N ₈	Enum.	0 = Auto 1 = Legionella prot. (65 °C) 2 = Normal temp. (55 °C) 3 = Reduced temp. (40 °C) 4 = Protection (5 °C) 5...255 Reserve	Event from KNX preselect operation (device/progr).
[DHW] Storage tank temp setpoint	DHW	1	1	1	1	1	9.001	_Value_Temp	2 bytes F ₁₆	°C	-273.00...+670760.00 Floating point	COV from KNX setp adj.

RMH760B: Inputs

Name in ETS	DP in FB	Flags					Data point type KNX				Value range	RMH760B receives:
		C	R	W	T	U	ID	DPT_Name	Format	Unit		
Confirm faults	Always	1	0	1	0	1	1.016	_Ack	1 bit B ₁	- - -	0 = No action 1 = Acknowledge / confirm	Event from KNX contact. No timeout monitoring.
Reset faults	Always	1	0	1	0	1	1.015	_Reset	1 bit B ₁	- - -	0 = No action 1 = Reset	Event from KNX contact. No timeout monitoring.
Fault transmission (enable/disable)	Always	1	0	1	0	1	1.003	_Enable	1 bit B ₁	- - -	0 = Disable 1 = Enable (default)	Event from KNX contact. "Disable" time-out monit 24 h.
Outside temperature (1)	Outs./meteo sensor	1	0	1	0	1	9.001	_Value_Temp	2 bytes F ₁₆	°C	-273.00...+670760.00 Floating point	COV from KNX sensor.
Wind speed	Outs./meteo sensor	1	0	1	0	1	9.005	_Value_Wsp	2 bytes F ₁₆	m/s	0...670760.00 Floating point	COV from KNX wind speed meter.
Solar radiation	Outs./meteo sensor	1	0	1	0	1	9.022	_PowerDensity	2 bytes F ₁₆	W/m ²	0...670760.00 Floating point	COV from KNX solar sensor.
[Heat circ 1] Room temperature	HC 1	1	0	1	0	1	9.001	_Value_Temp	2 bytes F ₁₆	°C	-273.00...+670760.00 Floating point	COV from KNX sensor.
[Heat circ 1] Timer button	HC 1	1	0	1	0	1	1.017	_Trigger	1 bit B ₁	- - -	0 = No action 1 = Comfort prolongation ³⁾	Event from KNX contact.
[Heat circ 1] Comfort button	HC 1	1	0	1	0	1	1.017	_Trigger	1 bit B ₁	- - -	0 = No action 1 = Operating mode ch'over ³⁾	Event from KNX contact.
[Heat circ 1] Room temp: Setpoint relative	HC 1	1	0	1	0	1	9.002	_Value_Tempd	2 bytes F ₁₆	K	-670760.00...+670760.00 Floating point	COV from KNX setp adj.
[Heat circ 1] Room optg mode: Time switch	HC 1	1	0	1	0	1	20.102	_HVACMode	1 byte N ₈	Enum.	0 = Auto 1 = Comfort 2 = Precomfort (Standby) 3 = Economy 4 = Protection (BldgProtect) 5...255 Reserve	Event from KNX preselect operation (device/progr). Timeout monit 31 min.

³⁾ See Section 1.4.3, page 14.

RMH760B: Inputs (continued)

Name in ETS	DP in FB	Flags					Data point type KNX				Value range	RMH760B receives:
		C	R	W	T	U	ID	DPT_Name	Format	Unit		
[Heat circ 2...3] Outside temperature	HC 2...3	1	0	1	0	1	9.001	_Value_Temp	2 bytes F ₁₆	°C	-273.00...+670760.00 Floating point	COV from KNX setp adj.
[Heat circ 2...3] Room temperature	HC 2...3	1	0	1	0	1	9.001	_Value_Temp	2 bytes F ₁₆	°C	-273.00...+670760.00 Floating point	COV from KNX sensor.
[Heat circ 2...3] Timer button	HC 2...3	1	0	1	0	1	1.017	_Trigger	1 bit B ₁	- - -	0 = No action 1 = Comfort prolongation ³⁾	Event from KNX contact.
[Heat circ 2...3] Comfort button	HC 2...3	1	0	1	0	1	1.017	_Trigger	1 bit B ₁	- - -	0 = No action 1 = Operating mode ch'over ³⁾	Event from KNX contact.
[Heat circ 2...3] Room temp: Setpoint relative	HC 2...3	1	0	1	0	1	9.002	_Value_Tempd	2 bytes F ₁₆	K	-670760.00...+670760.00 Floating point	COV from KNX setp adj.
[Heat circ 2...3] Room optg mode: Time switch (Parameterization: Slave)	HC 2...3	1	0	1	0	1	20.102	_HVACMode	1 byte N ₈	Enum.	0 = Not used 1 = Comfort 2 = Precomfort (Standby) 3 = Economy 4 = Protection (BldgProtect) 5...255 Reserve	Event from KNX operation (device/progr). Timeout monit 31 min.
[DHW] Forced charging	DHW	1	0	1	0	1	1.017	_Trigger	1 bit B ₁	- - -	0 = No action 1 = Action / forced charging	Event from KNX contact.
[DHW] Operating mode: Time switch (Parameterization: Slave)	DHW	1	0	1	0	1	20.103	_DHWMode	1 byte N ₈	Enum.	0 = Not used 1 = Legionella prot. (65 °C) 2 = Normal temp. (55 °C) 3 = Reduced temp. (40 °C) 4 = Protection (5 °C) 5...255 Reserve	Event from KNX preselect operation (device/progr). Timeout monit 31 min.
[Main controller] Flow temp: Setpoint relative	MC	1	0	1	0	1	9.002	_Value_Tempd	2 bytes F ₁₆	K	-670760.00...+670760.00 Floating point	COV from KNX setp adj.

³⁾ See Section 1.4.3, page 14.

RMH760B: Outputs

Name in ETS	DP in FB	Flags					Data point type KNX				Value range	RMH760B sends:
		C	R	W	T	U	ID	DPT_Name	Format	Unit		
Fault information	Always	1	0	0	1	0	219.001	_AlarmInfo ²⁾	6 bytes struct.	- - -	[0]...255 = Log no. [RMH = 0] [0...2]...255 = Alarm priority [0...11]...255 = Application area [0...4]...255 = Error class [0...15]...63 = Alarm attributes [0...7] = Fault state	Heartbeat 30 min.
Fault state (normal/faulty)	Always	1	0	0	1	0	1.005	_Alarm	1 bit B ₁	- - -	0 = No alarm (default) 1 = Alarm / faulty	Event, heart- beat 30 min.
Outside temperature (1) ⁷⁾	Outs./meteo sensor	1	0	0	1	0	9.001	_Value_Temp	2 bytes F ₁₆	°C	-273.00...+670760.00 Floating point	COV, heart- beat 15 min.
Wind speed ⁷⁾	Outs./meteo sensor	1	0	0	1	0	9.005	_Value_Wsp	2 bytes F ₁₆	m/s	0...670760.00 Floating point	COV, heart- beat 15 min.
Solar radiation ⁷⁾	Outs./meteo sensor	1	0	0	1	0	9.022	_PowerDensity	2 bytes F ₁₆	W/m ²	0...670760.00 Floating point	COV, heart- beat 15 min.
[Heat circ 1] Room temperature ⁷⁾	HC 1	1	0	0	1	0	9.001	_Value_Temp	2 bytes F ₁₆	°C	-273.00...+670760.00 Floating point	COV, heart- beat 15 min.
[Heat circ 1] Room optg mode: Time switch (Parameterization: Master)	HC 1	1	0	0	1	0	20.102	_HVACMode	1 byte N ₈	Enum.	0 = Not used 1 = Comfort 2 = Precomfort (Standby) 3 = Economy 4 = Protection (BldgProtect) 5...255 Reserve	Event, heart- beat 15 min.
[Heat circ 1] Room operating mode: State	HC 1	1	0	0	1	0	20.102	_HVACMode	1 byte N ₈	Enum.	0 = Not used 1 = Comfort 2 = Precomfort (Standby) 3 = Economy 4 = Protection (BldgProtect) 5...255 Reserve	Event, heart- beat 15 min.
[Heat circ 1] Mixing valve position	HC 1	1	1	0	1	0	5.001	_Scaling	8 bit U ₈	%	[0...100] Resolution 0.4 %	COV, heart- beat 15 min.

²⁾ See Section 1.4.3, page 14.

⁷⁾ See Section 1.5.1, page 16, S-mode DP sends 0.

RMH760B: Outputs (continued)

Name in ETS	DP in FB	Flags					Data point type KNX				Value range	RMH760B sends:
		C	R	W	T	U	ID	DPT_Name	Format	Unit		
[Heat circ 2...3] Outside temperature ⁷⁾	HC 2...3	1	0	0	1	0	9.001	_Value_Temp	2 bytes F ₁₆	°C	-273.00...+670760.00 Floating point	COV, heart-beat 15 min.
[Heat circ 2...3] Room temperature ⁷⁾	HC 2...3	1	0	0	1	0	9.001	_Value_Temp	2 bytes F ₁₆	°C	-273.00...+670760.00 Floating point	COV, heart-beat 15 min.
[Heat circ 2...3] Room optg mode: Time switch (Parameterization: Master)	HC 2...3	1	0	0	1	0	20.102	_HVACMode	1 byte N ₈	Enum.	0 = Not used 1 = Comfort 2 = Precomfort (Standby) 3 = Economy 4 = Protection (BldgProtect) 5...255 Reserve	Event from KNX operation (device/progr). Timeout monit 31 min.
[Heat circ 2...3] Room operating mode: State	HC 2...3	1	0	0	1	0	20.102	_HVACMode	1 byte N ₈	Enum.	0 = Not used 1 = Comfort 2 = Precomfort (Standby) 3 = Economy 4 = Protection (BldgProtect) 5...255 Reserve	Event, heart-beat 15 min.
[Heat circ 2...3] Mixing valve position	HC 2...3	1	1	0	1	0	5.001	_Scaling	8 bit U ₈	%	[0...100] Resolution 0.4%	COV, heart-beat 15 min.
[DHW] Operating mode: Time switch (Parameterization: Master)	DHW	1	0	0	1	0	20.103	_DHWMode	1 byte N ₈	Enum.	0 = Not used 1 = Legionella prot. (65 °C) 2 = Normal temp. (55 °C) 3 = Reduced temp. (40 °C) 4 = Protection (5 °C) 5...255 Reserve	Event from KNX preselect operation (device/progr). Timeout monit 31 min.
[DHW] operating mode: State	DHW	1	0	0	1	0	20.103	_DHWMode	1 byte N ₈	Enum.	0 = Not used 1 = Legionella prot. (65 °C) 2 = Normal temp. (55 °C) 3 = Reduced temp. (40 °C) 4 = Protection (5 °C) 5...255 Reserve	Event from KNX preselect operation (device/progr). Timeout monit 31 min.

⁷⁾ See Section 1.5.1, page 16, S-mode DP sends 0.

RMH760B: Outputs (continued)

Name in ETS	DP in FB	Flags					Data point type KNX				Value range	RMH760B sends:
		C	R	W	T	U	ID	DPT_Name	Format	Unit		
[DHW] Actual value storage tank temp top	DHW	1	0	0	1	0	9.001	_Value_Temp	2 bytes F ₁₆	°C	-273.00...+670760.00 Floating point	COV, heart-beat 15 min.
[DHW] Actual value storage tank temp bottom	DHW	1	0	0	1	0	9.001	_Value_Temp	2 bytes F ₁₆	°C	-273.00...+670760.00 Floating point	COV, heart-beat 15 min.
[DHW] Mixing valve position primary	DHW	1	1	0	1	0	5.001	_Scaling	8 bit U ₈	%	[0...100] Resolution 0.4%	COV, heart-beat 15 min.
[DHW] Mixing valve pos maintained secondary temp	DHW	1	1	0	1	0	5.001	_Scaling	8 bit U ₈	%	[0...100] Resolution 0.4%	COV, heart-beat 15 min.
[DHW] Mixing valve position consumers	DHW	1	1	0	1	0	5.001	_Scaling	8 bit U ₈	%	[0...100] Resolution 0.4%	COV, heart-beat 15 min.
[Main controller] Mixing valve position	MC	1	1	0	1	0	5.001	_Scaling	8 bit U ₈	%	[0...100] Resolution 0.4%	COV, heart-beat 15 min.
[Primary controller] Mixing valve position	PC	1	1	0	1	0	5.001	_Scaling	8 bit U ₈	%	[0...100] Resolution 0.4%	COV, heart-beat 15 min.
[Boiler] Signal modulating burner	B	1	1	0	1	0	5.001	_Scaling	8 bit U ₈	%	[0...100] Resolution 0.4%	COV, heart-beat 15 min.
[Boiler] Mixing valve pos maintained return temp	B	1	1	0	1	0	5.001	_Scaling	8 bit U ₈	%	[0...100] Resolution 0.4%	COV, heart-beat 15 min.
[Heat circ 1...3] Flow temperature: Setpoint ⁶⁾	HC 1...3	1	1	0	1	0	9.001	_Value_Temp	2 bytes F ₁₆	°C	-273.00...+670760.00 Floating point	COV, heart-beat 15 min.
[Heat circ 1...3] Room temp: Setpoint act. ⁶⁾	HC 1...3	1	1	0	1	0	9.001	_Value_Temp	2 bytes F ₁₆	°C	-273.00...+670760.00 Floating point	COV, heart-beat 15 min.
[Heating circuit 1...3] Return temperature max. ⁶⁾	HC 1...3	1	1	0	1	0	9.001	_Value_Temp	2 bytes F ₁₆	°C	-273.00...+670760.00 Floating point	COV, heart-beat 15 min.
[DHW] Flow temperature: Setpoint primary ⁶⁾	DHW	1	1	0	1	0	9.001	_Value_Temp	2 bytes F ₁₆	°C	-273.00...+670760.00 Floating point	COV, heart-beat 15 min.
[DHW] Flow temperature: Setpoint secondary ⁶⁾	DHW	1	1	0	1	0	9.001	_Value_Temp	2 bytes F ₁₆	°C	-273.00...+670760.00 Floating point	COV, heart-beat 15 min.
[DHW] Storage tank temp setpoint act. ⁶⁾	DHW	1	1	0	1	0	9.001	_Value_Temp	2 bytes F ₁₆	°C	-273.00...+670760.00 Floating point	COV, heart-beat 15 min.
[DHW] Return temperature max. ⁶⁾	DHW	1	1	0	1	0	9.001	_Value_Temp	2 bytes F ₁₆	°C	-273.00...+670760.00 Floating point	COV, heart-beat 15 min.
[DHW] Flow temperature: Setpoint consumer ⁶⁾	DHW	1	1	0	1	0	9.001	_Value_Temp	2 bytes F ₁₆	°C	-273.00...+670760.00 Floating point	COV, heart-beat 15 min.

⁶⁾ See Section 1.5.1, page 16, Out of service.

RMH760B: Outputs (continued)

Name in ETS	DP in FB	Flags					Data point type KNX				Value range	RMH760B sends:
		C	R	W	T	U	ID	DPT_Name	Format	Unit		
[Primary controller] Flow temp: Setpoint act. ⁶⁾	PC	1	1	0	1	0	9.001	_Value_Temp	2 bytes F ₁₆	°C	-273.00...+670760.00 Floating point	COV, heart-beat 15 min.
[Primary controller] Return temperature max. ⁶⁾	PC	1	1	0	1	0	9.001	_Value_Temp	2 bytes F ₁₆	°C	-273.00...+670760.00 Floating point	COV, heart-beat 15 min.
[Main controller] Flow temp: Setpoint act. ⁶⁾	MC	1	1	0	1	0	9.001	_Value_Temp	2 bytes F ₁₆	°C	-273.00...+670760.00 Floating point	COV, heart-beat 15 min.
[Main controller] Return temperature max. ⁶⁾	MC	1	1	0	1	0	9.001	_Value_Temp	2 bytes F ₁₆	°C	-273.00...+670760.00 Floating point	COV, heart-beat 15 min.
[Boiler] Temperature: Setpoint act. ⁶⁾	B	1	1	0	1	0	9.001	_Value_Temp	2 bytes F ₁₆	°C	-273.00...+670760.00 Floating point	COV, heart-beat 15 min.
[Boiler] Return temp min.	B	1	1	0	1	0	9.001	_Value_Temp	2 bytes F ₁₆	°C	-273.00...+670760.00 Floating point	COV, heart-beat 15 min.
[Boiler] Flue gas temperature maximum	B	1	1	0	1	0	9.001	_Value_Temp	2 bytes F ₁₆	°C	-273.00...+670760.00 Floating point	COV, heart-beat 15 min.
[Boiler] Flue gas temperature limit value	B	1	1	0	1	0	9.001	_Value_Temp	2 bytes F ₁₆	°C	-273.00...+670760.00 Floating point	COV, heart-beat 15 min.

⁶⁾ See Section 1.5.1, page 16, Out of service.

RMH760B: Terminals, Heating controller RMH760B

- Input terminals N.X1...N.X6 with S-mode function "Output", parameterizable for analog input value [°C], [% rH] etc. or for digital input value [0/1].

Name in ETS	DP ⁷⁾	Flags					Data point type KNX				Value range	RMH760B sends:
		C	R	W	T	U	ID	DPT_Name	Format	Unit		
Input N.X_ [°C]	RMH760B	1	1	0	1	0	9.001	_Value_Temp	2 bytes F ₁₆	°C	-273.00...+670760.00 Floating point	COV, heart-beat 15 min.
Input N.X_ [% rH]	RMH760B	1	1	0	1	0	9.007	_Value_Humidity	2 bytes F ₁₆	%	[0...670760]	COV, heart-beat 15 min.
Input N.X_ [0...100%]	RMH760B	1	1	0	1	0	5.001	_Scaling	8 bit U ₈	%	[0...100] Resolution 0.4%	COV, heart-beat 15 min.
Input N.X_ [0...255%]	RMH760B	1	1	0	1	0	5.004	_Percent	8 bit U ₈	%	[0...255] Resolution 1%	COV, heart-beat 15 min.
Input N.X_ [m/s]	RMH760B	1	1	0	1	0	14.065	_Value_Speed	4 bytes F ₃₂	m/s	IEEE 754 floating [0...255].[0...8388607]	COV, heart-beat 15 min.
Input N.X_ [m/s]	RMH760B	1	1	0	1	0	9.005	_Value_Wsp	2 bytes F ₁₆	m/s	[0...670760]	COV, heart-beat 15 min.
Input N.X_ [Pa]	RMH760B	1	1	0	1	0	14.058	_Value_Pressure	4 bytes F ₃₂	Pa = N/m ²	IEEE 754 floating [0...255].[0...8388607]	COV, heart-beat 15 min.
Input N.X_ [Pa]	RMH760B	1	1	0	1	0	9.006	_Value_Pres	2 bytes F ₁₆	Pa = N/m ²	[0...670760]	COV, heart-beat 15 min.
Input N.X_ [ppm]	RMH760B	1	1	0	1	0	9.008	_Value_AirQuality	2 bytes F ₁₆	ppm	[0...670760]	COV, heart-beat 15 min.
Input N.X_ [0/1]	RMH760B	1	1	0	1	0	1.001	_Switch	1 bit B ₁	- - -	0 = Off 1 = On	Event, heart-beat 15 min.

- Output terminals N.Q1...N.Q5, parameterized for digital output value [0/1].

Output N.Q_	RMH770 V2.0	1	1	0	1	0	1.001	_Switch	1 bit B ₁	- - -	0 = Off 1 = On	Event, heart-beat 15 min.
-------------	----------------	---	---	---	---	---	-------	---------	-------------------------	-------	-------------------	---------------------------

- Output terminals N.Y1, N.Y2, parameterized for analog output value [0...100].

Output N.Y_	RMH770 V2.0	1	1	0	1	0	5.001	_Scaling	8 bit U ₈	%	[0...100] Resolution 0.4 %	COV, heart-beat 15 min.
-------------	----------------	---	---	---	---	---	-------	----------	-------------------------	---	-------------------------------	-------------------------

⁷⁾ See Section 1.5.1, page 16, S-mode DP sends 0.

RMH760B: Terminals, Extension modules RMZ78x on Heating controller RMH760B

- Input terminals A__X_ with S-mode function "Output", parameterizable for analog input value [°C], [% rH] etc. or for digital input value [0/1].

Name in ETS	DP ⁷⁾	Flags					Data point type KNX				Value range	RMU7x0B sends:
		C	R	W	T	U	ID	DPT_Name	Format	Unit		
Input A__X_ [°C]	RMZ78x	1	1	0	1	0	9.001	_Value_Temp	2 bytes F ₁₆	°C	-273.00...+670760.00 Floating point	COV, heart-beat 15 min.
Input A__X_ [% rH]	RMZ78x	1	1	0	1	0	9.007	_Value_Humidity	2 bytes F ₁₆	%	[0...670760]	COV, heart-beat 15 min.
Input A__X_ [0...100%]	RMZ78x	1	1	0	1	0	5.001	_Scaling	8 bit U ₈	%	[0...100] Resolution 0.4 %	COV, heart-beat 15 min.
Input A__X_ [0...255%]	RMZ78x	1	1	0	1	0	5.004	_Percent	8 bit U ₈	%	[0...255] Resolution 1%	COV, heart-beat 15 min.
Input A__X_ [m/s]	RMZ78x	1	1	0	1	0	14.065	_Value_Speed	4 bytes F ₃₂	m/s	IEEE 754 floating [0...255].[0...8388607]	COV, heart-beat 15 min.
Input A__X_ [m/s]	RMZ78x	1	1	0	1	0	9.005	_Value_Wsp	2 bytes F ₁₆	m/s	[0...670760]	COV, heart-beat 15 min.
Input A__X_ [Pa]	RMZ78x	1	1	0	1	0	14.058	_Value_Pressure	4 bytes F ₃₂	Pa = N/m ²	IEEE 754 floating [0...255].[0...8388607]	COV, heart-beat 15 min.
Input A__X_ [Pa]	RMZ78x	1	1	0	1	0	9.006	_Value_Pres	2 bytes F ₁₆	Pa = N/m ²	[0...670760]	COV, heart-beat 15 min.
Input A__X_ [ppm]	RMZ78x	1	1	0	1	0	9.008	_Value_AirQuality	2 bytes F ₁₆	ppm	[0...670760]	COV, heart-beat 15 min.
Input A__X_ [0/1]	RMZ78x	1	1	0	1	0	1.001	_Switch	1 bit B ₁	- - -	0 = Off 1 = On	Event, heart-beat 15 min.

Input A2(1).X1...A2(1).X3	RMZ782(1)
Input A2(2).X1...A2(2).X3	RMZ782(2)
Input A3.X1...A3.X4	RMZ783
Input A7.X1...A7.X4	RMZ787
Input A9(1).X1...A9(1).X6	RMZ789(1)
Input A9(2).X1...A9(2).X6	RMZ789(2)

⁷⁾ See Section 1.5.1, page 16, S-mode DP sends 0.

RMH760B: Terminals, Extension modules RMZ78x on Heating controller RMH760B (continued)

- Output terminals A__Q__, parameterized for digital output value [0/1].

Name in ETS	DP ⁷⁾	Flags					Data point type KNX				Value range	RMH760B sends:
		C	R	W	T	U	ID	DPT_Name	Format	Unit		
Output A__Q__	RMZ78x	1	1	0	1	0	1.001	_Switch	1 bit B ₁	- - -	0 = Off 1 = On	Event, heart-beat 15 min.

Output A2(1).Q1...A2(1).Q3 RMZ782(1)
 Output A2(2).Q1...A2(2).Q3 RMZ782(2)
 Output A3.Q1...A3.Q5 RMZ783
 Output A7.Q1...A7.Q5 (without Q4) RMZ787
 Output A9(1).Q1...A9(1).Q4 RMZ789(1)
 Output A9(2).Q1...A9(2).Q4 RMZ789(2)

- Output terminals A__Y__, parameterized for analog output value [0...100].

Name in ETS	DP ⁷⁾	Flags					Data point type KNX				Value range	RMH760B sends:
		C	R	W	T	U	ID	DPT_Name	Format	Unit		
Output A__Y__	RMZ78x	1	1	0	1	0	5.001	_Scaling	8 bit U ₈	%	[0...100] Resolution 0.4 %	COV, heart-beat 15 min.

Output A2(1).Y1 RMZ782(1)
 Output A2(2).Y1 RMZ782(2)
 Output A3.Y1 RMZ783
 Output A9(1).Y1, A9(1).Y2 RMZ789(1)
 Output A9(2).Y1, A9(2).Y2 RMZ789(2)

Note: Max. 4 Extension modules RMZ78x (same or different types) are allowed per Heating controller RMH760B.

⁷⁾ See Section 1.5.1, page 16, S-mode DP sends 0.

4 RMK770, RMK770 V2.0 Boiler sequence controller

4.1 Overview

Brief description

The Synco 700 Boiler sequence controllers RMK770 and RMK770 V2.0 are responsible for controlling multi-boiler plants (up to 6 boilers), to control the boiler temperature as well as an additional heating and/or primary control loop. When used together with RMZ78x universal modules, additional control functions are possible.



Documentation

Data sheet	Boiler sequence controller RMK770	N3132
Basic documentation	Boiler sequence controller RMK770	P3132

Number of S-mode DPs

	RMK770	RMK770 V2.0
Inputs / Outputs	3	7
Inputs	15	10
Outputs	38	205

Column "DP active"

Indication:	Meaning:
Always	Standard S-mode DP
HC	Heating circuit
HC or T'swi	Heating circuit <u>or</u> time switch
Boiler 1...6	Boiler 1...6
Boiler seq. manager	Boiler sequence manager
MF sensor	Main flow sensor

Note

"Always" points to a standard S-mode DP that is always configured in ETS when the Synco device is selected.

Parameterization RMK770, RMK770 V2.0

An S-mode DP must be configured in ETS and the Synco device to ensure that the S-mode DP transmits valid values. See Section 1.5 on workflows.

Note

For RMK770, of a total of 56 S-mode DPs, a maximum of 50 can be connected via group addresses.
For RMK770 V2.0, all 222 S-mode DPs can be connected via group addresses.

4.2 RMK770, S-mode data points

RMK770: Inputs / Outputs

Name in ETS	DP active	Flags					Data point type KNX				Value range	RMK rec. or sends:
		C	R	W	T	U	ID	DPT_Name	Format	Unit		
System time (input) System time (output)	Always ⁵⁾	r	0	1	1	1	19.001	_DateTime	8 bytes struct.	YYYY MM DD d hh mm ss ---	1900...2155 = Year 1...12 = Month 1...31 = Day of month 1...7 = Monday - Sunday 0...23 = Hours 0...59 = Minutes 0...59 = Seconds Status bits ¹⁾	From KNX system time source or to KNX system time receiver cycl. 10 min.
Date (input) Date (output)	Always	1	0	1	1	1	11.001	_Date	3 bytes struct.	DD MM YY	1...31 = Day of month 1...12 = Month 00...99 = Year ⁴⁾	From KNX date source or to KNX date receiver cycl. 10 min.
Time of day (input) Time of day (output)	Always	1	0	1	1	1	10.001	_TimeOfDay	3 bytes struct.	d hh mm ss	1...7 = Monday - Sunday 0...23 = Hours 0...59 = Minutes 0...59 = Seconds	From KNX time source or to KNX time receiver cycl. 10 min.

¹⁾ See Section 1.4.3, page 13.

⁴⁾ See Section 1.4.3, page 14.

⁵⁾ See Section 1.5.1, page 16, Standard S-mode DP.

RMK770: Inputs

Name in ETS	DP active	Flags					Data point type KNX				Value range	RMK770 receives:
		C	R	W	T	U	ID	DPT_Name	Format	Unit		
Confirm faults	Always	1	0	1	0	1	1.016	_Ack	1 bit B ₁	---	0 = No action 1 = Acknowledge / confirm	Event from KNX contact. No timeout monitoring.
Reset faults	Always	1	0	1	0	1	1.015	_Reset	1 bit B ₁	---	0 = No action 1 = Reset	Event from KNX contact. No timeout monitoring.
Fault transmission (enable/disable)	Always	1	0	1	0	1	1.003	_Enable	1 bit B ₁	---	0 = Disable 1 = Enable (default)	Event from KNX contact. "Disable" time-out monit 24 h.
Outside temperature	Receive	1	0	1	0	1	9.001	_Value_Temp	2 bytes F ₁₆	°C	-273.00...+670760.00 Floating point	COV from KNX sensor.
Room temperature	Receive	1	0	1	0	1	9.001	_Value_Temp	2 bytes F ₁₆	°C	-273.00...+670760.00 Floating point	COV from KNX sensor.
Timer button	HC	1	0	1	0	1	1.017	_Trigger	1 bit B ₁	---	0 = No action 1 = Comfort prolongation ³⁾	Event from KNX contact.
Comfort button	HC	1	0	1	0	1	1.017	_Trigger	1 bit B ₁	---	0 = No action 1 = Operating mode ch'over ³⁾	Event from KNX contact
Room temperature: Setpoint relative	HC	1	0	1	0	1	9.002	_Value_Tempd	2 bytes F ₁₆	K	-670760.00...+670760.00 Floating point	COV from KNX setp adj.
Room optg mode: Preselection	HC	1	0	1	0	1	20.102	_HVACMode	1 byte N ₈	Enum.	0 = Auto 1 = Comfort 2 = Precomfort (Standby) 3 = Economy 4 = Protection (BldgProtect) 5...255 Reserve	Event from KNX preselect operation (device/progr)

³⁾ See Section 1.4.3, page 14.

RMK770: Inputs (continued)

Name in ETS	DP active	Flags					Data point type KNX				Value range	RMK770 receives:
		C	R	W	T	U	ID	DPT_Name	Format	Unit		
Room optg mode: Time switch operation Slave	HC or T'swi	1	0	1	0	1	20.102	_HVACMode	1 byte N ₈	Enum.	0 = Not used 1 = Comfort 2 = Precomfort (Standby) 3 = Economy 4 = Protection (BldgProtect) 5...255 Reserve	Event from KNX operation (device/progr). Timeout monit 31 min.
Room temp: Protection heating setpoint	HC	1	0	1	0	1	9.001	_Value_Temp	2 bytes F ₁₆	°C	-273.00...+670760.00 Floating point	COV from KNX setp adj.
Room temp: Economy heating setpoint	HC	1	0	1	0	1	9.001	_Value_Temp	2 bytes F ₁₆	°C	-273.00...+670760.00 Floating point	COV from KNX setp adj.
Room temp: Precomfort heating setpoint	HC	1	0	1	0	1	9.001	_Value_Temp	2 bytes F ₁₆	°C	-273.00...+670760.00 Floating point	COV from KNX setp adj.
Room temp: Comfort heating setpoint	HC	1	0	1	0	1	9.001	_Value_Temp	2 bytes F ₁₆	°C	-273.00...+670760.00 Floating point	COV from KNX setp adj.
Main flow temperature: Setpoint relative	MF sensor	1	0	1	0	1	9.002	_Value_Tempd	2 bytes F ₁₆	K	-670760.00...+670760.00 Floating point	COV from KNX setp adj.

RMK770: Outputs

Name in ETS	DP active	Flags					Data point type KNX				Value range	RMK770 sends:
		C	R	W	T	U	ID	DPT_Name	Format	Unit		
Fault information	Always	1	0	0	1	0	219.001	_AlarmInfo ²⁾	6 bytes struct.	---	[0]...255 = Log no. [RMK = 0] [0...2]...255 = Alarm priority [0...11]...255 = Application area [0...4]...255 = Error class [0...15]...63 = Alarm attributes [0...7] = Fault state	Heartbeat 30 min.
Fault state (normal/faulty)	Always	1	0	0	1	0	1.005	_Alarm	1 bit B ₁	---	0 = No alarm (default) 1 = Alarm / faulty	Event, heart-beat 30 min.
Outside temperature	Send	1	0	0	1	0	9.001	_Value_Temp	2 bytes F ₁₆	°C	-273.00...+670760.00 Floating point	COV, heart-beat 15 min.
Room temperature	Send	1	0	0	1	0	9.001	_Value_Temp	2 bytes F ₁₆	°C	-273.00...+670760.00 Floating point	COV, heart-beat 15 min.
Room optg mode: Time switch operation Master	HC or T'swi	1	0	0	1	0	20.102	_HVACMode	1 byte N ₈	Enum.	0 = Not used 1 = Comfort 2 = Precomfort (Standby) 3 = Economy 4 = Protection (BldgProtect) 5...255 Reserve	Event, heart-beat 15 min.
Room optg mode: State	HC	1	0	0	1	0	20.102	_HVACMode	1 byte N ₈	Enum.	0 = Not used 1 = Comfort 2 = Precomfort (Standby) 3 = Economy 4 = Protection (BldgProtect) 5...255 Reserve	Event, heart-beat 15 min.
Main flow temperature actual value	MF sensor	1	0	0	1	0	9.001	_Value_Temp	2 bytes F ₁₆	°C	-273.00...+670760.00 Floating point	COV, heart-beat 15 min.
Boiler seq manager: Fault state (normal/faulty)	MF sensor	1	0	0	1	0	1.002	_Bool	1 bit B ₁	---	0 = No error (default) 1 = Boiler sequence error	Event, heart-beat 15 min.

²⁾ See Section 1.4.3, page 14.

RMK770: Outputs (continued)

Name in ETS	DP active	Flags					Data point type KNX				Value range	RMK770 sends:
		C	R	W	T	U	ID	DPT_Name	Format	Unit		
Boiler 1...6: Actual value boiler temperature	Boiler 1...6	1	0	0	1	0	9.001	_Value_Temp	2 bytes F ₁₆	°C	-273.00...+670760.00 Floating point	COV, heart-beat 15 min.
Boiler 1...6: Current burner output [%]	Boiler 1...6	1	0	0	1	0	5.001	_Scaling	8 bit U ₈	%	[0...100] Resolution 0.4%	COV, heart-beat 3 min.
Boiler 1...6: Burner stage 1	Boiler 1...6	1	0	0	1	0	1.003	_Enable	1 bit B ₁	- - -	0 = Stage 1 disabled 1 = Stage 1 enabled	Event, heart-beat 3 min.
Boiler 1...6: Burner stage 2	Boiler 1...6	1	0	0	1	0	1.003	_Enable	1 bit B ₁	- - -	0 = Stage 2 disabled 1 = Stage 2 enabled	Event, heart-beat 3 min.
Boiler 1...6: Fault state (normal/faulty)	Boiler 1...6	1	0	0	1	0	1.002	_Bool	1 bit B ₁	- - -	0 = No error (default) 1 = Boiler error	Heartbeat 3 min.

- Selection of boilers 1...6 is free (e.g. boiler 2, boiler 3, and boiler 5).

4.3 RMK770 V2.0, S-mode data points

RMK770 V2.0: Inputs / Outputs

Name in ETS	DP active	Flags					Data point type KNX				Value range	RMK rec. or sends:
		C	R	W	T	U	ID	DPT_Name	Format	Unit		
System time (input) System time (output)	Always ⁵⁾	r	0	1	1	1	19.001	_DateTime	8 bytes struct.	YYYY MM DD d hh mm ss ---	1900...2155 = Year 1...12 = Month 1...31 = Day of month 1...7 = Monday - Sunday 0...23 = Hours 0...59 = Minutes 0...59 = Seconds Status bits ¹⁾	From KNX system time source or to KNX system time receiver cycl. 10 min.
Date (input) Date (output)	Always	1	0	1	1	1	11.001	_Date	3 bytes struct.	DD MM YY	1...31 = Day of month 1...12 = Month 00...99 = Year ⁴⁾	From KNX date source or to KNX date receiver cycl. 10 min.
Time of day (input) Time of day (output)	Always	1	0	1	1	1	10.001	_TimeOfDay	3 bytes struct.	d hh mm ss	1...7 = Monday - Sunday 0...23 = Hours 0...59 = Minutes 0...59 = Seconds	From KNX time source or to KNX time receiver cycl. 10 min.
Heating circuit room operating mode: Preselection	Heating circuit	1	0	1	1	1	20.102	_HVACMode	1 byte N ₈	Enum.	0 = Auto 1 = Comfort 2 = Precomfort (Standby) 3 = Economy 4 = Protection (BldgProtect) 5...255 Reserve	Event from KNX preselect operation (device/progr).
Heating circuit room temp: Economy heating setpoint	Heating circuit	1	1	1	1	1	9.001	_Value_Temp	2 bytes F ₁₆	°C	-273.00...+670760.00 Floating point	COV from KNX setp adj.
Heating circuit room temp: Precomfort heating setpoint	Heating circuit	1	1	1	1	1	9.001	_Value_Temp	2 bytes F ₁₆	°C	-273.00...+670760.00 Floating point	COV from KNX setp adj.
Heating circuit room temp: Comfort heating setpoint	Heating circuit	1	1	1	1	1	9.001	_Value_Temp	2 bytes F ₁₆	°C	-273.00...+670760.00 Floating point	COV from KNX setp adj.

¹⁾ See Section 1.4.3, page 13. ⁴⁾ See Section 1.4.3, page 14. ⁵⁾ See Section 1.5.1, page 16, Standard S-mode DP.

RMK770 V2.0: Inputs

Name in ETS	DP active	Flags					Data point type KNX				Value range	RMK770 V2.0 receives:
		C	R	W	T	U	ID	DPT_Name	Format	Unit		
Confirm faults	Always	1	0	1	0	1	1.016	_Ack	1 bit B ₁	- - -	0 = No action 1 = Acknowledge / confirm	Event from KNX contact. No timeout monitoring.
Reset faults	Always	1	0	1	0	1	1.015	_Reset	1 bit B ₁	- - -	0 = No action 1 = Reset	Event from KNX contact. No timeout monitoring.
Fault transmission (enable/disable)	Always	1	0	1	0	1	1.003	_Enable	1 bit B ₁	- - -	0 = Disable 1 = Enable (default)	Event from KNX contact. "Disable" time-out monit 24 h.
Outside temperature	Receive	1	0	1	0	1	9.001	_Value_Temp	2 bytes F ₁₆	°C	-273.00...+670760.00 Floating point	COV from KNX sensor.
Boiler seq. manager: Main flow temperature setpoint relative	Boiler seq. manager	1	0	1	0	1	9.002	_Value_Tempd	2 bytes F ₁₆	K	-670760.00...+670760.00 Floating point	COV from KNX setp adj.
Heating circuit: Timer button	Heating circuit	1	0	1	0	1	1.017	_Trigger	1 bit B ₁	- - -	0 = No action 1 = Comfort prolongation ³⁾	Event from KNX contact.
Heating circuit: Comfort button	Heating circuit	1	0	1	0	1	1.017	_Trigger	1 bit B ₁	- - -	0 = No action 1 = Operating mode ch'over ³⁾	Event from KNX contact
Heating circuit room temp.: Setpoint relative	Heating circuit	1	0	1	0	1	9.002	_Value_Tempd	2 bytes F ₁₆	K	-670760.00...+670760.00 Floating point	COV from KNX setp adj.
Heating circuit: Room temperature →	Receive	1	0	1	0	1	9.001	_Value_Temp	2 bytes F ₁₆	°C	-273.00...+670760.00 Floating point	COV from KNX sensor.
Heating circuit room operating mode: Time switch operation →	Slave	1	0	1	0	1	20.102	_HVACMode	1 byte N ₈	Enum.	0 = Not used 1 = Comfort 2 = Precomfort (Standby) 3 = Economy 4 = Protection (BldgProtect) 5...255 Reserve	Event from KNX operation (device/progr). Timeout monit 31 min.

³⁾ See Section 1.4.3, page 14.

RMK770 V2.0: Outputs

Name in ETS	DP active	Flags					Data point type KNX				Value range	RMK770 V2.0 sends:
		C	R	W	T	U	ID	DPT_Name	Format	Unit		
Fault information	Always	1	0	0	1	0	219.001	_AlarmInfo ²⁾	6 bytes struct.	---	[0]...255 = Log no. [RMK = 0] [0...2]...255 = Alarm priority [0...11]...255 = Application area [0...4]...255 = Error class [0...15]...63 = Alarm attributes [0...7] = Fault state	Heartbeat 30 min.
Fault state (normal/faulty)	Always	1	0	0	1	0	1.005	_Alarm	1 bit B ₁	---	0 = No alarm (default) 1 = Alarm / faulty	Event, heart-beat 30 min.
Outside temperature	Transmit (Send)	1	0	0	1	0	9.001	_Value_Temp	2 bytes F ₁₆	°C	-273.00...+670760.00 Floating point	COV, heart-beat 15 min.
Boiler seq manager: Main flow temperature actual value	Boiler seq. manager	1	1	0	1	0	9.001	_Value_Temp	2 bytes F ₁₆	°C	-273.00...+670760.00 Floating point	COV, heart-beat 15 min.
Boiler seq manager: Flow temperature current setpoint	Boiler seq. manager	1	1	0	1	0	9.001	_Value_Temp	2 bytes F ₁₆	°C	-273.00...+670760.00 Floating point	COV, heart-beat 15 min.
Boiler seq manager: Return temperature minimum	Boiler seq. manager	1	1	0	1	0	9.001	_Value_Temp	2 bytes F ₁₆	°C	-273.00...+670760.00 Floating point	COV, heart-beat 15 min.
Boiler seq manager: Mixing valve pos maintained return temp	Boiler seq. manager	1	1	0	1	0	5.001	_Scaling	8 bit U ₈	%	[0...100] Resolution 0.4%	COV, heart-beat 3 min.
Boiler seq manager: Fault state (normal/faulty)	Boiler seq. manager	1	1	0	1	0	1.002	_Bool	1 bit B ₁	---	0 = No error (default) 1 = Boiler sequence error	Event, heart-beat 15 min.
Boiler 1...6: Actual value boiler temperature	Boiler 1...6	1	1	0	1	0	9.001	_Value_Temp	2 bytes F ₁₆	°C	-273.00...+670760.00 Floating point	COV, heart-beat 15 min.
Boiler 1...6: Boiler temperature setpoint	Boiler 1...6	1	1	0	1	0	9.001	_Value_Temp	2 bytes F ₁₆	°C	-273.00...+670760.00 Floating point	COV, heart-beat 15 min.
Boiler 1...6: Signal modulating burner	Boiler 1...6	1	1	0	1	0	5.001	_Scaling	8 bit U ₈	%	[0...100] Resolution 0.4%	COV, heart-beat 3 min.
Boiler 1...6: Burner stage 1	Boiler 1...6	1	1	0	1	0	1.003	_Enable	1 bit B ₁	---	0 = Stage 1 disabled 1 = Stage 1 enabled	Event, heart-beat 3 min.
Boiler 1...6: Burner stage 2	Boiler 1...6	1	1	0	1	0	1.003	_Enable	1 bit B ₁	---	0 = Stage 2 disabled 1 = Stage 2 enabled	Event, heart-beat 3 min.
Boiler 1...6: Flue gas temperature maximum	Boiler 1...6	1	1	0	1	0	9.001	_Value_Temp	2 bytes F ₁₆	°C	-273.00...+670760.00 Floating point	COV, heart-beat 15 min.
Boiler 1...6: Flue gas temperature limit value	Boiler 1...6	1	1	0	1	0	9.001	_Value_Temp	2 bytes F ₁₆	°C	-273.00...+670760.00 Floating point	COV, heart-beat 15 min.

²⁾ See Section 1.4.3, page 14.

RMK770 V2.0: Outputs (continued)

Name in ETS	DP active	Flags					Data point type KNX				Value range	RMK770 V2.0 sends:
		C	R	W	T	U	ID	DPT_Name	Format	Unit		
Boiler 1...6: Return temperature minimum	Boiler 1...6	1	1	0	1	0	9.001	_Value_Temp	2 bytes F ₁₆	°C	-273.00...+670760.00 Floating point	COV, heart-beat 15 min.
Boiler 1...6: Mixing valve pos maintained return temp	Boiler 1...6	1	1	0	1	0	5.001	_Scaling	8 bit U ₈	%	[0...100] Resolution 0.4%	COV, heart-beat 3 min.
Boiler 1...6: Fault state (normal/faulty)	Boiler 1...6	1	1	0	1	0	1.002	_Bool	1 bit B ₁	- - -	0 = No error (default) 1 = Boiler error	Heartbeat 3 min.
Primary controller: Flow temperature current setpoint	Primary controller	1	1	0	1	0	9.001	_Value_Temp	2 bytes F ₁₆	°C	-273.00...+670760.00 Floating point	COV, heart-beat 15 min.
Primary controller: Return temperature maximum	Primary controller	1	1	0	1	0	9.001	_Value_Temp	2 bytes F ₁₆	°C	-273.00...+670760.00 Floating point	COV, heart-beat 15 min.
Primary controller: Mixing valve position	Primary controller	1	1	0	1	0	5.001	_Scaling	8 bit U ₈	%	[0...100] Resolution 0.4%	COV, heart-beat 15 min.
Heating circuit: Flow temperature setpoint	Heating circuit	1	1	0	1	0	9.001	_Value_Temp	2 bytes F ₁₆	°C	-273.00...+670760.00 Floating point	COV, heart-beat 15 min.
Heating circuit: Return temperature maximum	Heating circuit	1	1	0	1	0	9.001	_Value_Temp	2 bytes F ₁₆	°C	-273.00...+670760.00 Floating point	COV, heart-beat 15 min.
Heating circuit: Mixing valve position	Heating circuit	1	1	0	1	0	5.001	_Scaling	8 bit U ₈	%	[0...100] Resolution 0.4%	COV, heart-beat 15 min.
Heating circuit room temp.: Current setpoint	Heating circuit	1	1	0	1	0	9.001	_Value_Temp	2 bytes F ₁₆	°C	-273.00...+670760.00 Floating point	COV, heart-beat 15 min.
Heating circuit room operating mode: State	Heating circuit	1	0	0	1	0	20.102	_HVACMode	1 byte N ₈	Enum.	0 = Not used 1 = Comfort 2 = Precomfort (Standby) 3 = Economy 4 = Protection (BldgProtect) 5...255 Reserve	COV, heart-beat 15 min.
Heating circuit: Room temperature →	Transmit	1	0	0	1	0	9.001	_Value_Temp	2 bytes F ₁₆	°C	-273.00...+670760.00 Floating point	COV, heart-beat 15 min.
Heating circuit room operating mode: Time switch operation →	Master	1	0	0	1	0	20.102	_HVACMode	1 byte N ₈	Enum.	0 = Not used 1 = Comfort 2 = Precomfort (Standby) 3 = Economy 4 = Protection (BldgProtect) 5...255 Reserve	Event, heart-beat 15 min.

- Selection of boilers 1...6 is free (e.g. boiler 2, boiler 3, and boiler 5).

RMK770 V2.0: Terminals, Boiler sequence controller RMK770 V2.0

- Input terminals N.X1...N.X8 with S-mode function "Output", parameterizable for analog input value [°C], [% rH] etc. or for digital input value [0/1].

Name in ETS	DP ⁷⁾	Flags					Data point type KNX				Value range	RMK770 V2.0 sends:
		C	R	W	T	U	ID	DPT_Name	Format	Unit		
Input N.X_ [°C]	RMK770 V2.0	1	1	0	1	0	9.001	_Value_Temp	2 bytes F ₁₆	°C	-273.00...+670760.00 Floating point	COV, heart-beat 15 min.
Input N.X_ [% rH]	RMK770 V2.0	1	1	0	1	0	9.007	_Value_Humidity	2 bytes F ₁₆	%	[0...670760]	COV, heart-beat 15 min.
Input N.X_ [0...100%]	RMK770 V2.0	1	1	0	1	0	5.001	_Scaling	8 bit U ₈	%	[0...100] Resolution 0.4%	COV, heart-beat 15 min.
Input N.X_ [0...255%]	RMK770 V2.0	1	1	0	1	0	5.004	_Percent	8 bit U ₈	%	[0...255] Resolution 1%	COV, heart-beat 15 min.
Input N.X_ [m/s]	RMK770 V2.0	1	1	0	1	0	14.065	_Value_Speed	4 bytes F ₃₂	m/s	IEEE 754 floating [0...255].[0...8388607]	COV, heart-beat 15 min.
Input N.X_ [m/s]	RMK770 V2.0	1	1	0	1	0	9.005	_Value_Wsp	2 bytes F ₁₆	m/s	[0...670760]	COV, heart-beat 15 min.
Input N.X_ [Pa]	RMK770 V2.0	1	1	0	1	0	14.058	_Value_Pressure	4 bytes F ₃₂	Pa = N/m ²	IEEE 754 floating [0...255].[0...8388607]	COV, heart-beat 15 min.
Input N.X_ [Pa]	RMK770 V2.0	1	1	0	1	0	9.006	_Value_Pres	2 bytes F ₁₆	Pa = N/m ²	[0...670760]	COV, heart-beat 15 min.
Input N.X_ [ppm]	RMK770 V2.0	1	1	0	1	0	9.008	_Value_AirQuality	2 bytes F ₁₆	ppm	[0...670760]	COV, heart-beat 15 min.
Input N.X_ [0/1]	RMK770 V2.0	1	1	0	1	0	1.001	_Switch	1 bit B ₁	- - -	0 = Off 1 = On	Event, heart-beat 15 min.

- Input terminals N.D1, N.D2 with S-mode function "Output", parameterized for digital input value [0/1].

Input N.D_ [0/1]	RMK770 V2.0	1	1	0	1	0	1.001	_Switch	1 bit B ₁	- - -	0 = Off 1 = On	Event, heart-beat 15 min.
------------------	-------------	---	---	---	---	---	-------	---------	-------------------------	-------	-------------------	---------------------------

- Output terminals N.Q1...N.Q7, parameterized for digital output value [0/1].

Output N.Q_	RMK770 V2.0	1	1	0	1	0	1.001	_Switch	1 bit B ₁	- - -	0 = Off 1 = On	Event, heart-beat 15 min.
-------------	-------------	---	---	---	---	---	-------	---------	-------------------------	-------	-------------------	---------------------------

- Output terminals N.Y1, N.Y2, parameterized for analog output value [0...100].

Output N.Y_	RMK770 V2.0	1	1	0	1	0	5.001	_Scaling	8 bit U ₈	%	[0...100] Resolution 0.4 %	COV, heart-beat 15 min.
-------------	-------------	---	---	---	---	---	-------	----------	-------------------------	---	-------------------------------	-------------------------

⁷⁾ See Section 1.5.1, page 16, S-mode DP sends 0.

RMK770 V2.0: Terminals, Extension modules RMZ78x on Boiler sequence controller RMK770 V2.0

- Input terminals A__X_ with S-mode function "Output", parameterizable for analog input value [°C], [% rH] etc. or for digital input value [0/1].

Name in ETS	DP ⁷⁾	Flags					Data point type KNX				Value range	RMK770 V2.0 sends:
		C	R	W	T	U	ID	DPT_Name	Format	Unit		
Input A__X_ [°C]	RMZ78x	1	1	0	1	0	9.001	_Value_Temp	2 bytes F ₁₆	°C	-273.00...+670760.00 Floating point	COV, heart-beat 15 min.
Input A__X_ [% rH]	RMZ78x	1	1	0	1	0	9.007	_Value_Humidity	2 bytes F ₁₆	%	[0...670760]	COV, heart-beat 15 min.
Input A__X_ [0...100%]	RMZ78x	1	1	0	1	0	5.001	_Scaling	8 bit U ₈	%	[0...100] Resolution 0.4 %	COV, heart-beat 15 min.
Input A__X_ [0...255%]	RMZ78x	1	1	0	1	0	5.004	_Percent	8 bit U ₈	%	[0...255] Resolution 1%	COV, heart-beat 15 min.
Input A__X_ [m/s]	RMZ78x	1	1	0	1	0	14.065	_Value_Speed	4 bytes F ₃₂	m/s	IEEE 754 floating [0...255].[0...8388607]	COV, heart-beat 15 min.
Input A__X_ [m/s]	RMZ78x	1	1	0	1	0	9.005	_Value_Wsp	2 bytes F ₁₆	m/s	[0...670760]	COV, heart-beat 15 min.
Input A__X_ [Pa]	RMZ78x	1	1	0	1	0	14.058	_Value_Pressure	4 bytes F ₃₂	Pa = N/m ²	IEEE 754 floating [0...255].[0...8388607]	COV, heart-beat 15 min.
Input A__X_ [Pa]	RMZ78x	1	1	0	1	0	9.006	_Value_Pres	2 bytes F ₁₆	Pa = N/m ²	[0...670760]	COV, heart-beat 15 min.
Input A__X_ [ppm]	RMZ78x	1	1	0	1	0	9.008	_Value_AirQuality	2 bytes F ₁₆	ppm	[0...670760]	COV, heart-beat 15 min.
Input A__X_ [0/1]	RMZ78x	1	1	0	1	0	1.001	_Switch	1 bit B ₁	- - -	0 = Off 1 = On	Event, heart-beat 15 min.

Input A5(1).X1...A5(1).X8	RMZ785(1)
Input A5(2).X1...A5(2).X8	RMZ785(2)
Input A5(3).X1...A5(3).X8	RMZ785(3)
Input A7(1).X1...A7(1).X4	RMZ787(1)
Input A7(2).X1...A7(2).X4	RMZ787(2)
Input A7(3).X1...A7(3).X4	RMZ787(3)
Input A8(1).X1...A8(1).X4	RMZ788(1)
Input A8(2).X1...A8(2).X4	RMZ788(2)
Input A8(3).X1...A8(3).X4	RMZ788(3)
Input A9(1).X1...A9(1).X6	RMZ789(1)
Input A9(2).X1...A9(2).X6	RMZ789(2)
Input A9(3).X1...A9(3).X6	RMZ789(3)

RMK770 V2.0: Terminals, Extension modules RMZ78x on Boiler sequence controller RMK770 V2.0 (continued)

- Output terminals A__.Q_, parameterized for digital output value [0/1].

Name in ETS	DP ⁷⁾	Flags					Data point type KNX				Value range	RMK770 V2.0 sends:
		C	R	W	T	U	ID	DPT_Name	Format	Unit		
Output A__.Q_	RMZ78x	1	1	0	1	0	1.001	_Switch	1 bit B ₁	- - -	0 = Off 1 = On	Event, heart-beat 15 min.

Output A7(1).Q1...A7(1).Q5 RMZ787(1) without Q4
 Output A7(2).Q1...A7(2).Q5 RMZ787(2) without Q4
 Output A7(3).Q1...A7(3).Q5 RMZ787(3) without Q4
 Output A8(1).Q1, A8(1).Q5 RMZ788(1)
 Output A8(2).Q1, A8(2).Q5 RMZ788(2)
 Output A8(3).Q1, A8(3).Q5 RMZ788(3)
 Output A9(1).Q1...A9(1).Q4 RMZ789(1)
 Output A9(2).Q1...A9(2).Q4 RMZ789(2)
 Output A9(3).Q1...A9(3).Q4 RMZ789(3)

- Output terminals A__.Y_, parameterized for analog output value [0...100].

Name in ETS	DP ⁷⁾	Flags					Data point type KNX				Value range	RMK770 V2.0 sends:
		C	R	W	T	U	ID	DPT_Name	Format	Unit		
Output A__.Y_	RMZ78x	1	1	0	1	0	5.001	_Scaling	8 bit U ₈	%	[0...100] Resolution 0.4 %	COV, heart-beat 15 min.

Output A8(1).Y1, A8(1).Y2 RMZ788(1)
 Output A8(2).Y1, A8(2).Y2 RMZ788(2)
 Output A8(3).Y1, A8(3).Y2 RMZ788(3)
 Output A9(1).Y1, A9(1).Y2 RMZ789(1)
 Output A9(2).Y1, A9(2).Y2 RMZ789(2)
 Output A9(3).Y1, A9(3).Y2 RMZ789(3)

Note: Max. 3 Extension modules RMZ78x (same or different types) are allowed per **Boiler sequence controller RMK770 V2.0**.

⁷⁾ See Section 1.5.1, page 16, S-mode DP sends 0.

Blank page

5 RMB795, RMB795B Central control unit

5.1 Overview

Brief description

The Synco 700 central control units RMB795 and RMB795B allows you to centrally control room groups with RXB/RXL room controllers and RDG/RDF/RDU room thermostats as well as provides menu-assisted operation of room groups.

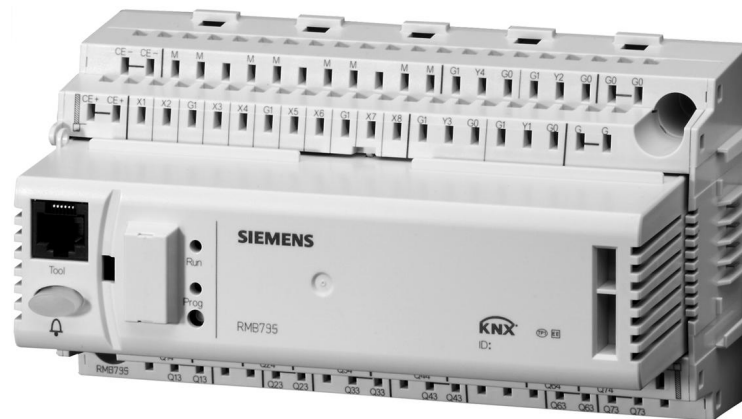

Documentation

Central control unit
RMB795

Data sheet Central control unit RMB795 **N3121**
Basic documentation Central control unit RMB795 **P3121**

Central control unit
RMB795B

Data sheet Central control unit RMB795 **N3122**
Basic documentation Central control unit RMB795 **P3122**

Number of S-mode DPs

	RMB795	RMB795B
Inputs / Outputs	3	3
Inputs and outputs	70	70
Inputs	4	27
Outputs	79	90

Column "DP active"

Indication:	Meaning:
Always	Standard S-mode DP
All appl.	S-mode DP in all applications
Room grp. 1...10	Room group 1...10 = Yes
Logic 1...10	Logic 1...10 = Send (only RMB795B)
Receive	S-mode "Receive object" (connected as input)
Transmit/Send	S-mode "Send object" (connected as output)

Note

"Always" points to a standard S-mode DP that is always configured in ETS when the Synco device is selected.

**Parameterization
RMB795, RMB795B**

An S-mode DP must be configured in ETS and the Synco device to ensure that the S-mode DP transmits (sends) valid values. See Section 1.5 on workflows.

Note

For RMB795, of a total of 156 S-mode DPs, a maximum of 50 can be connected via group addresses.
For RMB795B, all S-mode DPs can be connected via group addresses (maximal 250 group addresses).

**Universal reception and
transmission zones**

Device RMB795B allows for universal data exchange via own terminals (universal inputs, relay and analog outputs) as well as via terminals of extension modules RMZ78x. Data is exchanged via KNX.

The universal inputs can be used as reception objects in **reception zones** and as transmission (send) objects in **transmission zones**. The relays and analog outputs can only be used as transmission (send) objects.

Reception zones	Universal inputs	Terminals N.X_ and A__.X_
Transmission zones	Universal inputs	Terminals N.X_ and A__.X_
	Relay outputs	N.Q_ and A__.Q_
	Analog outputs.	N.Y_ and A__.Y_

Note

See Sections 5.3.1 to 5.3.6, pages 110 to 115:

5.2 RMB795, S-mode data points

RMB795: Inputs / Outputs

Name in ETS	DP active	Flags					Data point type KNX				Value range	RMB receives or sends:
		C	R	W	T	U	ID	DPT_Name	Format	Unit		
System time (input) System time (output)	Always ⁵⁾	1	0	1	1	1	19.001	_DateTime	8 bytes struct.	YYYY MM DD d hh mm ss ---	1900...2155 = Year 1...12 = Month 1...31 = Day of month 1...7 = Monday - Sunday 0...23 = Hours 0...59 = Minutes 0...59 = Seconds Status bits ¹⁾	From KNX system time source or to KNX system time receiver cycl. 10 min.
Date (input) Date (output)	Always	1	0	1	1	1	11.001	_Date	3 bytes struct.	DD MM YY	1...31 = Day of month 1...12 = Month 00...99 = Year ⁴⁾	From KNX date source or to KNX date receiver cycl. 10 min.
Time of day (input) Time of day (output)	Always	1	0	1	1	1	10.001	_TimeOfDay	3 bytes struct.	d hh mm ss	1...7 = Monday - Sunday 0...23 = Hours 0...59 = Minutes 0...59 = Seconds	From KNX time source or to KNX time receiver cycl. 10 min.

¹⁾ See Section 1.4.3, page 13.

⁴⁾ See Section 1.4.3, page 14.

⁵⁾ See Section 1.5.1, page 16, Standard S-mode DP.

RMB795: Inputs and outputs

S-mode DPs operated as input and output.

- Input: For operation using external device via KNX, Synco unit RMB795 receives the values of the S-mode DPs.
- Output: For operation from the Synco unit RMB795, the S-mode DP values are sent via KNX (synchronization of external unit).

Name in ETS	DP active	Flags					Data point type KNX				Value range	RMB795 rec., sends:
		C	R	W	T	U	ID	DPT_Name	Format	Unit		
[Room group 1...10] Preselection	Room grp. 1...10	1	0	1	1	1	20.102	_HVACMode	1 byte N ₈	Enum.	0 = Auto 1 = Comfort 2 = Precomfort (Standby) 3 = Economy 4 = Protection (BldgProtect) 5...255 Reserve	Event from KNX preselect operation (device/progr).
[Room group 1...10] Economy cooling setpoint	Room grp. 1...10	1	1	1	1	1	9.001	_Value_Temp	2 bytes F ₁₆	°C	-273.00...+670760.00 Floating point	COV from KNX setp adj.
[Room group 1...10] Precomfort cooling setpoint	Room grp. 1...10	1	1	1	1	1	9.001	_Value_Temp	2 bytes F ₁₆	°C	-273.00...+670760.00 Floating point	COV from KNX setp adj.
[Room group 1...10] Comfort cooling setpoint	Room grp. 1...10	1	1	1	1	1	9.001	_Value_Temp	2 bytes F ₁₆	°C	-273.00...+670760.00 Floating point	COV from KNX setp adj.
[Room group 1...10] Economy heating setpoint	Room grp. 1...10	1	1	1	1	1	9.001	_Value_Temp	2 bytes F ₁₆	°C	-273.00...+670760.00 Floating point	COV from KNX setp adj.
[Room group 1...10] Precomfort heating setpoint	Room grp. 1...10	1	1	1	1	1	9.001	_Value_Temp	2 bytes F ₁₆	°C	-273.00...+670760.00 Floating point	COV from KNX setp adj.
[Room group 1...10] Comfort heating setpoint	Room grp. 1...10	1	1	1	1	1	9.001	_Value_Temp	2 bytes F ₁₆	°C	-273.00...+670760.00 Floating point	COV from KNX setp adj.

- You can freely select room groups 1...10 (e.g. room group 2, room group 3, and room group 9).

RMB795: Inputs

Name in ETS	DP active	Flags					Data point type KNX				Value range	RMB795 receives:
		C	R	W	T	U	ID	DPT_Name	Format	Unit		
Confirm faults	Always	1	0	1	0	1	1.016	_Ack	1 bit B ₁	---	0 = No action 1 = Acknowledge / confirm	Event from KNX contact. No timeout monitoring.
Reset faults	Always	1	0	1	0	1	1.015	_Reset	1 bit B ₁	---	0 = No action 1 = Reset	Event from KNX contact. No timeout monitoring.
Fault transmission (enable/disable)	Always	1	0	1	0	1	1.003	_Enable	1 bit B ₁	---	0 = Disable 1 = Enable (default)	Event from KNX contact. "Disable" time-out monit 24 h.
Outside temperature	Receive	1	0	1	0	1	9.001	_Value_Temp	2 bytes F ₁₆	°C	-273.00...+670760.00 Floating point	COV from KNX sensor.

RMB795: Outputs

Name in ETS	DP active	Flags					Data point type KNX				Value range	RMB795 sends:
		C	R	W	T	U	ID	DPT_Name	Format	Unit		
Fault information	Always	1	0	0	1	0	219.001	_AlarmInfo ²⁾	6 bytes struct.	- - -	[0]...255 = Log no. [RMB = 0] [0...2]...255 = Alarm priority [0...14]...255 = Application area [0...4]...255 = Error class [0...15]...63 = Alarm attributes [0...7] = Fault state	Heartbeat 30 min.
Fault state (normal/faulty)	Always	1	0	0	1	0	1.005	_Alarm	1 bit B ₁	- - -	0 = No alarm (default) 1 = Alarm / faulty	Event, heartbeat 30 min.
Outside temperature.	Transmit	1	0	0	1	0	9.001	_Value_Temp	2 bytes F ₁₆	°C	-273.00...+670760.00 Floating point	COV, heartbeat 15 min.
[Room group 1...10] Emergency mode	Room grp. 1...10	1	0	0	1	0	20.106	_HVACEmergMode	1 byte N ₈	Enum.	0 = Normal 1 = Smoke extr with supply air 2 = Smoke extr with extract air 3 = Smoke extr with supp/extr air 4 = Emergency off 5 = Emergency fire alarm 6...255 Reserve	Event, heartbeat 15 min.
[Room group 1...10] State	Room grp. 1...10	1	0	0	1	0	20.102	_HVACMode	1 byte N ₈	Enum.	0 = Not used 1 = Comfort 2 = Precomfort (Standby) 3 = Economy 4 = Protection (BldgProtect) 5...255 Reserve	Event, heartbeat 15 min.
[Room group 1...10] Highest room temperature	Room grp. 1...10	1	0	0	1	0	9.001	_Value_Temp	2 bytes F ₁₆	°C	-273.00...+670760.00 Floating point	COV, heartbeat 15 min.
[Room group 1...10] Lowest room temperature	Room grp. 1...10	1	0	0	1	0	9.001	_Value_Temp	2 bytes F ₁₆	°C	-273.00...+670760.00 Floating point	COV, heartbeat 15 min.
Heating/cooling changeover	All appl.	1	0	0	1	0	1.100	_Heat/Cool	1 bit B ₁	- - -	0 = Cooling 1 = Heating (default)	Event, heartbeat 15 min.

²⁾ See Section 1.4.3, page 14.

- You can freely select room groups 1...10 (e.g. room group 2, room group 3, and room group 9).

RMB795: Terminals, Central control unit RMB795

- Input terminals N.X1...N.X6 with S-mode function "Output", parameterizable for analog input value [°C], [% rH] etc. or for digital input value [0/1].

Name in ETS	DP ⁷⁾	Flags					Data point type KNX				Value range	RMB795 sends:
		C	R	W	T	U	ID	DPT_Name	Format	Unit		
Input N.X_ [°C]	RMB795	1	1	0	1	0	9.001	_Value_Temp	2 bytes F ₁₆	°C	-273.00...+670760.00 Floating point	COV, heart-beat 15 min.
Input N.X_ [% rH]	RMB795	1	1	0	1	0	9.007	_Value_Humidity	2 bytes F ₁₆	%	[0...670760]	COV, heart-beat 15 min.
Input N.X_ [0...100%]	RMB795	1	1	0	1	0	5.001	_Scaling	8 bit U ₈	%	[0...100] Resolution 0.4%	COV, heart-beat 15 min.
Input N.X_ [0...255%]	RMB795	1	1	0	1	0	5.004	_Percent	8 bit U ₈	%	[0...255] Resolution 1%	COV, heart-beat 15 min.
Input N.X_ [m/s]	RMB795	1	1	0	1	0	14.065	_Value_Speed	4 bytes F ₃₂	m/s	IEEE 754 floating [0...255].[0...8388607]	COV, heart-beat 15 min.
Input N.X_ [m/s]	RMB795	1	1	0	1	0	9.005	_Value_Wsp	2 bytes F ₁₆	m/s	[0...670760]	COV, heart-beat 15 min.
Input N.X_ [Pa]	RMB795	1	1	0	1	0	14.058	_Value_Pressure	4 bytes F ₃₂	Pa = N/m ²	IEEE 754 floating [0...255].[0...8388607]	COV, heart-beat 15 min.
Input N.X_ [Pa]	RMB795	1	1	0	1	0	9.006	_Value_Pres	2 bytes F ₁₆	Pa = N/m ²	[0...670760]	COV, heart-beat 15 min.
Input N.X_ [ppm]	RMB795	1	1	0	1	0	9.008	_Value_AirQuality	2 bytes F ₁₆	ppm	[0...670760]	COV, heart-beat 15 min.
Input N.X_ [0/1]	RMB795	1	1	0	1	0	1.001	_Switch	1 bit B ₁	- - -	0 = Off 1 = On	Event, heart-beat 15 min.

- Output terminals N.Q1...N.Q5, parameterized for digital output value [0/1].

Output N.Q_	RMB795	1	1	0	1	0	1.001	_Switch	1 bit B ₁	- - -	0 = Off 1 = On	Event, heart-beat 15 min.
-------------	--------	---	---	---	---	---	-------	---------	-------------------------	-------	-------------------	---------------------------

- Output terminals N.Y1, N.Y2, parameterized for analog output value [0...100].

Output N.Y_	RMB795	1	1	0	1	0	5.001	_Scaling	8 bit U ₈	%	[0...100] Resolution 0.4 %	COV, heart-beat 15 min.
-------------	--------	---	---	---	---	---	-------	----------	-------------------------	---	-------------------------------	-------------------------

⁷⁾ See Section 1.5.1, page 16, S-mode DP sends 0.

RMB795: Terminals, Extension modules RMZ78x on Central control unit RMB795

- Input terminals A__X_ with S-mode function "Output", parameterizable for analog input value [°C], [% rH] etc. or for digital input value [0/1].

Name in ETS	DP ⁷⁾	Flags					Data point type KNX				Value range	RMB795 sends:
		C	R	W	T	U	ID	DPT_Name	Format	Unit		
Input A__X_ [°C]	RMZ78x	1	1	0	1	0	9.001	_Value_Temp	2 bytes F ₁₆	°C	-273.00...+670760.00 Floating point	COV, heart-beat 15 min.
Input A__X_ [% rH]	RMZ78x	1	1	0	1	0	9.007	_Value_Humidity	2 bytes F ₁₆	%	[0...670760]	COV, heart-beat 15 min.
Input A__X_ [0...100%]	RMZ78x	1	1	0	1	0	5.001	_Scaling	8 bit U ₈	%	[0...100] Resolution 0.4 %	COV, heart-beat 15 min.
Input A__X_ [0...255%]	RMZ78x	1	1	0	1	0	5.004	_Percent	8 bit U ₈	%	[0...255] Resolution 1%	COV, heart-beat 15 min.
Input A__X_ [m/s]	RMZ78x	1	1	0	1	0	14.065	_Value_Speed	4 bytes F ₃₂	m/s	IEEE 754 floating [0...255].[0...8388607]	COV, heart-beat 15 min.
Input A__X_ [m/s]	RMZ78x	1	1	0	1	0	9.005	_Value_Wsp	2 bytes F ₁₆	m/s	[0...670760]	COV, heart-beat 15 min.
Input A__X_ [Pa]	RMZ78x	1	1	0	1	0	14.058	_Value_Pressure	4 bytes F ₃₂	Pa = N/m ²	IEEE 754 floating [0...255].[0...8388607]	COV, heart-beat 15 min.
Input A__X_ [Pa]	RMZ78x	1	1	0	1	0	9.006	_Value_Pres	2 bytes F ₁₆	Pa = N/m ²	[0...670760]	COV, heart-beat 15 min.
Input A__X_ [ppm]	RMZ78x	1	1	0	1	0	9.008	_Value_AirQuality	2 bytes F ₁₆	ppm	[0...670760]	COV, heart-beat 15 min.
Input A__X_ [0/1]	RMZ78x	1	1	0	1	0	1.001	_Switch	1 bit B ₁	- - -	0 = Off 1 = On	Event, heart-beat 15 min.

Input A5.X1...A5.X8

RMZ785

Input A7(1).X1...A7(1).X4

RMZ787(1)

Input A7(2).X1...A7(2).X4

RMZ787(2)

⁷⁾ See Section 1.5.1, page 16, S-mode DP sends 0.

RMB795: Terminals, Extension modules RMZ78x on Central control unit RMB795 (continued)

- Output terminals A__.Q_, parameterized for digital output value [0/1].

Name in ETS	DP ⁷⁾	Flags					Data point type KNX				Value range	RMB795 sends:
		C	R	W	T	U	ID	DPT_Name	Format	Unit		
Output A__.Q_	RMZ78x	1	1	0	1	0	1.001	_Switch	1 bit B ₁	- - -	0 = Off 1 = On	Event, heart-beat 15 min.

Output A7(1).Q1...A7(1).Q5 RMZ787(1) without Q4
 Output A7(2).Q1...A7(2).Q5 RMZ787(2) without Q4

Note: Max. 3 Extension modules RMZ78x (same or different types) are allowed per Central control unit RMB795.

⁷⁾ See Section 1.5.1, page 16, S-mode DP sends 0.

5.3 RMB795B, S-mode data points

RMB795B: Inputs (Receive) / Outputs (Send)

Name in ETS	DP active	Flags					Data point type KNX				Value range	RMB receives <u>or</u> sends:
		C	R	W	T	U	ID	DPT_Name	Format	Unit		
System time (Receive) System time (Send)	Always ⁵⁾	1	0	1	1	1	19.001	_DateTime	8 bytes struct.	YYYY MM DD d hh mm ss ---	1900...2155 = Year 1...12 = Month 1...31 = Day of month 1...7 = Monday - Sunday 0...23 = Hours 0...59 = Minutes 0...59 = Seconds Status bits ¹⁾	From KNX system time source <u>or</u> to KNX system time receiver cycl. 10 min.
Date (Receive) Date (Send)	Always	1	0	1	1	1	11.001	_Date	3 bytes struct.	DD MM YY	1...31 = Day of month 1...12 = Month 00...99 = Year ⁴⁾	From KNX date source <u>or</u> to KNX date receiver cycl. 10 min.
Time of day (Receive) Time of day (Send)	Always	1	0	1	1	1	10.001	_TimeOfDay	3 bytes struct.	d hh mm ss	1...7 = Monday - Sunday 0...23 = Hours 0...59 = Minutes 0...59 = Seconds	From KNX time source <u>or</u> to KNX time receiver cycl. 10 min.

¹⁾ See Section 1.4.3, page 13.

⁴⁾ See Section 1.4.3, page 14.

⁵⁾ See Section 1.5.1, page 16, Standard S-mode DP.

RMB795B: Inputs (Receive) and Outputs (Send)

S-mode DPs operated as input and output.

- Input: For operation using external device via KNX, Synco unit RMB795B receives the values of the S-mode DPs.
- Output: For operation from the Synco unit RMB795B, the S-mode DP values are sent via KNX (synchronization of external unit).

Name in ETS	DP active	Flags					Data point type KNX				Value range	RMB795 rec., sends:
		C	R	W	T	U	ID	DPT_Name	Format	Unit		
[Room group 1...10] Room optg mode: Preselection	Room grp. 1...10 = Yes	1	1	1	1	1	20.102	_HVACMode	1 byte N ₈	Enum.	0 = Auto 1 = Comfort 2 = Precomfort (Standby) 3 = Economy 4 = Protection (BldgProtect) 5...255 Reserve	Event from KNX preselect operation (device/progr).
[Room group 1...10] Economy cooling setpoint	Room grp. 1...10	1	1	1	1	1	9.001	_Value_Temp	2 bytes F ₁₆	°C	-273.00...+670760.00 Floating point	COV from KNX setp adj.
[Room group 1...10] Precomfort cooling setpoint	Room grp. 1...10	1	1	1	1	1	9.001	_Value_Temp	2 bytes F ₁₆	°C	-273.00...+670760.00 Floating point	COV from KNX setp adj.
[Room group 1...10] Comfort cooling setpoint	Room grp. 1...10	1	1	1	1	1	9.001	_Value_Temp	2 bytes F ₁₆	°C	-273.00...+670760.00 Floating point	COV from KNX setp adj.
[Room group 1...10] Economy heating setpoint	Room grp. 1...10	1	1	1	1	1	9.001	_Value_Temp	2 bytes F ₁₆	°C	-273.00...+670760.00 Floating point	COV from KNX setp adj.
[Room group 1...10] Precomfort heating setpoint	Room grp. 1...10	1	1	1	1	1	9.001	_Value_Temp	2 bytes F ₁₆	°C	-273.00...+670760.00 Floating point	COV from KNX setp adj.
[Room group 1...10] Comfort heating setpoint	Room grp. 1...10	1	1	1	1	1	9.001	_Value_Temp	2 bytes F ₁₆	°C	-273.00...+670760.00 Floating point	COV from KNX setp adj.

- You can freely select room groups 1...10 (e.g. room group 2, room group 3, and room group 9).

RMB795B: Inputs (Receive)

Name in ETS	DP active	Flags					Data point type KNX				Value range	RMB795 receives:
		C	R	W	T	U	ID	DPT_Name	Format	Unit		
Confirm faults	Always	1	0	1	0	1	1.016	_Ack	1 bit B ₁	- - -	0 = No action 1 = Acknowledge / confirm	Event from KNX contact. No timeout monitoring.
Reset faults	Always	1	0	1	0	1	1.015	_Reset	1 bit B ₁	- - -	0 = No action 1 = Reset	Event from KNX contact. No timeout monitoring.
Fault transmission (enable/disable)	Always	1	0	1	0	1	1.003	_Enable	1 bit B ₁	- - -	0 = Disable 1 = Enable (default)	Event from KNX contact. "Disable" time-out monit 24 h.
Outside temperature	Receive	1	0	1	0	1	9.001	_Value_Temp	2 bytes F ₁₆	°C	-273.00...+670760.00 Floating point	COV from KNX sensor.
Heating/cooling changeover	Receive	1	0	1	0	1	1.100	_Heat/Cool	1 bit B ₁	- - -	0 = Cooling 1 = Heating (default)	Event from KNX contact. No timeout monitoring.

RMB795B: Outputs (Send)

Name in ETS	DP active	Flags					Data point type KNX				Value range	RMB795 sends:
		C	R	W	T	U	ID	DPT_Name	Format	Unit		
Fault information	Always	1	0	0	1	0	219.001	_AlarmInfo ²⁾	6 bytes struct.	---	[0]...255 = Log no. [RMB = 0] [0...2]...255 = Alarm priority [0...14]...255 = Application area [0...4]...255 = Error class [0...15]...63 = Alarm attributes [0...7] = Fault state	Heartbeat 30 min.
Fault state (normal/faulty)	Always	1	0	0	1	0	1.005	_Alarm	1 bit B ₁	---	0 = No alarm (default) 1 = Alarm / faulty	Event, heart-beat 30 min.
Outside temperature.	Send	1	0	0	1	0	9.001	_Value_Temp	2 bytes F ₁₆	°C	-273.00...+670760.00 Floating point	COV, heart-beat 15 min.
[Room group 1...10] Emergency mode	Room grp. 1...10	1	1	0	1	0	20.106	_HVACEmergMode	1 byte N ₈	Enum.	0 = Normal 1 = Smoke extr with supply air 2 = Smoke extr with extract air 3 = Smoke extr with supp/extr air 4 = Emergency off 5 = Emergency fire alarm 6...255 Reserve	Event, heart-beat 15 min.
[Room group 1...10] Room optg mode: State	Room grp. 1...10	1	1	0	1	0	20.102	_HVACMode	1 byte N ₈	Enum.	0 = Not used 1 = Comfort 2 = Precomfort (Standby) 3 = Economy 4 = Protection (BldgProtect) 5...255 Reserve	Event, heart-beat 15 min.
[Room group 1...10] Highest room temperature	Room grp. 1...10	1	1	0	1	0	9.001	_Value_Temp	2 bytes F ₁₆	°C	-273.00...+670760.00 Floating point	COV, heart-beat 15 min.
[Room group 1...10] Lowest room temperature	Room grp. 1...10	1	1	0	1	0	9.001	_Value_Temp	2 bytes F ₁₆	°C	-273.00...+670760.00 Floating point	COV, heart-beat 15 min.
Heating/cooling changeover	Send	1	1	0	1	0	1.100	_Heat/Cool	1 bit B ₁	---	0 = Cooling 1 = Heating (default)	Event, heart-beat 15 min.
[Logic 1...10] State	Send	1	1	0	1	0	1.001	_Switch	1 bit B ₁	---	0 = Off 1 = On	Event, heart-beat 15 min.

²⁾ See Section 1.4.3, page 14.

- You can freely select room groups 1...10 (e.g. room group 2, room group 3, and room group 9).

5.3.1 Terminal inputs as reception objects, RMB795B

RMB795B: Terminal inputs as reception objects

- Universal input N.X1...N.X6, parameterizable for analog input value [°C], [% rH] etc. or for digital input value [0/1]. The value can be received in S-mode via KNX.

Name in ETS	DP	Flags					Data point type KNX				Value range	RMB795B receives:
		C	R	W	T	U	ID	DPT_Name	Format	Unit		
Input N.X_ [°C]	Receive	1	0	1	0	1	9.001	_Value_Temp	2 bytes F ₁₆	°C	-273.00...+670760.00 Floating point	Event, no timeout monitoring
Input N.X_ [% rH]	Receive	1	0	1	0	1	9.007	_Value_Humidity	2 bytes F ₁₆	%	[0...670760]	Event, no timeout monitoring
Input N.X_ [0...100%]	Receive	1	0	1	0	1	5.001	_Scaling	8 bit U ₈	%	[0...100] Resolution 0.4%	Event, no timeout monitoring
Input N.X_ [0...255%]	Receive	1	0	1	0	1	5.004	_Percent	8 bit U ₈	%	[0...255] Resolution 1%	Event, no timeout monitoring
Input N.X_ [m/s]	Receive	1	0	1	0	1	14.065	_Value_Speed	4 bytes F ₃₂	m/s	IEEE 754 floating [0...255].[0...8388607]	Event, no timeout monitoring
Input N.X_ [m/s]	Receive	1	0	1	0	1	9.005	_Value_Wsp	2 bytes F ₁₆	m/s	[0...670760]	Event, no timeout monitoring
Input N.X_ [Pa]	Receive	1	0	1	0	1	14.058	_Value_Pressure	4 bytes F ₃₂	Pa = N/m ²	IEEE 754 floating [0...255].[0...8388607]	Event, no timeout monitoring
Input N.X_ [Pa]	Receive	1	0	1	0	1	9.006	_Value_Pres	2 bytes F ₁₆	Pa = N/m ²	[0...670760]	Event, no timeout monitoring
Input N.X_ [ppm]	Receive	1	0	1	0	1	9.008	_Value_AirQuality	2 bytes F ₁₆	ppm	[0...670760]	Event, no timeout monitoring
Input N.X_ [0/1]	Receive	1	0	1	0	1	1.001	_Switch	1 bit B ₁	- - -	0 = Off 1 = On	Event, no timeout monitoring

Notes:

- Receipt of an S-mode DP via input N.X_ values, that is outside the range limits ("Value high" and "Value low"), is limited by them, e.g. air velocity >20 [m/s] are limited to 20 [m/s] (when "Value high" = 20 [m/s]).
- The following priority applies to communication of data (e.g. sensor values) in S-mode and LTE mode (both modes possible at the same): Value in S-mode before value in LTE mode before terminal input value.

5.3.2 Terminal inputs as transmission (send) objects, RMB795B

RMB795B: Terminal inputs as transmission (send) objects

- Universal inputs N.X1...N.X6 can be parameterized for analog value [°C], [% rH], etc., or for digital value [0/1]. The value can be sent in S-mode via KNX.

Name in ETS	DP ⁷⁾	Flags					Data point type KNX				Value range	RMB795B sends:
		C	R	W	T	U	ID	DPT_Name	Format	Unit		
Input N.X_ [°C]	Send	1	1	0	1	0	9.001	_Value_Temp	2 bytes F ₁₆	°C	-273.00...+670760.00 Floating point	COV, heart-beat 15 min.
Input N.X_ [% rH]	Send	1	1	0	1	0	9.007	_Value_Humidity	2 bytes F ₁₆	%	[0...670760]	COV, heart-beat 15 min.
Input N.X_ [0...100%]	Send	1	1	0	1	0	5.001	_Scaling	8 bit U ₈	%	[0...100] Resolution 0.4%	COV, heart-beat 15 min.
Input N.X_ [0...255%]	Send	1	1	0	1	0	5.004	_Percent	8 bit U ₈	%	[0...255] Resolution 1%	COV, heart-beat 15 min.
Input N.X_ [m/s]	Send	1	1	0	1	0	14.065	_Value_Speed	4 bytes F ₃₂	m/s	IEEE 754 floating [0...255].[0...8388607]	COV, heart-beat 15 min.
Input N.X_ [m/s]	Send	1	1	0	1	0	9.005	_Value_Wsp	2 bytes F ₁₆	m/s	[0...670760]	COV, heart-beat 15 min.
Input N.X_ [Pa]	Send	1	1	0	1	0	14.058	_Value_Pressure	4 bytes F ₃₂	Pa = N/m ²	IEEE 754 floating [0...255].[0...8388607]	COV, heart-beat 15 min.
Input N.X_ [Pa]	Send	1	1	0	1	0	9.006	_Value_Pres	2 bytes F ₁₆	Pa = N/m ²	[0...670760]	COV, heart-beat 15 min.
Input N.X_ [ppm]	Send	1	1	0	1	0	9.008	_Value_AirQuality	2 bytes F ₁₆	ppm	[0...670760]	COV, heart-beat 15 min.
Input N.X_ [0/1]	Send	1	1	0	1	0	1.001	_Switch	1 bit B ₁	- - -	0 = Off 1 = On	Event, heart-beat 15 min.

⁷⁾ See Section 1.5.1, page 16, S-mode DP sends 0.

5.3.3 Terminal outputs as transmission (send) objects, RMB795B

RMB795B: Terminal outputs as transmission (send) objects,

- The relay outputs N.Q1...N.Q5 (without Q4), parameterized for digital output value [0/1]. The value can be sent in S-mode via KNX.

Name in ETS	DP ⁷⁾	Flags					Data point type KNX				Value range	RMB795B sends:
		C	R	W	T	U	ID	DPT_Name	Format	Unit		
Output N.Q_	Send	1	1	0	1	0	1.001	_Switch	1 bit B ₁	- - -	0 = Off 1 = On	Event, heart-beat 15 min.

- Analog outputs N.Y1...N.Y2, parameterized for analog output value [0...100]. The value can be sent in S-mode via KNX.

Name in ETS	DP ⁷⁾	Flags					Data point type KNX				Value range	RMB795B sends:
		C	R	W	T	U	ID	DPT_Name	Format	Unit		
Output N.Y_	Send	1	1	0	1	0	5.001	_Scaling	8 bit U ₈	%	[0...100] Resolution 0.4%	COV, heart-beat 15 min.

⁷⁾ See Section 1.5.1, page 16, S-mode DP sends 0.

5.3.4 Terminal inputs as reception objects, Extension modules RMZ78x

RMB795B: Terminal inputs as reception objects, Extension modules RMZ78x

- Universal inputs A_{...}X1...A_{...}X8, parameterized for analog values [°C], [% rH] etc., or digital value [0/1]. The value can be received in S-mode via KNX.

Name in ETS	DP	Flags					Data point type KNX				Value range	RMB795B receives:
		C	R	W	T	U	ID	DPT_Name	Format	Unit		
Input A _{...} X _{...} [°C]	Receive	1	0	1	0	1	9.001	_Value_Temp	2 bytes F ₁₆	°C	-273.00...+670760.00 Floating point	Event, no timeout monitoring
Input A _{...} X _{...} [% rH]	Receive	1	0	1	0	1	9.007	_Value_Humidity	2 bytes F ₁₆	%	[0...670760]	Event, no timeout monitoring
Input A _{...} X _{...} [0...100%]	Receive	1	0	1	0	1	5.001	_Scaling	8 bit U ₈	%	[0...100] Resolution 0.4%	Event, no timeout monitoring
Input A _{...} X _{...} [0...255%]	Receive	1	0	1	0	1	5.004	_Percent	8 bit U ₈	%	[0...255] Resolution 1%	Event, no timeout monitoring
Input A _{...} X _{...} [m/s]	Receive	1	0	1	0	1	14.065	_Value_Speed	4 bytes F ₃₂	m/s	IEEE 754 floating [0...255].[0...8388607]	Event, no timeout monitoring.
Input A _{...} X _{...} [m/s]	Receive	1	0	1	0	1	9.005	_Value_Wsp	2 bytes F ₁₆	m/s	[0...670760]	Event, no timeout monitoring
Input A _{...} X _{...} [Pa]	Receive	1	0	1	0	1	14.058	_Value_Pressure	4 bytes F ₃₂	Pa = N/m ²	IEEE 754 floating [0...255].[0...8388607]	Event, no timeout monitoring
Input A _{...} X _{...} [Pa]	Receive	1	0	1	0	1	9.006	_Value_Pres	2 bytes F ₁₆	Pa = N/m ²	[0...670760]	Event, no timeout monitoring
Input A _{...} X _{...} [ppm]	Receive	1	0	1	0	1	9.008	_Value_AirQuality	2 bytes F ₁₆	ppm	[0...670760]	Event, no timeout monitoring
Input A _{...} X _{...} [0/1]	Receive	1	0	1	0	1	1.001	_Switch	1 bit B ₁	- - -	0 = Off 1 = On	Event, no timeout monitoring

- Extension modules RMZ78x with universal inputs as reception objects

Input A5(1).X1...A5(1).X8	RMZ785
Input A7(1).X1...A7(1).X4	RMZ787(1)
Input A7(2).X1...A7(2).X4	RMZ787(2)

5.3.5 Terminal inputs as transm. (send) objects, Extension modules RMZ78x

RMB795B: Terminal inputs as transmission (send) objects, Extension modules RMZ78x

- Universal inputs A__X1...A__X8, can be parameterized for analog value [°C], [% rH] etc., or for digital value [0/1]. The value can be sent in S-mode via KNX.

Name in ETS	DP ⁷⁾	Flags					Data point type KNX				Value range	RMB795B sends:
		C	R	W	T	U	ID	DPT_Name	Format	Unit		
Input A__X_ [°C]	Send	1	1	0	1	0	9.001	_Value_Temp	2 bytes F ₁₆	°C	-273.00...+670760.00 Floating point	COV, heart-beat 15 min.
Input A__X_ [% rH]	Send	1	1	0	1	0	9.007	_Value_Humidity	2 bytes F ₁₆	%	[0...670760]	COV, heart-beat 15 min.
Input A__X_ [0...100%]	Send	1	1	0	1	0	5.001	_Scaling	8 bit U ₈	%	[0...100] Resolution 0.4%	COV, heart-beat 15 min.
Input A__X_ [0...255%]	Send	1	1	0	1	0	5.004	_Percent	8 bit U ₈	%	[0...255] Resolution 1%	COV, heart-beat 15 min.
Input A__X_ [m/s]	Send	1	1	0	1	0	14.065	_Value_Speed	4 bytes F ₃₂	m/s	IEEE 754 floating [0...255].[0...8388607]	COV, heart-beat 15 min.
Input A__X_ [m/s]	Send	1	1	0	1	0	9.005	_Value_Wsp	2 bytes F ₁₆	m/s	[0...670760]	COV, heart-beat 15 min.
Input A__X_ [Pa]	Send	1	1	0	1	0	14.058	_Value_Pressure	4 bytes F ₃₂	Pa = N/m ²	IEEE 754 floating [0...255].[0...8388607]	COV, heart-beat 15 min.
Input A__X_ [Pa]	Send	1	1	0	1	0	9.006	_Value_Pres	2 bytes F ₁₆	Pa = N/m ²	[0...670760]	COV, heart-beat 15 min.
Input A__X_ [ppm]	Send	1	1	0	1	0	9.008	_Value_AirQuality	2 bytes F ₁₆	ppm	[0...670760]	COV, heart-beat 15 min.
Input A__X_ [0/1]	Send	1	1	0	1	0	1.001	_Switch	1 bit B ₁	- - -	0 = Off 1 = On	Event, heart-beat 15 min.

- Extension modules RMZ78x with universal inputs as transmission (send) objects

Input A5(1).X1...A5(1).X8 RMZ785
 Input A7(1).X1...A7(1).X4 RMZ787(1)
 Input A7(2).X1...A7(2).X4 RMZ787(2)

⁷⁾ See Section 1.5.1, page 16, S-mode DP sends 0.

5.3.6 Terminal outputs as transm. (send) objects, Extension modules RMZ78x

RMB795B: Terminal outputs as transmission (send) objects, Extension modules RMZ78x

- Relay outputs A__.Q_, parameterized for digital output value [0/1]. The value can be sent in S-mode via KNX.

Name in ETS	DP ⁷⁾	Flags					Data point type KNX				Value range	RMB795B sends:
		C	R	W	T	U	ID	DPT Name	Format	Unit		
Output A__.Q_	Send	1	1	0	1	0	1.001	_Switch	1 bit B ₁	- - -	0 = Off 1 = On	Event, heart-beat 15 min.

- Extension modules RMZ787 with relay outputs as transmission (send) objects

Output A7(1).Q1...A7(1).Q5 RMZ787(1) without Q4

Output A7(2).Q1...A7(2).Q5 RMZ787(2) without Q4

Note: Max. 3 Extension modules RMZ78x are allowed per Central control unit RMB795B (1 x RMZ787 and/or max. 2 x RMZ787).

⁷⁾ See Section 1.5.1, page 16, S-mode DP sends 0.

Empty page

6 RMS705, RMS705B switching and monitoring device

6.1 Overview

Brief description

The Synco 700 switching and monitoring device RMS705 and RMS705B contains a multitude of function blocks to acquire counter values and operating hours, to log trends, and to log and record events (event logger). Furthermore, lead/lag control of aggregates with runtime equalization and, via freely configurable logic blocks, switching functions can be implemented.

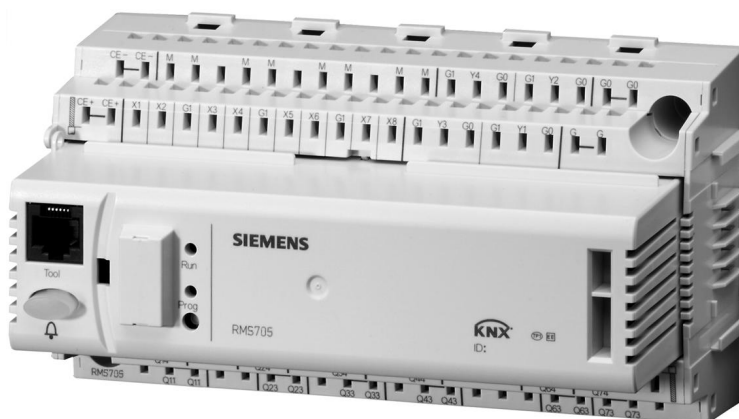

Documentation

Documentation RMS705	Data sheet	Switching and monitoring device RMS705	N3123
	Basic documentation	Switching and monitoring device RMS705	P3123
Documentation RMS705B	Data sheet	Switching and monitoring device RMS705B	N3124
	Basic documentation	Switching and monitoring device RMS705B	P3124

Number of S-mode DPs

	RMS705	RMS705B
Inputs / Outputs	3	3
Inputs and outputs	22	12
Inputs	4	37
Outputs	70	91

Column "DP active" RMS705

Indication:	Meaning:
Always	Standard S-mode DP
All appl.	S-mode DP in all applications
Controller 1...3	Controller setpoints (sequence controller) 1...3
Logic 1...10	Operation selector Logic 1...10
T'swi 1...6	Operation selector time switch 1...6
Receive	Receive outside temperature (linked as input)
Transmit	Transmit outside temperature (linked as output)

Note

"Always" points to a standard S-mode DP that is always configured in ETS when the Synco device is selected.

**Column "DP active"
RMS705B**

Indication:	Meaning:
Always	Standard S-mode DP
Controller 1...3	Controller setpoints (sequence controller) 1...3
Logic 1...10	Operation selector Logic 1...10
T'swi 1...6	Operation selector time switch 1...6
Receive	Receive outside temperature (linked as input)
Transmit	Transmit outside temperature (linked as output)
H/C chov. Receive	Receive heating/cooling changeover signal (linked as input)
H/C chov. Transmit	Transmit heating/cooling changeover signal (linked as output)
Calcul. 1, Calcul. 2	Calculator 1, Calculator 2 (calculated using formula)
Enthalpy	Dew point temperature / Wet bulb temperature
Sig-Inv	Signal doubler-inverter
Rec.object	Reception object (terminal value connected as input).
Trans. object	Transmission object (terminal value connected as output).

Note "Always" points to a standard S-mode DP that is always configured in ETS when the Synco device is selected.

**Parameterization
RMS705, RMS705B**

An S-mode DP must be configured in ETS and the Synco device to ensure that the S-mode DP transmits valid values. See Section 1.5 on workflows.

Note For RMS705, of a total of 99 S-mode DPs, a maximum of 50 can be connected via group addresses.
For RMS705B, all 143 S-mode DPs can be connected via group addresses.

**Universal reception and
transmission zones**

Device RMS705B allows for universal data exchange via own terminals (universal inputs, relay and analog outputs) as well as via terminals of extension modules RMZ78x. Data is exchanged via KNX.

The universal inputs can be used as reception objects in **reception zones** and as transmission objects in **transmission zones**. The relays and analog outputs can only be used as transmission objects.

Reception zones	Universal inputs	Terminals N.X_ and A__.X_
Transmission zones	Universal inputs	Terminals N.X_ and A__.X_
	Relay outputs	N.Q_ and A__.Q_
	Analog outputs.	N.Y_ and A__.Y_

Note See Section 6.3.1, pages 132 to 136:

Rec. object	Reception object (terminal value connected as input).
Trans. object	Transmission object (terminal value connected as output).

6.2 RMS705, S-mode data points

RMS705: Inputs / Outputs

Name in ETS	DP active	Flags					Data point type KNX				Value range	RMS receives or sends:
		C	R	W	T	U	ID	DPT_Name	Format	Unit		
System time (input) System time (output)	Always ⁵⁾	1	0	1	1	1	19.001	_DateTime	8 bytes struct.	YYYY MM DD d hh mm ss ---	1900...2155 = Year 1...12 = Month 1...31 = Day of month 1...7 = Monday - Sunday 0...23 = Hours 0...59 = Minutes 0...59 = Seconds Status bits ¹⁾	From KNX system time source or to KNX system time receiver cycl. 10 min.
Date (input) Date (output)	Always	1	0	1	1	1	11.001	_Date	3 bytes struct.	DD MM YY	1...31 = Day of month 1...12 = Month 00...99 = Year ⁴⁾	From KNX date source or to KNX date receiver cycl. 10 min.
Time of day (input) Time of day (output)	Always	1	0	1	1	1	10.001	_TimeOfDay	3 bytes struct.	d hh mm ss	1...7 = Monday - Sunday 0...23 = Hours 0...59 = Minutes 0...59 = Seconds	From KNX time source or to KNX time receiver cycl. 10 min.

¹⁾ See Section 1.4.3, page 13.

⁴⁾ See Section 1.4.3, page 14.

⁵⁾ See Section 1.5.1, page 16, Standard S-mode DP.

RMS705: Inputs and outputs

S-mode DPs operated as input and output.

- Input: For operation using external device via KNX, Synco unit RMS705 receives the values of the S-mode DPs.
- Output: For operation from the Synco unit RMS705, the S-mode DP values are sent via KNX (synchronization of external unit).

Name in ETS	DP active	Flags					Data point type KNX				Value range	RMS705 rec., sends
		C	R	W	T	U	ID	DPT_Name	Format	Unit		
[Operation selector time switch 1...6] Preselection	Ti Swi 1...6	1	0	1	1	1	20.102	_HVACMode	1 byte N ₈	Enum.	0 = Auto 1 = Comfort 2 = Precomfort (Standby) 3 = Economy 4 = Protection (BldgProtect) 5...255 Reserve	Event from KNX preselect operation (device/progr).
[Operation selector Logic 1...10] Preselection	Logic 1...10	1	0	1	1	1	(20.102)	(_HVACMode)	1 byte N ₈	Enum.	0 = --- OSV (Auto) 1 = Auto (Comfort) 2 = Off (Precomf, Standby) 3 = On (Economy) 4 = Reserve (Protection, BldgProtect) 5...255 Reserve	Event from KNX preselect operation (device/progr).
[Controller 1...3] Setpoint high [°C]	Controller 1...3	1	1	1	1	1	9.001	_Value_Temp	2 bytes F ₁₆	°C	-273.00...+670760.00 Floating point	COV from KNX setp adj.
[Controller 1...3] Setpoint low [°C]	Controller 1...3	1	1	1	1	1	9.001	_Value_Temp	2 bytes F ₁₆	°C	-273.00...+670760.00 Floating point	COV from KNX setp adj.

For [Controller 1...3], you can configure the setpoint for the various units or physical variables via the parameter "[Controller 1...3] Main controlled variable unit".

See screenshot to the right for [Controller 2].

44	[Controller 2] Setpoint high [°C]	Input and Output	2 Byte	C	R	W	T	U
45	[Controller 2] Setpoint low [°C]	Input and Output	2 Byte	C	R	W	T	U
48	Heating/cooling changeover	Output	1 bit	C	-	-	T	-

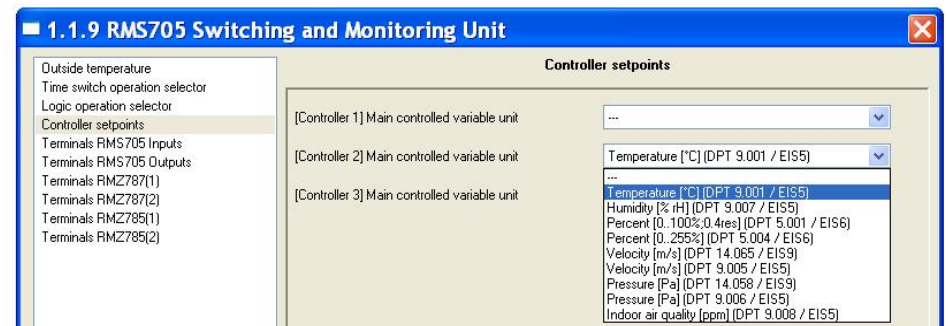

RMS705: Inputs

Name in ETS	DP active	Flags					Data point type KNX				Value range	RMS705 receives:
		C	R	W	T	U	ID	DPT_Name	Format	Unit		
Confirm faults	Always	1	0	1	0	1	1.016	_Ack	1 bit B ₁	---	0 = No action 1 = Acknowledge / confirm	Event from KNX contact. No timeout monitoring.
Reset faults	Always	1	0	1	0	1	1.015	_Reset	1 bit B ₁	---	0 = No action 1 = Reset	Event from KNX contact. No timeout monitoring.
Fault transmission (enable/disable)	Always	1	0	1	0	1	1.003	_Enable	1 bit B ₁	---	0 = Disable 1 = Enable (default)	Event from KNX contact. "Disable" time-out monit 24 h.
Outside temperature	Receive	1	0	1	0	1	9.001	_Value_Temp	2 bytes F ₁₆	°C	-273.00...+670760.00 Floating point	COV from KNX sensor.

RMS705: Outputs

Name in ETS	DP active	Flags					Data point type KNX				Value range	RMS705 sends:
		C	R	W	T	U	ID	DPT_Name	Format	Unit		
Fault information	Always	1	0	0	1	0	219.001	_AlarmInfo ²⁾	6 bytes struct.	- - -	[0]...255 = Log no. [RMS = 0] [0...2]...255 = Alarm priority [0...14]...255 = Application area [0...4]...255 = Error class [0...15]...63 = Alarm attributes [0...7] = Fault state	Heartbeat 30 min.
Fault state (normal/faulty)	Always	1	0	0	1	0	1.005	_Alarm	1 bit B ₁	- - -	0 = No alarm (default) 1 = Alarm / faulty	Event, heartbeat 30 min.
Outside temperature	Transmit	1	0	0	1	0	9.001	_Value_Temp	2 bytes F ₁₆	°C	-273.00...+670760.00 Floating point	COV, heartbeat 15 min.
[Time switch 1...6] State	T'swi 1...6	1	0	0	1	0	1.003	_Enable	1 bit B ₁	- - -	0 = Disable 1 = Enable (default)	Event, heartbeat 15 min.
[Logic 1...10] State	Logic 1...10	1	0	0	1	0	1.003	_Enable	1 bit B ₁	- - -	0 = Disable 1 = Enable (default)	Event, heartbeat 15 min.
Heating/cooling changeover	All appl.	1	0	0	1	0	1.100	_Heat/Cool	1 bit B ₁	- - -	0 = Cooling 1 = Heating (default)	Event, heartbeat 15 min.

²⁾ See Section 1.4.3, page 14.

- You can freely select time switches 1...6 and logic 1...10.

RMS705: Terminals, Switching and monitoring device RMS705

- Input terminals N.X1...N.X8 with S-mode function "Output", parameterizable for analog input value [°C], [% rH] etc. or for digital input value [0/1].

Name in ETS	DP ⁷⁾	Flags					Data point type KNX				Value range	RMS705 sends:
		C	R	W	T	U	ID	DPT_Name	Format	Unit		
Input N.X_ [°C]	RMS705	1	1	0	1	0	9.001	_Value_Temp	2 bytes F ₁₆	°C	-273.00...+670760.00 Floating point	COV, heart-beat 15 min.
Input N.X_ [% rH]	RMS705	1	1	0	1	0	9.007	_Value_Humidity	2 bytes F ₁₆	%	[0...670760]	COV, heart-beat 15 min.
Input N.X_ [0...100%]	RMS705	1	1	0	1	0	5.001	_Scaling	8 bit U ₈	%	[0...100] Resolution 0.4%	COV, heart-beat 15 min.
Input N.X_ [0...255%]	RMS705	1	1	0	1	0	5.004	_Percent	8 bit U ₈	%	[0...255] Resolution 1%	COV, heart-beat 15 min.
Input N.X_ [m/s]	RMS705	1	1	0	1	0	14.065	_Value_Speed	4 bytes F ₃₂	m/s	IEEE 754 floating [0...255].[0...8388607]	COV, heart-beat 15 min.
Input N.X_ [m/s]	RMS705	1	1	0	1	0	9.005	_Value_Wsp	2 bytes F ₁₆	m/s	[0...670760]	COV, heart-beat 15 min.
Input N.X_ [Pa]	RMS705	1	1	0	1	0	14.058	_Value_Pressure	4 bytes F ₃₂	Pa = N/m ²	IEEE 754 floating [0...255].[0...8388607]	COV, heart-beat 15 min.
Input N.X_ [Pa]	RMS705	1	1	0	1	0	9.006	_Value_Pres	2 bytes F ₁₆	Pa = N/m ²	[0...670760]	COV, heart-beat 15 min.
Input N.X_ [ppm]	RMS705	1	1	0	1	0	9.008	_Value_AirQuality	2 bytes F ₁₆	ppm	[0...670760]	COV, heart-beat 15 min.
Input N.X_ [0/1]	RMS705	1	1	0	1	0	1.001	_Switch	1 bit B ₁	- - -	0 = Off 1 = On	Event, heart-beat 15 min.

- Output terminals N.Q1...N.Q7 (without Q5), parameterized for digital output value [0/1].

Output N.Q_	RMS705	1	1	0	1	0	1.001	_Switch	1 bit B ₁	- - -	0 = Off 1 = On	Event, heart-beat 15 min.
-------------	--------	---	---	---	---	---	-------	---------	-------------------------	-------	-------------------	---------------------------

- Output terminals N.Y1...N.Y4, parameterized for analog output value [0...100].

Output N.Y_	RMS705	1	1	0	1	0	5.001	_Scaling	8 bit U ₈	%	[0...100] Resolution 0.4 %	COV, heart-beat 15 min.
-------------	--------	---	---	---	---	---	-------	----------	-------------------------	---	-------------------------------	-------------------------

⁷⁾ See Section 1.5.1, page 16, S-mode DP sends 0.

RMS705: Terminals, Extension modules RMZ78x on Switching and monitoring device RMS705

- Input terminals A__X_ with S-mode function "Output", parameterizable for analog input value [°C], [% rH] etc. or for digital input value [0/1].

Name in ETS	DP ⁷⁾	Flags					Data point type KNX				Value range	RMS705 sends:
		C	R	W	T	U	ID	DPT_Name	Format	Unit		
Input A__X_ [°C]	RMZ78x	1	1	0	1	0	9.001	_Value_Temp	2 bytes F ₁₆	°C	-273.00...+670760.00 Floating point	COV, heart-beat 15 min.
Input A__X_ [% rH]	RMZ78x	1	1	0	1	0	9.007	_Value_Humidity	2 bytes F ₁₆	%	[0...670760]	COV, heart-beat 15 min.
Input A__X_ [0...100%]	RMZ78x	1	1	0	1	0	5.001	_Scaling	8 bit U ₈	%	[0...100] Resolution 0.4 %	COV, heart-beat 15 min.
Input A__X_ [0...255%]	RMZ78x	1	1	0	1	0	5.004	_Percent	8 bit U ₈	%	[0...255] Resolution 1%	COV, heart-beat 15 min.
Input A__X_ [m/s]	RMZ78x	1	1	0	1	0	14.065	_Value_Speed	4 bytes F ₃₂	m/s	IEEE 754 floating [0...255].[0...8388607]	COV, heart-beat 15 min.
Input A__X_ [m/s]	RMZ78x	1	1	0	1	0	9.005	_Value_Wsp	2 bytes F ₁₆	m/s	[0...670760]	COV, heart-beat 15 min.
Input A__X_ [Pa]	RMZ78x	1	1	0	1	0	14.058	_Value_Pressure	4 bytes F ₃₂	Pa = N/m ²	IEEE 754 floating [0...255].[0...8388607]	COV, heart-beat 15 min.
Input A__X_ [Pa]	RMZ78x	1	1	0	1	0	9.006	_Value_Pres	2 bytes F ₁₆	Pa = N/m ²	[0...670760]	COV, heart-beat 15 min.
Input A__X_ [ppm]	RMZ78x	1	1	0	1	0	9.008	_Value_AirQuality	2 bytes F ₁₆	ppm	[0...670760]	COV, heart-beat 15 min.
Input A__X_ [0/1]	RMZ78x	1	1	0	1	0	1.001	_Switch	1 bit B ₁	- - -	0 = Off 1 = On	Event, heart-beat 15 min.

Input A5(1).X1...A5(1).X8 RMZ785(1)
 Input A5(2).X1...A5(2).X8 RMZ785(2)
 Input A7(1).X1...A8(1).X4 RMZ787(1)
 Input A7(2).X1...A8(2).X4 RMZ787(2)

⁷⁾ See Section 1.5.1, page 16, S-mode DP sends 0.

RMS705: Terminals, Extension modules RMZ78x on Switching and monitoring device RMS705 (continued)

- Output terminals A__.Q_, parameterized for digital output value [0/1].

Name in ETS	DP ⁷⁾	Flags					Data point type KNX				Value range	RMS705 sends:
		C	R	W	T	U	ID	DPT_Name	Format	Unit		
Output A__.Q_	RMZ78x	1	1	0	1	0	1.001	_Switch	1 bit B ₁	- - -	0 = Off 1 = On	Event, heart-beat 15 min.

Output A7(1).Q1...A7(1).Q5 RMZ787(1) without Q4
 Output A7(2).Q1...A7(2).Q5 RMZ787(2) without Q4

Note: Max. 3 Extension modules RMZ78x (same or different types) are allowed per **Switching and monitoring device RMS705**.

⁷⁾ See Section 1.5.1, page 16, S-mode DP sends 0.

6.3 RMS705B, S-mode data points

RMS705B: Inputs / Outputs

Name in ETS	DP active	Flags					Data point type KNX				Value range	RMS705B rec. or sends:
		C	R	W	T	U	ID	DPT_Name	Format	Unit		
System time (input) System time (output)	Always ⁵⁾	1	0	1	1	1	19.001	_DateTime	8 bytes struct.	YYYY MM DD d hh mm ss ---	1900...2155 = Year 1...12 = Month 1...31 = Day of month 1...7 = Monday - Sunday 0...23 = Hours 0...59 = Minutes 0...59 = Seconds Status bits ¹⁾	From KNX system time source or to KNX system time receiver cycl. 10 min.
Date (input) Date (output)	Always	1	0	1	1	1	11.001	_Date	3 bytes struct.	DD MM YY	1...31 = Day of month 1...12 = Month 00...99 = Year ⁴⁾	From KNX date source or to KNX date receiver cycl. 10 min.
Time of day (input) Time of day (output)	Always	1	0	1	1	1	10.001	_TimeOfDay	3 bytes struct.	d hh mm ss	1...7 = Monday - Sunday 0...23 = Hours 0...59 = Minutes 0...59 = Seconds	From KNX time source or to KNX time receiver cycl. 10 min.

¹⁾ See Section 1.4.3, page 13.

⁴⁾ See Section 1.4.3, page 14.

⁵⁾ See Section 1.5.1, page 16, Standard S-mode DP.

RMS705B: Inputs and outputs

S-mode DPs operated as input and output.

- Input: For operation using external device via KNX, Synco unit RMS705 receives the values of the S-mode DPs.
- Output: For operation from the Synco unit RMS705, the S-mode DP values are sent via KNX (synchronization of external unit).

Name in ETS	DP active	Flags					Data point type KNX				Value range	RMS705B rec., sends
		C	R	W	T	U	ID	DPT_Name	Format	Unit		
[Controller 1...3] Setpoint high [°C]	Controller 1...3	1	1	1	1	1	9.001	_Value_Temp	2 bytes F ₁₆	°C	-273.00...+670760.00 Floating point	COV from KNX setp adj.
[Controller 1...3] Setpoint low [°C]	Controller 1...3	1	1	1	1	1	9.001	_Value_Temp	2 bytes F ₁₆	°C	-273.00...+670760.00 Floating point	COV from KNX setp adj.
[Controller 1...3] Eco setpoint high [°C]	Controller 1...3	1	1	1	1	1	9.001	_Value_Temp	2 bytes F ₁₆	°C	-273.00...+670760.00 Floating point	COV from KNX setp adj.
[Controller 1...3] Eco setpoint low [°C]	Controller 1...3	1	1	1	1	1	9.001	_Value_Temp	2 bytes F ₁₆	°C	-273.00...+670760.00 Floating point	COV from KNX setp adj.

For [Controller 1...3], parameter "[Controller 1...3] Main controlled variable unit" can be used to configure the setpoint for various units or physical variables.

See screenshot (right) for [Controller 2].

33	[Controller 2] Eco setpoint high [°C]	Input and Output	2 Byte	C	R	W	T	U
34	[Controller 2] Setpoint high [°C]	Input and Output	2 Byte	C	R	W	T	U
35	[Controller 2] Setpoint low [°C]	Input and Output	2 Byte	C	R	W	T	U
36	[Controller 2] Eco setpoint low [°C]	Input and Output	2 Byte	C	R	W	T	U
37	[Controller 2] Current setpoint [°C]	Output	2 Byte	C	-	-	T	-

The screenshot displays the configuration window for '1.5.1 RMS705B Switching and Monitoring Unit'. On the left, a tree view shows the project structure, with 'Controller 2' highlighted. The main configuration area is titled 'Controller 2' and shows the parameter '[Controller 2] Main controlled variable unit'. A dropdown menu is open, showing a list of physical variables and their corresponding DPT and EIS5 values. The selected option is 'Temperature [°C] [DPT 9.001 / EIS5]'. Other visible options include Humidity [% rH], Percent [0...100%], Velocity [m/s], and Pressure [Pa].

RMS705B: Inputs

Name in ETS	DP active	Flags					Data point type KNX				Value range	RMS705B receives:
		C	R	W	T	U	ID	DPT_Name	Format	Unit		
Confirm faults	Always	1	0	1	0	1	1.016	_Ack	1 bit B ₁	- - -	0 = No action 1 = Acknowledge / confirm	Event from KNX contact. No timeout monitoring.
Reset faults	Always	1	0	1	0	1	1.015	_Reset	1 bit B ₁	- - -	0 = No action 1 = Reset	Event from KNX contact. No timeout monitoring.
Fault transmission (enable/disable)	Always	1	0	1	0	1	1.003	_Enable	1 bit B ₁	- - -	0 = Disable 1 = Enable (default)	Event from KNX contact. "Disable" time-out monit 24 h.
Outside temperature	Receive	1	0	1	0	1	9.001	_Value_Temp	2 bytes F ₁₆	°C	-273.00...+670760.00 Floating point	COV from KNX sensor.
Heating/cooling changeover	H/C chov. Receive	1	0	0	1	0	1.100	_Heat/Cool	1 bit B ₁	- - -	0 = Cooling 1 = Heating (default)	Event, heart-beat 15 min.

RMS705B: Outputs

Name in ETS	DP active	Flags					Data point type KNX				Value range	RMS705B sends:
		C	R	W	T	U	ID	DPT_Name	Format	Unit		
Fault information	Always	1	0	0	1	0	219.001	_AlarmInfo ²⁾	6 bytes struct.	---	[0]...255 = Log no. [RMS = 0] [0...2]...255 = Alarm priority [0...14]...255 = Application area [0...4]...255 = Error class [0...15]...63 = Alarm attributes [0...7] = Fault state	Heartbeat 30 min.
Fault state (normal/faulty)	Always	1	0	0	1	0	1.005	_Alarm	1 bit B ₁	---	0 = No alarm (default) 1 = Alarm / faulty	Event, heart-beat 30 min.
Outside temperature	Transmit	1	0	0	1	0	9.001	_Value_Temp	2 bytes F ₁₆	°C	-273.00...+670760.00 Floating point	COV, heart-beat 15 min.
[Time switch 1...6] State	T'swi 1...6	1	0	0	1	0	1.003	_Enable	1 bit B ₁	---	0 = Disable 1 = Enable (default)	Event, heart-beat 15 min.
[Logic 1...10] State	Logic 1...10	1	0	0	1	0	1.003	_Enable	1 bit B ₁	---	0 = Disable 1 = Enable (default)	Event, heart-beat 15 min.
[Controller 1...3] Current setpoint [°C] ⁶⁾	Controller 1...3 Transmit	1	0	0	1	0	9.001	_Value_Temp	2 bytes F ₁₆	°C	-273.00...+670760.00 Floating point	COV, heart-beat 15 min.
Heating/cooling changeover	H/C chov. Transmit	1	0	0	1	0	1.100	_Heat/Cool	1 bit B ₁	---	0 = Cooling 1 = Heating (default)	Event, heart-beat 15 min.

For the S-mode DPs (see table above).

- [Controller 1...3] Current setpoint [°C]
"Current setpoint" is displayed in the unit selected during S-mode DP configuration. Thus, "Current setpoint" can also be sent as temperature value [°C] or as humidity value [% rH], for example.

The screenshot (right) shows possible units for "Current setpoint".

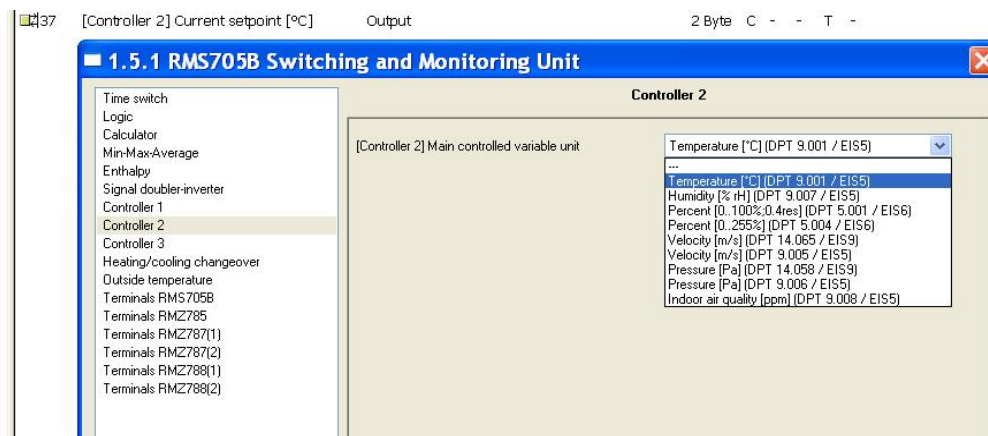

²⁾ See Section 1.4.3, page 14.

⁶⁾ See Section 1.5.1, page 16, Out of service.

RMS705B: Outputs (continued)

Name in ETS	DP active	Flags					Data point type KNX				Value range	RMS705B sends:
		C	R	W	T	U	ID	DPT_Name	Format	Unit		
[Calculator 1]	Calcul. 1	1	0	0	1	0	9.00x	EIS5	2 bytes F ₁₆	°C	-50.00...+9999.00 Floating point	COV, heart-beat 15 min.
[Calculator 2]	Calcul. 2	1	0	0	1	0	9.00x	EIS5	2 bytes F ₁₆	°C	-50.00...+9999.00 Floating point	COV, heart-beat 15 min.
[Min-Max-Average 1] A [°C]	①	1	0	0	1	0	9.001	_Value_Temp	2 bytes F ₁₆	°C	-273.00...+670760.00 Floating point	COV, heart-beat 15 min.
[Min-Max-Average 1] B [°C]		1	0	0	1	0	9.001	_Value_Temp	2 bytes F ₁₆	°C	-273.00...+670760.00 Floating point	COV, heart-beat 15 min.
[Min-Max-Average 2] A [ppm]	②	1	0	0	1	0	9.008	_Value_AirQuality	2 bytes F ₁₆	ppm	[0...670760]	COV, heart-beat 15 min.
[Min-Max-Average 2] B [ppm]		1	0	0	1	0	9.008	_Value_AirQuality	2 bytes F ₁₆	ppm	[0...670760]	COV, heart-beat 15 min.
[Min-Max-Average 1] A [% rH]	③	1	0	0	1	0	9.007	_Value_Humidity	2 bytes F ₁₆	%	[0...670760]	COV, heart-beat 15 min.
[Min-Max-Average 1] B [0...100%]		1	0	0	1	0	5.001	_Scaling	8 bit U ₈	%	[0...100] Resolution 0.4%	COV, heart-beat 15 min.
[Min-Max-Average 2] A [°C]	④	1	0	0	1	0	9.001	_Value_Temp	2 bytes F ₁₆	°C	-273.00...+670760.00 Floating point	COV, heart-beat 15 min.
[Min-Max-Average 2] B [0...255%]		1	0	0	1	0	5.004	_Percent	8 bit U ₈	%	[0...255] Resolution 1%	COV, heart-beat 15 min.

Min-Max-Average: Calculates the minimum or maximum or average value from 5 input values or (if inputs are splitted) from 2 and 3 input values.

- ① [Min-Max-Average 1] Inputs splitted = **No** → [Min-Max-Average 1] = Temperature [°C] or Humidity [% rH], Percent [0...100%], Percent [0...255%], Indoor air quality [ppm]
- ② [Min-Max-Average 2] Inputs splitted = **No** → [Min-Max-Average 2] = Indoor air quality [ppm]
 Note on ① and ② Inputs splitted = **No** → 1A and 1B or 2A and 2B always have the same unit, e.g. ① [°C], ② [ppm] or [% rH] [0...100%] [0...255%]
- ③ [Min-Max-Average 1] Inputs splitted = **Yes** → [Min-Max-Average 1] A = Humidity [% rH] or Temperature [°C], Percent [0...100%], Percent [0...255%], Indoor air quality [ppm]
 [Min-Max-Average 1] Inputs splitted = **Yes** → [Min-Max-Average 1] B = Percent [0...100%]
- ④ [Min-Max-Average 2] Inputs splitted = **Yes** → [Min-Max-Average 2] A = Temperature [°C]
 [Min-Max-Average 2] Inputs splitted = **Yes** → [Min-Max-Average 2] B = Percent [0...255%]
 Note on ③ and ④ Inputs splitted = **Yes** → 1A, 1B, 2A, 2B can have different units: [°C] [% rH] [0...100%] [0...255%] [ppm]

RMS705B: Outputs (continued)

Name in ETS	DP active	Flags					Data point type KNX				Value range	RMS705B sends:
		C	R	W	T	U	ID	DPT_Name	Format	Unit		
[Enthalpy] Dew point temperature	Enthalpy	1	0	0	1	0	9.001	_Value_DewPnt	2 bytes F ₁₆	°C	-273.00...+670760.00 Floating point	COV, heart-beat 15 min.
[Enthalpy] Wet bulb temperature		1	0	0	1	0	9.001	_Value_WetBlb	2 bytes F ₁₆	°C	-273.00...+670760.00 Floating point	COV, heart-beat 15 min.
[Signal doubler-inverter] A	Sig-Inv	1	0	0	1	0	5.001	_Scaling	8 bit U ₈	%	[0...100] Resolution 0.4%	COV, heart-beat 15 min.
[Signal doubler-inverter] B		1	0	0	1	0	5.001	_Scaling	8 bit U ₈	%	[0...100] Resolution 0.4%	COV, heart-beat 15 min.

6.3.1 Terminal inputs and outputs as reception or transmission objects

RMS705B: Terminal inputs as reception objects, Switching and monitoring device RMS705B

- Universal input N.X1...N.X8, parameterizable for analog input value [°C], [% rH] etc. or for digital input value [0/1]. The value can be received in S-mode via KNX.

Name in ETS	DP	Flags					Data point type KNX				Value range	RMS705B receives:
		C	R	W	T	U	ID	DPT_Name	Format	Unit		
Input N.X_ [°C]	Rec. object	1	0	1	0	1	9.001	_Value_Temp	2 bytes F ₁₆	°C	-273.00...+670760.00 Floating point	Event, no timeout monitoring
Input N.X_ [% rH]	Rec. object	1	0	1	0	1	9.007	_Value_Humidity	2 bytes F ₁₆	%	[0...670760]	Event, no timeout monitoring
Input N.X_ [0...100%]	Rec. object	1	0	1	0	1	5.001	_Scaling	8 bit U ₈	%	[0...100] Resolution 0.4%	Event, no timeout monitoring
Input N.X_ [0...255%]	Rec. object	1	0	1	0	1	5.004	_Percent	8 bit U ₈	%	[0...255] Resolution 1%	Event, no timeout monitoring
Input N.X_ [m/s]	Rec. object	1	0	1	0	1	14.065	_Value_Speed	4 bytes F ₃₂	m/s	IEEE 754 floating [0...255].[0...8388607]	Event, no timeout monitoring
Input N.X_ [m/s]	Rec. object	1	0	1	0	1	9.005	_Value_Wsp	2 bytes F ₁₆	m/s	[0...670760]	Event, no timeout monitoring
Input N.X_ [Pa]	Rec. object	1	0	1	0	1	14.058	_Value_Pressure	4 bytes F ₃₂	Pa = N/m ²	IEEE 754 floating [0...255].[0...8388607]	Event, no timeout monitoring
Input N.X_ [Pa]	Rec. object	1	0	1	0	1	9.006	_Value_Pres	2 bytes F ₁₆	Pa = N/m ²	[0...670760]	Event, no timeout monitoring
Input N.X_ [ppm]	Rec. object	1	0	1	0	1	9.008	_Value_AirQuality	2 bytes F ₁₆	ppm	[0...670760]	Event, no timeout monitoring
Input N.X_ [0/1]	Rec. object	1	0	1	0	1	1.001	_Switch	1 bit B ₁	- - -	0 = Off 1 = On	Event, no timeout monitoring

Notes:

- Receipt of an S-mode DP via input N.X_ values, that is outside the range limits ("Value high" and "Value low"), is limited by them, e.g. air velocity >20 [m/s] are limited to 20 [m/s] (when "Value high" = 20 [m/s]).
- The following priority applies to communication of data (e.g. sensor values) in S-mode and LTE mode (both modes possible at the same): Value in S-mode before value in LTE mode before terminal input value.

RMS705B: Terminal inputs as transmission objects, switching and monitoring device RMS705B

- Universal inputs N.X1...N.X8 can be parameterized for analog value [°C], [% rH], etc., or for digital value [0/1]. The value can be sent in S-mode via KNX.

Name in ETS	DP ⁷⁾	Flags					Data point type KNX				Value range	RMS705B sends:
		C	R	W	T	U	ID	DPT_Name	Format	Unit		
Input N.X_ [°C]	Trans. object	1	1	0	1	0	9.001	_Value_Temp	2 bytes F ₁₆	°C	-273.00...+670760.00 Floating point	COV, heart-beat 15 min.
Input N.X_ [% rH]	Trans. object	1	1	0	1	0	9.007	_Value_Humidity	2 bytes F ₁₆	%	[0...670760]	COV, heart-beat 15 min.
Input N.X_ [0...100%]	Trans. object	1	1	0	1	0	5.001	_Scaling	8 bit U ₈	%	[0...100] Resolution 0.4%	COV, heart-beat 15 min.
Input N.X_ [0...255%]	Trans. object	1	1	0	1	0	5.004	_Percent	8 bit U ₈	%	[0...255] Resolution 1%	COV, heart-beat 15 min.
Input N.X_ [m/s]	Trans. object	1	1	0	1	0	14.065	_Value_Speed	4 bytes F ₃₂	m/s	IEEE 754 floating [0...255].[0...8388607]	COV, heart-beat 15 min.
Input N.X_ [m/s]	Trans. object	1	1	0	1	0	9.005	_Value_Wsp	2 bytes F ₁₆	m/s	[0...670760]	COV, heart-beat 15 min.
Input N.X_ [Pa]	Trans. object	1	1	0	1	0	14.058	_Value_Pressure	4 bytes F ₃₂	Pa = N/m ²	IEEE 754 floating [0...255].[0...8388607]	COV, heart-beat 15 min.
Input N.X_ [Pa]	Trans. object	1	1	0	1	0	9.006	_Value_Pres	2 bytes F ₁₆	Pa = N/m ²	[0...670760]	COV, heart-beat 15 min.
Input N.X_ [ppm]	Trans. object	1	1	0	1	0	9.008	_Value_AirQuality	2 bytes F ₁₆	ppm	[0...670760]	COV, heart-beat 15 min.
Input N.X_ [0/1]	Trans. object	1	1	0	1	0	1.001	_Switch	1 bit B ₁	- - -	0 = Off 1 = On	Event, heart-beat 15 min.

⁷⁾ See Section 1.5.1, page 16, S-mode DP sends 0.

RMS705B: Terminal outputs as transmission objects, switching and monitoring device RMS705B

- The relay outputs N.Q1...N.Q7 (without Q5), parameterized for digital output value [0/1]. The value can be sent in S-mode via KNX.

Output N.Q_	Trans. object	1	1	0	1	0	1.001	_Switch	1 bit B ₁	- - -	0 = Off 1 = On	Event, heart-beat 15 min.
-------------	---------------	---	---	---	---	---	-------	---------	-------------------------	-------	-------------------	---------------------------

- Analog outputs N.Y1...N.Y4, parameterized for analog output value [0...100]. The value can be sent in S-mode via KNX.

Output N.Y_	Trans. object	1	1	0	1	0	5.001	_Scaling	8 bit U ₈	%	[0...100] Resolution 0.4%	COV, heart-beat 15 min.
-------------	---------------	---	---	---	---	---	-------	----------	-------------------------	---	------------------------------	-------------------------

RMS705B: Terminal inputs as reception objects, Extension modules RMZ78x on the Switching and monitoring device RMS705B

- Universal inputs A__X1...A__X8, parameterized for analog values [°C], [% rH] etc., or digital value [0/1]. The value can be received in S-mode via KNX.

Name in ETS	DP	Flags					Data point type KNX				Value range	RMS705B receives:
		C	R	W	T	U	ID	DPT_Name	Format	Unit		
Input A__X_ [°C]	Rec. object	1	0	1	0	1	9.001	_Value_Temp	2 bytes F ₁₆	°C	-273.00...+670760.00 Floating point	Event, no timeout monitoring
Input A__X_ [% rH]	Rec. object	1	0	1	0	1	9.007	_Value_Humidity	2 bytes F ₁₆	%	[0...670760]	Event, no timeout monitoring
Input A__X_ [0...100%]	Rec. object	1	0	1	0	1	5.001	_Scaling	8 bit U ₈	%	[0...100] Resolution 0.4%	Event, no timeout monitoring
Input A__X_ [0...255%]	Rec. object	1	0	1	0	1	5.004	_Percent	8 bit U ₈	%	[0...255] Resolution 1%	Event, no timeout monitoring
Input A__X_ [m/s]	Rec. object	1	0	1	0	1	14.065	_Value_Speed	4 bytes F ₃₂	m/s	IEEE 754 floating [0...255].[0...8388607]	Event, no timeout monitoring
Input A__X_ [m/s]	Rec. object	1	0	1	0	1	9.005	_Value_Wsp	2 bytes F ₁₆	m/s	[0...670760]	Event, no timeout monitoring
Input A__X_ [Pa]	Rec. object	1	0	1	0	1	14.058	_Value_Pressure	4 bytes F ₃₂	Pa = N/m ²	IEEE 754 floating [0...255].[0...8388607]	Event, no timeout monitoring
Input A__X_ [Pa]	Rec. object	1	0	1	0	1	9.006	_Value_Pres	2 bytes F ₁₆	Pa = N/m ²	[0...670760]	Event, no timeout monitoring
Input A__X_ [ppm]	Rec. object	1	0	1	0	1	9.008	_Value_AirQuality	2 bytes F ₁₆	ppm	[0...670760]	Event, no timeout monitoring
Input A__X_ [0/1]	Rec. object	1	0	1	0	1	1.001	_Switch	1 bit B ₁	- - -	0 = Off 1 = On	Event, no timeout monitoring

- Extension modules RMZ78x with universal inputs as reception objects

Input A5(1).X1...A5(1).X8 RMZ785
 Input A7(1).X1...A7(1).X4 RMZ787(1)
 Input A7(2).X1...A7(2).X4 RMZ787(2)
 Input A8(1).X1...A8(1).X4 RMZ788(1)
 Input A8(2).X1...A8(2).X4 RMZ788(2)

RMS705B: Terminal inputs as transmission objects, Extension modules RMZ78x on the Switching and monitoring device RMS705B

- Universal inputs A_{...}X1...A_{...}X8, can be parameterized for analog value [°C], [% rH] etc., or for digital value [0/1]. The value can be sent in S-mode via KNX.

Name in ETS	DP ⁷⁾	Flags					Data point type KNX				Value range	RMS705B sends:
		C	R	W	T	U	ID	DPT_Name	Format	Unit		
Input A _{...} X _{...} [°C]	Trans. object	1	1	0	1	0	9.001	_Value_Temp	2 bytes F ₁₆	°C	-273.00...+670760.00 Floating point	COV, heart-beat 15 min.
Input A _{...} X _{...} [% rH]	Trans. object	1	1	0	1	0	9.007	_Value_Humidity	2 bytes F ₁₆	%	[0...670760]	COV, heart-beat 15 min.
Input A _{...} X _{...} [0...100%]	Trans. object	1	1	0	1	0	5.001	_Scaling	8 bit U ₈	%	[0...100] Resolution 0.4%	COV, heart-beat 15 min.
Input A _{...} X _{...} [0...255%]	Trans. object	1	1	0	1	0	5.004	_Percent	8 bit U ₈	%	[0...255] Resolution 1%	COV, heart-beat 15 min.
Input A _{...} X _{...} [m/s]	Trans. object	1	1	0	1	0	14.065	_Value_Speed	4 bytes F ₃₂	m/s	IEEE 754 floating [0...255].[0...8388607]	COV, heart-beat 15 min.
Input A _{...} X _{...} [m/s]	Trans. object	1	1	0	1	0	9.005	_Value_Wsp	2 bytes F ₁₆	m/s	[0...670760]	COV, heart-beat 15 min.
Input A _{...} X _{...} [Pa]	Trans. object	1	1	0	1	0	14.058	_Value_Pressure	4 bytes F ₃₂	Pa = N/m ²	IEEE 754 floating [0...255].[0...8388607]	COV, heart-beat 15 min.
Input A _{...} X _{...} [Pa]	Trans. object	1	1	0	1	0	9.006	_Value_Pres	2 bytes F ₁₆	Pa = N/m ²	[0...670760]	COV, heart-beat 15 min.
Input A _{...} X _{...} [ppm]	Trans. object	1	1	0	1	0	9.008	_Value_AirQuality	2 bytes F ₁₆	ppm	[0...670760]	COV, heart-beat 15 min.
Input A _{...} X _{...} [0/1]	Trans. object	1	1	0	1	0	1.001	_Switch	1 bit B ₁	- - -	0 = Off 1 = On	Event, heart-beat 15 min.

- Extension modules RMZ78x with universal inputs as transmission objects

Input A5(1).X1...A5(1).X8	RMZ785
Input A7(1).X1...A7(1).X4	RMZ787(1)
Input A7(2).X1...A7(2).X4	RMZ787(2)
Input A8(1).X1...A8(1).X4	RMZ788(1)
Input A8(2).X1...A8(2).X4	RMZ788(2)

⁷⁾ See Section 1.5.1, page 16, S-mode DP sends 0.

RMS705B: Terminal outputs as transmission objects, Extension modules RMZ78x on the Switching and monitoring device RMS705B

- Relay outputs A__Q_, parameterized for digital output value [0/1]. The value can be sent in S-mode via KNX.

Name in ETS	DP ⁷⁾	Flags					Data point type KNX				Value range	RMS705B sends:
		C	R	W	T	U	ID	DPT_Name	Format	Unit		
Output A__Q_	Trans. object	1	1	0	1	0	1.001	_Switch	1 bit B ₁	---	0 = Off 1 = On	Event, heart-beat 15 min.

- Extension modules RMZ78x with relay outputs as transmission objects

Output A7(1).Q1...A7(1).Q5	RMZ787(1) without Q4
Output A7(2).Q1...A7(2).Q5	RMZ787(2) without Q4
Output A8(1).Q1, A8(1).Q5	RMZ788(1)
Output A8(2).Q1, A8(2).Q5	RMZ788(2)

- Analog outputs A__Y_, parameterized for analog output value [0...100]. The value can be sent in S-mode via KNX.

Name in ETS	DP ⁷⁾	Flags					Data point type KNX				Value range	RMS705B sends:
		C	R	W	T	U	ID	DPT_Name	Format	Unit		
Output A__Y_	Trans. object	1	1	0	1	0	5.001	_Scaling	8 bit U ₈	%	[0...100] Resolution 0.4%	COV, heart-beat 15 min.

- Extension modules RMZ78x with analog outputs as transmission objects

Output A8(1).Y1, A8(1).Y2	RMZ788(1)
Output A8(2).Y1, A8(2).Y2	RMZ788(2)

Note: Max. 4 Extension modules RMZ78x (same or different types) are allowed per Switching and monitoring device RMS705B.

⁷⁾ See Section 1.5.1, page 16, S-mode DP sends 0.

7 RMZ792, RMZ792B Bus operator units

7.1 Overview

Brief description

Synco 700 bus operator units RMZ792 and RMZ792B are used to operate Synco 700 control units via KNX. They can be installed e.g. in control panels or used for mobile application.

Note

The bus operator units does not allow to configure and commission the devices on the KNX network. To do this, use the RMZ790, RMZ791 operator units locally or together with the OCI700.1 service tool via KNX.



Documentation

Data sheet	Bus operator unit RMZ792 Series B	N3113
Basic documentation	Bus operator unit RMZ792 Series B	P3113

Number of S-mode DPs

	RMZ792, RMZ792B
Inputs	5
Outputs	2

Parameterization

An S-mode DP must be configured in ETS and the Synco device to ensure that the S-mode DP transmits valid values. See Section 1.5 on workflows.

Note

ETS configures all S-mode DPs after selecting the bus operator unit.

7.2 RMZ792, RMZ792B, S-mode data points

RMZ792, RMZ792B: Inputs

Name in ETS	Flags					Data point type KNX				Value range	RMZ... receives:
	C	R	W	T	U	ID	DPT_Name	Format	Unit		
System time	1	0	1	0	1	19.001	_DateTime	8 bytes struct.	YYYY MM DD d hh mm ss ---	1900...2155 = Year 1...12 = Month 1...31 = Day of month 1...7 = Monday - Sunday 0...23 = Hours 0...59 = Minutes 0...59 = Seconds Status bits ¹⁾	From KNX system time source, cycl.
Date	1	0	1	0	1	11.001	_Date	3 bytes struct.	DD MM YY	1...31 = Day of month 1...12 = Month 00...99 = Year ⁴⁾	From KNX date source, cycl. 10 min.
Time	1	0	1	0	1	10.001	_TimeOfDay	3 bytes struct.	d hh mm ss	1...7 = Monday - Sunday 0...23 = Hours 0...59 = Minutes 0...59 = Seconds	From KNX time source, cycl. 10 min.

¹⁾ See Section 1.4.3, page 13.

⁴⁾ See Section 1.4.3, page 14.

Note on system time, date, time

- Contrary to Synco 700 control devices with master/slave function and input/output, the RMZ792, RMZ792B bus operator units can only receive system time, date and time, i.e. slave function, input only.

RMZ792, RMZ792B: Inputs (continued)

Name in ETS	Flags					Data point type KNX				Value range	RMZ... receives:
	C	R	W	T	U	ID	DPT_Name	Format	Unit		
Confirm faults	1	0	1	0	1	1.016	_Ack	1 bit B ₁	---	0 = No action 1 = Acknowledge / confirm	Event from KNX contact. No timeout monitoring.
Fault transmission (enable/disable)	1	0	1	0	1	1.003	_Enable	1 bit B ₁	---	0 = Disable 1 = Enable (default)	Event from KNX contact. "Disable" time-out monit 48 h.

RMZ792, RMZ792B: Outputs

Name in ETS	Flags					Data point type KNX				Value range	RMZ... sends:
	C	R	W	T	U	ID	DPT_Name	Format	Unit		
Fault information	1	0	0	1	0	219.001	_AlarmInfo ²⁾	6 bytes struct.	---	[0]...255 = Log no.[RMZ = 0] [0...2]...255 = Alarm priority [0...10]...255 = Application area [0...4]...255 = Error class [0...15]...63 = Alarm attributes [0...7] = Fault state	Heartbeat 30 min.
Fault state (normal/faulty)	1	0	0	1	0	1.005	_Alarm	1 bit B ₁	---	0 = No alarm / normal (default) 1 = Alarm / faulty	Event, heart-beat 30 min.

²⁾ See Section 1.4.3, page 14.

Blank page

8 OZW771 Central communication unit

8.1 Overview

Brief description

The central communication unit OZW771 is used to remote control and supervise HVAC plants and Synco 700 devices in KNX networks (for 4, 10, or 64 devices depending on the type of OZW771.xx).

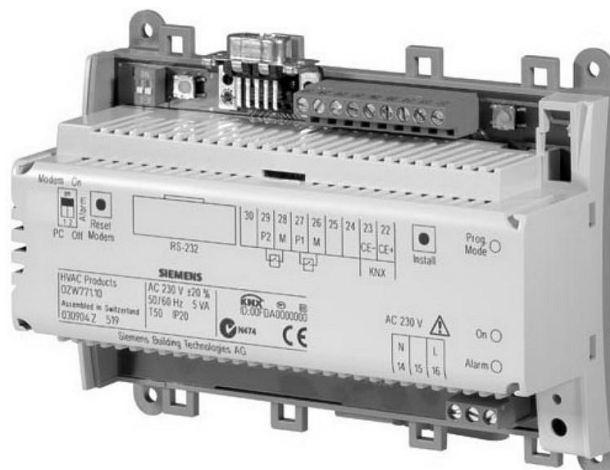

Documentation

Data sheet Central communication unit OZW771.xx **N3117**
Basic documentation Central communication unit OZW771.xx **P3117**

Number of S-mode DPs

	OZW771.xx
Inputs / Outputs	3
Inputs	1
Outputs	4

Parameterization

An S-mode DP must be configured in ETS and the Synco device to ensure that the S-mode DP transmits valid values. See Section 1.5 on workflows.

Note

ETS configures all S-mode DPs after selecting the central communication unit.

8.2 OZW771, S-mode data points

OZW771: Inputs / Outputs

Name in ETS	Flags					Data point type KNX				Value range	OZW receives <u>or</u> sends:
	C	R	W	T	U	ID	DPT_Name	Format	Unit		
System time (input) System time (output)	1	0	1	1	1	19.001	_DateTime	8 bytes struct.	YYYY MM DD d hh mm ss ---	1900...2155 = Year 1...12 = Month 1...31 = Day of month 1...7 = Monday - Sunday 0...23 = Hours 0...59 = Minutes 0...59 = Seconds Status bits ¹⁾	From KNX system time source <u>or</u> to KNX system time receiver cycl. 10 min.
Date (input) Date (output)	1	0	1	1	1	11.001	_Date	3 bytes struct.	DD MM YY	1...31 = Day of month 1...12 = Month 00...99 = Year ⁴⁾	From KNX date source <u>or</u> to KNX date receiver cycl. 10 min
Time of day (input) Time of day (output)	1	0	1	1	1	10.001	_TimeOfDay	3 bytes struct.	d hh mm ss	1...7 = Monday - Sunday 0...23 = Hours 0...59 = Minutes 0...59 = Seconds	From KNX time source <u>or</u> to KNX time receiver cycl. 10 min.

¹⁾ See Section 1.4.3, page 13.

⁴⁾ See Section 1.4.3, page 14.

OZW771: Inputs

Name in ETS	Flags					Data point type KNX				Value range	OZW771 receives:
	C	R	W	T	U	ID	DPT_Name	Format	Unit		
Fault transmission (enable/disable)	1	0	1	0	1	1.003	_Enable	1 bit B ₁	---	0 = Disable 1 = Enable (default)	Event from KNX contact. "Disable" time-out monit 48 h.

OZW771: Outputs

Name in ETS	Flags					Data point type KNX				Value range	OZW771 sends:
	C	R	W	T	U	ID	DPT_Name	Format	Unit		
Fault information	1	0	0	1	0	219.001	_AlarmInfo ²⁾	6 bytes struct.	---	[0]...255 = Log no.[OZW = 0] [0...2]...255 = Alarm priority [0...10]...255 = Application area [0...4]...255 = Error class [0...15]...63 = Alarm attributes [0...7] = Fault state	Heartbeat 30 min.
Fault state (normal/faulty)	1	0	0	1	0	1.005	_Alarm	1 bit B ₁	---	0 = No alarm (default) 1 = Alarm / faulty	Event, heart-beat 30 min.
Fault 1	1	0	0	1	0	1.006	_BinaryValue	1 bit B ₁	---	0 = Low / no fault (default) 1 = High / fault	Event, heart-beat 30 min.
Fault 2	1	0	0	1	0	1.006	_BinaryValue	1 bit B ₁	---	0 = Low / no fault (default) 1 = High / fault	Event, heart-beat 30 min.

²⁾ See Section 1.4.3, page 14.

Fault 1 and Fault 2

- The OZW771 central communication unit transmits the state pending at "Fault input 1" and "Fault input 2".

Blank page

9 OZW775 Central communication unit

9.1 Overview

Brief description

The OZW775 Central communication unit allows for remote operation and monitoring of HVAC plants comprising max. 250 Synco devices, and for operation using a web browser from Version 2.0.

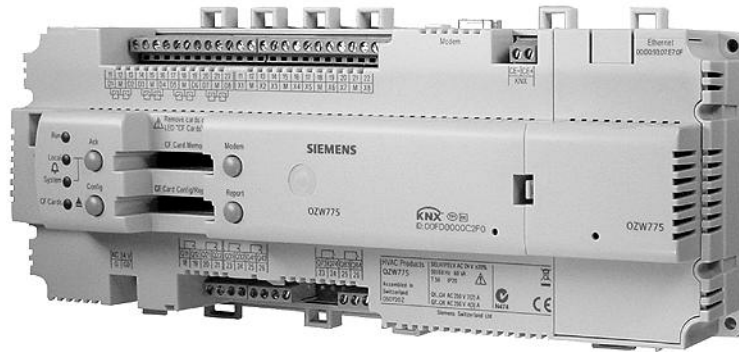

Documentation

Data sheet Central communication unit OZW775 **N5663**
Commissioning instructions Central communication unit OZW775 **C5663**

Number of S-mode DPs

	OZW775	OZW775 from V2.0
Inputs / Outputs	3	3
Inputs	2	2
Outputs	2	2 (+26, see table on page 148)

Parameterization

An S-mode DP must be configured in ETS and the Synco device to ensure that the S-mode DP transmits valid values. See Section 1.5 on workflows.

Note

ETS configures all S-mode DPs after selecting the central communication unit.

9.2 OZW775, S-mode data points

OZW775: Inputs / Outputs

Name in ETS	Flags					Data point type KNX				Value range	OZW receives or sends:
	C	R	W	T	U	ID	DPT_Name	Format	Unit		
System time (input) System time (output)	1	0	1	1	1	19.001	_DateTime	8 bytes struct.	YYYY MM DD d hh mm ss ---	1900...2155 = Year 1...12 = Month 1...31 = Day of month 1...7 = Monday - Sunday 0...23 = Hours 0...59 = Minutes 0...59 = Seconds Status bits ¹⁾	From KNX system time source or to KNX system time receiver cycl. 10 min.
Date (input) Date (output)	1	0	1	1	1	11.001	_Date	3 bytes struct.	DD MM YY	1...31 = Day of month 1...12 = Month 00...99 = Year ⁴⁾	From KNX date source or to KNX date receiver cycl. 10 min.
Time of day (input) Time of day (output)	1	0	1	1	1	10.001	_TimeOfDay	3 bytes struct.	d hh mm ss	1...7 = Monday - Sunday 0...23 = Hours 0...59 = Minutes 0...59 = Seconds	From KNX time source or to KNX time receiver cycl. 10 min.

¹⁾ See Section 1.4.3, page 13.

⁴⁾ See Section 1.4.3, page 14.

OZW775: Inputs

Name in ETS	Flags					Data point type KNX				Value range	OZW775 receives:
	C	R	W	T	U	ID	DPT_Name	Format	Unit		
Confirm faults	1	0	1	0	1	1.016	_Ack	1 bit B ₁	---	0 = No action 1 = Acknowledge / confirm	Event from KNX contact. No timeout monitoring.
Fault transmission (enable/disable)	1	0	1	0	1	1.003	_Enable	1 bit B ₁	---	0 = Disable 1 = Enable (default)	Event from KNX contact. "Disable" time-out monit 48 h.

OZW775: Outputs

Name in ETS	Flags					Data point type KNX				Value range	OZW775 sends:
	C	R	W	T	U	ID	DPT_Name	Format	Unit		
Fault information	1	0	0	1	0	219.001	_AlarmInfo ²⁾	6 bytes struct.	---	[0]...255 = Log no.[OZW = 0] [0...2]...255 = Alarm priority [0...10]...255 = Application area [0...4]...255 = Error class [0...15]...63 = Alarm attributes [0...7] = Fault state	Heartbeat 30 min.
Fault state (normal/faulty)	1	0	0	1	0	1.005	_Alarm	1 bit B ₁	---	0 = No alarm (default) 1 = Alarm / faulty	Event, heart-beat 30 min.

²⁾ See Section 1.4.3, page 14.

OZW775 from V2.0: Outputs

Input N.D1...8 and input N.X1...8 with S-mode function "Output"

- The S-mode DPs of OZW775 (new SW version) send the values pending at terminals D1...D8 (digital inputs [0/1]) and X1...X8 (analog inputs [C°], [% rH] etc.) via KNX (e.g. value transmission to an display unit).

Name in ETS	DP	Flags					Data point type KNX				Value range	OZW775 sends:
		C	R	W	T	U	ID	DPT_Name	Format	Unit		
Input N.D1...8	Digital input	1	1	0	1	0	1.001	_Switch	1 bit B ₁	- - -	0 = Off 1 = On	Event, heart-beat 15 min.
Input N.X1...8 [°C]	Temperature	1	1	0	1	0	9.001	_Value_Temp	2 bytes F ₁₆	°C	-273.00...+670760.00 Floating point	COV, heart-beat 15 min.
Input N.X1...8 [% rH]	Humidity	1	1	0	1	0	9.007	_Value_Humidity	2 bytes F ₁₆	%	[0...670760]	COV, heart-beat 15 min.
Input N.X1...8 [0...100%]	Percent	1	1	0	1	0	5.001	_Scaling	8 bit U ₈	%	[0...100] Resolution 0.4%	COV, heart-beat 15 min.
Input N.X1...8 [0...255%]	Percent	1	1	0	1	0	5.004	_Percent	8 bit U ₈	%	[0...255] Resolution 1%	COV, heart-beat 15 min.
Input N.X1...8 [m/s]	Speed	1	1	0	1	0	14.065	_Value_Speed	4 bytes F ₃₂	m/s	IEEE 754 floating [0...255].[0...8388607]	COV, heart-beat 15 min.
Input N.X1...8 [m/s]	Speed	1	1	0	1	0	9.005	_Value_Wsp	2 bytes F ₁₆	m/s	[0...670760]	COV, heart-beat 15 min.
Input N.X1...8 [Pa]	Pressure	1	1	0	1	0	14.058	_Value_Pressure	4 bytes F ₃₂	Pa = N/m ²	IEEE 754 floating [0...255].[0...8388607]	COV, heart-beat 15 min.
Input N.X1...8 [Pa]	Pressure	1	1	0	1	0	9.006	_Value_Pres	2 bytes F ₁₆	Pa = N/m ²	[0...670760]	COV, heart-beat 15 min.
Input N.X1...8 [ppm]	Air quality	1	1	0	1	0	9.008	_Value_AirQuality	2 bytes F ₁₆	ppm	[0...670760]	COV, heart-beat 15 min.
Input N.X1...8 [0/1]	Digital input	1	1	0	1	0	1.001	_Switch	1 bit B ₁	- - -	0 = Off 1 = On	Event, heart-beat 15 min.
Output N.Q1...4, N.Q7, N.Q8	Digital output	1	1	0	1	0	1.001	_Switch	1 bit B ₁	- - -	0 = Off 1 = On	Event, heart-beat 15 min.
[Time switch 1...4] State	Digital output	1	0	0	1	0	1.001	_Switch	1 bit B ₁	- - -	0 = Off 1 = On	Event, heart-beat 15 min.

10 OZW772 Web server

10.1 Overview

Brief description

Web server OZW772 V2.0 can connect 1 to 64 devices and OZW772 V3.0 1 to 250 devices from the product ranges: Synco 700, Synco RXB/RXL, Synco room thermostats RDF/RDU/RDG, and Synco living QAX9xx central apartment units.

Web servers OZW772... allows local operation/monitoring as well as remote operation/monitoring of Synco devices in a KNX network via web browser, smartphone and/or ACS operator station (PC/Laptop with ACS Commissioning and plant operating software).



Documentation

Data sheet	Web server OZW772...	N5701
Commissioning instructions	Web server OZW772...	C5701

Number of S-mode DPs

	OZW772...
Inputs / Outputs	3
Inputs	2
Outputs	2

Parameterization

An S-mode DP must be configured in ETS and the Synco device to ensure that the S-mode DP transmits valid values. See Section 1.5 on workflows.

Note

ETS configures all S-mode DPs after selecting the web server.

10.2 OZW772, S-mode data points

OZW772: Inputs / Outputs

Name in ETS	Flags					Data point type KNX				Value range	OZW receives <u>or</u> sends:
	C	R	W	T	U	ID	DPT_Name	Format	Unit		
System time (input) System time (output)	1	0	1	1	1	19.001	_DateTime	8 bytes struct.	YYYY MM DD d hh mm ss ---	1900...2155 = Year 1...12 = Month 1...31 = Day of month 1...7 = Monday - Sunday 0...23 = Hours 0...59 = Minutes 0...59 = Seconds Status bits ¹⁾	From KNX system time source <u>or</u> to KNX system time receiver cycl. 10 min.
Date (input) Date (output)	1	0	1	1	1	11.001	_Date	3 bytes struct.	DD MM YY	1...31 = Day of month 1...12 = Month 00...99 = Year ⁴⁾	From KNX date source <u>or</u> to KNX date receiver cycl. 10 min
Time of day (input) Time of day (output)	1	0	1	1	1	10.001	_TimeOfDay	3 bytes struct.	d hh mm ss	1...7 = Monday - Sunday 0...23 = Hours 0...59 = Minutes 0...59 = Seconds	From KNX time source <u>or</u> to KNX time receiver cycl. 10 min.

¹⁾ See Section 1.4.3, page 13.

⁴⁾ See Section 1.4.3, page 14.

OZW772: Inputs

Name in ETS	Flags					Data point type KNX				Value range	OZW775 receives:
	C	R	W	T	U	ID	DPT_Name	Format	Unit		
Confirm faults	1	0	1	0	1	1.016	_Ack	1 bit B ₁	---	0 = No action 1 = Acknowledge / confirm	Event from KNX contact. No timeout monitoring.
Fault transmission (enable/disable)	1	0	1	0	1	1.003	_Enable	1 bit B ₁	---	0 = Disable 1 = Enable (default)	Event from KNX contact. "Disable" time-out monit 48 h.

OZW772: Outputs

Name in ETS	Flags					Data point type KNX				Value range	OZW775 sends:
	C	R	W	T	U	ID	DPT_Name	Format	Unit		
Fault information	1	0	0	1	0	219.001	_AlarmInfo ²⁾	6 bytes struct.	---	[0]...255 = Log no.[OZW = 0] [0...2]...255 = Alarm priority [0...10]...255 = Application area [0...4]...255 = Error class [0...15]...63 = Alarm attributes [0...7] = Fault state	Heartbeat 30 min.
Fault state (normal/faulty)	1	0	0	1	0	1.005	_Alarm	1 bit B ₁	---	0 = No alarm (default) 1 = Alarm / faulty	Event, heart-beat 30 min.

²⁾ See Section 1.4.3, page 14.

Blank page

11 QAW740 Room unit

11.1 Overview

Brief description

The QAW740 room unit is a digital, multifunctional room unit. It has an LCD to display room temperature, operating mode or room setpoint adjustments.

The operating elements on the room unit allow for remote intervention in the control functions of the Synco 700 controllers. Both remote intervention and acquired room temperature are transmitted to the same-zone controller via KNX.

Note: The QAW740 room unit is not suited for use with the RXB room controllers.



Documentation

Data sheet	Room unit QAW740	N1633
Installation and operating instructions	Room unit QAW740	B1633
	(multilingual, enclosed with unit)	

Number of S-mode DPs

- Outputs 2

Parameterization

An S-mode DP must be configured in ETS and the Synco device to ensure that the S-mode DP transmits valid values. See Section 1.5 on workflows.

Note

ETS configures all S-mode DPs after selecting the room unit.

11.2 QAW740, S-mode data points

QAW740: Outputs

Name in ETS	Flags					Data point type KNX				Value range	QAW740 sends:
	C	R	W	T	U	ID	DPT_Name	Format	Unit		
Room temperature	1	0	0	1	0	9.001	_Value_Temp	2 bytes F ₁₆	°C	-273.00...+670760.00 Floating point ^{*)}	COV, heart-beat 15 min.
Room temperature: Setpoint relative	1	0	0	1	0	9.002	_Value_Tempd	2 bytes F ₁₆	K	-670760.00...+670760.00 Floating point ^{**)}	COV, heart-beat 15 min.

^{*)} For the QAW740 room unit, the value range is limited to measuring range 0...45 °C.

^{**)} For the QAW740 room unit, the value range is limited to a setpoint readjustment of ± 3 K (relative to setpoint).

12 RDF301, RDF301.50, RDF600KN Room thermostats

12.1 Overview

Brief description

Room thermostat RDF301, RDF301.50 and RDF600KN are used for applications with fan coils and heat pumps. Type RDF301.50 also has buttons for lighting and blinds control via KNX.

The room thermostats have an LCD to display (depending on operating function) room temperature, room setpoint, outside air temperature, operating mode, fan speed, alarm state and time.

The operating elements allow for remote intervention in the control functions.



RDF301.50



RDF301 / RDF600KN

Documentation

Data sheet	Room thermostats RDF301... / RDF600KN	N3171
Operating instructions	Room thermostats RDF301... / RDF600KN	B3171
Basic documentation	Room thermostats RDF301... / RDF600KN	P3171

Number of S-mode DPs

	RDF301 RDF600KN	RDF301.50
Inputs and outputs ¹⁾	2	2
Outputs and inputs (Synchronization inputs) ²⁾	---	4
Inputs	19	19
Output	20	32

¹⁾ Input and Output S-mode DP receives a value, e.g. the setpoint from an external setpoint default
S-mode DP sends a value, e.g. the setpoint to another (third-party) device.

²⁾ Output and Input S-mode DP sends primarily one value.
S-mode DP receives a value, if the parameter setting:
→ Function button ... = Toggle is selected, i.e. the button is used as toggle (switch), e.g. lighting control. The input is synchronized with the output (of another device). An input with this function is identified as "synchronization input".

Column "DP visible in ETS"

The data in column "DP visible in ETS" (see table below) refers to parameter settings where the S-mode DP is visible in the ETS.

Parameterization

An S-mode DP must be configured in ETS and the Synco device to ensure that the S-mode DP transmits valid values. See Section 1.5 on workflows.

12.2 RDF301, RDF301.50, RDF600KN, S-mode data points

RDF301... / RDF600KN: Inputs and outputs

Name in ETS	DP visible in ETS	Flags					Data point type KNX				Value range	RDF receives, sends:
		C	R	W	T	U	ID	DPT_Name	Format	Unit		
Room operating mode: Preselection	①	1	0	1	1	1	20.102	_HVACMode	1 byte N ₈	Enum.	0 = Auto 1 = Comfort 2 = Precomfort, mapped in 1 or 3 3 = Economy 4 = Protection (BldgProtect) 5...255 Reserve	Receives event from KNX preselect operation (device/progr). Sends at local change (local operation).
Room temperature: Comfort setpoint	②	1	0	1	1	1	9.001	_Value_Temp	2 bytes F ₁₆	°C	-273.00...+670760.00 Floating point LCD display 5...40 °C	Receives event from KNX preselect operation (device/progr). Sends at local change (local operation).

① Preselection reception: Group object type = 1 byte (Enumeration)

② Room temperature: Comfort setpoint = Yes

RDF301.50: Outputs and inputs (Synchronization inputs)

Name in ETS	DP visible in ETS	Flags					Data point type KNX				Value range	RDF sends, receives:
		C	R	W	T	U	ID	DPT_Name	Format	Unit		
Button top left: On/Off	①	1	0	1	1	1	1.001	_Switch	1 bit B ₁	---	0 = Off 1 = On	Sends button activation (output). <u>and</u> Receives (as Event via KNX) the button activation (Synchronization input).
Button bottom left: On/Off	②	1	0	1	1	1	1.001	_Switch	1 bit B ₁	---	0 = Off 1 = On	
Button top right: On/Off	③	1	0	1	1	1	1.001	_Switch	1 bit B ₁	---	0 = Off 1 = On	
Button bottom right: On/Off	④	1	0	1	1	1	1.001	_Switch	1 bit B ₁	---	0 = Off 1 = On	

- ① Function buttons left = Switch → On/Off function = Twice On/Off → Function button top = Toggle
- ② Function buttons left = Switch → On/Off function = Twice On/Off → Function button bottom = Toggle
- ③ Function buttons right = Switch → On/Off function = Twice On/Off → Function button top = Toggle
- ④ Function buttons right = Switch → On/Off function = Twice On/Off → Function button bottom = Toggle



RDF301... / RDF600KN: Inputs

Name in ETS	DP visible in ETS	Flags					Data point type KNX				Value range	RDF receives:
		C	R	W	T	U	ID	DPT_Name	Format	Unit		
System time	Always ⁵⁾	1	0	1	0	1	19.001	_DateTime	8 bytes struct.	YYYY MM DD d hh mm ss ---	1900...2155 = Year 1...12 = Month 1...31 = Day of month 1...7 = Monday - Sunday 0...23 = Hours 0...59 = Minutes 0...59 = Seconds Status bits ¹⁾	KNX system clock (for RDF weekday and time).
Time of day	Always	1	0	1	0	1	10.001	_TimeOfDay	3 bytes struct.	d hh mm ss	1...7 = Monday - Sunday 0...23 = Hours 0...59 = Minutes 0...59 = Seconds	KNX clock.
Fault transmission (enable/disable)	Always	1	0	1	0	1	1.003	_Enable	1 bit B ₁	---	0 = Disable 1 = Enable (default)	Event from KNX contact.
Room operating mode: Preselection Auto	①	1	0	1	0	0	1.001	_Switch	1 bit B ₁	---	0 = Not used 1 = Auto	Event from KNX preselect operation (device/progr). No reception timeout.
Room operating mode: Preselection Comfort		1	0	1	0	0	1.001	_Switch	1 bit B ₁	---	0 = Not used 1 = Comfort	
Room operating mode: Preselection Economy		1	0	1	0	0	1.001	_Switch	1 bit B ₁	---	0 = Not used 1 = Economy	
Room operating mode: Preselection Protection		1	0	1	0	0	1.001	_Switch	1 bit B ₁	---	0 = Not used 1 = Protection	

① Preselection reception: Group object type = 1 bit

¹⁾ See Section 1.4.3, page 13.

⁵⁾ See Section 1.5.1, page 16, Standard S-mode DP.

RDF301... / RDF600KN: Inputs (continued)

Name in ETS	DP visible in ETS	Flags					Data point type KNX				Value range	RDF receives:
		C	R	W	T	U	ID	DPT_Name	Format	Unit		
Room operating mode: Time switch	①	1	0	1	0	1	20.102	_HVACMode	1 byte N ₈	Enum.	1 = Comfort 2 = Precomfort, mapped in 1 or 3 3 = Economy 4 = Protection (BldgProtect) 5...255 Reserve	Event from KNX preselect operation (device/progr).
Room operating mode: Time switch Comfort	②	1	0	1	0	0	1.001	_Switch	1 bit B ₁	---	0 = Not used 1 = Comfort	Event from KNX preselect operation (device/progr).
Room operating mode: Time switch Economy		1	0	1	0	0	1.001	_Switch	1 bit B ₁	---	0 = Not used 1 = Economy	
Room operating mode: Time switch Protection		1	0	1	0	0	1.001	_Switch	1 bit B ₁	---	0 = Not used 1 = Protection	
Room operating mode: Window state	③	1	0	1	0	1	1.019	_Window_Door	1 bit B ₁	---	0 = Closed 1 = Open	Event from window contact (via KNX).
Room temperature: Comfort basic setpoint	④	1	0	1	0	1	9.001	_Value_Temp	2 bytes F ₁₆	°C	-273.00...+670760.00 Floating point LCD display 5...40 °C (default = 21 °C)	Event from KNX preselect operation (device/progr).
Enable electric heater	⑤	1	0	1	0	1	1.003	_Enable	1 bit B ₁	---	0 = Disable 1 = Enable (default)	Event from KNX preselect operation (device/progr).
Heating/cooling changeover	⑥	1	0	1	0	1	1.100	_Heat/Cool	1 bit B ₁	---	0 = Cooling 1 = Heating (default)	Event from KNX preselect operation (device/progr).

- ① Time switch reception: Group object type = 1 byte (Enumeration)
- ② Time switch reception: Group object type = 1 bit
- ③ Window state input = Bus Note: The S-mode DP has no function if window contact is recorded locally via terminal input.
- ④ Room temperature: Comfort basic setpoint = Receive
- ⑤ Plant type = 2-pipe with electric heater Note: The S-mode DP has no function if the enable is recorded locally via the terminal input.
- ⑥ Plant type (all) → Control sequence = H/C changeover auto

RDF301... / RDF600KN: Inputs (continued)

Name in ETS	DP visible in ETS	Flags					Data point type KNX				Value range	RDF receives:
		C	R	W	T	U	ID	DPT_Name	Format	Unit		
Application mode	①	1	0	1	0	1	20.105	_HVACContrMode	1 byte N ₈	Enum.	0 = Auto 1 = Heat 2 = Heat 3 = Cool 4 = Auto 5 = Cool 6 = Off 7 = Auto 8 = Heat 9 = Fan only 10 = Cool 11...255 = Reserve	Event from KNX mode preselection (device/progr), especially from Synco living central apartment units.
Enable fan command value	②	1	0	1	0	1	1.003	_Enable	1 bit B ₁	- - -	0 = Disable 1 = Enable (default)	Event from KNX preselect operation (device/progr).
Fan command value	③	1	0	1	0	1	5.001	_Scaling	8 bit U ₈	%	[0...100] Resolution 0.4%	Event from KNX preselect operation (device/progr).
Outside temperature	④	1	0	1	0	1	9.001	_Value_Temp	2 bytes F ₁₆	°C	-273.00...+670760.00 Floating point LCD display -99...655.3 °C	COV from outside air sensor.

- ① Plant type (all) → Application mode = Receive
- ② Fan operation = Yes → Enable/disable command value = Receive
- ③ Fan operation = Yes → Fan speed: Command value and output [%] = Yes
- ④ Outside temperature = Receive

RDF301... / RDF600KN: Outputs

Name in ETS	DP visible in ETS	Flags					Data point type KNX				Value range	RDF sends:
		C	R	W	T	U	ID	DPT_Name	Format	Unit		
Fault information	Always	1	0	0	1	0	219.001	_AlarmInfo ²⁾	6 bytes strukt.	---	[0]...255 = Log no. [RDF = 0] [0...2]...255 = Alarm priority [0...11]...255 = Application area [0...4]...255 = Error class [0...15]...63 = Alarm attributes [0...7] = Fault state	Event, heart-beat 30 min.
Fault state (normal/faulty)	Always	1	0	0	1	0	1.005	_Alarm	1 bit B ₁	---	0 = No alarm (default) 1 = Alarm / faulty	Event, heart-beat 30 min.
Room operating mode: State	①	1	1	0	1	0	20.102	_HVACMode	1 byte N ₈	Enum.	0 = Auto (Not used) 1 = Comfort 2 = PreComfort (Not used) 3 = Economy 4 = Protection (BldgProtect) 5...255 Reserve	Event, heart-beat 15 min.
Room operating mode: State Comfort	②	1	0	0	1	0	1.001	_Switch	1 bit B ₁	---	0 = Not used 1 = Comfort	Event, last change of state applies. No heartbeat.
Room operating mode: State Economy		1	0	0	1	0	1.001	_Switch	1 bit B ₁	---	0 = Not used 1 = Economy	
Room operating mode: State Protection		1	0	0	1	0	1.001	_Switch	1 bit B ₁	---	0 = Not used 1 = Protection	
Room temperature	③	1	1	0	1	0	9.001	_Value_Temp	2 bytes F ₁₆	°C	-273.00...+670760.00 Floating point LCD display 0...49 °C	COV, heart-beat 15 min.
Room temperature: Current setpoint	④	1	1	0	1	0	9.001	_Value_Temp	2 bytes F ₁₆	°C	-273.00...+670760.00 Floating point LCD display 5...40 °C	Event, heart-beat 15 min.
Heating output primary	⑤	1	1	0	1	0	5.001	_Scaling	8 bit U ₈	%	[0...100] Resolution 0.4%	Event, heart-beat 15 min.

① State transmission: Group object type = 1 byte (Enumeration)

② State transmission: Group object type = 1 bit

③ Room temperature = Transmit

④ Room temperature: Current setpoint = Transmit

⑤ Plant type (all) → Control sequence = Heating only or H/C changeover auto or H/K changeover manual

²⁾ See Section 1.4.3, page 14.

RDF301... / RDF600KN: Outputs (continued)

Name in ETS	DP visible in ETS	Flags					Data point type KNX				Value range	RDF sends:
		C	R	W	T	U	ID	DPT_Name	Format	Unit		
Heating output secondary	①	1	1	0	1	0	5.001	_Scaling	8 bit U ₈	%	[0...100] Resolution 0.4%	Event, heart-beat 15 min.
Cooling output primary	②	1	1	0	1	0	5.001	_Scaling	8 bit U ₈	%	[0...100] Resolution 0.4%	Event, heart-beat 15 min.
Fan operation (0=Auto/1=Manual)	③	1	1	0	1	0	1.001	_Switch	1 bit B ₁	---	0 = Auto 1 = Manual	Event, heart-beat 15 min.
Fan output	④	1	1	0	1	0	5.001	_Scaling	8 bit U ₈	%	[0...100] Resolution 0.4%	Event, heart-beat 15 min.
Fan speed 1	⑤	1	1	0	1	0	1.001	_Switch	1 bit B ₁	---	0 = Off 1 = On	Event, heart-beat 15 min.
Fan speed 2		1	1	0	1	0	1.001	_Switch	1 bit B ₁	---	0 = Off 1 = On	
Fan speed 3		1	1	0	1	0	1.001	_Switch	1 bit B ₁	---	0 = Off 1 = On	
X1: Temperature [°C]	⑥	1	1	0	1	0	9.001	_Value_Temp	2 bytes F ₁₆	°C	-273.00...+670760.00 Floating point LCD display 0...49 °C	COV, heart-beat 15 min.
X1: Digital [0/1]	⑦	1	1	0	1	0	1.001	_Switch	1 bit B ₁	---	0 = Off 1 = On	Event, heart-beat 15 min.
X2: Temperature [°C]	⑧	1	1	0	1	0	9.001	_Value_Temp	2 bytes F ₁₆	°C	-273.00...+670760.00 Floating point LCD display 0...49 °C	COV, heart-beat 15 min.
X2: Digital [0/1]	⑨	1	1	0	1	0	1.001	_Switch	1 bit B ₁	---	0 = Off 1 = On	Event, heart-beat 15 min.

- ① Plant type = 2-pipe with electric heater
 ② Plant type (all) → Control sequence = Cooling only or H/C changeover auto or H/C changeover manual
 ③ Fan operation = Yes → Current operating mode = Transmit
 ④ Fan operation = Yes → Fan speed: Command value and output [%] = Yes
 ⑤ Fan operation = Yes → Fan speed: Speed 1...3 = Yes
 ⑥ Universal input X1 = Temperature [°C]
 ⑦ Universal input X1 = Digital [0/1]
 ⑧ Universal input X2 = Temperature [°C]
 ⑨ Universal input X2 = Digital [0/1]

RDF301.50: Outputs

Name in ETS	DP visible in ETS	Flags					Data point type KNX				Value range	RDF sends:
		C	R	W	T	U	ID	DPT_Name	Format	Unit		
Buttons left: On/Off Button top left: On/Off	① / ④ ②	1	0	0	1	0	1.001	_Switch	1 bit B ₁	---	0 = Off 1 = On	Event for button activation.
Button bottom left: On/Off	③	1	0	0	1	0	1.001	_Switch	1 bit B ₁	---	0 = Off 1 = On	Event for button activation.
Buttons left: Dim up/down	④	1	0	0	1	0	3.007	_Control_Dimming	4 bit U ₄	---	On/Off via switching U ₄ U ₃ U ₂ U ₁ 0 0 0 1 = Darker 1 0 0 1 = Brighter 0 0 0 0 = Stop	Event for button activation.
Buttons left: Blind step/stop	⑤	1	0	0	1	0	1.007	_Step	1 bit B ₁	---	0 = Step up 1 = Step down	Event for button activation.
Buttons left: Blind up/down		1	0	0	1	0	1.008	_UpDown	1 bit B ₁	---	0 = Up 1 = Down	Event for button activation.
Buttons left: Scene	⑥	1	0	0	1	0	18.001	_SceneControl	1 byte B ₁ r ₁ U ₆	---	B ₁ 0 = Activate scene 1 = Learn scene r ₁ = (Reserve) U ₆ = Scene number 0...63	Event for button activation.

- ① Function buttons left = Switch → On/Off function = Top: On / Bottom: Off
- ② Function buttons left = Switch → On/Off function = Twice On/Off → Function button top = On or Function button top = Off
- ③ Function buttons left = Switch → On/Off function = Twice On/Off → Function button bottom = On or Function button bottom = Off
- ④ Function buttons left = Dim
- ⑤ Function buttons left = Blind
- ⑥ Function buttons left = Scene

RDF301.50: Outputs (continued)

Name in ETS	DP visible in ETS	Flags					Data point type KNX				Value range	RDF sends:
		C	R	W	T	U	ID	DPT_Name	Format	Unit		
Buttons right: On/Off Button top right: On/Off	① / ④ ②	1	0	0	1	0	1.001	_Switch	1 bit B ₁	---	0 = Off 1 = On	Event for button activation.
Button bottom right: On/Off	③	1	0	0	1	0	1.001	_Switch	1 bit B ₁	---	0 = Off 1 = On	Event for button activation.
Buttons right: Dim up/down	④	1	0	0	1	0	3.007	_Control_Dimming	4 bit U ₄	---	On/Off via switching U ₄ U ₃ U ₂ U ₁ 0 0 0 1 = Darker 1 0 0 1 = Brighter 0 0 0 0 = Stop	Event for button activation.
Buttons right: Blind step/stop	⑤	1	0	0	1	0	1.007	_Step	1 bit B ₁	---	0 = Step up 1 = Step down	Event for button activation.
Buttons right: Blind up/down		1	0	0	1	0	1.008	_UpDown	1 bit B ₁	---	0 = Up 1 = Down	Event for button activation.
Buttons right: Scene	⑥	1	0	0	1	0	18.001	_SceneControl	1 byte B ₁ r ₁ U ₆	---	B ₁ 0 = Activate scene 1 = Learn scene r ₁ = (Reserve) U ₆ = Scene number 0...63	Event for button activation.

- ① Function buttons right = Switch → On/Off function = Top: On / Bottom: Off
 ② Function buttons right = Switch → On/Off function = Twice On/Off → Function button top = On or Function button top = Off
 ③ Function buttons right = Switch → On/Off function = Twice On/Off → Function button bottom = On or Function button bottom = Off
 ④ Function buttons right = Dim
 ⑤ Function buttons right = Blind
 ⑥ Function buttons right = Scene

13 RDU341 Room thermostat

13.1 Overview

Brief description

Room thermostat RDU341 is used for VAV applications. It has an LCD to display (depending on operating function) room temperature, room setpoint, outside air temperature, operating mode, alarm state and time.

The operating elements on the room unit allow for remote intervention in the control functions.



Documentation

Data sheet	Room thermostat RDU341	N3172
Operating instructions	Room thermostat RDU341	B3172
Basic documentation	Room thermostat RDU341	P3172

Number of S-mode DPs

	RDU341
Inputs and outputs	2
Inputs	17
Outputs	14

Parameterization

An S-mode DP must be configured in ETS and the Synco device to ensure that the S-mode DP transmits valid values. See Section 1.5 on workflows.

13.2 RDU341, S-mode data points

RDU341: Inputs and outputs

Name in ETS	DP visible in ETS	Flags					Data point type KNX				Value range	RDU receives, sends:
		C	R	W	T	U	ID	DPT_Name	Format	Unit		
Room operating mode: Preselection	①	1	0	1	1	1	20.102	_HVACMode	1 byte N ₈	Enum.	0 = Auto 1 = Comfort 2 = Precomfort, mapped in 1 or 3 3 = Economy 4 = Protection (BldgProtect) 5...255 Reserve	Receives event from KNX preselect operation (device/progr). Sends at local change (local operation).
Room temperature: Comfort setpoint	②	1	0	1	1	1	9.001	_Value_Temp	2 bytes F ₁₆	°C	-273.00...+670760.00 Floating point LCD display 5...40 °C	Receives event from KNX preselect operation (device/progr). Sends at local change (local operation).

① Preselection reception: Group object type = 1 byte (Enumeration)

② Room temperature: Comfort setpoint = Yes

RDU341: Inputs

Name in ETS	DP visible in ETS	Flags					Data point type KNX				Value range	RDU receives:
		C	R	W	T	U	ID	DPT_Name	Format	Unit		
System time	Always ⁵⁾	1	0	1	0	1	19.001	_DateTime	8 bytes struct.	YYYY MM DD d hh mm ss ---	1900...2155 = Year 1...12 = Month 1...31 = Day of month 1...7 = Monday - Sunday 0...23 = Hours 0...59 = Minutes 0...59 = Seconds Status bits ¹⁾	KNX system clock (for RDU weekday and time).
Time of day	Always	1	0	1	0	1	10.001	_TimeOfDay	3 bytes struct.	d hh mm ss	1...7 = Monday - Sunday 0...23 = Hours 0...59 = Minutes 0...59 = Seconds	KNX clock.
Fault transmission (enable/disable)	Always	1	0	1	0	1	1.003	_Enable	1 bit B ₁	---	0 = Disable 1 = Enable (default)	Event from KNX contact.
Room operating mode: Preselection Auto	①	1	0	1	0	0	1.001	_Switch	1 bit B ₁	---	0 = Not used 1 = Auto	Event from KNX preselect operation (device/progr). No reception timeout.
Room operating mode: Preselection Comfort		1	0	1	0	0	1.001	_Switch	1 bit B ₁	---	0 = Not used 1 = Comfort	
Room operating mode: Preselection Economy		1	0	1	0	0	1.001	_Switch	1 bit B ₁	---	0 = Not used 1 = Economy	
Room operating mode: Preselection Protection		1	0	1	0	0	1.001	_Switch	1 bit B ₁	---	0 = Not used 1 = Protection	

① Preselection reception: Group object type = 1 bit

¹⁾ See Section 1.4.3, page 13.

⁵⁾ See Section 1.5.1, page 16, Standard S-mode DP.

RDU341: Inputs (continued)

Name in ETS	DP visible in ETS	Flags					Data point type KNX				Value range	RDU receives:
		C	R	W	T	U	ID	DPT_Name	Format	Unit		
Room operating mode: Time switch	①	1	0	1	0	1	20.102	_HVACMode	1 byte N ₈	Enum.	1 = Comfort 2 = Precomfort, mapped in 1 or 3 3 = Economy 4 = Protection (BldgProtect) 5...255 Reserve	Event from KNX preselect operation (device/progr).
Room operating mode: Time switch Comfort	②	1	0	1	0	0	1.001	_Switch	1 bit B ₁	---	0 = Not used 1 = Comfort	Event from KNX preselect operation (device/progr).
Room operating mode: Time switch Economy		1	0	1	0	0	1.001	_Switch	1 bit B ₁	---	0 = Not used 1 = Economy	
Room operating mode: Time switch Protection		1	0	1	0	0	1.001	_Switch	1 bit B ₁	---	0 = Not used 1 = Protection	
Room operating mode: Window state	③	1	0	1	0	1	1.019	_Window_Door	1 bit B ₁	---	0 = Closed 1 = Open	Event from window contact (via KNX).
Room temperature: Comfort basic setpoint	④	1	0	1	0	1	9.001	_Value_Temp	2 bytes F ₁₆	°C	-273.00...+670760.00 Floating point LCD display 5...40 °C (default = 21 °C)	Event from KNX preselect operation (device/progr).
Enable electric heater	⑤	1	0	1	0	1	1.003	_Enable	1 bit B ₁	---	0 = Disable 1 = Enable (default)	Event from KNX preselect operation (device/progr).

① Time switch reception: Group object type = 1 byte (Enumeration)

② Time switch reception: Group object type = 1 bit

③ Window state input = Bus Note: The S-mode DP has no function if window contact is recorded locally via terminal input.

④ Room temperature: Comfort basic setpoint = Receive

⑤ Plant type = Single duct with electric heater Note: The S-mode DP has no function if the enable is recorded locally via the terminal input.

RDU341: Inputs (continued)

Name in ETS	DP visible in ETS	Flags					Data point type KNX				Value range	RDU receives:
		C	R	W	T	U	ID	DPT_Name	Format	Unit		
Supply air temperature	①	1	0	1	0	1	9.001	_Value_Temp	2 bytes F ₁₆	°C	-273.00...+670760.00 Floating point	COV from supply air sensor.
Application mode	②	1	0	1	0	1	20.105	_HVACContrMode	1 byte N ₈	Enum.	0 = Auto 1 = Heat 2 = Heat 3 = Cool 4 = Night purge 5 = Cool 6 = Off 7 = Auto 8 = Heat 9 = Fan only 10 = Cool 11...255 = Reserve	Event from KNX mode preselection (device/progr), especially from Synco living central apartment units.
Outside temperature	③	1	0	1	0	1	9.001	_Value_Temp	2 bytes F ₁₆	°C	-273.00...+670760.00 Floating point LCD display -99...655.3 °C	COV from outside air sensor.

① Plant type (all) → Supply air temperature = Receive

② Plant type (all) → Application mode input = Receive

③ Outside temperature = Receive

RDU341: Outputs

Name in ETS	DP visible in ETS	Flags					Data point type KNX				Value range	RDU sends:
		C	R	W	T	U	ID	DPT_Name	Format	Unit		
Fault information	Always	1	0	0	1	0	219.001	_AlarmInfo ²⁾	6 bytes strukt.	- - -	[0]...255 = Log no. [RDU = 0] [0...2]...255 = Alarm priority [0...11]...255 = Application area [0...4]...255 = Error class [0...15]...63 = Alarm attributes [0...7] = Fault state	Event, heart- beat 30 min.
Fault state (normal/faulty)	Always	1	0	0	1	0	1.005	_Alarm	1 bit B ₁	- - -	0 = No alarm (default) 1 = Alarm / faulty	Event, heart- beat 30 min.
Room operating mode: State	①	1	1	0	1	0	20.102	_HVACMode	1 byte N ₈	Enum.	0 = Auto (Not used) 1 = Comfort 2 = PreComfort (Not used) 3 = Economy 4 = Protection (BldgProtect) 5...255 Reserve	Event, heart- beat 15 min.
Room operating mode: State Comfort	②	1	0	0	1	0	1.001	_Switch	1 bit B ₁	- - -	0 = Not used 1 = Comfort	Event, last change of state applies. No heartbeat.
Room operating mode: State Economy		1	0	0	1	0	1.001	_Switch	1 bit B ₁	- - -	0 = Not used 1 = Economy	
Room operating mode: State Protection		1	0	0	1	0	1.001	_Switch	1 bit B ₁	- - -	0 = Not used 1 = Protection	
Room temperature	③	1	1	0	1	0	9.001	_Value_Temp	2 bytes F ₁₆	°C	-273.00...+670760.00 Floating point LCD display 0...49 °C	COV, heart- beat 15 min.
Room temperature: Current setpoint	④	1	1	0	1	0	9.001	_Value_Temp	2 bytes F ₁₆	°C	-273.00...+670760.00 Floating point LCD display 5...40 °C	Event, heart- beat 15 min.

① State transmission: Group object type = 1 byte (Enumeration)

② State transmission: Group object type = 1 bit

③ Room temperature = Transmit

④ Room temperature: Current setpoint = Transmit

²⁾ See Section 1.4.3, page 14.

RDU341: Outputs (continued)

Name in ETS	DP visible in ETS	Flags					Data point type KNX				Value range	RDU sends:
		C	R	W	T	U	ID	DPT_Name	Format	Unit		
Controller output VAV	① / ②	1	1	0	1	0	5.001	_Scaling	8 bit U ₈	%	[0...100] Resolution 0.4%	Event, heart-beat 15 min.
Heating output primary	②	1	1	0	1	0	5.001	_Scaling	8 bit U ₈	%	[0...100] Resolution 0.4%	Event, heart-beat 15 min.
X1: Temperature [°C]	③	1	1	0	1	0	9.001	_Value_Temp	2 bytes F ₁₆	°C	-273.00...+670760.00 Floating point LCD display 0...49 °C	COV, heart-beat 15 min.
X1: Digital [0/1]	④	1	1	0	1	0	1.001	_Switch	1 bit B ₁	- - -	0 = Off 1 = On	Event, heart-beat 15 min.
X2: Temperature [°C]	⑤	1	1	0	1	0	9.001	_Value_Temp	2 bytes F ₁₆	°C	-273.00...+670760.00 Floating point LCD display 0...49 °C	COV, heart-beat 15 min.
X2: Digital [0/1]	⑥	1	1	0	1	0	1.001	_Switch	1 bit B ₁	- - -	0 = Off 1 = On	Event, heart-beat 15 min.

- ① Plant type = Single duct
- ② Plant type = Single duct with electric heater
- ③ Universal input X1 = Temperature [°C]
- ④ Universal input X1 = Digital [0/1]
- ⑤ Universal input X2 = Temperature [°C]
- ⑥ Universal input X2 = Digital [0/1]

Blank page

14 RDG100KN, RDG160KN Room thermostats

14.1 Overview

Brief description

Room thermostats RDG100KN and RDG160KN are used for applications with fan coils and heating/cooling systems.

The room thermostats have an LCD to display (depending on the operating function) room temperature, room setpoint, outside air temperature, operating mode, fan speed, alarm state and time.

The operating elements allow for remote intervention in the control functions.



Documentation

Data sheet	Room thermostats RDG100KN / RDG160KN	N3191
Operating instructions	Room thermostats RDG100KN / RDG160KN	B3191
Basic documentation	Room thermostats RDG100KN / RDG160KN	P3191

Number of S-mode DPs

	RDG100KN RDG160KN
Inputs and outputs	2
Inputs	19
Outputs	22

Column "DP visible in ETS"

The data in column "DP visible in ETS" (see table below) refers to parameter settings where the S-mode DP is visible in the ETS.

Parameterization

An S-mode DP must be configured in ETS and the thermostat to ensure that the S-mode DP transmits valid values.

14.2 RDG100KN, RDG160KN, S-mode data points

RDG100KN / RDG160KN: Inputs and outputs

Name in ETS	DP visible in ETS	Flags					Data point type KNX				Value range	RDG receives, sends:
		C	R	W	T	U	ID	DPT_Name	Format	Unit		
Room operating mode: Preselection	①	1	0	1	1	1	20.102	_HVACMode	1 byte N ₈	Enum.	0 = Auto 1 = Comfort 2 = Precomfort, mapped in 1 or 3 3 = Economy 4 = Protection (BldgProtect) 5...255 Reserve	Receives event from KNX preselect operation (device/progr). Sends at local change (local operation).
Room temp: Comfort setpoint	②	1	0	1	1	1	9.001	_Value_Temp	2 bytes F ₁₆	°C	-273.00...+670760.00 Floating point LCD display 5...40 °C	Receives event from KNX preselect operation (device/progr). Sends at local change (local operation).

① Preselection reception: Group object type = 1 byte (Enumeration)

② Room temperature: Comfort setpoint = Yes

RDG100KN / RDG160KN: Inputs

Name in ETS	DP visible in ETS	Flags					Data point type KNX				Value range	RDG receives:
		C	R	W	T	U	ID	DPT_Name	Format	Unit		
System time	Always ⁵⁾	1	0	1	0	1	19.001	_DateTime	8 bytes struct.	YYYY MM DD d hh mm ss ---	1900...2155 = Year 1...12 = Month 1...31 = Day of month 1...7 = Monday - Sunday 0...23 = Hours 0...59 = Minutes 0...59 = Seconds Status bits ¹⁾	KNX system clock (for RDG weekday and time).
Time of day	Always	1	0	1	0	1	10.001	_TimeOfDay	3 bytes struct.	d hh mm ss	1...7 = Monday - Sunday 0...23 = Hours 0...59 = Minutes 0...59 = Seconds	KNX clock.
Fault transmission (enable/disable)	Always	1	0	1	0	1	1.003	_Enable	1 bit B ₁	---	0 = Disable 1 = Enable (default)	Event from KNX contact.
Room operating mode: Preselection Auto	①	1	0	1	0	0	1.001	_Switch	1 bit B ₁	---	0 = Not used 1 = Auto	Event from KNX preselect operation (device/progr). No reception timeout.
Room operating mode: Preselection Comfort		1	0	1	0	0	1.001	_Switch	1 bit B ₁	---	0 = Not used 1 = Comfort	
Room operating mode: Preselection Economy		1	0	1	0	0	1.001	_Switch	1 bit B ₁	---	0 = Not used 1 = Economy	
Room operating mode: Preselection Protection		1	0	1	0	0	1.001	_Switch	1 bit B ₁	---	0 = Not used 1 = Protection	

① Preselection reception: Group object type = 1 bit

¹⁾ See Section 1.4.3, page 13.

⁵⁾ See Section 1.5.1, page 16, Standard S-mode DP.

RDG100KN / RDG160KN: Inputs (continued)

Name in ETS	DP visible in ETS	Flags					Data point type KNX				Value range	RDG receives:
		C	R	W	T	U	ID	DPT_Name	Format	Unit		
Room operating mode: Time switch	①	1	0	1	0	1	20.102	_HVACMode	1 byte N ₈	Enum.	1 = Comfort 2 = Precomfort, mapped in 1 or 3 3 = Economy 4 = Protection (BldgProtect) 5...255 Reserve	Event from KNX preselect operation (device/progr).
Room operating mode: Time switch Comfort	②	1	0	1	0	0	1.001	_Switch	1 bit B ₁	---	0 = Not used 1 = Comfort	Event from KNX preselect operation (device/progr).
Room operating mode: Time switch Economy		1	0	1	0	0	1.001	_Switch	1 bit B ₁	---	0 = Not used 1 = Economy	
Room operating mode: Time switch Protection		1	0	1	0	0	1.001	_Switch	1 bit B ₁	---	0 = Not used 1 = Protection	
Room operating mode: Window state	③	1	0	1	0	1	1.019	_Window_Door	1 bit B ₁	---	0 = Closed 1 = Open	Event from window contact (via KNX).
Room temp: Comfort basic setpoint	④	1	0	1	0	1	9.001	_Value_Temp	2 bytes F ₁₆	°C	-273.00...+670760.00 Floating point LCD display 5...40 °C (default = 21 °C)	Event from KNX preselect operation (device/progr).
Enable electric heater	⑤	1	0	1	0	1	1.003	_Enable	1 bit B ₁	---	0 = Disable 1 = Enable (default)	Event from KNX preselect operation (device/progr).
Heating/cooling changeover	⑥	1	0	1	0	1	1.100	_Heat/Cool	1 bit B ₁	---	0 = Cooling 1 = Heating (default)	Event from KNX preselect operation (device/progr).

① Time switch reception: Group object type = 1 byte (Enumeration)

② Time switch reception: Group object type = 1 bit

③ Window state input = Bus Note: The S-mode DP has no function if window contact is recorded locally via terminal input.

④ Room temperature: Comfort basic setpoint = Receive

⑤ Plant type = 2-pipe with electric heater Note: The S-mode DP has no function if the enable is recorded locally via the terminal input.

⑥ Plant type (all) → Control sequence = H/C changeover auto

RDG100KN / RDG160KN: Inputs (continued)

Name in ETS	DP visible in ETS	Flags					Data point type KNX				Value range	RDG receives:
		C	R	W	T	U	ID	DPT_Name	Format	Unit		
Application mode	①	1	0	1	0	1	20.105	_HVACContrMode	1 byte N ₈	Enum.	0 = Auto 1 = Heat 2 = Heat 3 = Cool 4 = Auto 5 = Cool 6 = Off 7 = Auto 8 = Heat 9 = Fan only 10 = Cool 11...255 = Reserve	Event from KNX mode preselection (device/progr), especially from Synco living central apartment units.
Enable fan command value	②	1	0	1	0	1	1.003	_Enable	1 bit B ₁	- - -	0 = Disable 1 = Enable (default)	Event from KNX preselect operation (device/progr).
Fan command value	③	1	0	1	0	1	5.001	_Scaling	8 bit U ₈	%	[0...100] Resolution 0.4%	Event from KNX preselect operation (device/progr).
Outside temperature	④	1	0	1	0	1	9.001	_Value_Temp	2 bytes F ₁₆	°C	-273.00...+670760.00 Floating point LCD display -99....655.3 °C	COV from outside air sensor.

- ① Plant type (all) → Application mode input = Receive
- ② Fan operation = Yes → Enable/disable command value = Receive
- ③ Fan operation = Yes → Fan speed: Command value and output [%] = Yes
- ④ Outside temperature = Receive

RDG100KN / RDG160KN: Outputs

Name in ETS	DP visible in ETS	Flags					Data point type KNX				Value range	RDG sends:
		C	R	W	T	U	ID	DPT_Name	Format	Unit		
Fault information	Always	1	0	0	1	0	219.001	_AlarmInfo ²⁾	6 bytes strukt.	- - -	[0]...255 = Log no. [RDG = 0] [0...2]...255 = Alarm priority [0...11]...255 = Application area [0...4]...255 = Error class [0...15]...63 = Alarm attributes [0...7] = Fault state	Event, heart- beat 30 min.
Fault state (normal/faulty)	Always	1	0	0	1	0	1.005	_Alarm	1 bit B ₁	- - -	0 = No alarm (default) 1 = Alarm / faulty	Event, heart- beat 30 min.
Room operating mode: State	①	1	1	0	1	0	20.102	_HVACMode	1 byte N ₈	Enum.	0 = Auto (Not used) 1 = Comfort 2 = PreComfort (Not used) 3 = Economy 4 = Protection (BldgProtect) 5...255 Reserve	Event, heart- beat 15 min.
Room operating mode: State Comfort	②	1	0	0	1	0	1.001	_Switch	1 bit B ₁	- - -	0 = Not used 1 = Comfort	Event, last change of state applies. No heartbeat.
Room operating mode: State Economy		1	0	0	1	0	1.001	_Switch	1 bit B ₁	- - -	0 = Not used 1 = Economy	
Room operating mode: State Protection		1	0	0	1	0	1.001	_Switch	1 bit B ₁	- - -	0 = Not used 1 = Protection	
Room temperature	③	1	1	0	1	0	9.001	_Value_Temp	2 bytes F ₁₆	°C	-273.00...+670760.00 Floating point LCD display 0...49 °C	COV, heart- beat 15 min.
Room temp: Current setpoint	④	1	1	0	1	0	9.001	_Value_Temp	2 bytes F ₁₆	°C	-273.00...+670760.00 Floating point LCD display 5...40 °C	Event, heart- beat 15 min.
Heating output primary	⑤	1	1	0	1	0	5.001	_Scaling	8 bit U ₈	%	[0...100] Resolution 0.4%	Event, heart- beat 15 min.
Heating output secondary	⑥	1	1	0	1	0	5.001	_Scaling	8 bit U ₈	%	[0...100] Resolution 0.4%	Event, heart- beat 15 min.

① State transmission: Group object type = 1 byte (Enumeration)

② State transmission: Group object type = 1 bit

③ Room temperature = Transmit

④ Room temperature: Current setpoint = Transmit

⑤ Plant type (all) → Control sequence = Heating only or H/C changeover manual or H/K changeover auto

⑥ Plant type = 2-pipe with electric heater or 2-pipe with radiator or 2-stage heating or cooling → Control sequence: Heating only or H/C changeover manual / auto

²⁾ See Section 1.4.3, page 14.

RDG100KN / RDG160KN: Outputs (continued)

Name in ETS	DP visible in ETS	Flags					Data point type KNX				Value range	RDG sends:
		C	R	W	T	U	ID	DPT_Name	Format	Unit		
Cooling output primary	①	1	1	0	1	0	5.001	_Scaling	8 bit U ₈	%	[0...100] Resolution 0.4%	Event, heart-beat 15 min.
Cooling output secondary	②	1	1	0	1	0	5.001	_Scaling	8 bit U ₈	%	[0...100] Resolution 0.4%	Event, heart-beat 15 min.
Fan operation (0=Auto/1=Manual)	③	1	1	0	1	0	1.001	_Switch	1 bit B ₁	---	0 = Auto 1 = Manual	Event, heart-beat 15 min.
Fan output	④	1	1	0	1	0	5.001	_Scaling	8 bit U ₈	%	[0...100] Resolution 0.4%	Event, heart-beat 15 min.
Fan speed 1	⑤	1	1	0	1	0	1.001	_Switch	1 bit B ₁	---	0 = Off 1 = On	Event, heart-beat 15 min.
Fan speed 2		1	1	0	1	0	1.001	_Switch	1 bit B ₁	---	0 = Off 1 = On	
Fan speed 3		1	1	0	1	0	1.001	_Switch	1 bit B ₁	---	0 = Off 1 = On	
X1: Temperature [°C]	⑥	1	1	0	1	0	9.001	_Value_Temp	2 bytes F ₁₆	°C	-273.00...+670760.00 Floating point LCD display 0...49 °C	COV, heart-beat 15 min.
X1: Digital [0/1]	⑦	1	1	0	1	0	1.001	_Switch	1 bit B ₁	---	0 = Off 1 = On	Event, heart-beat 15 min.
X2: Temperature [°C]	⑥	1	1	0	1	0	9.001	_Value_Temp	2 bytes F ₁₆	°C	-273.00...+670760.00 Floating point LCD display 0...49 °C	COV, heart-beat 15 min.
X2: Digital [0/1]	⑦	1	1	0	1	0	1.001	_Switch	1 bit B ₁	---	0 = Off 1 = On	Event, heart-beat 15 min.
D1: Digital [0/1]	⑧	1	1	0	1	0	1.001	_Switch	1 bit B ₁	---	0 = Off 1 = On	Event, heart-beat 15 min.

- ① Plant type (all) → Control sequence = Cooling only or H/C changeover manual or H/C changeover auto
 ② Plant type = 2-stage heating or cooling → Control sequence: Cooling only or H/C changeover manual or H/C changeover auto
 ③ Fan operation = Yes → Current operating mode = Transmit
 ④ Fan operation = Yes → Fan speed: Command value and output [%] = Yes
 ⑤ Fan operation = Yes → Fan speed: Speed 1...3 = Yes
 ⑥ Universal input X1 = Temperature [°C], Universal input X2 = Temperature [°C]
 ⑦ Universal input X1 = Digital [0/1], Universal input X2 = Digital [0/1]
 ⑧ Digital input D1 = Yes

Blank page

15 RDG400KN Room thermostat

15.1 Overview

Brief description

Room thermostat RDG400KN is used for VAV applications. It has an LCD to display (depending on operating function) room temperature, room setpoint, outside air temperature, operating mode and alarm state.

The operating elements on the room unit allow for remote intervention in the control functions.



Documentation

Data sheet	Room thermostat RDG400KN	N3192
Operating instructions	Room thermostat RDG400KN	B3192
Basic documentation	Room thermostat RDG400KN	P3192

Number of S-mode DPs

	RDG400KN
Inputs and outputs	2
Inputs	18
Outputs	15

Column "DP visible in ETS"

The data in column "DP visible in ETS" (see table below) refers to parameter settings where the S-mode DP is visible in the ETS.

Parameterization

An S-mode DP must be configured in ETS and the thermostat to ensure that the S-mode DP transmits valid values.

15.2 RDG400KN, S-mode data points

RDG400KN: Inputs and outputs

Name in ETS	DP visible in ETS	Flags					Data point type KNX				Value range	RDG receives, sends:
		C	R	W	T	U	ID	DPT_Name	Format	Unit		
Room operating mode: Preselection	①	1	0	1	1	1	20.102	_HVACMode	1 byte N ₈	Enum.	0 = Auto 1 = Comfort 2 = Precomfort, mapped in 1 or 3 3 = Economy 4 = Protection (BldgProtect) 5...255 Reserve	Receives event from KNX preselect operation (device/progr). Sends at local change (local operation).
Room temp: Comfort setpoint	②	1	0	1	1	1	9.001	_Value_Temp	2 bytes F ₁₆	°C	-273.00...+670760.00 Floating point LCD display 5...40 °C	Receives event from KNX preselect operation (device/progr). Sends at local change (local operation).

① Preselection reception: Group object type = 1 byte (Enumeration)

② Room temperature: Comfort setpoint = Yes

RDG400KN: Inputs

Name in ETS	DP visible in ETS	Flags					Data point type KNX				Value range	RDG400KN receives:
		C	R	W	T	U	ID	DPT_Name	Format	Unit		
System time	Always ⁵⁾	1	0	1	0	1	19.001	_DateTime	8 bytes struct.	YYYY MM DD d hh mm ss ---	1900...2155 = Year 1...12 = Month 1...31 = Day of month 1...7 = Monday - Sunday 0...23 = Hours 0...59 = Minutes 0...59 = Seconds Status bits ¹⁾	KNX system clock (for RDU weekday and time).
Time of day	Always	1	0	1	0	1	10.001	_TimeOfDay	3 bytes struct.	d hh mm ss	1...7 = Monday - Sunday 0...23 = Hours 0...59 = Minutes 0...59 = Seconds	KNX clock.
Fault transmission (enable/disable)	Always	1	0	1	0	1	1.003	_Enable	1 bit B ₁	---	0 = Disable 1 = Enable (default)	Event from KNX contact.
Room operating mode: Preselection Auto	①	1	0	1	0	0	1.001	_Switch	1 bit B ₁	---	0 = Not used 1 = Auto	Event from KNX preselect operation (device/progr). No reception timeout.
Room operating mode: Preselection Comfort		1	0	1	0	0	1.001	_Switch	1 bit B ₁	---	0 = Not used 1 = Comfort	
Room operating mode: Preselection Economy		1	0	1	0	0	1.001	_Switch	1 bit B ₁	---	0 = Not used 1 = Economy	
Room operating mode: Preselection Protection		1	0	1	0	0	1.001	_Switch	1 bit B ₁	---	0 = Not used 1 = Protection	

① Preselection reception: Group object type = 1 bit

¹⁾ See Section 1.4.3, page 13.

⁵⁾ See Section 1.5.1, page 16, Standard S-mode DP.

RDG400KN: Inputs (continued)

Name in ETS	DP visible in ETS	Flags					Data point type KNX				Value range	RDG400KN receives:
		C	R	W	T	U	ID	DPT_Name	Format	Unit		
Room operating mode: Time switch	①	1	0	1	0	1	20.102	_HVACMode	1 byte N ₈	Enum.	1 = Comfort 2 = Precomfort, mapped in 1 or 3 3 = Economy 4 = Protection (BldgProtect) 5...255 Reserve	Event from KNX preselect operation (device/progr).
Room operating mode: Time switch Comfort	②	1	0	1	0	0	1.001	_Switch	1 bit B ₁	---	0 = Not used 1 = Comfort	Event from KNX preselect operation (device/progr).
Room operating mode: Time switch Economy		1	0	1	0	0	1.001	_Switch	1 bit B ₁	---	0 = Not used 1 = Economy	
Room operating mode: Time switch Protection		1	0	1	0	0	1.001	_Switch	1 bit B ₁	---	0 = Not used 1 = Protection	
Room operating mode: Window state	③	1	0	1	0	1	1.019	_Window_Door	1 bit B ₁	---	0 = Closed 1 = Open	Event from window contact (via KNX).
Room temp: Comfort basic setpoint	④	1	0	1	0	1	9.001	_Value_Temp	2 bytes F ₁₆	°C	-273.00...+670760.00 Floating point LCD display 5...40 °C (default = 21 °C)	Event from KNX preselect operation (device/progr).
Enable electric heater	⑤	1	0	1	0	1	1.003	_Enable	1 bit B ₁	---	0 = Disable 1 = Enable (default)	Event from KNX preselect operation (device/progr).
Heating/cooling changeover	⑥	1	0	1	0	1	1.100	_Heat/Cool	1 bit B ₁	---	0 = Cooling 1 = Heating (default)	Event from KNX preselect operation (device/progr).

① Time switch reception: Group object type = 1 byte (Enumeration)

② Time switch reception: Group object type = 1 bit

③ Window state input = Bus Note: The S-mode DP has no function if window contact is recorded locally via terminal input.

④ Room temperature: Comfort basic setpoint = Receive

⑤ Plant type = Single duct with electric heater Note: The S-mode DP has no function if the enable is recorded locally via the terminal input.

⑥ Plant type (all) → Control sequence = H/C changeover auto

RDG400KN: Inputs (continued)

Name in ETS	DP visible in ETS	Flags					Data point type KNX				Value range	RDG400KN receives:
		C	R	W	T	U	ID	DPT_Name	Format	Unit		
Supply air temperature	①	1	0	1	0	1	9.001	_Value_Temp	2 bytes F ₁₆	°C	-273.00...+670760.00 Floating point	COV from supply air sensor.
Application mode	②	1	0	1	0	1	20.105	_HVACContrMode	1 byte N ₈	Enum.	0 = Auto 1 = Heat 2 = Heat 3 = Cool 4 = Night purge 5 = Cool 6 = Off 7 = Auto 8 = Heat 9 = Fan only 10 = Cool 11...255 = Reserve	Event from KNX mode preselection (device/progr), especially from Synco living central apartment units.
Outside temperature	③	1	0	1	0	1	9.001	_Value_Temp	2 bytes F ₁₆	°C	-273.00...+670760.00 Floating point LCD display -99...655.3 °C	COV from outside air sensor.

- ① Plant type (all) → Supply air temperature = Receive
- ② Plant type (all) → Application mode input = Receive
- ③ Outside temperature = Receive

RDG400KN: Outputs

Name in ETS	DP visible in ETS	Flags					Data point type KNX				Value range	RDG400KN sends:
		C	R	W	T	U	ID	DPT_Name	Format	Unit		
Fault information	Always	1	0	0	1	0	219.001	_AlarmInfo ²⁾	6 bytes strukt.	- - -	[0]...255 = Log no. [RDG = 0] [0...2]...255 = Alarm priority [0...11]...255 = Application area [0...4]...255 = Error class [0...15]...63 = Alarm attributes [0...7] = Fault state	Event, heart- beat 30 min.
Fault state (normal/faulty)	Always	1	0	0	1	0	1.005	_Alarm	1 bit B ₁	- - -	0 = No alarm (default) 1 = Alarm / faulty	Event, heart- beat 30 min.
Room operating mode: State	①	1	1	0	1	0	20.102	_HVACMode	1 byte N ₈	Enum.	0 = Auto (Not used) 1 = Comfort 2 = PreComfort (Not used) 3 = Economy 4 = Protection (BldgProtect) 5...255 Reserve	Event, heart- beat 15 min.
Room operating mode: State Comfort	②	1	0	0	1	0	1.001	_Switch	1 bit B ₁	- - -	0 = Not used 1 = Comfort	Event, last change of state applies. No heartbeat.
Room operating mode: State Economy		1	0	0	1	0	1.001	_Switch	1 bit B ₁	- - -	0 = Not used 1 = Economy	
Room operating mode: State Protection		1	0	0	1	0	1.001	_Switch	1 bit B ₁	- - -	0 = Not used 1 = Protection	
Room temperature	③	1	1	0	1	0	9.001	_Value_Temp	2 bytes F ₁₆	°C	-273.00...+670760.00 Floating point LCD display 0...49 °C	COV, heart- beat 15 min.
Room temp: Current setpoint	④	1	1	0	1	0	9.001	_Value_Temp	2 bytes F ₁₆	°C	-273.00...+670760.00 Floating point LCD display 5...40 °C	Event, heart- beat 15 min.

① State transmission: Group object type = 1 byte (Enumeration)

② State transmission: Group object type = 1 bit

③ Room temperature = Transmit

④ Room temperature: Current setpoint = Transmit

²⁾ See Section 1.4.3, page 14.

RDG400KN: Outputs (continued)

Name in ETS	DP visible in ETS	Flags					Data point type KNX				Value range	RDG400KN sends:
		C	R	W	T	U	ID	DPT_Name	Format	Unit		
Controller output VAV	①	1	1	0	1	0	5.001	_Scaling	8 bit U ₈	%	[0...100] Resolution 0.4%	Event, heart-beat 15 min.
Heating output primary	②	1	1	0	1	0	5.001	_Scaling	8 bit U ₈	%	[0...100] Resolution 0.4%	Event, heart-beat 15 min.
Cooling output primary	③	1	1	0	1	0	5.001	_Scaling	8 bit U ₈	%	[0...100] Resolution 0.4%	Event, heart-beat 15 min.
X1: Temperature [°C]	④	1	1	0	1	0	9.001	_Value_Temp	2 bytes F ₁₆	°C	-273.00...+670760.00 Floating point LCD display 0...49 °C	COV, heart-beat 15 min.
X1: Digital [0/1]	⑤	1	1	0	1	0	1.001	_Switch	1 bit B ₁	- - -	0 = Off 1 = On	Event, heart-beat 15 min.
U1: 0-10V [%]	⑥	1	1	0	1	0	5.001	_Scaling	8 bit U ₈	%	[0...100] Resolution 0.4%	Event, heart-beat 15 min.
D1: Digital [0/1]	⑦	1	1	0	1	0	1.001	_Switch	1 bit B ₁	- - -	0 = Off 1 = On	Event, heart-beat 15 min.

① Plant type = Single duct *or* Single duct with electric heater *or* Single duct with radiator *or* Single duct with h/c coil

② Plant type = Single duct with electric heater *or* Single duct with radiator *or* Single duct with h/c coil → Control sequence: Heating only *or* H/C changeover manual / auto

③ Plant type = Single duct with h/c coil → Control sequence: Cooling only *or* H/C changeover manual *or* H/C changeover auto

④ Universal input X1 = Temperature [°C]

⑤ Universal input X1 = Digital [0/1]

⑥ Voltage input U1 = Yes

⑦ Digital input D1 = Yes

Blank page

16 QAX910 Central apartment unit

16.1 Overview

Brief description

The QAX910 Central apartment unit (Synco living) controls heating, cooling, ventilation and DHW in an apartment with max.12 rooms. The function for absence is used to implement heat and security-related functionality such as reduced heat generation (heating, DHW), lighting control, door and window contact monitoring and smoke detection.



Documentation

Data sheet	Central apartment unit QAX910	N2707
Instructions	Mounting and commissioning	C2707
Operating instructions		B2707

Overview of series for versions

	Software version QAX910 Central apartment unit	Product data import file *.vd3 / *.vd5 ETS Program version
Series A	V1.00 and V1.01	1.0
Series B	V2.00	1.1
Series C	V3.00 and V3.01	3.0
Series C	V3.02	3.1

Note

Note the interdependence of software and program version listed in the above table if you want to add new devices to a line or area in ETS via **Add Devices**.

Number of S-mode DPs

Number of S-mode DPs	Series A, V1.xx	Series B, V2.00	Series C, V3.xx
Visible in ETS	182	195	252
In group address table	50	250	250
In association table	50	250	250

Parameterization

See Section 16.1.1 to parameterize the central apartment unit QAX910. See also Section 1.5 for a principal workflow.

The central apartment unit QAX910 series A allows you to connect max. 50 S-mode DPs via group addresses; QAX910 series B and C allows for max. 250.

An S-mode DP must be configured in ETS and the Synco device to ensure that the S-mode DP transmits valid values.

16.1.1 Parameterizing QAX910 series A, B and C

Start parameterization

Start parameterization via view "All Devices" in ETS (screenshots ETS3).

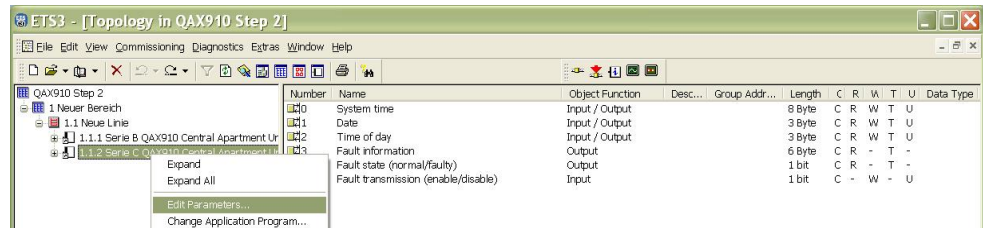

Select the QAX910 central apartment unit and right-click to open the context menu. Select **Edit Parameters...** to open the following dialog box.

Dialog box (series C)



Select a parameter group in the dialog box to start parameterization. This configures or makes visible the corresponding parameters, allowing you to set the parameter values.

Parameter group	Fault inputs
Parameter	Fault input 1: State
	...
	Fault input 8: State
Parameter value	No (default)
	Receive

Differences between series A, B, and C

1. Some values of parameters with identical names in series A, B, and C differ. See below: 1. Parameter values.
2. The **contents** of the dialog boxes differ depending on the parameter group.
3. **Number and order** of S-mode DPs or DP numbers differ depending on the parameter group.
4. **Configuration** of the S-mode DPs depends on the set parameter values. See below: 4. Configuration.

1. Parameter values

Series A

Fault inputs → Fault input 1: State → No communication / Receive



No communication
→ Receive

When you set parameter value No communication (default) to Receive and click [OK], ETS configures the S-mode DP Fault input 1: State.

Series B and C

Fault inputs → Fault input 1: State → No / Receive



No → Receive

When you set parameter value No (default) to Receive and click [OK], ETS also configures the S-mode DP Fault input 1: State.

Number, Object Function
columns

From an QAX910 viewpoint, parameter value Receive configures S-mode DP 8 (see Number column) with Object Function = Input (see Object Function column).

Number	Name	Object Function	Desc...	Group Addr...	Length	C	R	W	T	U	Data Type
0	System time	Input / Output			8 Byte	C	R	W	T	U	
1	Date	Input / Output			3 Byte	C	R	W	T	U	
2	Time of day	Input / Output			3 Byte	C	R	W	T	U	
3	Fault information	Output			6 Byte	C	R	-	T	-	
6	Fault state (normal/faulty)	Output			1 bit	C	R	-	T	-	
7	Fault transmission (enable/disable)	Input			1 bit	C	-	W	-	U	
8	Fault input 1: State	Input			1 bit	C	-	W	-	U	

Fault inputs 1...4

You can parameterize Fault input 1...4 as needed by changing the parameter value No communication (series A) or No (series B and C) to Receive. In this case, the S-mode DPs 8...11 are configured.

Series C
Fault inputs 5...8

In the QAX910 series C, Fault inputs 5...8 additionally can be configured with S-mode DPs 12...15.

2. Contents

Series A

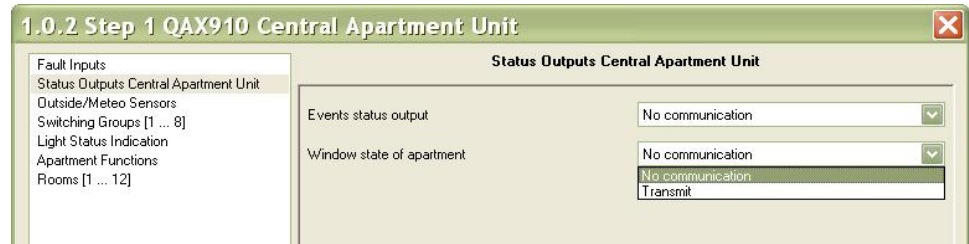

Parameter group	Status Outputs Central Apartment Unit
Parameter	Events status output
	Window state of apartment
Parameter value	No communication
	Transmit

Events status output	No communication	→ Event status output not used (default)
	Transmit	→ DP 16, output
Window state of apartment	No communication	→ Window state for apartment not used (default)
	Transmit	→ DP 17, output

Series B and C



Parameter group Supervision (series A Status Outputs Central Apartment Unit)

Events status output	No	→ Events status output not used (default)
	Send	→ DP 12 (series B), DP 16 (series C), output
Window/door state of apartment	No	→ Window/door state of apartment not used (default)
	Send	→ DP 13 (B), DP 17 (C), output
[Door 1] Door state	No	→ [Door 1] Door state not used (default)
	Send	→ DP 14 (B), DP 18 (C), output
	Receive	→ DP 14 (B), DP 18 (C), input
[Door 2] Door state	No	→ [Door 2] Door state not used (default)
	Send	→ DP 15 (B), DP 19 (C), output
	Receive	→ DP 15 (B), DP 19 (C), input
Supervision	No	→ Supervision not used (default)
	Yes	→ DP 16 (B), 20 (C), output and input ¹⁾

¹⁾ S-mode DP number 16 (B) and 20 (C) and other S-mode DP are configured as input and output; see screenshot "S-mode DP in ETS" on the following page.

Parameter values Transmit / Send (series A / B+C), Receive and Yes configure the S-mode DPs in ETS.

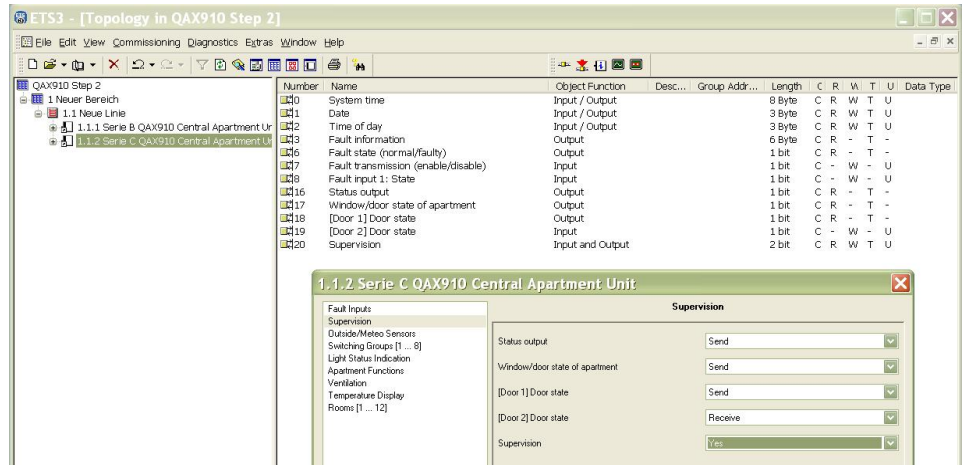

3. Number and order

Series A

Parameter group Outside/Meteo sensors with three parameters.

Outside temperature No communication → Outside temperature not used (default)
 Transmit → DP 18, Outside temperature, Output
 Receive → DP 19, Outside temperature, Input

Atmospheric pressure No communication → Atmospheric pressure (measurement) not used (default)
 Transmit → DP 20, Atmospheric pressure, Output

Twilight switch No communication → Twilight switch not used (default)
 Receive → DP 21, Twilight switch, Input

Series B and C

Parameter group Outside/Meteo sensors with three parameters (same as series A). Number and order of the configurable S-mode DPs differ between series A (see above) and series B and C (see below).

Outside temperature No → Outside temperature not used (default)
 Send → DP 17 (B), 21 (C), Meteo sensor: Outside temperature, Output
 Receive → DP 18 (B), 22 (C), Outside temperature, Input

Atmospheric pressure No → Atmospheric pressure not used (default)
 Send → DP 19 (B), 23 (C),
 Meteo sensor: Atmospheric pressure measured value, Output
 → DP 20 (B), 24 (C),
 Meteo sensor: Atmospheric pressure on sea level, Output

Twilight switch No → Twilight switch not used (default)
 Receive → DP 21 (B), 25 (C), Twilight switch, Input

4. Configuration

Series B and C

Name	Object Function	Desc...	Group Addr...	Length	C	R	W	T	U
System time	Input / Output			8 Byte	C	R	W	T	U
Date	Input / Output			3 Byte	C	R	W	T	U
Time of day	Input / Output			3 Byte	C	R	W	T	U
Fault information	Output			6 Byte	C	R	-	T	-
Fault state (normal/faulty)	Output			1 bit	C	R	-	T	-
Fault transmission (enable/disable)	Input			1 bit	C	-	W	-	U
Fault input 1: State	Input			1 bit	C	-	W	-	U
Status output	Output			1 bit	C	R	-	T	-
Window/door state of apartment	Output			1 bit	C	R	-	T	-
[Door 1] Door state	Output			1 bit	C	R	-	T	-
[Door 2] Door state	Input			1 bit	C	-	W	-	U
Supervision	Input and Output			2 bit	C	R	W	T	U

The following configuration information pertain to S-mode DPs of QAX910 series B and C. The following applies:

Parameter group and Parameter	See information in margin.
Parameter value	Receive, Send, Yes, ...
Name	See column Name in ETS.
Object Function	See column Object function in ETS.

Parameter value	Name	Object Function
-----------------	------	-----------------

Fault inputs

Fault input 1...4 (B)	Receive	Fault input X: State	Input
Fault input 1...8 (C)			
Supervision			
Status output	Send	Status output	Output
Window/door state of apartment	Send	Window/door state of apartment	Output
[Door 1...2] Door state	Send	[Door X] Door state	Output
	Receive	[Door X] Door state	Input
Supervision	Superv. = Yes	Supervision	Input and Output

Outside/Meteo sensors

Outside temperature	Send	Meteo sensor: Outside temperature	Output
	Receive	Outside temperature	Input
Atmospheric pressure	Send	Meteo sensor: Atmospheric pressure measured value	Output
		Meteo sensor: Atmospheric pressure on sea level	Output
Twilight switch	Receive	Twilight switch	Input

	Parameter value	Name	Object Function
Switching groups [1...8]			
[Switching group 1...4]	[Swi grp. X] = Yes	configures:	
	Switch	[Switching group X] Switch	Output
		[Switching group X] Trigger On/Off	Input
	Dim	[Switching group X] Switch	Output
		[Switching group X] Dim	Output
		[Switching group X] Trigger On/Off	Input
	Blind	[Switching group X] Blind Step/Stop	Output
		[Switching group X] Blind Up/Down	Output
		[Switching group X] Trigger Up/Down	Input
	Scene	[Switching group X] Scene	Output
		[Switching group X] Trigger (0= Scene A, 1=Scene B)	Input
[Switching group 5...8]	[Swi grp. X] = Yes	configures:	
	Switch	[Switching group X] Switch	Output
		[Switching group X] Trigger On/Off	Input
	Blind	[Switching group X] Blind Up/Down	Output
		[Switching group X] Trigger Up/Down	Input
	Scene	[Switching group X] Scene	Output
		[Switching group X] Trigger (0= Scene A, 1=Scene B)	Input
Light status indication			
Lamp 1...4	Lamp X = Yes	Light status indication Lamp X	Input
Apartment functions			
Domestic hot water	DHW = Yes	Domestic hot water: Forced charging	Input (Trigger)
		Domestic hot water operating mode: Preselection	Input and Output
		Domestic hot water operating mode: State	Output
		Domestic hot water storage tank temp: Setpoint	Input and Output
		Domestic hot water storage tank temp: Actual value	Output
Absence	Absence = Yes	Absence: Contact	Input
		Absence: State	Output
Apartment operating mode	Ap op mode = Yes	Apartment operating mode: Preselection	Input and Output
		Apartment operating mode: Comfort release	Output
Heating summer operation	Send	Heating summer operation: State	Output
	Receive	Heating summer operation: Preselection	Input
2-pipe H/C system	2-pipe = Yes	Heating/Cooling changeover	Input
Heat demand	Heat dem = Yes	Heat demand absolute [°C]	Output
From series C			
Exhaust hood	Exh hood = Yes	Exhaust hood: Release	Output

From series C

Parameter group **Ventilation**

Ventilation

Vent. = Yes	configures S-mode DPs: [Ventilation] Stage selection [Ventilation] Ventilation stage and parameters: [Ventilation] Contact 1 [Ventilation] Contact 2 Air quality Air humidity Fireplace mode	Input and Output Output
-------------	--	----------------------------

[Ventilation] Contact 1...2

Contact X = Yes	[Ventilation] Contact X	Input
------------------------	-------------------------	-------

Air quality

Send	Air quality	Output
Receive	Air quality	Input

Air humidity

Send	Air humidity	Output
Receive	Air humidity	Input

Fireplace mode

Send	Fireplace mode	Output
Receive	Fireplace mode	Input

From series C

Parameter group **Temperature display**

Temperature display

Sensor 1...3

Send	[Temperature display] Sensor X	Output
Receive	[Temperature display] Sensor X	Input

Series B

Parameter group **Rooms [1...12]**

[Rm X] = Yes	configures parameters: Room heating = Yes Window state = Send Smoke indication = Send
--------------	--

Room heating

Rm heat. = Yes	configures S-mode DPs: [Room X] Room temperature [Room X] Operating mode: Preselection [Room X] Operating mode: State [Room X] Room temp: Economy heating setpoint [Room X] Room temp: Precomfort heating setpoint [Room X] Room temp: Comfort heating setpoint [Room X] Valve position	Output Input and Output Output Input and Output Input and Output Input and Output Output
----------------	--	--

Window state

Send	[Room X] Window	Output
Receive	[Room X] Window	Input

Smoke indication

Send	[Room X] Smoke	Output
Receive	[Room X] Smoke	Input

	Parameter value	Name	Object Function
Series C V3.01			
		Parameter group Rooms [1...12]	
	[Rm X] = Yes	configures S-mode DPs:	
		[Room X] Room temperature	Output
		[Room X] Operating mode: Preselection	Input and Output
		[Room X] Operating mode: State	Output
		[Room X] Room temp: Economy heating setpoint	Input and Output
		[Room X] Room temp: Precomfort heating setpoint	Input and Output
		[Room X] Room temp: Comfort heating setpoint	Input and Output
		[Room X] Valve position	Output
		[Room X] Window	Output
		[Room X] Smoke	Output
		configures parameters:	
		Room control = Yes	
		Cooling = No	
		Window state = Send	
		Smoke indication = Send	
Room control	Rm ctrl. = Yes	configures the same S-mode DPs as [Rm X] = Yes	
Cooling	With cooling release	configures S-mode DP:	
		[Room X] Cooling: Release	Output
	With air conditioner	configures S-mode DPs:	
		[Room X] Air conditioner: On/Off	Output
		[Room X] Air conditioner: Operating mode	Output
		[Room X] Air conditioner: Room temp. setpoint act.	Output
		[Room X] Room temp: Economy cooling setpoint	Input and Output
		[Room X] Room temp: Precomfort cooling setpoint	Input and Output
		[Room X] Room temp: Comfort cooling setpoint	Input and Output
Window state	Send	[Room X] Window	Output
	Receive	[Room X] Window	Input
Smoke indication	Send	[Room X] Smoke	Output
	Receive	[Room X] Smoke	Input
<hr/>			
From series C V3.02			
		Parameter group Räume [1...12]	
	[Rm X] = Yes	configures S-mode DPs:	
		[Room X] Room temperature	Output
		[Room X] Operating mode: Preselection	Input and Output
		[Room X] Operating mode: State	Output
		[Room X] Room temp: Economy heating setpoint	Input and Output
		[Room X] Room temp: Precomfort heating setpoint	Input and Output
		[Room X] Room temp: Comfort heating setpoint	Input and Output
		[Room X] Valve position	Output
		[Room X] Window	Output
		[Room X] Smoke	Output
		configures parameters:	
		Room control = Yes	
		Room temperature = Send	
		Cooling / Room controller = No	
		Window state = Send	
		Smoke indication = Send	

From series C V3.02

Parameter group **Räume [1...12]** (continued)

Room control	Rm ctr = Yes	configures the same S-mode DPs as [Rm X] = Yes		
Room temperature	Send	[Room X] Room temperature	Output	
	Receive	[Room X] Room temperature	Input	
Cooling / Room controller	With cooling release	configures S-mode DP:		
		[Room X] Cooling: Release	Output	
	With air conditioner (Zennio)	configures S-mode DPs:		
		[Room X] Air conditioner: On/Off	Output	
		[Room X] Air conditioner: Operating mode	Output	
		[Room X] Air conditioner: Room temp. setpoint act.	Output	
		[Room X] Room temp: Economy cooling setpoint	Input and Output	
		[Room X] Room temp: Precomfort cooling setpoint	Input and Output	
	[Room X] Room temp: Comfort cooling setpoint	Input and Output		
	With room controller Siemens	configures S-mode DPs:		
[Room X] Room controller: Application mode		Output		
[Room X] Room temp: Economy cooling setpoint		Input and Output		
[Room X] Room temp: Precomfort cooling setpoint		Input and Output		
[Room X] Room temp: Comfort cooling setpoint	Input and Output			
Window state	Send	[Room X] Window	Output	
	Receive	[Room X] Window	Input	
Smoke indication	Send	[Room X] Smoke	Output	
	Receive	[Room X] Smoke	Input	

Tables with S-mode DP

The tables in Section 16.2 are sorted by application (not inputs/outputs as for the Synco 700 devices). The S-mode DPs refer to the central apartment unit QAX910 series B and C.

Notes

In the tables, "Always" in column "DP active" means that it is standard S-mode DP that is always configured in the ETS tool when the central apartment unit is selected.

"[Swi grp. X] = Yes" in column "DP active" means that parameter "[Switching group 1] = Yes" must be set.

16.2 QAX910, S-mode data points

QAX910: Time

Name in ETS	Input Output	DP active	Flags					Data point type KNX			Value range	QAX910 receives or sends:	
			C	R	W	T	U	ID	DPT_Name	Format			Unit
System time ⁵⁾	I / O	Always	1	1	1	1	1	19.001	_DateTime	8 bytes struct.	YYYY MM DD d hh mm ss ---	1900...2155 = Year 1...12 = Month 1...31 = Day of Month 0, 1...7 = Any day, Monday...Sunday 0...23 = Hours 0...59 = Minutes 0...59 = Seconds Status bits ¹⁾	From KNX system time source, receive timeout of 21 min. <u>or</u> to KNX system time receiver, heartbeat 10 min. or for system time adjustment.
Date ⁵⁾	I / O	Always	1	1	1	1	1	11.001	_Date	3 bytes struct.	YY MM DD	00...99 = Year ⁴⁾ 1...12 = Month 1...31 = Day of Month	From KNX date source, receive timeout of 21 min. <u>or</u> to KNX date receiver, heartbeat 10 min. or for date adjustment.
Time of day ⁵⁾	I / O	Always	1	1	1	1	1	10.001	_Time	3 bytes struct.	hh d mm ss	0...23 = Hours 1...7 = Monday... Sunday 0...59 = Minutes 0...59 = Seconds	From KNX time source, receive timeout of 21 min. <u>or</u> to KNX time receiver, heartbeat 10 min. or for time of day adjustment.

¹⁾ See Section 1.4.3, page 13.

⁴⁾ See Section 1.4.3, page 14.

⁵⁾ See Section 1.5.1, page 16, Standard S-mode DP.

QAX910: Fault

Name in ETS	Input Output	DP active	Flags					Data point type KNX				Value range	QAX910 rec. (I), sends (O)
			C	R	W	T	U	ID	DPT_Name	Format	Unit		
Fault information ⁵⁾	O	Always	1	1	0	1	0	219.001	_AlarmInfo ²⁾	6 bytes struct.	- - -	[0]...255 = Log no. [0...2]...255 = Alarm priority [0...14]...255 = Applicat. area [0...4]...255 = Error class [0...15]...255 = Alarm attributes [0...7]...255 = Fault state	Heartbeat 30 min. or when an error occurs.
Fault state (normal/faulty) ⁵⁾	O	Always	1	1	0	1	0	1.005	_Alarm	1 bit B ₁	- - -	0 = No alarm / normal (default) 1 = Alarm / faulty	Heartbeat 30 min. and for change.
Fault transmission (enable/disable) ⁵⁾	I	Always	1	0	1	0	1	1.003	_Enable	1 bit B ₁	- - -	0 = Disable 1 = Enable (default)	Event from KNX contact, set automatically to 1 without receipt after 48 hours.

²⁾ See Section 1.4.3, page 14.

⁵⁾ See Section 1.5.1, page 16, Standard S-mode DP.

QAX910: Fault inputs

Name in ETS	Input Output	DP active	Flags					Data point type KNX				Value range	QAX910 receives:
			C	R	W	T	U	ID	DPT_Name	Format	Unit		
Fault input 1...4: State From series C Fault input 1...8: State	I	Receive	1	0	1	0	1	1.001	_Switch	1 bit B ₁	- - -	0 = Off 1 = On (settable)	Event, no receive timeout.

- You can freely select Fault input 1...4 or Fault input 1...8, i.e. you can first configure e.g. Fault input 2.

QAX910: Supervision

Name in ETS	Input Output	DP active	Flags					Data point type KNX				Value range	QAX910 rec. (I), sends (O)
			C	R	W	T	U	ID	DPT_Name	Format	Unit		
Events status output	O	Send	1	1	0	1	0	1.001	_Switch	1 bit B ₁	---	0 = Off 1 = On	For change.
Door/window state of apartment	O	Send	1	1	0	1	0	1.019	_Window_Door	1 bit B ₁	---	0 = Closed 1 = Open	Heartbeat 15 min. and for change.
[Door 1..2] Door state	O	Send	1	1	0	1	0	1.019	_Window_Door	1 bit B ₁	---	0 = Closed 1 = Open	For change.
[Door 1..2] Door state	I	Receive	1	0	1	0	1	1.019	_Window_Door	1 bit B ₁	---	0 = Closed 1 = Open	Event from KNX contact, no receive timeout.
Supervision	I and O	Superv. = Yes	1	1	1	1	1	2.005	_Alarm_Control	2 bit B ₂	---	v c 0 0 = Inactive 0 1 = Inactive 1 0 = Partially monit. 1 1 = All monitored	No receive timeout <u>or</u> heartbeat 15 min. and for change.

- You can freely select [Door 1...2], i.e. you can first configure e.g. [Door 2].

QAX910: Outside/Meteo sensors

Name in ETS	Input Output	DP active	Flags					Data point type KNX				Value range	QAX910 rec. (I), sends (O)
			C	R	W	T	U	ID	DPT_Name	Format	Unit		
Meteo sensor: Outside temperature	O	Send	1	1	0	1	0	9.001	_Value_Temp	2 bytes F ₁₆	°C	-273.00...+670760.00 Floating point	Heartbeat 15 min. and for change >0.2 °C.
Outside temperature	I	Receive	1	0	1	0	1	9.001	_Value_Temp	2 bytes F ₁₆	°C	-273.00...+670760.00 Floating point	COV from KNX sensor.
Meteo sensor: Atmospheric pressure measured value	O	Send	1	1	0	1	0	9.006	_Value_Pres	2 bytes F ₁₆	Pa = N/m ²	[0...670760]	Heartbeat 15 min. and for change >20 Pa.
Meteo sensor: Atmospheric pressure on sea level	O	Send	1	1	0	1	0	9.006	_Value_Pres	2 bytes F ₁₆	Pa = N/m ²	[0...670760]	Heartbeat 15 min. and for change >20 Pa.
Twilight switch	I	Receive	1	0	1	0	1	1.001	_Switch	1 bit B ₁	---	0 = Dark 1 = Bright	Event from KNX twilight switch.

QAX910: Switching groups [1...8]

Name in ETS	Input Output	DP active	Flags					Data point type KNX				Value range	QAX910 rec. (I), sends (O)
			C	R	W	T	U	ID	DPT_Name	Format	Unit		
[Switching group 1...8] Switch	O	[Swi grp. X] = Yes, Fct. = Switch	1	0	0	1	0	1.001	_Switch	1 bit B ₁	---	0 = Off 1 = On	Event
[Switching group 1...8] Trigger On/Off	I	[Swi grp. X] = Yes, Fct. = Switch	1	0	1	0	0	1.001	_Switch	1 bit B ₁	---	0 = Off 1 = On	From KNX switch, no receive timeout.
[Switching group 1...4] Switch	O	[Swi grp. X] = Yes, Fct. = Dim	1	0	0	1	0	1.001	_Switch	1 bit B ₁	---	0 = Off 1 = On	Event
[Switching group 1...4] Dim	O	[Swi grp. X] = Yes, Fct. = Dim	1	0	0	1	0	3.007	_Control_Dimming	4 bit U ₄	---	On/Off via switching U ₄ U ₃ U ₂ U ₁ 0 0 0 1 = Darker 1 0 0 1 = Brighter 0 0 0 0 = Stop	Event
[Switching group 1...4] Trigger On/Off	I	[Swi grp. X] = Yes, Fct. = Dim	1	0	1	0	0	1.001	_Switch	1 bit B ₁	---	0 = Off 1 = On	From KNX switch, no receive timeout.
[Switching group 1...4] Blind Step/Stop	O	[Swi grp. X] = Yes, Fct. = Blind	1	0	0	1	0	1.007	_Step	1 bit B ₁	---	0 = Step up 1 = Step down	Event
[Switching group 1...8] Blind Up/Down	O	[Swi grp. X] = Yes, Fct. = Blind	1	0	0	1	0	1.008	_UpDown	1 bit B ₁	---	0 = Up 1 = Down	Event
[Switching group 1...8] Trigger Up/Down	I	[Swi grp. X] = Yes, Fct. = Blind	1	0	1	0	0	1.008	_Switch	1 bit B ₁	---	0 = Up 1 = Down	From KNX switch, no receive timeout.
[Switching group 1...8] Scene	O	[Swi grp. X] = Yes, Fct. = Scene	1	0	0	1	0	18.001	_SceneControl	1 byte B ₁ r ₁ U ₆	---	B ₁ 0 = Activate scene 1 = Learn scene r ₁ (Reserve) U ₆ Scene number 0...63	Event
[Switching group 1...8] Trigger (0=Scene A, 1=Scene B)	I	[Swi grp. X] = Yes, Fct. = Scene	1	0	1	0	0	1.022	_Scene_AB	1 bit B ₁	---	0 = Activate scene A 1 = Activate scene B	From KNX switch, no receive timeout.

- You can freely select [Switching group 1...8], i.e. you can first configure e.g. [Switching group 4].

QAX910: Light status indication

Name in ETS	Input Output	DP active	Flags					Data point type KNX				Value range	QAX910 receives:
			C	R	W	T	U	ID	DPT_Name	Format	Unit		
Light status indication Lamp 1...4	I	Lamp X = Yes	1	0	1	0	1	1.001	_Switch	1 bit B ₁	- - -	0 = Off 1 = On	From KNX light actor, no receive timeout.

- You can freely select Lamp 1...4, i.e. you can first configure e.g. Lamp 3.

QAX910: Apartment functions

Name in ETS	Input Output	DP active	Flags					Data point type KNX				Value range	QAX910 rec. (I), sends (O)
			C	R	W	T	U	ID	DPT_Name	Format	Unit		
Domestic hot water: Forced charging	I	DHW = Yes	1	0	1	0	0	1.017	_Trigger	1 bit B ₁	- - -	0 = No action 1 = Forced charging	Event from KNX contact, no receive timeout.
Domestic hot water operating mode: Preselection	I and O	DHW = Yes	1	1	1	1	1	20.103	_DHWMODE	1 byte N ₈	Enum.	0 = Auto 1 = Legionella protection 2 = Normal temp. 3 = Reduced temp. 4 = Protection mode	No receive timeout <u>or</u> heartbeat 15 min. and for change.
Domestic hot water operating mode: State	O	DHW = Yes	1	1	0	1	0	20.103	_DHWMODE	1 byte N ₈	Enum.	1 = Legionella protection 2 = Normal temp. 3 = Reduced temp. 4 = Protection mode	Heartbeat 15 min. and for change.
Domestic hot water storage tank temp: Setpoint	I and O	DHW = Yes	1	1	1	1	1	9.001	_Value_Temp	2 bytes F ₁₆	°C	-273.00...+670760.00 Floating point	No receive timeout <u>or</u> heartbeat 15 min. and for change.
Domestic hot water storage tank temp: Actual value	O	DHW = Yes	1	1	0	1	0	9.001	_Value_Temp	2 bytes F ₁₆	°C	-273.00...+670760.00 Floating point	Heartbeat 15 min. and for change >2 °C.

QAX910: Apartment functions (continued)

Name in ETS	Input Output	DP active	Flags					Data point type KNX				Value range	QAX910 rec. (I), sends (O)
			C	R	W	T	U	ID	DPT_Name	Format	Unit		
Absence: Contact	I	Absence = Yes	1	0	1	0	1	1.018	_Occupancy	1 bit B ₁	---	0 = Not occupied / absent 1 = Occupied / present	From KNX contact, no receive timeout.
Absence: State	O	Absence = Yes	1	1	0	1	0	1.018	_Occupancy	1 bit B ₁	---	0 = Not occupied / absent 1 = Occupied / present	Heartbeat 15 min. and for change.
Apartment operating mode: Preselection	I and O	Ap op mode = Yes	1	1	1	1	1	20.102	_HVACMode	1 byte N ₈	Enum.	0 = Auto 1 = Comfort 2 = Precomfort (Standby) 3 = Economy 4 = Protection mode (Building protection)	No receive timeout <u>or</u> for change.
Apartment operating mode: Comfort release	I	Ap op mode = Yes	1	0	1	0	1	1.003	_Enable	1 bit B ₁	---	0 = Disable 1 = Enable (default)	Receive timeout 31 min.
Heating summer operation: State	O	Send	1	1	0	1	0	1.002	_Bool	1 bit B ₁	---	0 = No preselection (default) 1 = Summer mode	Heartbeat 15 min. and for change.
Heating summer operation: Preselection	I	Receive	1	0	1	0	1	1.002	_Bool	1 bit B ₁	---	0 = No preselection (default) 1 = Summer mode	From KNX contact, receive timeout 31 min.
Heating/cooling changeover	I	2-pipe = Yes	1	0	1	0	1	1.002	_Bool	1 bit B ₁	---	0 = Cooling mode 1 = Heating mode (default)	From KNX contact, receive timeout 31 min.
Heat demand absolute	O	Heat dem = Yes	1	1	0	1	0	9.001	_Value_Temp	2 bytes F ₁₆	°C	-273.00...+670760.00 Floating point	Heartbeat 15 min. and for change >2 °C.
From series C Exhaust hood: Release	O	Exh hood = Yes	1	1	0	1	0	1.003	_Enable	1 Bit B ₁	---	0 = Disable 1 = Enable	Heartbeat 15 min. and for change.

QAX910: Ventilation

From series C Parameter group Ventilation

Name in ETS	Input Output	DP active	Flags					Data point type KNX				Value range	QAX910 rec. (I), sends (O)
			C	R	W	T	U	ID	DPT_Name	Format	Unit		
[Ventilation] Stage selection	I and O	Vent. = Yes	1	1	1	1	1	20.60172	_StepSelectorSwitch	1 Byte N ₈	Enum.	0 = Auto 1 = Off 2 = Stage 1 3 = Stage 2 4 = Stage 3	No receive timeout or heartbeat 15 min. and for change.
[Ventilation] Ventilation stage	O	Vent. = Yes	1	1	0	1	0	5.010	_Value_1_Ucount	1 Byte U ₈	Enum.	0 = Off 1 = Stage 1 2 = Stage 2 3 = Stage 3	Heartbeat 15 min. and for change.
[Ventilation] Contact 1...2	I	Vent. = Yes Contact X = Yes	1	0	1	0	1	1.001	_Switch	1 Bit B ₁	- - -	0 = Off 1 = On	Event, no receive timeout.
Air quality	O	Vent. = Yes Send	1	1	0	1	0	9.008	_Value_AirQuality	2 Bytes F ₁₆	ppm	[0...670760]	Heartbeat 15 min. and for change >10 ppm.
Air quality	I	Vent. = Yes Receive	1	0	1	0	1	9.008	_Value_AirQuality	2 Bytes F ₁₆	ppm	[0...670760]	Event, no receive timeout.
Air humidity	O	Vent. = Yes Send	1	1	0	1	0	9.007	_Value_Humidity	2 Bytes F ₁₆	%	[0...670760]	Heartbeat 15 min. and for change >5 %
Air humidity	I	Vent. = Yes Receive	1	0	1	0	1	9.007	_Value_Humidity	2 Bytes F ₁₆	%	[0...670760]	Event, no receive timeout.
Fireplace mode	O	Vent. = Yes Send	1	1	0	1	0	1.001	_Switch	1 Bit B ₁	- - -	0 = Off 1 = On	Heartbeat 15 min. and for change.
Fireplace mode	I	Vent. = Yes Receive	1	0	1	0	1	1.001	_Switch	1 Bit B ₁	- - -	0 = Off 1 = On	Event, no receive timeout.

QAX910: Temperature display

From series C Parameter group Temperature display

Name in ETS	Input Output	DP active	Flags					Data point type KNX				Value range	QAX910 rec. (I), sends (O)
			C	R	W	T	U	ID	DPT_Name	Format	Unit		
[Temperature display] Sensor 1...3	O	Sensor X = Send	1	1	0	1	0	9.001	_Value_Temp	2 Bytes F ₁₆	°C	-273.00...+670760.00 Floating point	Heartbeat 15 min. and for change >0.2 °C
[Temperature display] Sensor 1...3	I	Sensor X = Receive	1	0	1	0	1	9.001	_Value_Temp	2 Bytes F ₁₆	°C	-273.00...+670760.00 Floating point	Event, no receive timeout.

- You can freely select [Temperature display] Sensor 1...3, i.e. you can first configure e.g. [Temperature display] Sensor 3.

QAX910: Rooms [1...12]

Name in ETS	Input Output	DP active	Flags					Data point type KNX				Value range	QAX910 rec. (I), sends (O)
			C	R	W	T	U	ID	DPT_Name	Format	Unit		
Series B and series C V3.01 [Room 1...12] Room temperature	O	[Rm X] = Yes Rm heat. = Yes	1	1	0	1	0	9.001	_Value_Temp	2 bytes F ₁₆	°C	-273.00...+670760.00 Floating point	Heartbeat 15 min. and for change >0.04 °C.
From series C V3.02 [Room 1...12] Room temperature	O	[Rm X] = Yes Rm ctr = Yes Send	1	1	0	1	0	9.001	_Value_Temp	2 bytes F ₁₆	°C	-273.00...+670760.00 Floating point	Heartbeat 15 min. and for change >0.04 °C.
From series C V3.02 [Room 1...12] Room temperature	I	[Rm X] = Yes Rm heat. / Rm ctr = Yes Receive	1	0	1	0	1	9.001	_Value_Temp	2 bytes F ₁₆	°C	-273.00...+670760.00 Floating point	From KNX sensor, receive timeout 31 min.
[Room 1...12] Operating mode: Preselection	I and O	[Rm X] = Yes Rm heat. / Rm ctrl. = Yes	1	1	1	1	1	20.102	_HVACMode	1 byte N ₈	Enum.	0 = Auto 1 = Comfort 2 = Precomfort (Standby) 3 = Economy 4 = Protection mode (Building protection)	Event from KNX mode preselection (device/program), no receive timeout or for change.
[Room 1...12] Operating mode: State	O	[Rm X] = Yes Rm heat. / Rm ctrl. = Yes	1	1	0	1	0	20.102	_HVACMode	1 byte N ₈	Enum.	1 = Comfort 2 = Precomfort (Standby) 3 = Economy 4 = Protection mode (Building protection)	Heartbeat 15 min. and for change.
[Room 1...12] Room temperature: Economy heating setpoint	I and O	[Rm X] = Yes Rm heat. / Rm ctrl. = Yes	1	1	1	1	1	9.001	_Value_Temp	2 bytes F ₁₆	°C	-273.00...+670760.00 Floating point	From KNX setpoint source, no receive timeout or for change.
[Room 1...12] Room temperature: Precomfort heating setpoint	I and O	[Rm X] = Yes Rm heat. / Rm ctrl. = Yes	1	1	1	1	1	9.001	_Value_Temp	2 bytes F ₁₆	°C	-273.00...+670760.00 Floating point	From KNX setpoint source, no receive timeout or for change.
[Room 1...12] Room temperature: Comfort heating setpoint	I and O	[Rm X] = Yes Rm heat. / Rm ctrl. = Yes	1	1	1	1	1	9.001	_Value_Temp	2 bytes F ₁₆	°C	-273.00...+670760.00 Floating point	From KNX setpoint source, no receive timeout or for change.

QAX910: Rooms [1...12] (continued)

Name in ETS	Input Output	DP active	Flags					Data point type KNX				Value range	QAX910 rec. (I), sends (O)
			C	R	W	T	U	ID	DPT_Name	Format	Unit		
[Room 1...12] Valve position	O	[Rm X] = Yes Rm heat. / Rm ctrl. = Yes	1	1	0	1	0	5.001	_Scaling	1 byte U ₈	%	[0...100] Resolution 1%	Heartbeat 15 min. and for change >5%.
[Room 1...12] Window	O	[Rm X] = Yes Send	1	1	0	1	0	1.019	_Window_Door	1 bit B ₁	---	0 = Closed 1 = Open	For change only.
[Room 1...12] Window	I	[Rm X] = Yes Receive	1	0	1	0	1	1.019	_Window_Door	1 bit B ₁	---	0 = Closed 1 = Open	From KNX window contact, no receive timeout.
[Room 1...12] Smoke	O	[Rm X] = Yes Send	1	1	0	1	0	1.005	_Alarm	1 bit B ₁	---	0 = No alarm / normal (default) 1 = Alarm / faulty	For change only.
[Room 1...12] Smoke	I	[Rm X] = Yes Receive	1	0	1	0	1	1.005	_Alarm	1 bit B ₁	---	0 = No alarm / normal (default) 1 = Alarm / faulty	No actual receive timeout (if no alarms are received for 15 min., input is set to 0).

- You can freely select [Room 1...12], i.e. you can first configure e.g. [Room 7].

QAX910: Rooms [1...12] (continued)

Series C V3.01 Rooms [1...12] Room control, Cooling

Name in ETS	Input Output	DP active	Flags					Data point type KNX			Value range	QAX910 rec. (I), sends (O)		
			C	R	W	T	U	ID	DPT_Name	Format			Unit	
[Room 1...12] Cooling: Release	O	[Rm X] = Yes Rm ctrl. = Y With cooling release	1	1	0	1	0	1.003	_Enable	1 Bit B ₁	---	0 = Disable 1 = Enable	Upon a change of one of the three DPs, all three DPs are sent (e.g. to ZN1CL-IRSC by Zennio).	
[Room 1...12] Air conditioner: On/Off	O	[Rm X] = Yes Rm ctrl. = Y With air conditioner	1	1	0	1	0	1.001	_Switch	1 Bit B ₁	---	0 = Off 1 = On		
[Room 1...12] Air conditioner: Operating mode	O	[Rm X] = Yes Rm ctrl. = Y With air conditioner	1	1	0	1	0	20.60174	_SPUCOpMode	1 Byte N ₈	Enum.	0 = Auto 1 = Heating 4 = Cooling		
[Room 1...12] Air conditioner: Room temp. setpoint act.	O	[Rm X] = Yes Rm ctrl. = Y With air conditioner	1	1	0	1	0	9.001	_Value_Temp	2 Bytes F ₁₆	°C	-273.00...+670760.00 Floating point		
[Room 1...12] Room temp: Economy cooling setpoint	I and O	[Rm X] = Yes Rm ctrl. = Y With air conditioner	1	1	1	1	1	9.001	_Value_Temp	2 Bytes F ₁₆	°C	-273.00...+670760.00 Floating point		From KNX setpoint source, no receive timeout or for change.
[Room 1...12] Room temp: Precomfort cooling setpoint	I and O	[Rm X] = Yes Rm ctrl. = Y With air conditioner	1	1	1	1	1	9.001	_Value_Temp	2 Bytes F ₁₆	°C	-273.00...+670760.00 Floating point		From KNX setpoint source, no receive timeout or for change.
[Room 1...12] Room temp: Comfort cooling setpoint	I and O	[Rm X] = Yes Rm ctrl. = Y With air conditioner	1	1	1	1	1	9.001	_Value_Temp	2 Bytes F ₁₆	°C	-273.00...+670760.00 Floating point	From KNX setpoint source, no receive timeout or for change.	

- You can freely select [Room 1...12], i.e. you can first configure e.g. [Room 7].

QAX910: Rooms [1...12] (continued)

From C V3.02 Rooms [1...12] Room control, Cooling / Room controller

Name in ETS	Input Output	DP active	Flags					Data point type KNX				Value range	QAX910 rec. (I), sends (O)
			C	R	W	T	U	ID	DPT_Name	Format	Unit		
[Room 1...12] Cooling: Release	O	[Rm X] = Yes Rm ctrl. = Y With cooling release	1	1	0	1	0	1.003	_Enable	1 Bit B ₁	---	0 = Disable 1 = Enable	Heartbeat 15 min. and for change.
[Room 1...12] Air conditioner: On/Off	O	[Rm X] = Yes Rm ctrl. = Y With air conditioner	1	1	0	1	0	1.001	_Switch	1 Bit B ₁	---	0 = Off 1 = On	Upon a change of one of the three DPs, all three DPs are sent (e.g. to ZN1CL-IRSC by Zennio).
[Room 1...12] Air conditioner: Operating mode	O	[Rm X] = Yes Rm ctrl. = Y With air conditioner	1	1	0	1	0	20.60174	_SPUCOpMode	1 Byte N ₈	Enum.	0 = Auto 1 = Heating 4 = Cooling	
[Room 1...12] Air conditioner: Room temp. setpoint act.	O	[Rm X] = Yes Rm ctrl. = Y With air conditioner	1	1	0	1	0	9.001	_Value_Temp	2 Bytes F ₁₆	°C	-273.00...+670760.00 Floating point	
[Room 1...12] Room controller: Application mode	O	[Rm X] = Yes Rm ctr = Yes With room controller	1	1	0	1	0	20.105	_HVCContrMode	1 Byte N ₈	Enum	0 = Auto 1 = Heating 3 = Cooling 6 = Off	Heartbeat 15 min. and for change.
[Room 1...12] Room temp: Economy cooling setpoint	I and O	[Rm X] = Yes Rm ctr = Yes With room controller	1	1	1	1	1	9.001	_Value_Temp	2 Bytes F ₁₆	°C	-273.00...+670760.00 Floating point	From KNX setpoint source, no receive timeout or for change.
[Room 1...12] Room temp: Precomfort cooling setpoint	I and O	[Rm X] = Yes Rm ctr = Yes With room controller	1	1	1	1	1	9.001	_Value_Temp	2 Bytes F ₁₆	°C	-273.00...+670760.00 Floating point	From KNX setpoint source, no receive timeout or for change.
[Room 1...12] Room temp: Comfort cooling setpoint	I and O	[Rm X] = Yes Rm ctr = Yes With room controller	1	1	1	1	1	9.001	_Value_Temp	2 Bytes F ₁₆	°C	-273.00...+670760.00 Floating point	From KNX setpoint source, no receive timeout or for change.

- You can freely select [Room 1...12], i.e. you can first configure e.g. [Room 7].

17 QAX903, QAX913 Central apartment units

17.1 Overview

Note

See Section 16.2 for S-mode DPs of the QAX910 central apartment unit.

Brief description

The QAX903 and QAX913 central apartment units (both Synco living) control heating, cooling, ventilation in an apartment with max.12 rooms, while QAX913 additionally controls DHW. The absence function is used to implement heating and security-related functions (QAX913 only) such as reduced heat generation (heating, DHW), lighting control, door and window contact monitoring. The consumption values of the connected meters are used to bill heating costs.



QAX903



QAX913

Documentation

Data sheet	Central apartment unit QAX903	N2741
Data sheet	Central apartment unit QAX913	N2740
Instructions	Mounting and commissioning	C2740
Operating instructions		B2740

Overview of series for versions

	Software version Central apartment unit	Product data import-File *.vd5 ETS Program version
QAX903	V1.00	1.0
QAX913	V1.01 and 1.02	1.0

Note

Note the interdependence of software and program version listed in the above table if you want to add new devices to a line or area in ETS via [Add Devices](#) .

Number of S-mode DPs

Number of S-mode DPs	QAX903, V1.xx	QAX913, V1.xx
Visible in ETS	278	362
In group address table	370	370
In association table	370	370

Parameterization

See Section 17.1.1 to parameterize the central apartment units QAX903 and QAX913. See also Section 1.5 for a principal workflow.

The central apartment units QAX903 and QAX913 allows you to connect max. 370 S-mode DPs via group addresses.

An S-mode DP must be configured in ETS and the Synco device to ensure that the S-mode DP transmits valid values.

17.1.1 Parameterizing QAX9x3

Start parameterization

Start parameterization in ETS3 or ETS4 (screenshots ETS4).

Parameter groups

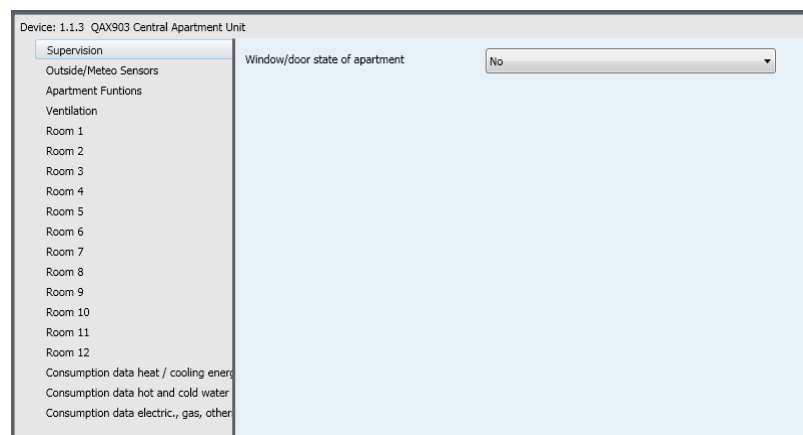

QAX903

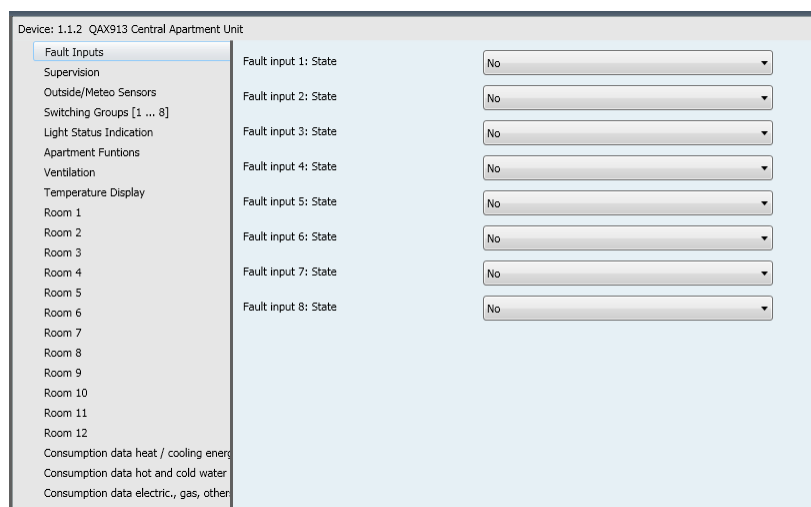

QAX913

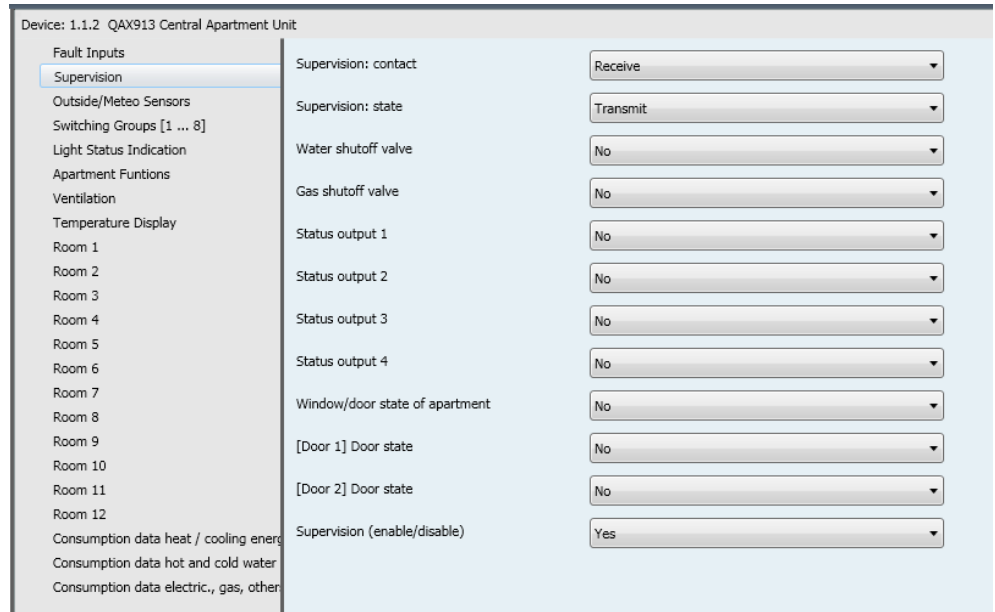

Parameters and Parameter values

Configuration

S-mode DP in ETS

Parameter values Receive, Transmit and Yes (and depending on parameter also other values) configure the S-mode DPs in ETS.

Supervision: Contact

- No → Supervision contact not used (default)
- Receive → DP 17, Supervision: Contact (configured in ETS)
→ Object Function: Receive (input)

Supervision: State

- No → Supervision state not used (default)
- Transmit → DP 18, Supervision: State (configured in ETS)
→ Object Function: Transmit (output)

Supervision (enable/disable)

- No → Supervision not used (default)
- Yes → DP 28, Supervision (enable/disable) (configured in ETS)
→ Object Function: Receive and Transmit (input and output) ¹⁾

¹⁾ S-mode DP number 28 (and other S-mode DP) are configured as input and output. The "Object Function" column indicates this through Receive and Transmit (see below).

Number	Name	Object Function	Description	Group Addresses	Length	C	R	W	T	U	Data Type	Priority
1	System time	Receive / Transmit			8 Byte	C	R	W	T	U		High
2	Date	Receive / Transmit			3 Byte	C	R	W	T	U	date	Low
3	Time of day	Receive / Transmit			3 Byte	C	R	W	T	U	time of day	Low
4	Fault information	Transmit			6 Byte	C	R	-	T	-		Alarm
7	Fault state (normal/faulty)	Transmit			1 bit	C	R	-	T	-		Low
8	Fault transmission (enable/disable)	Receive			1 bit	C	-	W	-	U	enable	Low
17	Supervision: contact	Receive			1 bit	C	-	W	-	U		Low
18	Supervision: state	Transmit			1 bit	C	R	-	T	-	on/off	Low
28	Supervision (enable/disable)	Receive and Transmit			2 bit	C	R	W	T	U		Low

Note

S-mode data points numbers 1 to 4 and 7, 8 are standard S-mode data points that are always configured automatically when a central apartment unit is selected in ETS.

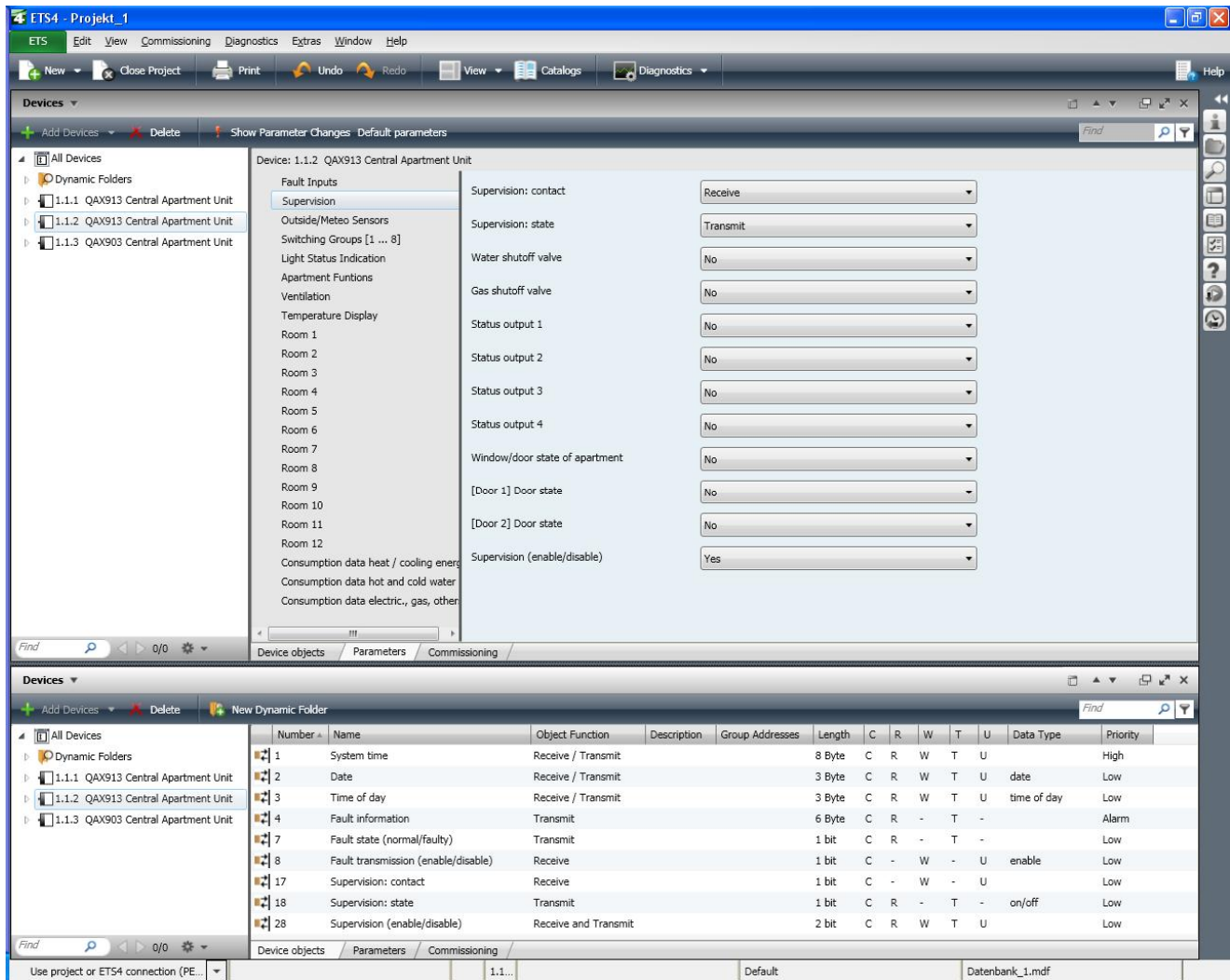

S-mode data points: Numbers and names in ETS

Note

The configured S-mode data points are displayed following the standard S-mode data points (Number 1 to 4 and 7, 8).

Parameter group Fault inputs

Fault input 1...8: State
 No → Fault input X not used (default)
 Receive → DP 9...16, Fault input 1...8: State

Parameter group Supervision

Supervision: Contact
 No → Supervision contact not used (default)
 Receive → DP 17, Supervision: Contact

Supervision: State
 No → Supervision state not used (default)
 Transmit → DP 18, Supervision: State

Water shutoff valve
 No → Water shutoff valve not used (default)
 Transmit → DP 19, Water shutoff valve

Gas shutoff valve	No Transmit	→ Gas shutoff valve not used (default) → DP 20, Gas shutoff valve
Status output 1...4	No Transmit	→ Status output X not used (default) → DP 21...24, Status output 1...4
Window/door state of apartment	No Transmit	→ Window/door state of apartment not used (default) → DP 25, Window/door state of apartment
[Door 1] Door state	No Transmit Receive	→ [Door 1] Door state not used (default) → DP 26, [Door 1] Door state (Transmit = Output) → DP 26, [Door 1] Door state (Receive = Input)
[Door 2] Door state	No Transmit Receive	→ [Door 2] Door state not used (default) → DP 27, [Door 2] Door state (Transmit = Output) → DP 27, [Door 2] Door state (Receive = Input)
Supervision (enable/disable)	No Yes	→ Supervision not used (default) → DP 28, Supervision (enable/disable) (Input and Output)

Parameter group Outside/Meteo sensors

Outside temperature	No Transmit Receive	→ Outside temperature not used (default) → DP 29, Outside temperature (Transmit = Output) → DP 30, Outside temperature (Receive = Input)
Atmospheric pressure	No Transmit	→ Atmospheric pressure not used (default) → DP 31, Meteo sensor: Atmospheric pressure measured value → DP 32, Meteo sensor: Atmospheric pressure on sea level
Twilight switch	No Receive	→ Twilight switch not used (default) → DP 33, Twilight switch (0=Dark; 1=Bright)

Example Standard S-mode data points and some configured S-mode data points for parameter groups: Fault inputs, Supervision, Outside/Meteo sensors.

Number	Name	Object Function	Description	Group Addresses	Length	C	R	W	T	U	Data Type	Priority
1	System time	Receive / Transmit			8 Byte	C	R	W	T	U		High
2	Date	Receive / Transmit			3 Byte	C	R	W	T	U	date	Low
3	Time of day	Receive / Transmit			3 Byte	C	R	W	T	U	time of day	Low
4	Fault information	Transmit			6 Byte	C	R	-	T	-		Alarm
7	Fault state (normal/faulty)	Transmit			1 bit	C	R	-	T	-		Low
8	Fault transmission (enable/disable)	Receive			1 bit	C	-	W	-	U	enable	Low
9	Fault input 1: State	Receive			1 bit	C	-	W	-	U	on/off	Low
16	Fault input 8: State	Receive			1 bit	C	-	W	-	U	on/off	Low
17	Supervision: contact	Receive			1 bit	C	-	W	-	U		Low
18	Supervision: state	Transmit			1 bit	C	R	-	T	-	on/off	Low
28	Supervision (enable/disable)	Receive and Transmit			2 bit	C	R	W	T	U		Low
29	Outside temperature	Transmit			2 Byte	C	R	-	T	-	temperature (°C)	Low

Configuration information

The following configuration information pertain to S-mode DPs of QAX903 and QAX913 central apartment units. The following applies:

Parameter group and Parameter	See information in margin.
Parameter value	Receive, Transmit, Yes, ...
Name	See column Name in ETS.
Object Function	See column Object Function in ETS.

	Parameter value	Name	Object Function
Fault inputs			
(QAX913 only)			
Fault input 1...8: State	Receive	Fault input X: State	Receive
Supervision			
(QAX913 only)			
Supervision: Contact	Receive	Supervision: Contact	Receive
Supervisio: State	Transmit	Supervision: State	Transmit
(QAX913 only)			
Water shutoff valve	Transmit	Water shutoff valve	Transmit
(QAX913 only)			
Gas shutoff valve	Transmit	Gas shutoff valve	Transmit
(QAX913 only)			
Status output 1...4	Transmit	Status output X	Transmit
(QAX913 only)			
Window/door state of apartment	Transmit	Window/door state of apartment	Transmit
[Door 1...2] Door state	Transmit	[Door X] Door state	Transmit
(QAX913 only)			
	Receive	[Door X] Door state	Receive
Supervision (enable/disable)	Yes	Supervision (enable/disable)	Receive and Transmit
(QAX913 only)			
Outside/Meteo sensors			
Outside temperature			
	Transmit	Outside temperature	Transmit
	Receive	Outside temperature	Receive
Atmospheric pressure			
	Transmit	Meteo sensor: Atmospheric pressure measured value	Transmit
		Meteo sensor: Atmospheric pressure on sea level	Transmit
Twilight switch			
(QAX913 only)			
	Receive	Twilight switch (0=Dark; 1=Bright)	Receive

	Parameter value	Name	Object Function	
Switching groups [1...8]				
(QAX913 only)				
Switching group 1...4: Function	Switch	[Switching group X] Switch	Transmit	
		[Switching group X] Trigger On/Off	Receive	
	Dim	[Switching group X] Switch	Transmit	
		[Switching group X] Dim	Transmit	
		[Switching group X] Trigger On/Off	Receive	
	Blind	[Switching group X] Blind Up/Down	Transmit	
		[Switching group X] Blind Step/Stop	Transmit	
		[Switching group X] Trigger Up/Down	Receive	
	Scene	[Switching group X] Scene	Transmit	
		[Switching group X] Trigger (0=Scene A, 1=Scene B)	Receive	
	Switching group 5...8: Function	Switch	[Switching group X] Switch	Transmit
			[Switching group X] Trigger On/Off	Receive
Blind		[Switching group X] Blind Up/Down	Transmit	
		[Switching group X] Trigger Up/Down	Receive	
Scene		[Switching group X] Scene	Transmit	
		[Switching group X] Trigger (0=Scene A, 1=Scene B)	Receive	
Light status indication				
(QAX913 only)				
Lamp 1...4	Receive	Light status indication Lamp X	Receive	
Apartment functions				
Domestic hot water				
(QAX913 only)				
	Yes	[Domestic hot water] Forced charging	Receive (Trigger)	
		[Domestic hot water] Operating mode: Preselection	Receive and Transmit	
		[Domestic hot water] Operating mode: State	Transmit	
		[Domestic hot water] Storage tank temp: Setpoint	Receive and Transmit	
		[Domestic hot water] Storage tank temp: Curr value	Transmit	
Absence	Yes	Absence: Contact	Receive	
		Absence: State	Transmit	
Apartment opoertanig mode	Yes	Apartment operating mode: Preselection	Receive and Transmit	
		Apartment operating mode: Comfort release	Receive	
Heating summer operation	Transmit	Heating summer operation: State	Transmit	
	Receive	Heating summer operation: Preselection	Receive	
Cooling release	Yes	Cooling release: Preselection	Receive	
		Cooling release: State	Transmit	
2-pipe H/C system	Receive	Heating/cooling changeover	Receive	
Dew point	Receive	Dew point	Receive	
Heat demand	Transmit	Heat demand absolute [°C]	Transmit	
Refrigeration demand	Transmit	Refrigeration demand absolute [°C]	Transmit	
Exhaust hood	Transmit	Exhaust hood: Release	Transmit	

	Parameter value	Name	Object Function
Ventilation			
Ventilation stage	Yes	[Ventilation] Stage selection	Receive and Transmit
		[Ventilation] Ventilation stage	Transmit
		[Ventilation] Ventilation stage [%]	Transmit
Ventilation contact 1...2	Receive	[Ventilation] Contact X	Receive
Air quality	Transmit	Air quality	Transmit
	Receive	Air quality	Receive
Air humidity	Transmit	Air humidity	Transmit
	Receive	Air humidity	Receive
Fireplace mode	Transmit	Fireplace mode	Transmit
	Receive	Fireplace mode	Receive
Temperature display (QAX913 only)			
Sensor 1...3	Transmit	[Temperature display] Sensor X	Transmit
	Receive	[Temperature display] Sensor X	Receive
Room 1...12			
Room temperature: Current value	Transmit	[Room X] Room temperature: Current value	Transmit
	Receive	[Room X] Room temperature: Current value	Receive
Room temperature: Current setpoint	Transmit	[Room X] Room temperature: Current setpoint	Transmit
Room control (heating)	Yes	[Room X] Operating mode: Preselection	Receive and Transmit
		[Room X] Operating mode: State	Transmit
		[Room X] Room temp: Economy heating setpoint	Receive and Transmit
		[Room X] Room temp: Precomfort heating setpoint	Receive and Transmit
		[Room X] Room temp: Comfort heating setpoint	Receive and Transmit
Valve position	Transmit	[Room X] Valve position	Transmit
Cooling / Room controller	With cooling release	[Room X] Cooling: Release	Transmit
	With air conditioner	[Room X] Air conditioner: On/Off	Transmit
		[Room X] Air conditioner: Operating mode	Transmit
		[Room X] Air conditioner: Room temp. curr. setp.	Transmit
		[Room X] Room temp: Economy cooling setpoint	Receive and Transmit
		[Room X] Room temp: Precomfort cooling setpoint	Receive and Transmit
	[Room X] Room temp: Comfort cooling setpoint	Receive and Transmit	
	With r.cont.Siemens	[Room X] Room controller: Application mode	Transmit
		[Room X] Room temp: Economy cooling setpoint	Receive and Transmit
		[Room X] Room temp: Precomfort cooling setpoint	Receive and Transmit
[Room X] Room temp: Comfort cooling setpoint		Receive and Transmit	

	Parameter value	Name	Object Function
Window state	Transmit	[Room X] Window	Transmit
	Receive	[Room X] Window	Receive
Smoke indication (QAX913 only)	Transmit	[Room X] Smoke	Transmit
	Receive	[Room X] Smoke	Receive
Consumption data heat / cooling energy			
Heat / cooling energy 1...4	Comb. h. and c. ener.	[Heat X] Meter reading current	Transmit
		[Cooling energy X] Meter reading current	Transmit
	Heat or cool. energy	[Heat/cooling energy X] Meter reading current	Transmit
	Comb. h. and c. ener. Heat or cool. energy	Combined heat and cooling energy meter Heat or cooling energy meter	
Consumption data hot and cold water			
Hot water 1...4	Yes	[Hot water X] Meter reading current	Transmit
Cold water 1...4	Yes	[Cold water X] Meter reading current	Transmit
Consumption data electric., gas, others			
Electricity 1...3	Yes	[Electricity X] Meter reading current	Transmit
Gas 1...3	Yes	[Gas X] Meter reading current	Transmit
Others 1...2	Yes	[Others X] Meter reading current	Transmit

Tables with S-mode DP

The tables in Section 17.2 are sorted by application (not inputs/outputs as for the Synco 700 devices).

Notes

In the tables, "Always" in column "DP active" means that it is standard S-mode DP that is always configured in the ETS tool when the central apartment unit is selected.

"S'vis: cont. = Receive" in column "DP active" means that the parameter "Supervision: Contact = Receive" must be set.

Important note

With QAX903 and QAX913 central apartment units and in contrast to all other Synco devices, the following applies under Function (ETS3) or Object Function (ETS4) in place of:

Input	Receive	Recv (I)
Input / Output	Receive / Transmit	Recv / Trns
Input and Output	Receive and Transmit	Recv and Trns
Output	Transmit	Trns (O)

The meaning of Receive, Transmit for the QAX9x3 central apartment units is the same as that for Input, Output in all other Synco devices. For more information, see Section 1.3.2.

17.2 QAX903, QAX913, S-mode data points

QAX9x3: Time

Name in ETS	Receive Transmit	DP active	Flags					Data point type KNX				Value range	QAX9x3 receives or sends:
			C	R	W	T	U	ID	DPT_Name	Format	Unit		
System time ⁵⁾	Recv / Trns	Always	1	1	1	1	1	19.001	_DateTime	8 bytes struct.	YYYY MM DD d hh mm ss ---	1900...2155 = Year 1...12 = Month 1...31 = Day of Month 0, 1...7 = Any day, Monday...Sunday 0...23 = Hours 0...59 = Minutes 0...59 = Seconds Status bits ¹⁾	From KNX system time source, receive timeout of 21 min. or to KNX system time receiver, heartbeat 10 min. or for system time adjustment.
Date ⁵⁾	Recv / Trns	Always	1	1	1	1	1	11.001	_Date	3 bytes struct.	YY MM DD	00...99 = Year ⁴⁾ 1...12 = Month 1...31 = Day of Month	From KNX date source, receive timeout of 21 min. or to KNX date receiver, heartbeat 10 min. or for date adjustment.
Time of day ⁵⁾	Recv / Trns	Always	1	1	1	1	1	10.001	_Time	3 bytes struct.	hh d mm ss	0...23 = Hours 1...7 = Monday... Sunday 0...59 = Minutes 0...59 = Seconds	From KNX time source, receive timeout of 21 min. or to KNX time receiver, heartbeat 10 min. or for time of day adjustment.

¹⁾ See Section 1.4.3, page 13.

⁴⁾ See Section 1.4.3, page 14.

⁵⁾ See Section 1.5.1, page 16, Standard S-mode DP.

QAX9x3: Fault

Name in ETS	Receive Transmit	DP active	Flags					Data point type KNX				Value range	QAX9x3 receives (I), transmits (O)
			C	R	W	T	U	ID	DPT_Name	Format	Unit		
Fault information ⁵⁾	Trns (O)	Always	1	1	0	1	0	219.001	_AlarmInfo ²⁾	6 bytes struct.	- - -	[0]...255 = Log no. [0...2]...255 = Alarm priority [0...14]...255 = Applicat. area [0...4]...255 = Error class [0...15]...255 = Alarm attributes [0...7]...255 = Fault state	Heartbeat 30 min. or when an error occurs.
Fault state (normal/faulty) ⁵⁾	Trns (O)	Always	1	1	0	1	0	1.005	_Alarm	1 bit B ₁	- - -	0 = No alarm / normal (default) 1 = Alarm / faulty	Heartbeat 30 min. and for change.
Fault transmission (enable/disable) ⁵⁾	Recv (I)	Always	1	0	1	0	1	1.003	_Enable	1 bit B ₁	- - -	0 = Disable 1 = Enable (default)	Event from KNX contact, set automatically to 1 without receipt after 48 hours.

²⁾ See Section 1.4.3, page 14.

⁵⁾ See Section 1.5.1, page 16, Standard S-mode DP.

QAX913: Fault inputs

Name in ETS	Receive Transmit	DP active	Flags					Data point type KNX				Value range	QAX913 receives:
			C	R	W	T	U	ID	DPT_Name	Format	Unit		
Fault input 1...8: State	Recv (I)	Fault inp X = Receive	1	0	1	0	1	1.001	_Switch	1 bit B ₁	- - -	0 = Off 1 = On (settable)	Event, no receive timeout.

- You can freely select Fault input 1...8, i.e. you can first configure e.g. Fault input 2.

QAX913: Supervision

Name in ETS	Receive Transmit	DP active	Flags					Data point type KNX				Value range	QAX913 receives (I), transmits (O)
			C	R	W	T	U	ID	DPT_Name	Format	Unit		
Supervision: Contact	Recv (I)	S'vis: cont. = Receive	1	0	1	0	1	1.017	_Trigger	1 Bit B ₁	---	0 = No action 1 = Toggle supervision state	Event from KNX contact, no receive timeout.
Supervision: State	Trns (O)	S'vis: state = Transmit	1	1	0	1	0	1.001	_Switch	1 Bit B ₁	---	0 = Not monitored 1 = Monitored	Heartbeat 15 min. and for change.
Water shutoff valve	Trns (O)	W s'off v. = Transmit	1	1	0	1	0	1.001	_Switch	1 Bit B ₁	---	0 = Open 1 = Closed	Heartbeat 15 min. and for change.
Gas shutoff valve	Trns (O)	Gas s'off v. = Transmit	1	1	0	1	0	1.001	_Switch	1 Bit B ₁	---	0 = Open 1 = Closed	Heartbeat 15 min. and for change.
Status output [1...4]	Trns (O)	Sta outp X = Transmit	1	1	0	1	0	1.001	_Switch	1 Bit B ₁	---	0 = Off 1 = On	Heartbeat 15 min. and for change.
Window/door state of apartment (also QAX903)	Trns (O)	Window/door sta = Transmit	1	1	0	1	0	1.019	_Window_Door	1 Bit B ₁	---	0 = Closed 1 = Open	Heartbeat 15 min. and for change.
[Door 1..2] Door state	Trns (O)	Door sta X = Transmit	1	1	0	1	0	1.019	_Window_Door	1 Bit B ₁	---	0 = Closed 1 = Open	For change.
[Door 1..2] Door state	Recv (I)	Door sta X = Receive	1	0	1	0	1	1.019	_Window_Door	1 Bit B ₁	---	0 = Closed 1 = Open	Event from KNX contact, no receive timeout.
Supervision (enable/disable)	Recv and Trns	Supervis = Yes	1	1	1	1	1	2.005	_Alarm_Control	2 Bit B ₂	---	v c 0 0 = Inactive 0 1 = Inactive 1 0 = Partially monit. 1 1 = All monitored	No receive timeout <u>or</u> heartbeat 15 min. and for change.

- You can freely select [Door 1...2], i.e. you can first configure e.g. [Door 2].

QAX9x3: Outside/Meteo sensors

Name in ETS	Receive Transmit	DP active	Flags					Data point type KNX				Value range	QAX9x3 receives (I), transmits (O)
			C	R	W	T	U	ID	DPT_Name	Format	Unit		
Outside temperature	Trns (O)	Outs temp = Transmit	1	1	0	1	0	9.001	_Value_Temp	2 Bytes F ₁₆	°C	-273.00...+670760.00 Floating point	Heartbeat 15 min. and for change >0.2 °C.
	Recv (I)	Outs temp = Receive	1	0	1	0	1	9.001	_Value_Temp	2 Bytes F ₁₆	°C	-273.00...+670760.00 Floating point	COV from KNX sensor.
Meteo sensor: Atmospheric pressure measured	Trns (O)	Atmosph pressure = Transmit	1	1	0	1	0	9.006	_Value_Pres	2 Bytes F ₁₆	Pa = N/m ²	[0...670760]	Heartbeat 15 min. and for change >20 Pa.
Meteo sensor: Atmospheric pressure on sea level	Trns (O)		1	1	0	1	0	9.006	_Value_Pres	2 Bytes F ₁₆	Pa = N/m ²	[0...670760]	Heartbeat 15 min. and for change >20 Pa.
Twilight switch (0=Dark; 1=Bright) (QAX913 only)	Recv (I)	Twilight swi = Receive	1	0	1	0	1	1.001	_Switch	1 Bit B ₁	- - -	0 = Dark 1 = Bright	Event from KNX twilight switch.

QAX913: Switching groups [1...8]

Name in ETS	Receive Transmit	DP active	Flags					Data point type KNX				Value range	QAX913 receives (I), transmits (O)
			C	R	W	T	U	ID	DPT_Name	Format	Unit		
[Switching group 1...8] Switch	Trns (O)	Swi grp X: Function = Switch	1	0	0	1	0	1.001	_Switch	1 Bit B ₁	---	0 = Off 1 = On	Event
[Switching group 1...8] Trigger On/Off	Recv (I)		1	0	1	0	0	1.001	_Switch	1 Bit B ₁	---	0 = Off 1 = On	From KNX switch, no receive timeout.
[Switching group 1...4] Switch	Trns (O)	Swi grp X: Function = Dim	1	0	0	1	0	1.001	_Switch	1 Bit B ₁	---	0 = Off 1 = On	Event
[Switching group 1...4] Dim	Trns (O)		1	0	0	1	0	3.007	_Control_Dimming	4 Bit U ₄	---	On/Off via switching U ₄ U ₃ U ₂ U ₁ 0 0 0 1 = Dunkler 1 0 0 1 = Heller 0 0 0 0 = Stop	Event
[Switching group 1...4] Trigger On/Off	Recv (I)		1	0	1	0	0	1.001	_Switch	1 Bit B ₁	---	0 = Off 1 = On	From KNX switch, no receive timeout.
[Switching group 1...4] Blind Step/Stop	Trns (O)	Swi grp X: Function = Blind	1	0	0	1	0	1.007	_Step	1 Bit B ₁	---	0 = Step up 1 = Step down	Event
[Switching group 1...8] Blind Up/Down	Trns (O)		1	0	0	1	0	1.008	_UpDown	1 Bit B ₁	---	0 = Up 1 = Down	Event
[Switching group 1...8] Trigger Up/Down	Recv (I)		1	0	1	0	0	1.008	_Switch	1 Bit B ₁	---	0 = Up 1 = Down	From KNX switch, no receive timeout.
[Switching group 1...8] Scene	Trns (O)	Swi grp X: Function = Scene	1	0	0	1	0	18.001	_SceneControl	1 Byte B ₁ r ₁ U ₆	---	B ₁ 0 = Activate Scene 1 = Learn Scene r ₁ (Reserve) U ₆ Scene number 0...63	Event
[Switching group 1...8] Trigger (0=Scene A, 1=Scene B)	Recv (I)		1	0	1	0	0	1.022	_Scene_AB	1 Bit B ₁	---	0 = Activate Scene A 1 = Activate Scene B	From KNX switch, no receive timeout.

- You can freely select [Switching group 1...8], i.e. you can first configure e.g. [Switching group 4].

QAX913: Light status indication

Name in ETS	Receive Transmit	DP active	Flags					Data point type KNX				Value range	QAX913 receives
			C	R	W	T	U	ID	DPT_Name	Format	Unit		
Light status indication Lamp 1...4	Recv (I)	Lamp X = Receive	1	0	1	0	1	1.001	_Switch	1 Bit B ₁	---	0 = Off 1 = On	From KNX light actor, no receive timeout.

- You can freely select Lamp 1...4, i.e. you can first configure e.g. Lamp 3.

QAX9x3: Apartment functions

Name in ETS	Receive Transmit	DP active	Flags					Data point type KNX				Value range	QAX9x3 receives (I), transmits (O)
			C	R	W	T	U	ID	DPT_Name	Format	Unit		
[Domestic hot water] Forced charging (QAX913 only)	Recv (I)	Domestic hot water = Yes	1	0	1	0	0	1.017	_Trigger	1 Bit B ₁	---	0 = No action 1 = Forced charging	Event from KNX contact, no receive timeout.
[Domestic hot water] Operating mode: Preselection (QAX913 only)	Recv and Trns		1	1	1	1	1	20.103	_DHWMode	1 Byte N ₈	Enum.	0 = Auto 1 = Legionella protection 2 = Normal temp. 3 = Reduced temp. 4 = Protection mode	No receive timeout <u>or</u> heartbeat 15 min. and for change.
[Domestic hot water] Operating mode: State (QAX913 only)	Trns (O)		1	1	0	1	0	20.103	_DHWMode	1 Byte N ₈	Enum.	1 = Legionella protection 2 = Normal temp. 3 = Reduced temp. 4 = Protection mode	Heartbeat 15 min. and for change.
[Domestic hot water] Storage tank temp: Setpoint (QAX913 only)	Recv and Trns		1	1	1	1	1	9.001	_Value_Temp	2 Bytes F ₁₆	°C	-273.00...+670760.00 Floating point	No receive timeout <u>or</u> heartbeat 15 min. and for change.
[Domestic hot water] Storage tank temp: Curr value (QAX913 only)	Trns (O)		1	1	0	1	0	9.001	_Value_Temp	2 Bytes F ₁₆	°C	-273.00...+670760.00 Floating point	Heartbeat 15 min. and for change >2 °C.
Absence: Contact	Recv (I)	Absence = Yes	1	0	1	0	1	1.018	_Occupancy	1 Bit B ₁	---	0 = Not occupied / absent 1 = Occupied / present	From KNX contact, no receive timeout.
Absence: State	Trns (O)		1	1	0	1	0	1.018	_Occupancy	1 Bit B ₁	---	0 = Not occupied / absent 1 = Occupied / present	Heartbeat 15 min. and for change.

QAX9x3: Apartment functions (continued)

Name in ETS	Receive Transmit	DP active	Flags					Data point type KNX				Value range	QAX9x3 receives (I), transmits (O)
			C	R	W	T	U	ID	DPT_Name	Format	Unit		
Apartment operating mode: Preselection	Recv and Trns	Apartment operating mode = Yes	1	1	1	1	1	20.102	_HVACMode	1 Byte N ₈	Enum.	0 = Auto 1 = Comfort 2 = Precomfort (Standby) 3 = Economy 4 = Protection mode (Building protection)	No receive timeout or bei Änderung
Apartment operating mode: Comfort release	Recv (I)		1	0	1	0	1	1.003	_Enable	1 Bit B ₁	---	0 = Disable 1 = Enable (default)	Receive timeout 31 min.
Heating summer operation: State	Trns (O)	Heating sum. oper = Transmit	1	1	0	1	0	1.002	_Bool	1 Bit B ₁	---	0 = Kein Vorgabe (default) 1 = Sommerbetrieb	Heartbeat 15 min. and for change.
Heating summer operation: Preselection	Recv (I)	Heating sum. oper = Receive	1	0	1	0	1	1.002	_Bool	1 Bit B ₁	---	0 = No preselection (default) 1 = Summer mode	From KNX contact, receive timeout 31 min.
Cooling release: Preselection	Recv (I)	Cooling release = Yes	1	1	0	1	0	1.002	_Bool	1 Bit B ₁	---	0 = No preselection (default) 1 = Summer mode	From KNX contact, receive timeout 31 min.
Cooling release: State	Trns (O)		1	0	1	0	1	1.002	_Bool	1 Bit B ₁	---	0 = No preselection (default) 1 = Summer mode	Heartbeat 15 min. and for change.
Heating/cooling changeover	Recv (I)	2-pipe H/C system = Receive	1	0	1	0	1	1.002	_Bool	1 Bit B ₁	---	0 = Kühlbetrieb 1 = Heizbetrieb (default)	From KNX contact, receive timeout 31 min.
Dew point	Recv (I)	Dew point = Receive	1	0	1	0	1	1.002	_Bool	1 Bit B ₁	---	0 = nicht aktiv (default) 1 = aktiv	From KNX contact, receive timeout 31 min.
Heat demand absolute [°C]	Trns (O)	Heat demand = Transmit	1	1	0	1	0	9.001	_Value_Temp	2 Bytes F ₁₆	°C	-273.00...+670760.00 Floating point	Heartbeat 15 min. and for change >2 °C.
Refrigeration demand absolute [°C]	Trns (O)	Refrig. demand = Transmit	1	1	0	1	0	9.001	_Value_Temp	2 Bytes F ₁₆	°C	-273.00...+670760.00 Floating point	Heartbeat 15 min. and for change >2 °C.
Exhaust hood: Release	Trns (O)	Exhaust hood = Transmit	1	1	0	1	0	1.003	_Enable	1 Bit B ₁	---	0 = Disable 1 = Enable	Heartbeat 15 min. and for change.

QAX9x3: Ventilation

Name in ETS	Receive Transmit	DP active	Flags					Data point type KNX				Value range	QAX9x3 receives (I), transmits (O)
			C	R	W	T	U	ID	DPT_Name	Format	Unit		
[Ventilation] Stage selection	Recv and Trns	Ventilation stage = Yes	1	1	1	1	1	20.60172	_StepSelectorSwitch	1 Byte N ₈	Enum.	0 = Auto 1 = Off 2 = Stage 1 3 = Stage 2 4 = Stage 3	No receive timeout or Heartbeat 15 min. and for change.
[Ventilation] Ventilation stage	Trns (O)		1	1	0	1	0	20.60190	_StepSelectorSwitch2	1 Byte U ₈	Enum.	0 = Off 1 = Stage 1 2 = Stage 2 3 = Stage 3	Heartbeat 15 min. and for change.
[Ventilation] Ventilation stage [%]	Trns (O)		1	1	0	1	0	5.001	_Scaling	1 Byte U ₈	%	[0...100] Resolution 1%	Heartbeat 15 min. and for change.
[Ventilation] Contact 1...2	Recv (I)	Vent cont X = Receive	1	0	1	0	1	1.001	_Switch	1 Bit B ₁	- - -	0 = Off 1 = On	Event, no receive timeout
Air quality	Trns (O)	Air quality = Transmit	1	1	0	1	0	9.008	_Value_AirQuality	2 Bytes F ₁₆	ppm	[0...670760]	Heartbeat 15 min. and for change >10 ppm.
	Recv (I)	Air quality = Receive	1	0	1	0	1	9.008	_Value_AirQuality	2 Bytes F ₁₆	ppm	[0...670760]	Event, no receive timeout
Air humidity	Trns (O)	Air humidity = Transmit	1	1	0	1	0	9.007	_Value_Humidity	2 Bytes F ₁₆	%	[0...670760]	Heartbeat 15 min. and for change >5 %.
	Recv (I)	Air humidity = Receive	1	0	1	0	1	9.007	_Value_Humidity	2 Bytes F ₁₆	%	[0...670760]	Event, no receive timeout
Fireplace mode	Trns (O)	Firepl mode = Transmit	1	1	0	1	0	1.001	_Switch	1 Bit B ₁	- - -	0 = Off 1 = On	Heartbeat 15 min. and for change.
	Recv (I)	Firepl mode = Receive	1	0	1	0	1	1.001	_Switch	1 Bit B ₁	- - -	0 = Off 1 = On	Event, no receive timeout

QAX913: Temperature display

Name in ETS	Receive Transmit	DP active	Flags					Data point type KNX				Value range	QAX913 receives (I), transmits (O)
			C	R	W	T	U	ID	DPT_Name	Format	Unit		
[Temperature display] Sensor 1...3	Trns (O)	Sensor X = Transmit	1	1	0	1	0	9.001	_Value_Temp	2 Bytes F ₁₆	°C	-273.00...+670760.00 Floating point	Heartbeat 15 min. and for change >0.2 °C.
	Recv (I)	Sensor X = Receive	1	0	1	0	1	9.001	_Value_Temp	2 Bytes F ₁₆	°C	-273.00...+670760.00 Floating point	Event, no receive timeout

- You can freely select [Temperature display] Sensor 1...3, i.e. you can first configure e.g. [Temperature display] Sensor 3.

QAX9x3: Rooms [1...12]

Name in ETS	Receive Transmit	DP active	Flags					Data point type KNX				Value range	QAX9x3 receives (I), transmits (O)
			C	R	W	T	U	ID	DPT_Name	Format	Unit		
[Room 1...12] Room temperature: Current value	Trns (O)	Rm temp.: Current val = Transmit	1	1	0	1	0	9.001	_Value_Temp	2 Bytes F ₁₆	°C	-273.00...+670760.00 Floating point	Heartbeat 15 min. and for change >0.04 °C.
	Recv (I)	Rm temp.: Current val = Receive	1	0	1	0	1	9.001	_Value_Temp	2 Bytes F ₁₆	°C	-273.00...+670760.00 Floating point	From KNX sensor, receive timeout 31 min.
[Room 1...12] Room temperature: Current setpoint	Trns (O)	Rm temp.: Curr. setp = Transmit	1	1	0	1	0	9.001	_Value_Temp	2 Bytes F ₁₆	°C	-273.00...+670760.00 Floating point	Heartbeat 15 min. and for change >0.04 °C.
[Room 1...12] Operating mode: Preselection	Recv and Trns	Room control (heating) = Yes	1	1	1	1	1	20.102	_HVACMode	1 Byte N ₈	Enum.	0 = Auto 1 = Comfort 2 = Precomfort (Standby) 3 = Economy 4 = Protection mode (Building protection)	Event from KNX mode preselection (device/program), no receive timeout or for change.
[Room 1...12] Operating mode: State	Trns (O)		1	1	0	1	0	20.102	_HVACMode	1 Byte N ₈	Enum.	1 = Comfort 2 = Precomfort (Standby) 3 = Economy 4 = Protection mode (Building protection)	Heartbeat 15 min. and for change.

QAX9x3: Rooms [1...12] (continued)

Name in ETS	Receive Transmit	DP active	Flags					Data point type KNX				Value range	QAX9x3 receives (I), transmits (O)
			C	R	W	T	U	ID	DPT_Name	Format	Unit		
[Room 1...12] Room temperature: Economy heating setpoint	Recv and Trns	Room control (heating) = Yes	1	1	1	1	1	9.001	_Value_Temp	2 Bytes F ₁₆	°C	-273.00...+670760.00 Floating point	From KNX setpoint source, no receive timeout or for change.
[Room 1...12] Room temperature: Precomfort heating setpoint	Recv and Trns		1	1	1	1	1	9.001	_Value_Temp	2 Bytes F ₁₆	°C	-273.00...+670760.00 Floating point	From KNX setpoint source, no receive timeout or for change.
[Room 1...12] Room temperature: Comfort heating setpoint	Recv and Trns		1	1	1	1	1	9.001	_Value_Temp	2 Bytes F ₁₆	°C	-273.00...+670760.00 Floating point	From KNX setpoint source, no receive timeout or for change.
[Room 1...12] Valve position	Trns (O)	Valve pos = Transmit	1	1	0	1	0	5.001	_Scaling	1 Byte U ₈	%	[0...100] Resolution 1%	Heartbeat 15 min. and for change >5%.
[Room 1...12] Cooling: Release	Trns (O)	Cool / Rm controller = With cool release	1	1	0	1	0	1.003	_Enable	1 Bit B ₁	- - -	0 = Disable 1 = Enable	Heartbeat 15 min. and for change.
[Room 1...12] Air conditioner: On/Off	Trns (O)	Cool / Rm controller = With air conditioner	1	1	0	1	0	1.001	_Switch	1 Bit B ₁	- - -	0 = Off 1 = On	Upon a change of one of the three DPs, all three DPs are sent (e.g. to ZN1CL-IRSC by Zennio).
Series A [Room 1...12] Air conditioner: Operating mode ¹⁾	Trns (O)		1	1	0	1	0	20.60174	_SPUCOpMode	1 Byte N ₈	Enum.	0 = Auto 1 = Heating 4 = Cooling	
From series B [Room 1...12] Air conditioner: Operating mode ²⁾	Trns (O)		1	1	0	1	0	20.105	_HVCContrMode	1 Byte N ₈	Enum.	0 = Auto 1 = Heating 3 = Cooling 6 = Off	
[Room 1...12] Air conditioner: Room temp. curr. setp.	Trns (O)		1	1	0	1	0	9.001	_Value_Temp	2 Bytes F ₁₆	°C	-273.00...+670760.00 Floating point	
[Room 1...12] Room controller: Application mode	Trns (O)	Cool / Rm controller = With room controller	1	1	0	1	0	20.105	_HVCContrMode	1 Byte N ₈	Enum.	0 = Auto 1 = Heating 3 = Cooling 6 = Off	Heartbeat 15 min. and for change.

¹⁾ Compatible with Zennio IRSC Plus **V4.xx**

²⁾ Compatible with Zennio IRSC Plus **from V5.xx**

QAX9x3: Rooms [1...12] (continued)

Name in ETS	Receive Transmit	DP active	Flags					Data point type KNX				Value range	QAX9x3 receives (I), transmits (O)
			C	R	W	T	U	ID	DPT_Name	Format	Unit		
[Room 1...12] Room temperature: Economy heating setpoint	Recv and Trns	Cool / Rm controller = With air conditioner = With room controller	1	1	1	1	1	9.001	_Value_Temp	2 Bytes F ₁₆	°C	-273.00...+670760.00 Floating point	From KNX setpoint source, no receive timeout or for change.
[Room 1...12] Room temperature: Precomfort heating setpoint	Recv and Trns		1	1	1	1	1	9.001	_Value_Temp	2 Bytes F ₁₆	°C	-273.00...+670760.00 Floating point	From KNX setpoint source, no receive timeout or for change.
[Room 1...12] Room temperature: Comfort heating setpoint	Recv and Trns		1	1	1	1	1	9.001	_Value_Temp	2 Bytes F ₁₆	°C	-273.00...+670760.00 Floating point	From KNX setpoint source, no receive timeout or for change.
[Room 1...12] Window	Trns (O)	Wind. state = Transmit	1	1	0	1	0	1.019	_Window_Door	1 Bit B ₁	---	0 = Closed 1 = Open	For change only.
	Recv (I)	Wind. state = Receive	1	0	1	0	1	1.019	_Window_Door	1 Bit B ₁	---	0 = Closed 1 = Open	From KNX window contact, no receive timeout.
[Room 1...12] Smoke (QAX913 only)	Trns (O)	Smoke indic = Transmit	1	1	0	1	0	1.005	_Alarm	1 Bit B ₁	---	0 = No alarm / normal (default) 1 = Alarm / faulty	For change only.
	Recv (I)	Smoke indic = Receive	1	0	1	0	1	1.005	_Alarm	1 Bit B ₁	---	0 = No alarm / normal (default) 1 = Alarm / faulty	No actual receive timeout (if no alarms are received for 15 min., input is set to 0).

- You can freely select [Room 1...12], i.e. you can first configure e.g. [Room 7].

QAX9x3: Consumption data heat / cooling energy

Name in ETS	Transmit	DP active	Flags					Data point type KNX				Value range	QAX9x3 transmits (O)
			C	R	W	T	U	ID	DPT_Name	Format	Unit		
[Heat 1...4] Meter reading current	Trns (O)	Heat / cool energy X = Comb. heat and cool energy	1	1	0	1	0	12.001	_Value_4_Ucount	4 Bytes U ₃₂	---	0...+2 ³²	For change.
[Cooling energy 1...4] Meter reading current	Trns (O)		1	1	0	1	0	12.001	_Value_4_Ucount	4 Bytes U ₃₂	---	0...+2 ³²	For change.
[Heat/cooling energy 1...4] Meter reading current	Trns (O)	Heat / cool energy X = heat or cool energy	1	1	0	1	0	12.001	_Value_4_Ucount	4 Bytes U ₃₂	---	0...+2 ³²	For change.

QAX9x3: Consumption data hot and cold water

Name in ETS	Transmit	DP active	Flags					Data point type KNX				Value range	QAX9x3 transmits (O)
			C	R	W	T	U	ID	DPT_Name	Format	Unit		
[Hot water 1...4] Meter reading current	Trns (O)	Hot water X = Yes	1	1	0	1	0	12.001	_Value_4_Ucount	4 Bytes U ₃₂	---	0...+2 ³²	For change.
[Cold water 1...4] Meter reading current	Trns (O)	Cold w X = Yes	1	1	0	1	0	12.001	_Value_4_Ucount	4 Bytes U ₃₂	---	0...+2 ³²	For change.

QAX9x3: Consumption data electric., gas, others

Name in ETS	Transmit	DP active	Flags					Data point type KNX				Value range	QAX9x3 transmits (O)
			C	R	W	T	U	ID	DPT_Name	Format	Unit		
[Electricity 1...3] Meter reading current	Trns (O)	Electricity X = Yes	1	1	0	1	0	12.001	_Value_4_Ucount	4 Bytes U ₃₂	---	0...+2 ³²	For change.
[Gas 1...3] Meter reading current	Trns (O)	Gas X = Yes	1	1	0	1	0	12.001	_Value_4_Ucount	4 Bytes U ₃₂	---	0...+2 ³²	For change.
[Others 1...2] Meter reading current	Trns (O)	Others X = Yes	1	1	0	1	0	12.001	_Value_4_Ucount	4 Bytes U ₃₂	---	0...+2 ³²	For change.

Blank page

18 Index

A	
Abbreviations	8
Area 0	9
Area line 0	9
Areas 1...15	9
Assign parameter value	19
B	
Basic types RMH760	63
Basic types RMU7x0B	24
Basic types RMU7x0B Step 3	24
C	
Comfort button	16
Communication flags	14
Communication object	7
D	
Data point formats	15
Data point inputs / outputs	12
Device address	10
DPT, data point type	8
DPT_AlarmInfo	16
DPT_Date	16
DPT_DateTime	15
DPT_Trigger	16
E	
Edit Parameters	19
F	
Fixed group addresses	12
G	
Group address	11
Group object:	7
I	
Import files	7
Individual address	10
K	
KNX network	9
L	
Lines 1...15	9
LTE mode	7
M	
Main lines 1..15	9
N	
Network address	10
O	
Out of Service	18
Overview	
Boiler sequence controller RMK770	83
Boiler sequence controller RMK770 V2.0	83
Bus operator units RMZ792, RMZ792B	137
Central apartment unit QAX910	189
Central apartment units QAX903, QAX913	211
Central communication unit OZW771	141
Central communication unit OZW775	145
Central control unit RMB795	97
Central control unit RMB795B	97
Heating controller RMH760	63
Heating controller RMH760B	63
Room thermostat RD600KN	155
Room thermostat RDG100KN	173
Room thermostat RDG160KN	173
Room thermostat RDG400KN	181
Room thermostat RDU341	165
Room thermostats RDF301, RDF301.50	155
Room unit QAW740	153
Switching and monitoring device RMS705	117
Switching and monitoring device RMS705B	117
Universal controllers RMU7x0	23
Universal controllers RMU7x0B	23
Universal controllers RMU7x0B Step 3	23
Web server OZW772 V2.0, OZW772 V3.0	149
OZW771: Inputs	143
OZW771: Inputs / Outputs	142
OZW771: Outputs	143
OZW772: Inputs	151
OZW772: Inputs / Outputs	150
OZW772: Outputs	151
OZW775: Inputs	147
OZW775: Inputs / Outputs	146
OZW775: Outputs	147
P	
Parameterization in ETS	17
Plant types, RMH760B	64
Product data	7
Q	
QAW740: Outputs	154
QAX910: Apartment functions	203
QAX910: Fault	200
QAX910: Fault inputs	200
QAX910: Light status indication	203
QAX910: Outside/Meteo sensors	201
QAX910: Rooms [1...12]	207
QAX910: Rooms [1...12] Room control, Cooling	209
QAX910: Rooms [1...12] Room control, Cooling / Room controller	210
QAX910: Supervision	201
QAX910: Switching groups [1...8]	202
QAX910: Temperature display	206
QAX910: Time	199
QAX910: Ventilation	205
QAX913: Fault inputs	221
QAX913: Light status indication	225
QAX913: Supervision	222
QAX913: Switching groups [1...8]	224
QAX913: Temperature display	228
QAX9x3: Apartment functions	225

QAX9x3: Consumption data electric., gas, others...231	RMH760B: Plant types 64
QAX9x3: Consumption data heat / cooling energy .231	RMH760B: Terminals 80
QAX9x3: Consumption data hot and cold water231	RMK770 V2.0: Inputs 90
QAX9x3: Fault221	RMK770 V2.0: Inputs / Outputs..... 89
QAX9x3: Outside/Meteo sensors223	RMK770 V2.0: Outputs..... 91
QAX9x3: Rooms [1...12].....228	RMK770 V2.0: Terminals 93
QAX9x3: Time220	RMK770: Inputs 85
QAX9x3: Ventilation227	RMK770: Inputs / Outputs 84
R	RMK770: Outputs 87
RDF301... : Inputs158	RMS705: Inputs 121
RDF301... : Inputs and outputs156	RMS705: Inputs / Outputs 119
RDF301... : Outputs161	RMS705: Inputs and outputs 120
RDF301.50: Outputs163	RMS705: Outputs 122
RDF301.50: Outputs and inputs (Synchr. inputs)....157	RMS705: Terminals..... 123
RDF600KN: Inputs158	RMS705B: Inputs 128
RDF600KN: Inputs and outputs156	RMS705B: Inputs / Outputs..... 126
RDF600KN: Outputs161	RMS705B: Inputs and outputs..... 127
RDG100KN: Inputs.....175	RMS705B: Outputs..... 129
RDG100KN: Inputs and outputs.....174	RMS705B: Terminal inputs as Rec. objects 132
RDG100KN: Outputs.....178	RMS705B: Terminal outputs as Trans. objects 133
RDG160KN: Inputs.....175	RMS705B: Terminals inputs as Trans. objects 133
RDG160KN: Inputs and outputs.....174	RMU7x0: Inputs..... 26
RDG160KN: Outputs.....178	RMU7x0: Inputs / Outputs 25
RDG400KN: Inputs.....183	RMU7x0: Outputs 28
RDG400KN: Inputs and outputs.....182	RMU7x0B Step 3: Inputs / Outputs, Type A 38
RDG400KN: Outputs.....186	RMU7x0B Step 3: Inputs / Outputs, Type C 48
RDU341: Inputs.....167	RMU7x0B Step 3: Inputs / Outputs, Type P 44
RDU341: Inputs and outputs166	RMU7x0B Step 3: Inputs / Outputs, Type U 52
RDU341: Outputs170	RMU7x0B Step 3: Inputs and outputs, Type A 39
RMB795: Inputs.....101	RMU7x0B Step 3: Inputs and outputs, Type C 49
RMB795: Inputs / Outputs99	RMU7x0B Step 3: Inputs and outputs, Type P 45
RMB795: Inputs and outputs.....100	RMU7x0B Step 3: Inputs and outputs, Type U 53
RMB795: Outputs.....102	RMU7x0B Step 3: Inputs, Basic type A 41
RMB795: Terminals.....103	RMU7x0B Step 3: Inputs, Basic type C 50
RMB795B: Inputs (Reveive).....108	RMU7x0B Step 3: Inputs, Basic type P 46
RMB795B: Inputs / Outputs.....106	RMU7x0B Step 3: Inputs, Basic type U 54
RMB795B: Inputs and Outputs.....107	RMU7x0B Step 3: Outputs, Basic type A 42
RMB795B: Outputs (Send).....109	RMU7x0B Step 3: Outputs, Basic type C 51
RMB795B: Terminal inputs as reception objects110	RMU7x0B Step 3: Outputs, Basic type P 47
RMB795B: Terminal inputs as reception objects, Extension modules RMZ78x113	RMU7x0B Step 3: Outputs, Basic type U 55
RMB795B: Terminal inputs as transmis. objects.....111	RMU7x0B Step 3: Terminal inputs as reception objects, all Basic types 57
RMB795B: Terminal inputs as transmis. objects, Extension modules RMZ78x114	RMU7x0B Step 3: Terminal inputs as transmission objects, all Basic types 58
RMB795B: Terminal outputs as transmis. objects ..112	RMU7x0B Step 3: Terminal outputs as transmission objects, all Basic types 59
RMB795B: Terminal outputs as transmis. objects, Extension modules RMZ78x115	RMU7x0B: Basic types..... 24
RMH760: Basic types.....63	RMU7x0B: Inputs 32
RMH760: Inputs67	RMU7x0B: Inputs / Outputs..... 29
RMH760: Inputs / Outputs.....66	RMU7x0B: Inputs and outputs..... 30
RMH760: Outputs.....70	RMU7x0B: Outputs..... 33
RMH760B: Inputs74	RMU7x0B: Terminals 35
RMH760B: Inputs / Outputs72	RMZ792, RMZ792B: Inputs 138
RMH760B: Inputs and outputs73	RMZ792, RMZ792B: Outputs 139
RMH760B: Outputs76	

S			
S-mode data points	8	Terminal inputs as transmission objects, Extension modules RMZ78x	61
S-mode DP	8	Terminal outputs as transmission objects, Extension modules RMZ78x	62
S-mode DP sends 0	18	Timer button	16
Standard S-mode DP	18	Transmission medium KNX TP1	7
Subnetwork	10	V	
T		View, All Devices	17
Terminal inputs as reception objects, Extension modules RMZ78x	60	Z	
		Zone addresses	7

Siemens Switzerland Ltd
Infrastructure & Cities Sector
Building Technologies Division
Gubelstrasse 22
CH-6301 Zug
Tel. +41 41-724 24 24
<http://www.siemens.com/sbt>

© 2004-2013 Siemens Switzerland Ltd
Subject to change