

FEATURES

- Presence Detector with four adjustable-sensitivity sectors.
- Lighting level sensor with human eye spectral sensitivity.
- 6 presence detector channels.
- 2 constant light regulation channels.
- Occupancy detection.
- 10 Logic functions
- Total data saving on KNX bus failure.
- Integrated KNX BCU.
- Dimensions Ø85 x 47mm.
- Surface-mounted or flush-mounted.
- Conformity with the CE directives.

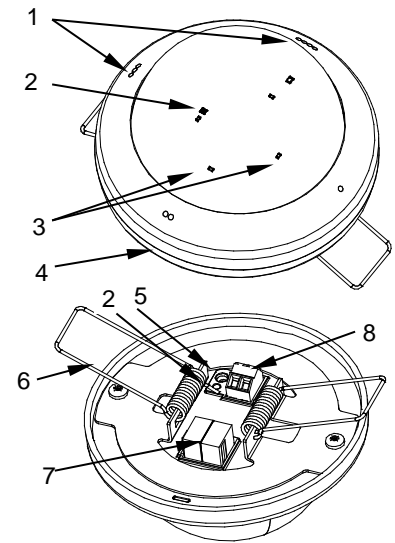

Figure 1. Presentia C

1. Orientation marks	2. Programming LED	3. 4x Detection notification LED	4. Base
5. Programming button	6. Retaining spring	7. KNX connector	8. Auxiliary Sensor Input (Without use)

Programming button: short press to set programming mode. If this button is held while plugging the device into the KNX bus, it enters the safe mode.

Programming LED: programming mode indicator (red). When the device enters into safe mode, it blinks (red) every half second. During the start-up (reset or after KNX bus failure) and if the device is not in safe mode, it emits a blue blinking sequence during the motion sensor initialization.

GENERAL SPECIFICATIONS				
CONCEPT		DESCRIPTION		
Type of device		Electric operation control device		
KNX supply	Voltage (typical)	29VDC SELV		
	Voltage range	21...31VDC		
	Maximum consumption	Voltage	mA	mW
		29VDC (typical)	8.15	236.35
24VDC ⁽¹⁾	10	240		
Connection type		Typical TP1 bus connector for rigid cable 0.80mm Ø		
External power supply		Not required		
Operation temperature		0°C to +35°C		
Storage temperature		-20°C to +55°C		
Operation humidity		5 to 95% RH (no condensation)		
Storage humidity		5 to 95% RH (no condensation)		
Complementary characteristics		Class B		
Protection class		III		
Operation type		Continuous operation		
Device action type		Type 1		
Electrical stress period		Long		
Degree of protection		IP20, clean environment		
Installation		Surface-mounted or flush-mounted.		
Minimum clearances		Not required		
Response on KNX bus failure		Data saving according to parameterization		
Response on KNX bus restart		Data recovery according to parameterization		
Operation indicator		The programming LED indicates programming mode (red) or motion sensors initialization (blue blinking). The motion detection of each sector is indicated by a white flash.		
Weight		89.5g		
PCB CTI index		175V		
Housing material		PC/ABS FR V0 halogen free housing and HDPE lens.		

⁽¹⁾ Maximum consumption in the worst case scenario (KNX Fan-In model)

SURFACE-MOUNTED INSTALLATION

1. Please remove the retaining springs.
2. Drill four holes (Ø6mm) on the ceiling forming a 43mm-side square shape and insert plugs.
3. Anchor the base by using screws. Recover the wiring and connect it.
4. Fix the device to the base. Pay attention to the orientation marks.

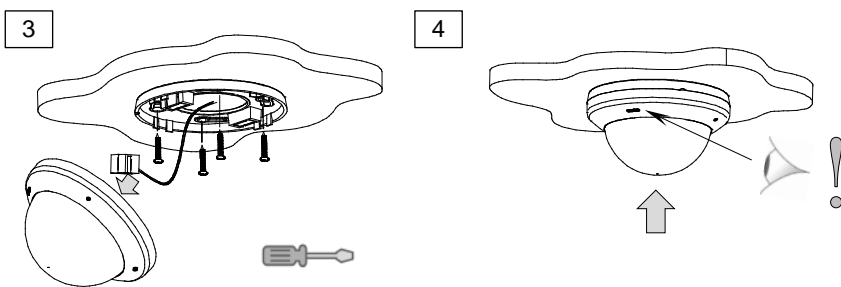
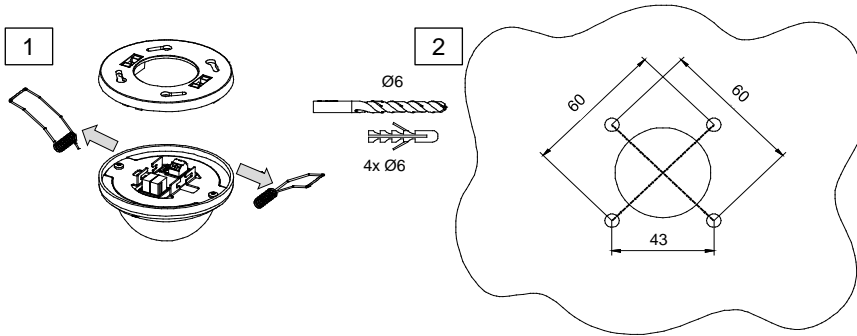

FLUSH-MOUNTED INSTALLATION

1. Make a Ø40mm hole on the ceiling.
2. Recover the wiring and connect it to the device.
3. Insert the device into the ceiling hole and allow the retaining springs to close.
4. Fix it and pay attention to the orientation marks.

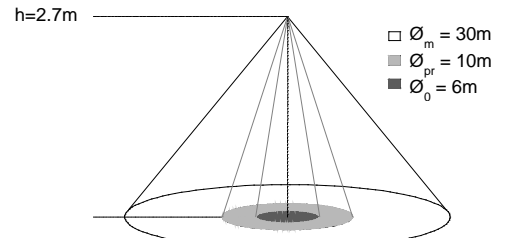
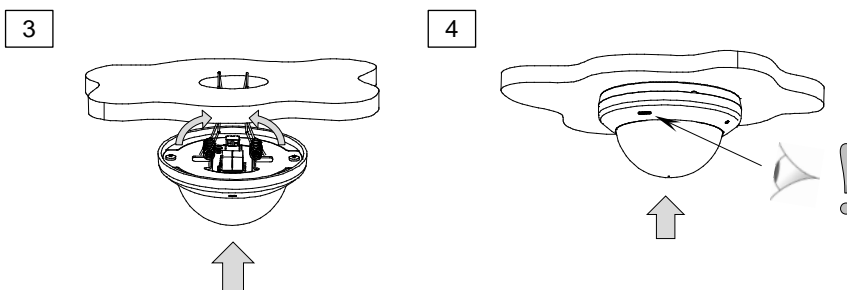
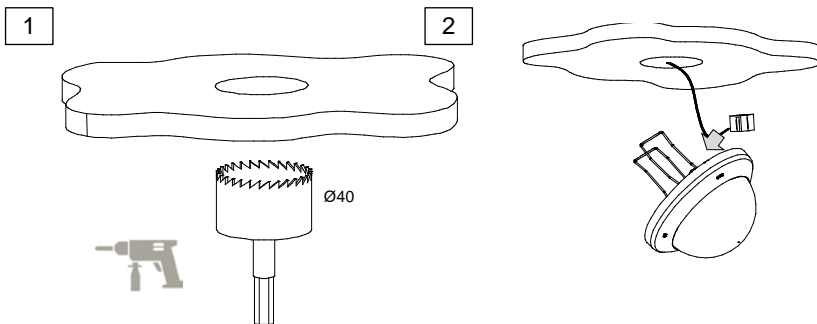

\varnothing_m : Tangential motion detection area. For perpendicular movement to the sensor, the motion detection area is decreased (see installation tips).
 \varnothing_{pr} : Presence detection area (1 meter over the floor)
 \varnothing_0 : Maximum detection area (detection not affected by sensitivity parametrization)

Figure 2. Presence and movement detection ranges.

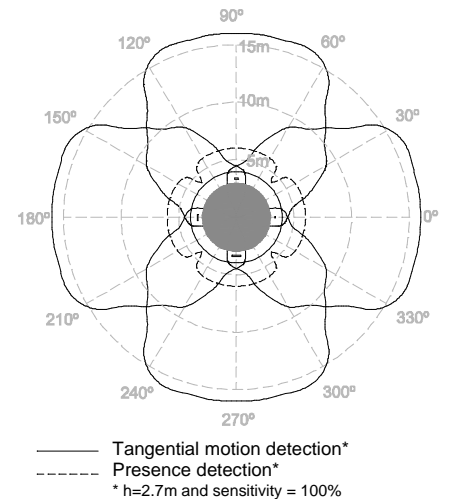

Figure 3. Detection sectors

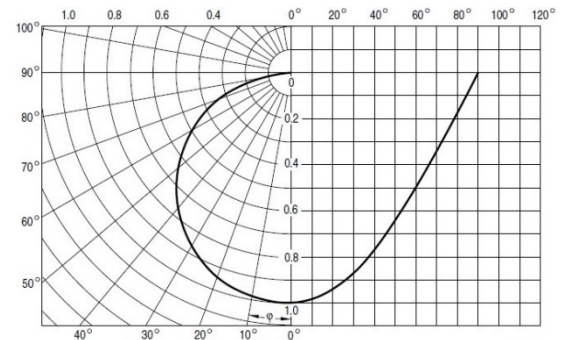

Figure 4. Illuminance sensor sensitivity.

SAFETY INSTRUCTIONS

- Installation should only be performed by qualified professionals according to the laws and regulations applicable in each country.
- Do not connect the mains voltage nor any other external voltage to any point of the KNX bus; it would represent a risk for the entire KNX system. The facility must have enough insulation between the mains (or auxiliary) voltage and the KNX bus or the wires of other accessories, in case of being installed.
- Keep the device away from water and do not cover it with clothes, paper or any other material while in use.
- The WEEE logo means that this device contains electronic parts and it must be properly disposed of by following the instructions at <http://zennio.com/weee-regulation>.