



# MAXinBOX 66 v2

**Multifunction Actuator with 6 Outputs and 6 Inputs**

**ZIOMB66V2**

Application program version: [1.1]  
User manual edition: [1.1]\_a

# CONTENTS

---

Contents .....	2
1 Introduction .....	3
1.1 MAXinBOX 66 v2 .....	4
1.2 Installation .....	5
1.3 Start-Up and Power Loss .....	6
2 Configuration .....	7
2.1 General .....	7
2.2 Inputs .....	10
2.2.1 Binary Input .....	10
2.2.2 Temperature Probe .....	10
2.2.3 Motion Detector .....	10
2.3 Outputs .....	12
2.4 Logic Functions .....	13
2.5 Thermostats .....	14
2.6 Master Light .....	15
2.7 Scene temporisation .....	18
2.8 Manual Control .....	20
ANNEX I. Communication Objects .....	24

## DOCUMENT UPDATES

---

Version	Changes	Page(s)
[1.1_a]	<b>Changes in the application program of MAXinBOX 66 v2:</b> <ul style="list-style-type: none"><li data-bbox="427 479 746 510">• Internal optimization.</li></ul>	-

# 1 INTRODUCTION

---

## 1.1 MAXINBOX 66 V2

---

MAXinBOX 66 v2 from Zennio is a versatile KNX actuator featuring a wide variety of functions:

- **6 relay outputs**, configurable as:
  - Up to 3 independent shutter channels (with or without slats),
  - Up to 6 individual ON/OFF outputs,
  - A combination of the above.
- **6 multi-purpose inputs**, configurable as:
  - Temperature probes (possibility to parameterise a personalised probe),
  - Binary inputs (i.e., pushbuttons, switches, sensors),
  - Motion detectors.
- **10 customisable, multi-operation logic functions.**
- **4 independent thermostats.**
- **Master light control** for an easy, out-of-the-box control of a set of luminaires (or functionally equivalent devices) one of which acts as a general lamp and the others as secondary lamps.
- **Manual operation / supervision** of the 6 relay outputs through the on-board pushbuttons and LEDs.
- **Relay switches counter.**
- **Heartbeat** or periodical “still-alive” notification.

## 1.2 INSTALLATION

MAXinBOX 66 v2 connects to the KNX bus through the on-board KNX connector.

Once the device is provided with power from the KNX bus, both the individual address and the associated application program may be downloaded.

This device does not need any additional external power since it is entirely powered through the KNX bus.

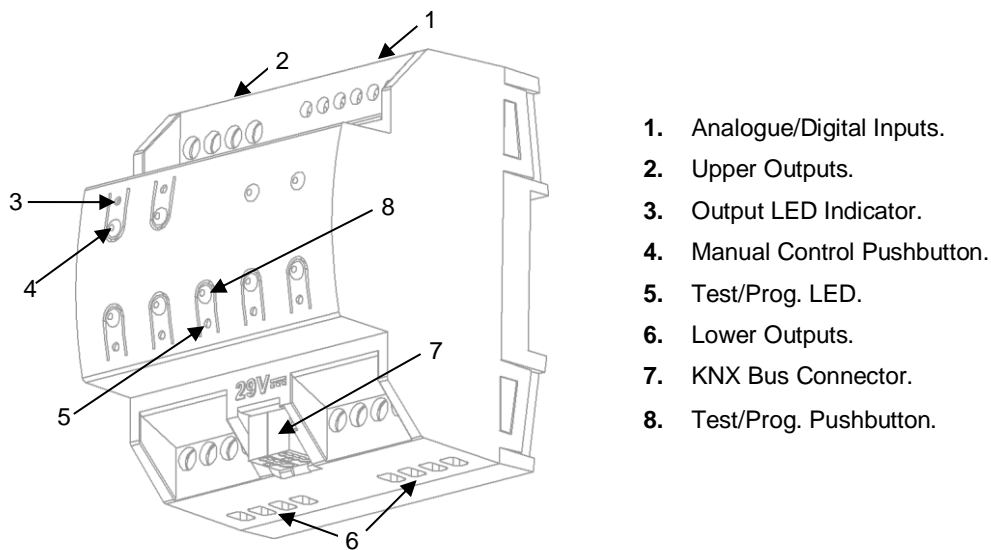

Figure 1. Elements scheme.

The main elements of the device are described next.

- **Test/Prog. Pushbutton (8):** a short press on this button sets the device into the programming mode, making the associated LED (5) light in red.

**Note:** if this button is held while plugging the device into the KNX bus, the device will enter into **safe mode**. In such case, the LED will blink in red every 0.5 seconds.

- **Outputs (2 and 6):** output ports for the insertion of the stripped cables of the systems being controlled by the actuator (see section 2.3). Please secure the connection by means of the on-board screws.
- **Inputs (1):** input ports for the insertion of the stripped cables of external elements such as switches / motion detectors / temperature probes, etc. One

of the two cables of each element needs to be connected to one of the slots labelled “1” to “6”, while the other cable should be connected to the slot labelled as “C”. Note that all the external input devices share the “C” slot for one of the two cables. Please secure the connection by means of the on-board screws.

To get detailed information about the technical features of this device, as well as on the installation and security procedures, please refer to the corresponding **Datasheet**, bundled with the original package of the device and also available at [www.zennio.com](http://www.zennio.com).

### 1.3 START-UP AND POWER LOSS

---

During the start-up of the device, the Test/Prog. LED will blink in blue colour for a few seconds before MAXinBOX 66 v2 is ready. External orders will not be executed during this time, but afterwards.

Depending on the configuration, some specific actions will also be performed during the start-up. For example, the integrator can set whether the output channels should switch to a particular state and whether the device should send certain objects to the bus after the power recovery. Please consult the next sections of this document for further details.

On the other hand, when a bus power failure takes place, MAXinBOX 66 v2 will interrupt any pending actions, and will save its state so it can be recovered once the power supply is restored.

For safety reasons, all **shutter channels** will be stopped (i.e., the relays will open) if a power loss takes place, while the individual outputs will switch to the specific state configured in ETS (if any).

## 2 CONFIGURATION

### 2.1 GENERAL

After importing the corresponding database in ETS and adding the device into the topology of the desired project, the configuration process begins by entering the Parameters tab of the device.

#### ETS PARAMETERISATION

The only parameterisable screen available by default is General. From this screen it is possible to activate/deactivate all the required functionality.

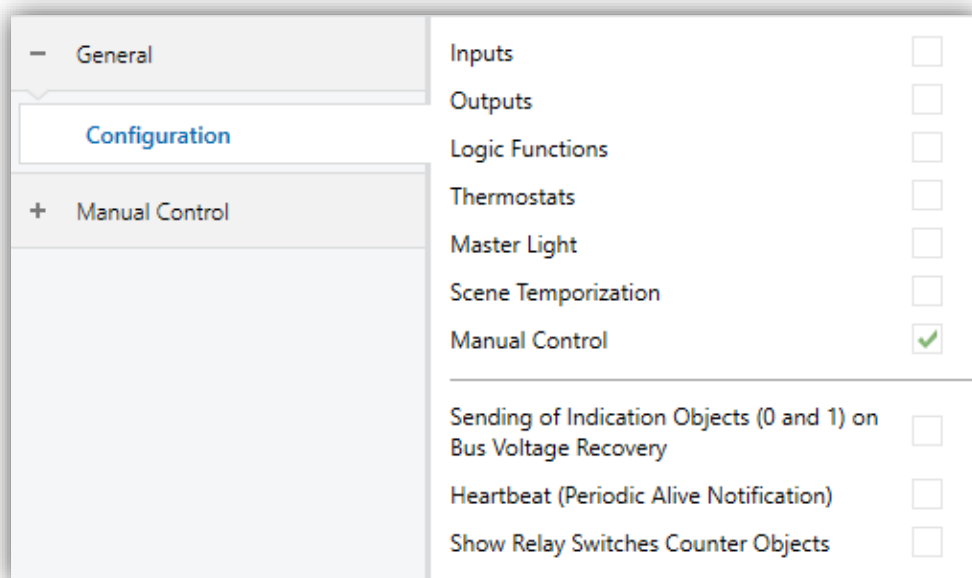
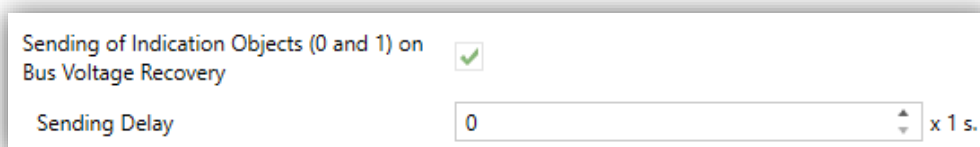

Figure 2. General screen

- **Inputs** [*disabled/enabled*]<sup>1</sup>: enables o disables the “Inputs” tab on the left menu. See section 2.2 for more details.
- **Outputs** [*disabled/enabled*]: enables o disables the “Outputs” tab on the left menu. See section 2.3 for more details.

<sup>1</sup> The default values of each parameter will be highlighted in blue in this document, as follows: [*default/rest of options*].

- **Logic Functions** [[disabled/enabled](#)]: enables o disables the “Logic Functions” tab on the left menu. See section 2.4 for more details.
- **Thermostats** [[disabled/enabled](#)]: enables o disables the “Thermostats” tab on the left menu. See section 2.5 for more details.
- **Master Light** [[disabled/enabled](#)]: enables o disables the “Master Light” tab on the left menu. See section 2.6 for more details.
- **Scene Temporization** [[disabled/enabled](#)]: enables o disables the “Scene Temporization” tab on the left menu. See section 2.7 for more details.
- **Manual Control** [[disabled/enabled](#)]: enables o disables the “Manual Control” tab on the left menu. See section 2.8 for more details.
- **Sending of Indication Objects (0 and 1) on Bus Voltage Recovery** [[disabled/enabled](#)]: this parameter lets the integrator activate two new communication objects (“**Reset 0**” and “**Reset 1**”), which will be sent to the KNX bus with values “0” and “1” respectively whenever the device begins operation (for example, after a bus power failure). It is possible to parameterise a certain **delay** [[0...255](#)] to this sending.



Sending of Indication Objects (0 and 1) on Bus Voltage Recovery

Sending Delay  x 1 s.

Figure 3. Sending of Indication objects on bus voltage recovery

- **Heartbeat (Periodic Alive Notification)** [[disabled/enabled](#)]: this parameter lets the integrator incorporate a one-bit object to the project (“**[Heartbeat] Object to Send ‘1’**”) that will be sent periodically with value “1” to notify that the device is still working (*still alive*).



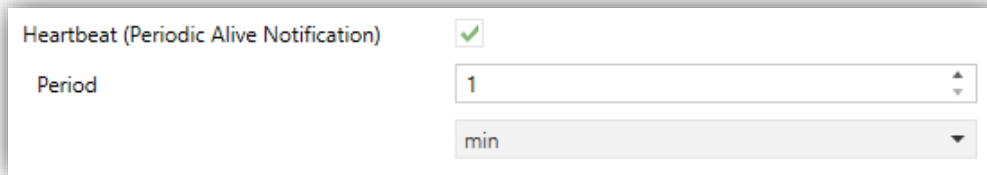

Heartbeat (Periodic Alive Notification)	<input checked="" type="checkbox"/>
Period	1
	min

Figure 4. Heartbeat.

**Note:** The first sending after download or bus failure takes place with a delay of up to 255 seconds, to prevent bus overload. The following sendings match the period set.

- **Show Relay Switches Counter Objects** [[disabled/enabled](#)]: enables two communication objects to keep track of the number of switches performed by each of the relays ("**[Relay X] Number of Switches**") and the maximum number of switches carried out in a minute ("**[Relay X] Maximum Switches per Minute**").

## 2.2 INPUTS

---

MAXinBOX 66 v2 incorporates **6 analogue/digital inputs**, each configurable as a:

- **Binary Input**, for the connection of a pushbutton or a switch/sensor.
- **Temperature Probe**, to connect a temperature sensor from Zennio.
- **Motion Detector**, to connect a motion detector (models ZN1IO-DETEC-P and ZN1IO-DETEC-X from Zennio).

**Important:** Older models of the Zennio motion detector (e.g., ZN1IO-DETEC and ZN1IO-DETEC-N) will not work properly with MAXinBOX 66 v2.

### 2.2.1 BINARY INPUT

---

Please refer to the “**Binary Inputs**” user manual, available under the MAXinBOX 66 v2 product section at [www.zennio.com](http://www.zennio.com).

### 2.2.2 TEMPERATURE PROBE

---

Please refer to the “**Temperature Probe**” user manual, available under the MAXinBOX 66 v2 product section at [www.zennio.com](http://www.zennio.com).

### 2.2.3 MOTION DETECTOR

---

It is possible to connect motion detectors (models **ZN1IO-DETEC-P** and **ZN1IO-DETEC-X** from Zennio) to the input ports of MAXinBOX 66 v2.

Please refer to the “**Motion Detector**” user manual, available under the MAXinBOX 66 v2 product section at [www.zennio.com](http://www.zennio.com), for detailed information about the functionality and the configuration of the related parameters.

#### **Notes:**

- *The ZN1IO-DETEC-P motion detector is compatible with a variety of Zennio devices. However, depending on the device it is actually being connected to, the functionality may differ slightly. Therefore, please refer specifically to the aforementioned user manual.*
- *Motion detectors with references ZN1IO-DETEC and ZN1IO-DETEC-N are*

**not compatible** with MAXinBOX 66 v2 (may report inaccurate measurements if connected to this device).

- When connected to MAXinBOX 66 v2, the rear micro-switch of model ZN110-DETEC-P should be set to position “**Type B**”.

## 2.3 OUTPUTS

---

MAXinBOX 66 v2 incorporates **6 relay outputs**, each configurable as a:

- **Individual binary output**, which allows an independent control of a load (up to 6 different loads can be controlled by a MAXinBOX 66 v2).
- **Shutter channel**, which allows controlling the motion of one blind (up to 3 blinds can be controlled by a MAXinBOX 66 v2).

For detailed information about the functionality and the configuration of the related parameters, please refer to the following specific manuals, all of them available under the MAXinBOX 66 v2 product section at the Zennio homepage ([www.zennio.com](http://www.zennio.com)):

- **Individual outputs.**
- **Shutter channels.**

## 2.4 LOGIC FUNCTIONS

---

This module makes it possible to perform numeric and binary operations to incoming values received from the KNX bus, and to send the results through other communication objects specifically enabled for this purpose.

MAXinBOX 66 v2 can implement **up to 10 different and independent functions**, each of them entirely customisable and consisting in **up to 4 consecutive operations each**.

The execution of each function can depend on a configurable **condition**, which will be evaluated every time the function is **triggered** through specific, parameterisable communication objects. The result after executing the operations of the function can also be evaluated according to certain **conditions** and afterwards sent (or not) to the KNX bus, which can be done every time the function is executed, periodically or only when the result differs from the last one.

Please refer to the “**Logic Functions**” user manual available under the MAXinBOX 66 v2 product section at the Zennio homepage ([www.zennio.com](http://www.zennio.com)) for detailed information about the functionality and the configuration of the related parameters.

## 2.5 THERMOSTATS

---

MAXinBOX 66 v2 implements **four Zennio thermostats** which can be enabled and configured independently.

Please refer to the specific “**Zennio Thermostat**” user manual available under the MAXinBOX 66 v2 product section at the Zennio homepage ([www.zennio.com](http://www.zennio.com)) for detailed information about the functionality and the configuration of the related parameters.

## 2.6 MASTER LIGHT

---

The Master Light function brings the option to monitor the state of up to 12 light sources (or even more, if the Master Light controls from multiple Zennio devices are linked together) or of any other elements whose state is transmitted through a binary object and, depending on those states, perform a **master order** every time a certain trigger signal (again, a binary value) is received through a specific object.

Such master order will consist in:

- A **general switch-off** order, if at least one of the up to twelve status objects is found to be on.
- A **courtesy switch-on** order, if none of the up to twelve status objects is found to be on.

Note that the above switch-off and switch-on orders are not necessarily a binary value being sent to the bus – it is up to the integrator the decision of what to send to the KNX bus in both cases: a shutter order, a thermostat setpoint or mode switch order, a constant value, a scene... Only the trigger object and the twelve status objects are required to be binary (on/off).

The most typical scenario for this Master Light control would be a hotel room with a master pushbutton next to the door. When leaving the room, the guest will have the possibility of pressing on the master pushbutton and make all the lamps turn off together. Afterwards, back on the room and with all the lamps off, pressing on the same master pushbutton will only make a particular lamp turn on (e.g., the closest lamp to the door) – this is the courtesy switch-on.

Besides, it is possible to concatenate two or more Master Light modules by means of a specific communication object which represents the general state of the light sources of each module. Thereby, it is possible to expand the number of light sources by considering the general state of one module as an additional light source for another.

## ETS PARAMETERISATION

Once the Master Light function has been enabled, a specific tab will be included in the menu on the left. This new parameter screen (Figure 5) contains the following options:

General	Number of State Objects	1
Configuration	Trigger Value	0/1
Master Light	General Switch Off	
Configuration	Delay	0 x 1 s
	Binary Value	<input checked="" type="checkbox"/>
	Scaling	<input type="checkbox"/>
	Scene	<input type="checkbox"/>
	HVAC	<input type="checkbox"/>
	Courtesy Switch On	
	Delay	0 x 1 s
	Binary Value	<input checked="" type="checkbox"/>
	Scaling	<input type="checkbox"/>
	Scene	<input type="checkbox"/>
	HVAC	<input type="checkbox"/>

Figure 5. Master Light

- **Number of State Objects** [1...12]: defines the number of 1-bit status objects required. These objects are called “[ML] Status Object *n*”.

In addition, the general status object (“[ML] General status”) will always be available in the project topology. It will be sent to the bus with a value of “1” whenever there is at least one of the above state objects with such value. Otherwise (i.e., if none of them has a value of “1”), it will be sent with a value of “0”.

- **Trigger Value** [0 / 1 / 0/1]: sets the value that will trigger, when received through “[ML] Trigger”, the master action (the general switch-off or the courtesy switch-on).

- **General Switch-Off.**

- **Delay** [0...255] [x 1 s]: defines a certain delay (once the trigger has been received) before the execution of the general switch-off. The allowed range is 0 to 255 seconds.



- **Binary Value** [*disabled/enabled*]: if checked, object “[ML] **General Switch-off: Binary Object**” will be enabled, which will send one “0” whenever the general switch-off takes off.
- **Scaling** [*disabled/enabled*]: if checked, object “[ML] **General Switch-off: Scaling**” will be enabled, which will send a percentage value (configurable in **Value** [*0...100*]) whenever the general switch-off takes off.
- **Scene** [*disabled/enabled*]: if checked, object “[ML] **General Switch-off: Scene**” will be enabled, which will send a scene run / save order (configurable in **Action** [*Run / Save*] and **Scene Number** [*1...64*]) whenever the general switch-off takes off
- **HVAC** [*disabled/enabled*]: if checked, object “[ML] **General Switch-off: HVAC mode**” will be enabled, which will send an HVAC thermostat mode value (configurable in **Value** [*Auto / Comfort / Standby / Economy / Building Protection*]) whenever the general switch-off takes off

**Note:** *the above options are not mutually exclusive; it is possible to send values of different nature together.*

#### ● **Courtesy Switch-On:**

The parameters available here are entirely analogous to those already mentioned for General Switch-Off. However, in this case the names of the objects start with “[ML] **Courtesy Switch-On (...)**”. On the other hand, sending **scene save orders** is not possible for the courtesy switch-on (only orders to play scenes are allowed).

**Note:** *object “[ML] **Courtesy Switch-On: Binary Object**” sends the value “1” (when the courtesy switch-on takes place), in contrast to object “[ML] **General Switch-Off: Binary Object**”, which sends the value “0” (during the general switch-off, as explained above).*

## 2.7 SCENE TEMPORISATION

The scene temporisation allows **imposing delays over the scenes** of the outputs. These delays, defined in parameters, are applied on the execution of one or more scenes that may have been configured.

Please bear in mind that, as multiple delayed scenes can be configured for each individual output / shutter channel, in case of receiving an order to execute one of them when **a previous temporisation is still pending** for that output / channel, such temporisation will be interrupted and only the delay and the action of the new scene will be executed.

### ETS PARAMETERISATION

Prior to setting the **scene temporisation**, it is necessary to have one or more scenes configured in some of the outputs. When entering the Configuration window under Scene Temporization, all configured scenes will be listed, together with a few checkboxes to select which of them need to be temporised, as shown in Figure 6:

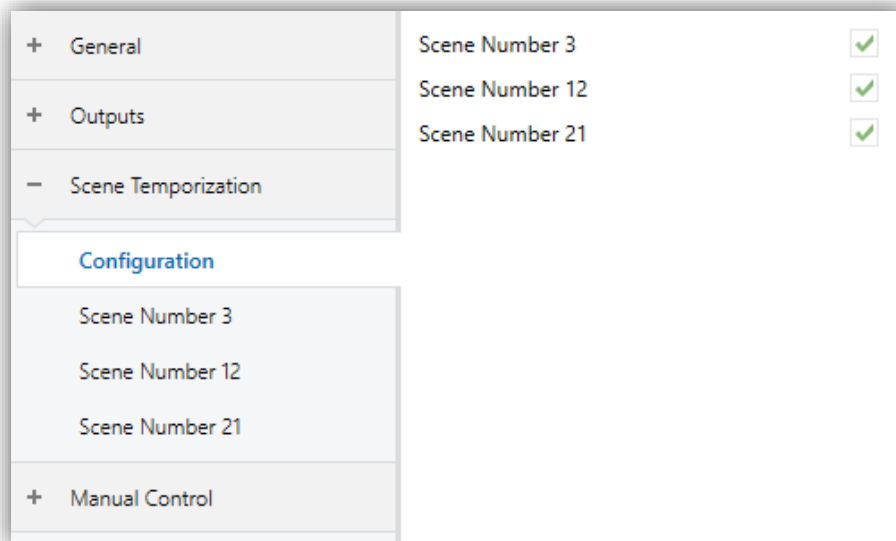

Figure 6. Scene Temporisation

Enabling a certain **Scene Number  $n$**  [*disabled/enabled*] brings a new tab with such name to the menu on the left, from which it is possible to configure the temporisation of that scene for each of the outputs where it has been configured.

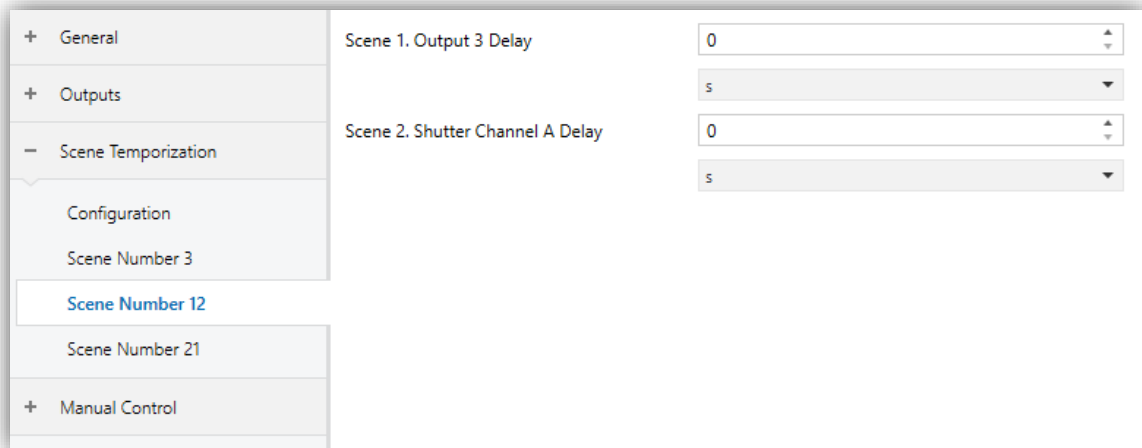

Figure 7. Configuring Scene Temporisations

Therefore, parameter **Scene n. Z Delay**  $[0...3600][s]$   $[0...1440][min]$   $[0...24][h]$  defines the delay that will be applied to the action defined in Z (being Z a specific individual output or shutter channel) for the execution of scene m.

**Note:** *In the configuration of a scene of an output / shutter channel it is possible to parameterize several scenes with the same scene number. This means that several delay parameters associated with the same output appear in the configuration tab of the delays of that scene. With this parameterization, the behaviour will be as follows: the action and delay of the first scene parameterized with the same scene number will always prevail, where the highest priority scene is 1 (the first in the scene configuration tab) and the lowest priority is the last.*

## 2.8 MANUAL CONTROL

---

MAXinBOX 66 v2 allows manually switching the state of its output relays through the respective pushbuttons on the top of the device. A specific pushbutton is therefore available per output.

Manual operation can be done in two different ways, named as **Test On Mode** (for testing purposes during the configuration of the device) and **Test Off Mode** (for a normal use, anytime). Whether both, only one, or none of these modes should be accessible needs to be parameterised in ETS. Moreover, it is possible to enable a specific binary object for locking and unlocking the manual control in runtime.

### Note:

- *The **Test Off mode** will be active (unless it has been disabled by parameter) after a download or a reset with no need of a specific activation – the pushbuttons will respond to user presses from the start.*
- *On the contrary, switching to the **Test On mode** (unless disabled by parameter) needs to be done by long-pressing the Prog/Test button (for at least three seconds), until the LED is no longer red and turns yellow. From that moment, once the button is released, the LED light will remain green to confirm that the device has switched from the Test Off mode to the Test On mode. After that, an additional press will turn the LED yellow and then off, once the button is released. This way, the device leaves the Test On mode. Note that it will also leave this mode if a bus power failure takes place.*

### Test Off Mode

Under the Test Off Mode, the outputs can be controlled through both their communication objects and the actual pushbuttons located on the top of the device.

When one of these buttons is pressed, the output will behave as if an order had been received through the corresponding communication object, depending on whether the output is configured as an individual output or as a shutter channel.

- **Individual output:** a simple press (short or long) will make the output switch its on-off state, which will be reported to the KNX bus through the

corresponding status object, if enabled.

- **Shutter Channel:** when the button is pressed, the device will act over the output according to the length of the button press and to the current state.
  - A **long press** makes the shutter start moving (upwards or downwards, depending on the button being pressed). The LED will light in green until the end of the motion. If the button gets pressed being the shutter already at the top or bottom positions, nothing will happen (the LED will not light).
  - A **short press** will make the shutter drive stop (if in motion), as it normally does when a step/stop order is received from the KNX bus. In case of not being the shutter in motion, pressing the button does not cause any action, unless slats/lamellas have been parameterized – in such case, a step movement (up/down, depending on the button pressed) will take place. The status objects will be sent to the bus when corresponding.
- **Disabled output:** outputs disabled by parameter will not react to button presses under the Test Off mode.

Regarding the lock, timer, alarm and scene functions, the device will behave under the Test Off mode as usual. Button presses during this mode are entirely analogous to the reception of the corresponding orders from the KNX bus.

## Test On Mode

After entering the Test On mode, it will only be possible to control the outputs through the on-board pushbuttons. Orders received through communication objects will be ignored, with independence of the channel or the output they are addressed to.

Depending on whether the output has been parameterised as an individual output or as part of a shutter channel, the reactions to the button presses will differ.

- **Individual output:** short or long pressing the button will commute the on-off state of the relay.
- **Shutter channel:** pressing the button will make the shutter drive move upward or downward (depending on the button) until the button is released again, thus ignoring the position of the shutter and the parameterised times.

**Note:** after leaving the Test On mode, the status objects will recover the values they had prior to entering Test On. As the device is never aware of the actual position of the shutter (as the shutter drive does not provide any feedback), these values may not show the real position. This can be solved by performing a complete move-up or move-down order, or by calibrating the shutter position in the Test On mode until it matches the status objects.

- **Disabled output:** under the Test On mode, short and long presses will cause the same effect for disabled outputs as for individual outputs (i.e., the relay will switch its state).

As described previously if the device is in Test On mode, any command sent from the KNX bus to the actuator will not affect the outputs and no status objects will be sent (only periodically timed objects such as Heartbeat or logic functions will continue to be sent to the bus) while Test ON mode is active. However, in the case of the "Alarm" and "Block" objects, although in Test ON mode the actions received by each object are not taken into account, the evaluation of their status is carried out when exiting this mode, so that any change in the alarm status or blocking of the outputs while Test ON mode is active is taken into account when exiting this mode and is updated with the last status detected.

**Important:** the device is factory delivered with all the output channels configured as shutters (without slats), and with both manual modes (Test Off and Test On) enabled.

## ETS PARAMETERISATION

After enabling "**Manual Control**" (enabled by default) in the General screen (see section 2.1), a new tab will be incorporated into the tree on the left.

The only two parameters are:

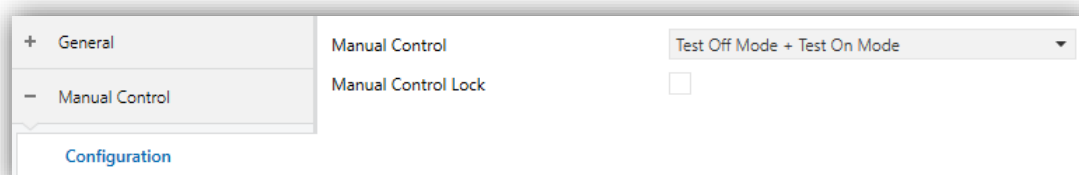

Figure 8. Manual Control

- **Manual Control** [*Disabled / Only Test Mode Off / Only Test Mode On / Test Off Mode + Test On Mode*]: depending on the selection, the device will permit using the manual control under the Test Off, the Test On, or both modes. Note that, as stated before, using the Test Off mode does not require any special action, while switching to the Test On mode does require long-pressing the Prog/Test button.
- **Manual Lock Control** [*disabled/enabled*]: unless the above parameter has been “Disabled”, the Lock Manual Control parameter provides an optional procedure for locking the manual control in runtime. When this checkbox is enabled, object “**Manual Control Lock**” turns visible, as well as two more parameters:
  - **Value** [*0 = Lock; 1 = Unlock / 0 = Unlock; 1 = Lock*]: defines whether the manual control lock/unlock should take place respectively upon the reception (through the aforementioned object) of values “0” and “1”, or the opposite.
  - **Initialization** [*Unlocked / Locked / Last Value*]: sets how the manual control should remain after the device start-up (after an ETS download or a bus power failure). If “Last Value” is selected, on the very first start-up, this will be “Unlocked”).

## ANNEX I. COMMUNICATION OBJECTS

- “Functional range” shows the values that, with independence of any other values permitted by the bus according to the object size, may be of any use or have a particular meaning because of the specifications or restrictions from both the KNX standard or the application program itself.

Number	Size	I/O	Flags	Data type (DPT)	Functional Range	Name	Function
1	1 Bit		<b>CT---</b>	DPT_Trigger	0/1	Reset 0	Voltage Recovery -> Sending of 0
2	1 Bit		<b>CT---</b>	DPT_Trigger	0/1	Reset 1	Voltage Recovery -> Sending of 1
3	1 Bit	I	<b>C--W-</b>	DPT_Enable	0/1	Lock Manual Control	0 = Lock; 1 = Unlock
	1 Bit	I	<b>C--W-</b>	DPT_Enable	0/1	Lock Manual Control	0 = Unlock; 1 = Lock
4	1 Bit		<b>CT---</b>	DPT_Trigger	0/1	[Heartbeat] Object to Send '1'	Sending of '1' Periodically
5	1 Byte	I	<b>C--W-</b>	DPT_SceneControl	0-63; 128-191	[Thermostat] Scene Input	Scene Value
6, 44, 82, 120	2 Bytes	I	<b>C--W-</b>	DPT_Value_Temp	-273.00 - 670760.00	[Tx] Temperature Source 1	External Sensor Temperature
7, 45, 83, 121	2 Bytes	I	<b>C--W-</b>	DPT_Value_Temp	-273.00 - 670760.00	[Tx] Temperature Source 2	External Sensor Temperature
8, 46, 84, 122	2 Bytes	O	<b>CTR--</b>	DPT_Value_Temp	-273.00 - 670760.00	[Tx] Effective Temperature	Effective Control Temperature
9, 47, 85, 123	1 Byte	I	<b>C--W-</b>	DPT_HVACMode	1=Comfort 2=Standby 3=Economy 4=Building Protection	[Tx] Special Mode	1-Byte HVAC Mode
10, 48, 86, 124	1 Bit	I	<b>C--W-</b>	DPT_Ack	0/1	[Tx] Special Mode: Comfort	0 = Nothing; 1 = Trigger
	1 Bit	I	<b>C--W-</b>	DPT_Switch	0/1	[Tx] Special Mode: Comfort	0 = Off; 1 = On
11, 49, 87, 125	1 Bit	I	<b>C--W-</b>	DPT_Ack	0/1	[Tx] Special Mode: Standby	0 = Nothing; 1 = Trigger
	1 Bit	I	<b>C--W-</b>	DPT_Switch	0/1	[Tx] Special Mode: Standby	0 = Off; 1 = On
12, 50, 88, 126	1 Bit	I	<b>C--W-</b>	DPT_Ack	0/1	[Tx] Special Mode: Economy	0 = Nothing; 1 = Trigger
	1 Bit	I	<b>C--W-</b>	DPT_Switch	0/1	[Tx] Special Mode: Economy	0 = Off; 1 = On
13, 51, 89, 127	1 Bit	I	<b>C--W-</b>	DPT_Ack	0/1	[Tx] Special Mode: Protection	0 = Nothing; 1 = Trigger
	1 Bit	I	<b>C--W-</b>	DPT_Switch	0/1	[Tx] Special Mode: Protection	0 = Off; 1 = On
14, 52, 90, 128	1 Bit	I	<b>C--W-</b>	DPT_Window_Door	0/1	[Tx] Window Status (Input)	0 = Closed; 1 = Open
15, 53, 91, 129	1 Bit	I	<b>C--W-</b>	DPT_Ack	0/1	[Tx] Comfort Prolongation	0 = Nothing; 1 = Timed Comfort
16, 54, 92, 130	1 Byte	O	<b>CTR--</b>	DPT_HVACMode	1=Comfort 2=Standby 3=Economy 4=Building Protection	[Tx] Special Mode Status	1-Byte HVAC Mode
17, 55, 93, 131	2 Bytes	I	<b>C--W-</b>	DPT_Value_Temp	-273.00 - 670760.00	[Tx] Setpoint	Thermostat Setpoint Input



	2 Bytes	I	<b>C--W-</b>	DPT_Value_Temp	-273.00 - 670760.00	[Tx] Basic Setpoint	Reference Setpoint
18, 56, 94, 132	1 Bit	I	<b>C--W-</b>	DPT_Step	0/1	[Tx] Setpoint Step	0 = Decrease Setpoint; 1 = Increase Setpoint
19, 57, 95, 133	2 Bytes	I	<b>C--W-</b>	DPT_Value_Tempd	-670760.00 - 670760.00	[Tx] Setpoint Offset	Float Offset Value
20, 58, 96, 134	2 Bytes	O	<b>CTR--</b>	DPT_Value_Temp	-273.00 - 670760.00	[Tx] Setpoint Status	Current Setpoint
21, 59, 97, 135	2 Bytes	O	<b>CTR--</b>	DPT_Value_Temp	-273.00 - 670760.00	[Tx] Basic Setpoint Status	Current Basic Setpoint
22, 60, 98, 136	2 Bytes	O	<b>CTR--</b>	DPT_Value_Tempd	-670760.00 - 670760.00	[Tx] Setpoint Offset Status	Current Setpoint Offset
23, 61, 99, 137	1 Bit	I	<b>C--W-</b>	DPT_Reset	0/1	[Tx] Setpoint Reset	Reset Setpoint to Default
	1 Bit	I	<b>C--W-</b>	DPT_Reset	0/1	[Tx] Offset Reset	Reset Offset
24, 62, 100, 138	1 Bit	I	<b>C--W-</b>	DPT_Heat_Cool	0/1	[Tx] Mode	0 = Cool; 1 = Heat
25, 63, 101, 139	1 Bit	O	<b>CTR--</b>	DPT_Heat_Cool	0/1	[Tx] Mode Status	0 = Cool; 1 = Heat
26, 64, 102, 140	1 Bit	I	<b>C--W-</b>	DPT_Switch	0/1	[Tx] On/Off	0 = Off; 1 = On
27, 65, 103, 141	1 Bit	O	<b>CTR--</b>	DPT_Switch	0/1	[Tx] On/Off Status	0 = Off; 1 = On
28, 66, 104, 142	1 Bit	I/O	<b>C-RW-</b>	DPT_Switch	0/1	[Tx] Main System (Cool)	0 = System 1; 1 = System 2
29, 67, 105, 143	1 Bit	I/O	<b>C-RW-</b>	DPT_Switch	0/1	[Tx] Main System (Heat)	0 = System 1; 1 = System 2
30, 68, 106, 144	1 Bit	I	<b>C--W-</b>	DPT_Enable	0/1	[Tx] Enable/Disable Secondary System (Cool)	0 = Disable; 1 = Enable
31, 69, 107, 145	1 Bit	I	<b>C--W-</b>	DPT_Enable	0/1	[Tx] Enable/Disable Secondary System (Heat)	0 = Disable; 1 = Enable
32, 38, 70, 76, 108, 114, 146, 152	1 Byte	O	<b>CTR--</b>	DPT_Scaling	0% - 100%	[Tx] [Sx] Control Variable (Cool)	PI Control (Continuous)
33, 39, 71, 77, 109, 115, 147, 153	1 Byte	O	<b>CTR--</b>	DPT_Scaling	0% - 100%	[Tx] [Sx] Control Variable (Heat)	PI Control (Continuous)
	1 Byte	O	<b>CTR--</b>	DPT_Scaling	0% - 100%	[Tx] [Sx] Control Variable	PI Control (Continuous)
34, 40, 72, 78, 110, 116, 148, 154	1 Bit	O	<b>CTR--</b>	DPT_Switch	0/1	[Tx] [Sx] Control Variable (Cool)	2-Point Control
	1 Bit	O	<b>CTR--</b>	DPT_Switch	0/1	[Tx] [Sx] Control Variable (Cool)	PI Control (PWM)
35, 41, 73, 79, 111, 117, 149, 155	1 Bit	O	<b>CTR--</b>	DPT_Switch	0/1	[Tx] [Sx] Control Variable (Heat)	2-Point Control
	1 Bit	O	<b>CTR--</b>	DPT_Switch	0/1	[Tx] [Sx] Control Variable (Heat)	PI Control (PWM)
	1 Bit	O	<b>CTR--</b>	DPT_Switch	0/1	[Tx] [Sx] Control Variable	2-Point Control
	1 Bit	O	<b>CTR--</b>	DPT_Switch	0/1	[Tx] [Sx] Control Variable	PI Control (PWM)
36, 42, 74, 80, 112, 118, 150, 156	1 Bit	O	<b>CTR--</b>	DPT_Switch	0/1	[Tx] [Sx] PI State (Cool)	0 = PI Signal 0%; 1 = PI Signal Greater than 0%
37, 43, 75, 81, 113, 119, 151, 157	1 Bit	O	<b>CTR--</b>	DPT_Switch	0/1	[Tx] [Sx] PI State (Heat)	0 = PI Signal 0%; 1 = PI Signal Greater than 0%
	1 Bit	O	<b>CTR--</b>	DPT_Switch	0/1	[Tx] [Sx] PI State	0 = PI Signal 0%; 1 = PI Signal Greater than 0%
158	1 Bit	I	<b>C--W-</b>	DPT_Switch	0/1	[ML] Trigger	Trigger the Master Light Function
159, 160, 161, 162, 163, 164, 165, 166, 167, 168, 169, 170	1 Bit	I	<b>C--W-</b>	DPT_Switch	0/1	[ML] Status Object x	Binary Status

171	1 Bit	O	CTR--	DPT_Switch	0/1	[ML] General Status	Binary Status
172	1 Bit		CT---	DPT_Switch	0/1	[ML] General Switch Off: Binary Object	Switch Off Sending
173	1 Byte		CT---	DPT_Scaling	0% - 100%	[ML] General Switch Off: Scaling	0-100%
174	1 Byte		CT---	DPT_SceneControl	0-63; 128-191	[ML] General Switch Off: Scene	Scene Sending
175	1 Byte		CT---	DPT_HVACMode	1=Comfort 2=Standby 3=Economy 4=Building Protection	[ML] General Switch Off: HVAC mode	Auto, Comfort, Standby, Economy, Building Protection
176	1 Bit		CT---	DPT_Switch	0/1	[ML] Courtesy Switch On: Binary Object	Switch On Sending
177	1 Byte		CT---	DPT_Scaling	0% - 100%	[ML] Courtesy Switch On: Scaling	0-100%
178	1 Byte		CT---	DPT_SceneControl	0-63; 128-191	[ML] Courtesy Switch On: Scene	Scene Sending
179	1 Byte		CT---	DPT_HVACMode	1=Comfort 2=Standby 3=Economy 4=Building Protection	[ML] Courtesy Switch On: HVAC mode	Auto, Comfort, Standby, Economy, Building Protection
180, 184, 188, 192, 196, 200	2 Bytes	O	CTR--	DPT_Value_Temp	-273.00 - 670760.00	[Ix] Current Temperature	Temperature Sensor Value
181, 185, 189, 193, 197, 201	1 Bit	O	CTR--	DPT_Alarm	0/1	[Ix] Overcooling	0 = No Alarm; 1 = Alarm
182, 186, 190, 194, 198, 202	1 Bit	O	CTR--	DPT_Alarm	0/1	[Ix] Overheating	0 = No Alarm; 1 = Alarm
183, 187, 191, 195, 199, 203	1 Bit	O	CTR--	DPT_Alarm	0/1	[Ix] Probe Error	0 = No Alarm; 1 = Alarm
204, 210, 216, 222, 228, 234	1 Bit	I	C--W-	DPT_Enable	0/1	[Ix] Input Lock	0 = Unlock; 1 = Lock
205, 211, 217, 223, 229, 235	1 Bit		CT---	DPT_Switch	0/1	[Ix] [Short Press] 0	Sending of 0
	1 Bit		CT---	DPT_Switch	0/1	[Ix] [Short Press] 1	Sending of 1
	1 Bit	I	CT-W-	DPT_Switch	0/1	[Ix] [Short Press] 0/1 Switching	Switching 0/1
	1 Bit		CT---	DPT_UpDown	0/1	[Ix] [Short Press] Move Up Shutter	Sending of 0 (Up)
	1 Bit		CT---	DPT_UpDown	0/1	[Ix] [Short Press] Move Down Shutter	Sending of 1 (Down)
	1 Bit		CT---	DPT_UpDown	0/1	[Ix] [Short Press] Move Up/Down Shutter	Switching 0/1 (Up/Down)
	1 Bit		CT---	DPT_Step	0/1	[Ix] [Short Press] Stop/Step Up Shutter	Sending of 0 (Stop/Step Up)
	1 Bit		CT---	DPT_Step	0/1	[Ix] [Short Press] Stop/Step Down Shutter	Sending of 1 (Stop/Step Down)
	1 Bit		CT---	DPT_Step	0/1	[Ix] [Short Press] Stop/Step Shutter (Switched)	Switching of 0/1 (Stop/Step Up/Down)
4 Bit		CT---	DPT_Control_Dimming	0x0 (Stop) 0x1 (Dec. by 100%) ... 0x7 (Dec. by 1%) 0x8 (Stop)	[Ix] [Short Press] Brighter	Increase Brightness	

				0xD (Inc. by 100%) ... 0xF (Inc. by 1%)		
	4 Bit		CT----	DPT_Control_Dimming	0x0 (Stop) 0x1 (Dec. by 100%) ... 0x7 (Dec. by 1%) 0x8 (Stop) 0xD (Inc. by 100%) ... 0xF (Inc. by 1%)	[Ix] [Short Press] Darker  Decrease Brightness
	4 Bit		CT----	DPT_Control_Dimming	0x0 (Stop) 0x1 (Dec. by 100%) ... 0x7 (Dec. by 1%) 0x8 (Stop) 0xD (Inc. by 100%) ... 0xF (Inc. by 1%)	[Ix] [Short Press] Brighter/Darker  Switch Bright/Dark
	1 Bit		CT----	DPT_Switch	0/1	[Ix] [Short Press] Light On Sending of 1 (On)
	1 Bit		CT----	DPT_Switch	0/1	[Ix] [Short Press] Light Off Sending of 0 (Off)
	1 Bit	I	CT-W-	DPT_Switch	0/1	[Ix] [Short Press] Light On/Off Switching 0/1
	1 Byte		CT----	DPT_SceneControl	0-63; 128-191	[Ix] [Short Press] Run Scene Sending of 0 - 63
	1 Byte		CT----	DPT_SceneControl	0-63; 128-191	[Ix] [Short Press] Save Scene Sending of 128 - 191
	1 Bit	I/O	CTRW-	DPT_Switch	0/1	[Ix] [Switch/Sensor] Edge Sending of 0 or 1
	1 Byte		CT----	DPT_Value_1_Ucount	0 - 255	[Ix] [Short Press] Constant Value (Integer) 0 - 255
	1 Byte		CT----	DPT_Scaling	0% - 100%	[Ix] [Short Press] Constant Value (Percentage) 0% - 100%
	2 Bytes		CT----	DPT_Value_2_Ucount	0 - 65535	[Ix] [Short Press] Constant Value (Integer) 0 - 65535
	2 Bytes		CT----	9.xxx	-671088.64 - 670760.96	[Ix] [Short Press] Constant Value (Float) Float Value
206, 212, 218, 224, 230, 236	1 Byte	I	C--W-	DPT_Scaling	0% - 100%	[Ix] [Short Press] Shutter Status (Input) 0% = Top; 100% = Bottom
	1 Byte	I	C--W-	DPT_Scaling	0% - 100%	[Ix] [Short Press] Dimming Status (Input) 0% - 100%
207, 213, 219, 225, 231, 237	1 Bit		CT----	DPT_Switch	0/1	[Ix] [Long Press] 0 Sending of 0
	1 Bit		CT----	DPT_Switch	0/1	[Ix] [Long Press] 1 Sending of 1
	1 Bit	I	CT-W-	DPT_Switch	0/1	[Ix] [Long Press] 0/1 Switching Switching 0/1
	1 Bit		CT----	DPT_UpDown	0/1	[Ix] [Long Press] Move Up Shutter Sending of 0 (Up)
	1 Bit		CT----	DPT_UpDown	0/1	[Ix] [Long Press] Move Down Shutter Sending of 1 (Down)
	1 Bit		CT----	DPT_UpDown	0/1	[Ix] [Long Press] Move Up/Down Shutter Switching 0/1 (Up/Down)
	1 Bit		CT----	DPT_Step	0/1	[Ix] [Long Press] Stop/Step Up Shutter Sending of 0 (Stop/Step Up)
	1 Bit		CT----	DPT_Step	0/1	[Ix] [Long Press] Stop/Step Down Shutter Sending of 1 (Stop/Step Down)

	1 Bit		<b>CT----</b>	DPT_Step	0/1	[Ix] [Long Press] Stop/Step Shutter (Switched)	Switching of 0/1 (Stop/Step Up/Down)
	4 Bit		<b>CT----</b>	DPT_Control_Dimming	0x0 (Stop) 0x1 (Dec. by 100%) ... 0x7 (Dec. by 1%) 0x8 (Stop) 0xD (Inc. by 100%) ... 0xF (Inc. by 1%)	[Ix] [Long Press] Brighter	Long Pr. -> Brighter; Release -> Stop
	4 Bit		<b>CT----</b>	DPT_Control_Dimming	0x0 (Stop) 0x1 (Dec. by 100%) ... 0x7 (Dec. by 1%) 0x8 (Stop) 0xD (Inc. by 100%) ... 0xF (Inc. by 1%)	[Ix] [Long Press] Darker	Long Pr. -> Darker; Release -> Stop
	4 Bit		<b>CT----</b>	DPT_Control_Dimming	0x0 (Stop) 0x1 (Dec. by 100%) ... 0x7 (Dec. by 1%) 0x8 (Stop) 0xD (Inc. by 100%) ... 0xF (Inc. by 1%)	[Ix] [Long Press] Brighter/Darker	Long Pr. -> Brighter/Darker; Release -> Stop
	1 Bit		<b>CT----</b>	DPT_Switch	0/1	[Ix] [Long Press] Light On	Sending of 1 (On)
	1 Bit		<b>CT----</b>	DPT_Switch	0/1	[Ix] [Long Press] Light Off	Sending of 0 (Off)
	1 Bit	I	<b>CT-W-</b>	DPT_Switch	0/1	[Ix] [Long Press] Light On/Off	Switching 0/1
	1 Byte		<b>CT----</b>	DPT_SceneControl	0-63; 128-191	[Ix] [Long Press] Run Scene	Sending of 0 - 63
	1 Byte		<b>CT----</b>	DPT_SceneControl	0-63; 128-191	[Ix] [Long Press] Save Scene	Sending of 128 - 191
	1 Bit	O	<b>CTR--</b>	DPT_Alarm	0/1	[Ix] [Switch/Sensor] Alarm: Breakdown or Sabotage	1 = Alarm; 0 = No Alarm
	2 Bytes		<b>CT----</b>	9.xxx	-671088.64 - 670760.96	[Ix] [Long Press] Constant Value (Float)	Float Value
	2 Bytes		<b>CT----</b>	DPT_Value_2_Ucount	0 - 65535	[Ix] [Long Press] Constant Value (Integer)	0 - 65535
	1 Byte		<b>CT----</b>	DPT_Scaling	0% - 100%	[Ix] [Long Press] Constant Value (Percentage)	0% - 100%
	1 Byte		<b>CT----</b>	DPT_Value_1_Ucount	0 - 255	[Ix] [Long Press] Constant Value (Integer)	0 - 255
208, 214, 220, 226, 232, 238	1 Bit		<b>CT----</b>	DPT_Trigger	0/1	[Ix] [Long Press/Release] Stop Shutter	Release -> Stop Shutter
209, 215, 221, 227, 233, 239	1 Byte	I	<b>C--W-</b>	DPT_Scaling	0% - 100%	[Ix] [Long Press] Dimming Status (Input)	0% - 100%
	1 Byte	I	<b>C--W-</b>	DPT_Scaling	0% - 100%	[Ix] [Long Press] Shutter Status (Input)	0% = Top; 100% = Bottom

240	1 Byte	I	C--W-	DPT_SceneNumber	0 - 63	[Motion Detector] Scene Input	Scene Value
241	1 Byte		CT---	DPT_SceneControl	0-63; 128-191	[Motion Detector] Scene Output	Scene Value
242, 271, 300, 329, 358, 387	1 Byte	O	CTR--	DPT_Scaling	0% - 100%	[Ix] Luminosity	0-100%
243, 272, 301, 330, 359, 388	1 Bit	O	CTR--	DPT_Alarm	0/1	[Ix] Open Circuit Error	0 = No Error; 1 = Open Circuit Error
244, 273, 302, 331, 360, 389	1 Bit	O	CTR--	DPT_Alarm	0/1	[Ix] Short Circuit Error	0 = No Error; 1 = Short Circuit Error
245, 274, 303, 332, 361, 390	1 Byte	O	CTR--	DPT_Scaling	0% - 100%	[Ix] Presence State (Scaling)	0-100%
246, 275, 304, 333, 362, 391	1 Byte	O	CTR--	DPT_HVACMode	1=Comfort 2=Standby 3=Economy 4=Building Protection	[Ix] Presence State (HVAC)	Auto, Comfort, Standby, Economy, Building Protection
247, 276, 305, 334, 363, 392	1 Bit	O	CTR--	DPT_Occupancy	0/1	[Ix] Presence State (Binary)	Binary Value
	1 Bit	O	CTR--	DPT_Ack	0/1	[Ix] Presence: Slave Output	1 = Motion Detected
248, 277, 306, 335, 364, 393	1 Bit	I	C--W-	DPT_Window_Door	0/1	[Ix] Presence Trigger	Binary Value to Trigger the Presence Detection
249, 278, 307, 336, 365, 394	1 Bit	I	C--W-	DPT_Ack	0/1	[Ix] Presence: Slave Input	0 = Nothing; 1 = Detection from slave device
250, 279, 308, 337, 366, 395	2 Bytes	I	C--W-	DPT_TimePeriodSec	0 - 65535	[Ix] Presence: Waiting Time	0-65535 s.
251, 280, 309, 338, 367, 396	2 Bytes	I	C--W-	DPT_TimePeriodSec	0 - 65535	[Ix] Presence: Listening Time	1-65535 s.
252, 281, 310, 339, 368, 397	1 Bit	I	C--W-	DPT_Enable	0/1	[Ix] Presence: Enable	According to parameters
253, 282, 311, 340, 369, 398	1 Bit	I	C--W-	DPT_DayNight	0/1	[Ix] Presence: Day/Night	According to parameters
254, 283, 312, 341, 370, 399	1 Bit	O	CTR--	DPT_Occupancy	0/1	[Ix] Presence: Occupancy State	0 = Not Occupied; 1 = Occupied
255, 284, 313, 342, 371, 400	1 Bit	I	C--W-	DPT_Ack	0/1	[Ix] External Motion Detection	0 = Nothing; 1 = Motion detected by an external sensor
256, 261, 266, 285, 290, 295, 314, 319, 324, 343, 348, 353, 372, 377, 382, 401, 406, 411	1 Byte	O	CTR--	DPT_Scaling	0% - 100%	[Ix] [Cx] Detection State (Scaling)	0-100%
257, 262, 267, 286, 291, 296, 315, 320, 325, 344, 349, 354, 373, 378, 383, 402,	1 Byte	O	CTR--	DPT_HVACMode	1=Comfort 2=Standby 3=Economy 4=Building Protection	[Ix] [Cx] Detection State (HVAC)	Auto, Comfort, Standby, Economy, Building Protection

407, 412							
258, 263, 268, 287, 292, 297, 316, 321, 326, 345, 350, 355, 374, 379, 384, 403, 408, 413	1 Bit	O	<b>CTR--</b>	DPT_Switch	0/1	[Ix] [Cx] Detection State (Binary)	Binary Value
259, 264, 269, 288, 293, 298, 317, 322, 327, 346, 351, 356, 375, 380, 385, 404, 409, 414	1 Bit	I	<b>C--W-</b>	DPT_Enable	0/1	[Ix] [Cx] Enable Channel	According to parameters
260, 265, 270, 289, 294, 299, 318, 323, 328, 347, 352, 357, 376, 381, 386, 405, 410, 415	1 Bit	I	<b>C--W-</b>	DPT_Switch	0/1	[Ix] [Cx] Force State	0 = No Detection; 1 = Detection
416, 427, 438, 449, 460, 471	1 Byte	I	<b>C--W-</b>	DPT_SceneControl	0-63; 128-191	[Ox] Scenes	0 - 63 (Execute 1 - 64); 128 - 191 (Save 1 - 64)
417, 428, 439, 450, 461, 472	1 Bit	I	<b>C--W-</b>	DPT_BinaryValue	0/1	[Ox] On/Off	N.O. (0=Open Relay; 1=Close Relay)
	1 Bit	I	<b>C--W-</b>	DPT_BinaryValue	0/1	[Ox] On/Off	N.C. (0=Close Relay; 1= Open Relay)
418, 429, 440, 451, 462, 473	1 Bit	O	<b>CTR--</b>	DPT_BinaryValue	0/1	[Ox] On/Off (Status)	0=Output Off; 1=Output On
419, 430, 441, 452, 463, 474	1 Bit	I	<b>C--W-</b>	DPT_Enable	0/1	[Ox] Lock	0=Unlock; 1=Lock
420, 431, 442, 453, 464, 475	1 Bit	I	<b>C--W-</b>	DPT_Start	0/1	[Ox] Timer	0=Switch Off; 1=Switch On
421, 432, 443, 454, 465, 476	1 Bit	I	<b>C--W-</b>	DPT_Start	0/1	[Ox] Flashing	0=Stop; 1=Start
422, 433, 444, 455, 466, 477	1 Bit	I	<b>C--W-</b>	DPT_Alarm	0/1	[Ox] Alarm	0=Normal; 1=Alarm
	1 Bit	I	<b>C--W-</b>	DPT_Alarm	0/1	[Ox] Alarm	0=Alarm; 1=Normal
423, 434, 445, 456, 467, 478	1 Bit	I	<b>C--W-</b>	DPT_Ack	0/1	[Ox] Unfreeze Alarm	Alarm=0 + Unfreeze=1 => End Alarm
424, 435, 446, 457, 468, 479	1 Bit	O	<b>CTR--</b>	DPT_State	0/1	[Ox] Warning Time (Status)	0=Normal; 1=Warning
425, 436, 447, 458, 469, 480	4 Bytes	I/O	<b>CTRW-</b>	DPT_LongDeltaTimeSec	-2147483648, 2147483647	[Ox] Operating Time (s)	Time in Seconds
426, 437, 448, 459, 470, 481	2 Bytes	I/O	<b>CTRW-</b>	DPT_TimePeriodHrs	0 - 65535	[Ox] Operating Time (h)	Time in Hours
482	1 Byte	I	<b>C--W-</b>	DPT_SceneControl	0-63; 128-191	[Shutter] Scenes	0 - 63 (Execute 1 - 64); 128 - 191 (Save 1 - 64)

483, 511, 539	1 Bit	I	C - - W -	DPT_UpDown	0/1	[Cx] Move	0=Raise; 1=Lower
484, 512, 540	1 Bit	I	C - - W -	DPT_Step	0/1	[Cx] Stop/Step	0=Stop/StepUp; 1=Stop/StepDown
	1 Bit	I	C - - W -	DPT_Trigger	0/1	[Cx] Stop	0=Stop; 1=Stop
485, 513, 541	1 Bit	I	C - - W -	DPT_Enable	0/1	[Cx] Lock	0=Unlock; 1=Lock
486, 514, 542	1 Byte	I	C - - W -	DPT_Scaling	0% - 100%	[Cx] Shutter Positioning	0%=Top; 100%=Bottom
487, 515, 543	1 Byte	O	C T R - -	DPT_Scaling	0% - 100%	[Cx] Shutter Position (Status)	0%=Top; 100%=Bottom
488, 516, 544	1 Byte	I	C - - W -	DPT_Scaling	0% - 100%	[Cx] Slats Positioning	0%=Open; 100%=Closed
489, 517, 545	1 Byte	O	C T R - -	DPT_Scaling	0% - 100%	[Cx] Slats Position (Status)	0%=Open; 100%=Closed
490, 518, 546	1 Bit	O	C T R - -	DPT_Switch	0/1	[Cx] Rising Relay (Status)	0=Open; 1=Closed
491, 519, 547	1 Bit	O	C T R - -	DPT_Switch	0/1	[Cx] Lowering Relay (Status)	0=Open; 1=Closed
492, 520, 548	1 Bit	O	C T R - -	DPT_Switch	0/1	[Cx] Movement (Status)	0=Stopped; 1=Moving
493, 521, 549	1 Bit	O	C T R - -	DPT_UpDown	0/1	[Cx] Movement Direction (Status)	0=Upward; 1=Downward
494, 522, 550	1 Bit	I	C - - W -	DPT_Switch	0/1	[Cx] Auto: On/Off	0=On; 1=Off
	1 Bit	I	C - - W -	DPT_Switch	0/1	[Cx] Auto: On/Off	0=Off; 1=On
495, 523, 551	1 Bit	O	C T R - -	DPT_Switch	0/1	[Cx] Auto: On/Off (Status)	0=On; 1=Off
	1 Bit	O	C T R - -	DPT_Switch	0/1	[Cx] Auto: On/Off (Status)	0=Off; 1=On
496, 524, 552	1 Bit	I	C - - W -	DPT_UpDown	0/1	[Cx] Auto: Move	0=Raise; 1=Lower
497, 525, 553	1 Bit	I	C - - W -	DPT_Step	0/1	[Cx] Auto: Stop/Step	0=Stop/StepUp; 1=Stop/StepDown
	1 Bit	I	C - - W -	DPT_Step	0/1	[Cx] Auto: Stop	0=Stop; 1=Stop
498, 526, 554	1 Byte	I	C - - W -	DPT_Scaling	0% - 100%	[Cx] Auto: Shutter Positioning	0%=Top; 100%=Bottom
499, 527, 555	1 Byte	I	C - - W -	DPT_Scaling	0% - 100%	[Cx] Auto: Slats Positioning	0%=Open; 100%=Closed
500, 528, 556	1 Bit	I	C T - W U	DPT_Scene_AB	0/1	[Cx] Sunshine/Shadow	0=Sunshine; 1=Shadow
	1 Bit	I	C T - W U	DPT_Scene_AB	0/1	[Cx] Sunshine/Shadow	0=Shadow; 1=Sunshine
501, 529, 557	1 Bit	I	C T - W U	DPT_Heat_Cool	0/1	[Cx] Cooling/Heating	0=Heating; 1=Cooling
	1 Bit	I	C T - W U	DPT_Heat_Cool	0/1	[Cx] Cooling/Heating	0=Cooling; 1=Heating
502, 530, 558	1 Bit	I	C T - W U	DPT_Occupancy	0/1	[Cx] Presence/No Presence	0=Presence; 1=No Presence
	1 Bit	I	C T - W U	DPT_Occupancy	0/1	[Cx] Presence/No Presence	0=No Presence; 1=Presence
503, 531, 559	1 Bit	I	C - - W -	DPT_Alarm	0/1	[Cx] Alarm 1	0=No Alarm; 1=Alarm
	1 Bit	I	C - - W -	DPT_Alarm	0/1	[Cx] Alarm 1	0=Alarm; 1=No Alarm
504, 532, 560	1 Bit	I	C - - W -	DPT_Alarm	0/1	[Cx] Alarm 2	0=No Alarm; 1=Alarm
	1 Bit	I	C - - W -	DPT_Alarm	0/1	[Cx] Alarm 2	0=Alarm; 1=No Alarm
505, 533, 561	1 Bit	I	C - - W -	DPT_Ack	0/1	[Cx] Unfreeze Alarm	Alarm1=Alarm2=No Alarm + Unfreeze (1) => End Alarm
506, 534, 562	1 Bit	I	C - - W -	DPT_Scene_AB	0/1	[Cx] Move (Reversed)	0=Lower; 1=Raise
507, 535, 563	1 Bit	I	C - - W -	DPT_Ack	0/1	[Cx] Direct Positioning 1	0=No Action; 1=Go to Position
508, 536, 564	1 Bit	I	C - - W -	DPT_Ack	0/1	[Cx] Direct Positioning 2	0=No Action; 1=Go to Position
509, 537, 565	1 Bit	I	C - - W -	DPT_Ack	0/1	[Cx] Direct Positioning 1 (Save)	0=No Action; 1=Save Current

							Position
510, 538, 566	1 Bit	I	C--W-	DPT_Ack	0/1	[Cx] Direct Positioning 2 (Save)	0=No Action; 1=Save Current Position
601, 602, 603, 604, 605, 606, 607, 608, 609, 610, 611, 612, 613, 614, 615, 616, 617, 618, 619, 620, 621, 622, 623, 624, 625, 626, 627, 628, 629, 630, 631, 632	1 Bit	I	C--W-	DPT_Bool	0/1	[LF] (1-Bit) Data Entry x	Binary Data Entry (0/1)
633, 634, 635, 636, 637, 638, 639, 640, 641, 642, 643, 644, 645, 646, 647, 648	1 Byte	I	C--W-	DPT_Value_1_Ucount	0 - 255	[LF] (1-Byte) Data Entry x	1-Byte Data Entry (0-255)
649, 650, 651, 652, 653, 654, 655, 656, 657, 658, 659, 660, 661, 662, 663, 664	2 Bytes	I	C--W-	DPT_Value_2_Ucount	0 - 65535	[LF] (2-Byte) Data Entry x	2-Byte Data Entry
				DPT_Value_2_Count	-32768 -32767		
				DPT_Value_Temp	-273,00 - 670760,00		
665, 666, 667, 668, 669, 670, 671, 672	4 Bytes	I	C--W-	DPT_Value_4_Count	-2147483648 - 2147483647	[LF] (4-Byte) Data Entry x	4-Byte Data Entry
673, 674, 675, 676, 677, 678, 679, 680, 681, 682	1 Bit	O	CTR--	DPT_Bool	0/1	[LF] Function x - Result	(1-Bit) Boolean
	1 Byte	O	CTR--	DPT_Value_1_Ucount	0 - 255	[LF] Function x - Result	(1-Byte) Unsigned
	2 Bytes	O	CTR--	DPT_Value_2_Ucount	0 - 65535	[LF] Function x - Result	(2-Byte) Unsigned
	4 Bytes	O	CTR--	DPT_Value_4_Count	-2147483648 - 2147483647	[LF] Function x - Result	(4-Byte) Signed
	1 Byte	O	CTR--	DPT_Scaling	0% - 100%	[LF] Function x - Result	(1-Byte) Percentage
	2 Bytes	O	CTR--	DPT_Value_2_Count	-32768 - 32767	[LF] Function x - Result	(2-Byte) Signed
	2 Bytes	O	CTR--	DPT_Value_Temp	-273.00 - 670760.00	[LF] Function x - Result	(2-Byte) Float
683, 685, 687, 689, 691, 693	4 Bytes	O	CTR--	DPT_Value_4_Ucount	0 - 4294967295	[Relay x] Number of Switches	Number of Switches
684, 686, 688, 690, 692, 694	2 Bytes	O	CTR--	DPT_Value_2_Ucount	0 - 65535	[Relay x] Maximum Switches per Minute	Maximum Switches per Minute





Join and send us your inquiries  
about Zennio devices:

<http://support.zennio.com>

**Zennio Avance y Tecnología S.L.**

C/ Río Jarama, 132. Nave P-8.11  
45007 Toledo, Spain.

*Tel. +34 925 232 002.*

*www.zennio.com*  
*info@zennio.com*



RoHS